

ELVES

41075





LEGO.com/brickseparator



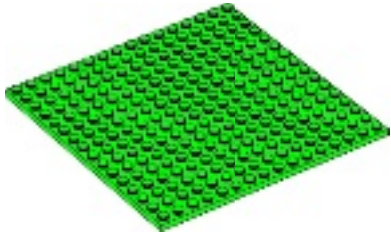

+



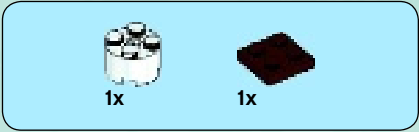

1



2



3

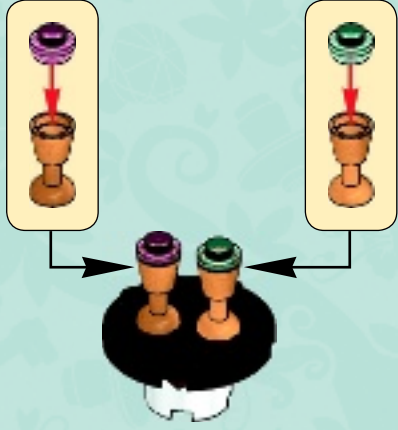

4

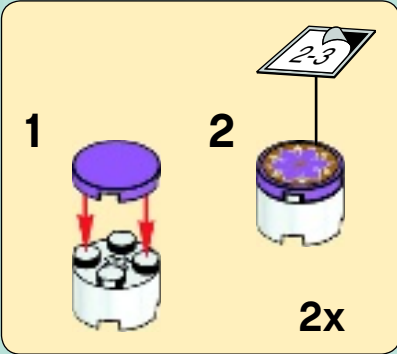

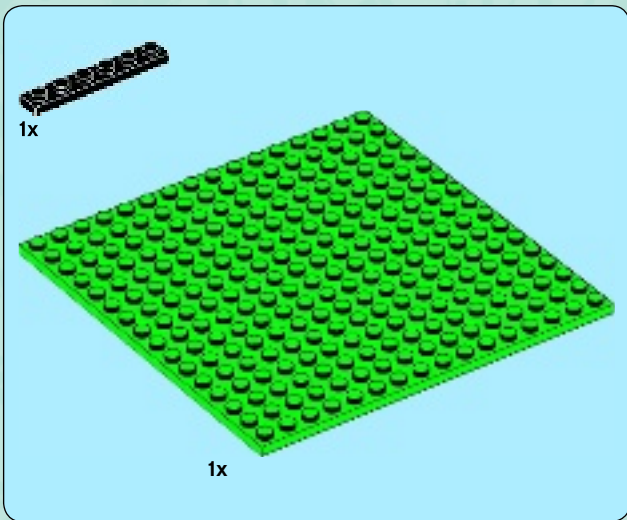

1

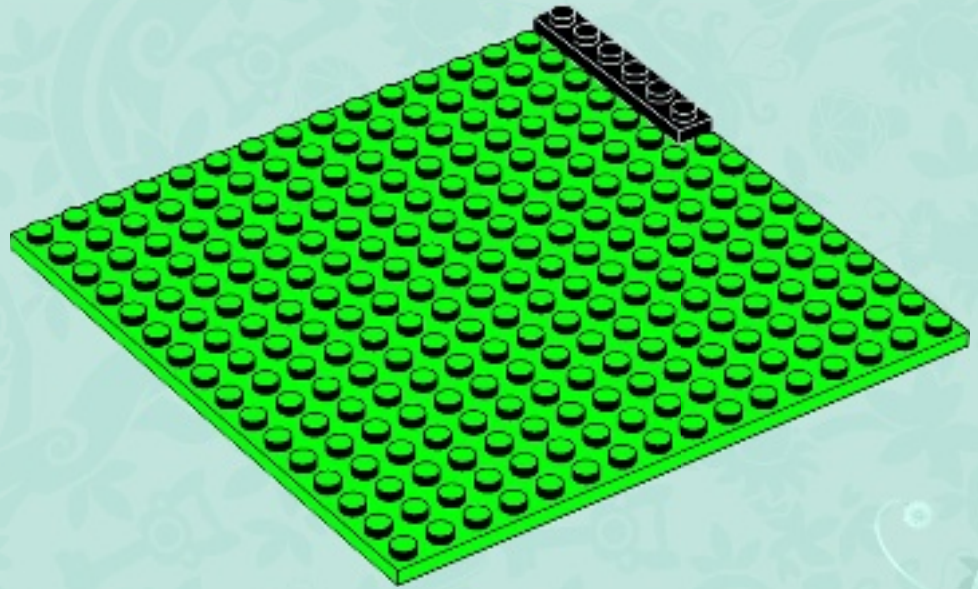

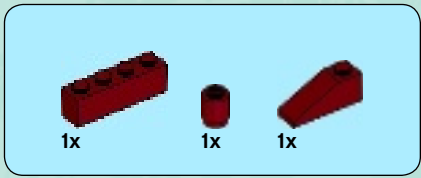

2

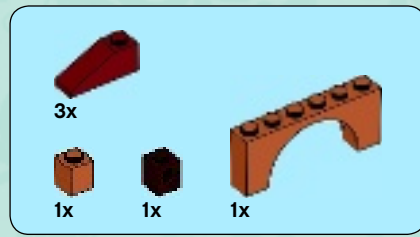
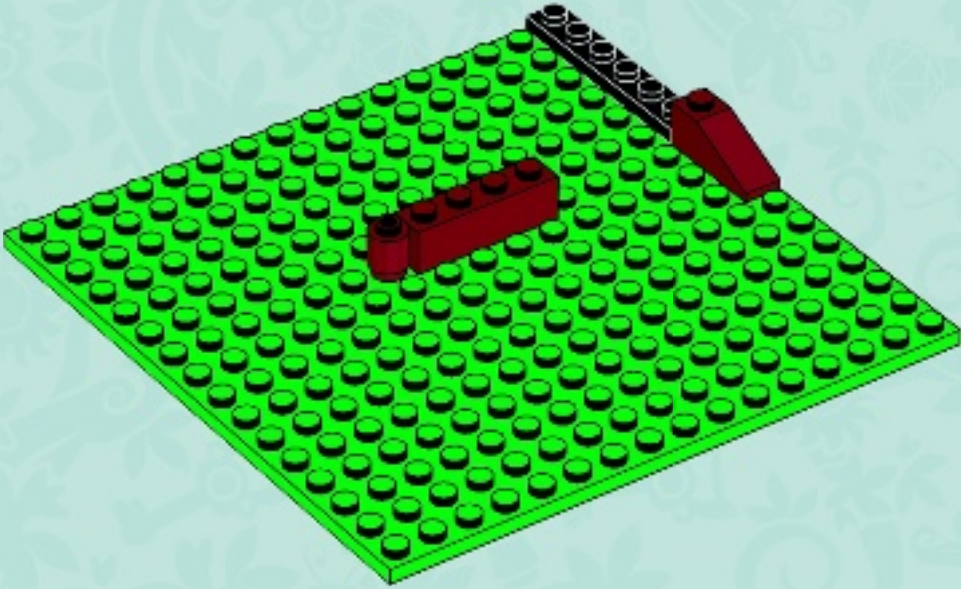

3

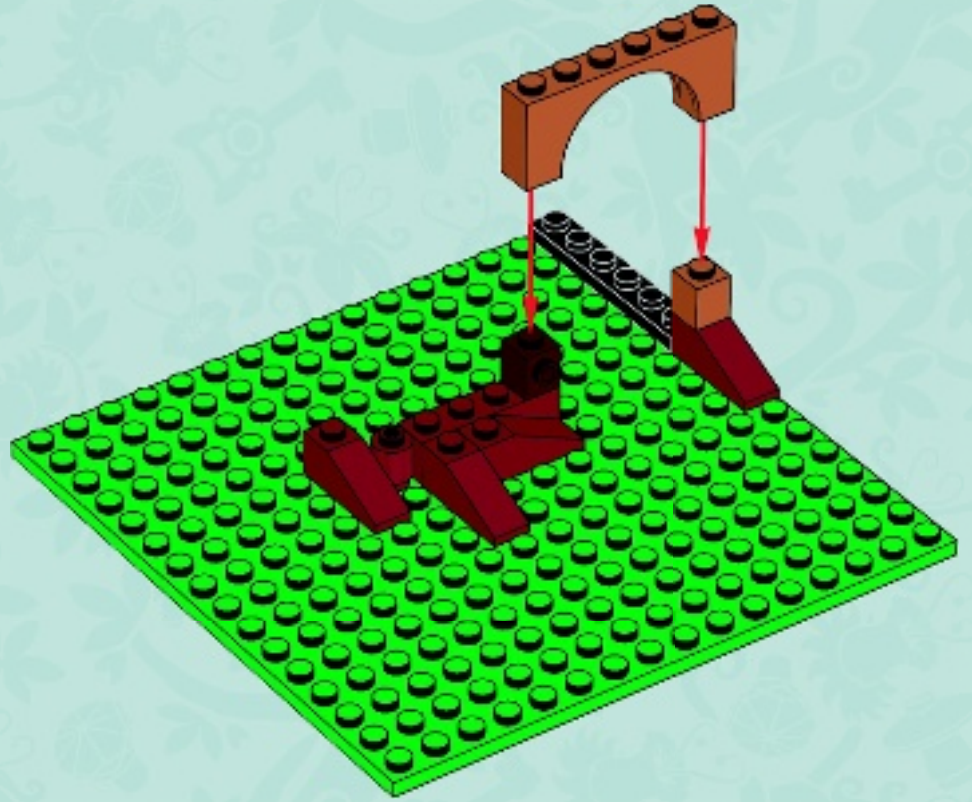

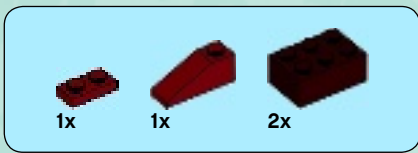

4

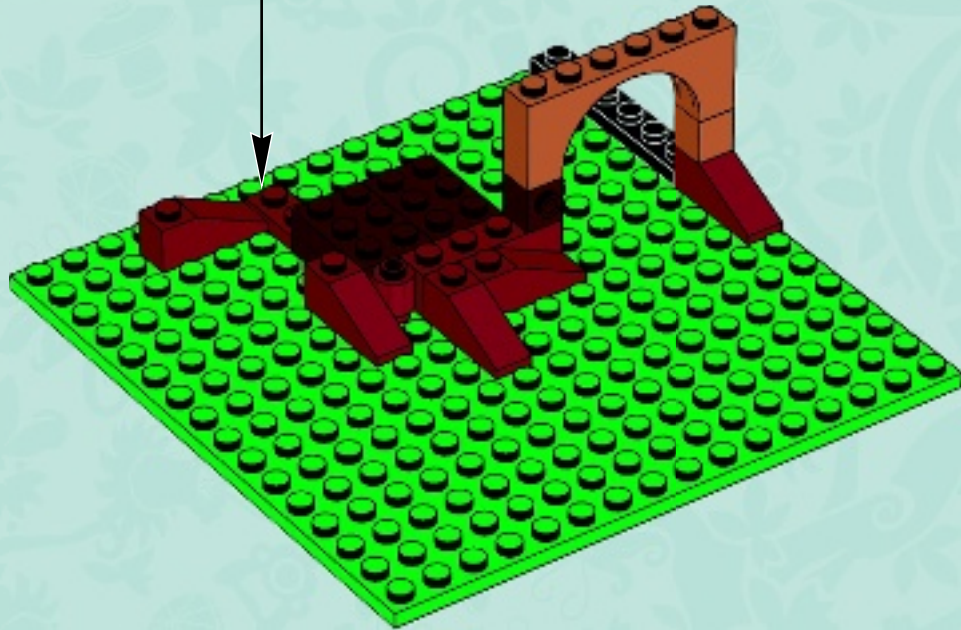
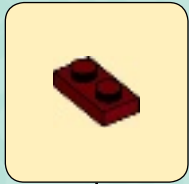

5

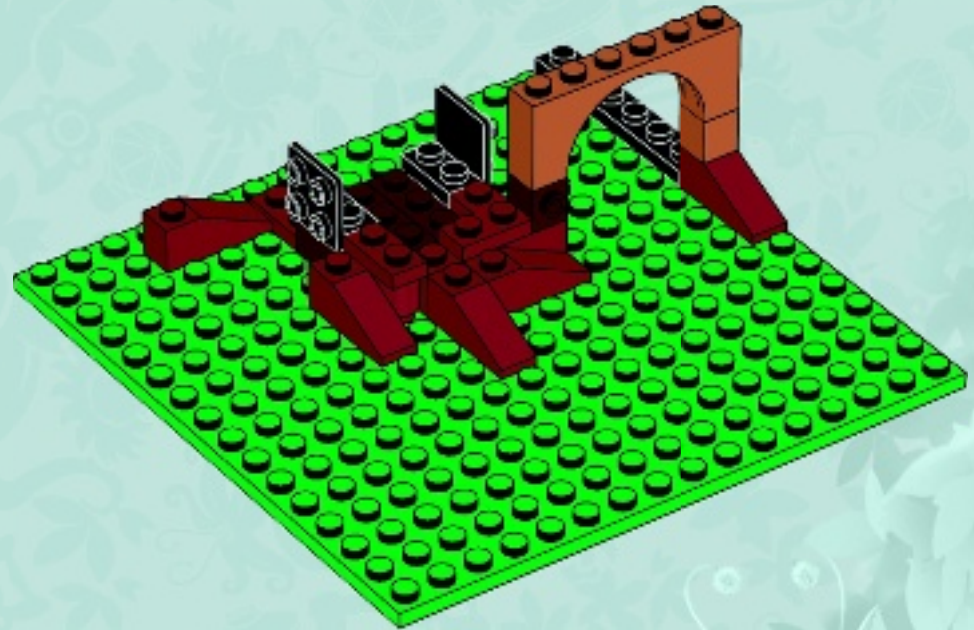



6

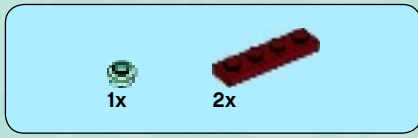
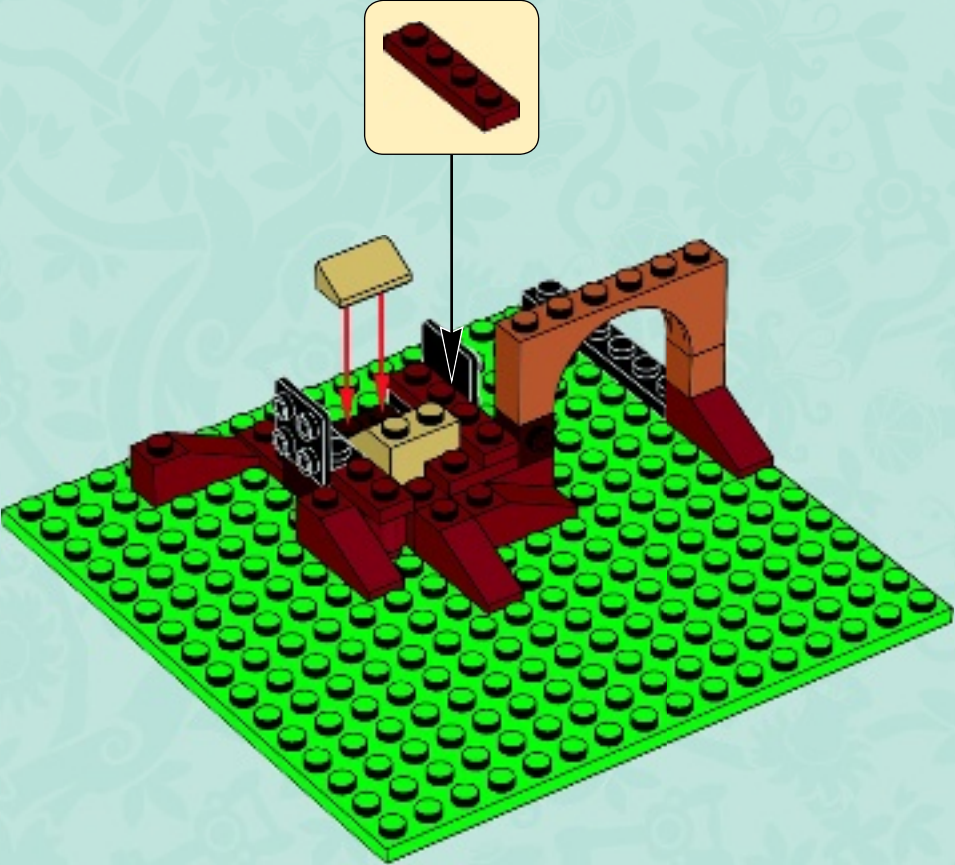

7

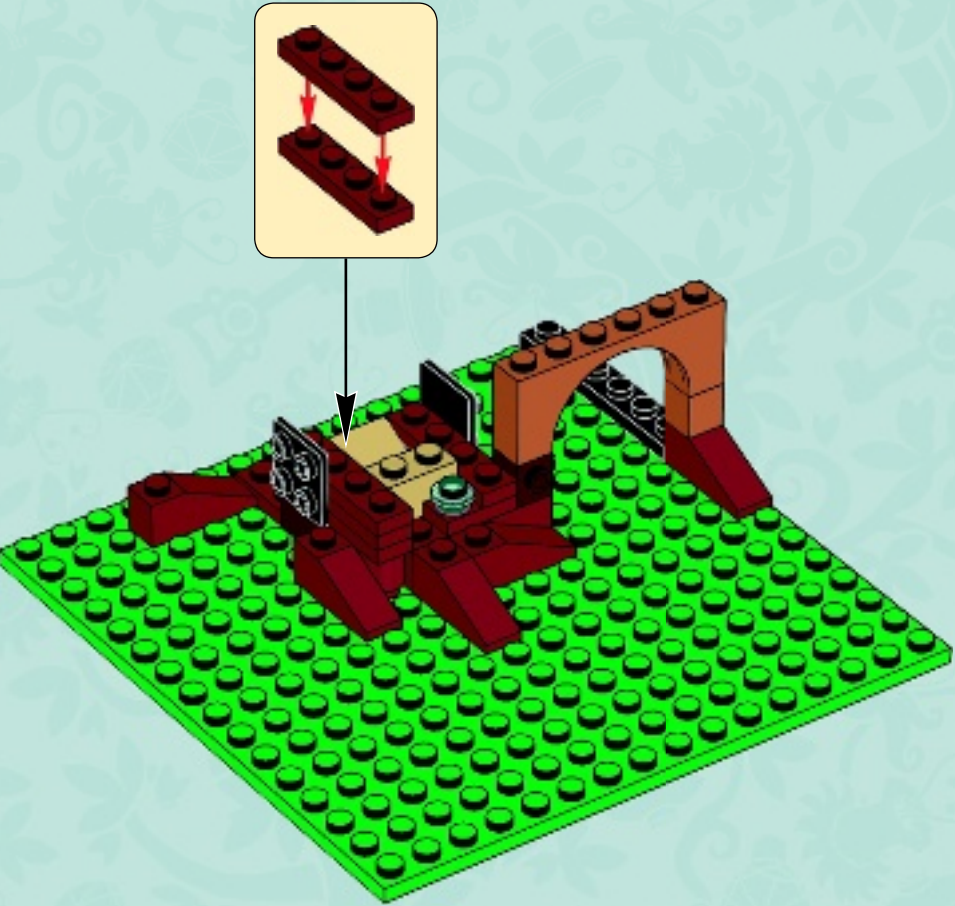

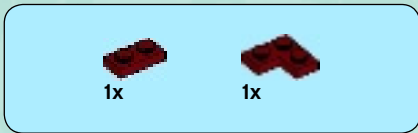

8

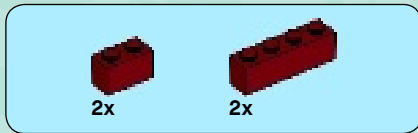
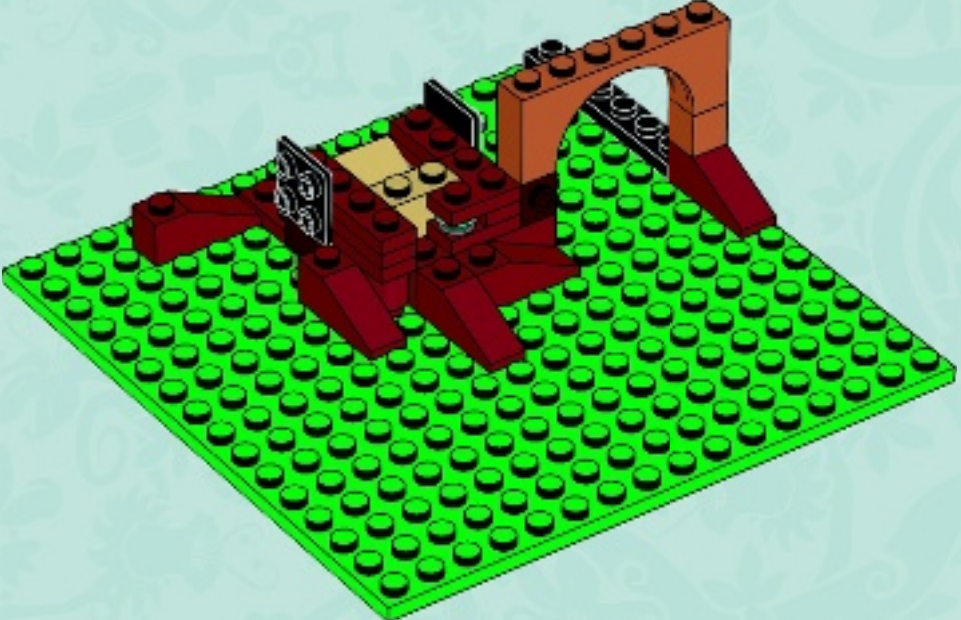

9

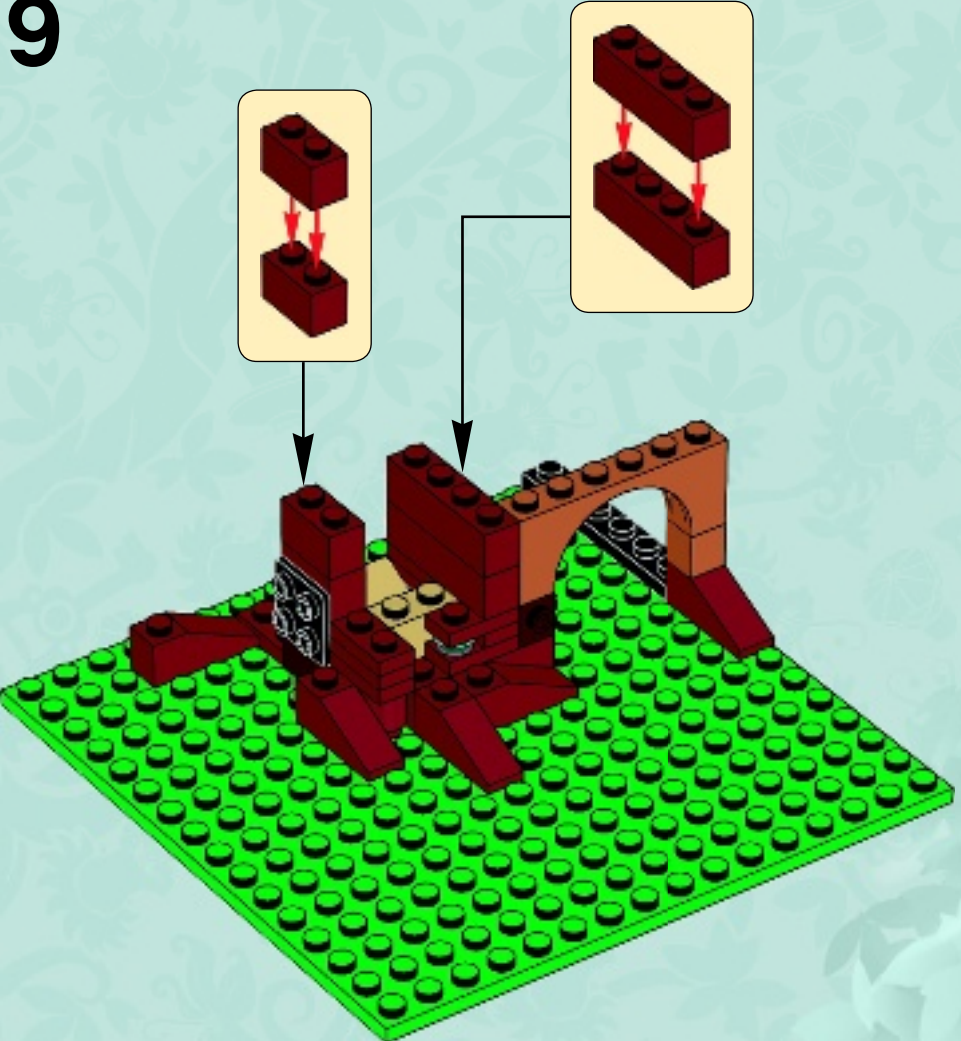

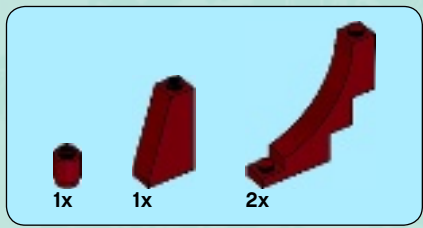

10

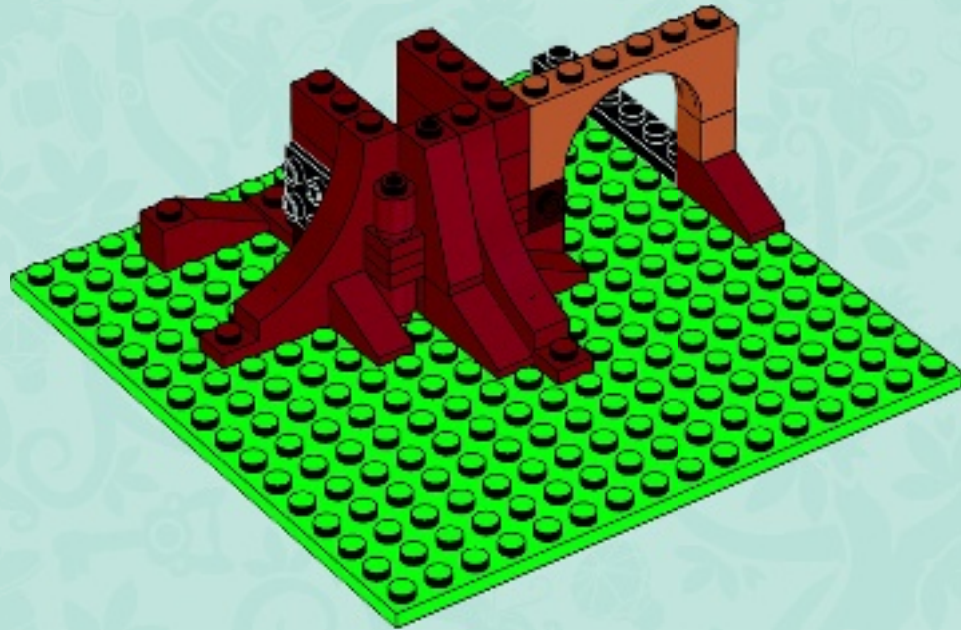



11

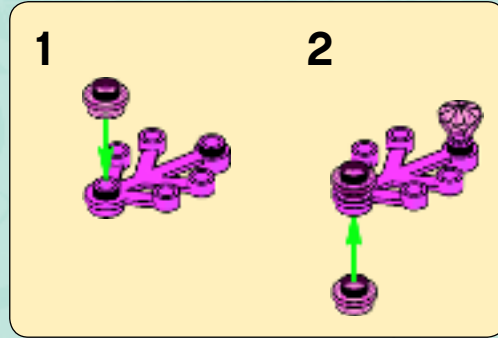

2

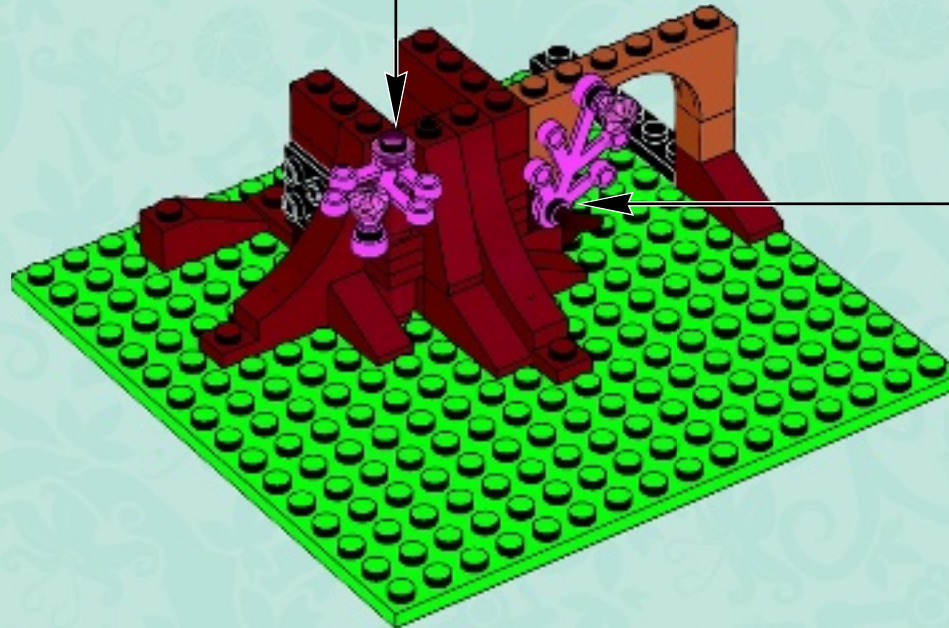
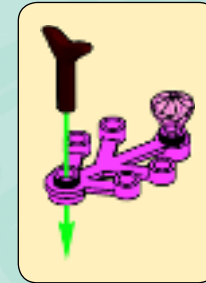

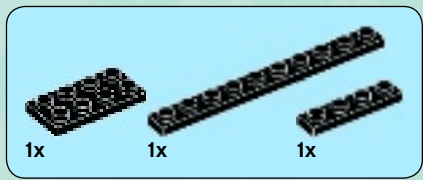

12



13

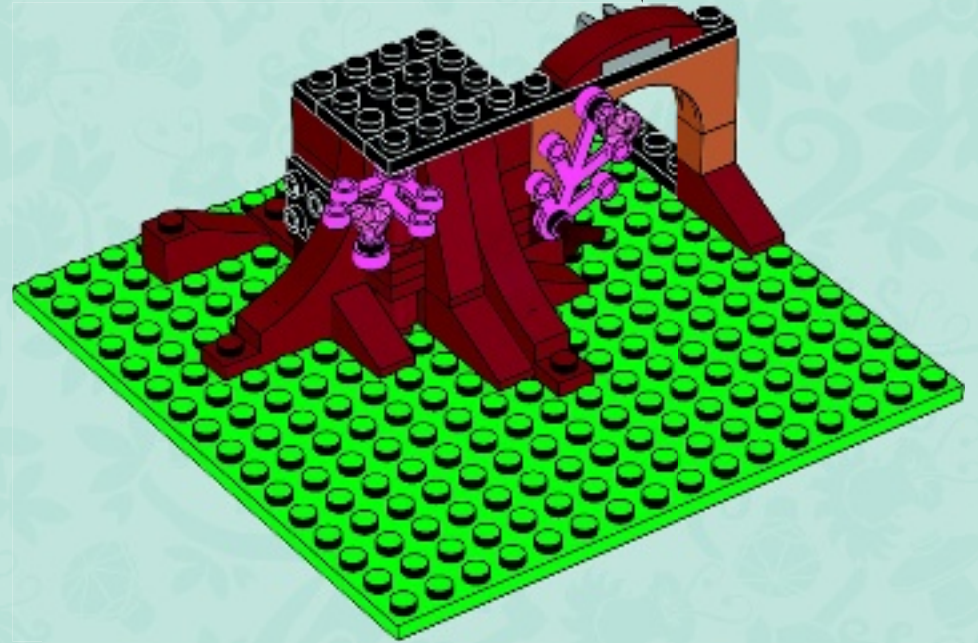
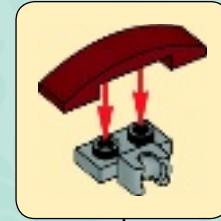

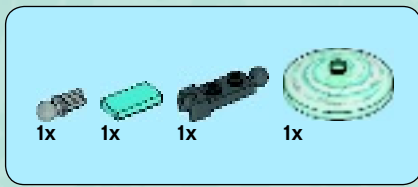

14

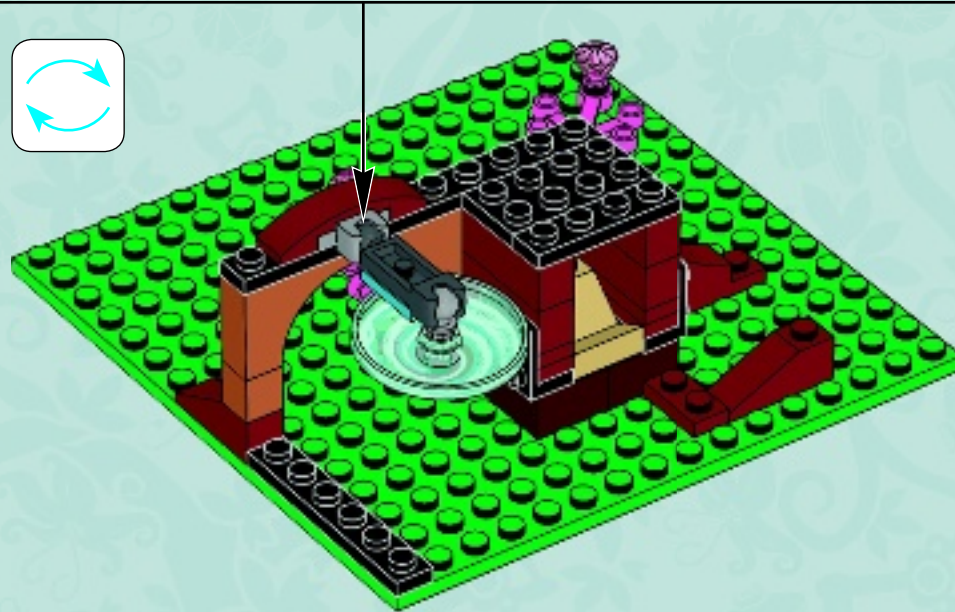
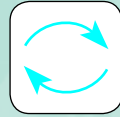
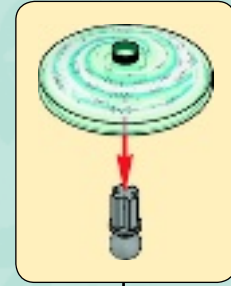
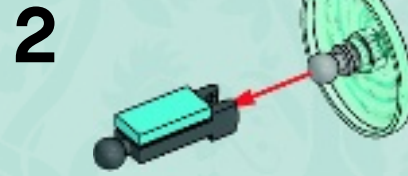
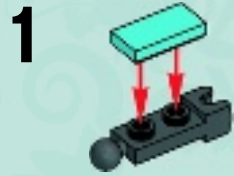

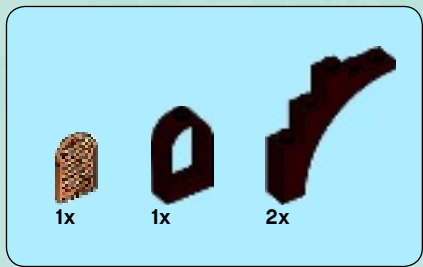

15

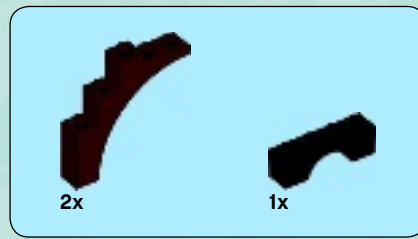

16

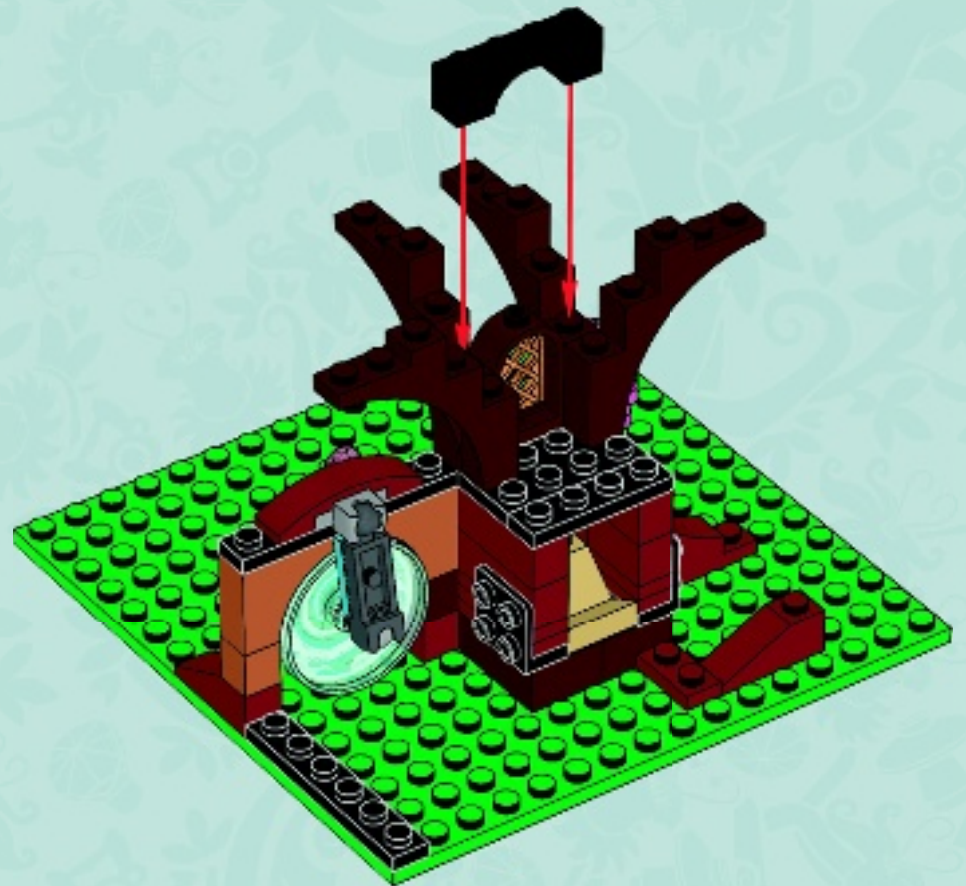

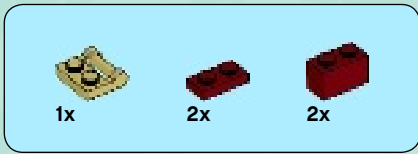

17

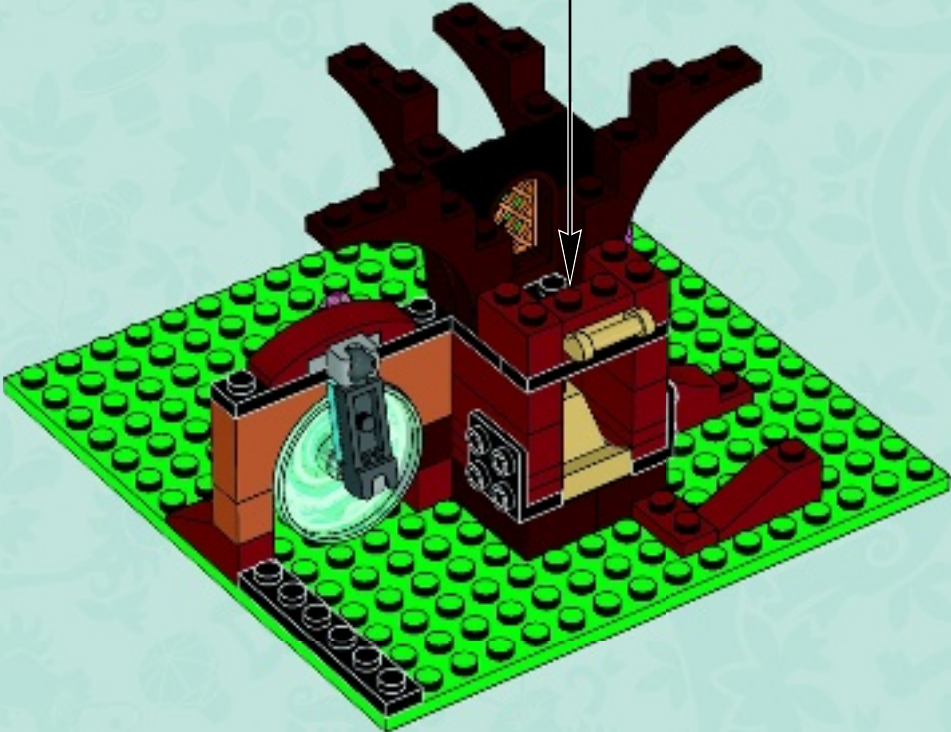
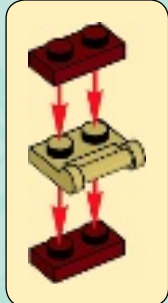

18

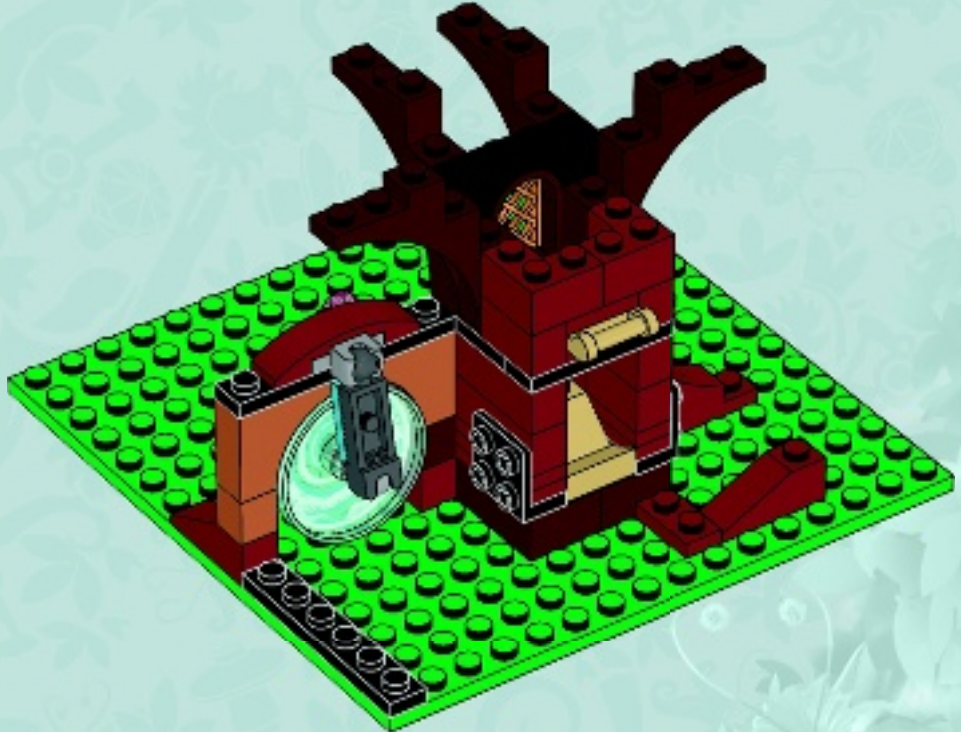

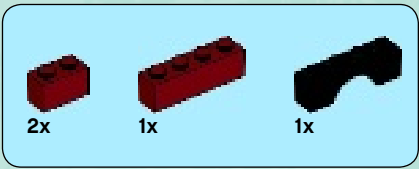

19

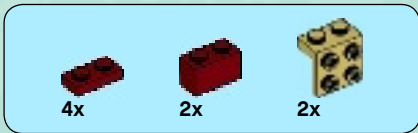
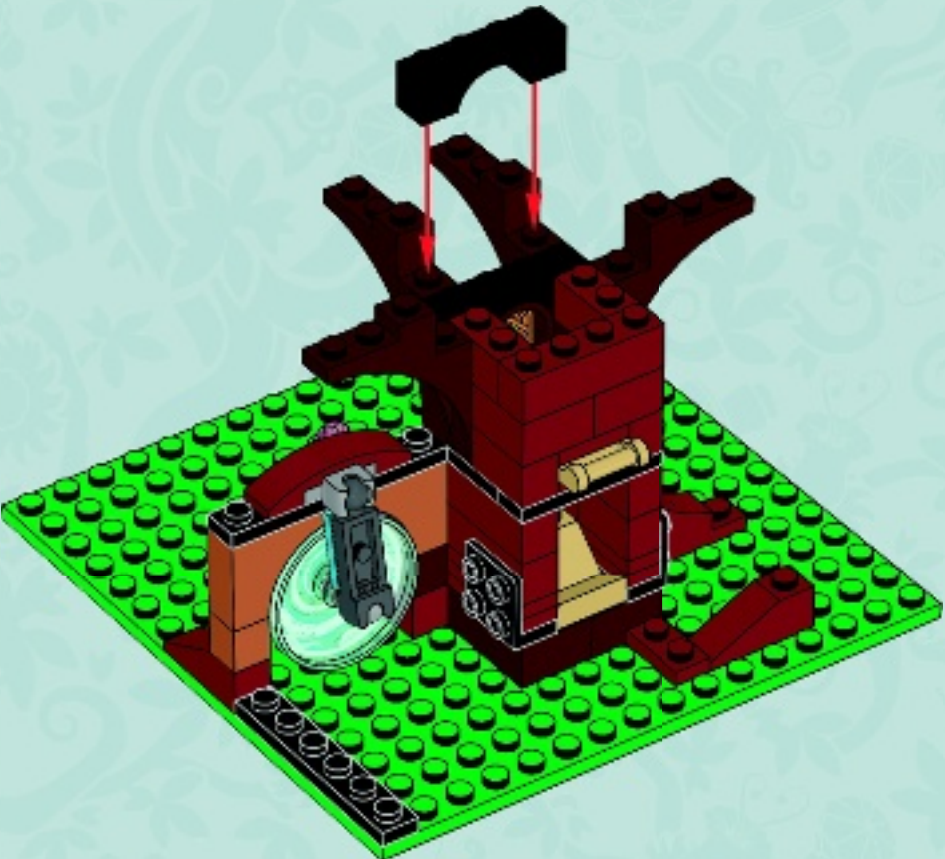

20

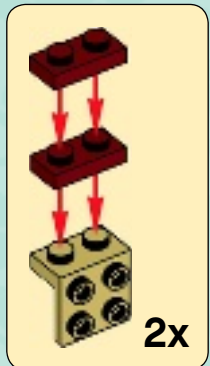

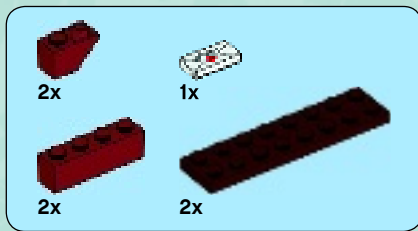

21



22

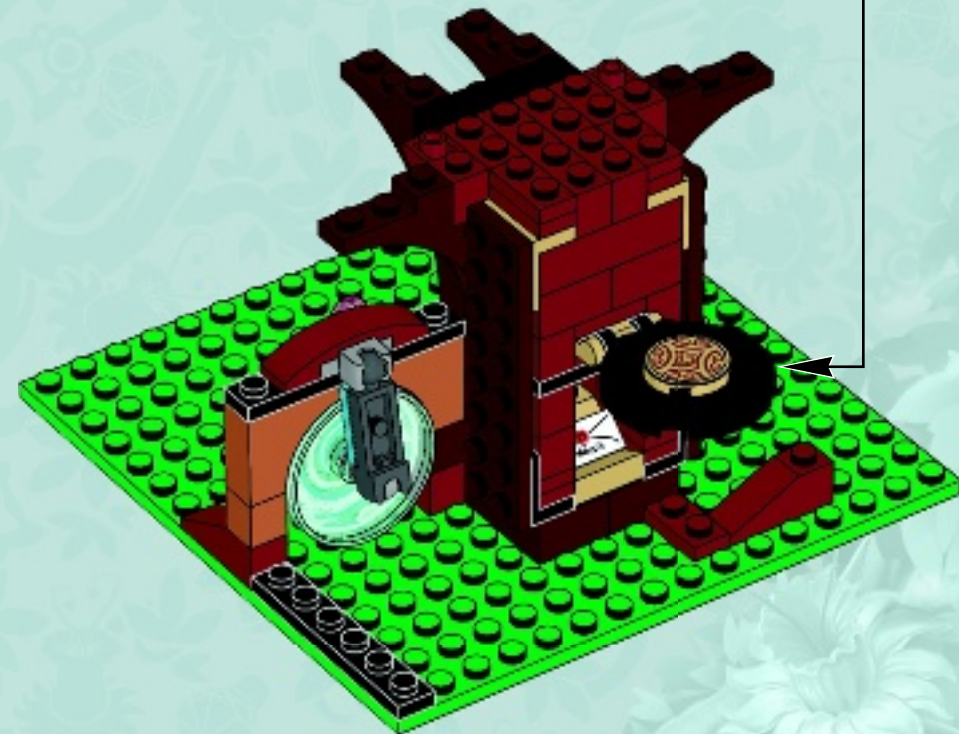
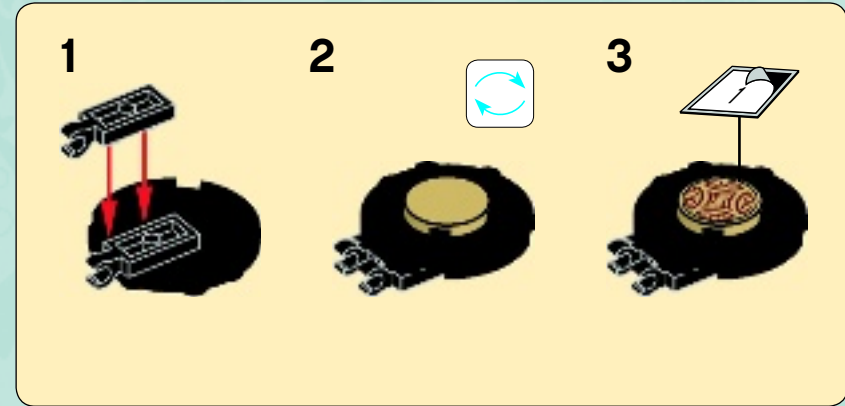

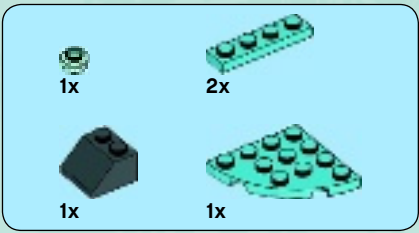

23



24





25

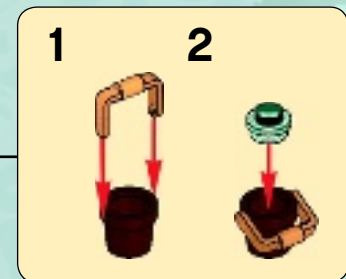



2

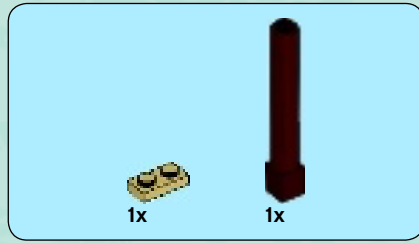

1x

1x

26

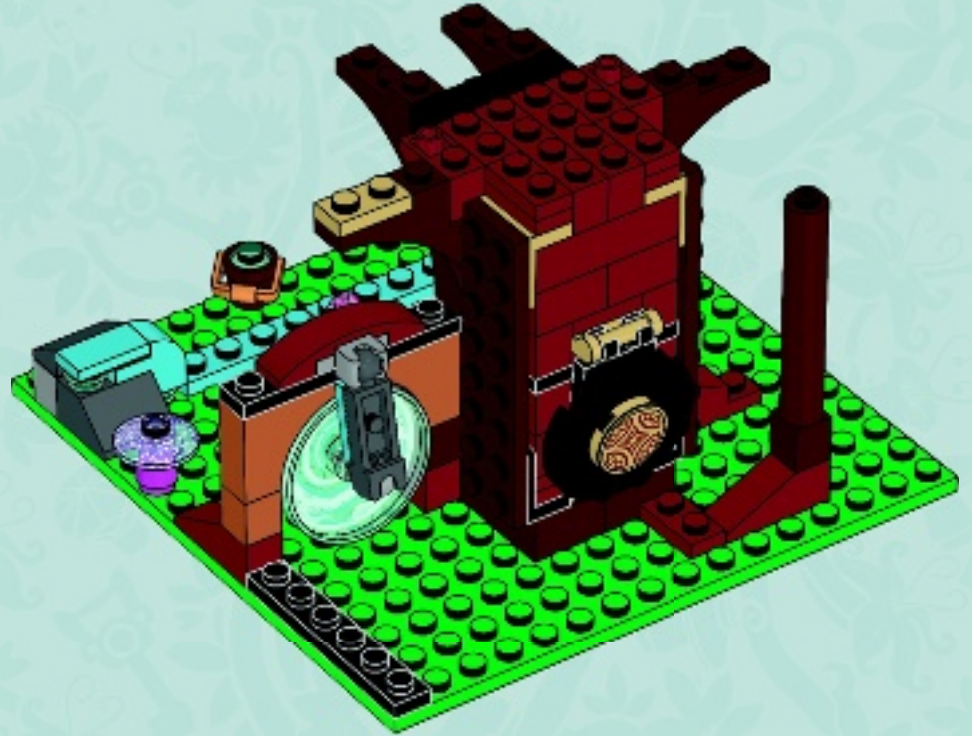
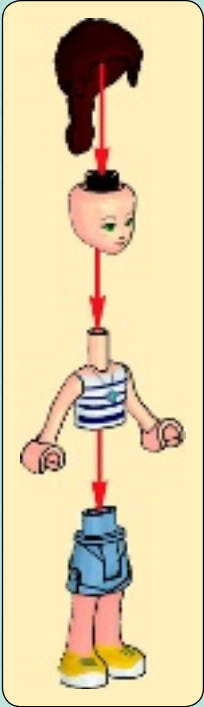
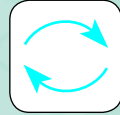

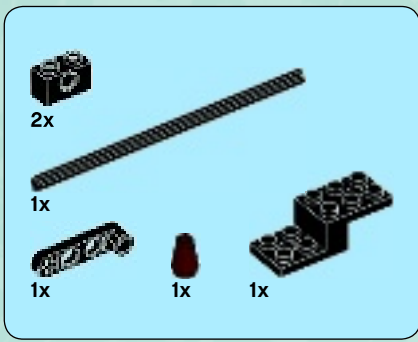

27

1



2



3

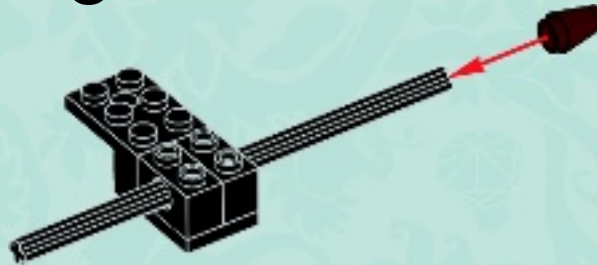

4

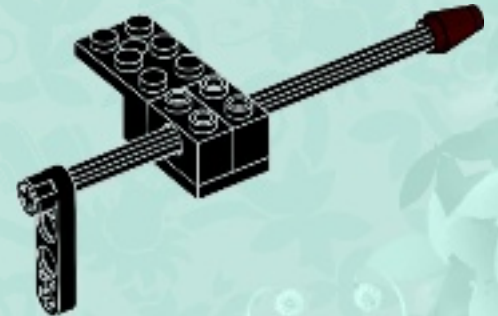

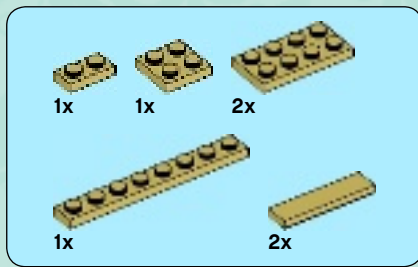

28

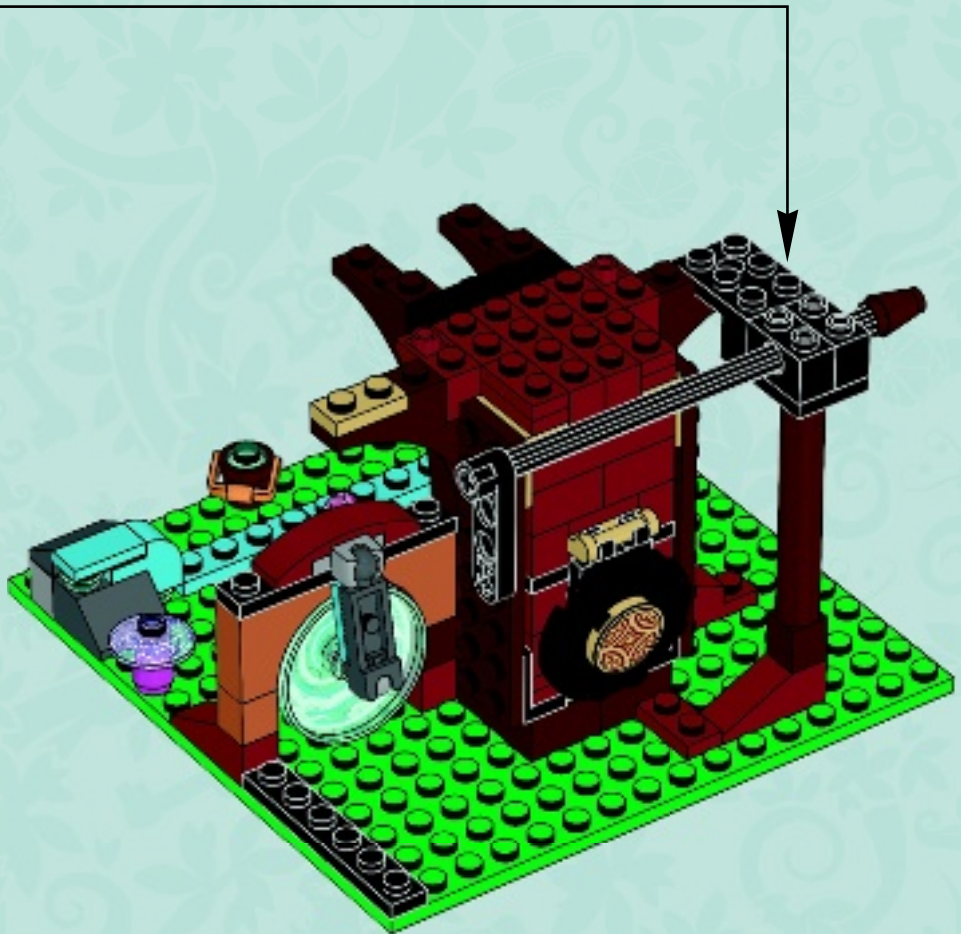

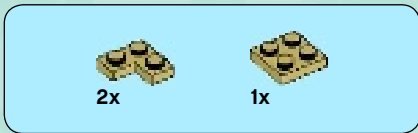

29

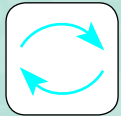
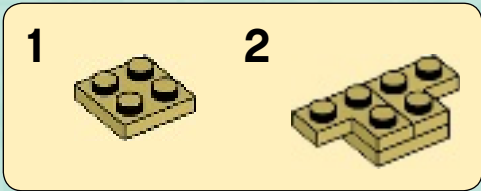



2x

30



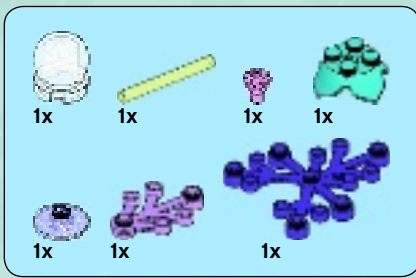

31

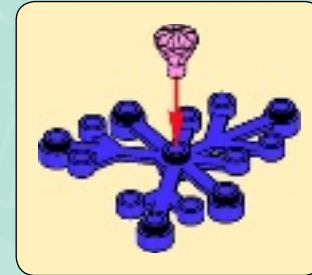
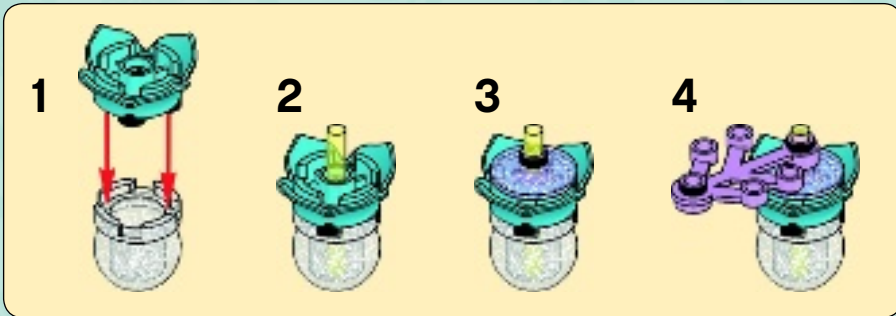



1x

32



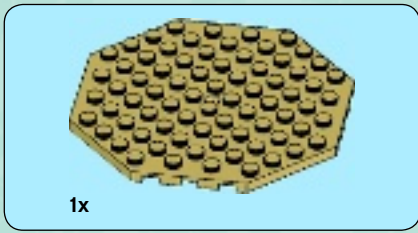

33



34



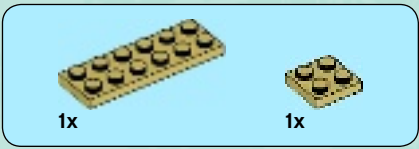

35





36

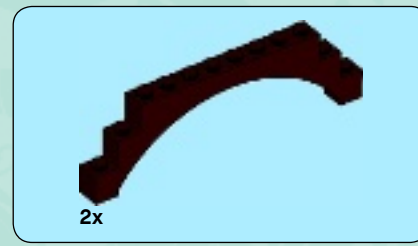
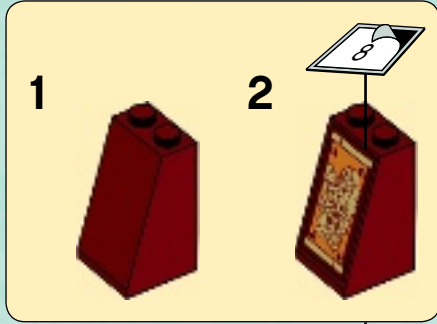

37





38



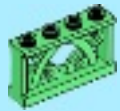

3x

39



2x



2x

40



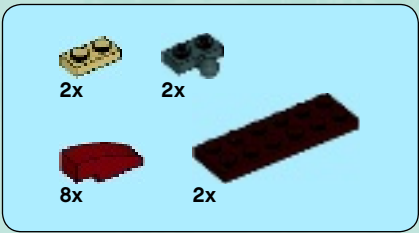

41

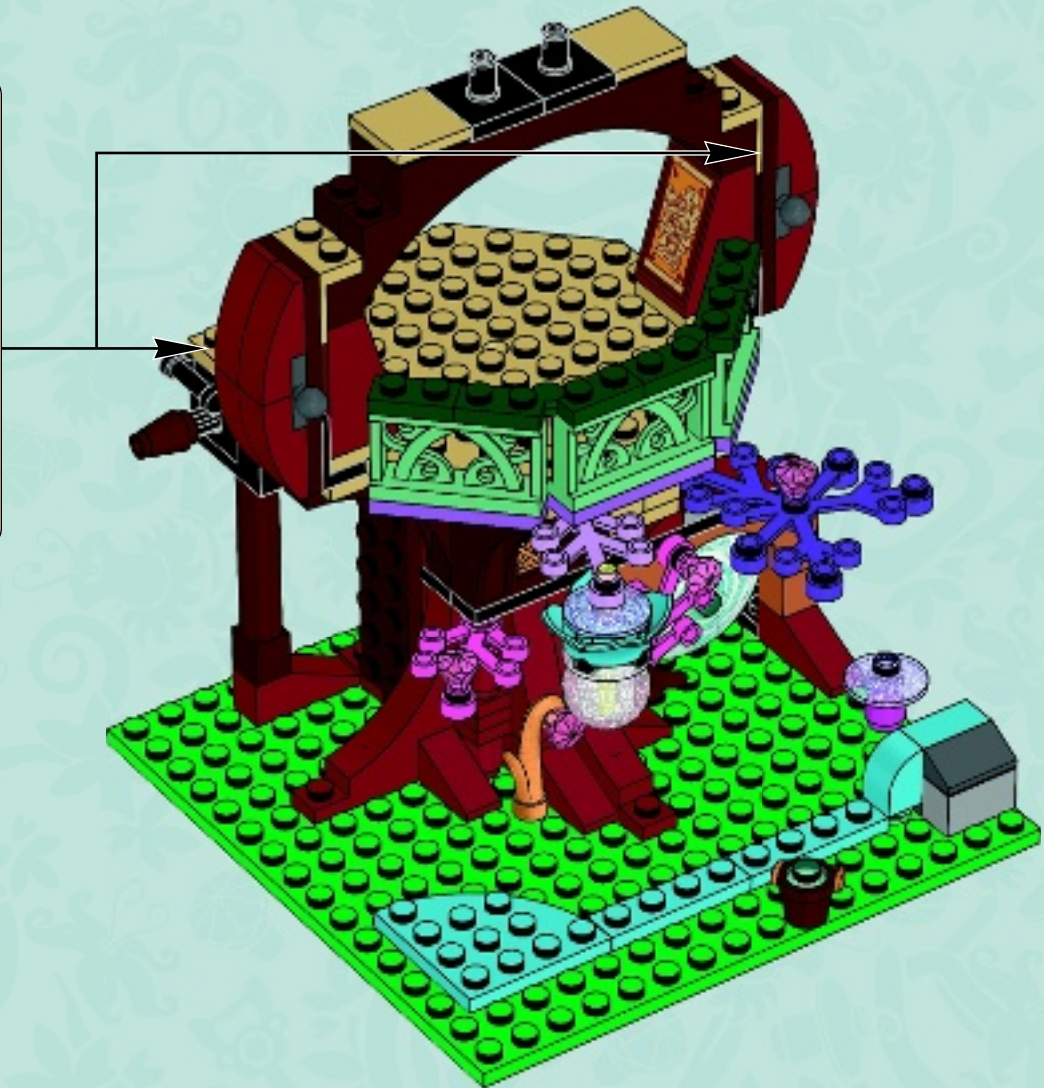
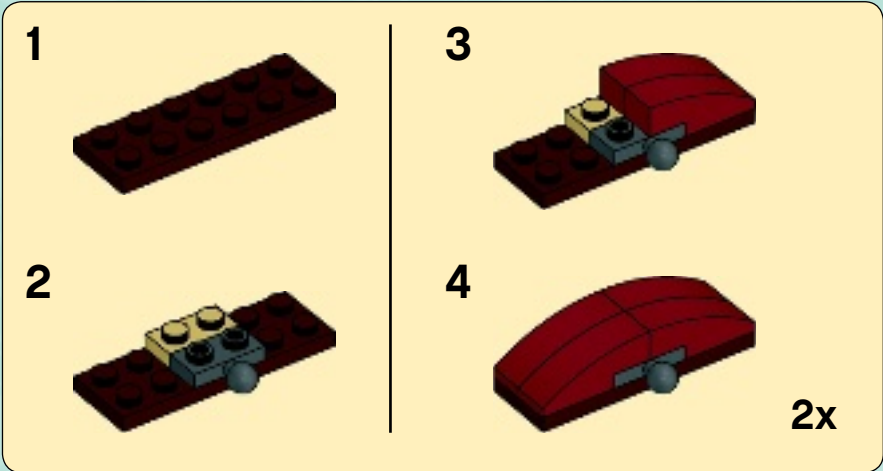



42

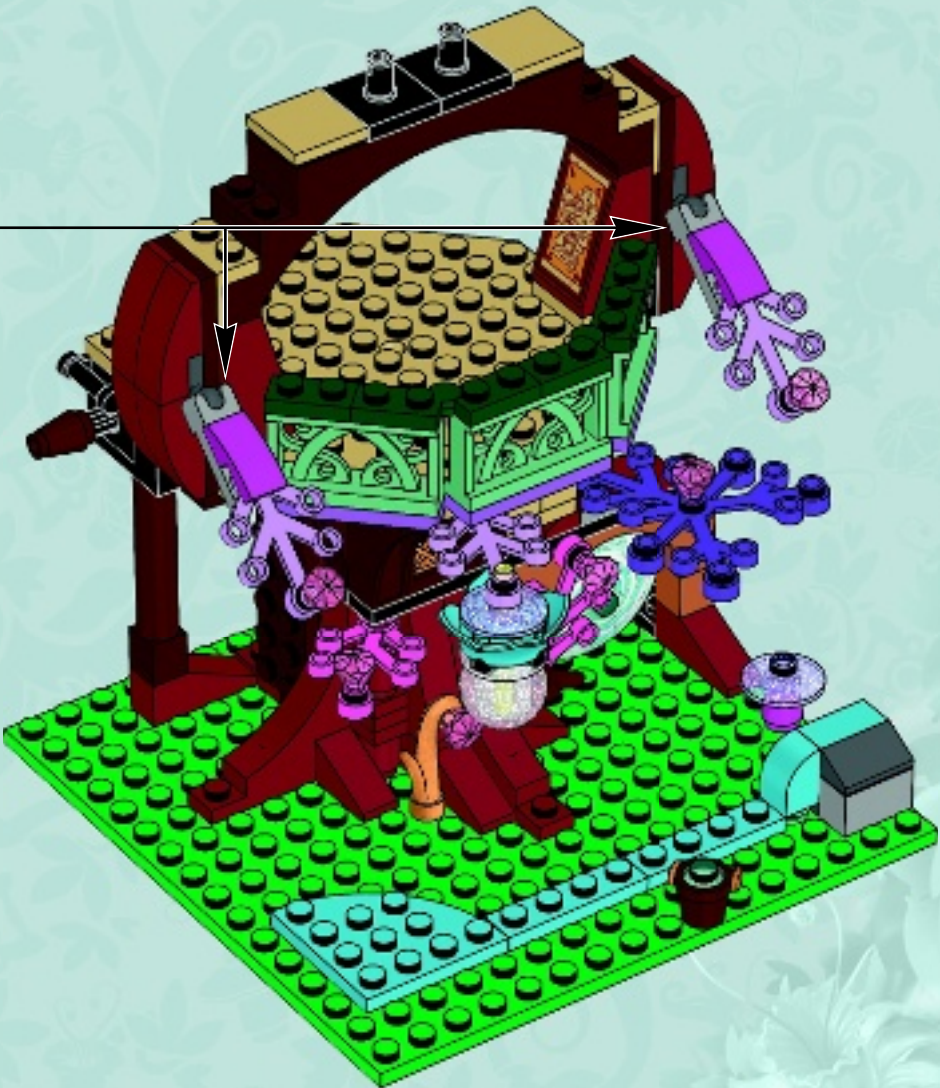
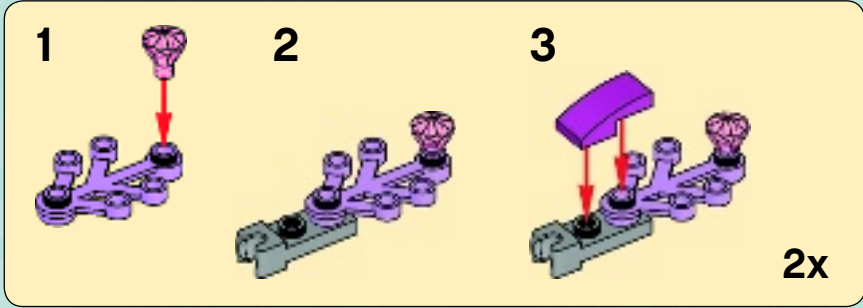

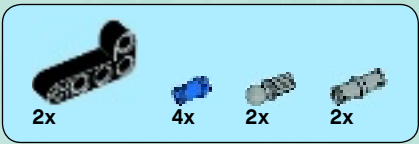

43

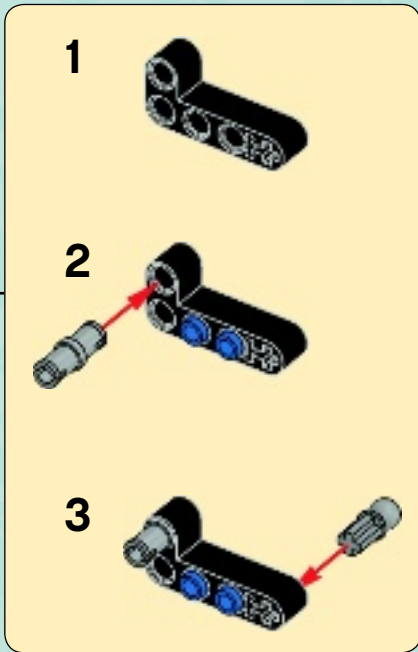
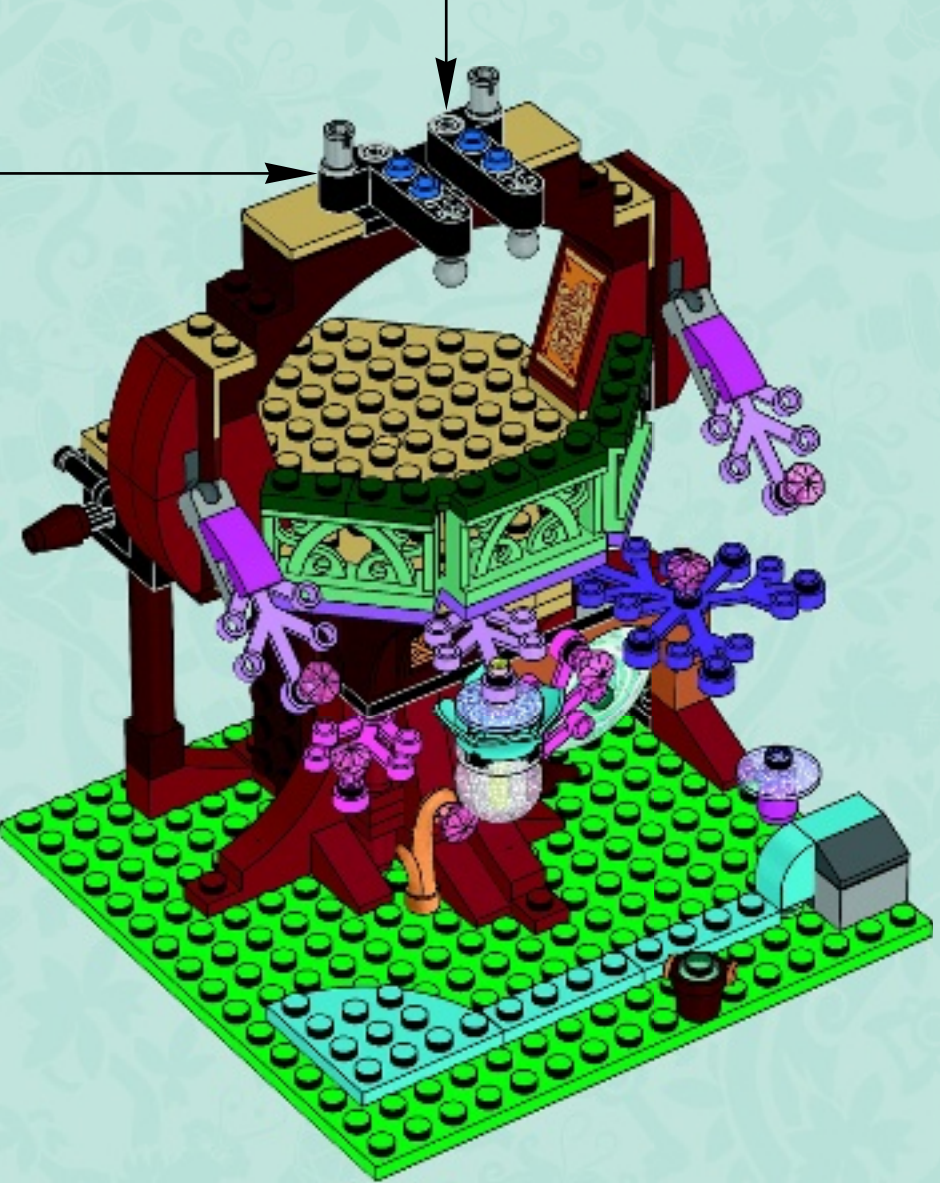
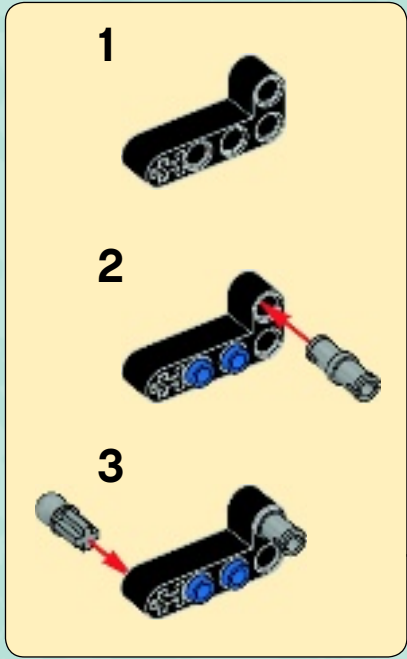

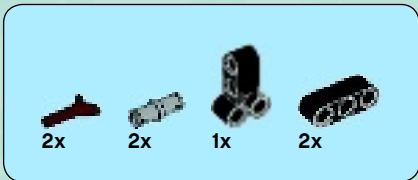

44

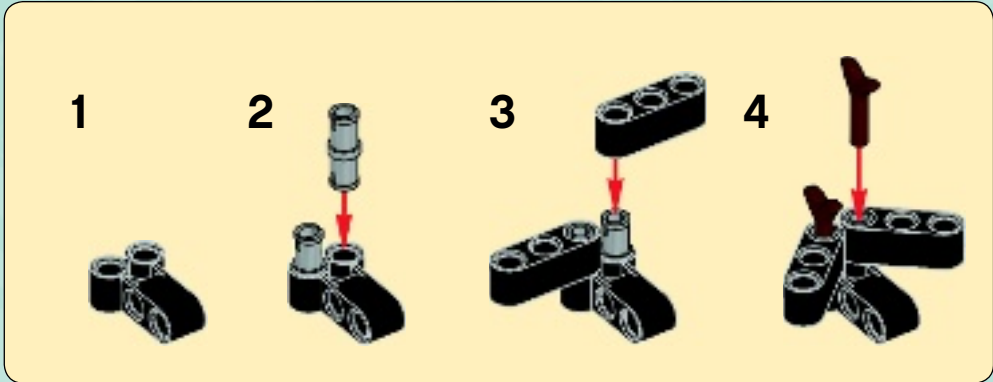

2x

2x

2x

45

1

2



1

2

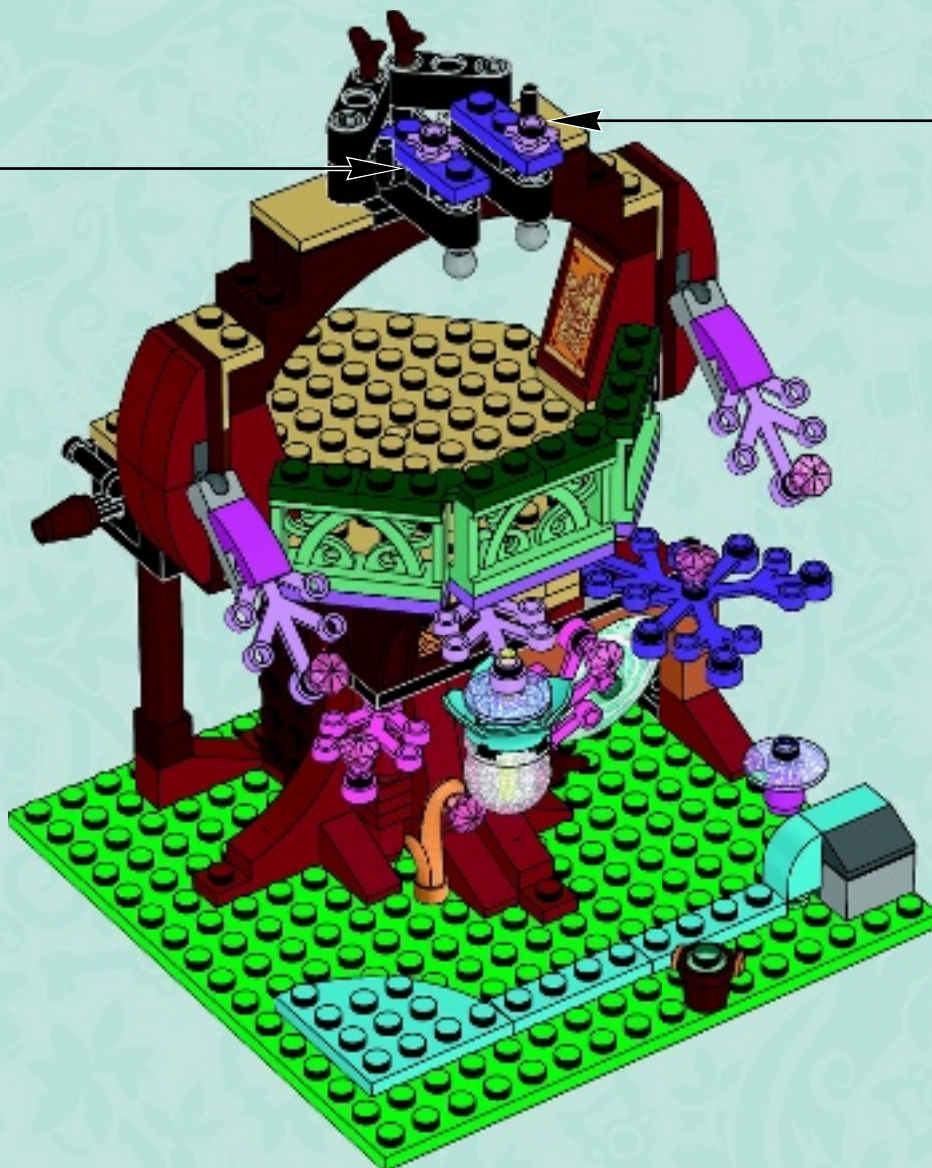



46

1



2



3



4

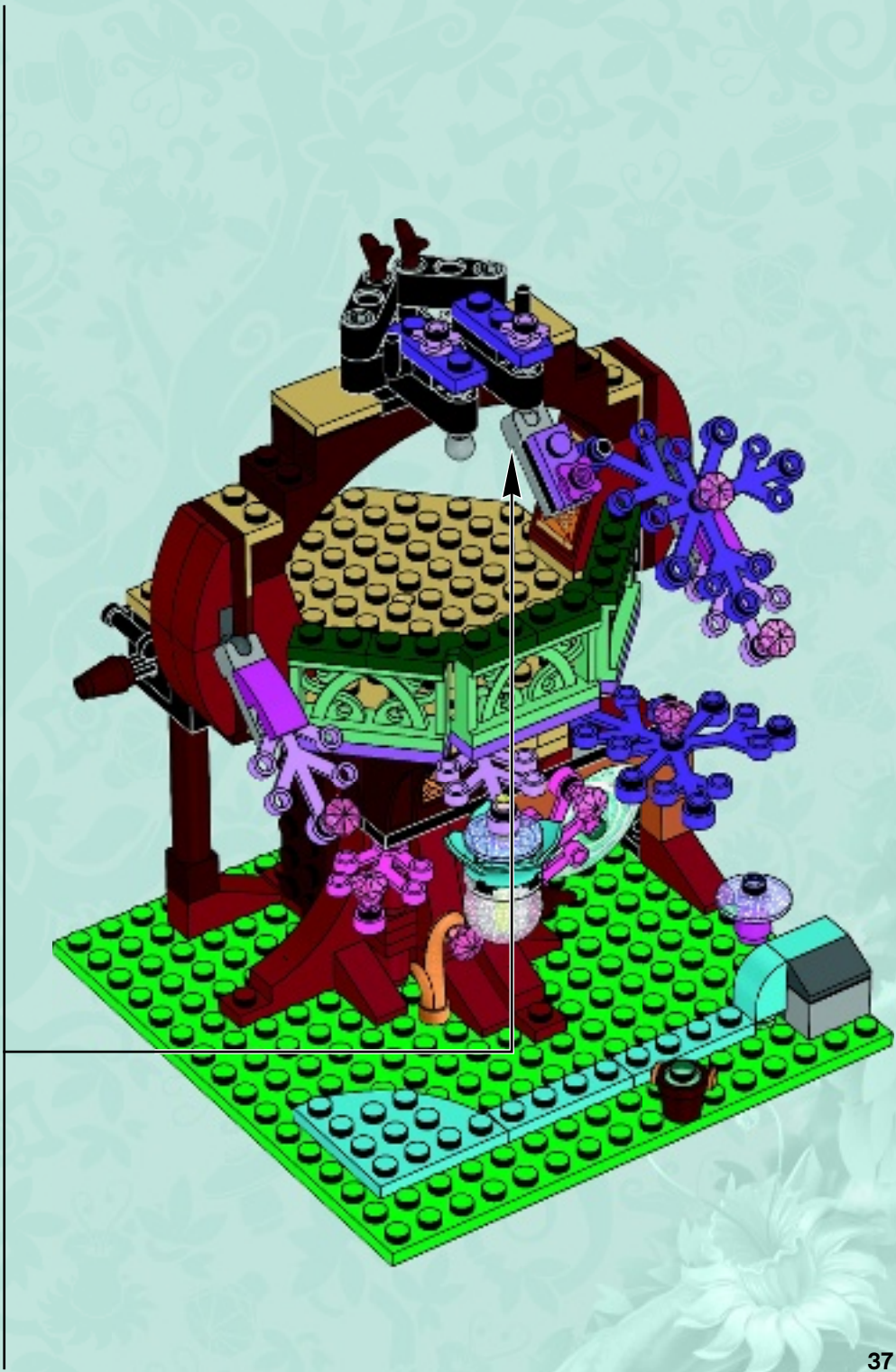

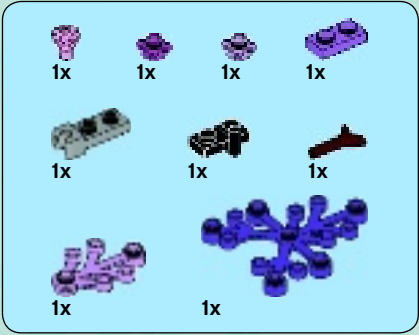

47

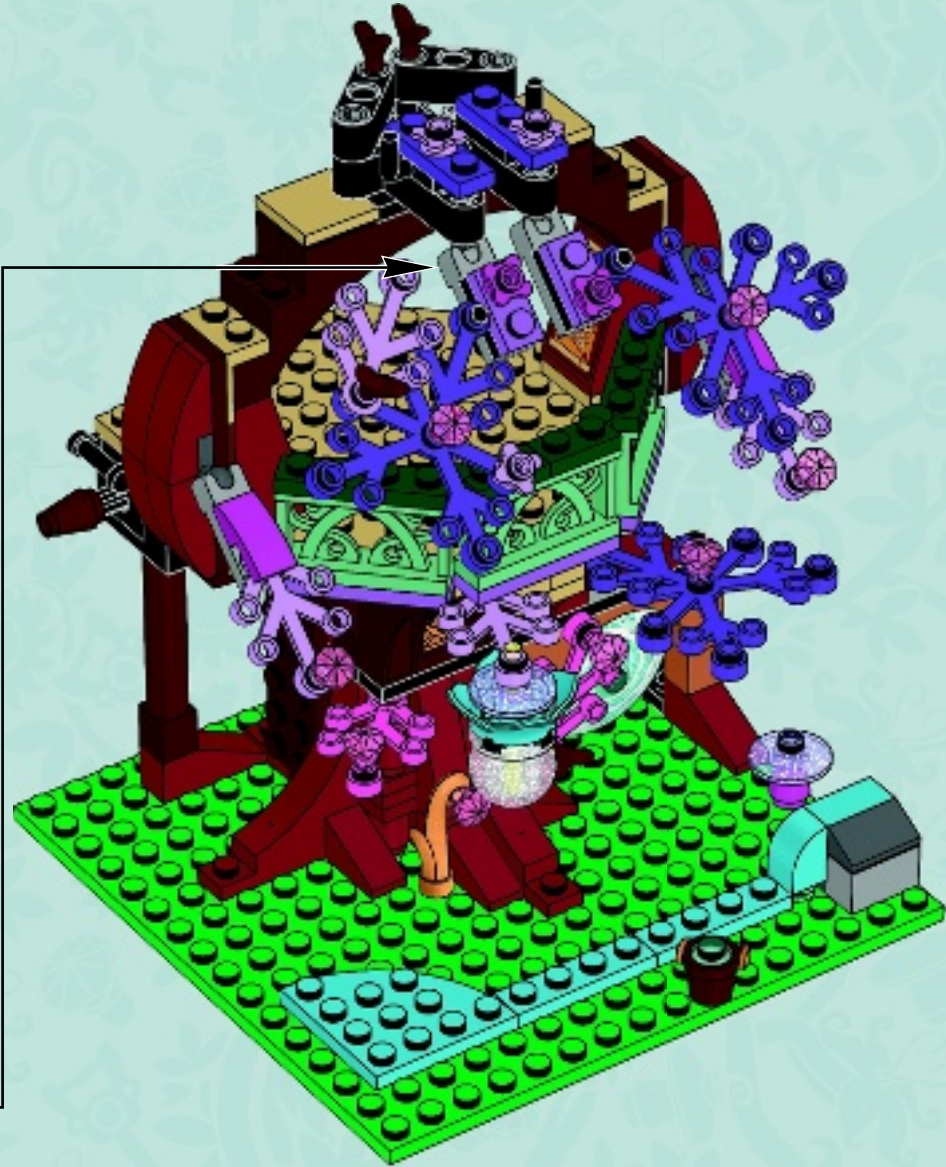

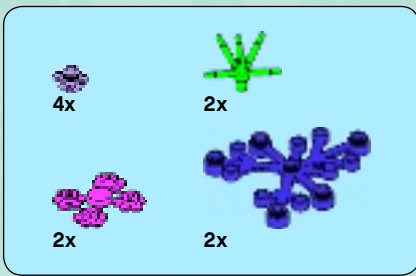

48

1



2



3

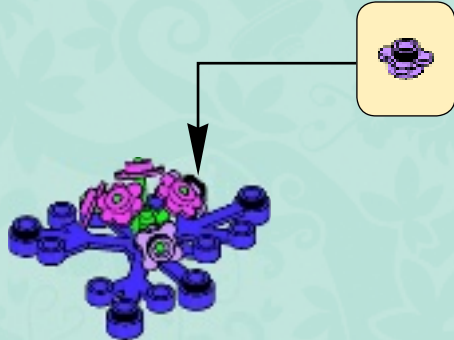

2x

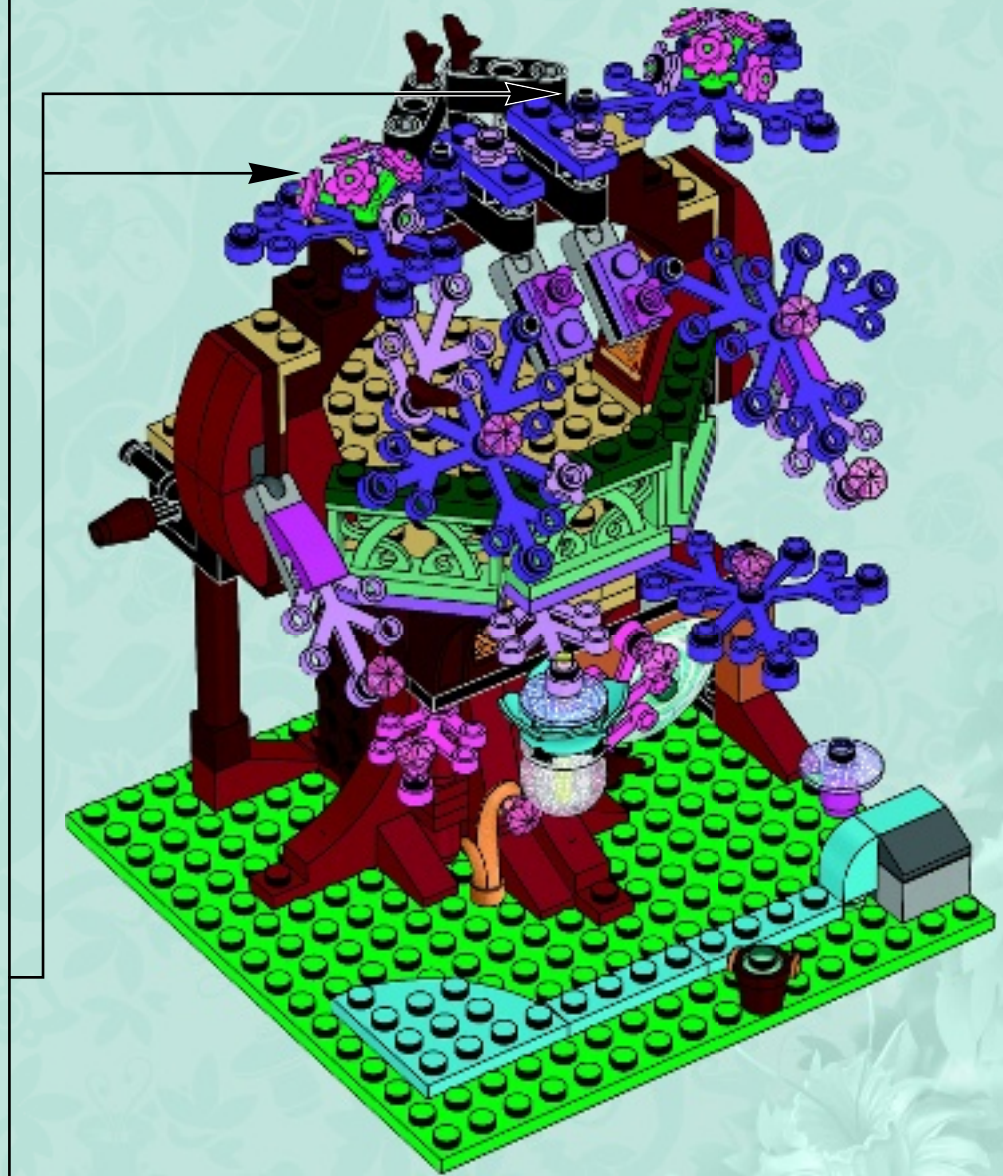

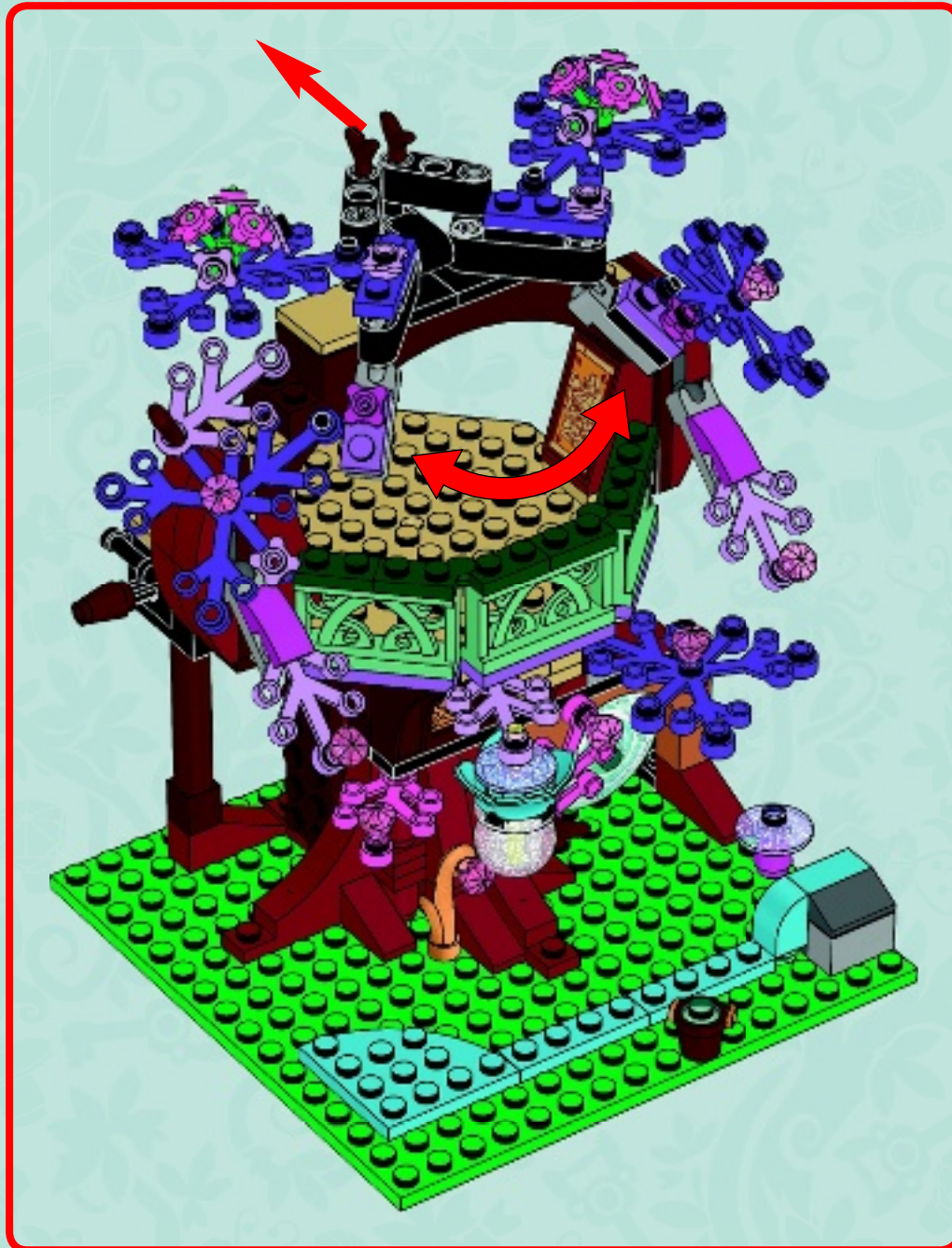

4x  5x 

49

1



2



3

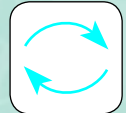

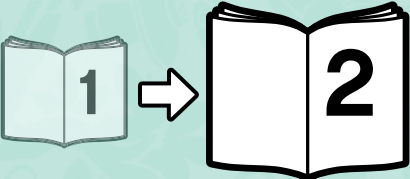



ELVES



Azari

Aira

Emily Jones

Farran

Naida

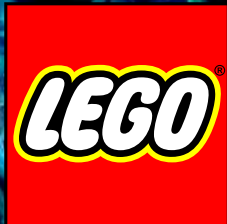

ELVES



Azari

Aira

Naida

Fanran

Emily Jones





ELVES



41071



41076



41075



41072



41073



41074

 LEGO.com/elves



ELVES



Apple, iPad and iPhone are trademarks of Apple Inc.
Google Play is a trademark of Google Inc.

WIN

GO TO WWW.LEGO.COM/PRODUCTFEEDBACK AND
GIVE US YOUR SHORT **FEEDBACK** ABOUT THIS
LEGO® SET FOR A CHANCE TO WIN
A COOL LEGO PRIZE.



LEGO.com/productfeedback

GEWINNE



Erzähle uns auf
www.LEGO.com/productfeedback

etwas über die Erfahrungen, die
du mit diesem LEGO® Set gemacht
hast, und sichere dir die Chance
auf einen coolen LEGO Preis!

GAGNE



Rends-toi sur
www.LEGO.com/productfeedback

et donne-nous quelques com-
mentaires sur ce produit LEGO®
pour avoir une chance de gagner
un prix LEGO !

GANAN



Visita
www.LEGO.com/productfeedback

y envíanos tu opinión acerca de
este set LEGO®. ¡Participarás en el
sorteo de un premio LEGO!

获取奖品



登录
www.LEGO.com/productfeedback

给出关于此乐高®套装的简短反馈，
就有机会获得炫酷乐高奖品

경품 당첨 기회



www.LEGO.com/productfeedback

페이지로 이동하여 이 레고® 세트에
대한 간략한 피드백을 보내 주시고
멋진 레고 경품을 탈 수 있는 기회도
잡으십시오

ЗАПОЛНИ АНКЕТУ И ПОЛУЧИ ПРИЗ



Перейди по ссылке
www.LEGO.com/productfeedback

ответь всего на несколько во-
просов об этом наборе LEGO®,
и у тебя появится шанс выиграть
замечательный приз от компании
LEGO.

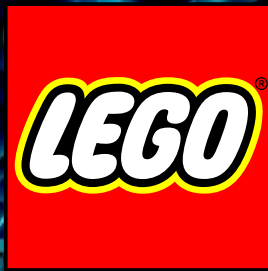

ELVES

41075



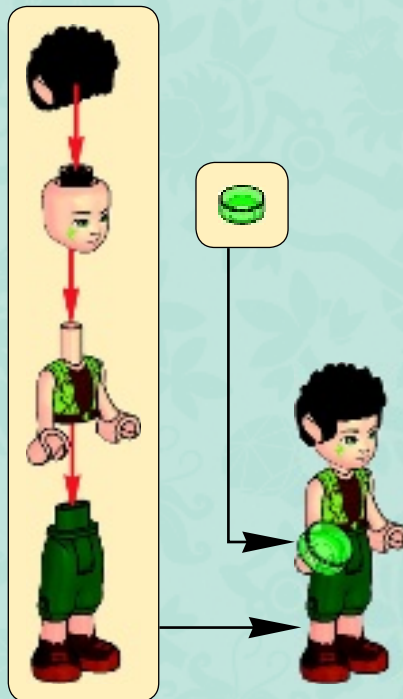
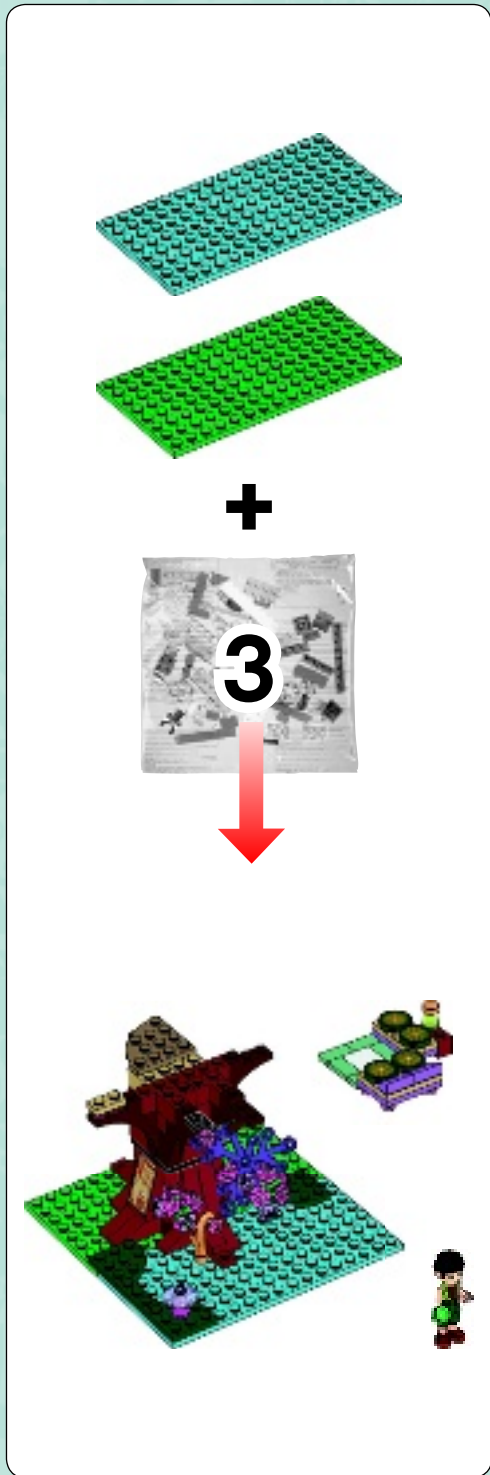

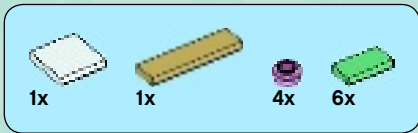

50





1x



1x



1x

51

1



2



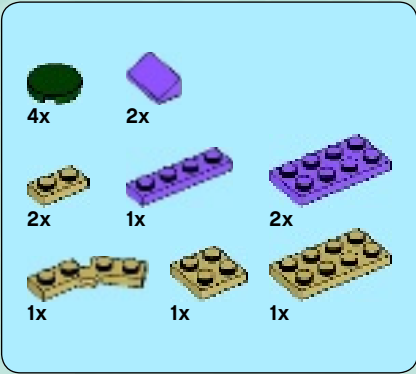

52

1

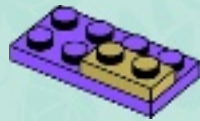

2



3



4



5

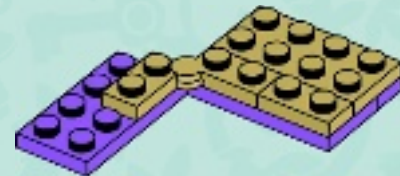

6



7

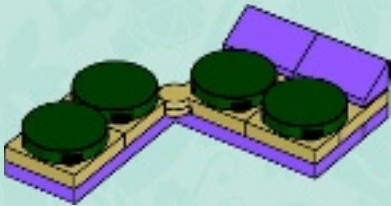

8

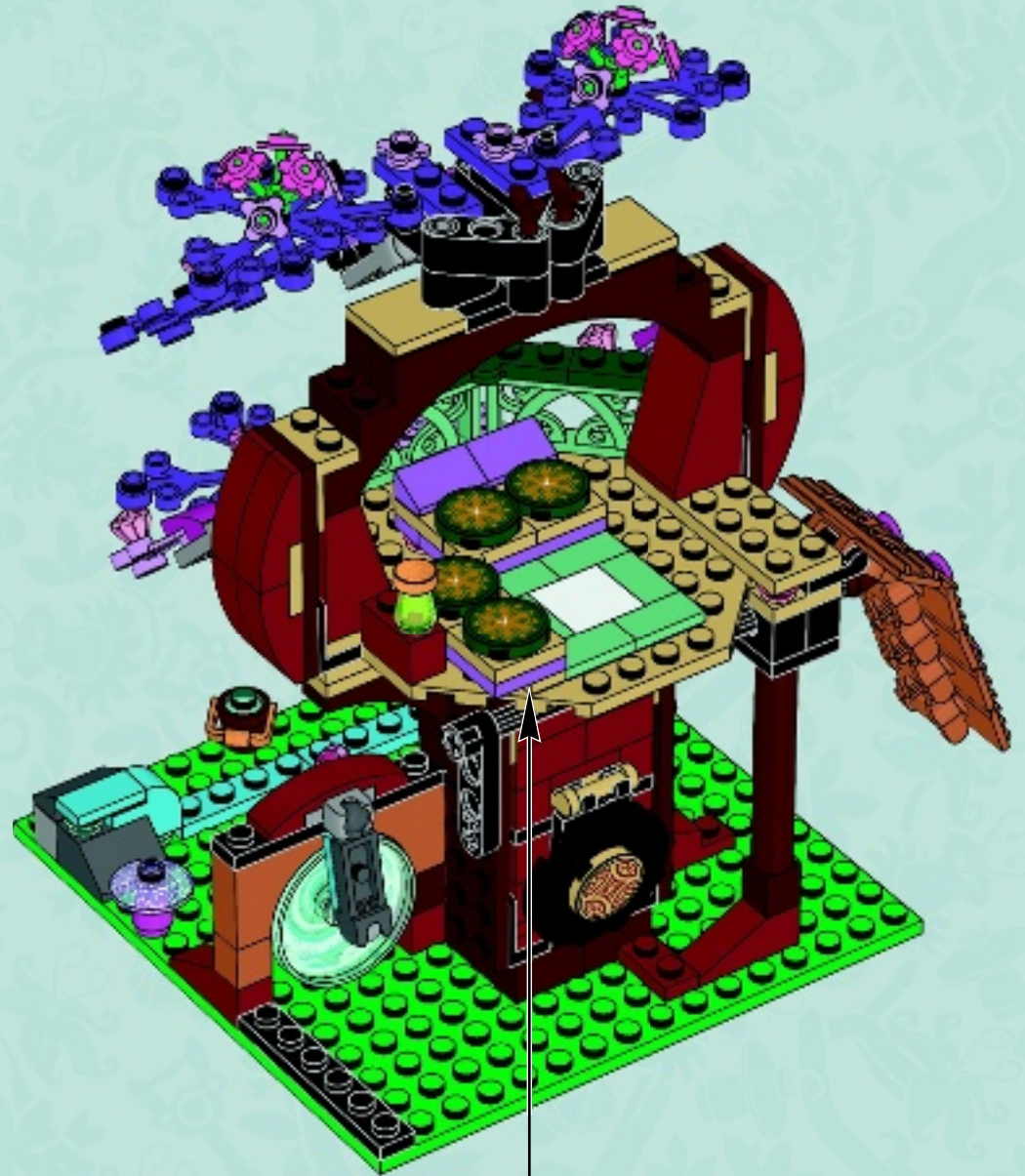
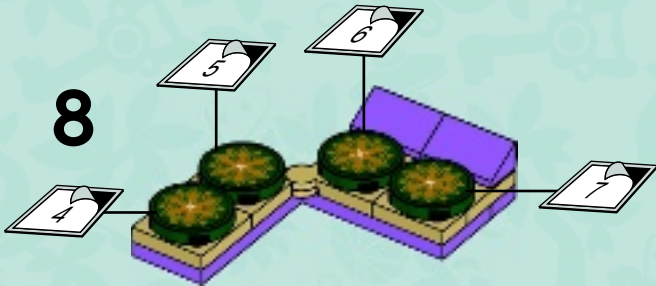

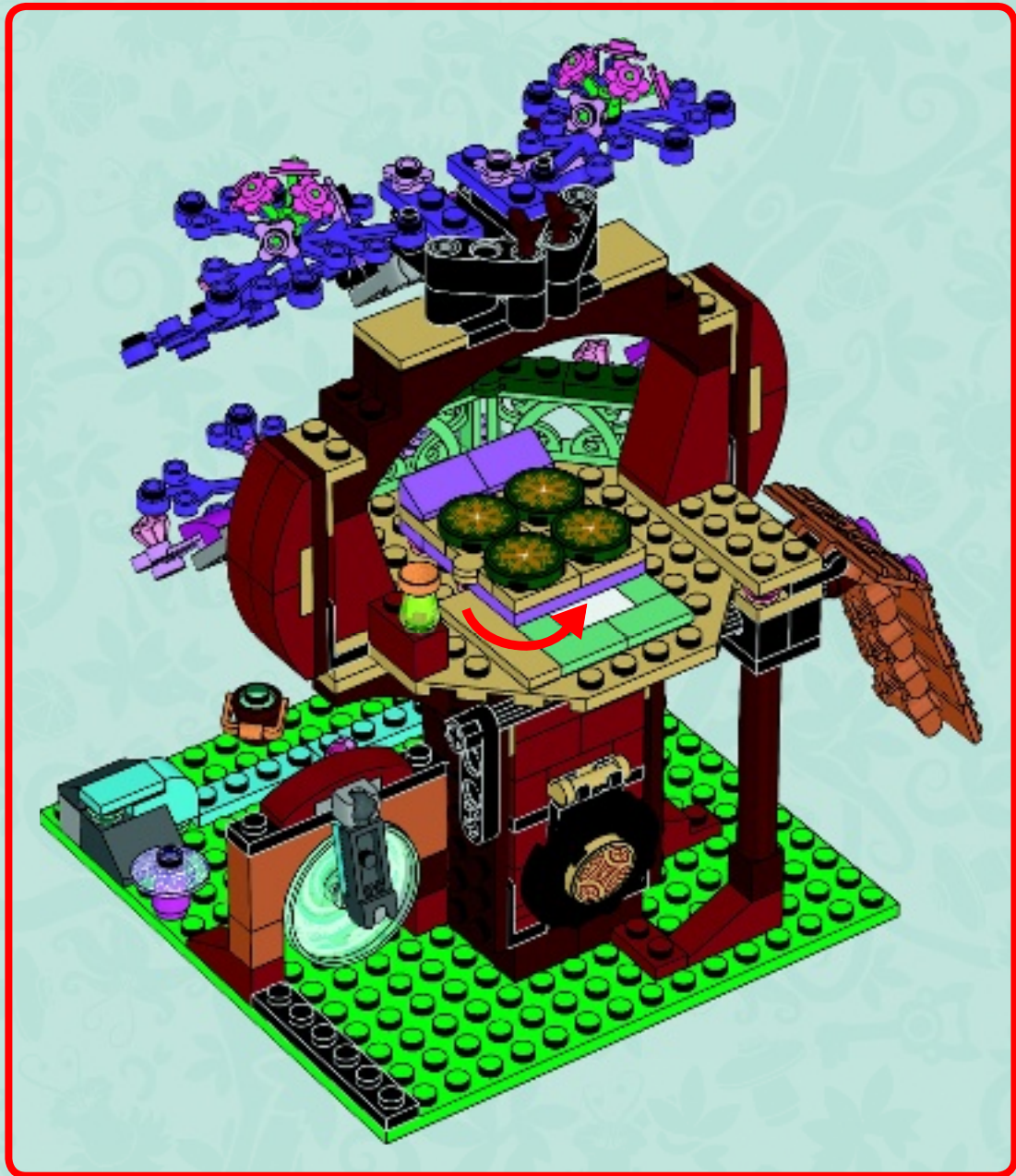

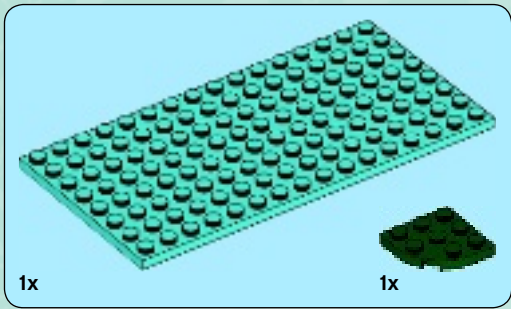

1

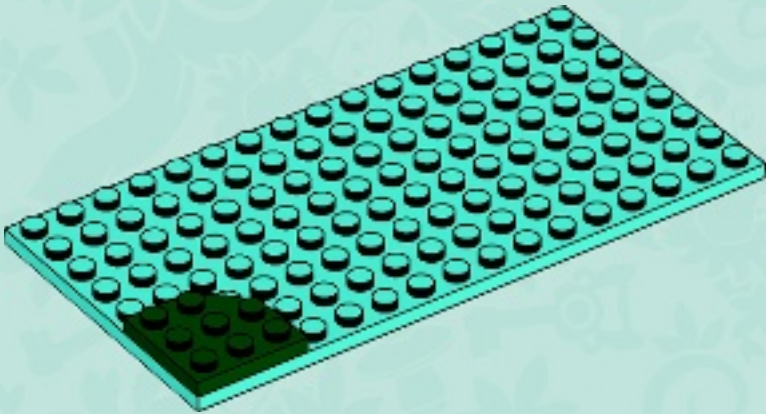

2

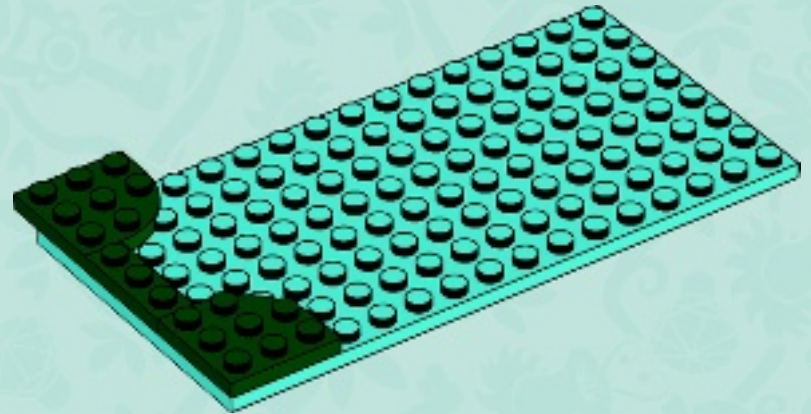

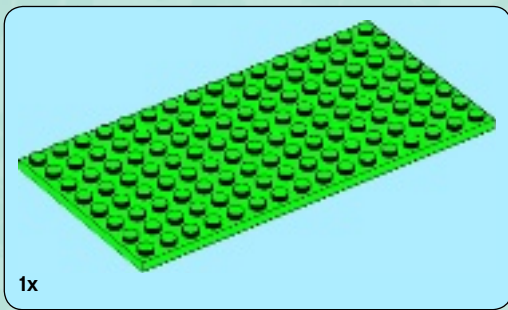

3

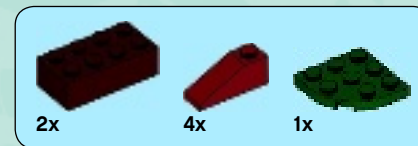
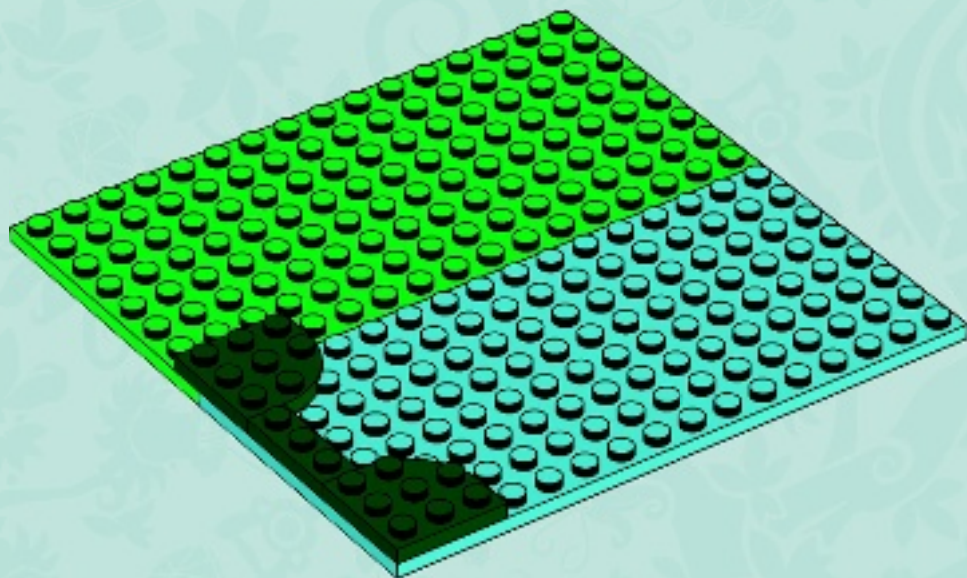

4

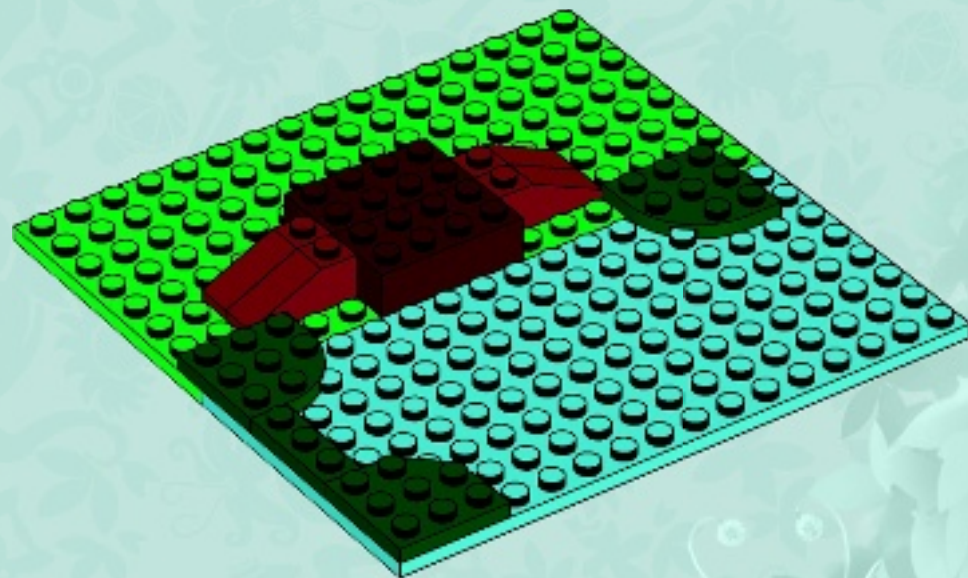

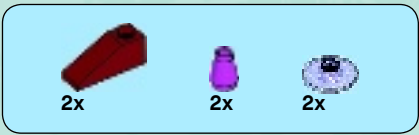

5

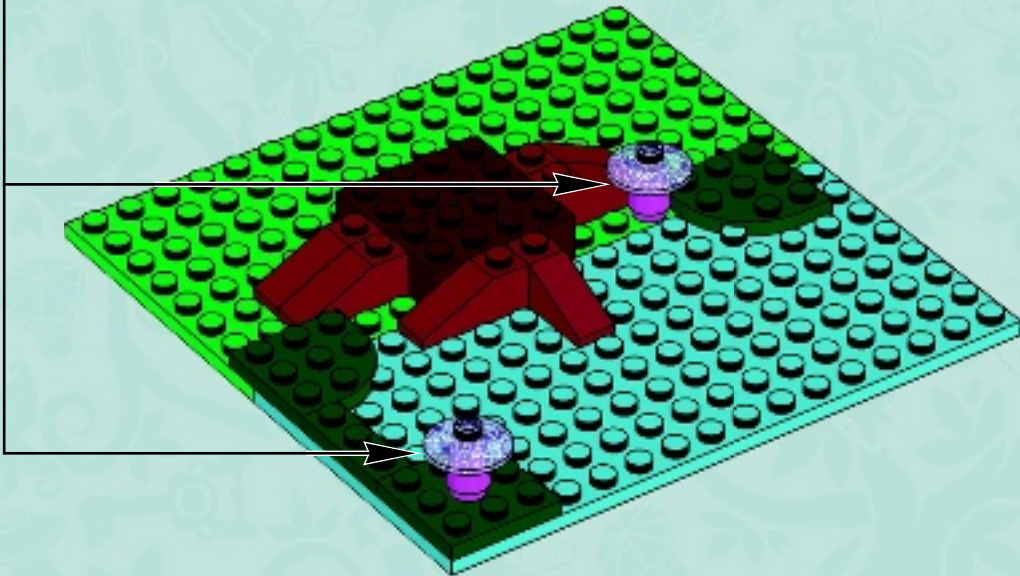

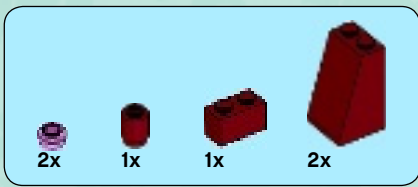

6

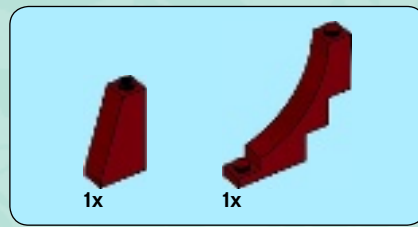
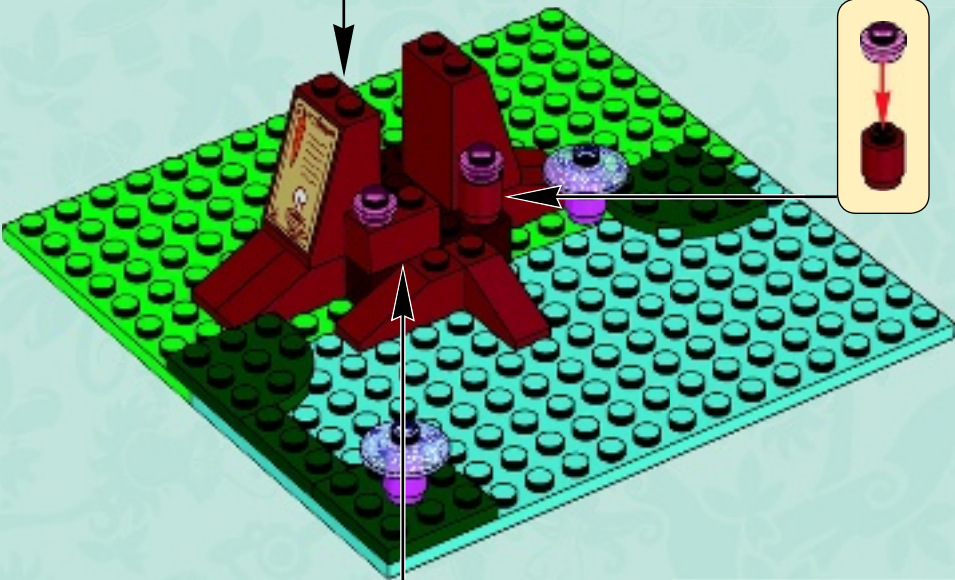

7





8

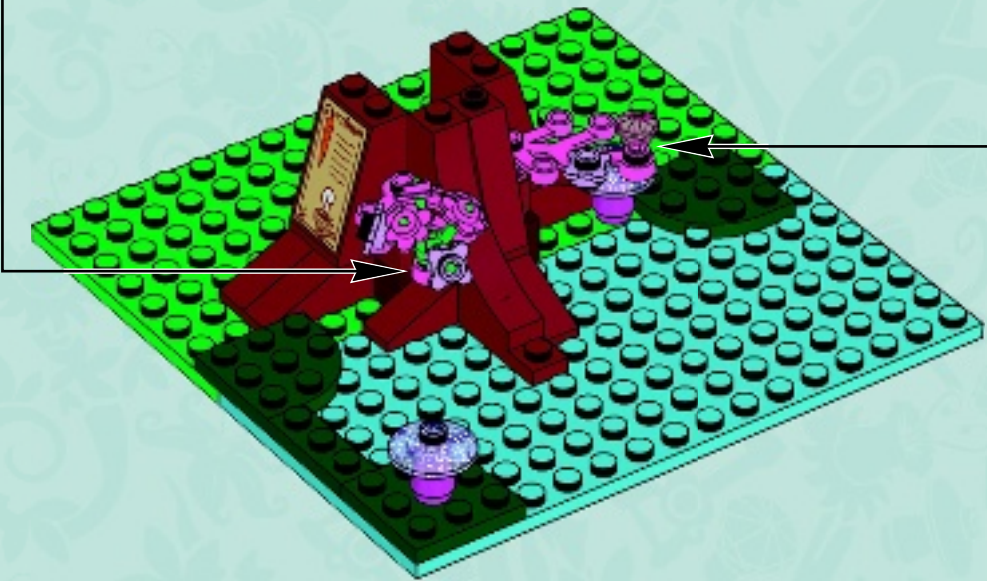
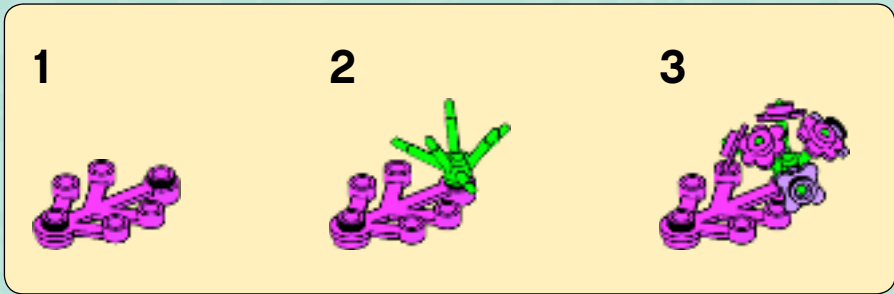



9

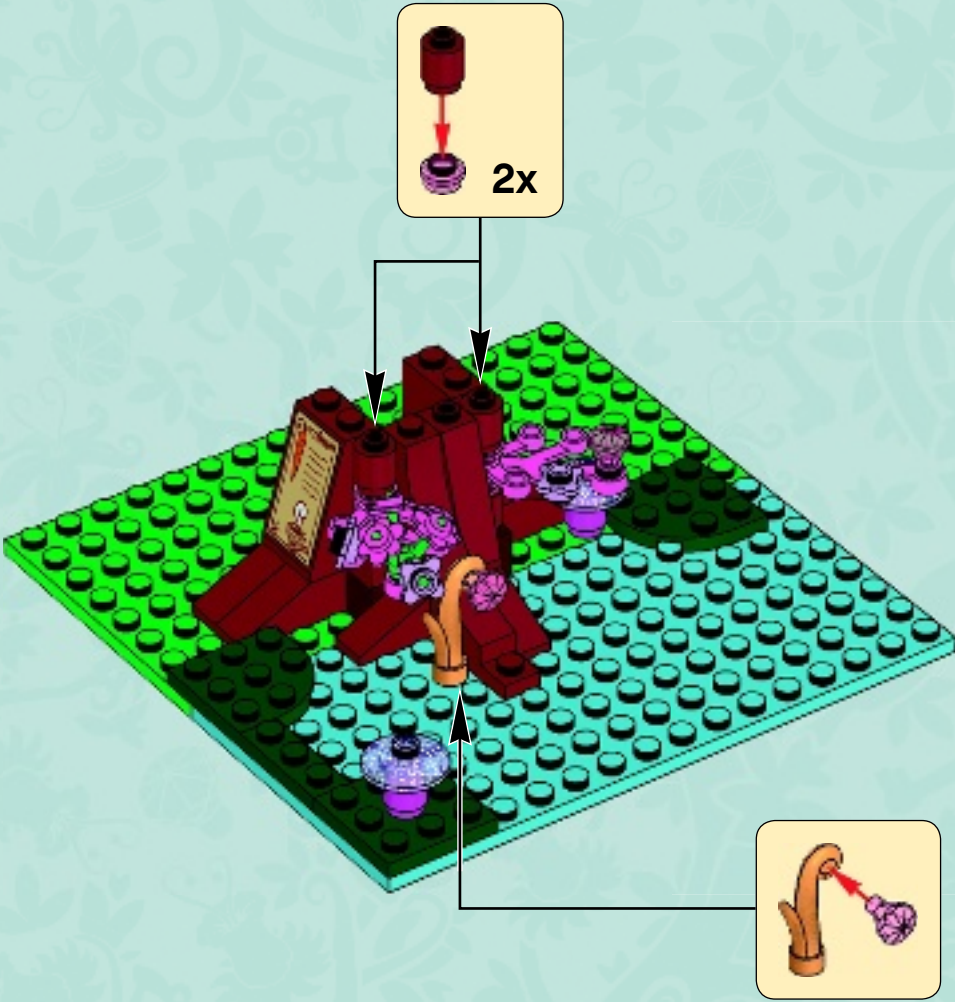

10

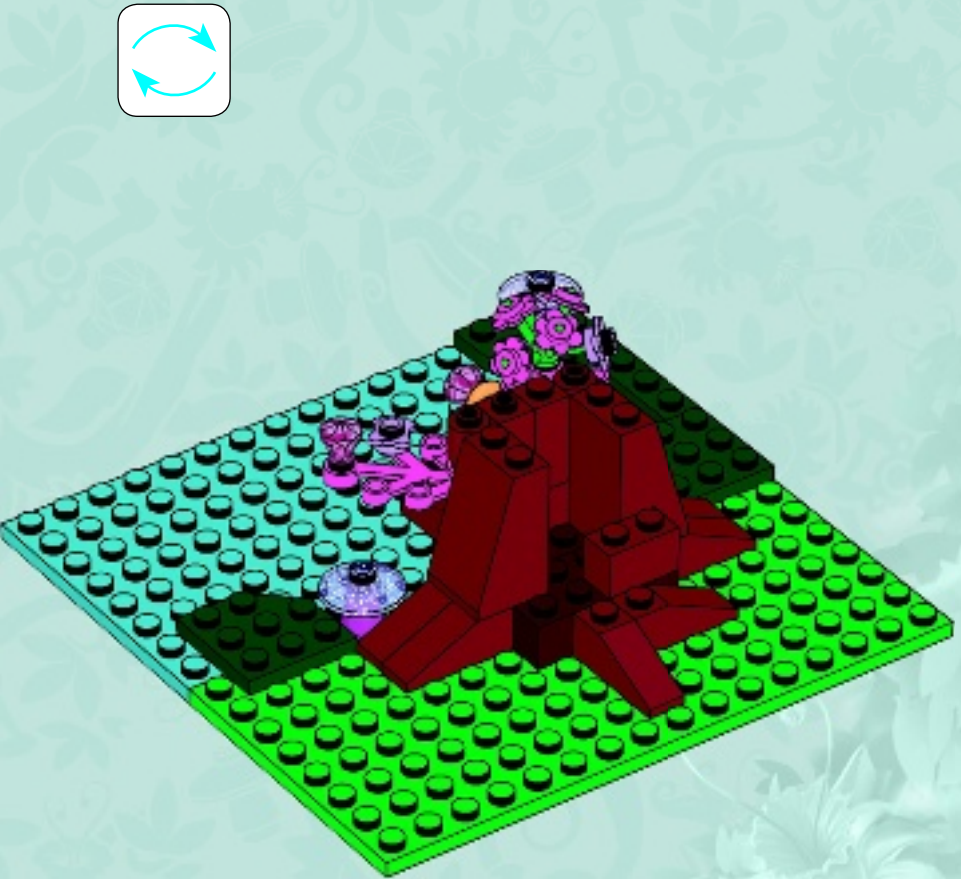

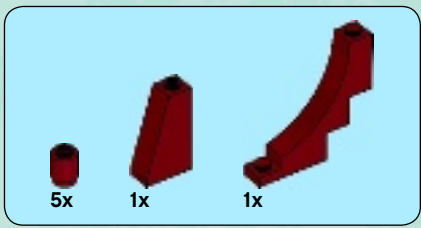

11

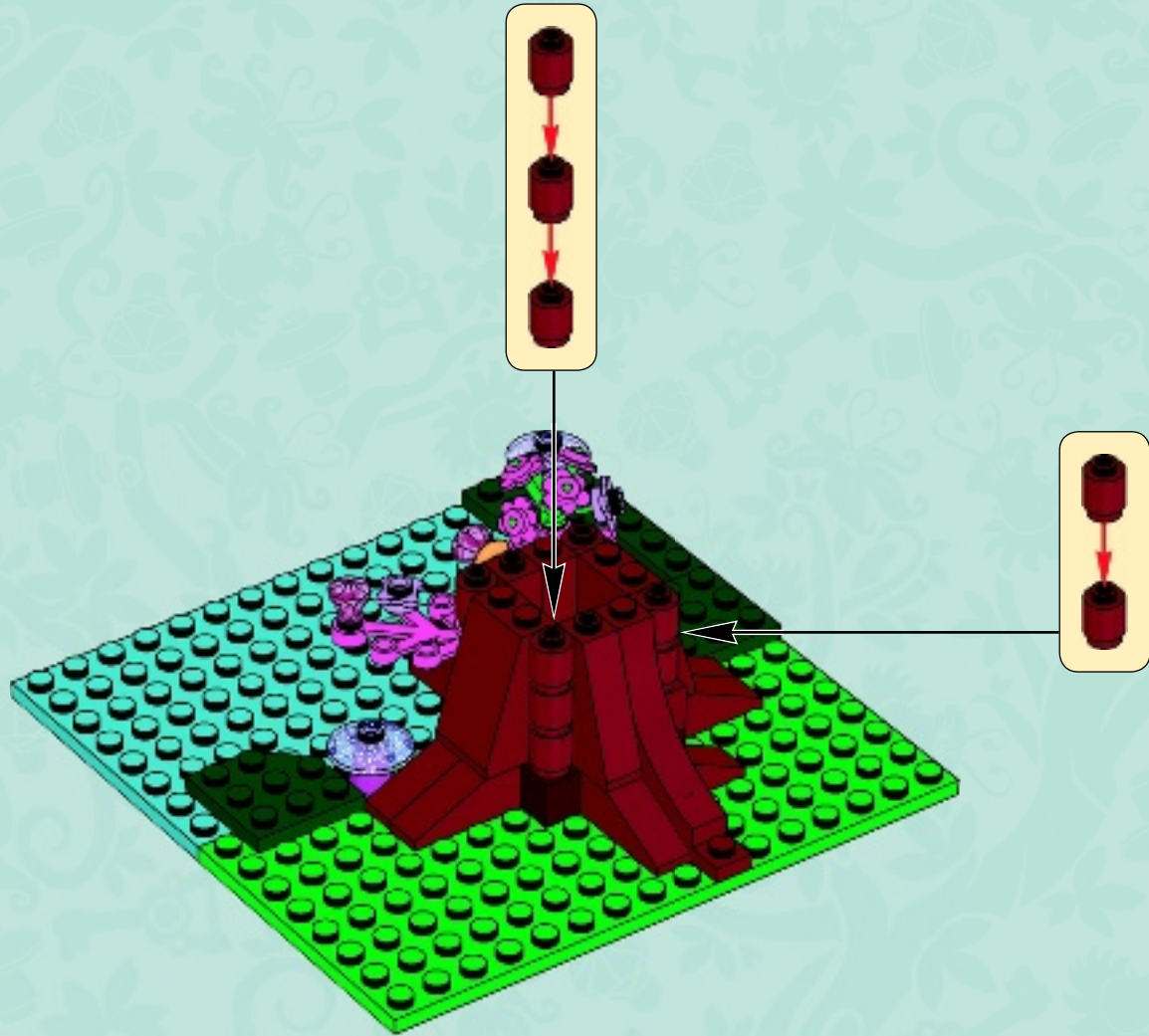



12

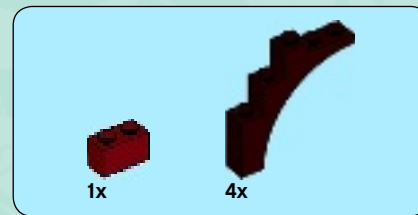

13

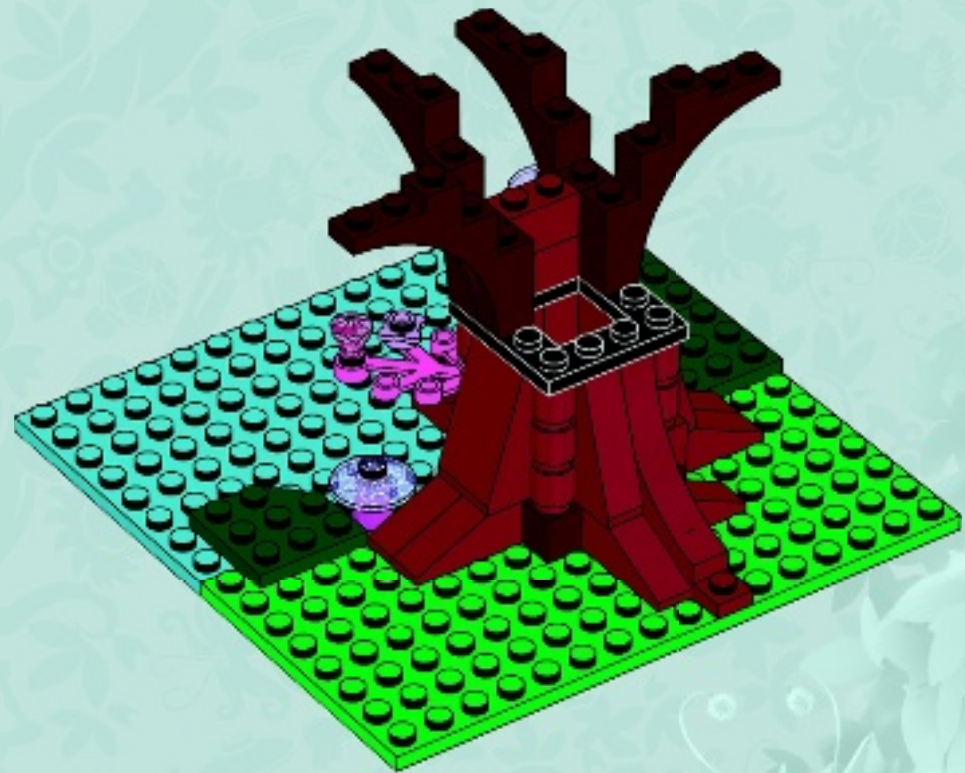



4x

14

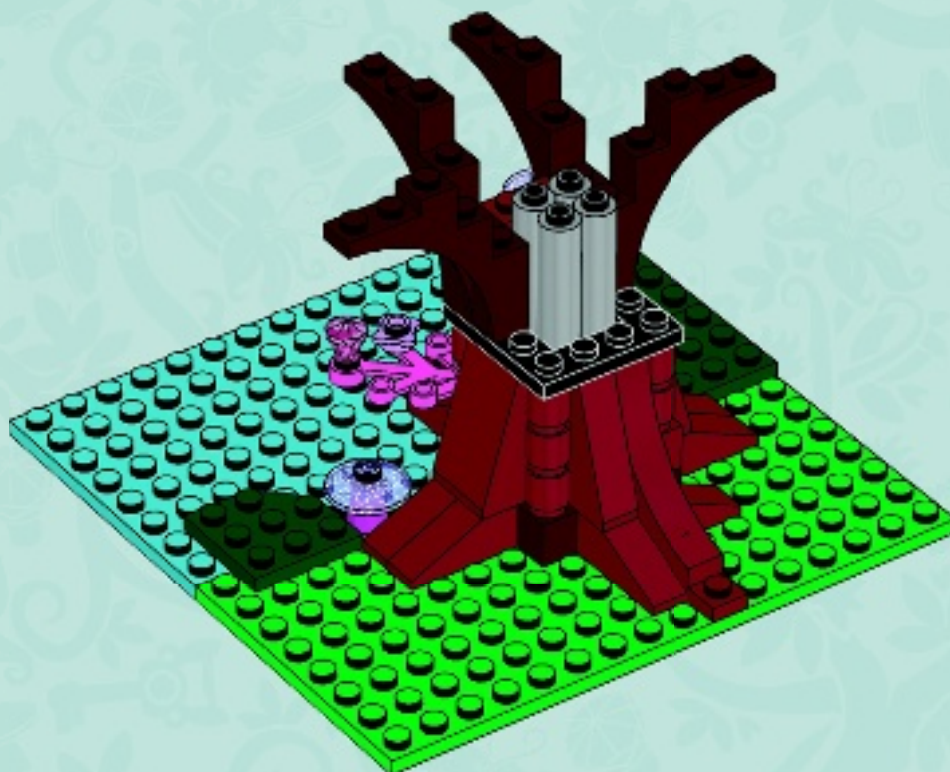



15

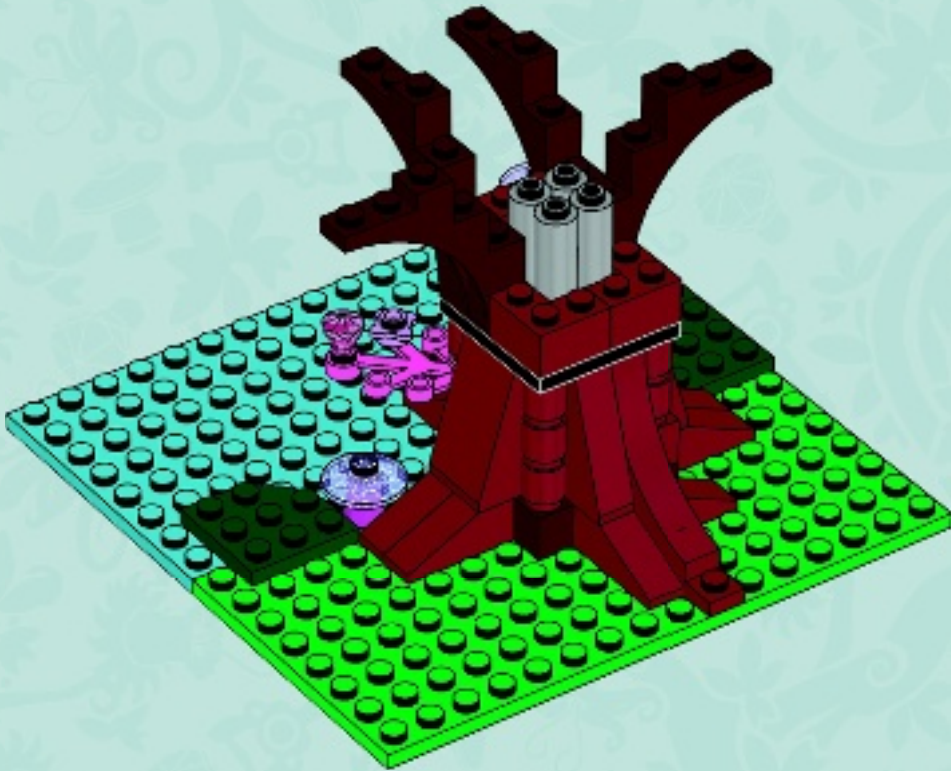

16

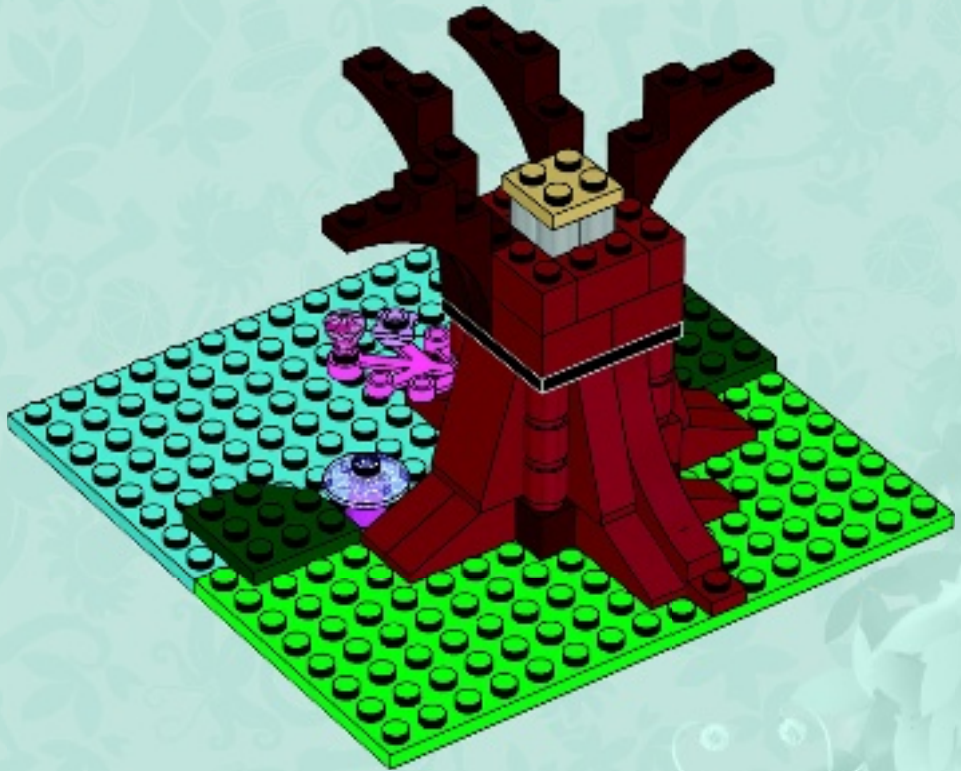



17

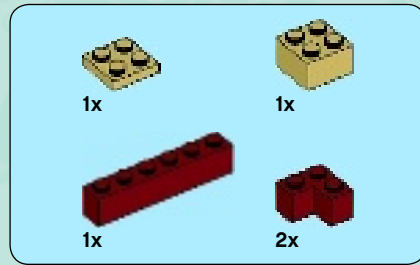
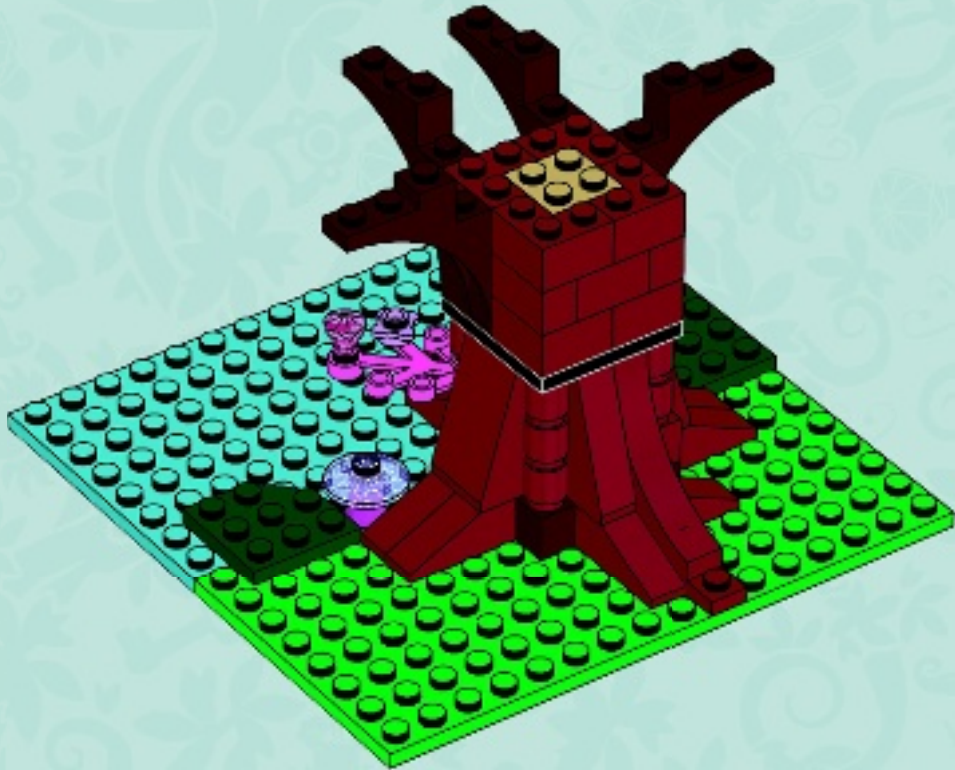

18

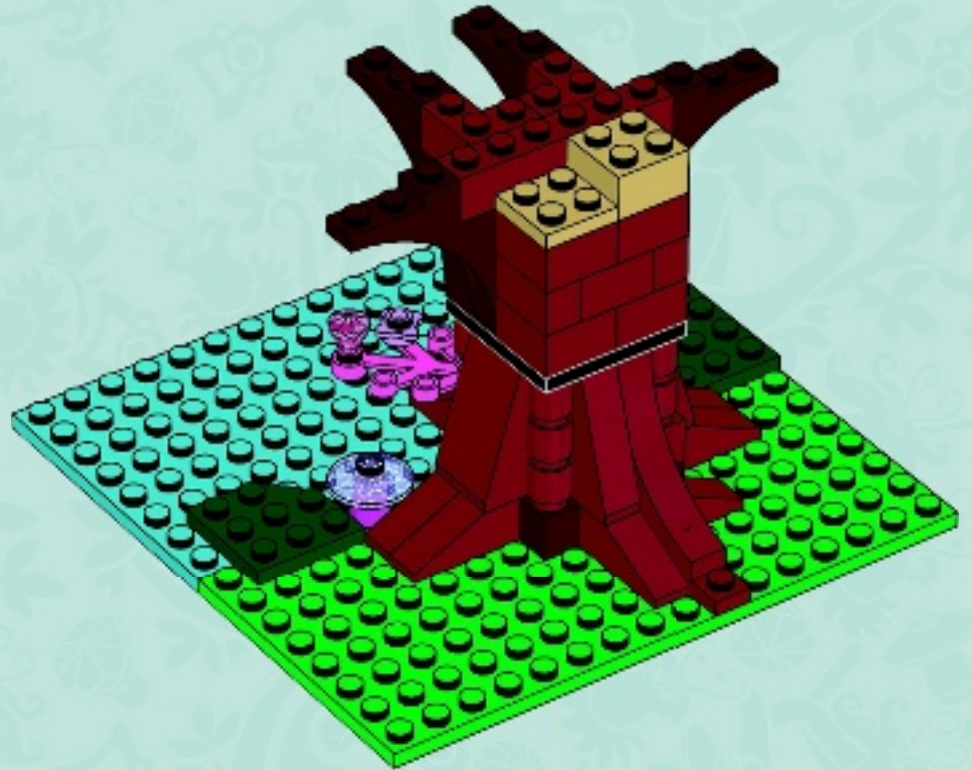

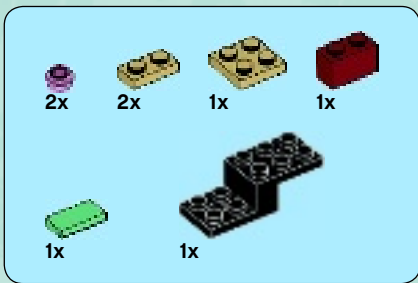

19

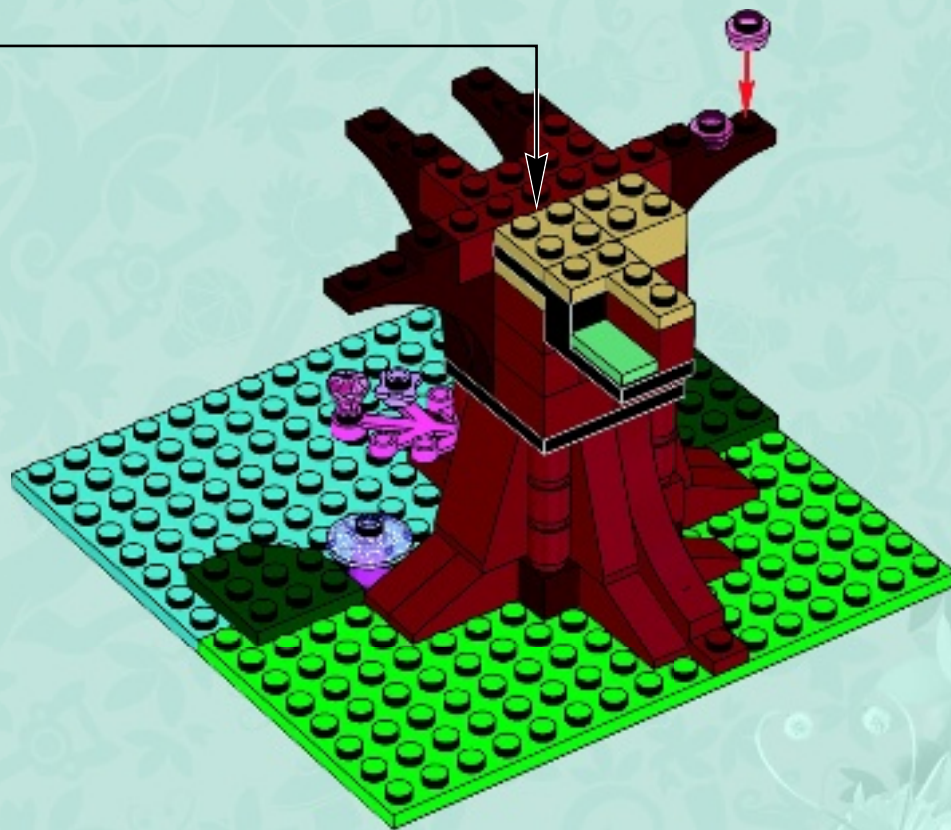
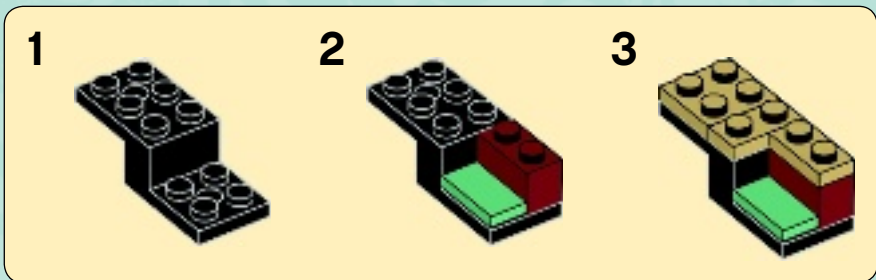



20

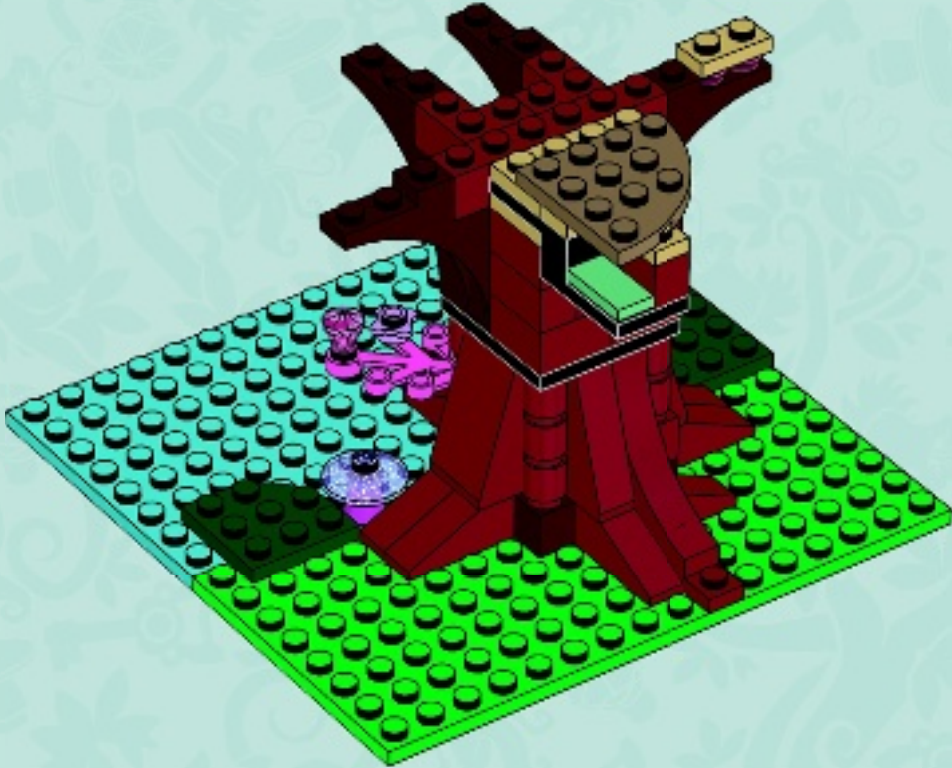

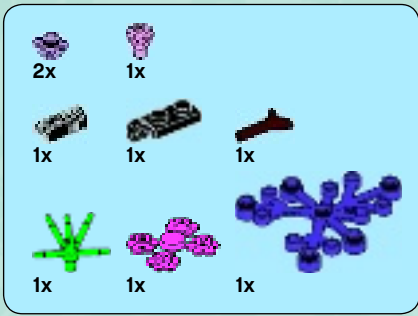

21

1



2



3



4



5

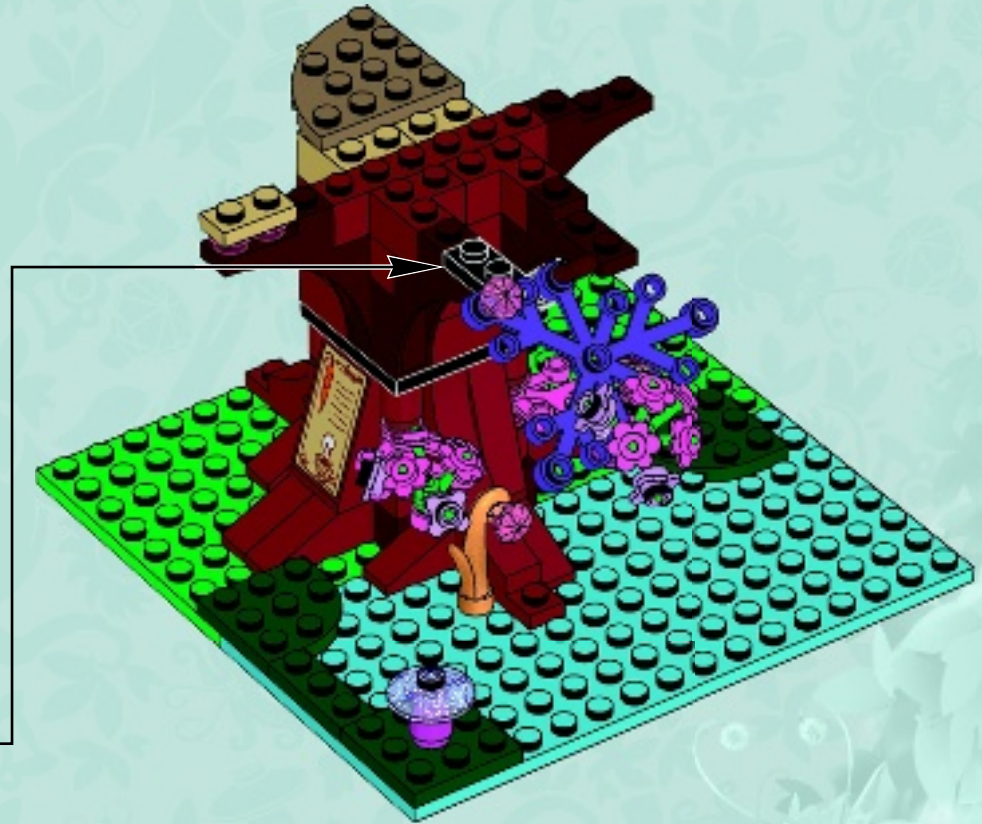
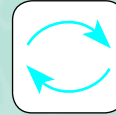

4



1x

1x

1



2x

2x

1x

2



2x

2x

3

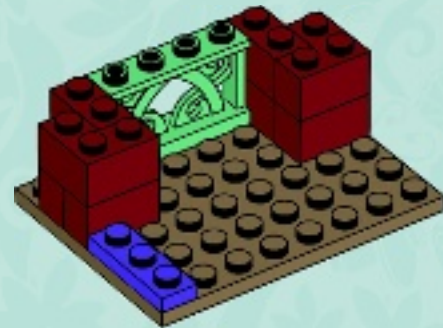

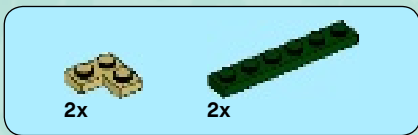

4

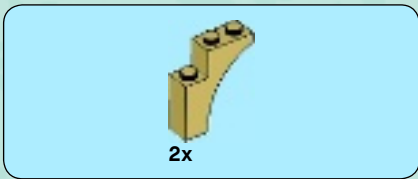
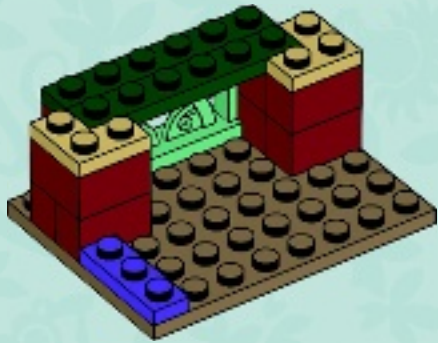

5

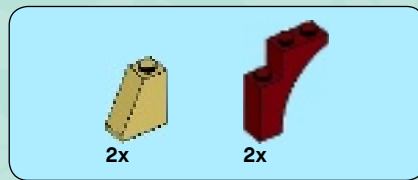
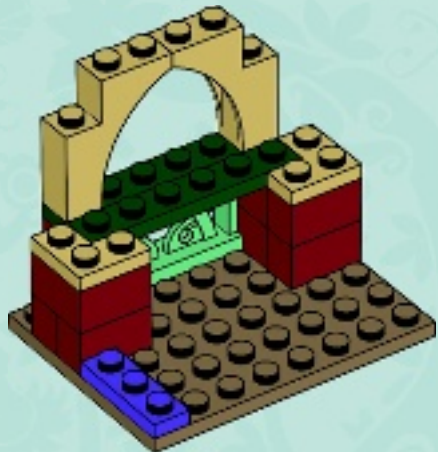

6

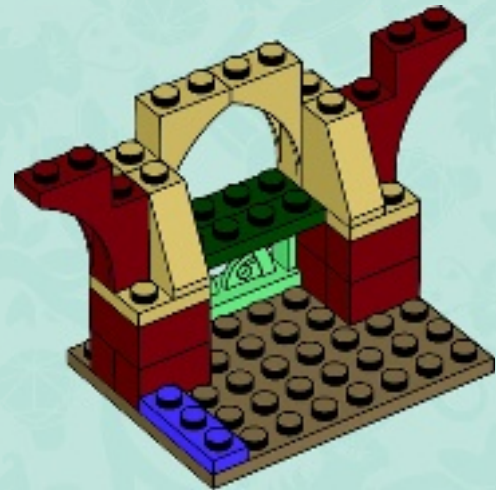



7

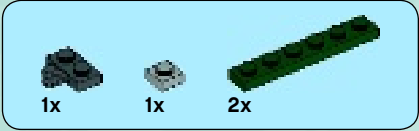

8

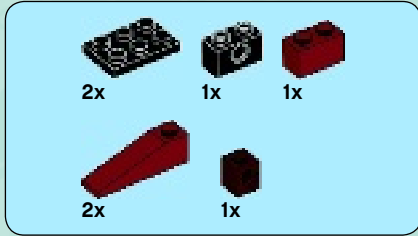
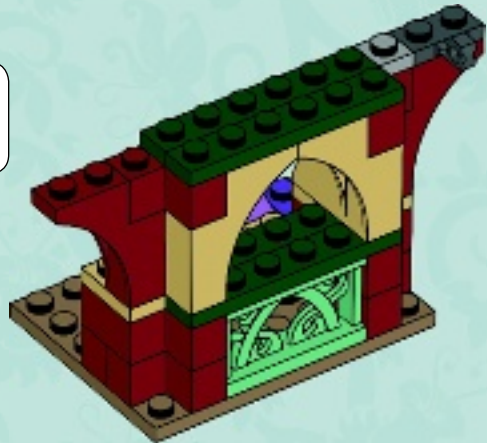

9

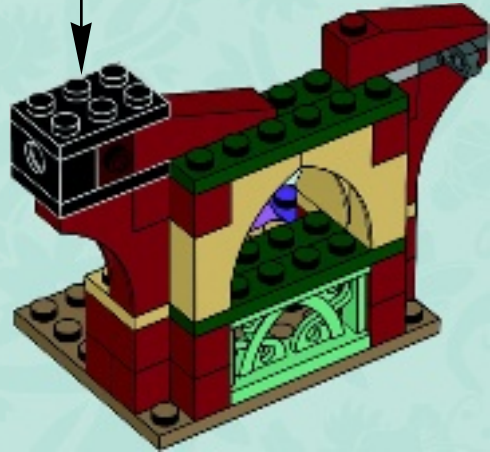
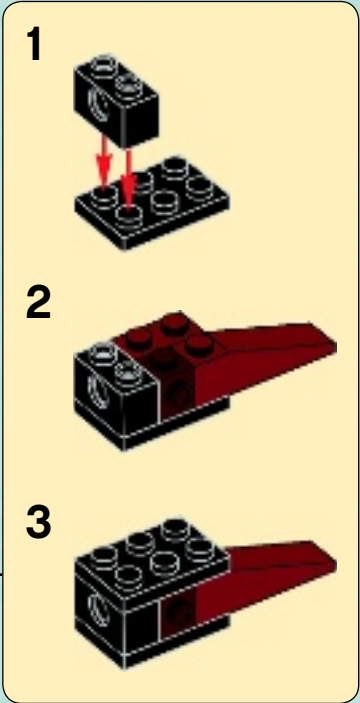



10



11



12

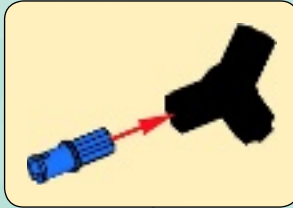

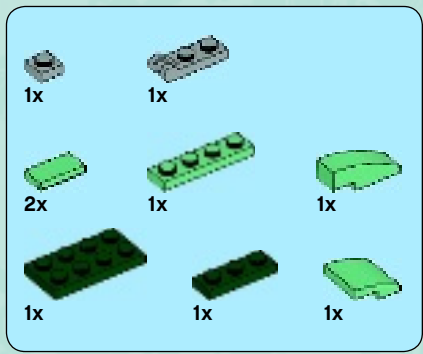

13

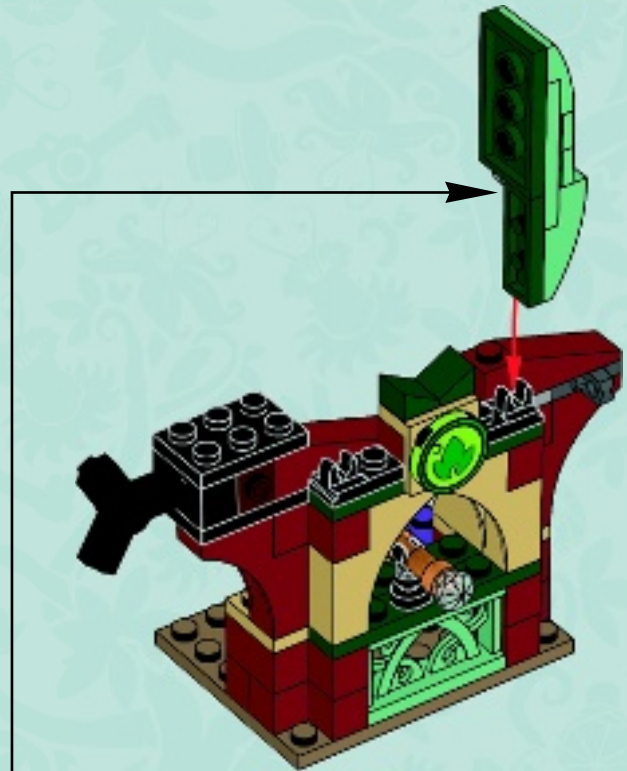
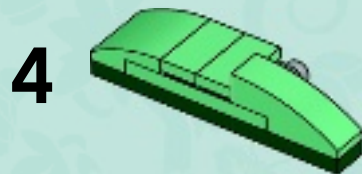
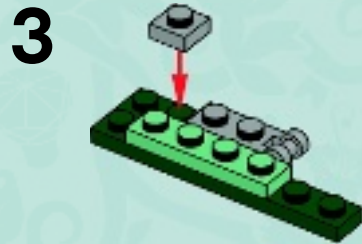
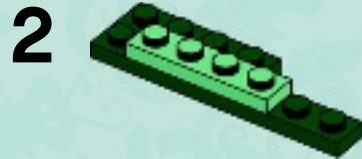
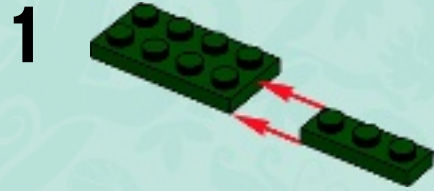

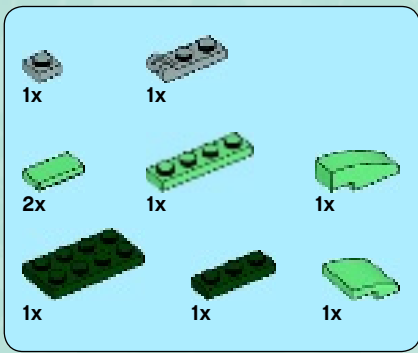

14

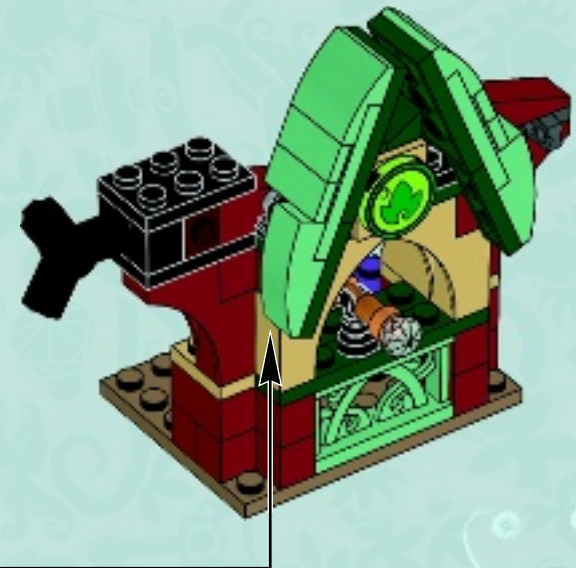
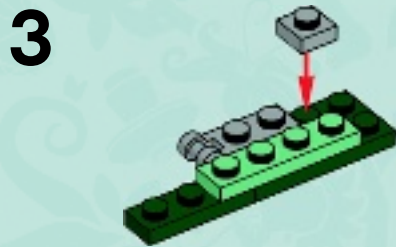
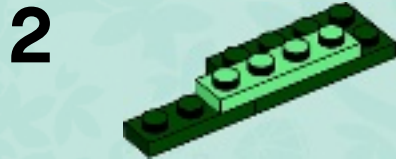
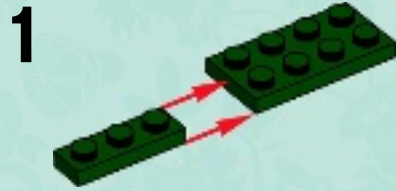

22

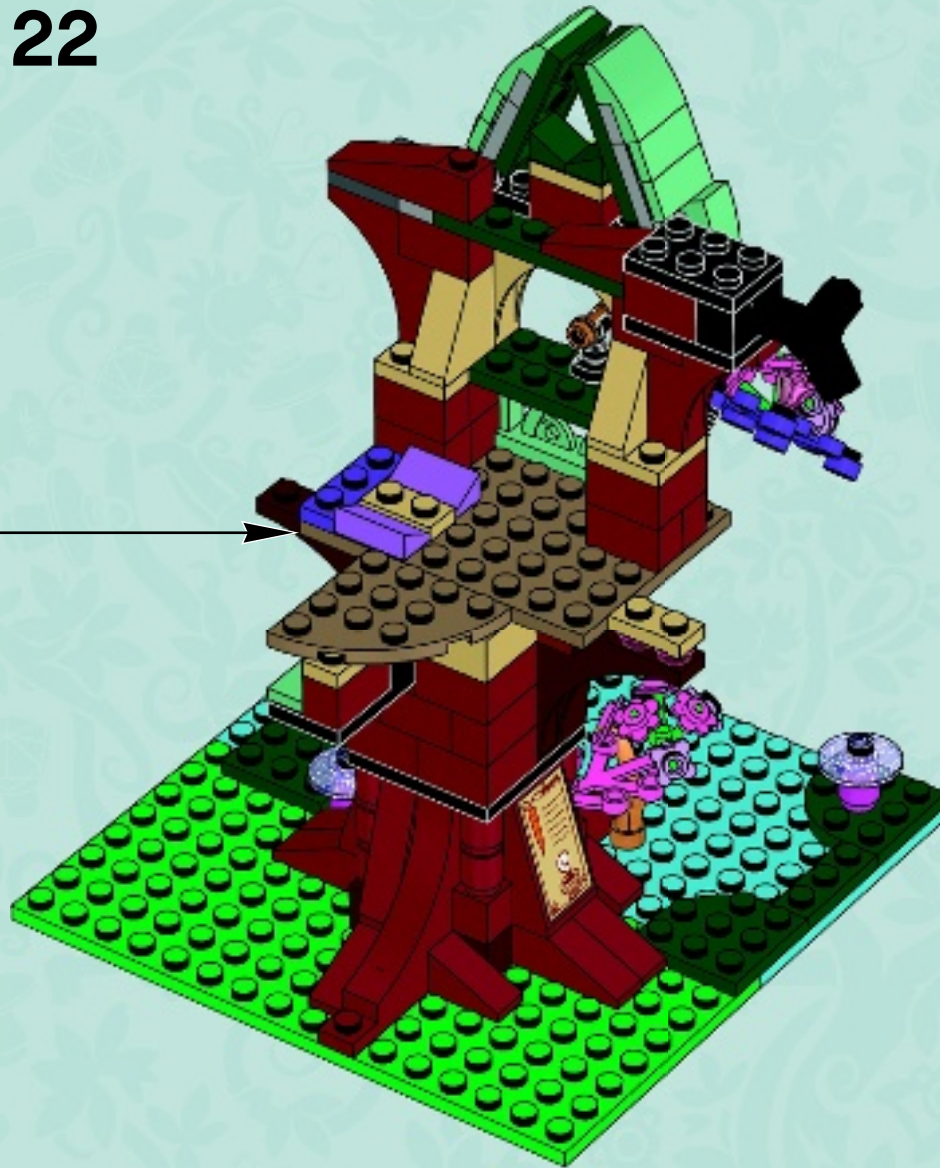
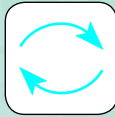



23

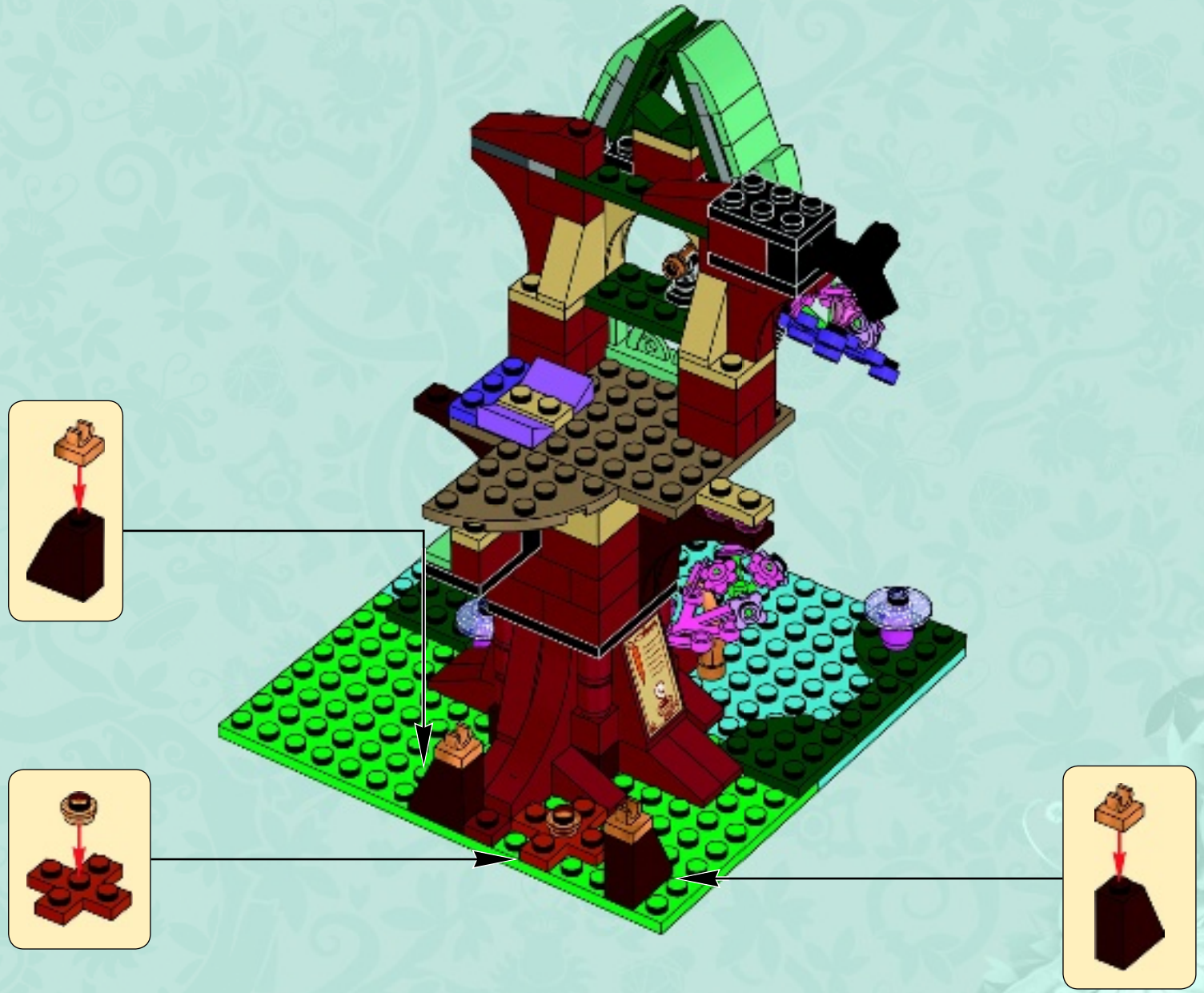

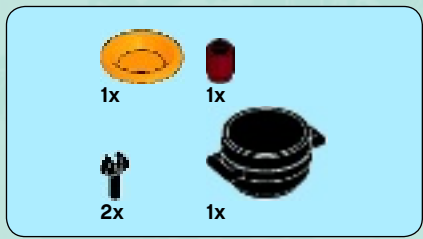

24

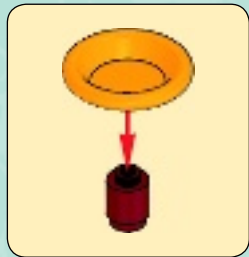
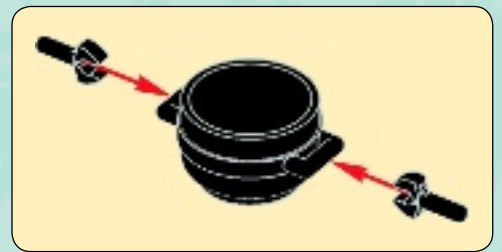

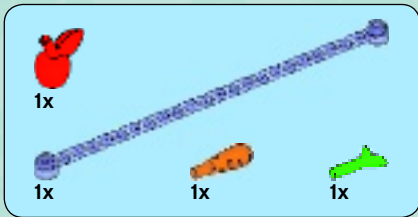

25

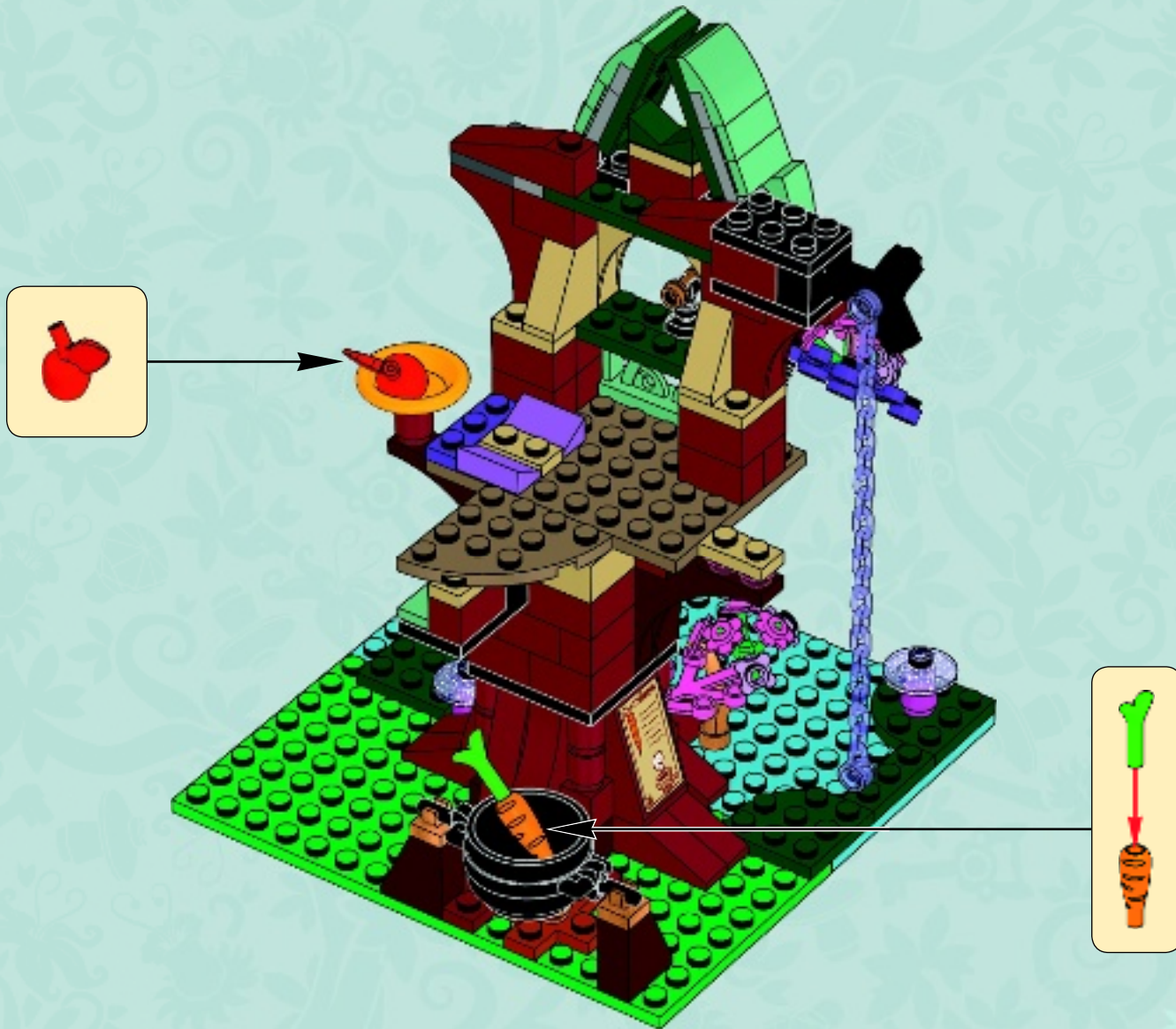



26

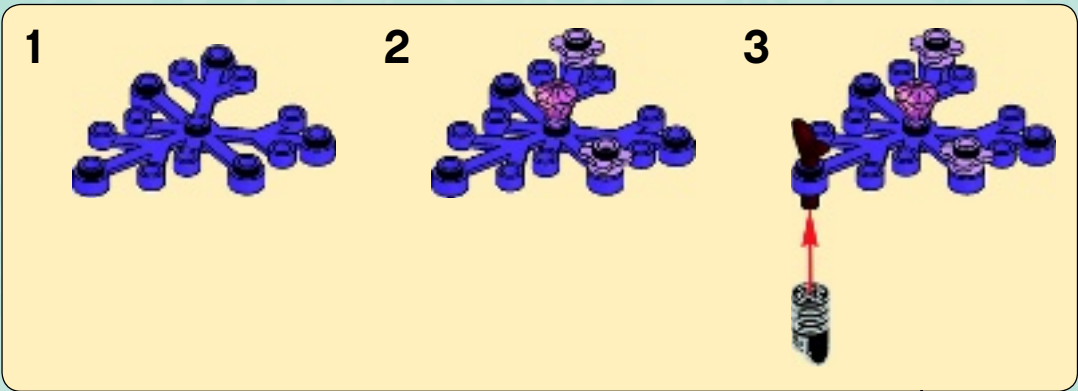

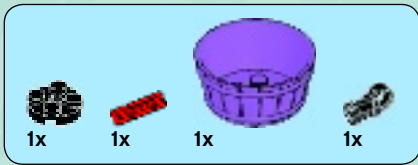

27

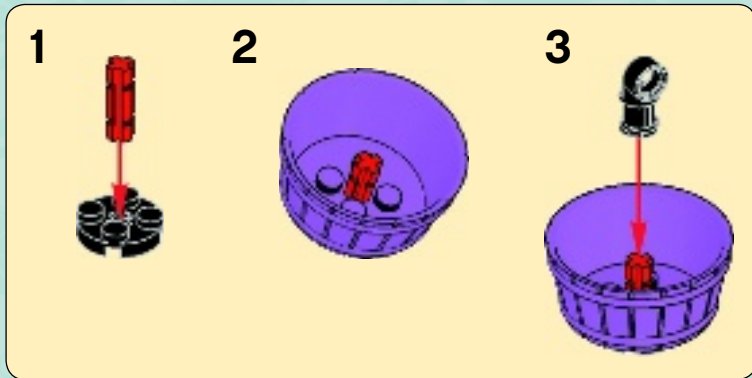

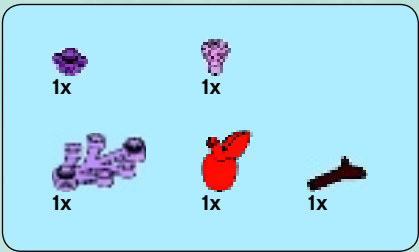

28

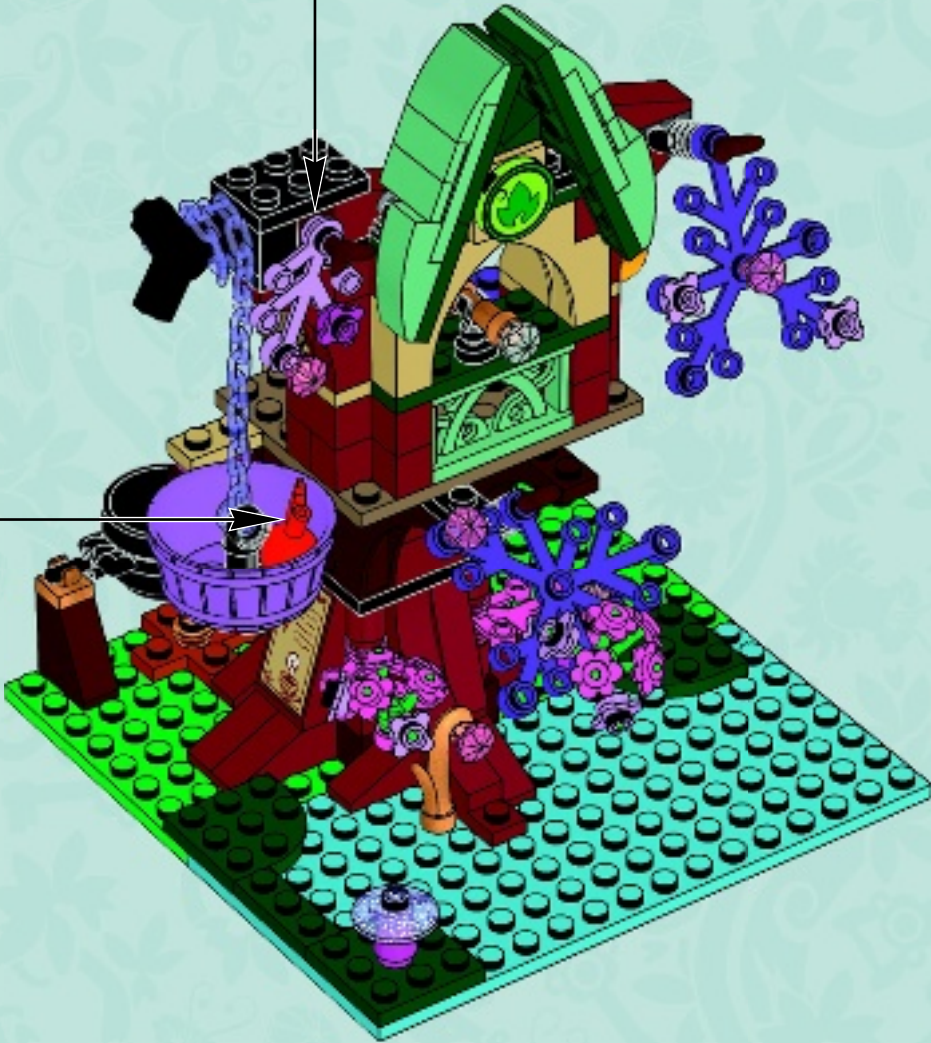
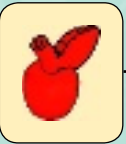
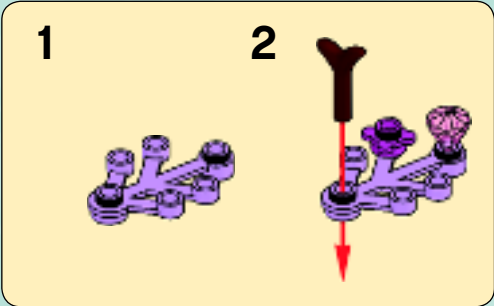

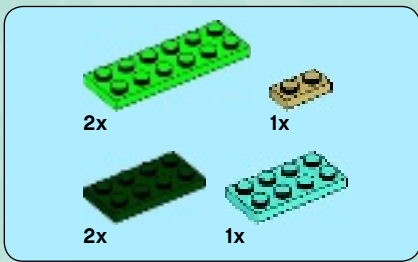

29



53

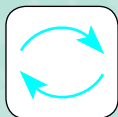

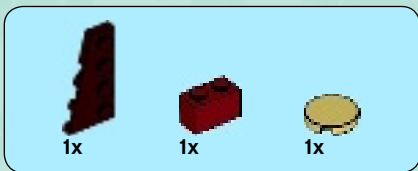

54

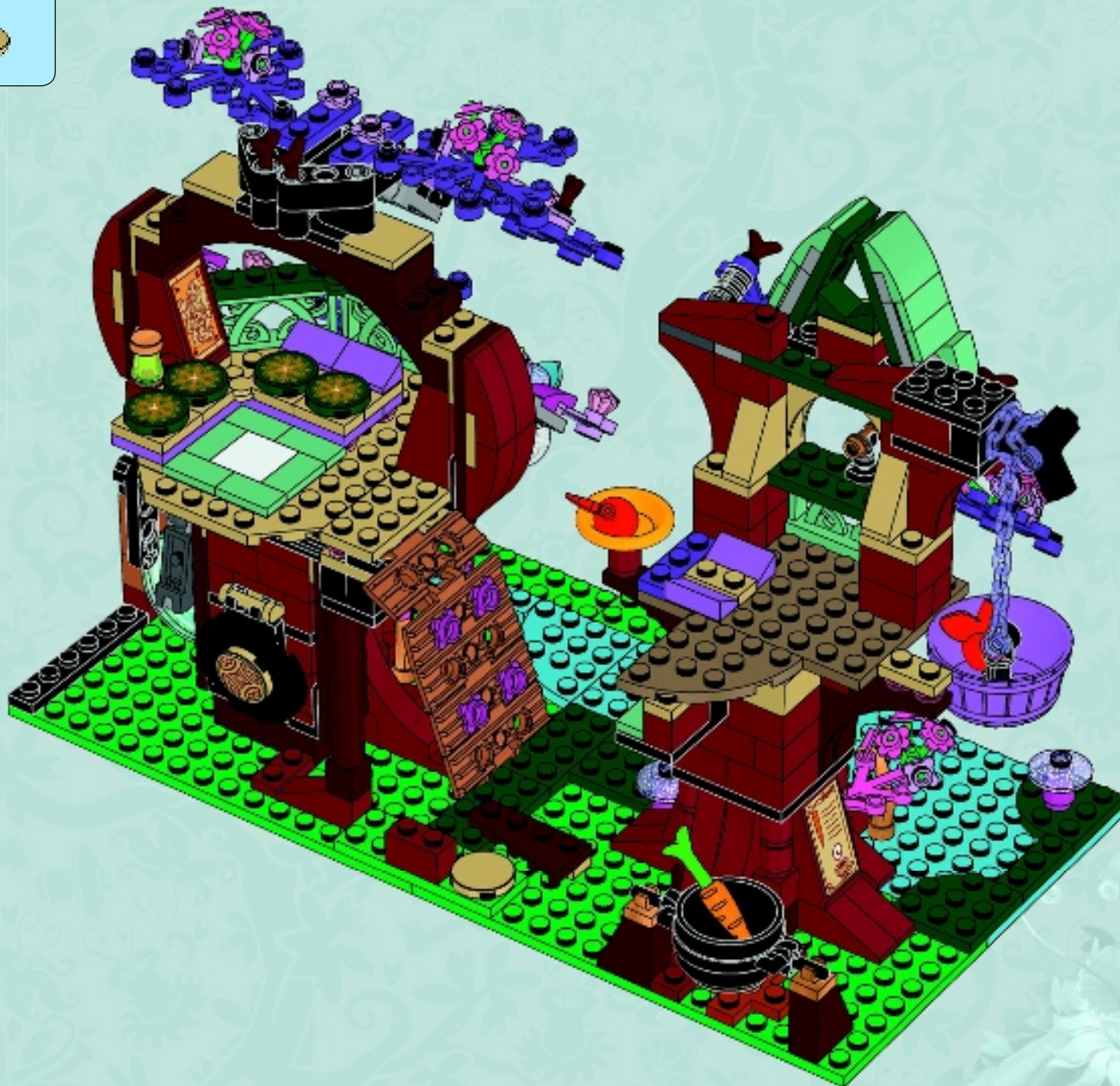
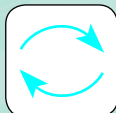

2x  1x 

55

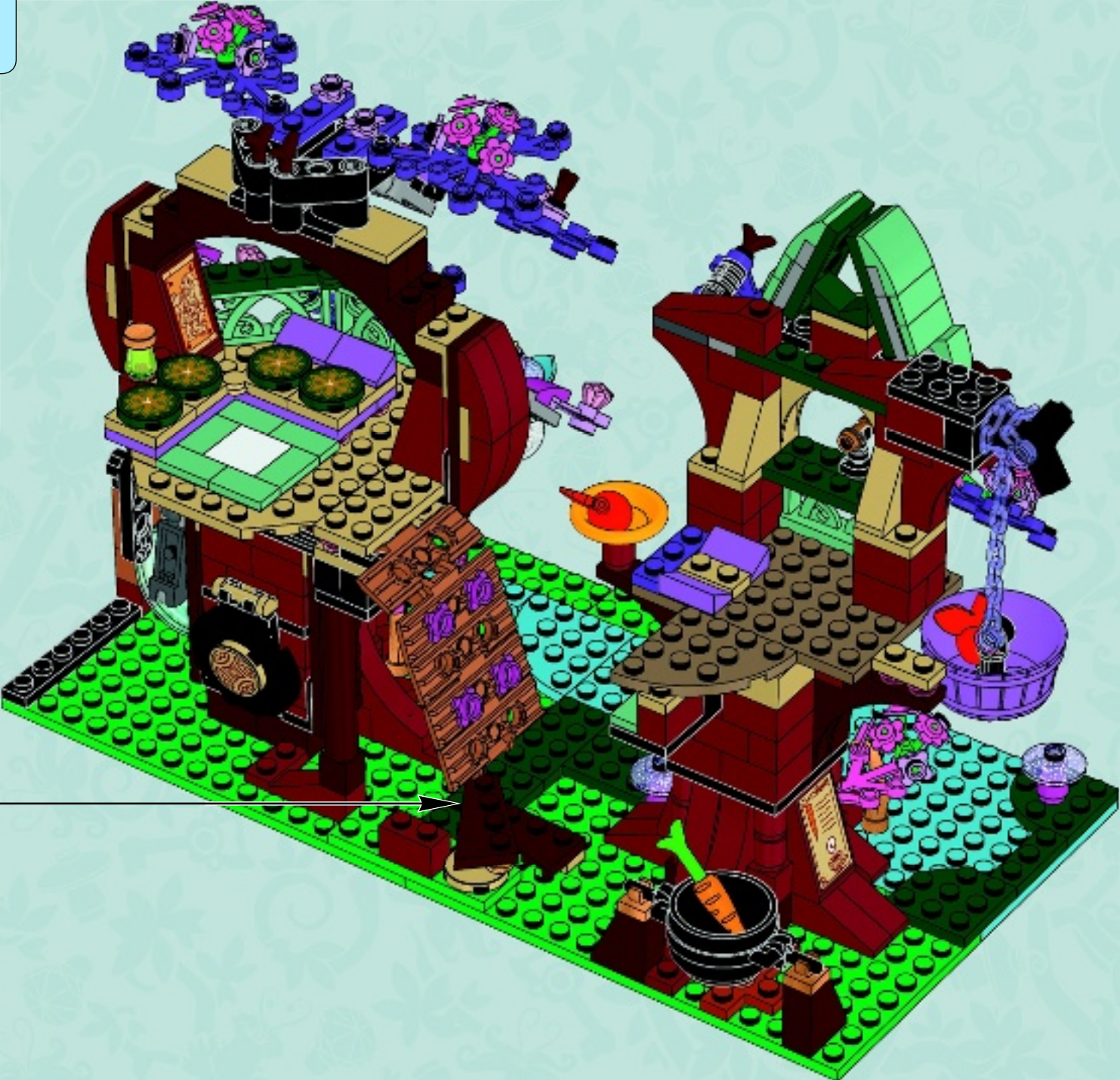



56

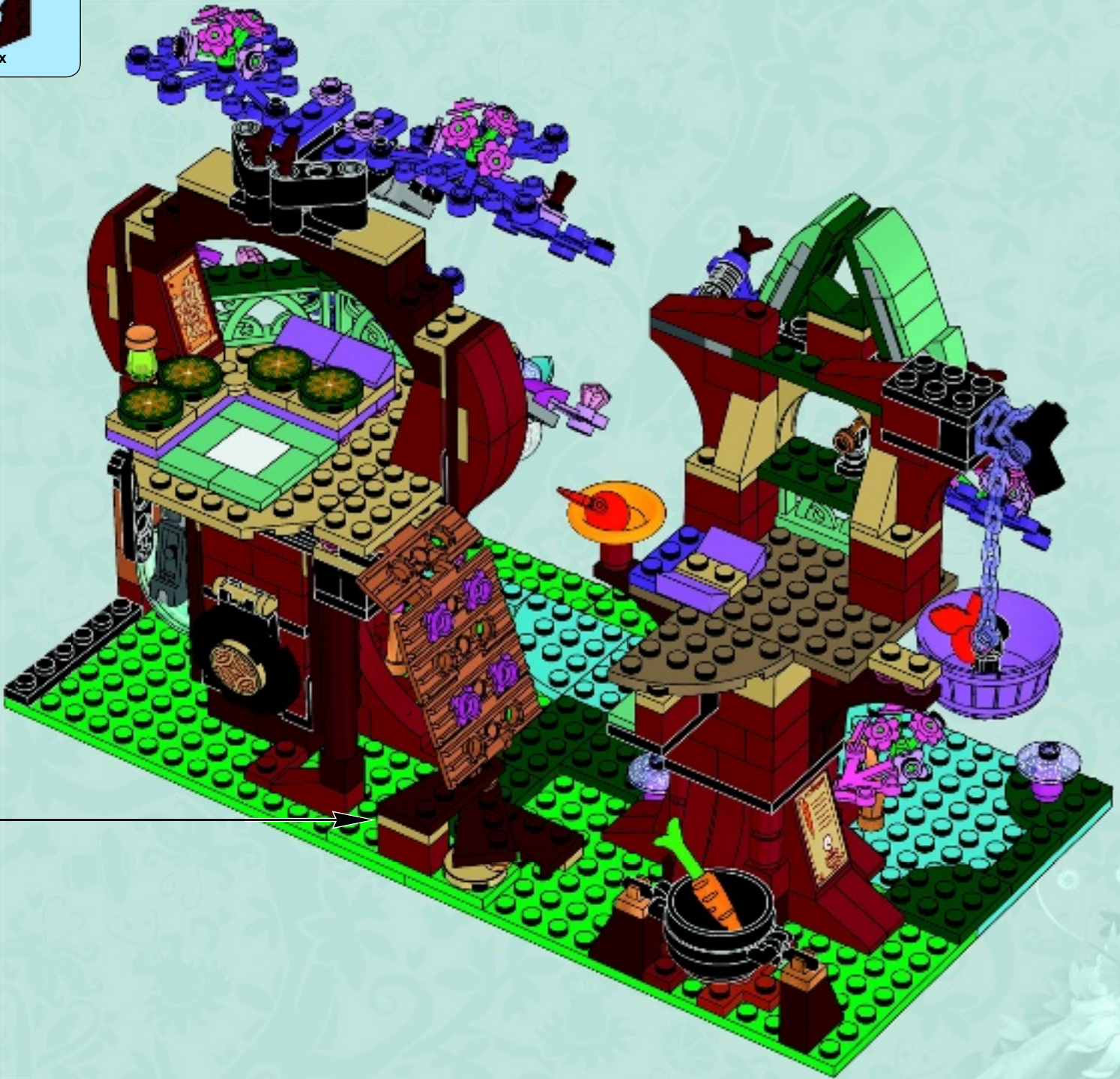

1x  3x 

57

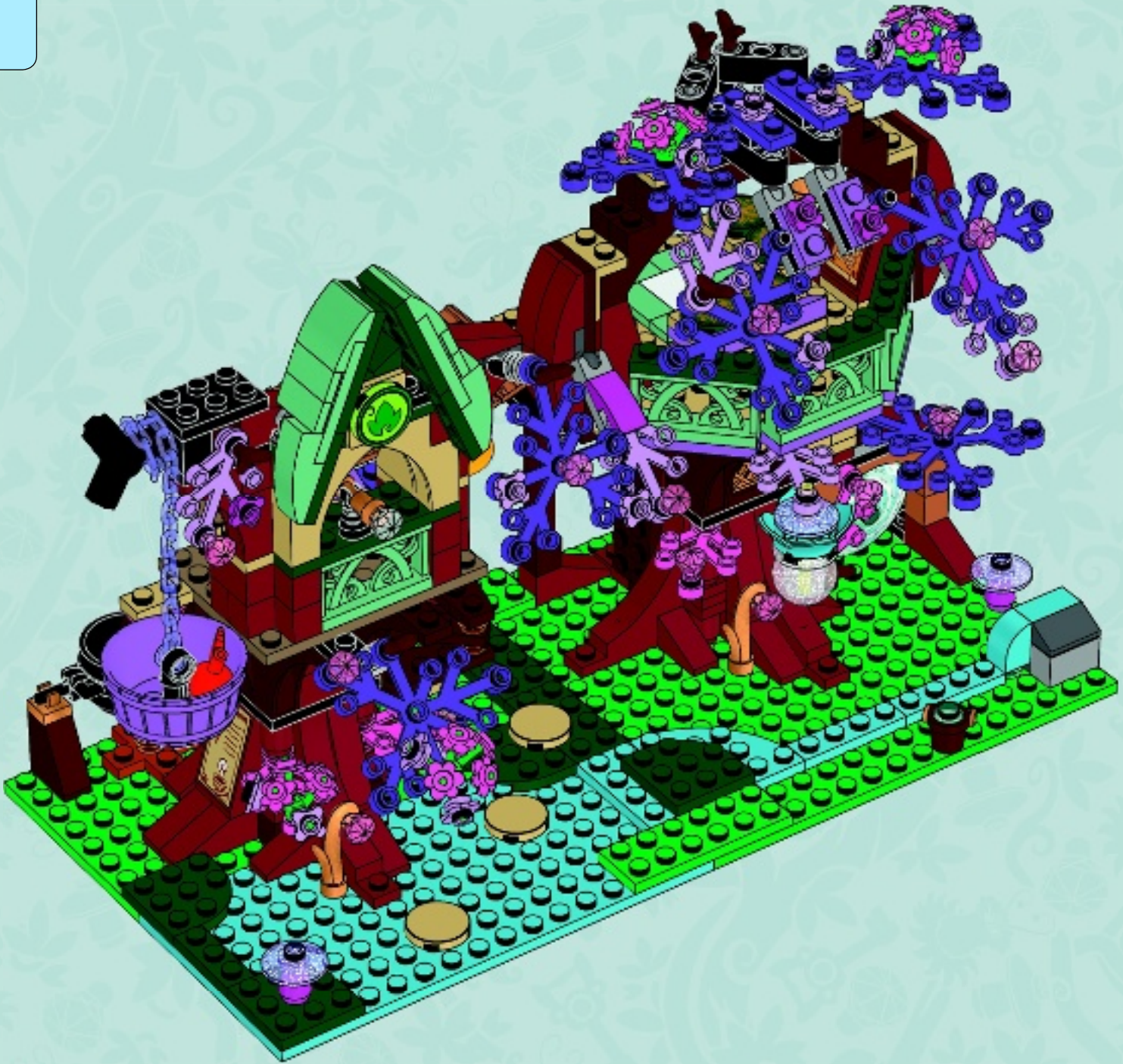



 3x 614301	 1x 4113993	 1x 302026	 2x 4142822	 1x 6062215	 1x 6107429	 4x 6092771
 1x 306801	 1x 4114324	 1x 366626	 2x 4120017	 1x 4248937	 1x 6097525	 4x 6001836
 1x 4119410	 5x 6117975	 1x 6058118	 1x 4143466	 1x 4646864	 4x 6093752	 1x 6103241
 1x 4114306	 1x 4217562	 1x 447726	 1x 4143466	 5x 4163917	 1x 6097525	 2x 6102779
 1x 4624086	 5x 6066344	 2x 4598528	 1x 4107136	 1x 6110077	 1x 6109383	 2x 6080431
 2x 4626200	 1x 6102772	 4x 4569733	 1x 4107136	 1x 4124054	 1x 6106043	 2x 6100237
 1x 4114322	 2x 6054438	 4x 6000650	 1x 4660886	 1x 6103249	 1x 6102301	 11x 4616578
 2x 6058093	 1x 4142865	 1x 4225201	 1x 370826	 1x 4654448	 1x 4251796	 4x 6097680
 12x 4113917	 4x 4143005	 2x 4535739	 2x 379528	 1x 6093747	 1x 4570451	 24x 4539102
 7x 4114084	 1x 4206482	 1x 4183043	 1x 6097232	 14x 4599535	 2x 4504375	 16x 4541379
 2x 4185177	 2x 6039194	 2x 4258354	 4x 6097232	 13x 4129917	 2x 6013102	 6x 6052777
 4x 4114077	 3x 370026	 1x 403226	 1x 4119479	 1x 6104413	 3x 6013975	 1x 4541528
 3x 4550324	 2x 302126	 1x 6038453	 2x 4289538	 7x 6078932	 4x 4586057	 11x 4539099
 3x 4114309	 1x 371026	 1x 4525078	 2x 4143372	 3x 6003007	 4x 4245566	 2x 4590811



Customer Service
Kundenservice
Service Consommateurs
Servicio Al Consumidor
LEGO.com/service or dial





ELVES

the land of
Elvendale
completing the quest

Desertlands



The great mountain of Silad

Sparkle Rock

Leaflands

The Izdur Ocean

Blue Water Bay

Windy Beach

Leaf High Hill

Island

 LEGO.com/elves