



CITY

30355



6201595



1

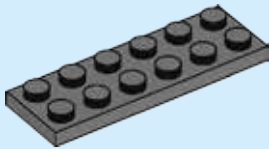

2



3

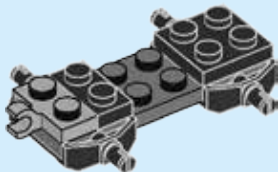

4

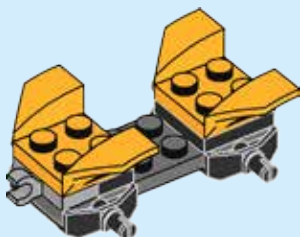

5

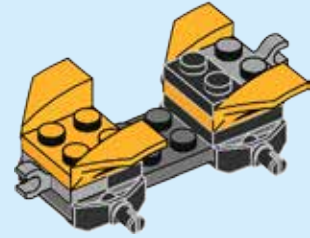

6

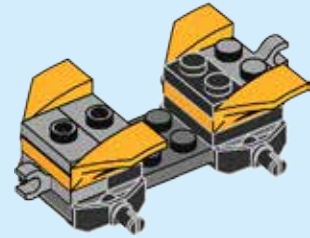

7

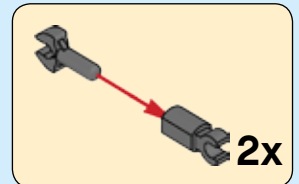

8

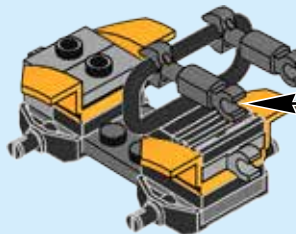

9

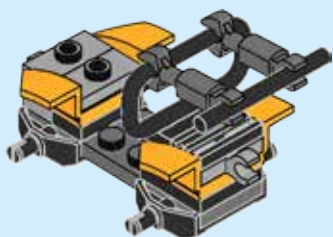

10

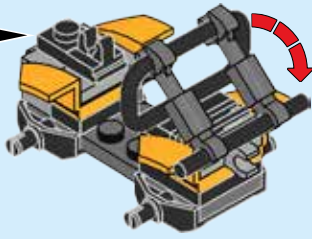
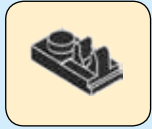

12

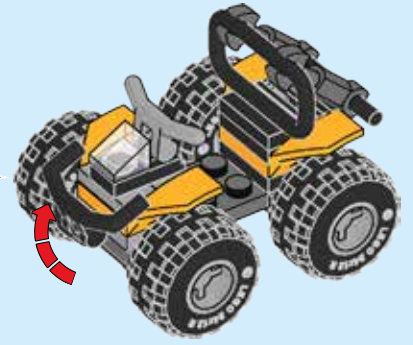
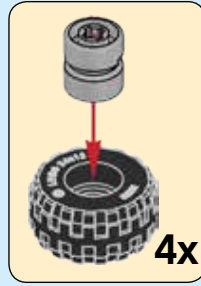

11

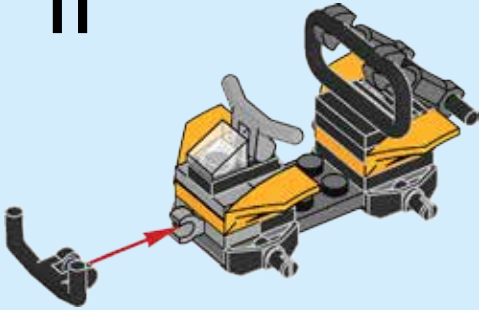

13



LEGO.com/city

LEGO and the LEGO logo are trademarks of the LEGO Group.
©2017 The LEGO Group. 6201595

LEGO CITY



60160



60161



60159

LEGO.com/city