

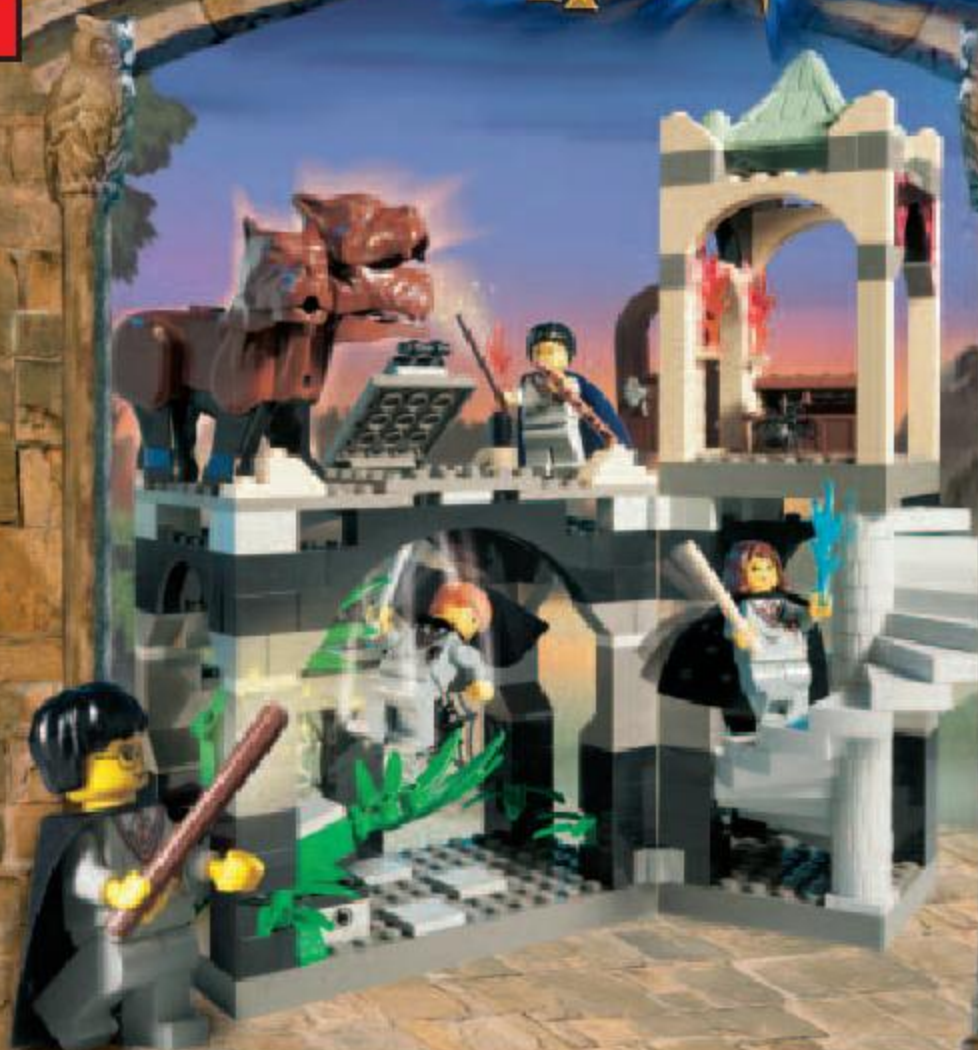

Harry Potter™



4706



1



2

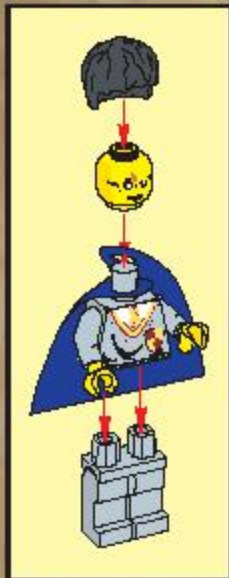

1

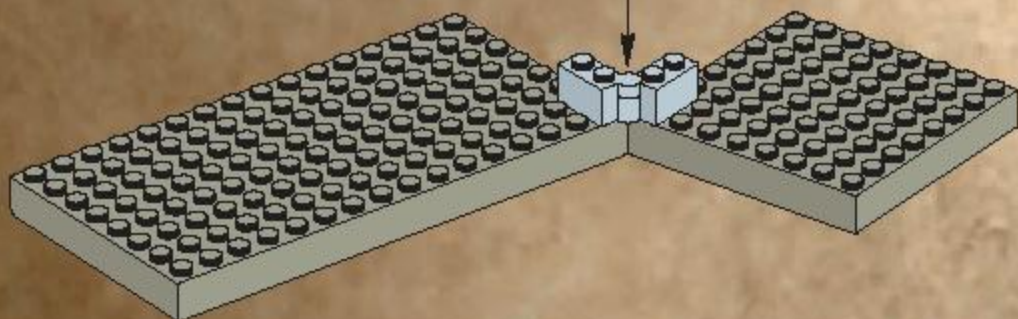

2

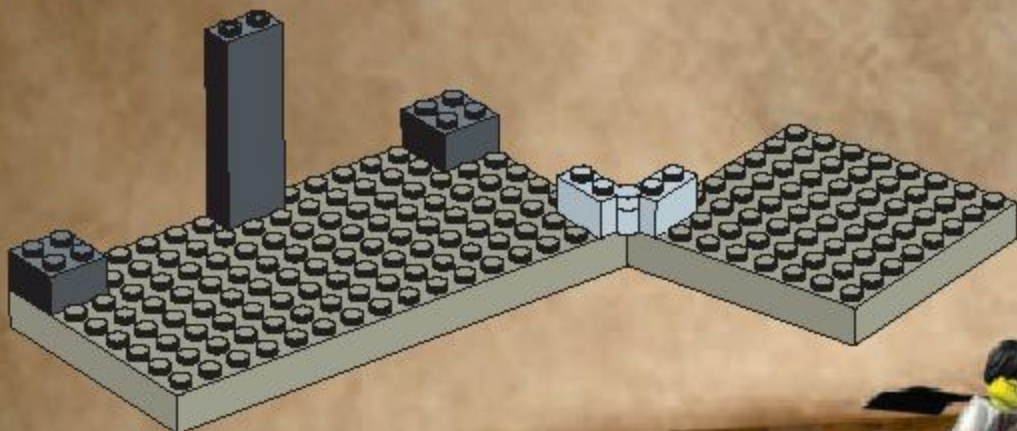

3

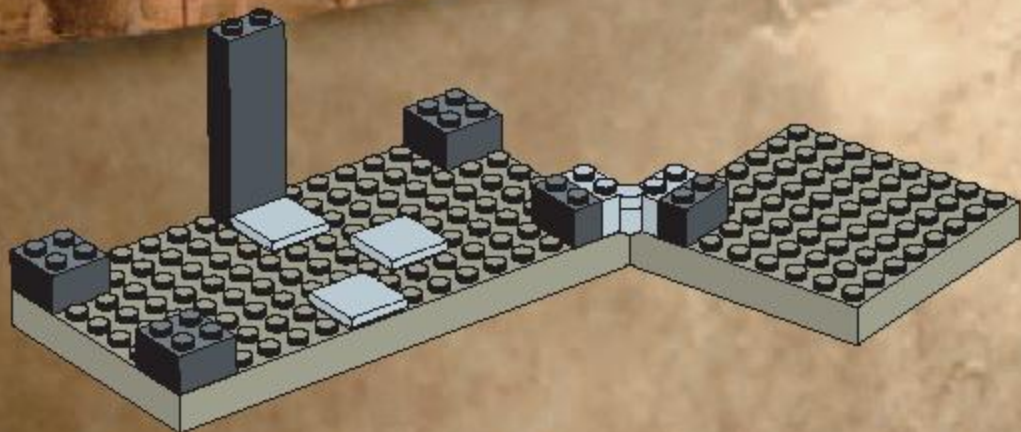

4

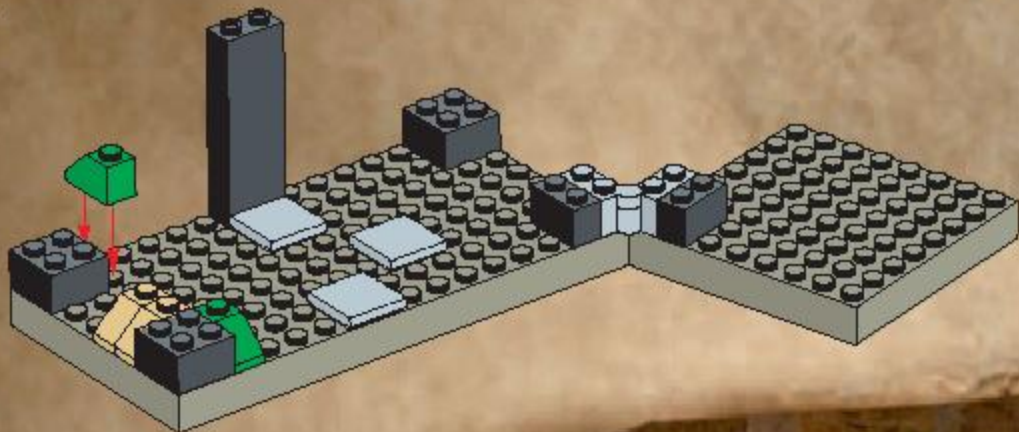

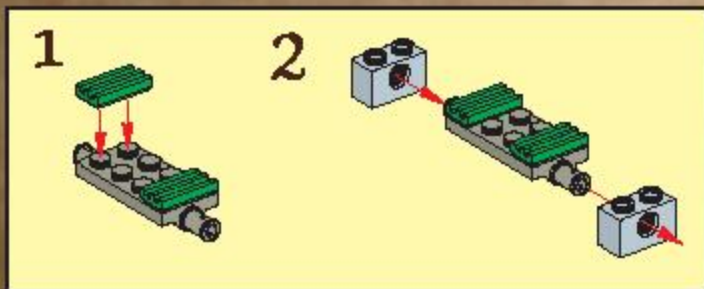

5

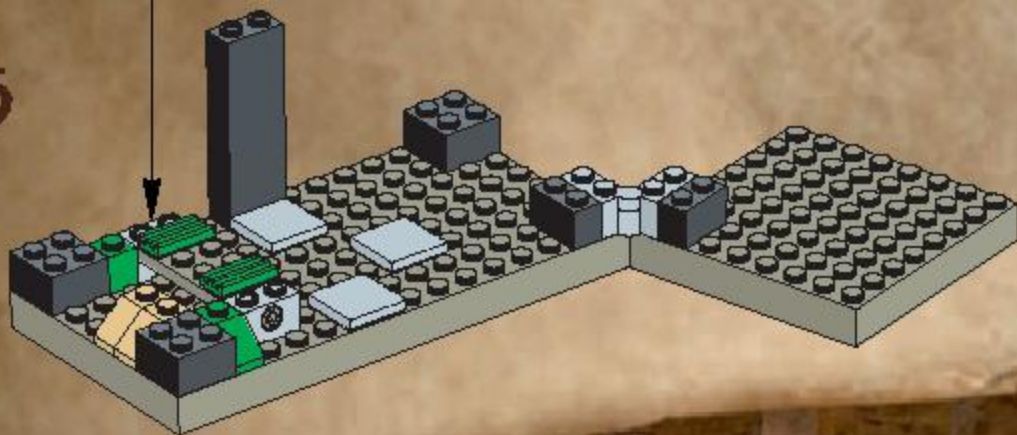

6

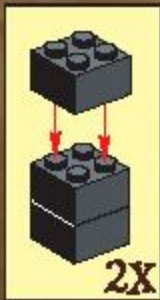
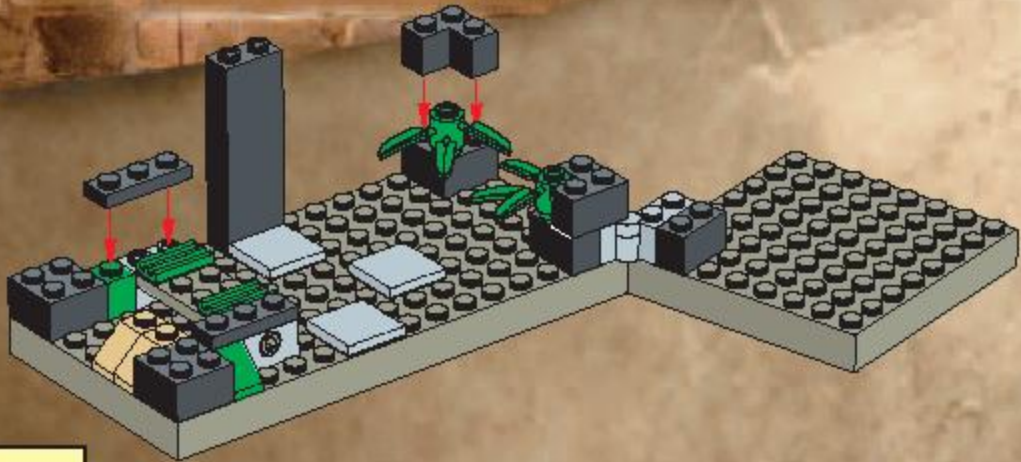

7

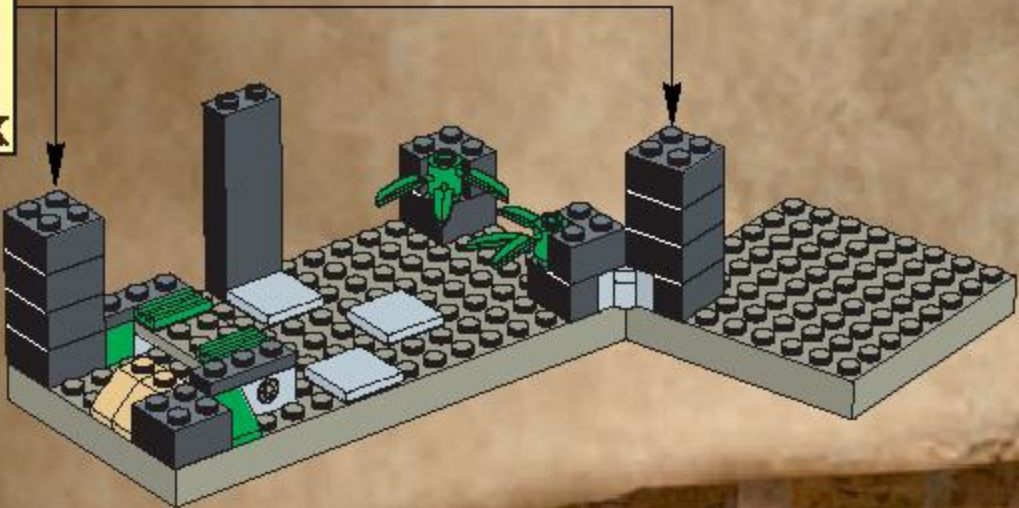

1



3

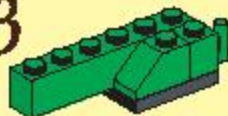

5

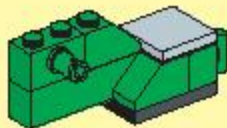

2

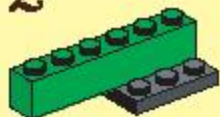

4

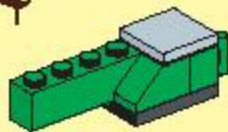

6

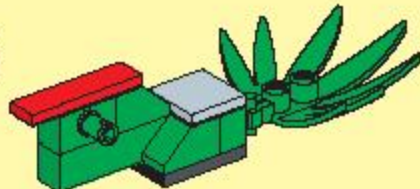

8

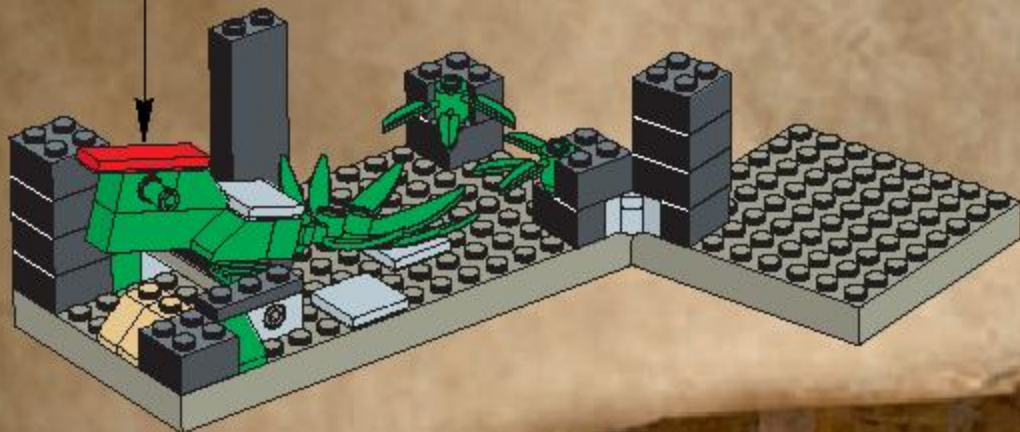

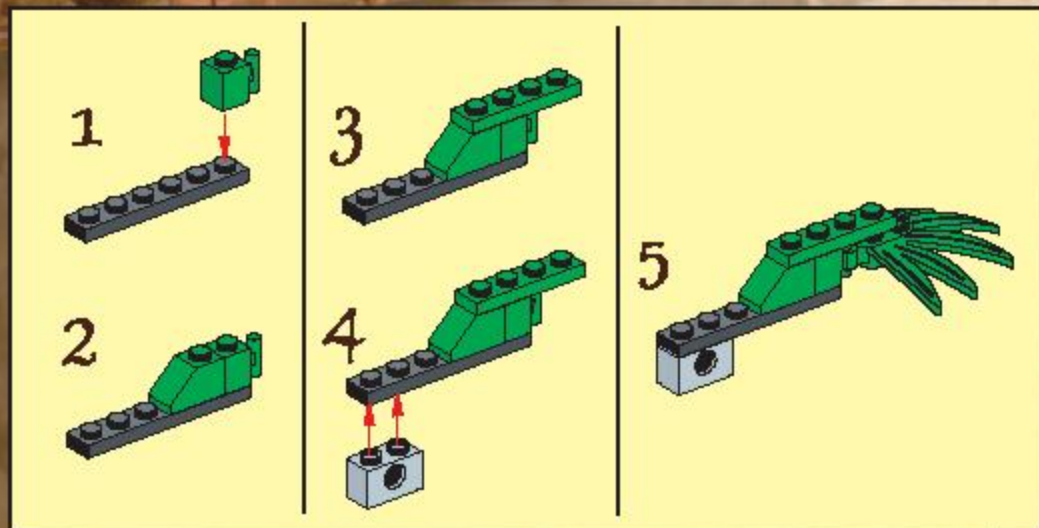

9

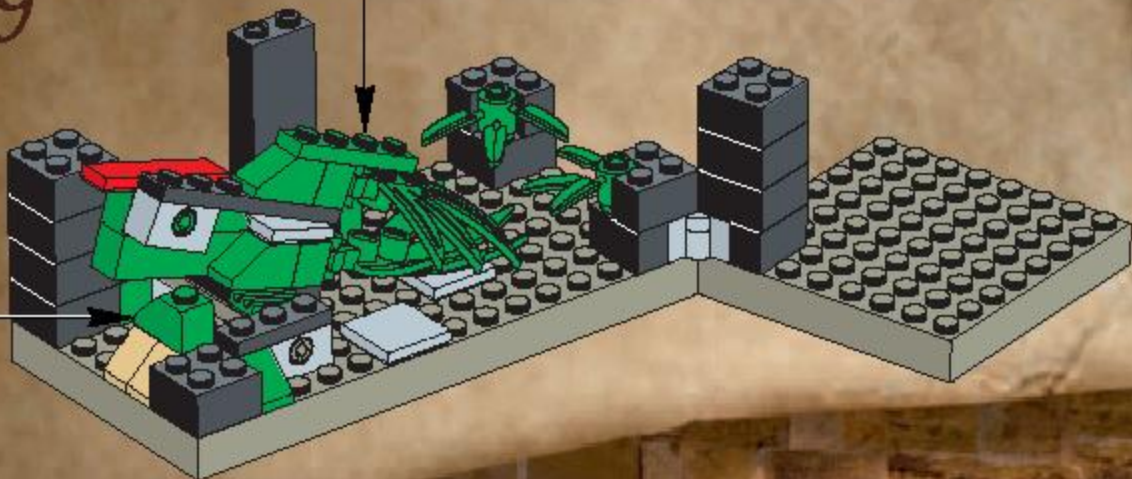

10

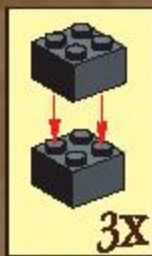
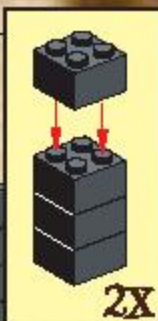
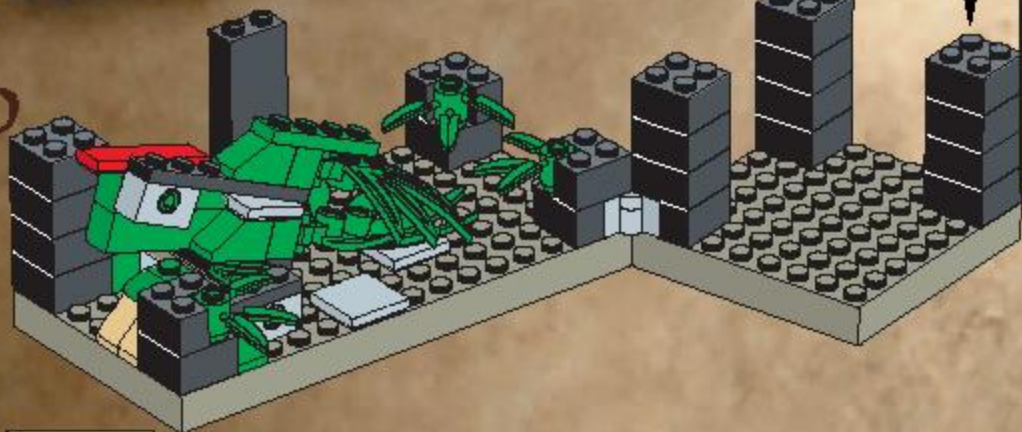

11

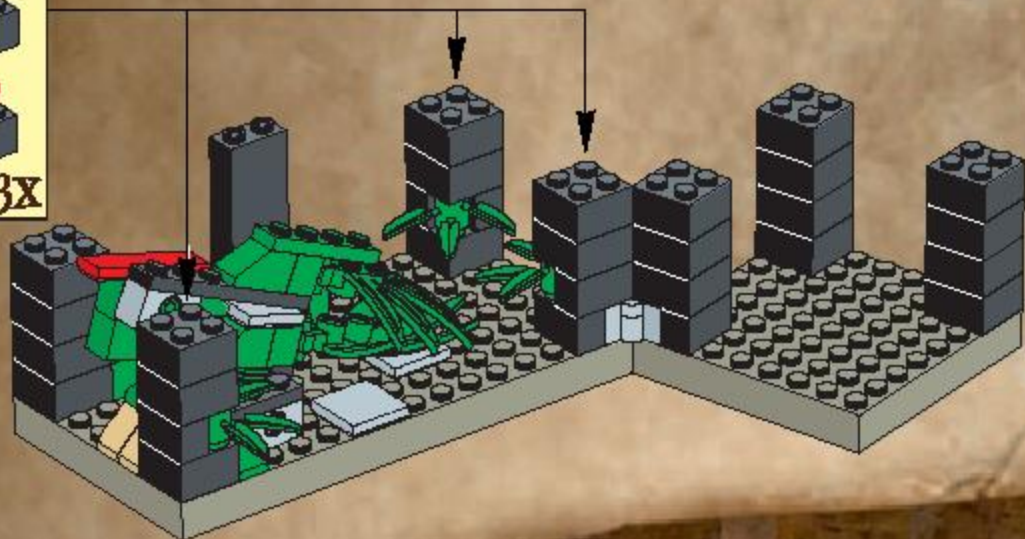

12



13

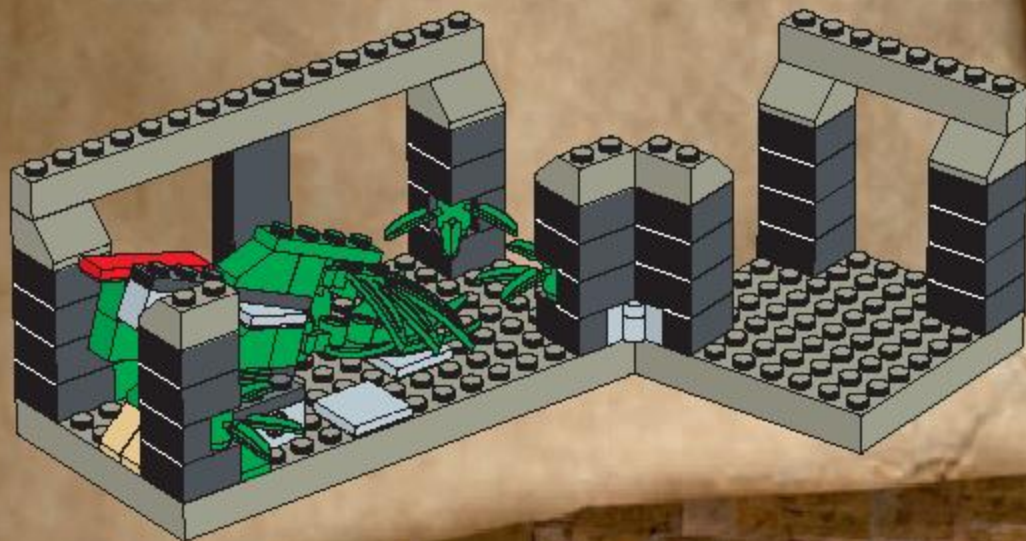

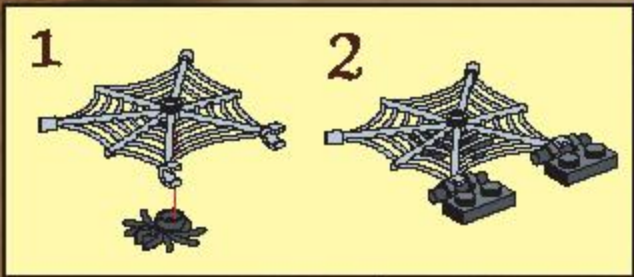

14

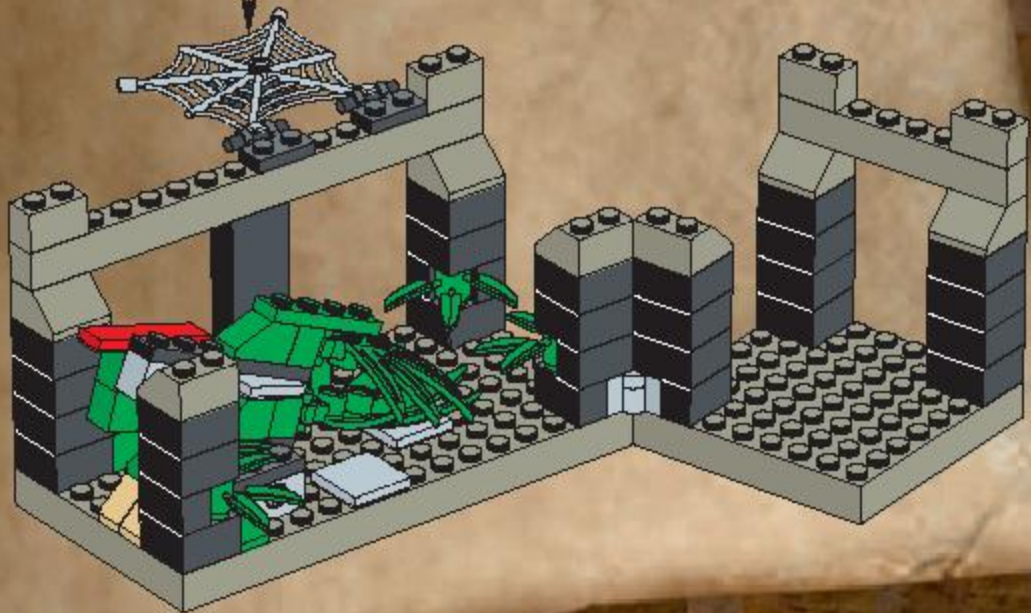

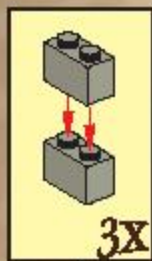
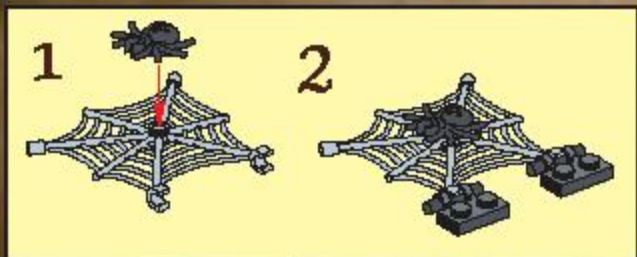

15

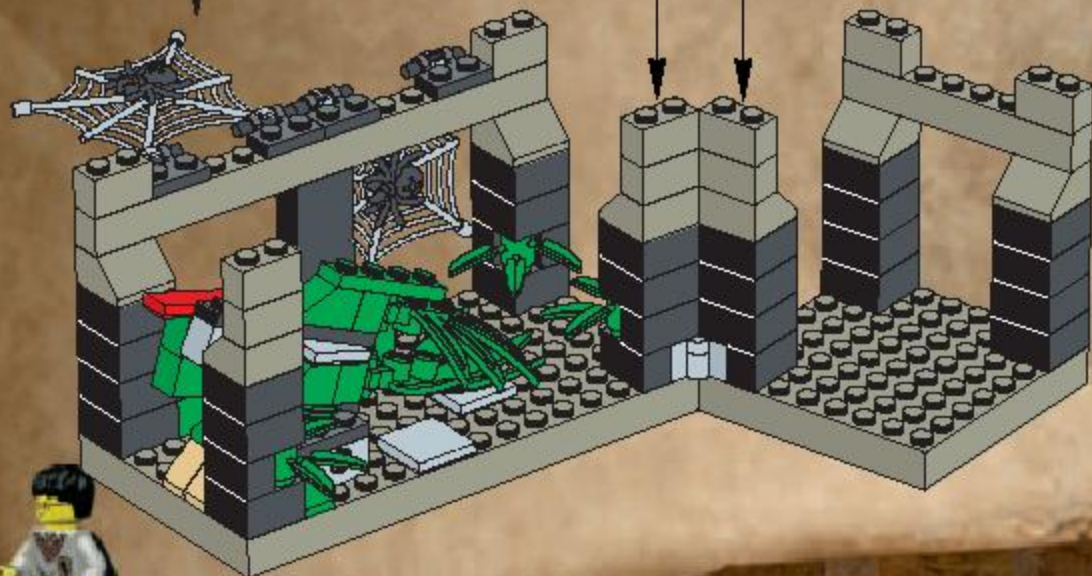

12



16

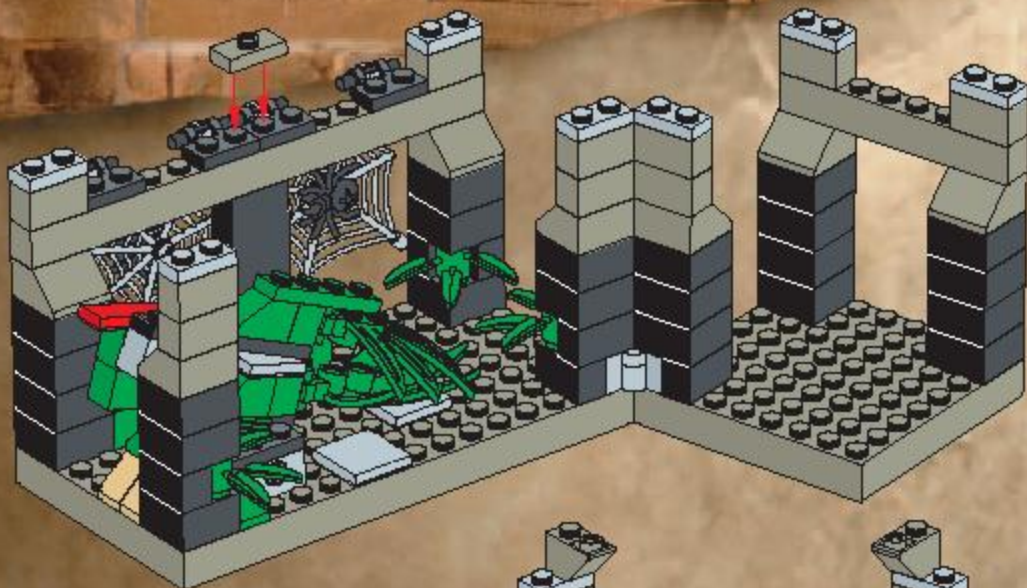

17

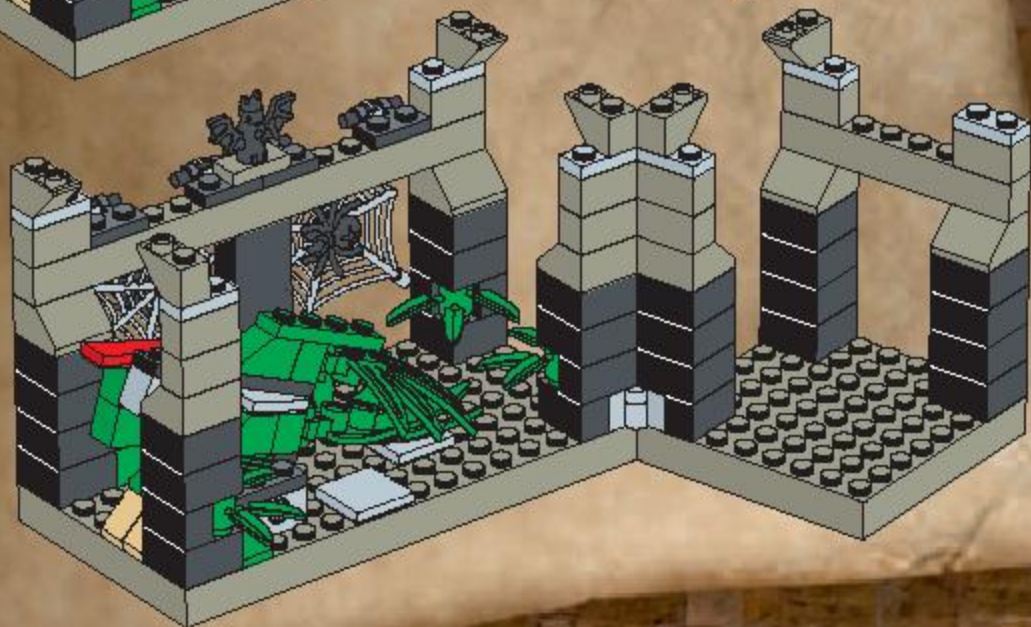

18



19

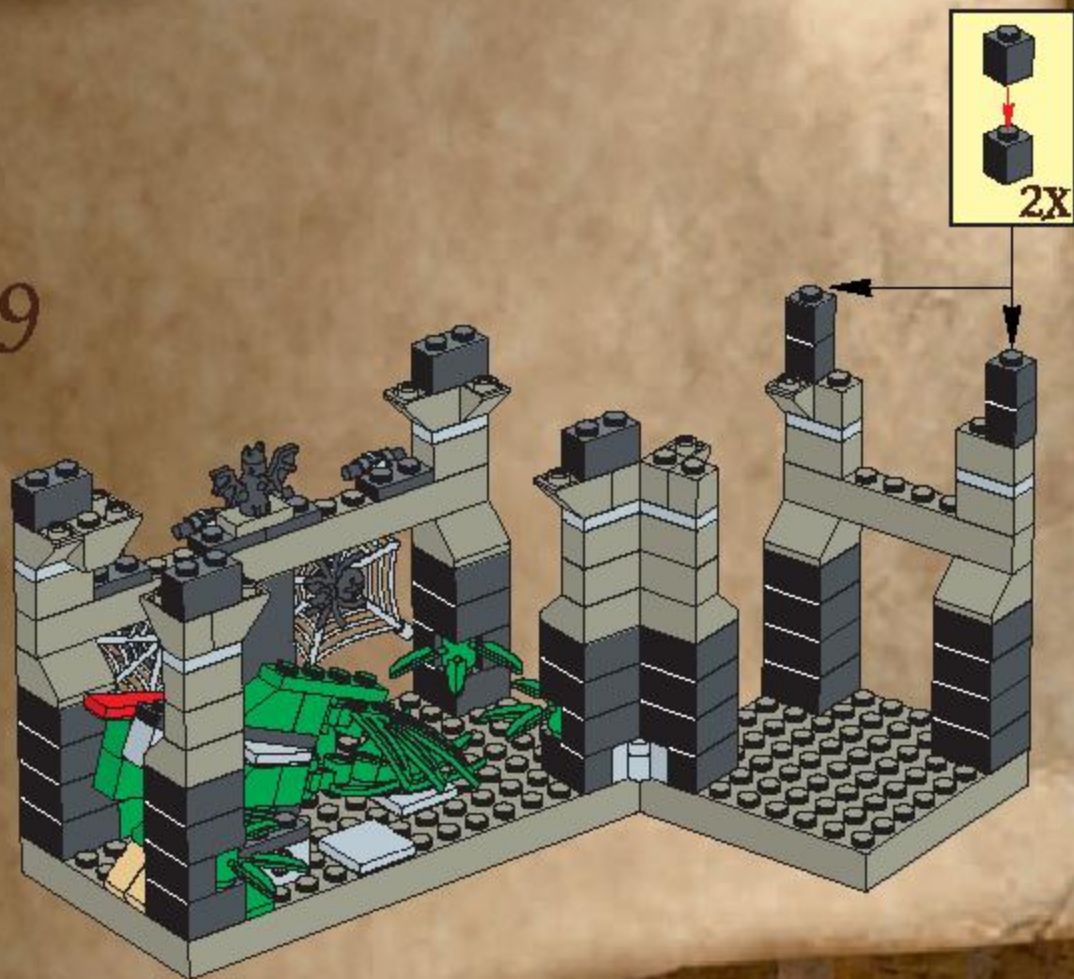

20

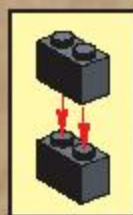

21



22



23

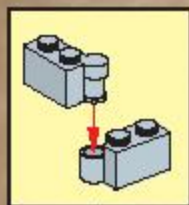

1



2



3

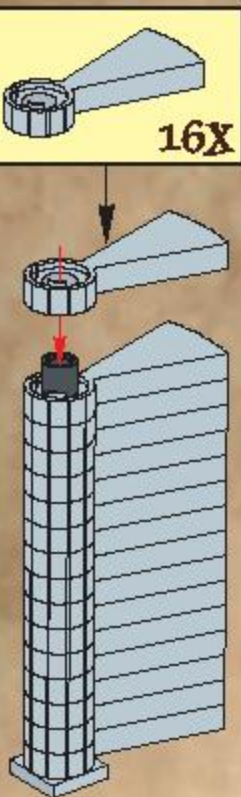

4

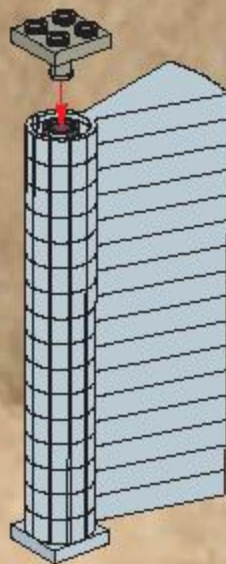

24

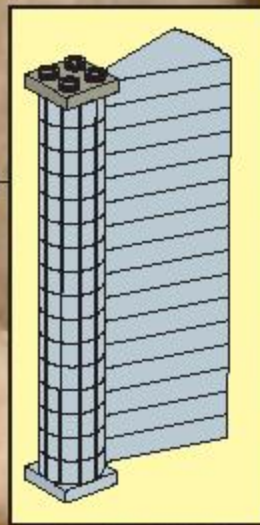

25



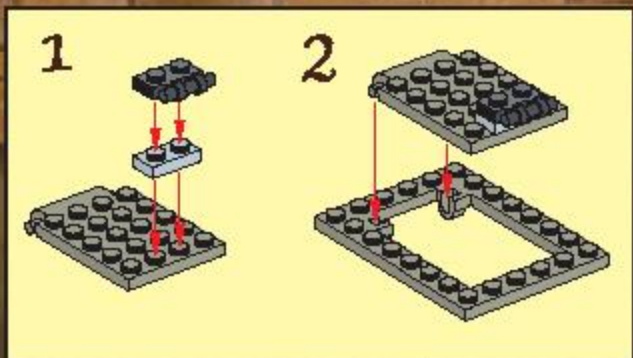

26

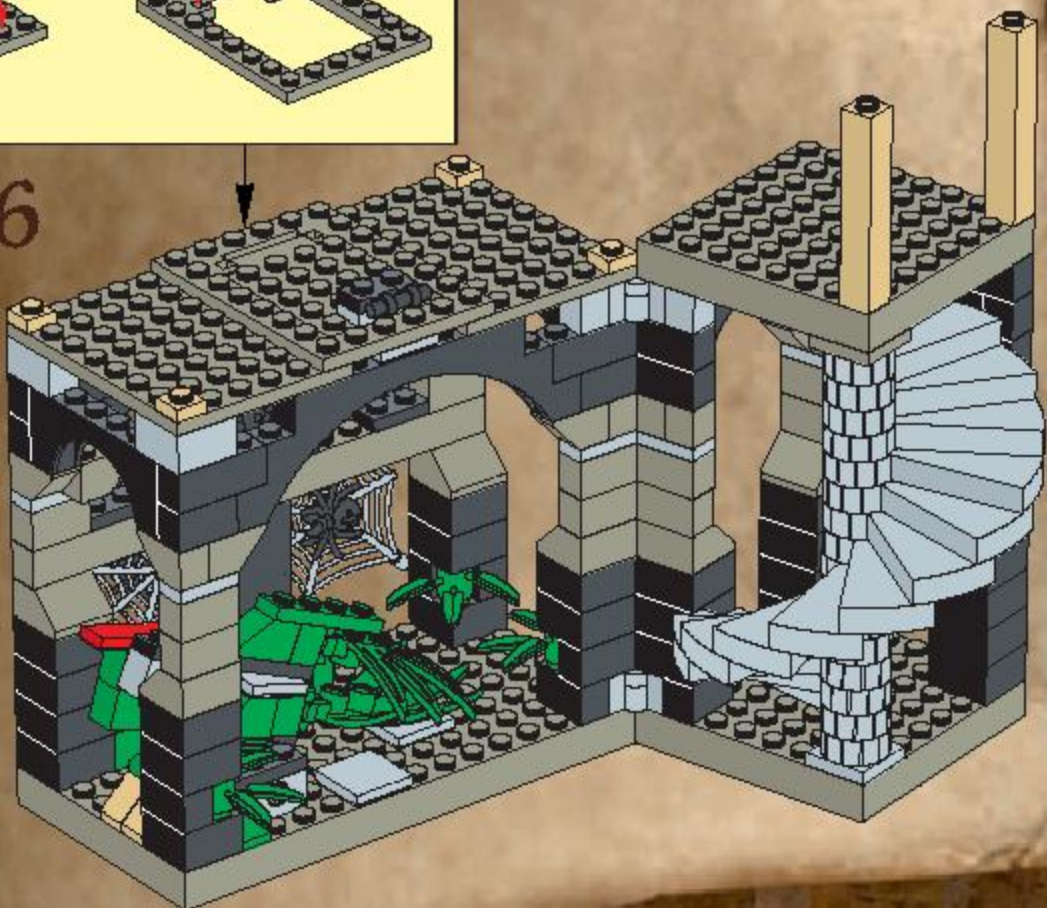



27



28

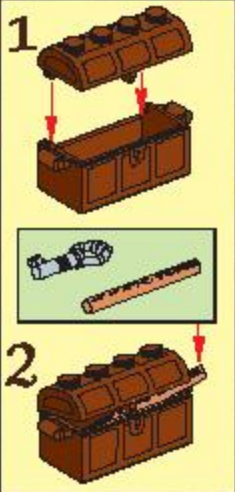



29

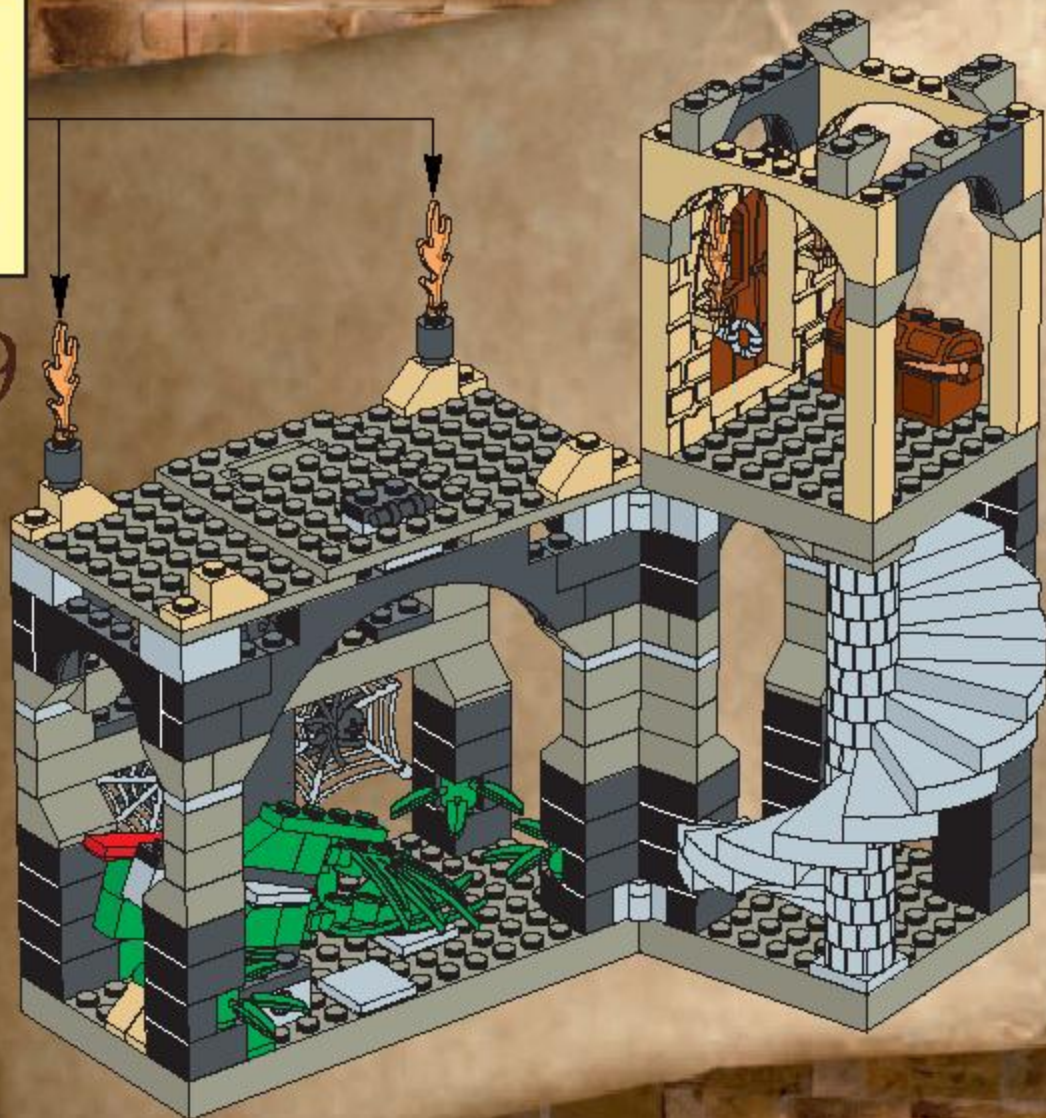

30



31



32



1

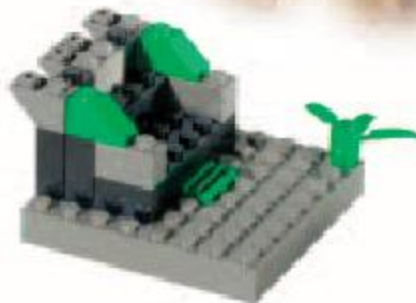

2

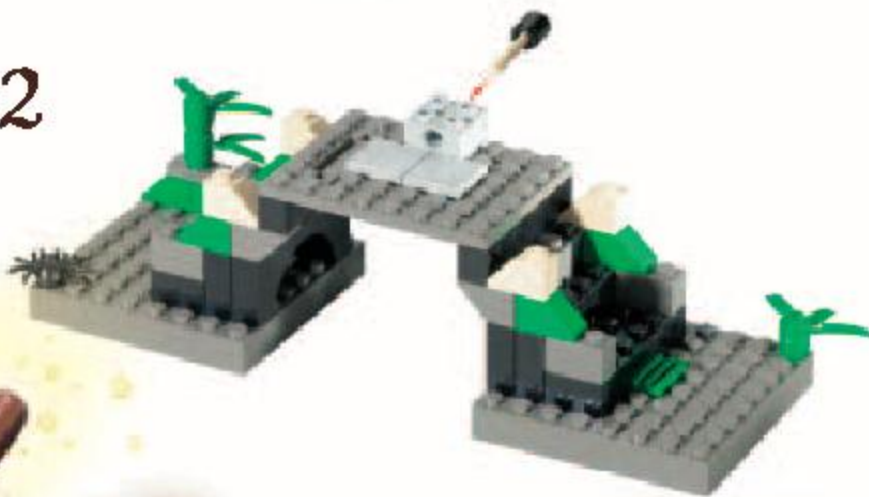

3



4



1



3

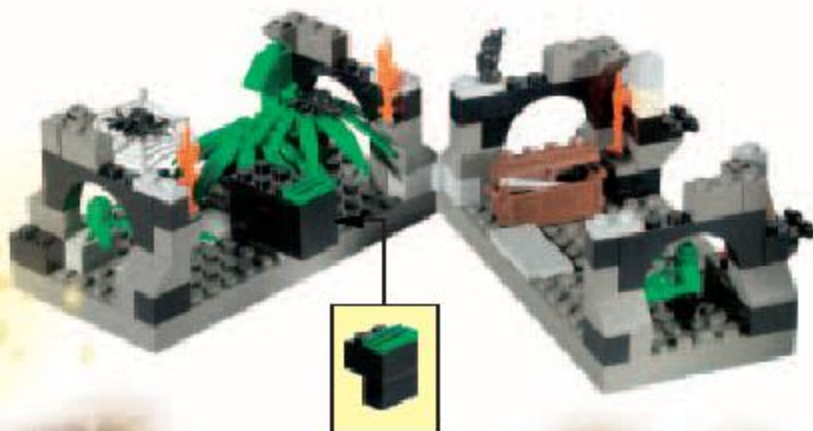

2



4



1

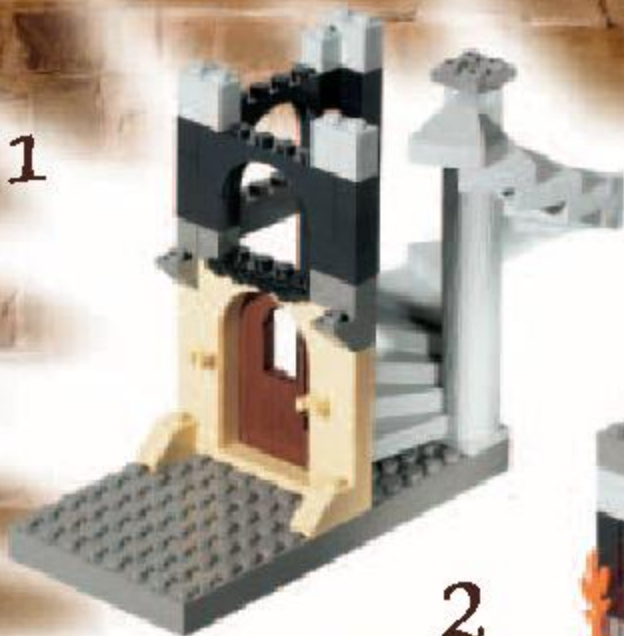

2

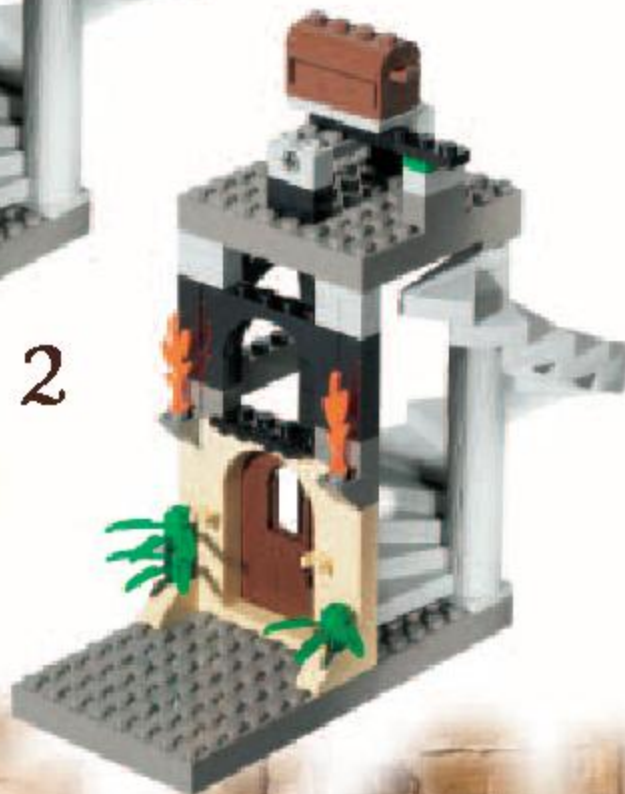

3



4





SOFTWARE

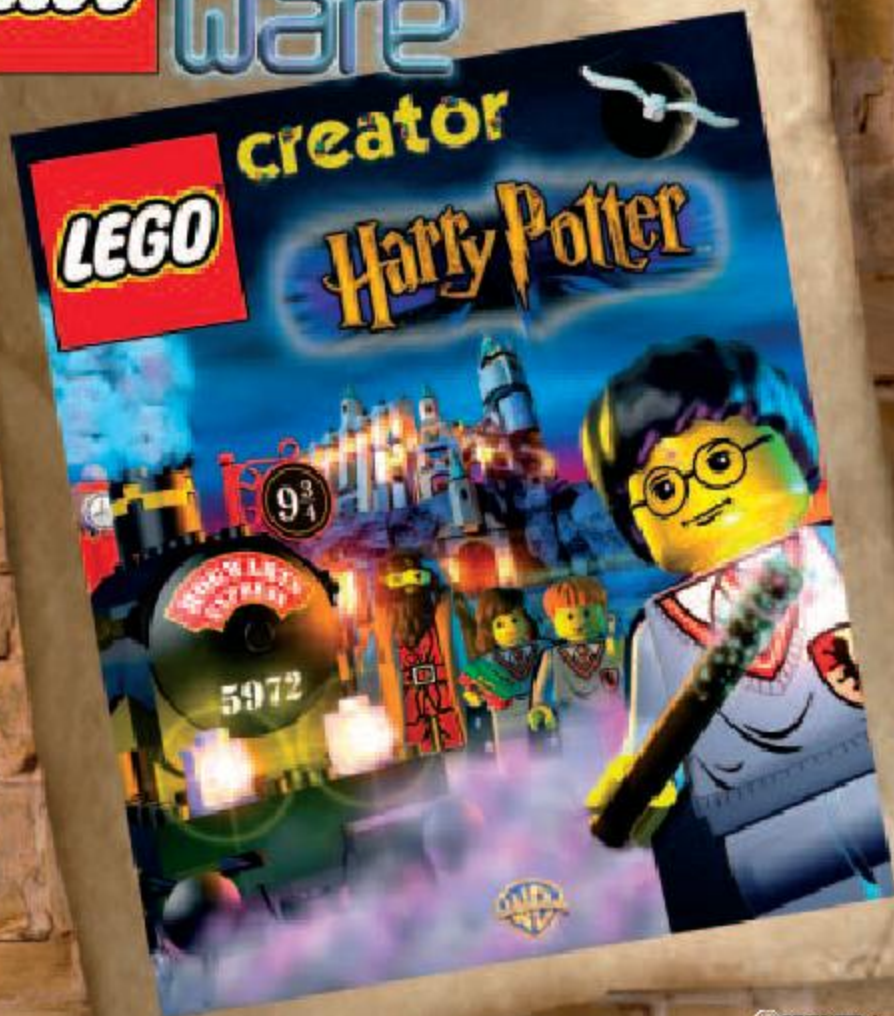

www.harrypotter.com



© 2001 WARNER BROS. ENTERTAINMENT INC. HARRY POTTER, characters, names and related indicia are trademarks of Warner Bros. © 2001 WARNER BROS. ENTERTAINMENT INC. HARRY POTTER, characters, names and related indicia are trademarks of and © Warner Bros. (9/01)