



BLACKTRON[®]

6861



Super Model building instruction.



6851 Tri-Wheeled Tyrax



6878 Sub Orbital Guardian



6887 Allied Avenger



Use this Building Instruction

Special

to combine pieces from each of these
three sets into a Space vehicle
that's out of this world!



Dear LEGO® Builder,

Thank you so much for your interest in LEGO® products and for sending for your FREE BLACKTRON® Super Model building instruction.

As you know, one of the best things about LEGO toys is that all LEGO sets work together! The following building instruction provides an exciting example of the endless building possibilities available when you combine LEGO sets together. An added advantage of this special building instruction is the opportunity you have to build a spectacular set that is not available in any store!

Thanks again for participating in this offer. We hope that you really enjoy building your "super" Space model and that you'll continue to enjoy LEGO products for many years to come!

And remember, you need all three sets from the previous page to complete the Super Model.

**Good Luck!
Jack the LEGO MANIAC®**

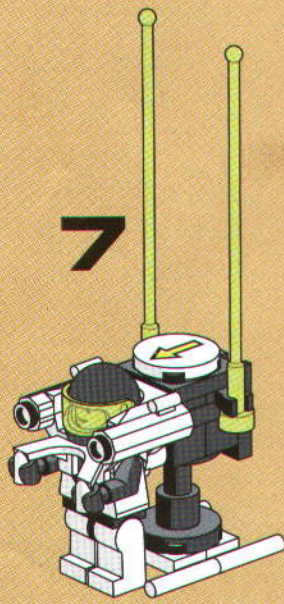
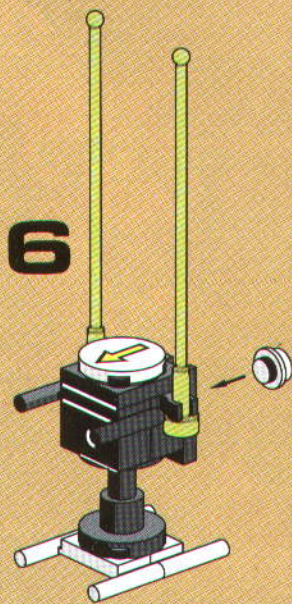
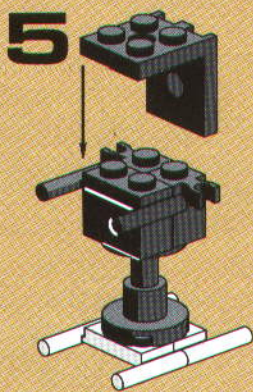
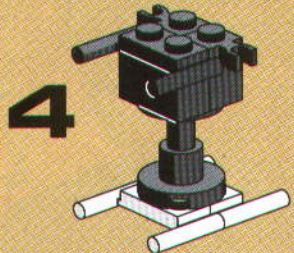
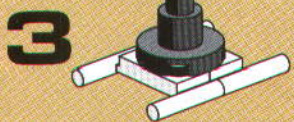
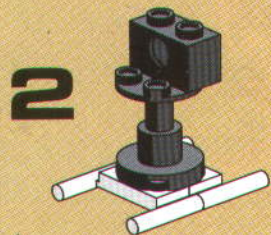
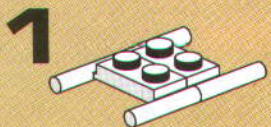
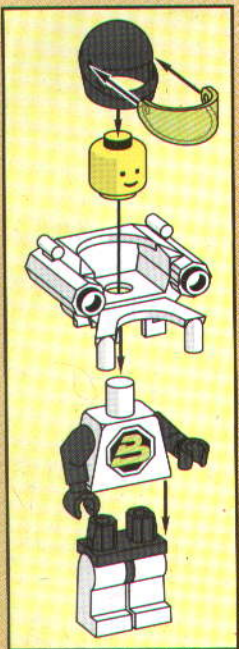

1

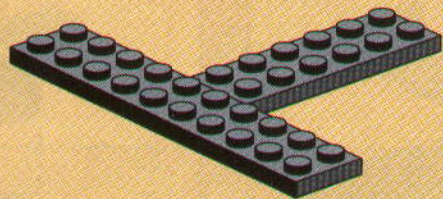

2

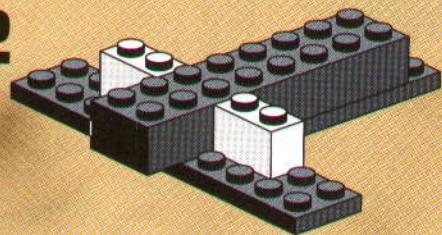

3

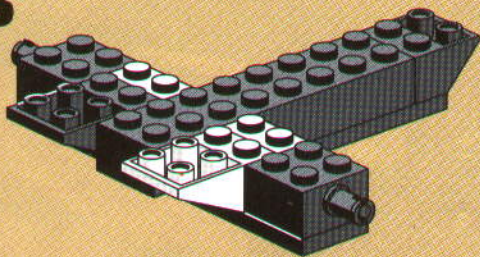

4

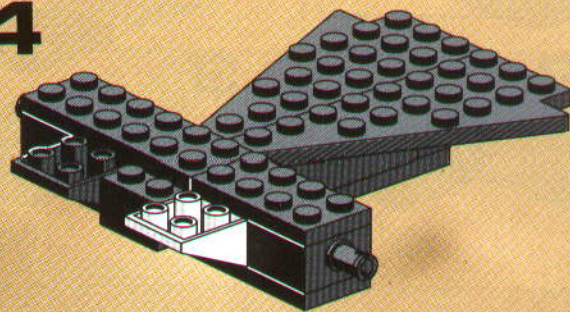

5

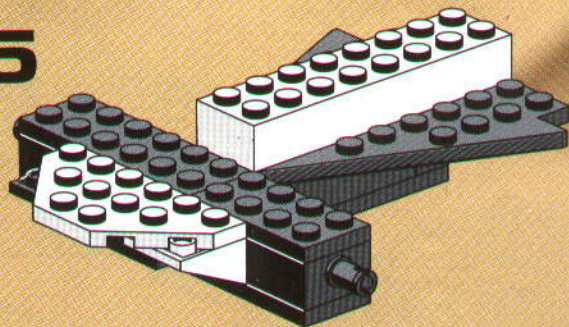

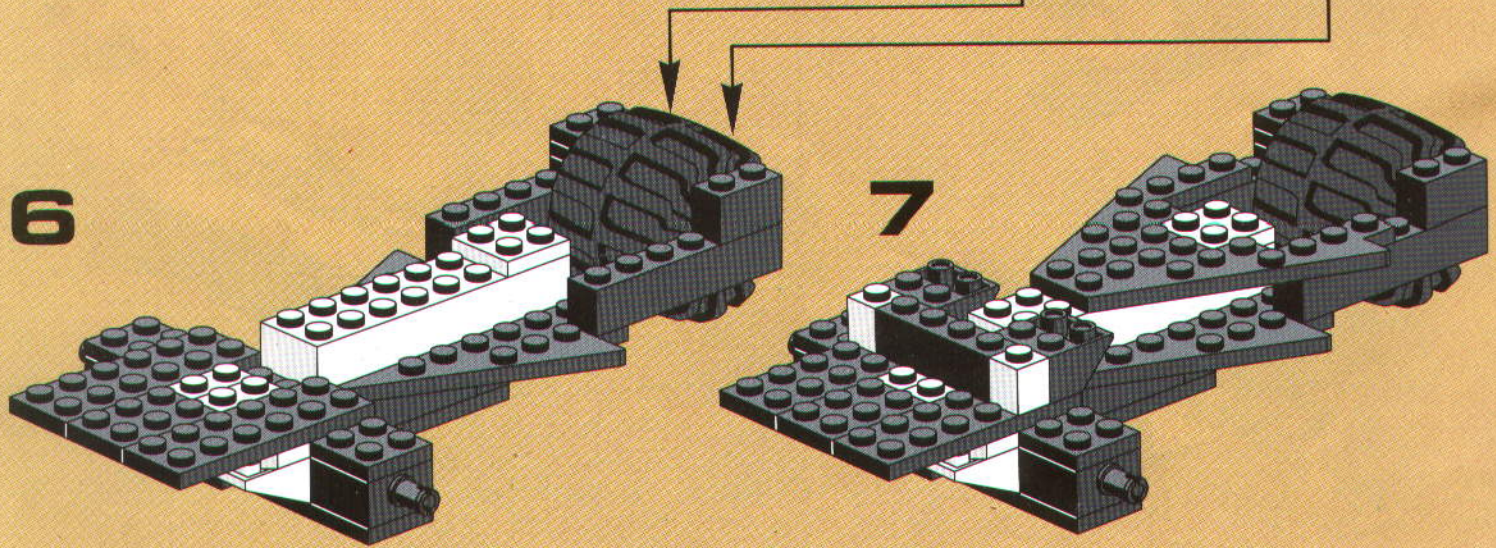
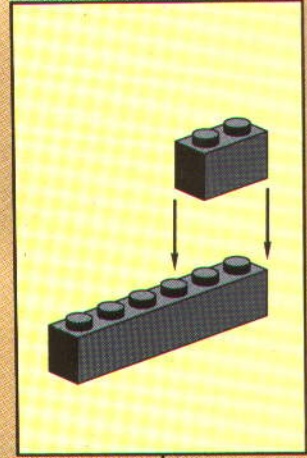
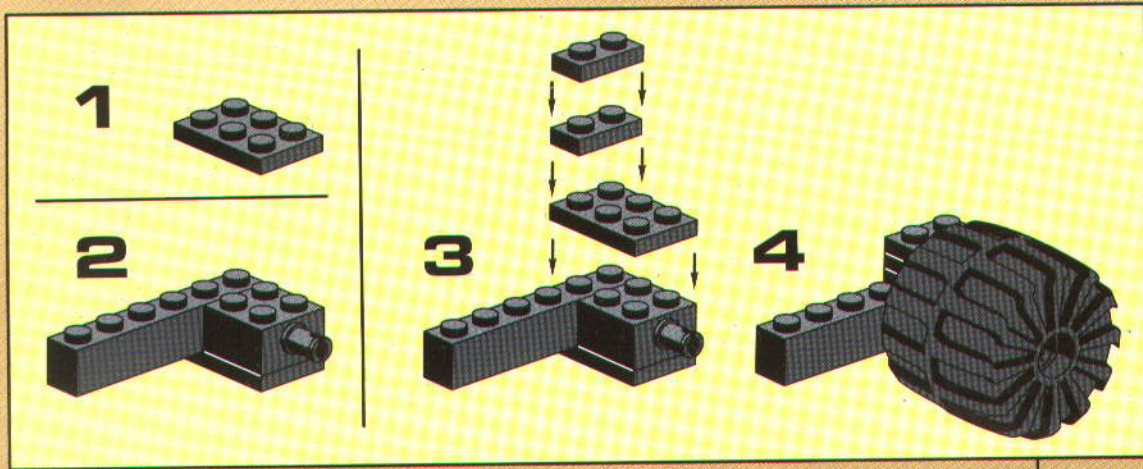

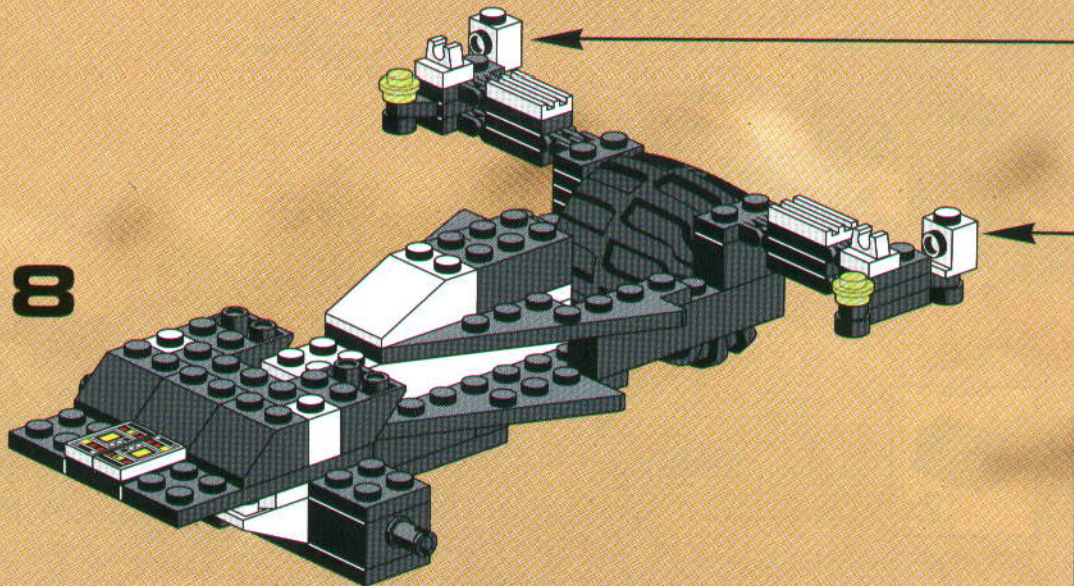
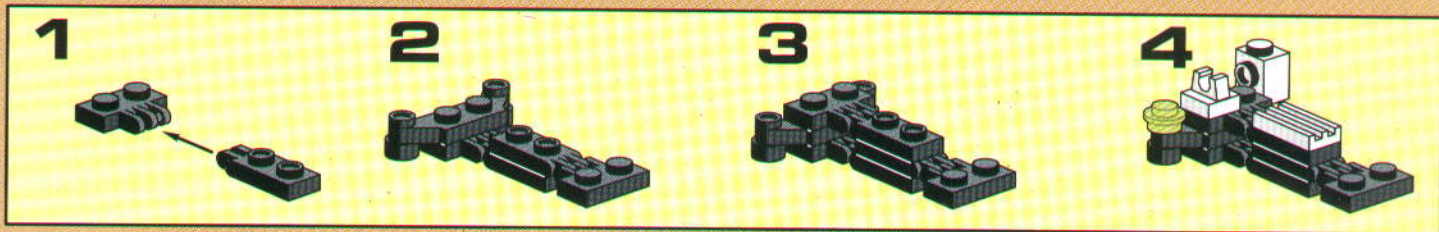

9

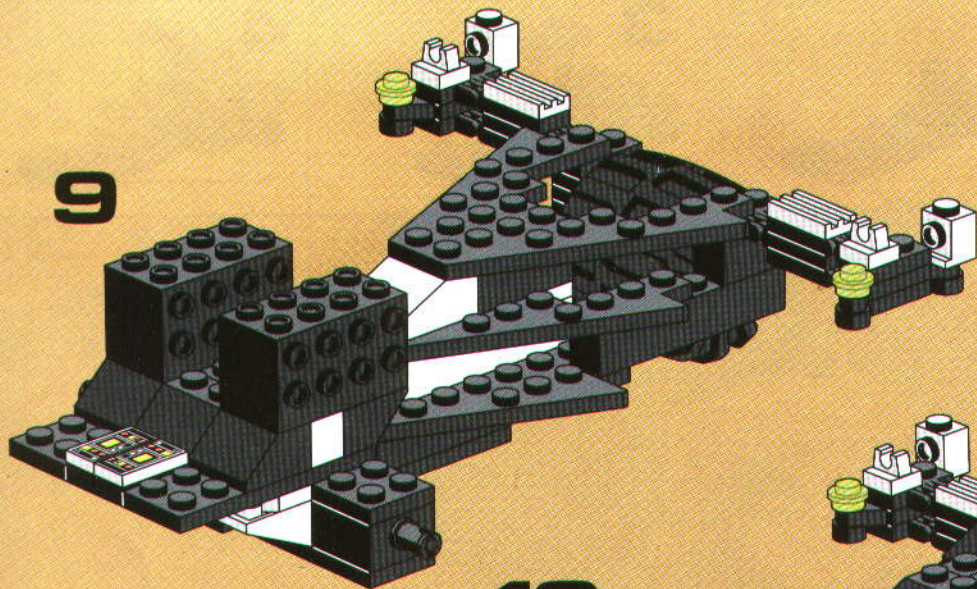

10

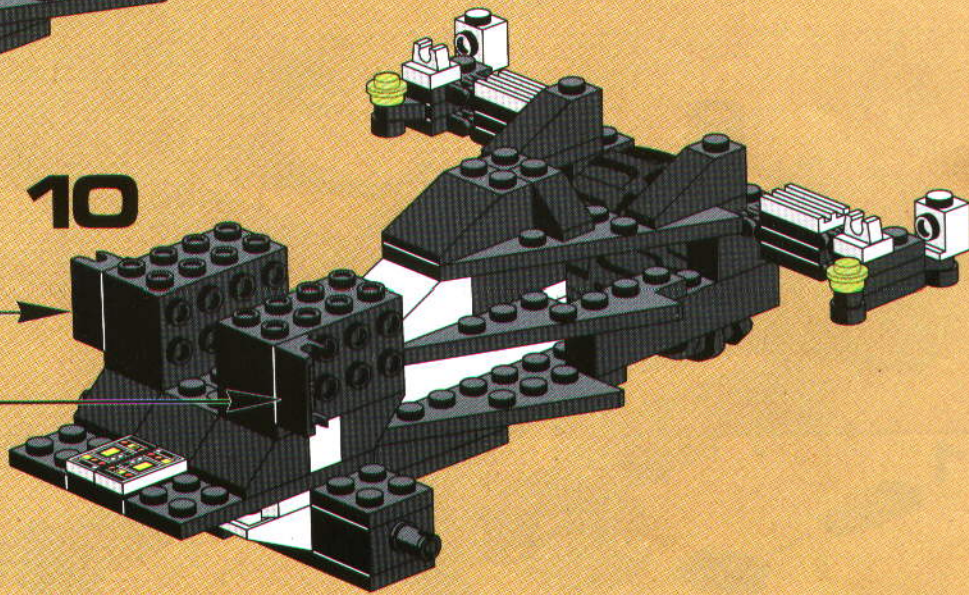
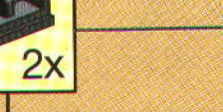

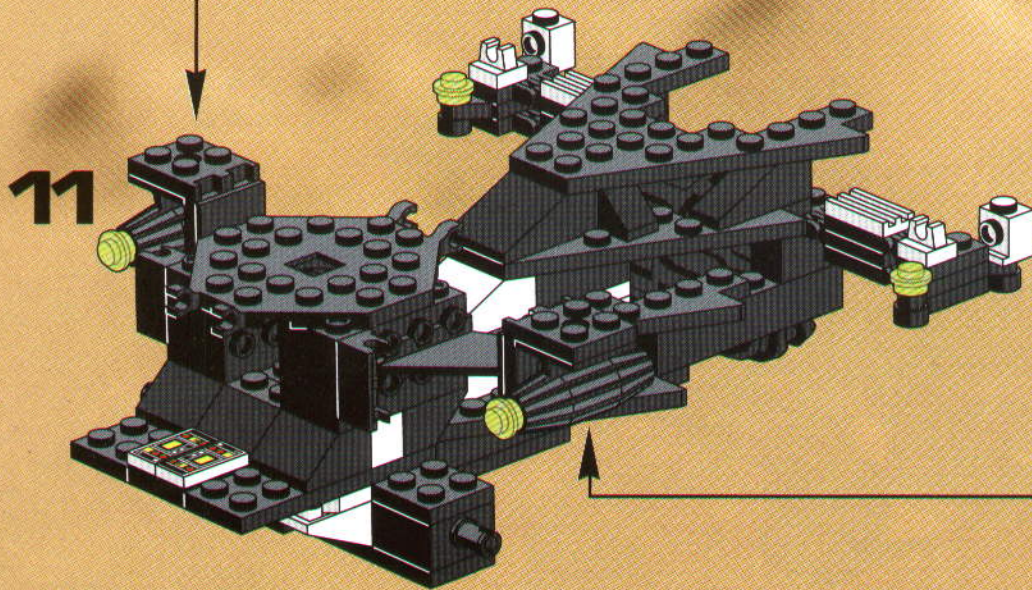
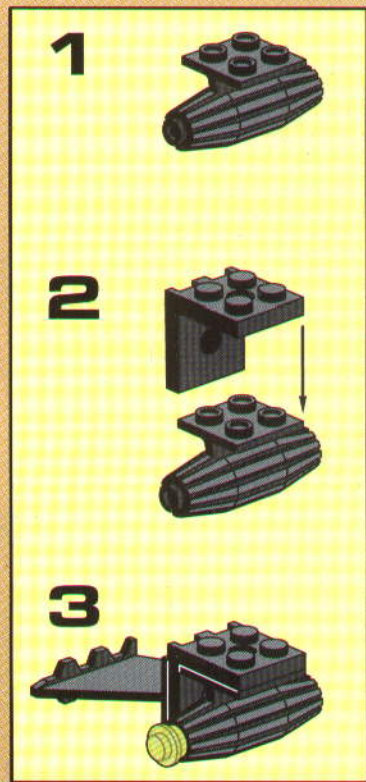
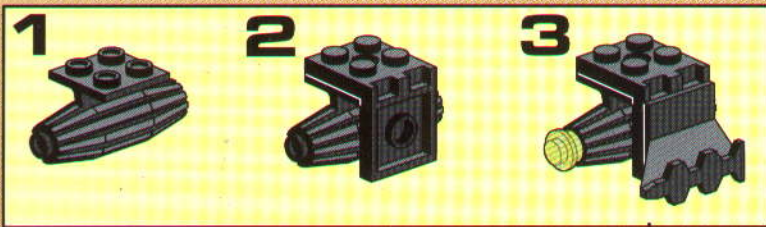

12

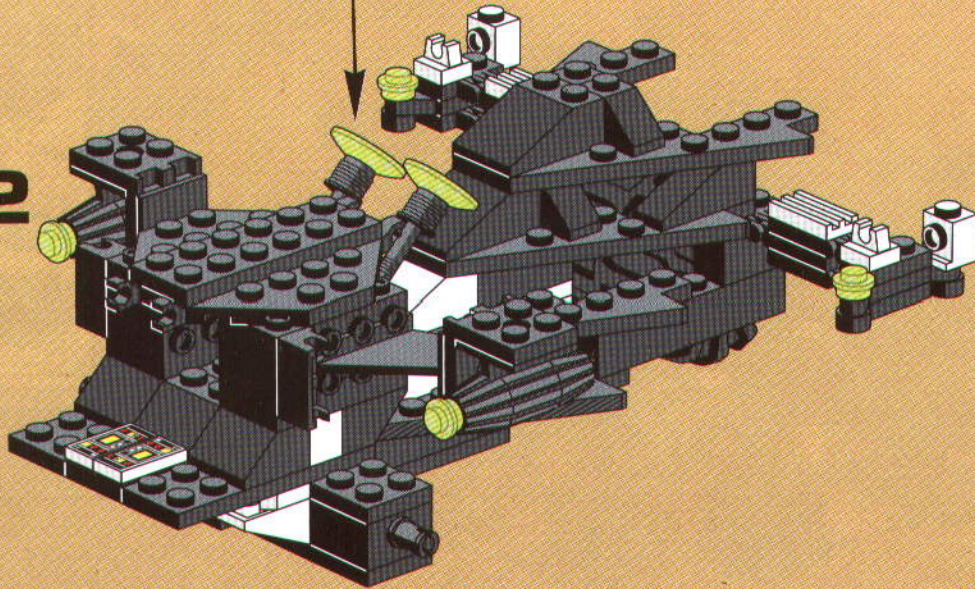
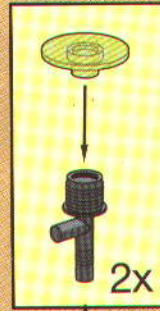

1

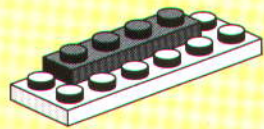

2

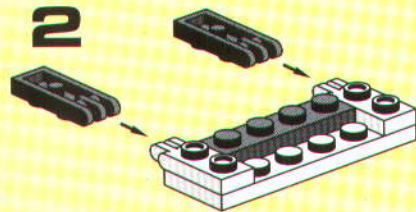

3

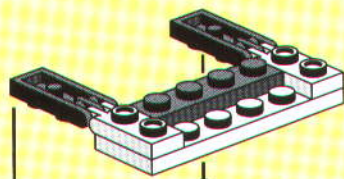

4

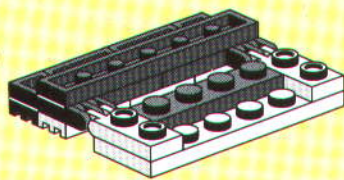

5

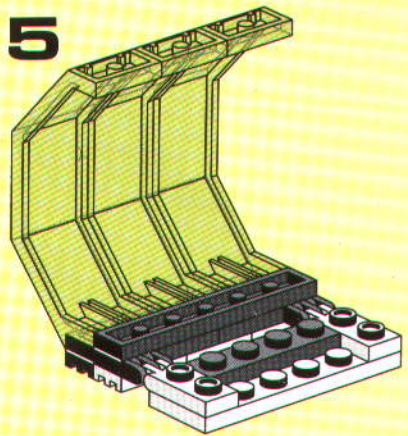

6

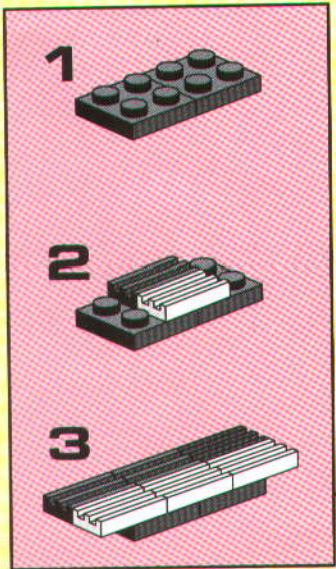
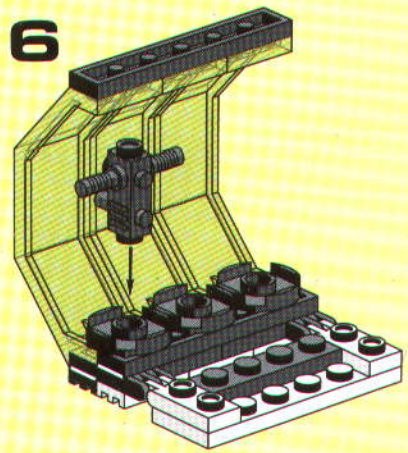

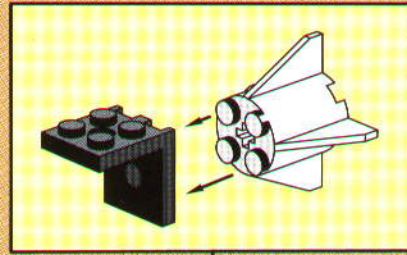

14

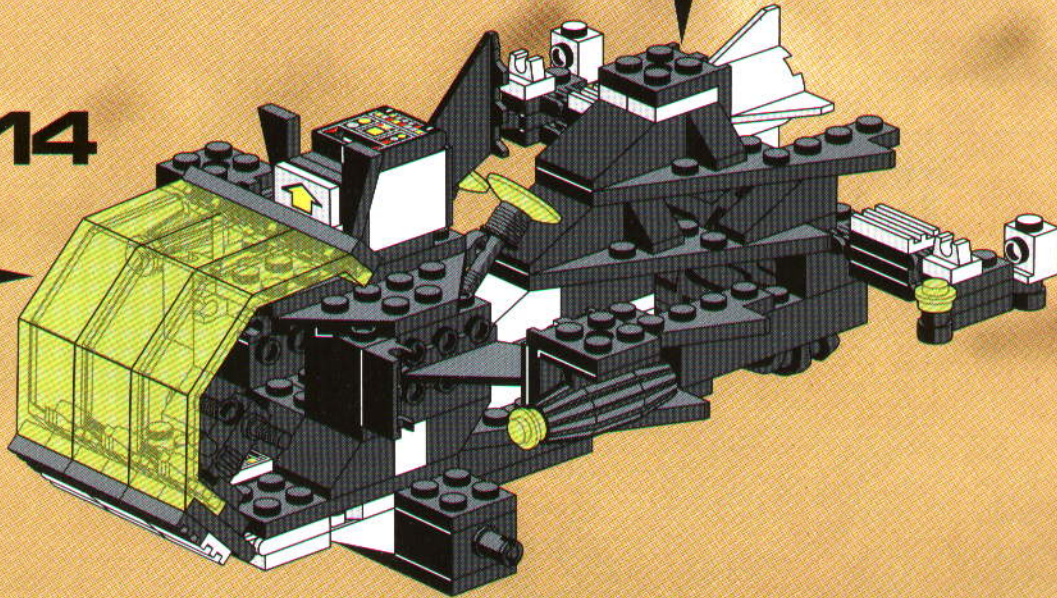

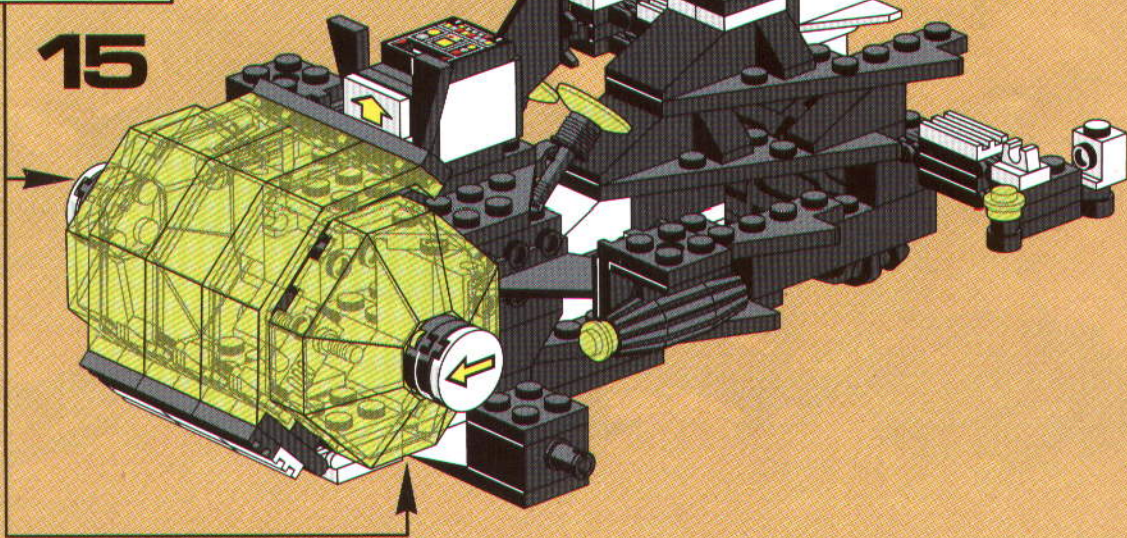
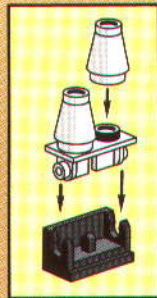
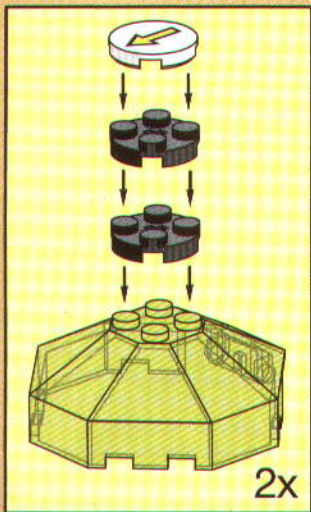

16

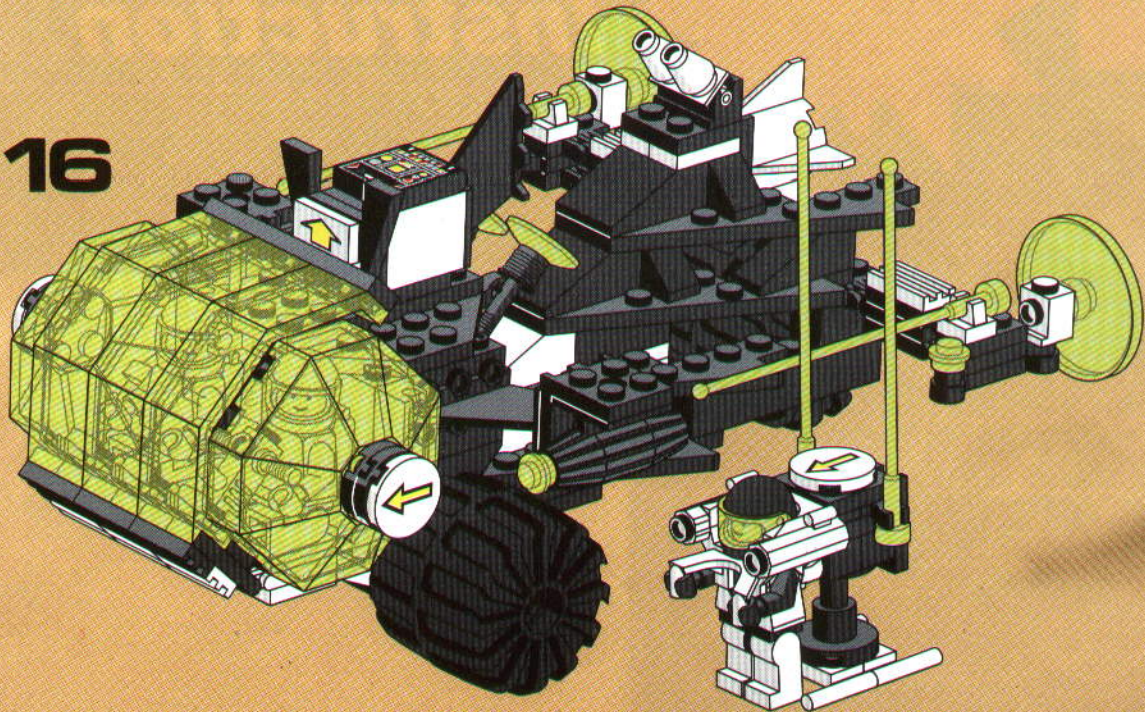

The LEGO logo is displayed in its characteristic white, bold, sans-serif font with a thick black outline. It is set against a solid red square background.The word "Free" is written in a bold, red, sans-serif font. It is centered within a large, multi-pointed starburst shape that has a red-to-orange gradient and a halftone dot pattern.

**Building
Instruction**

