

**LEGO**

7-12

**STAR  
WARS**



4176940

**7103**

**JEDI™ DUEL**

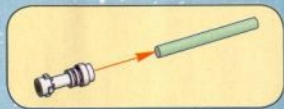

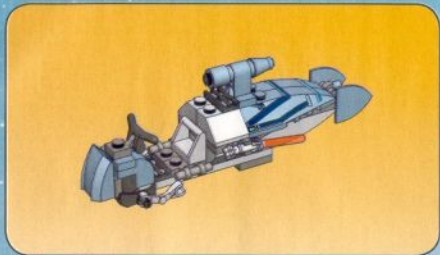

1

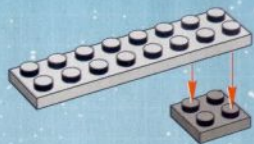

2



3

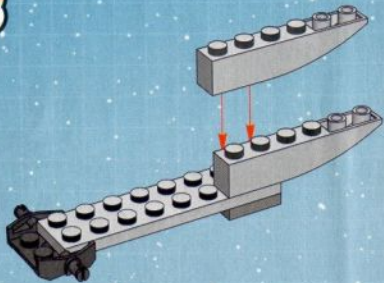

4

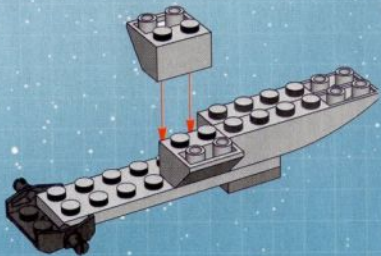

5

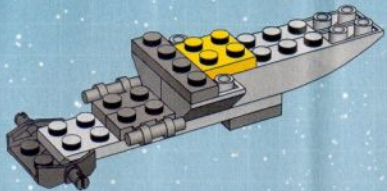

6

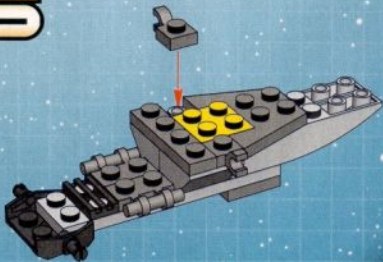



7

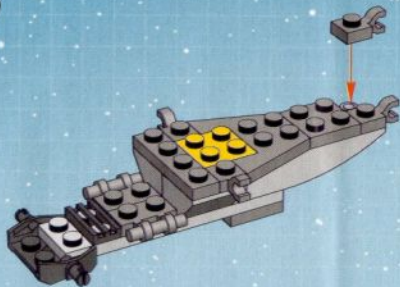

8

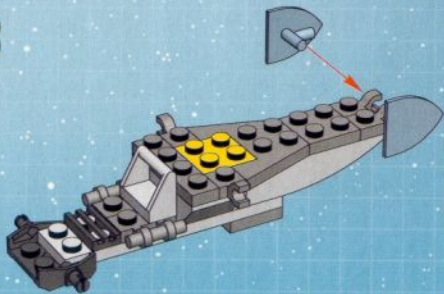

9

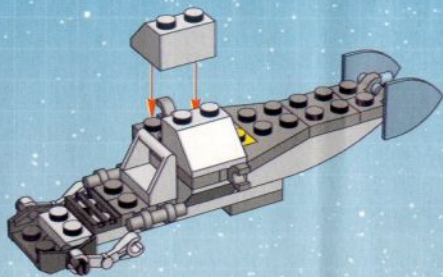

10

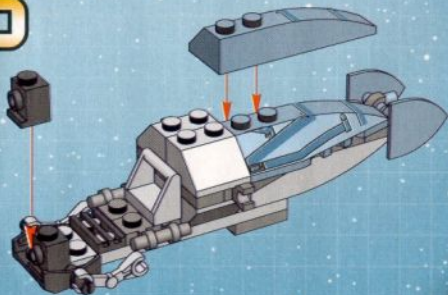

11

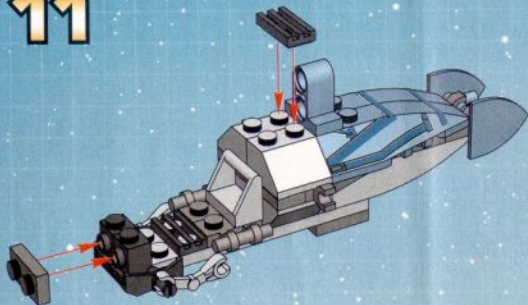

12

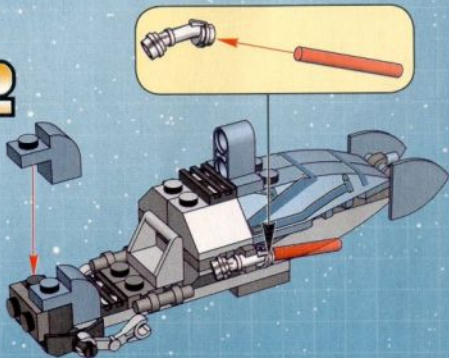



13

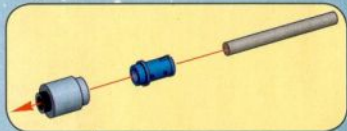
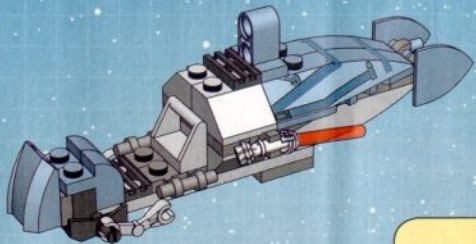

14

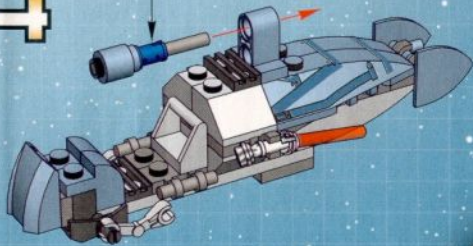

# 15



# 16



17



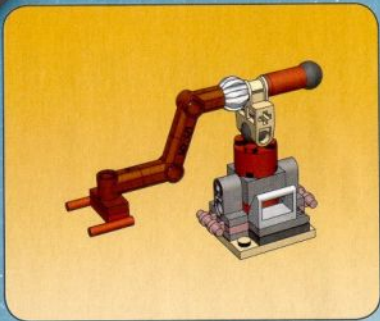

1

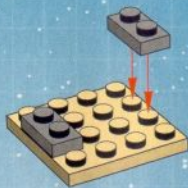

2

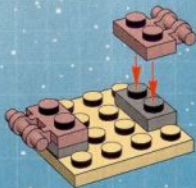

3



4





5

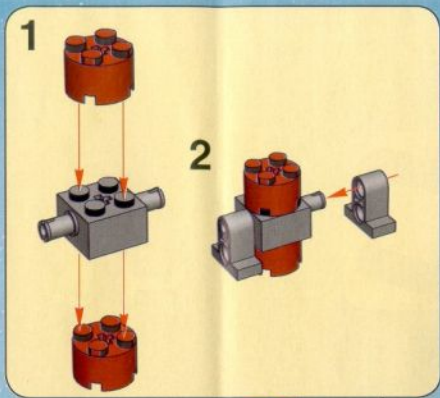

6

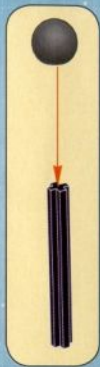

7



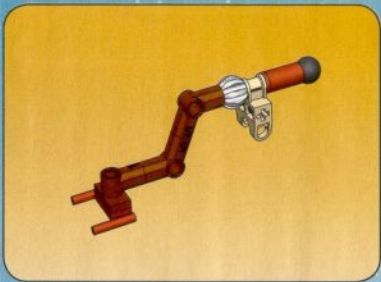

1



2

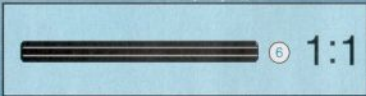

3

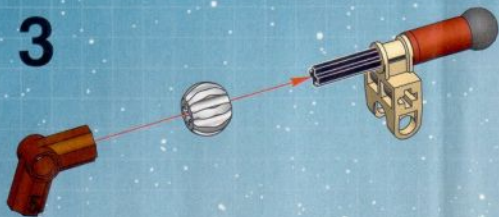

4



5

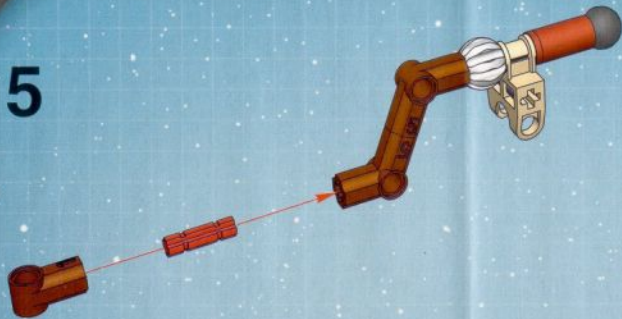

6

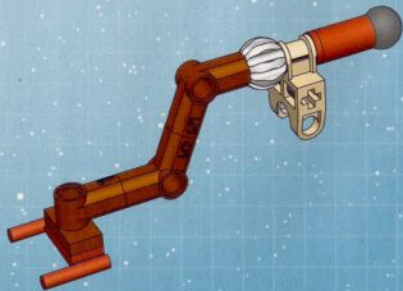
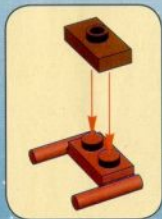



8



9





# STAR WARS

ATTACK OF THE CLONES™



7133





7113







**LEGO** STAR WARS



7200

7201





[www.LEGO.com/starwars](http://www.LEGO.com/starwars)

LEGO, the LEGO logo, the JUST IMAGINE logo and the Minifigure are trademarks of/ sont des marques de commerce de/ son marcas registradas de LEGO Group.

©2002 Lucasfilm Ltd. & TM/MC. All rights reserved. Used under authorization./Tous droits réservés. Utilisé sous autorisation./ Todos los derechos reservados. Usado bajo autorización.