

7777





LEGO® tog har den fordel, at de kan laves på mange måder. I denne bog er der vist en masse ideer til, hvordan lokomotiver, vogne, banelegemet – og det, der er udenom – også kan se ud. Bogen er delt op i et større afsnit om 12 V tog og et mindre afsnit om 4,5 V tog. Men det behøver du ikke at tage så højtideligt. Du kan sikkert få ideer fra begge afsnit – uanset hvilket tog, du har.

Måske har du ikke lige præcis alle de elementer, der er brugt i de forskellige modelforslag. Du skal ikke opgive af den grund. Hvis du bruger din fantasi, vil du næsten altid kunne bygge modellerne på en lidt anden måde ved hjælp af de klodser, du har. God fornøjelse.



Det fine med LEGO® tog er at de kan bygges på flere måter. I denne boken finner du masse idéer til hvordan lokomotiver, vogner, banelegemet osv. kan se ut.

Boken er delt opp i et større avsnitt om 12 V tog og et mindre avsnitt om 4,5 V tog. Du kan sikkert få idéer fra begge avsnitt – uansett hvilket tog du har.

Du har kanskje ikke akkurat alle de elementene som er brukt i de forskjellige modellforslag, men gi ikke opp av den grunn. Hvis du bruker fantasien din, vil du nesten alltid kunne bygge modellene på en litt annen måte ved hjelp av de klossene du har. Lykke til!



LEGO® tågen har den fördelen att de kan byggas på många olika sätt. I denna bok ger vi några tips om hur du kan bygga.

Boken är uppdelad i två avsnitt. Det ena handlar om 12 volt och det andra om 4,5 volt tåg.

Du kanske inte kan bygga exakt vad vi visar i boken, eftersom du saknar vissa LEGO klossar. Men det gör inget, för det viktigaste är att du börjar bygga och försöker skapa liknande modeller med de LEGO klossar du redan har.

Lycka till!



LEGO® junan etuna on, että se voidaan rakentaa monella eri tavalla uudelleen ja uudelleen. Tässä kirjassessa annetaan koko joukko viiheitä vaihtoehtoisista tavoista rakentaa vetureita, vaunuja, ratajärjestelmiä jne.

Kirjan pääosa käsittelee 12 V junia ja pienempi osa 4,5 V junia. Älä kuitenkaan ota tätä jakoa liian vakavasti. Voit varmasti löytää molemmista jaksoista paljon mielenkiintoista riippumatta siitä, minkälainen juna Sinulla on.

Sinulla ei ehkä ole aivan kaikkia elementtejä, joita erillisissä rakenne-ehdotuksissa on käytetty. Älä kuitenkaan luovu, vaan käytä mielikuvitustasi. Voit varmasti lähes kaikissa tapauksissa rakentaa mallit sen verran muunneltuina, että omat elementtisi riittävät.

Hyvää junamatkaa!



Der große Vorzug des LEGO® Eisenbahn-Programms ist, daß die Züge auf so vielfältige Art gebaut werden können. Dieses Buch bietet Dir jede Menge Ideen, wie Du Lokomotiven, Waggons, Schienen – und natürlich auch die Umgebung – zusammenbauen kannst.

Der Hauptteil des Buches beschäftigt sich mit dem 12 Volt Programm, der kleinere Teil gilt dem 4.5 Volt Programm. Du kannst Ideen und Anregungen aus beiden Teilen kombinieren. Darum spielt es auch keine Rolle, welches der beiden Programme Du hast.

Wahrscheinlich hast Du nicht alle LEGO Elemente, um die verschiedenen Modellvorstellungen zu verwirklichen. Wenn Du Deine Fantasie benutzt und ein wenig probierst, wirst Du bestimmt eine Möglichkeit finden, mit den bei Dir vorhandenen Steinen tolle Modelle zu bauen.



The great thing about LEGO® trains is that they can be built in many different ways. This book gives you lots of ideas for building locomotives, waggons, tracks – and settings.

The major part of the book deals with Electric trains and the remainder with Battery trains. But you are sure to get ideas from both sections – no matter which type of train you have.

You may not have exactly all the pieces used in the various model suggestions. Do not let that stop you. If you use your imagination, you will almost always be able to build the models in a slightly different way by using the bricks you already have. So be creative. Be inventive. And have fun.



Eén van de voordelen van de LEGO® treinen is, dat je alles steeds weer kunt veranderen. Dit boek laat zien, hoe je op verschillende manieren, lokomotieven, wagons, de spoorbaan en wat er allemaal nog meer bij hoort, op kunt bouwen.

De inhoud is voornamelijk gewijd aan de (12 Volt) elektrische LEGO treinen en verder aan de batterij-treinen. Maar je kunt – welke LEGO trein je zelf ook hebt – uit beide soorten vast en zeker veel nieuwe ideeën op doen.

Je hoeft echt niet alle onderdelen te hebben, welke in de verschillende modellen gebruikt worden. Als je je fantasie gebruikt, zul je bijna altijd in staat zijn, om de voorbeelden (misschien een beetje anders) met onderdelen uit je eigen LEGO verzameling na te bouwen.



L'avantage du train LEGO® c'est de pouvoir le construire de plusieurs façons différentes. Dans ce livre, vous trouverez des idées de constructions pour faire différentes sortes de locomotives, wagons, circuits ...

Il y a des idées pour les trains 12 volts sur transformateur et pour les trains 4,5 volts à piles et très souvent elles sont valables pour les 2 types de trains.

Vous n'avez peut-être pas tous les éléments pour réaliser ces modèles, mais vous pourrez toujours en imaginer d'autres en utilisant les briques que vous possédez.



Il vantaggio principale dei treni della LEGO® è che essi si possono costruire in molti modi diversi. Questo libro vi presenta molte idee per la costruzione di differenti modelli di vagoni, locomotive, circuiti ferroviari e del paesaggio circostante.

La maggior parte del libro si riferisce al treno da 12 V ed il resto presenta il treno a pila da 4.5 V. Ma non attenetevi rigidamente a questa divisione. Potrete infatti attingere interessanti idee da entrambe le sezioni, qualunque sia il treno che possedete.

Potreste anche non disporre esattamente di tutti i pezzi necessari per costruire i modelli. Questo non vi deve arrestare! Con un po' di fantasia potrete realizzare gli stessi modelli sia pure con qualche piccola modifica, usando i pezzi che già possedete.



La ventaja de los trenes LEGO® es que se pueden construir de muchas formas distintas. En este libro encontrarás un montón de ideas para formas diversas de construir locomotoras, vagones de pasajeros, vagones de mercancías y también alrededores.

La mayor parte del libro está dedicada a trenes de 12 voltios y el resto a los de 4,5 voltios. Pero esto no significa que no puedas encontrar ideas en las dos secciones, sin importar el tipo de tren que tengas.

En algún caso, puede que no tengas todos los elementos necesarios para hacer un modelo. No te preocupes. Con tu imaginación podrás construir un modelo casi exactamente igual utilizando los elementos LEGO que ya tengas.

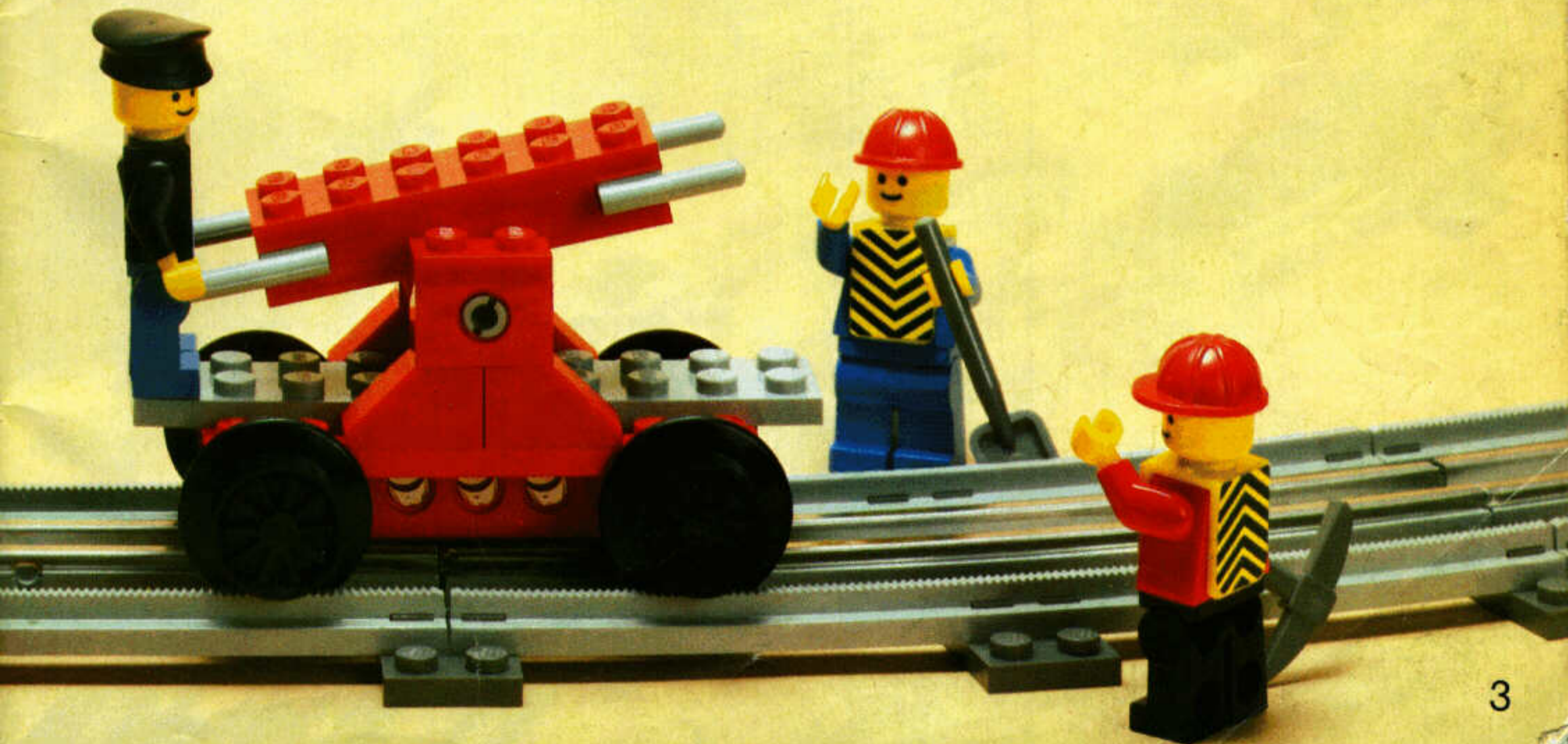
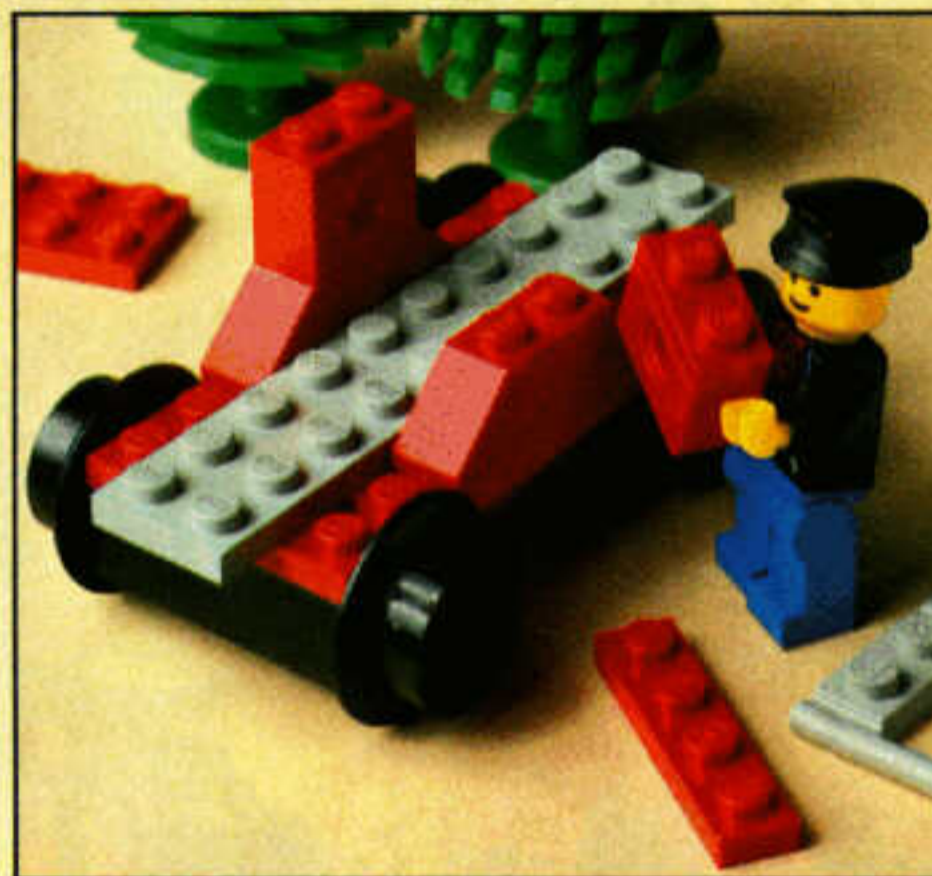
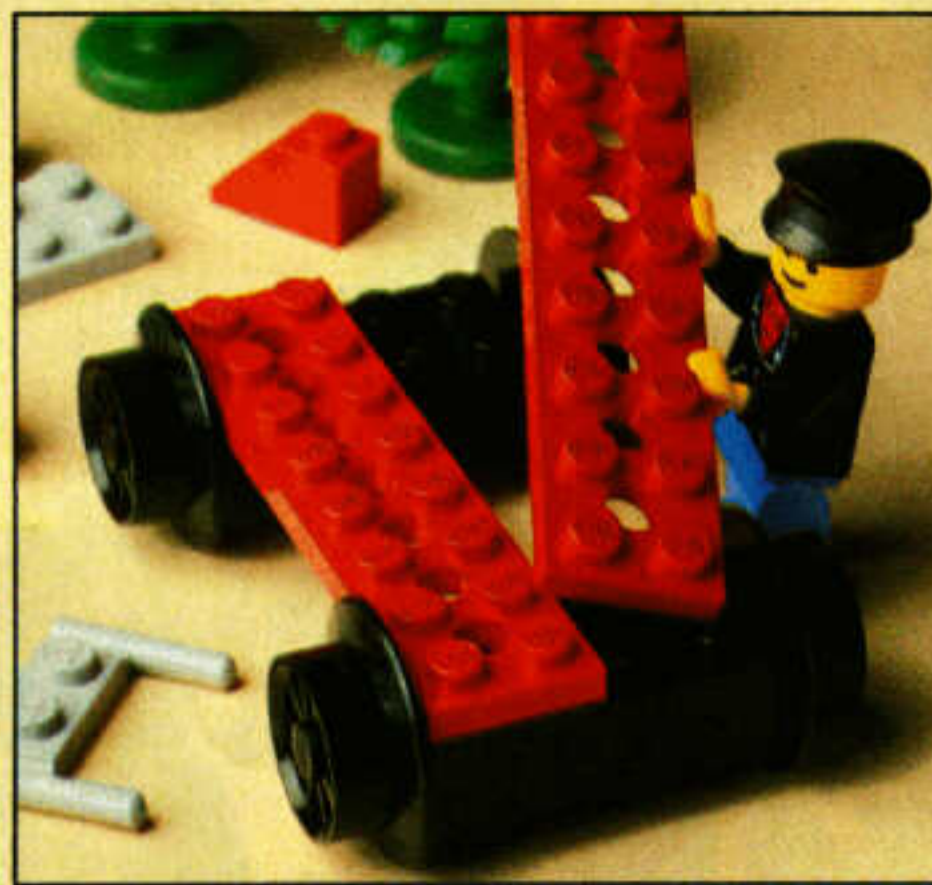





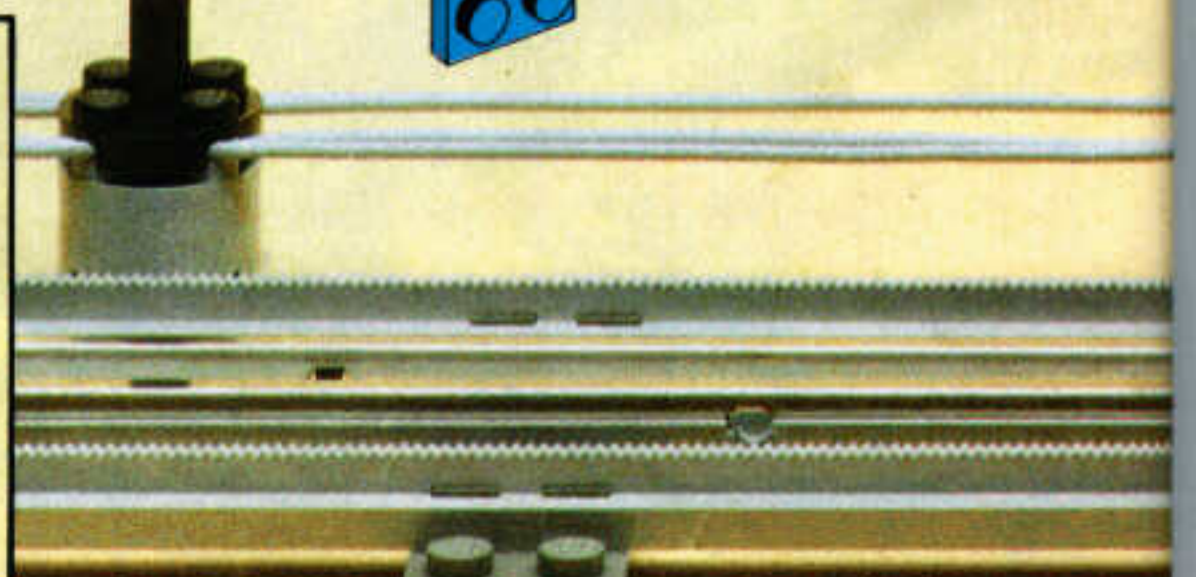
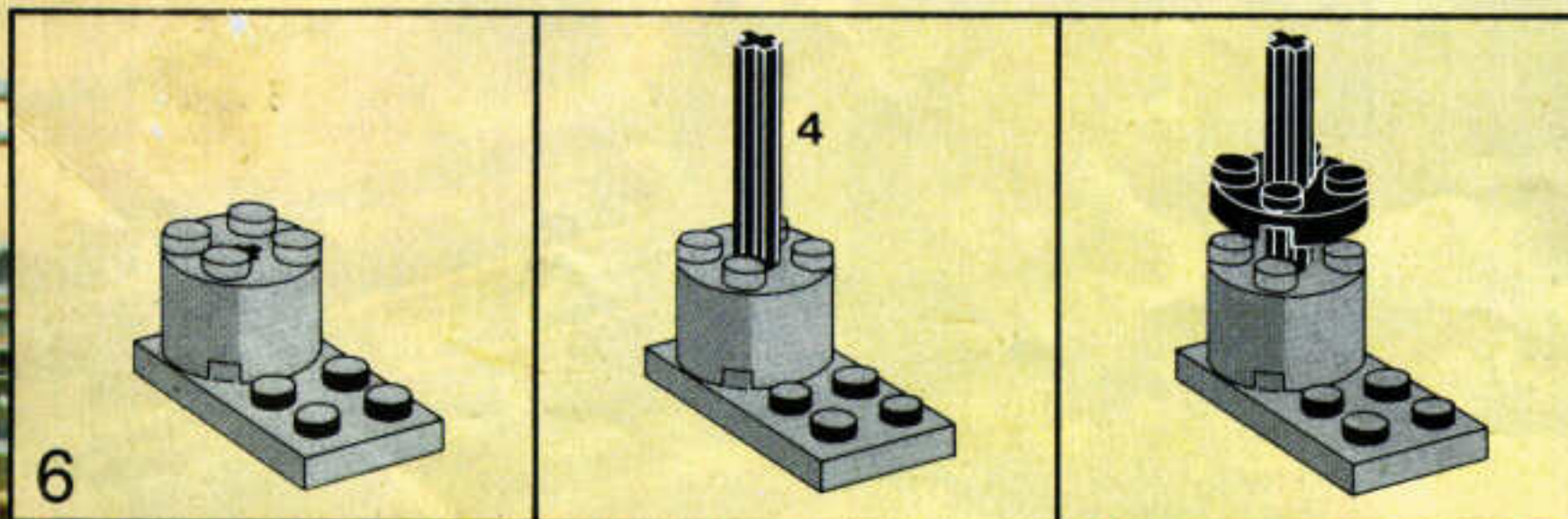
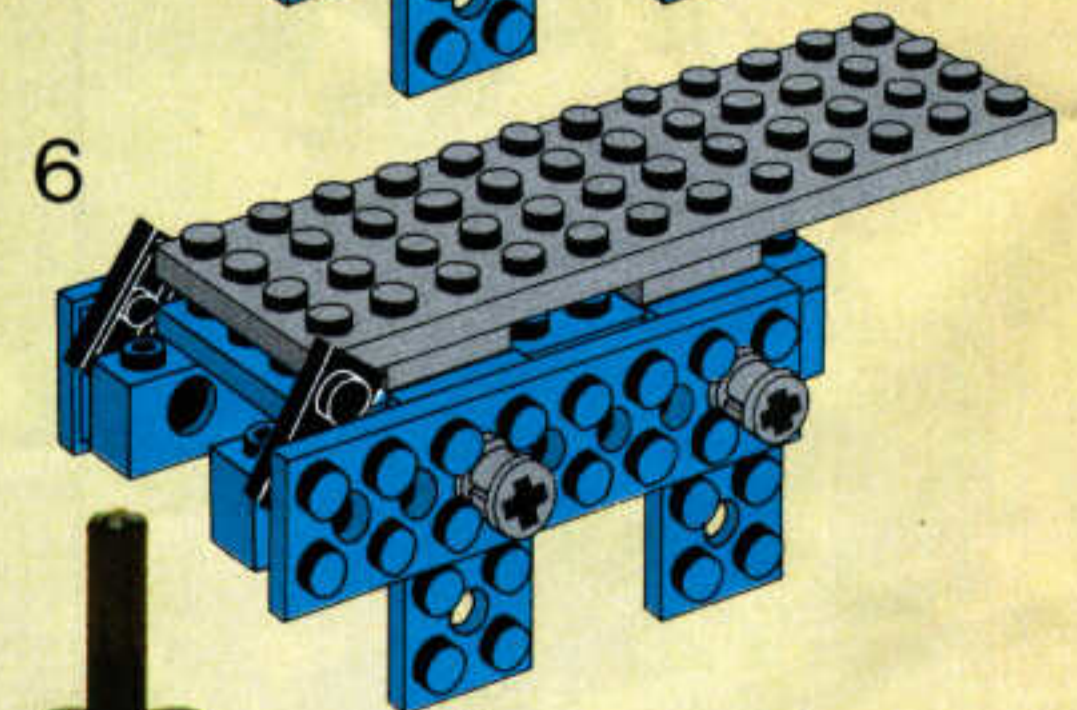
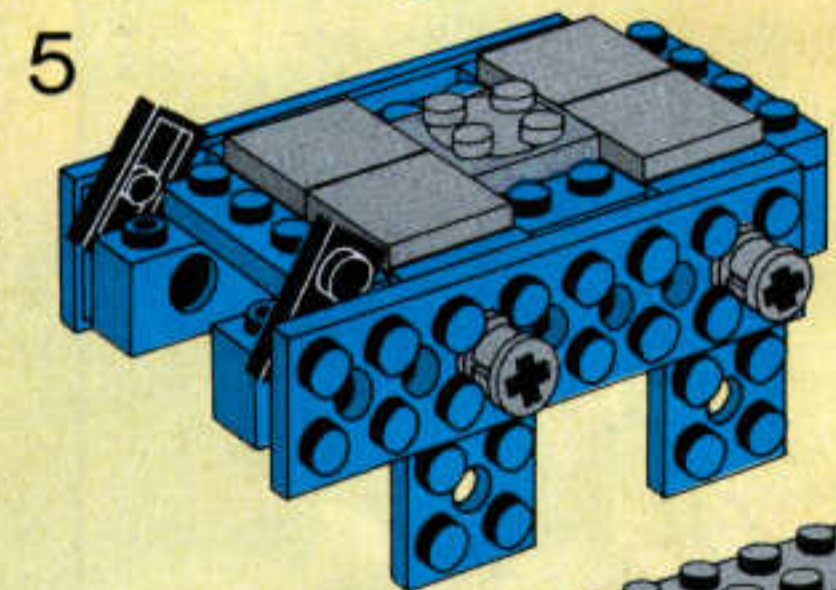
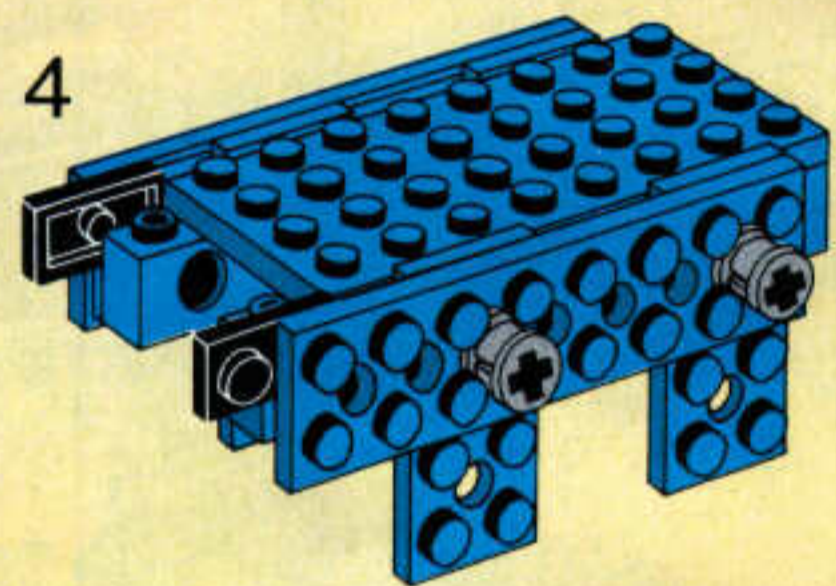
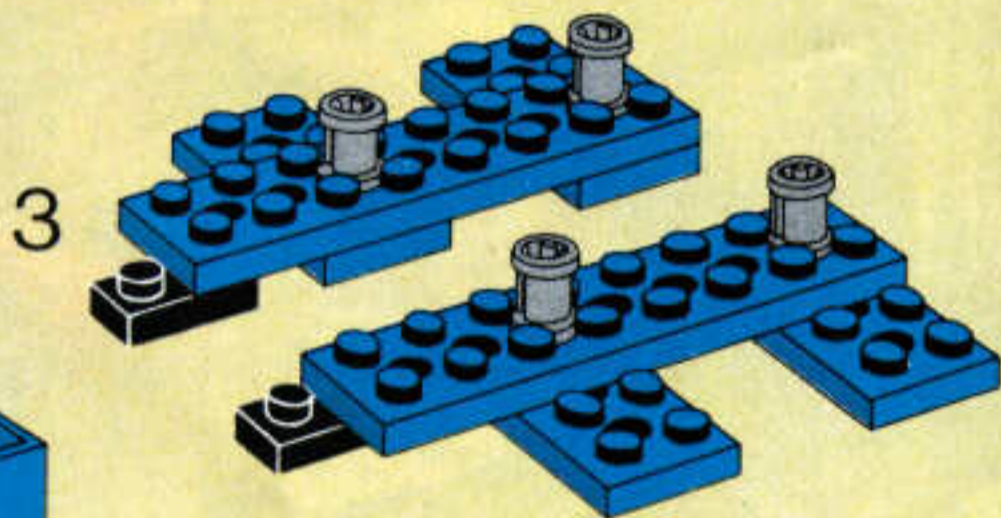
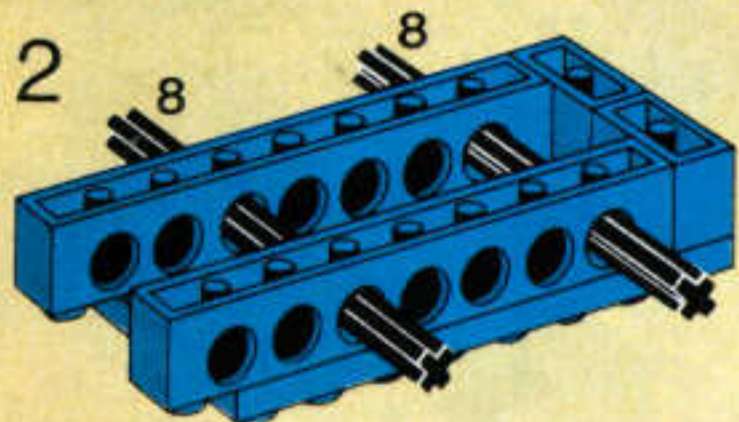
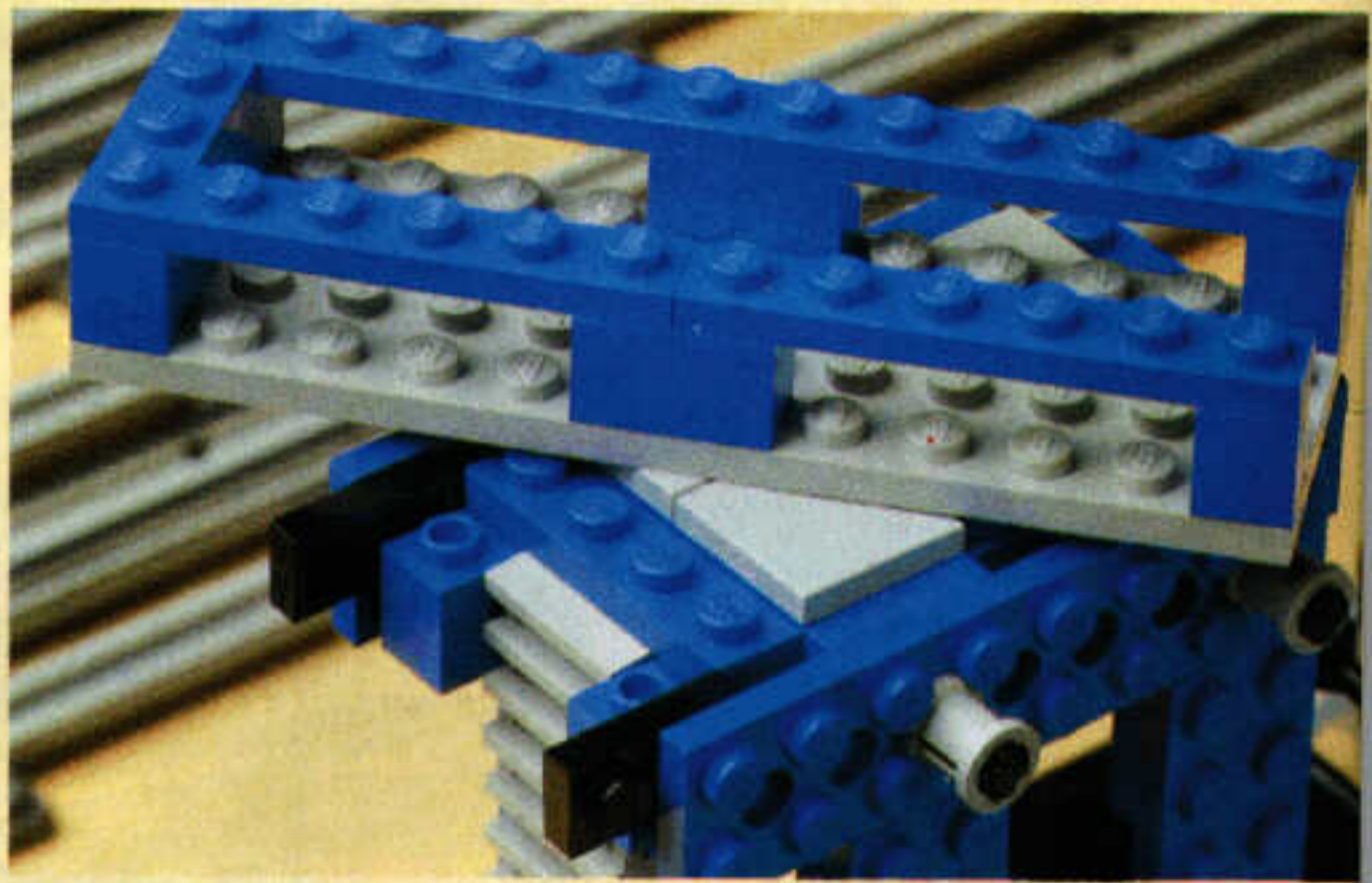
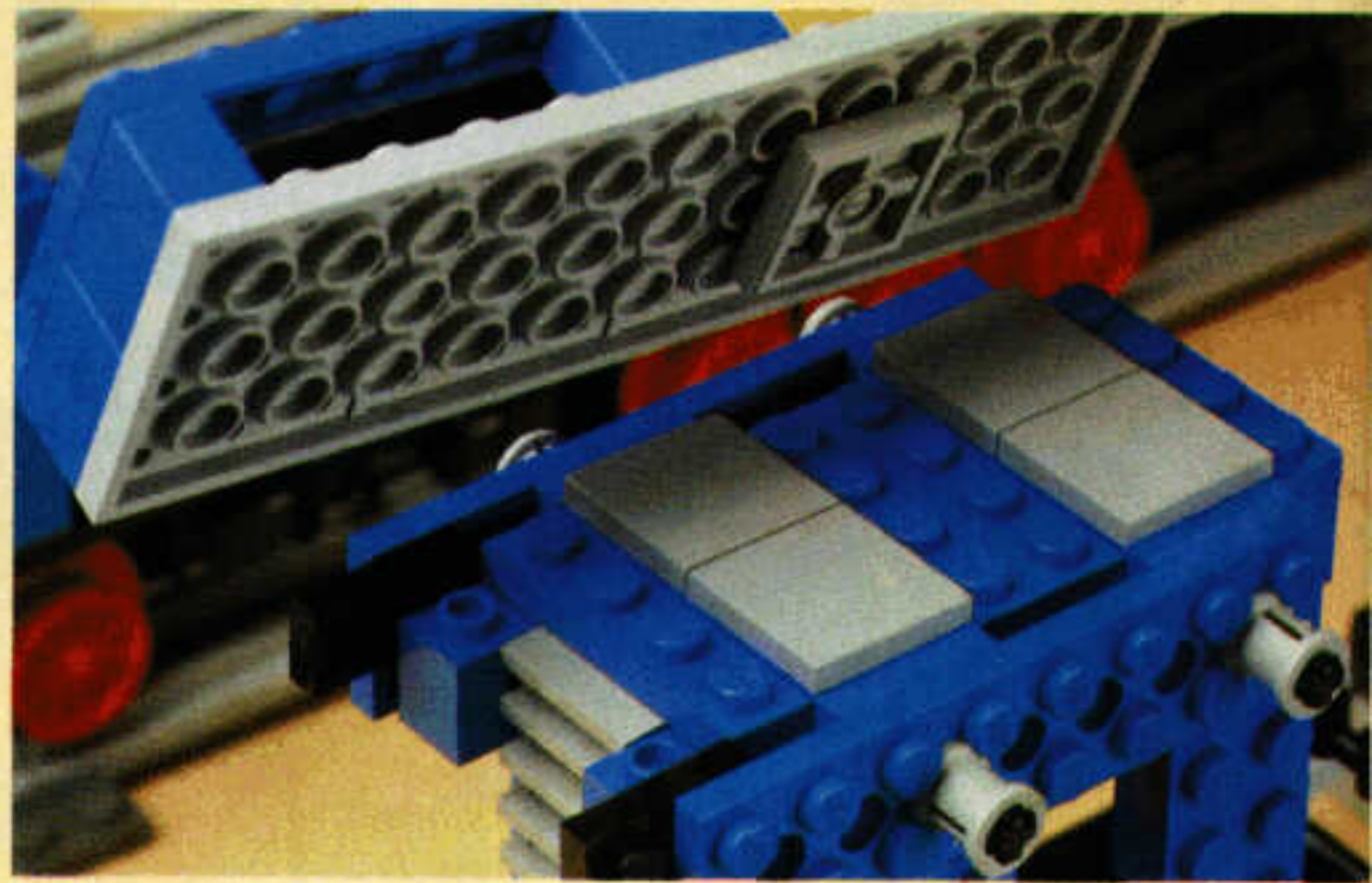
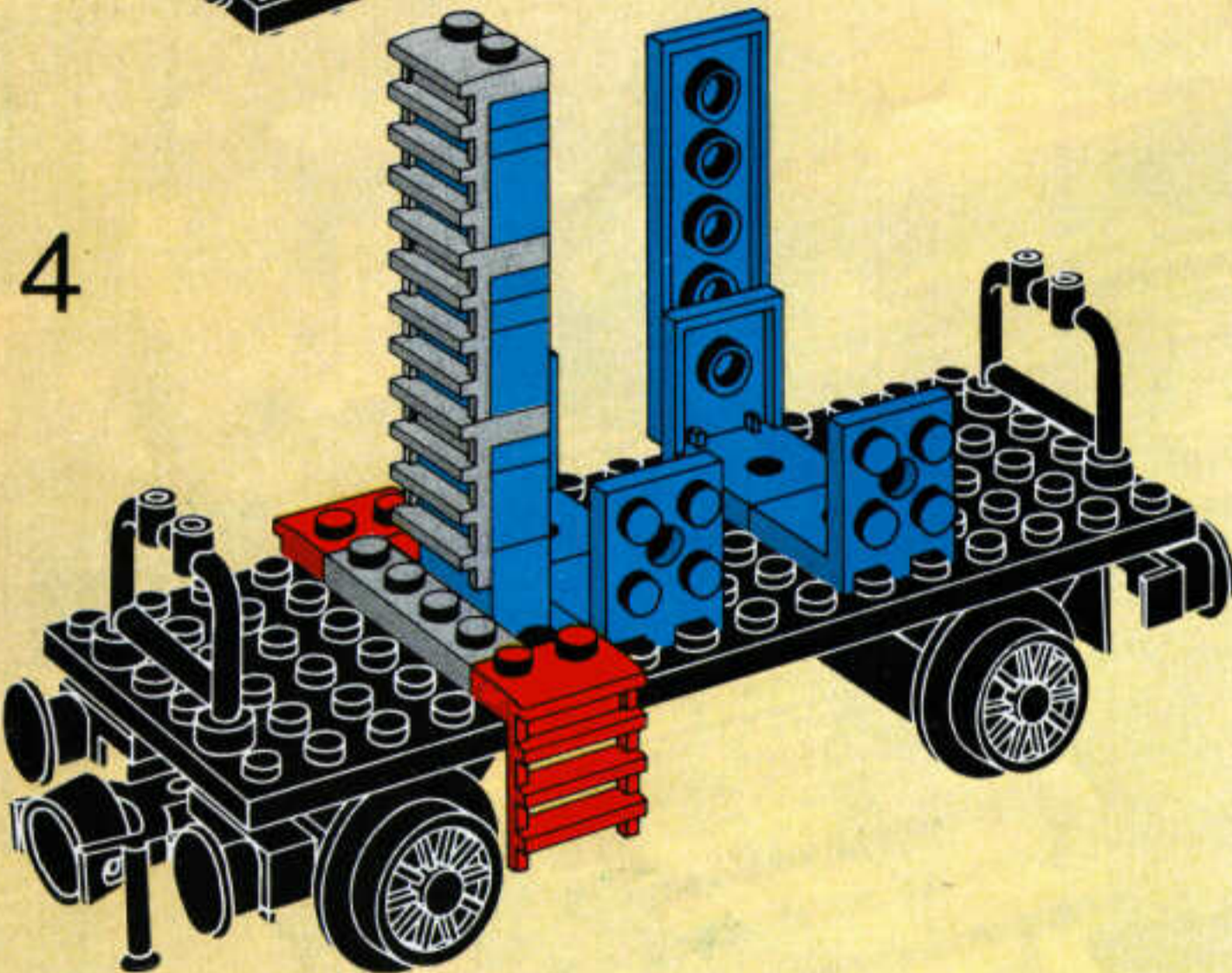
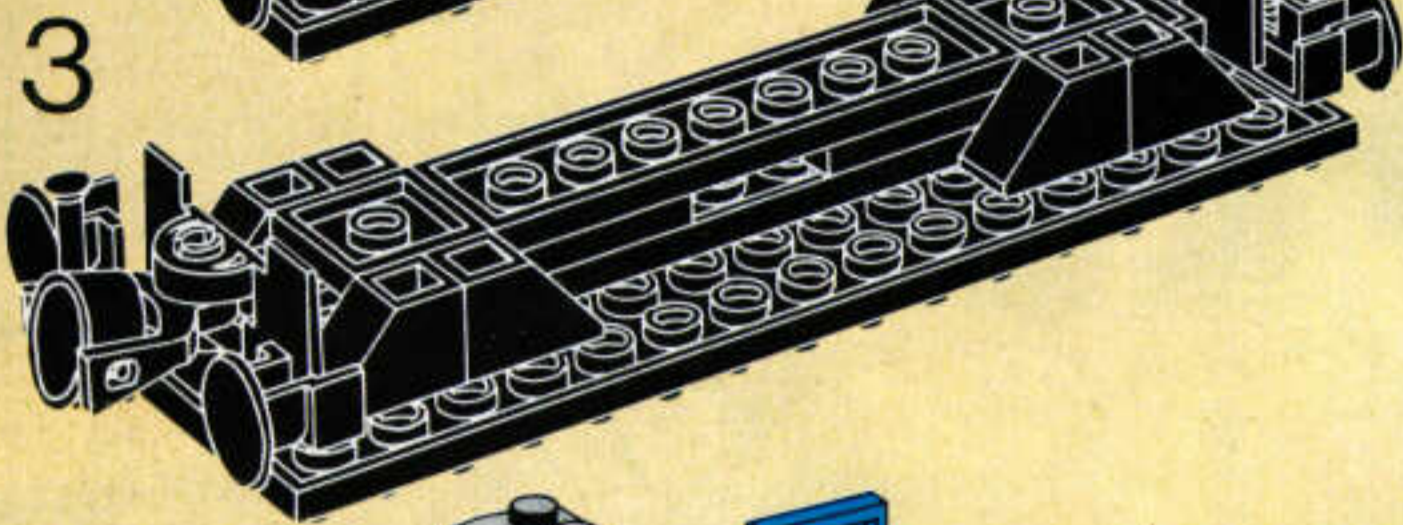
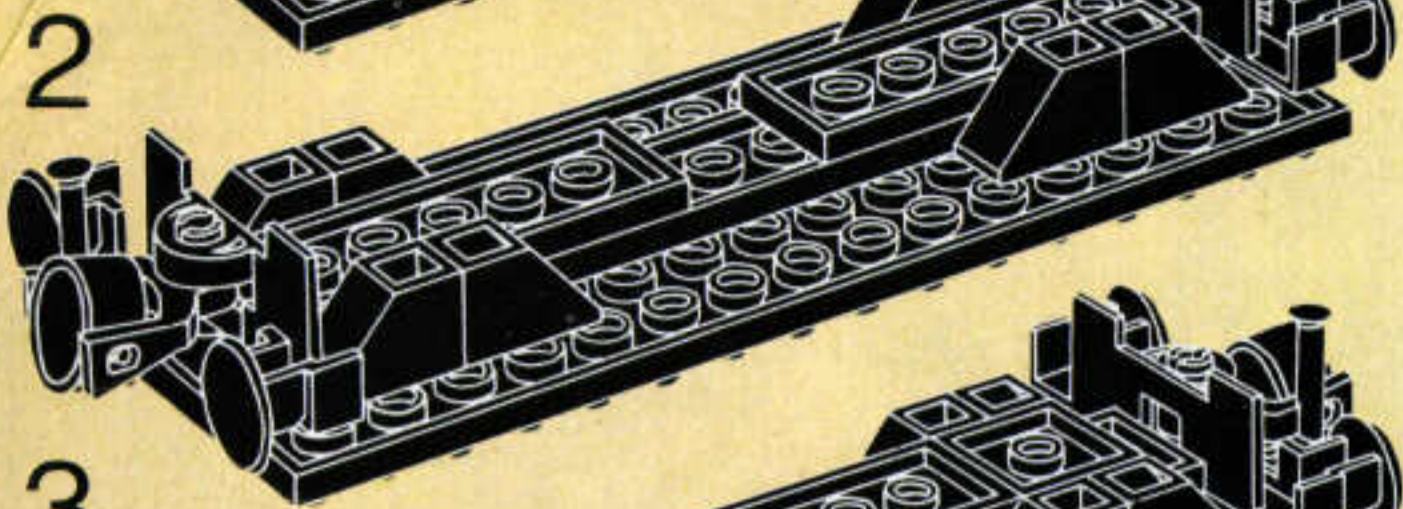
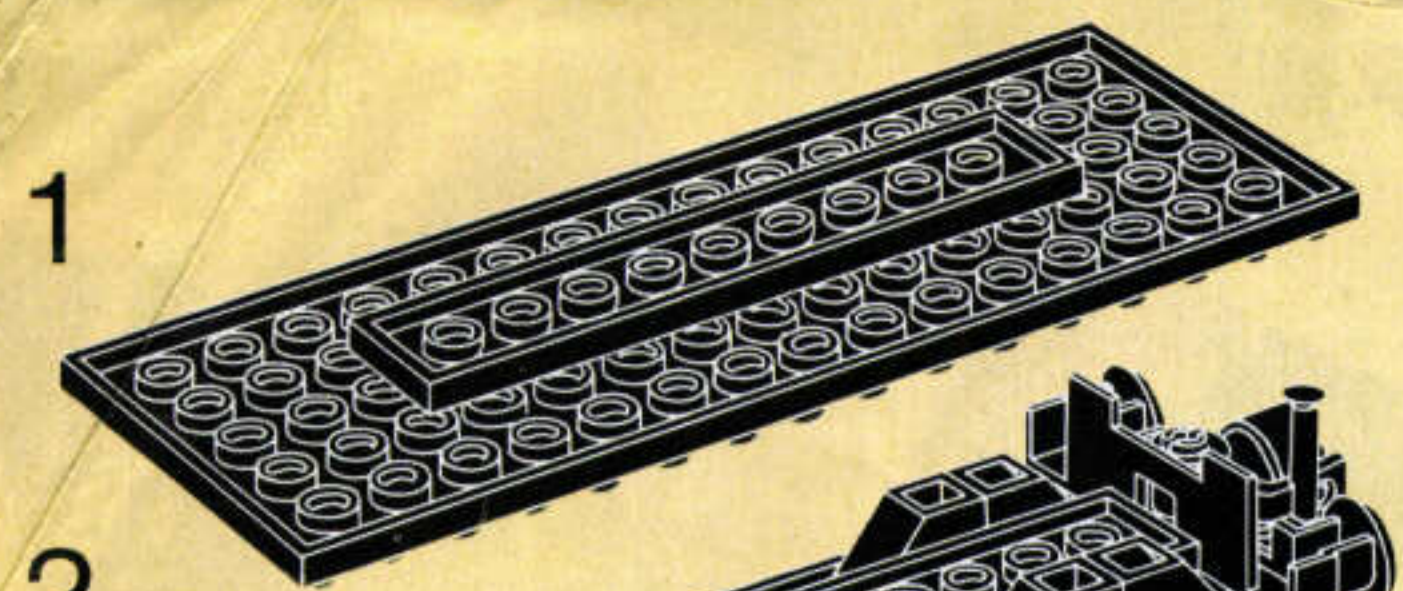

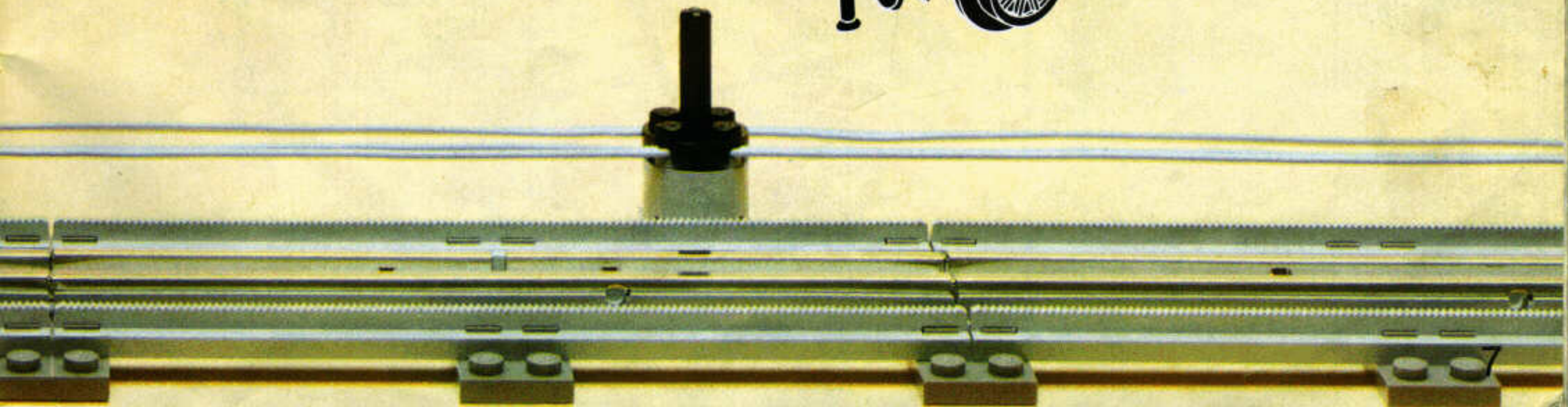
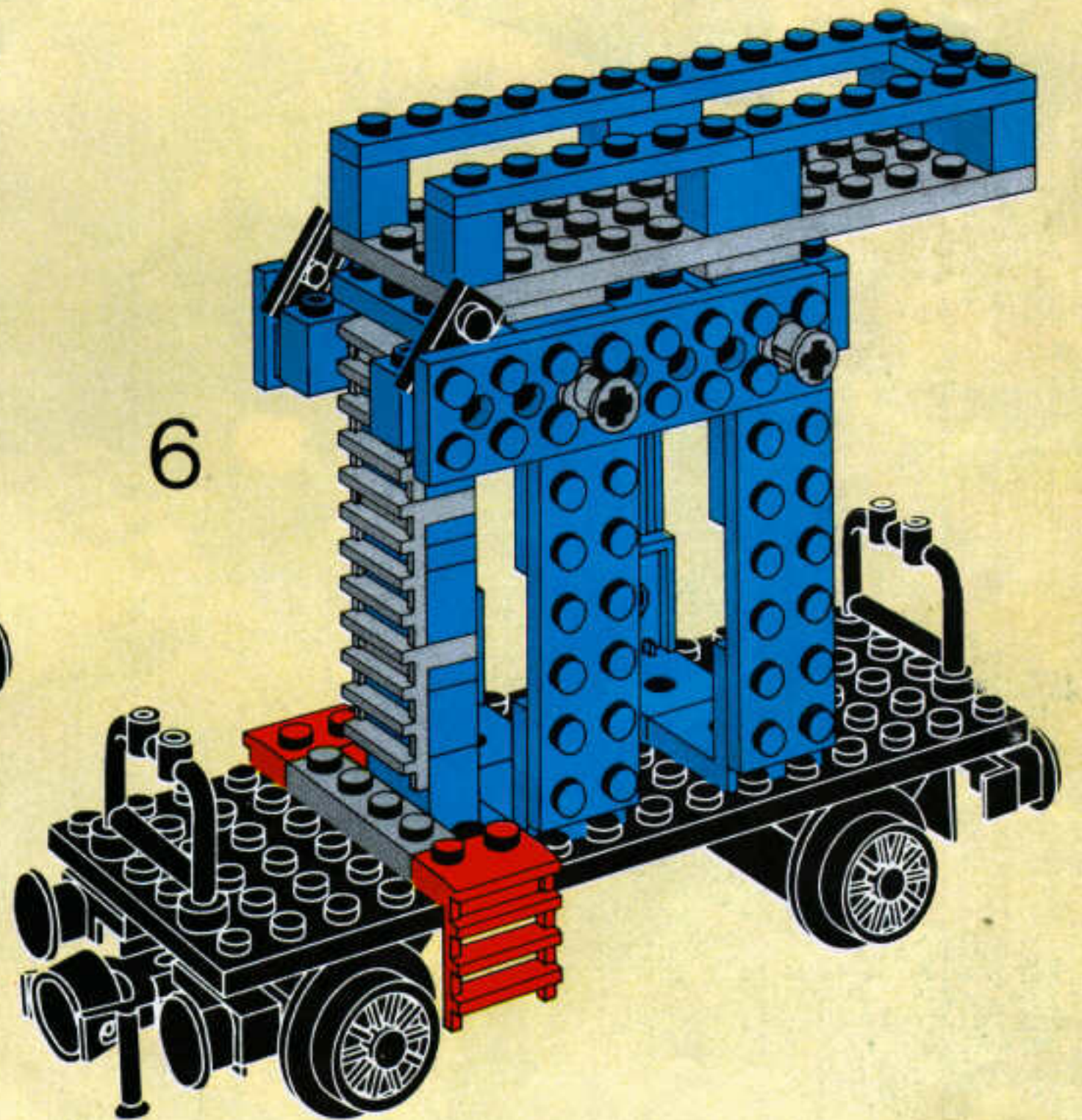
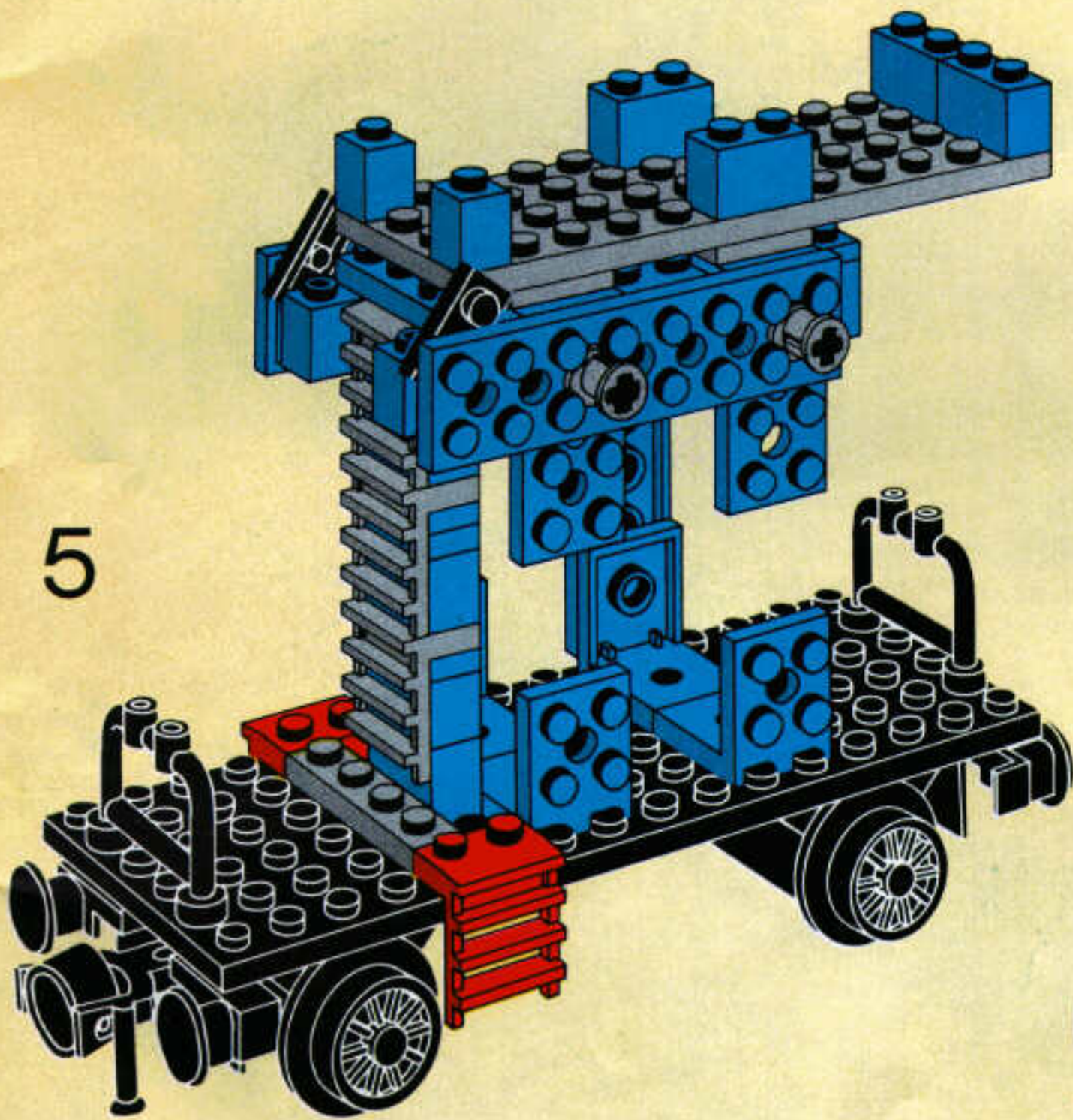
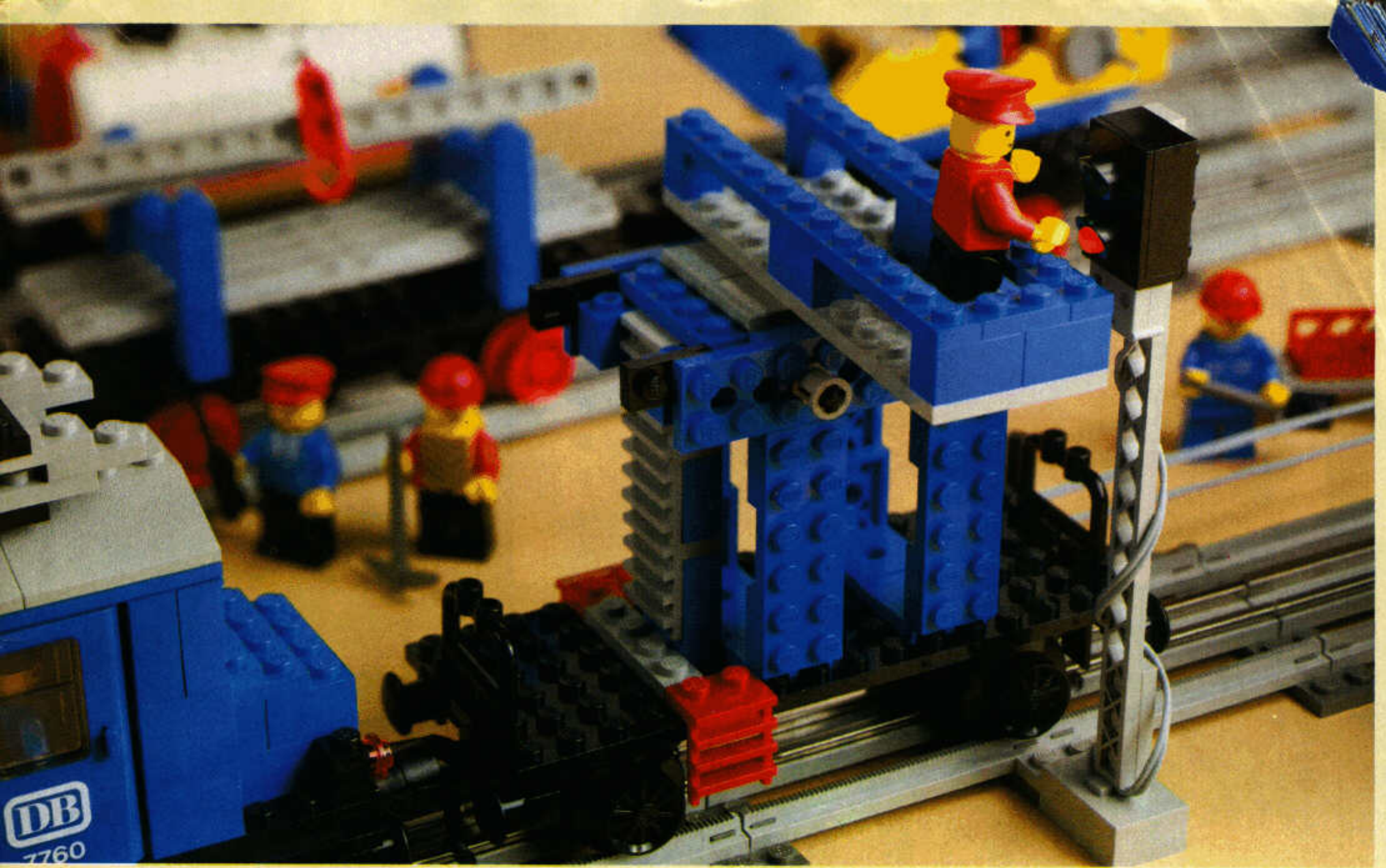

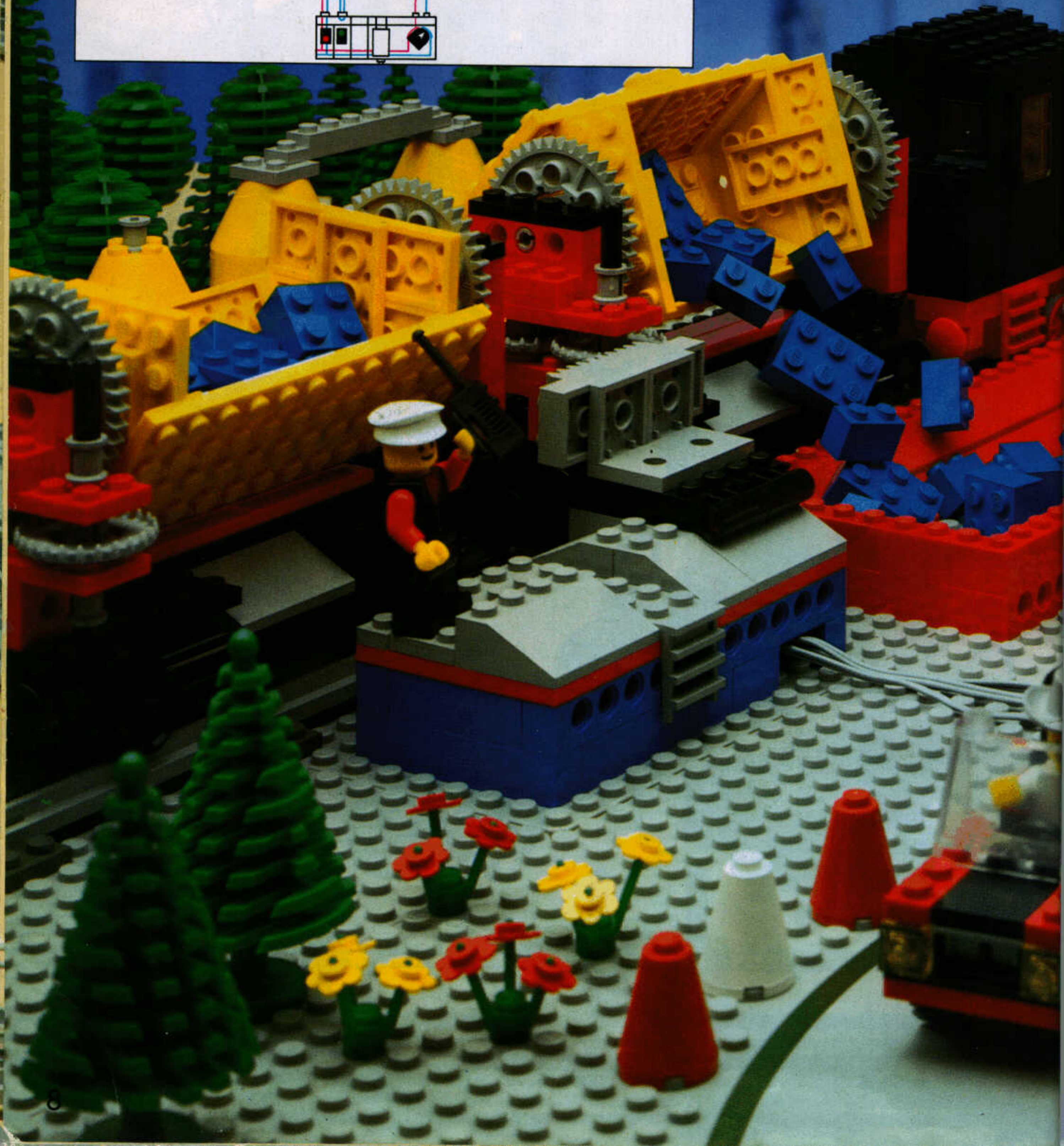
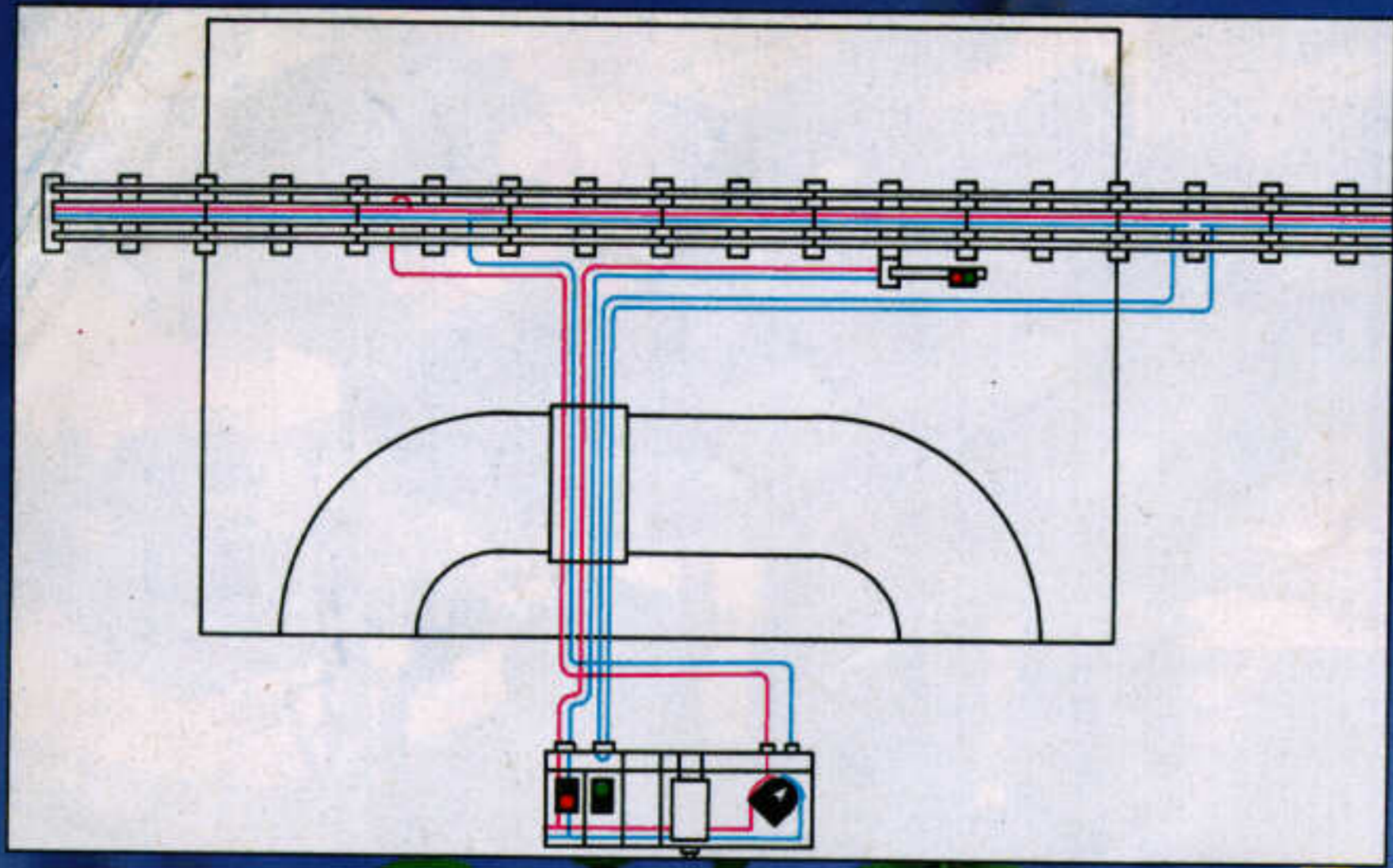





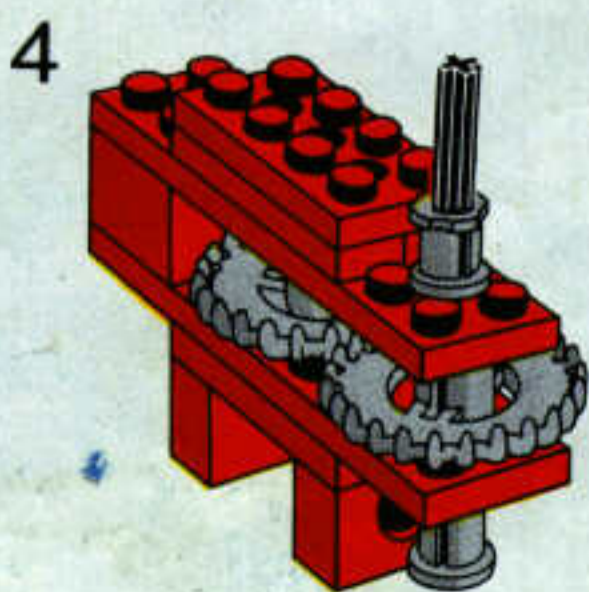
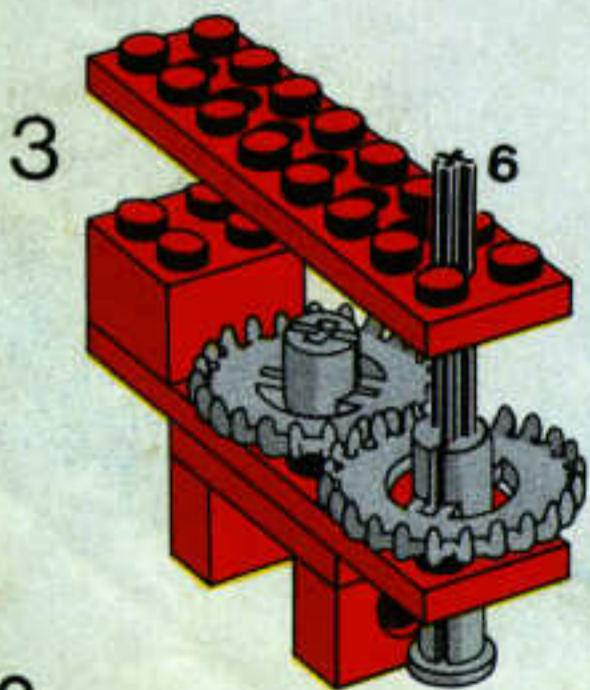
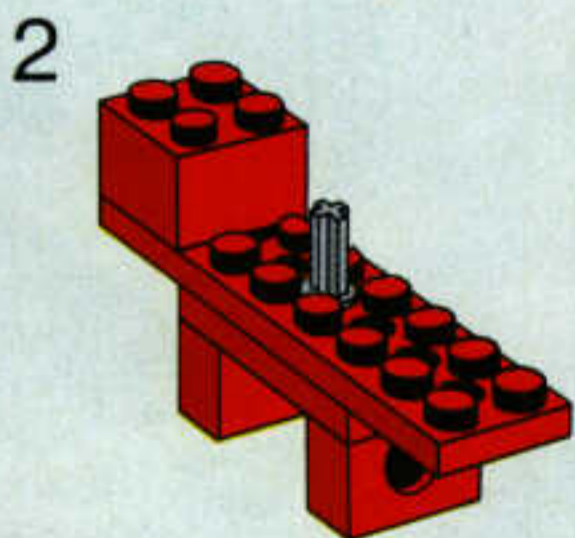
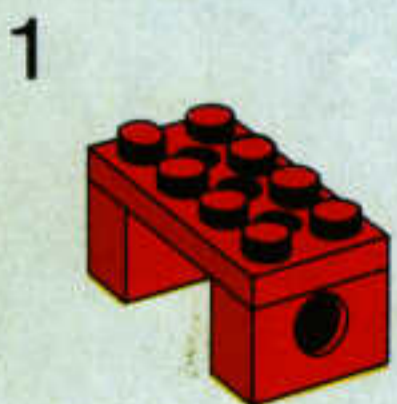
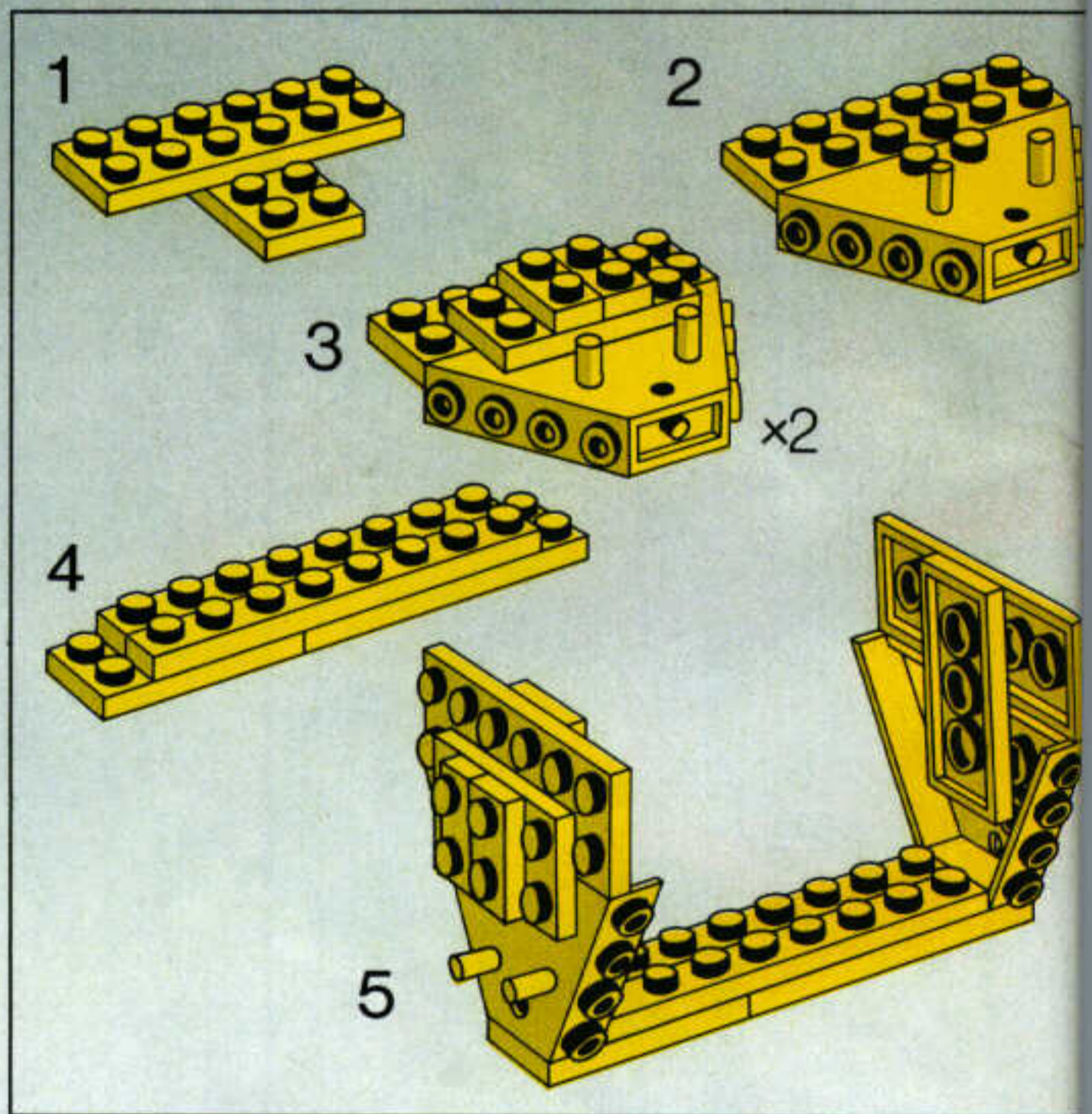
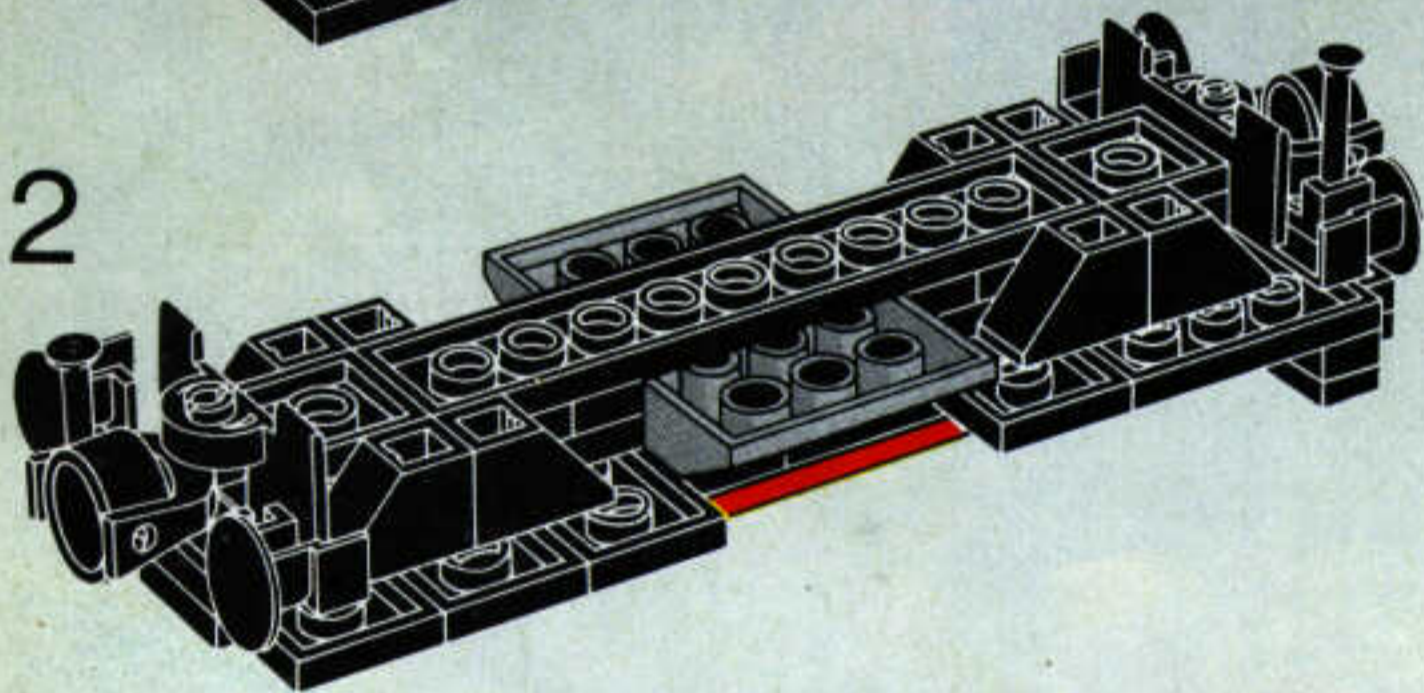
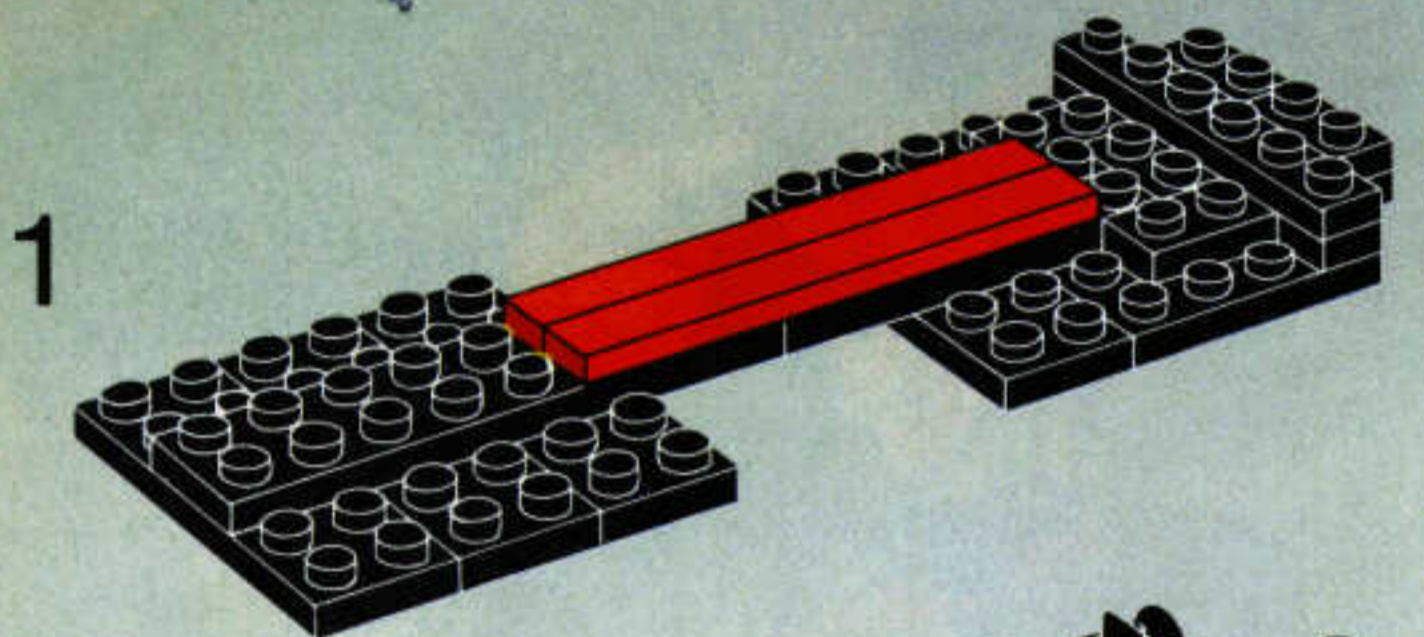
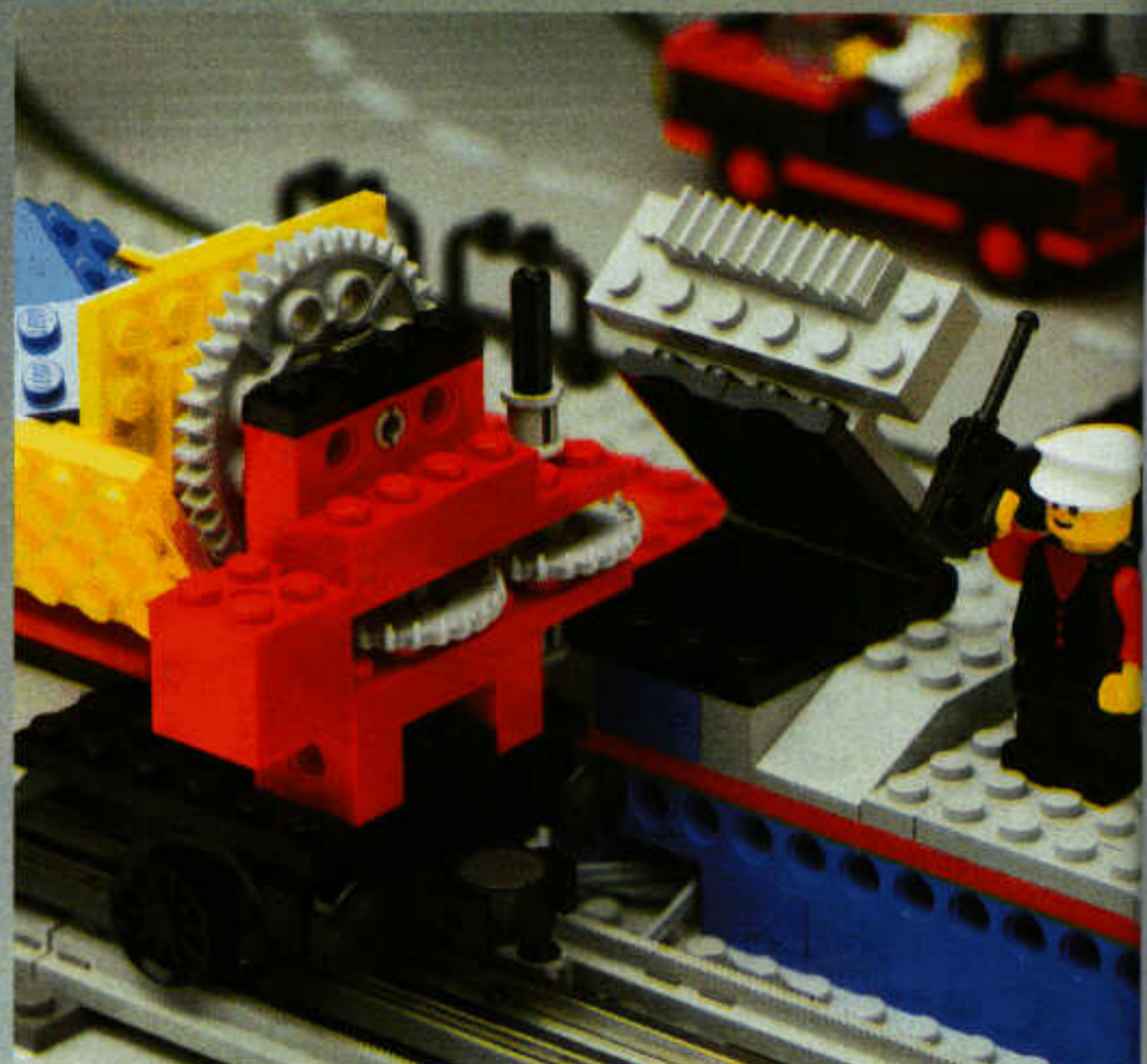
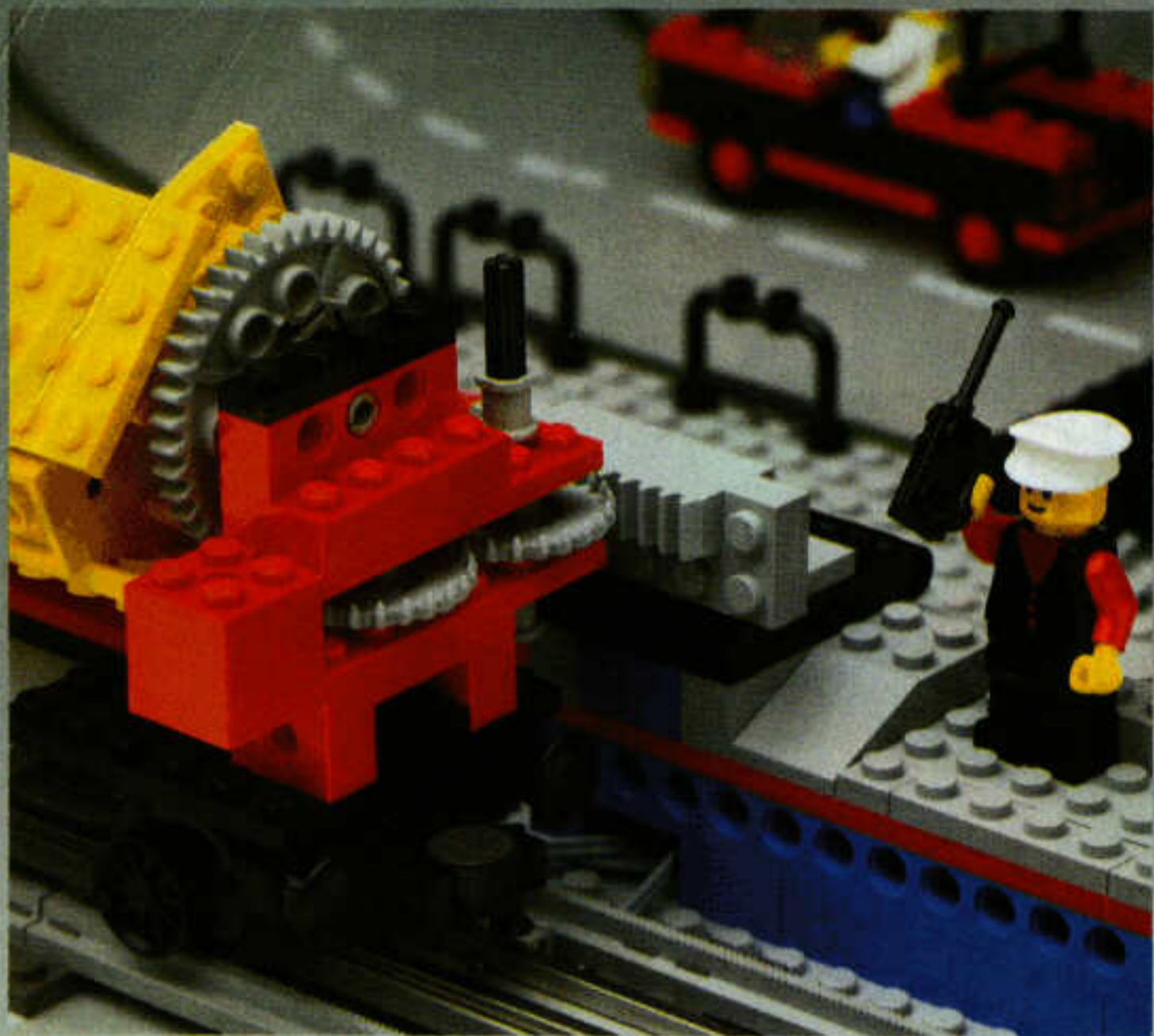

3

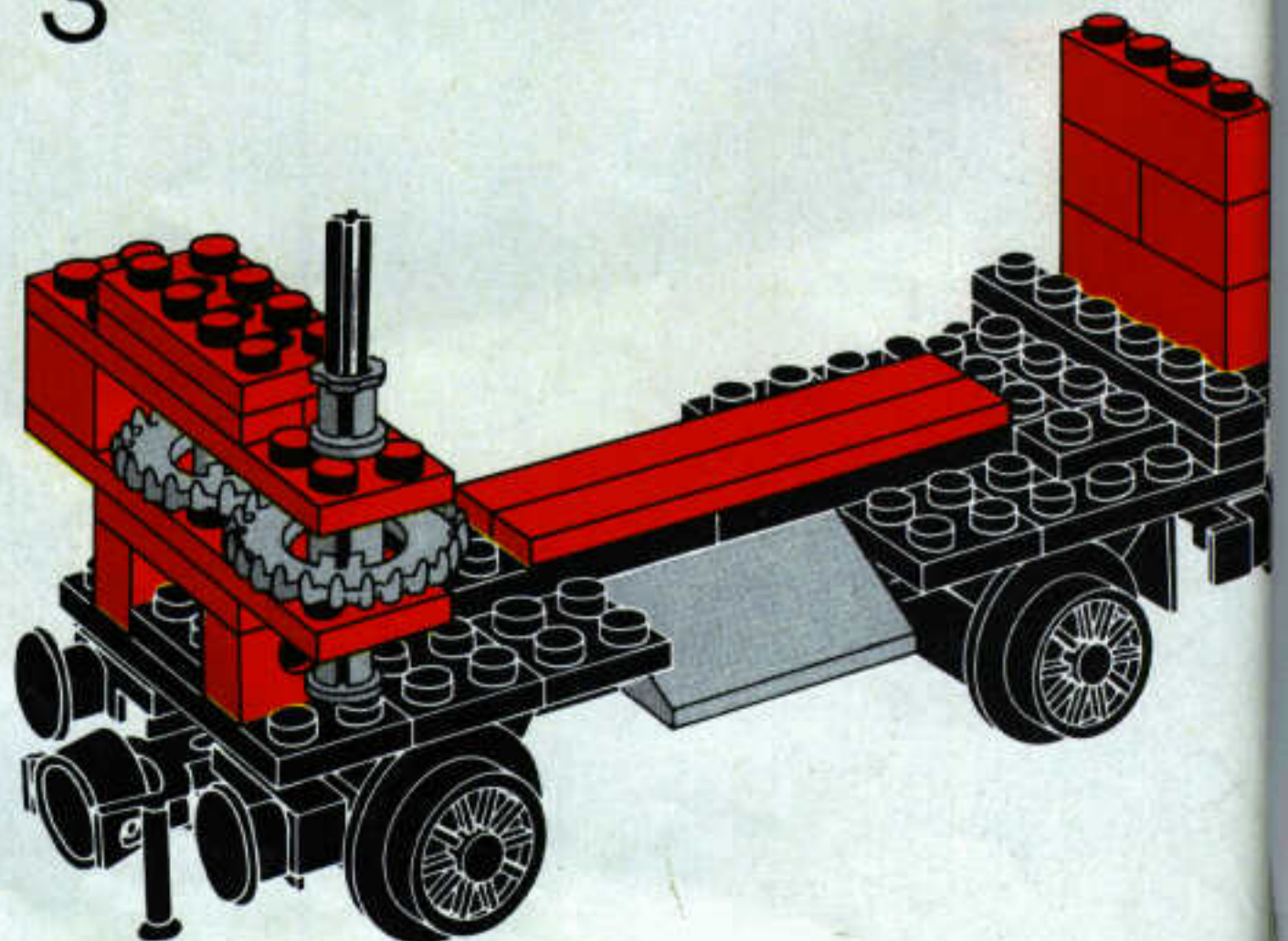

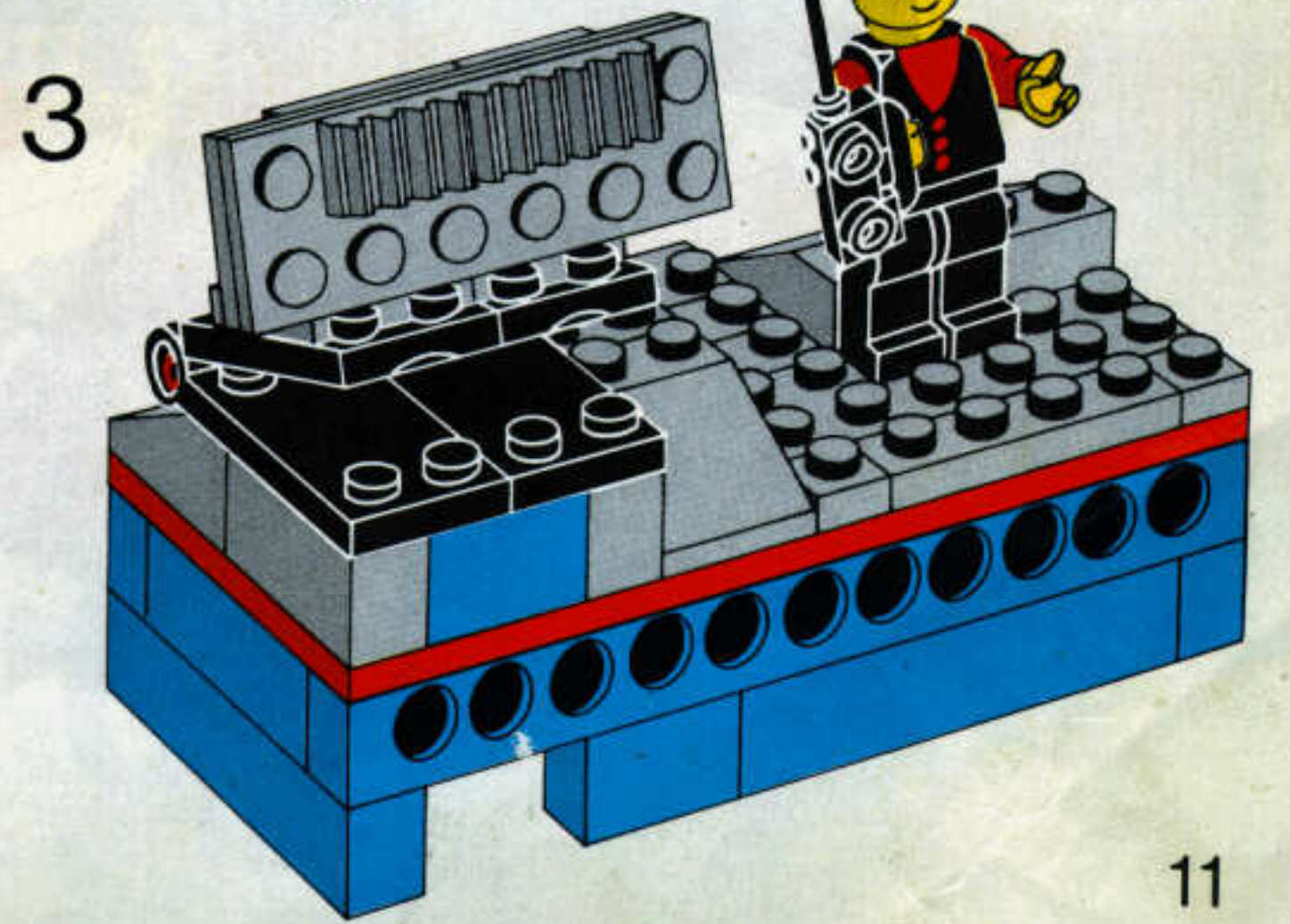
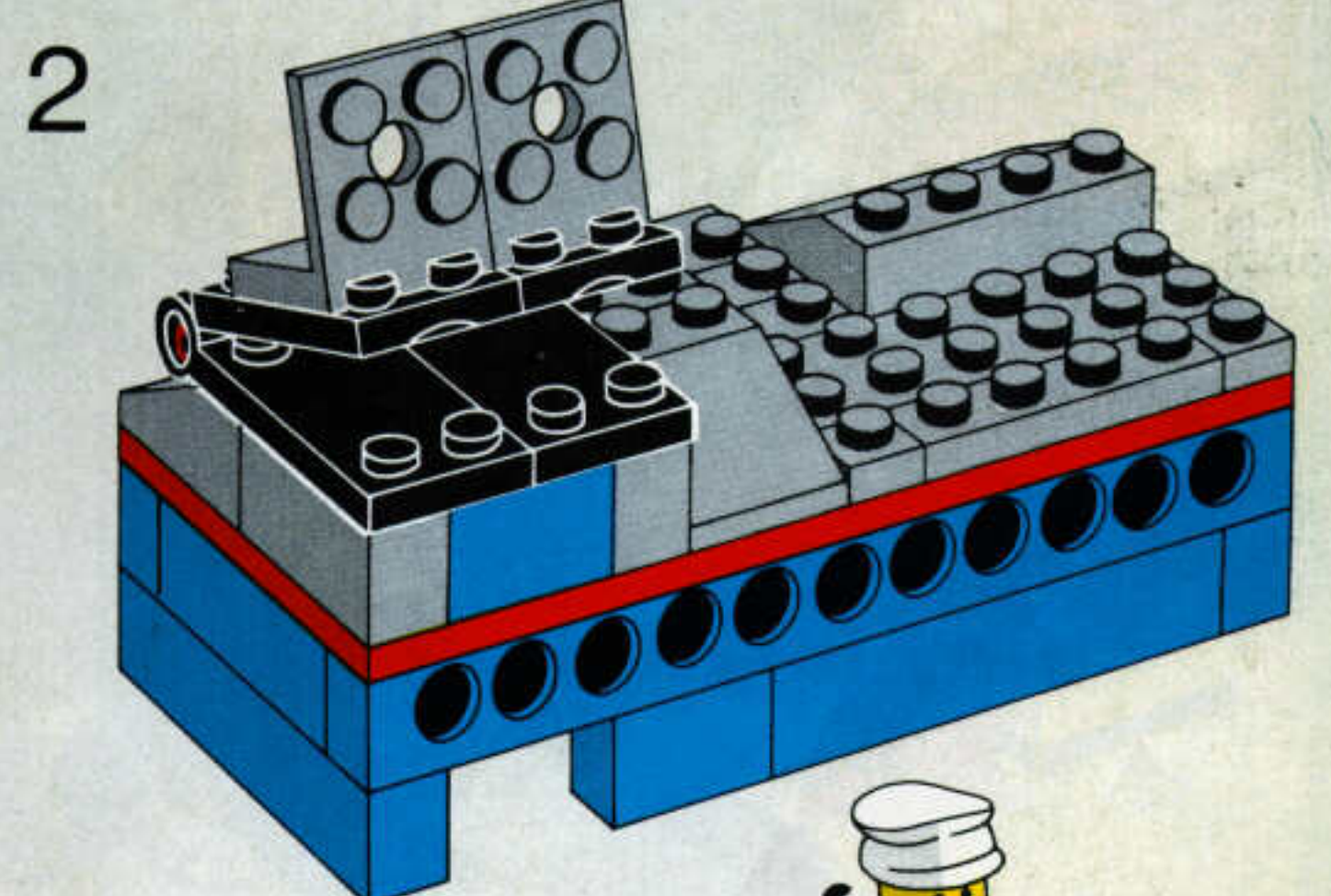
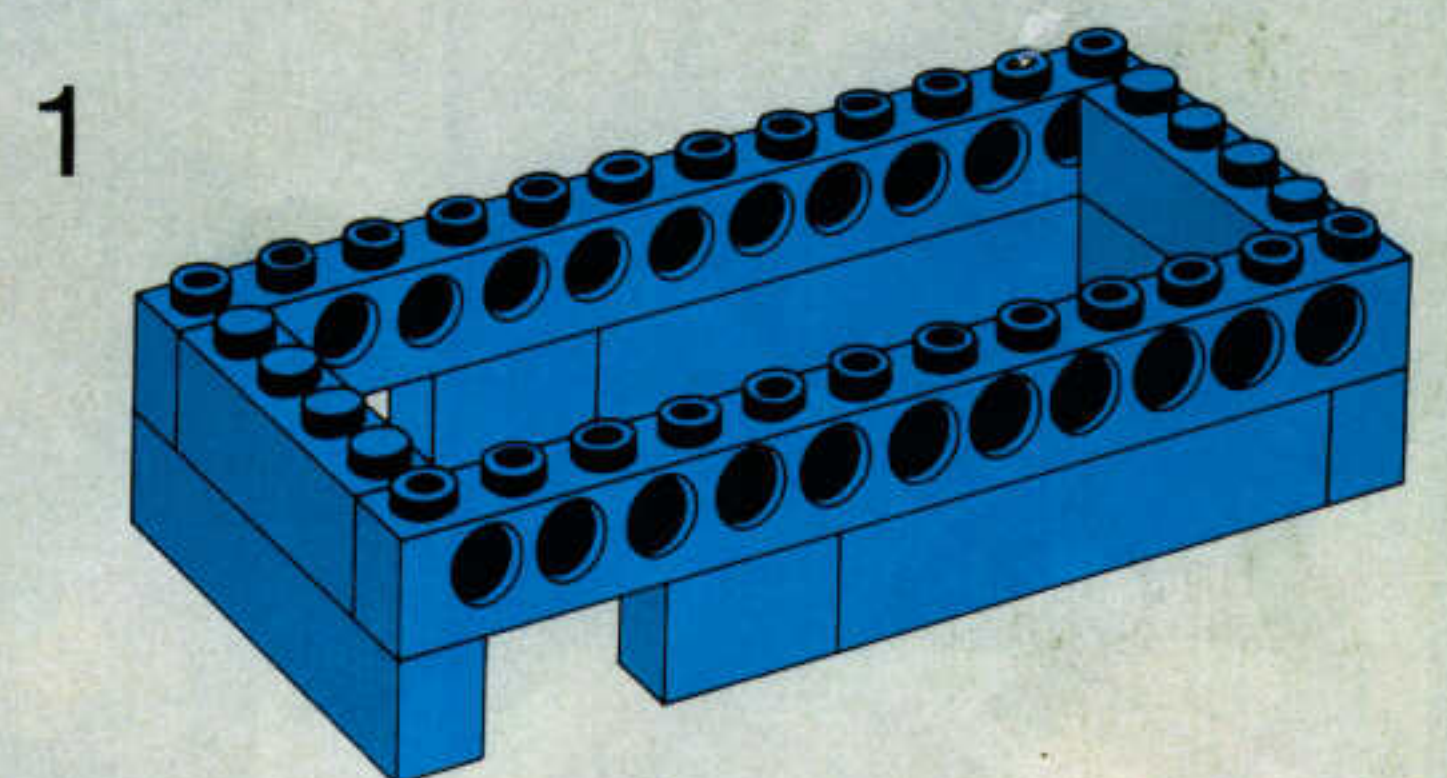
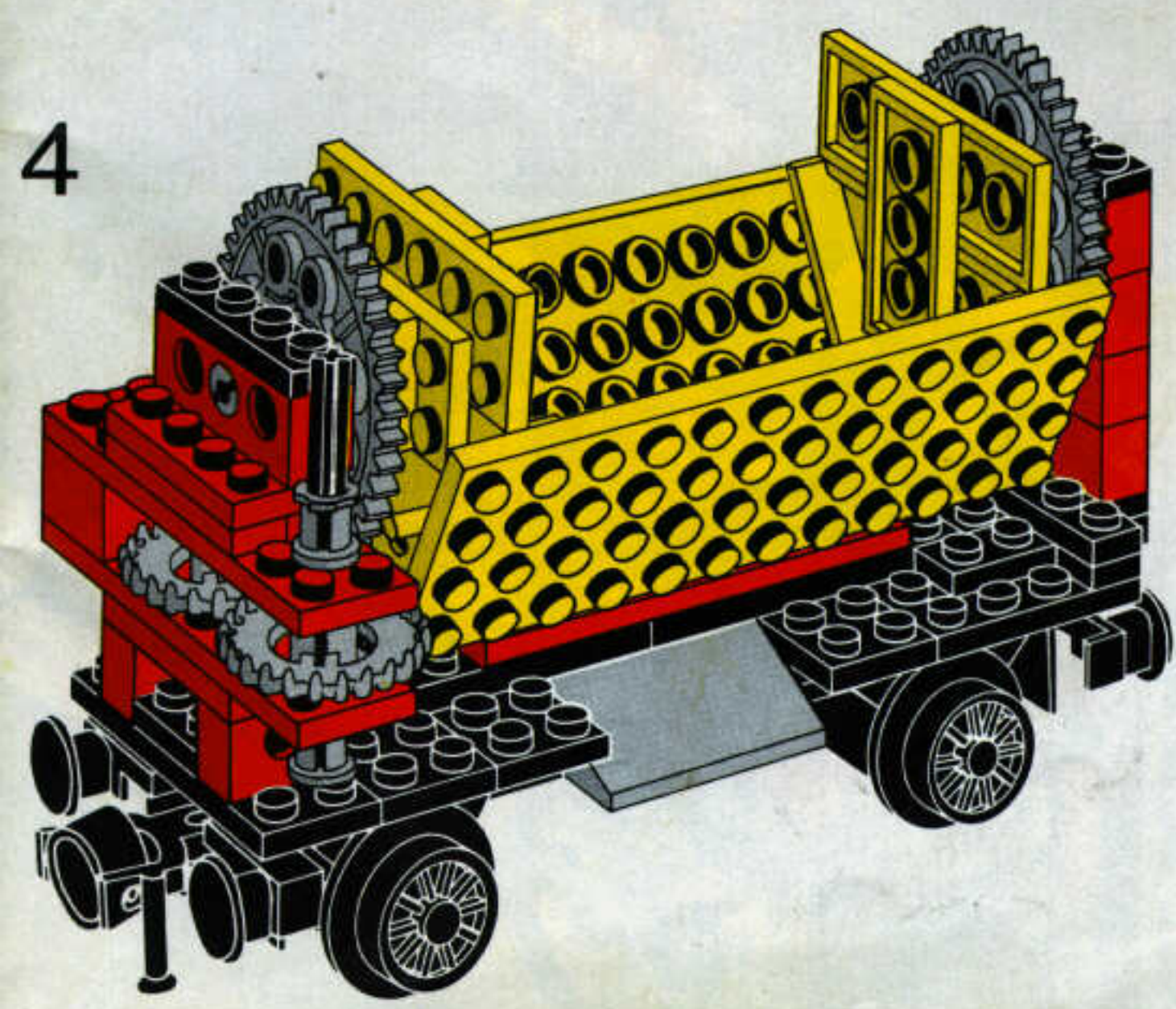
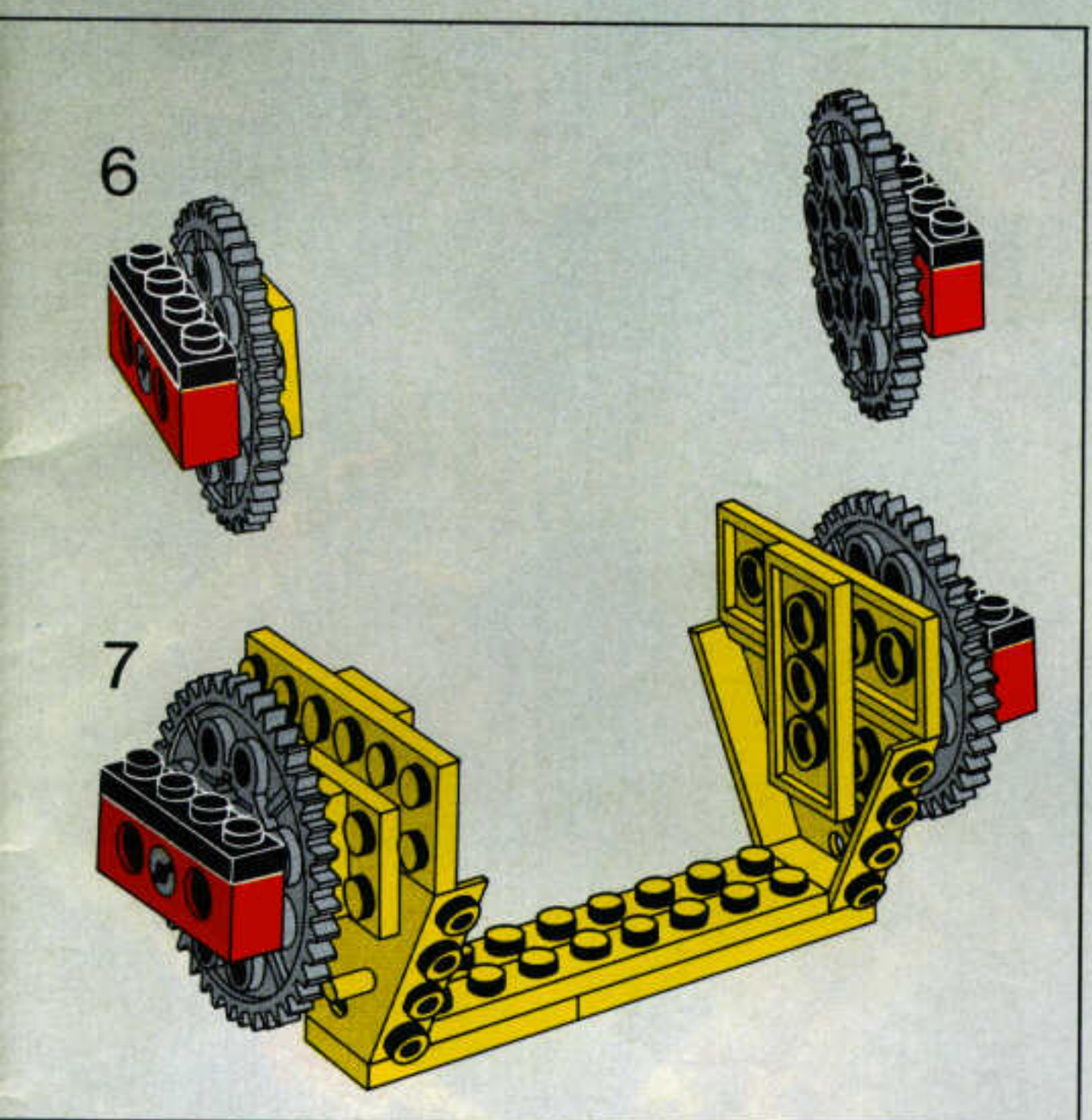
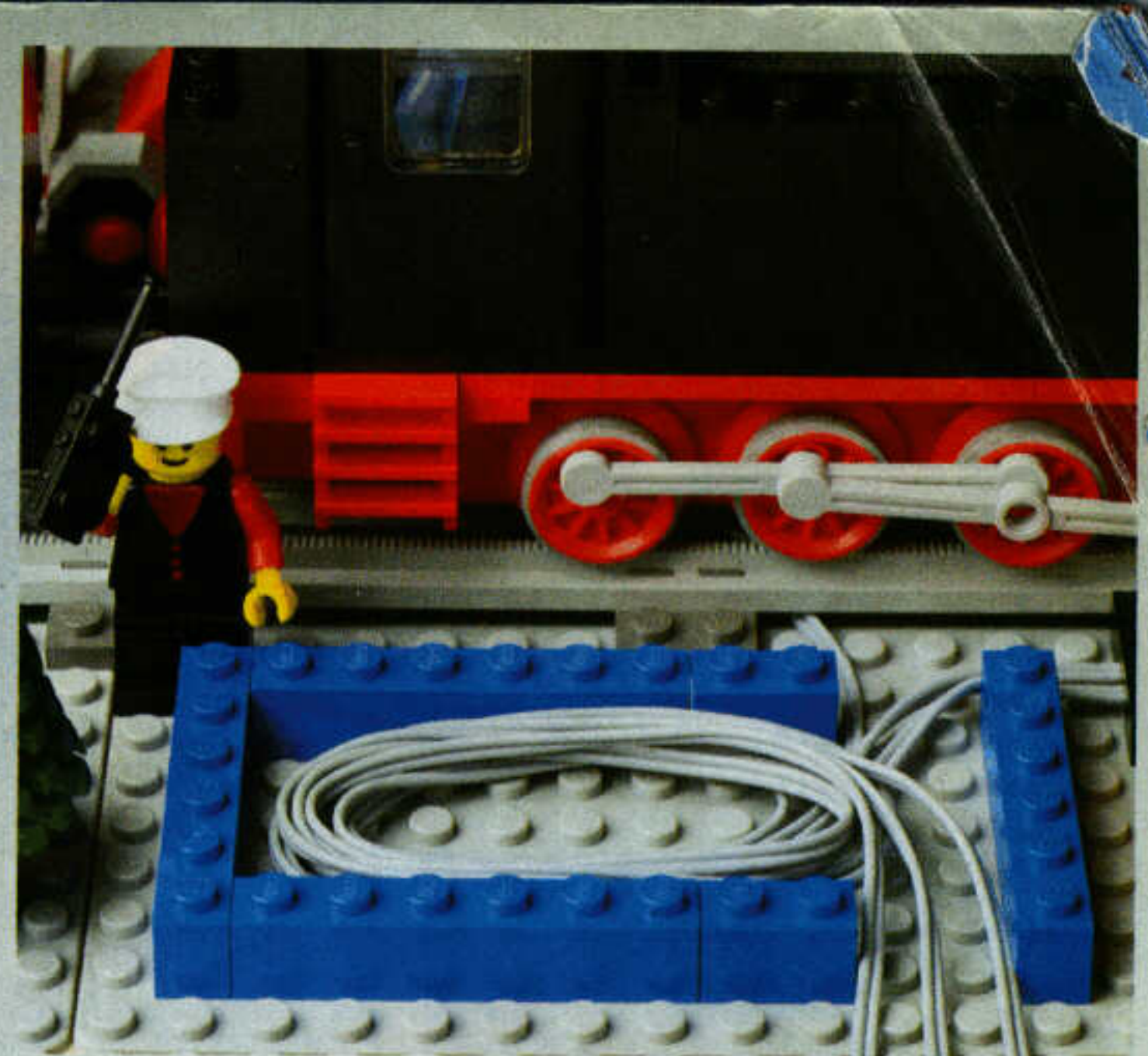
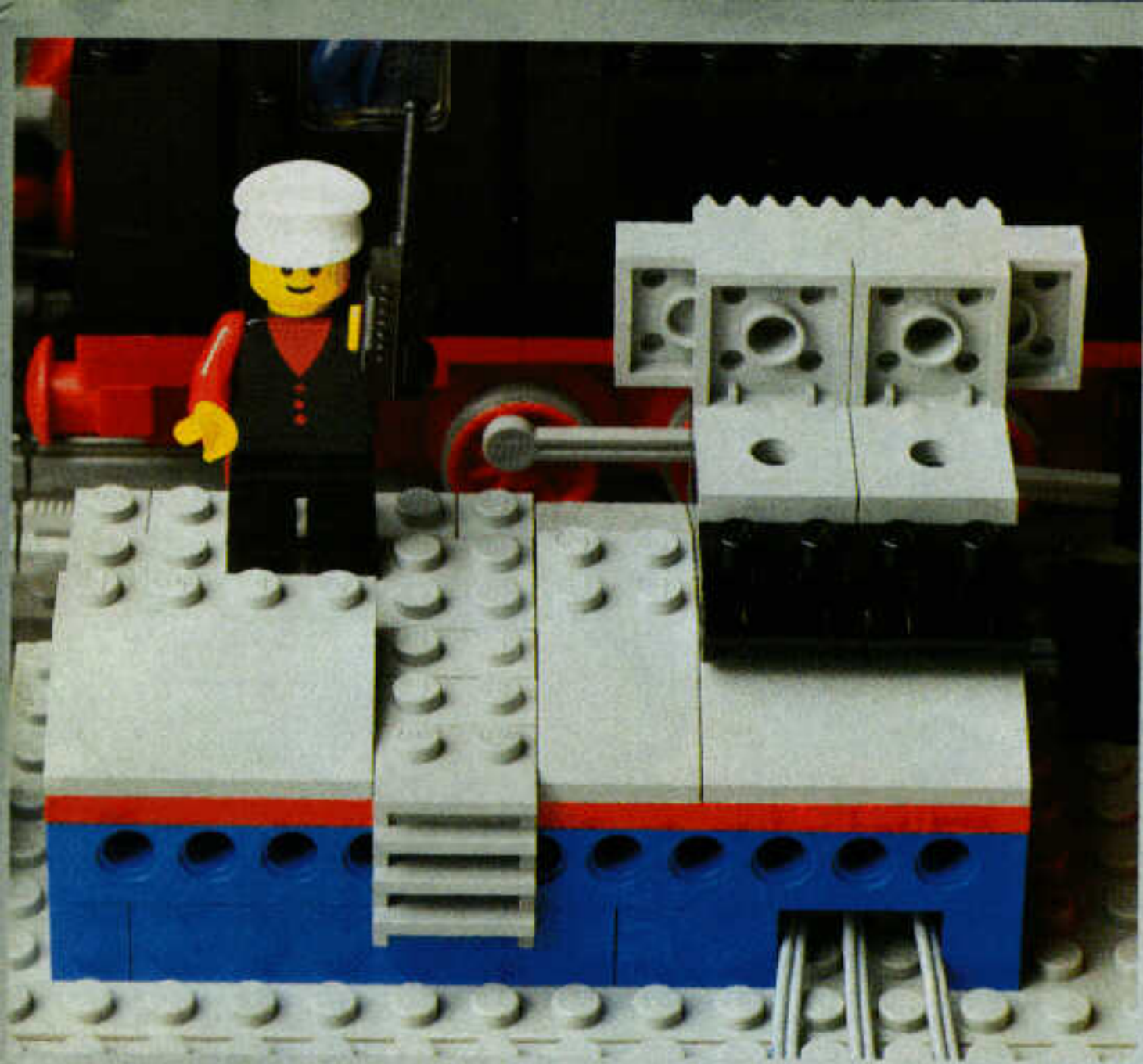

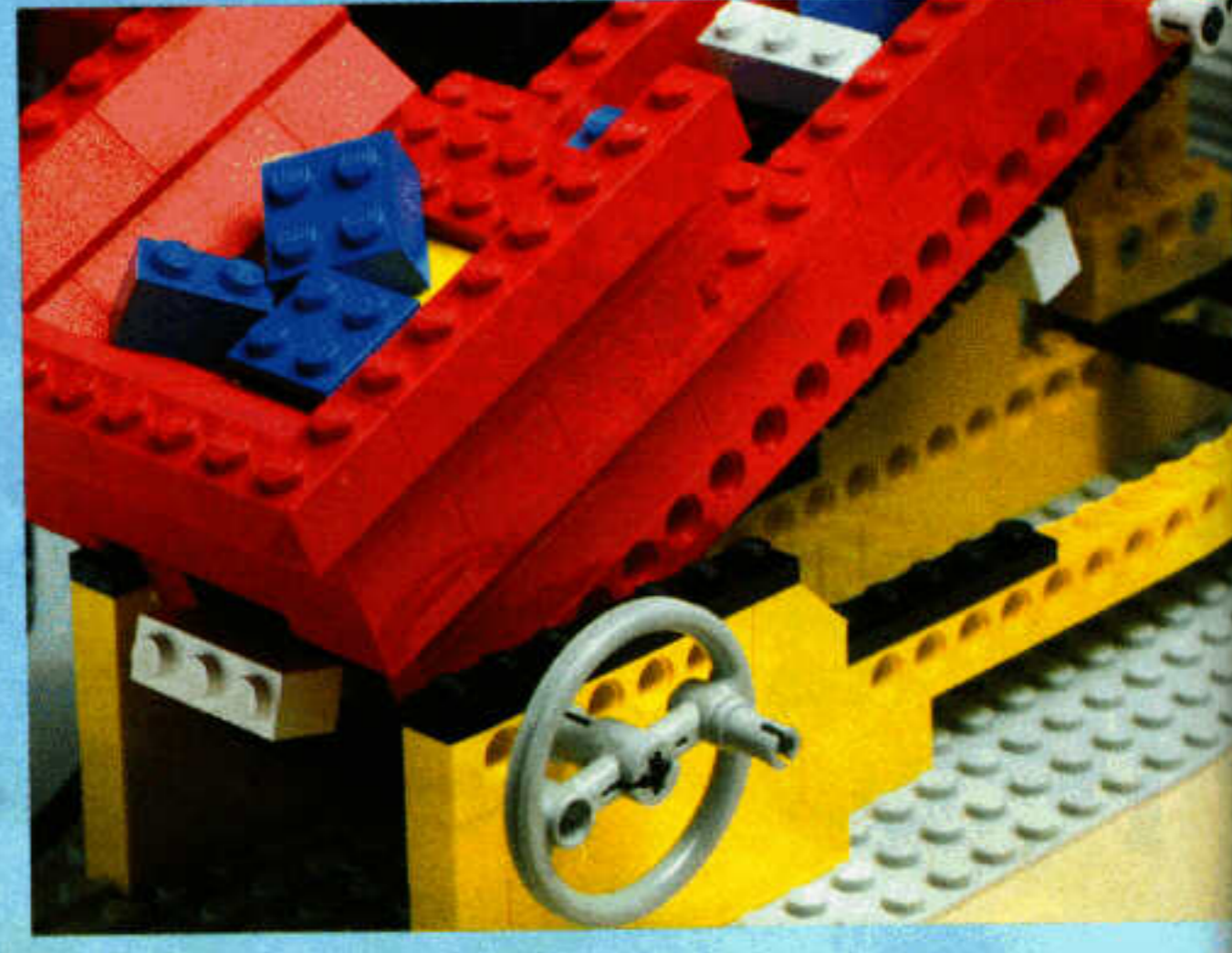
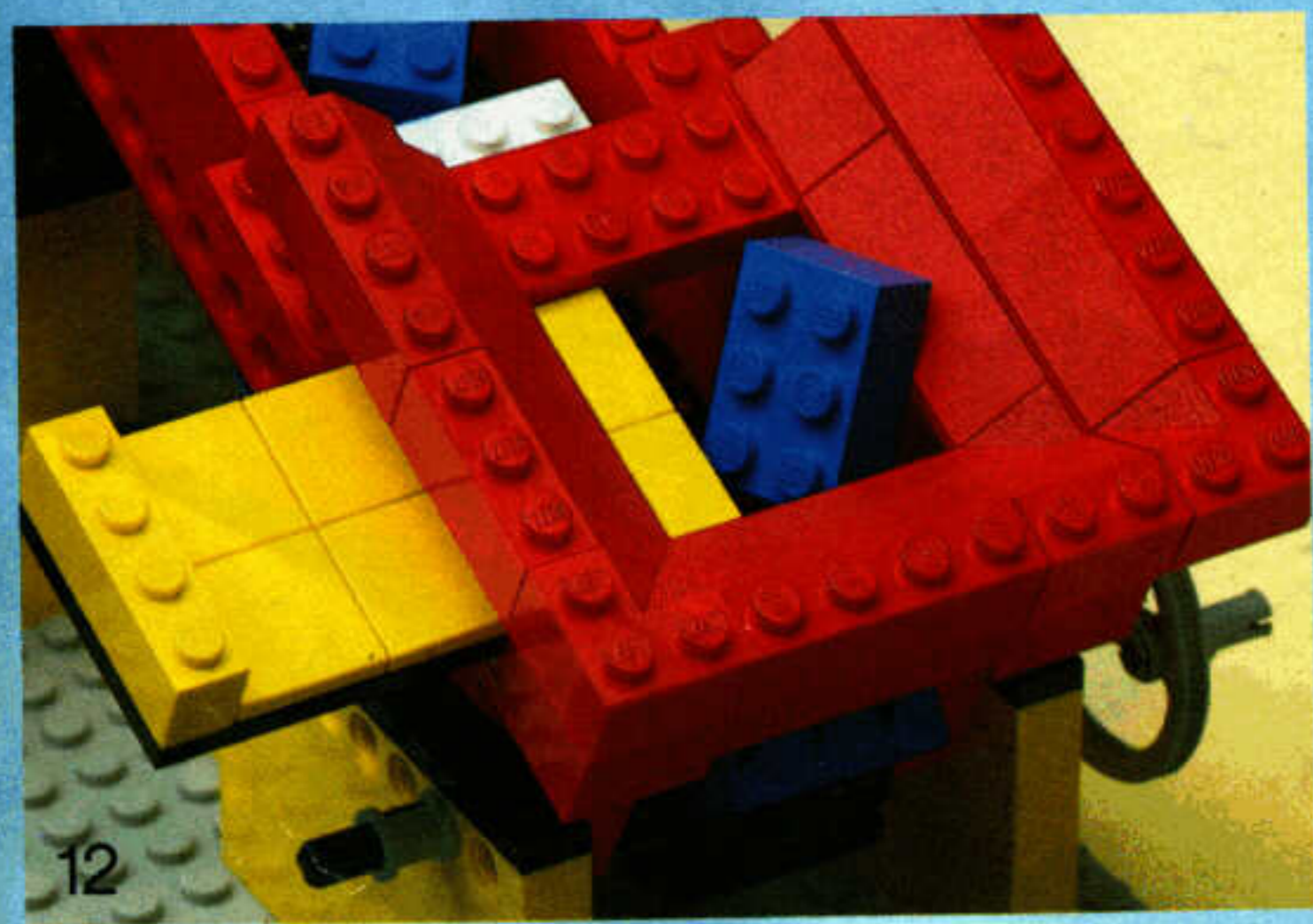
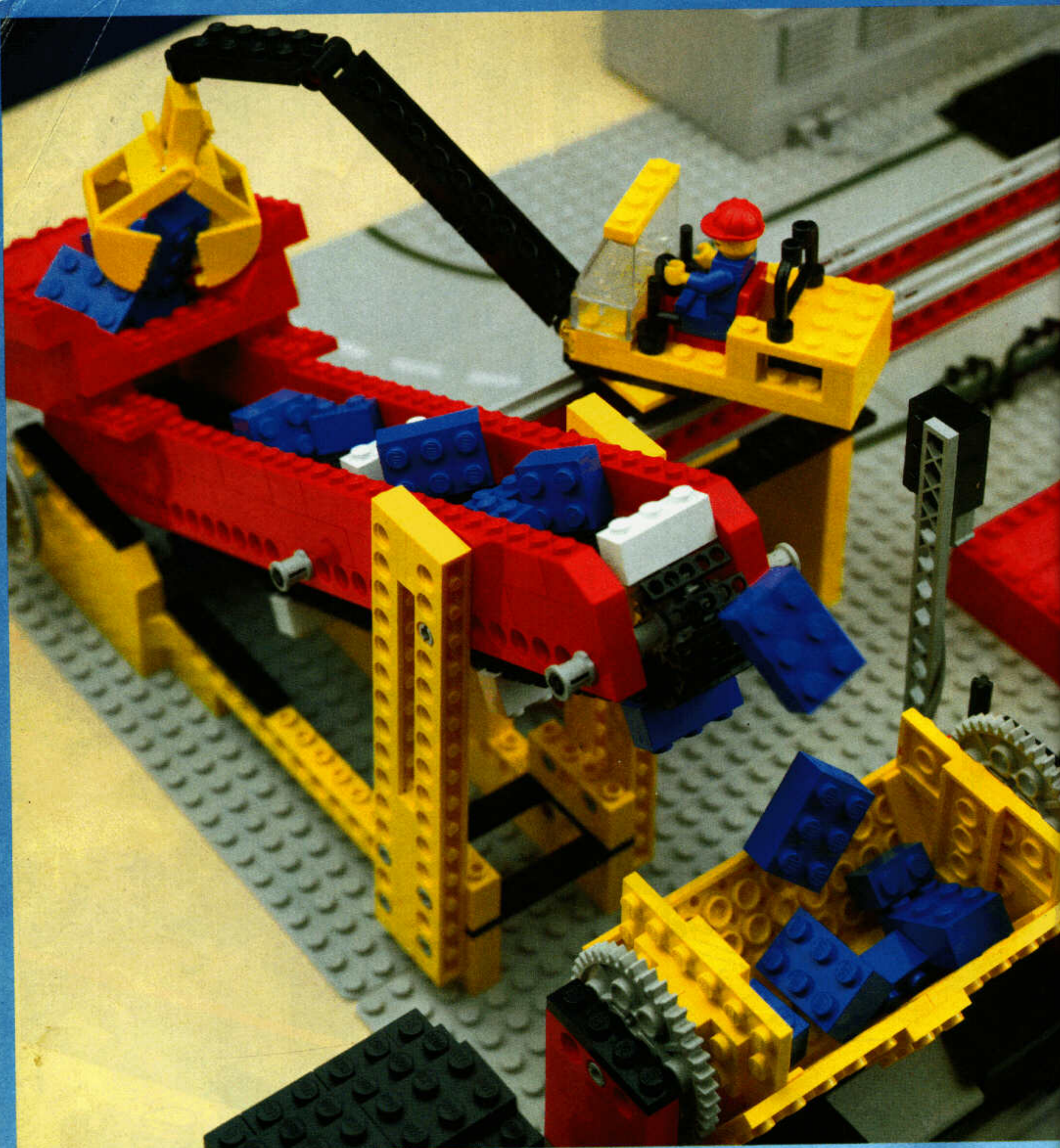

1

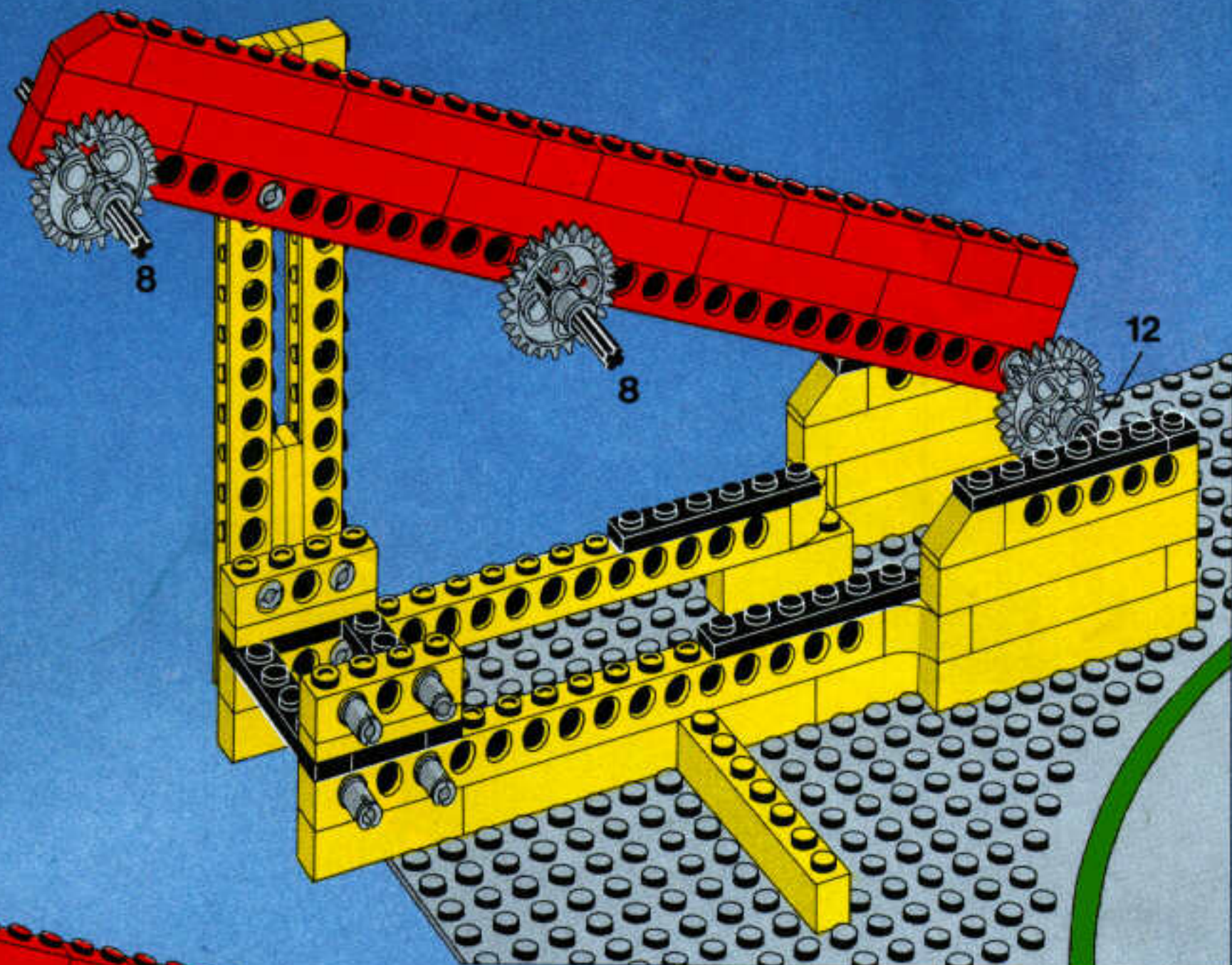

2

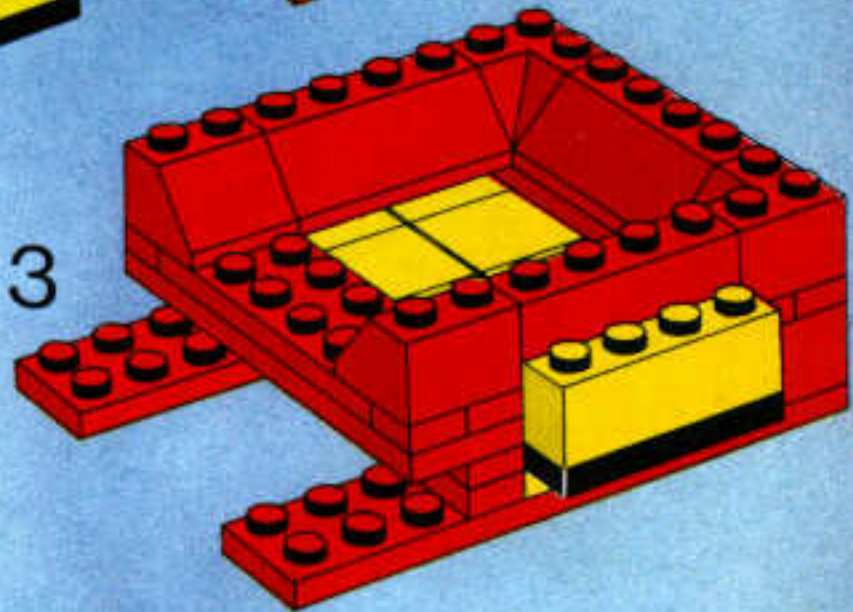
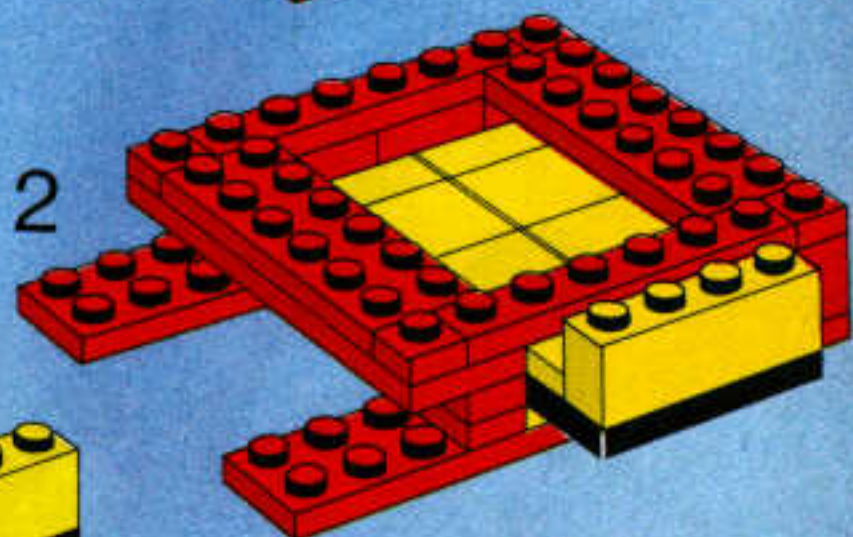
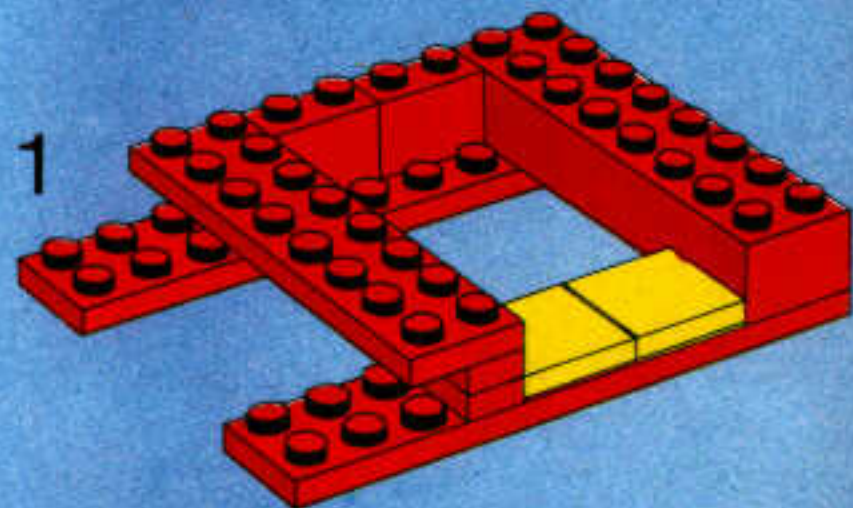
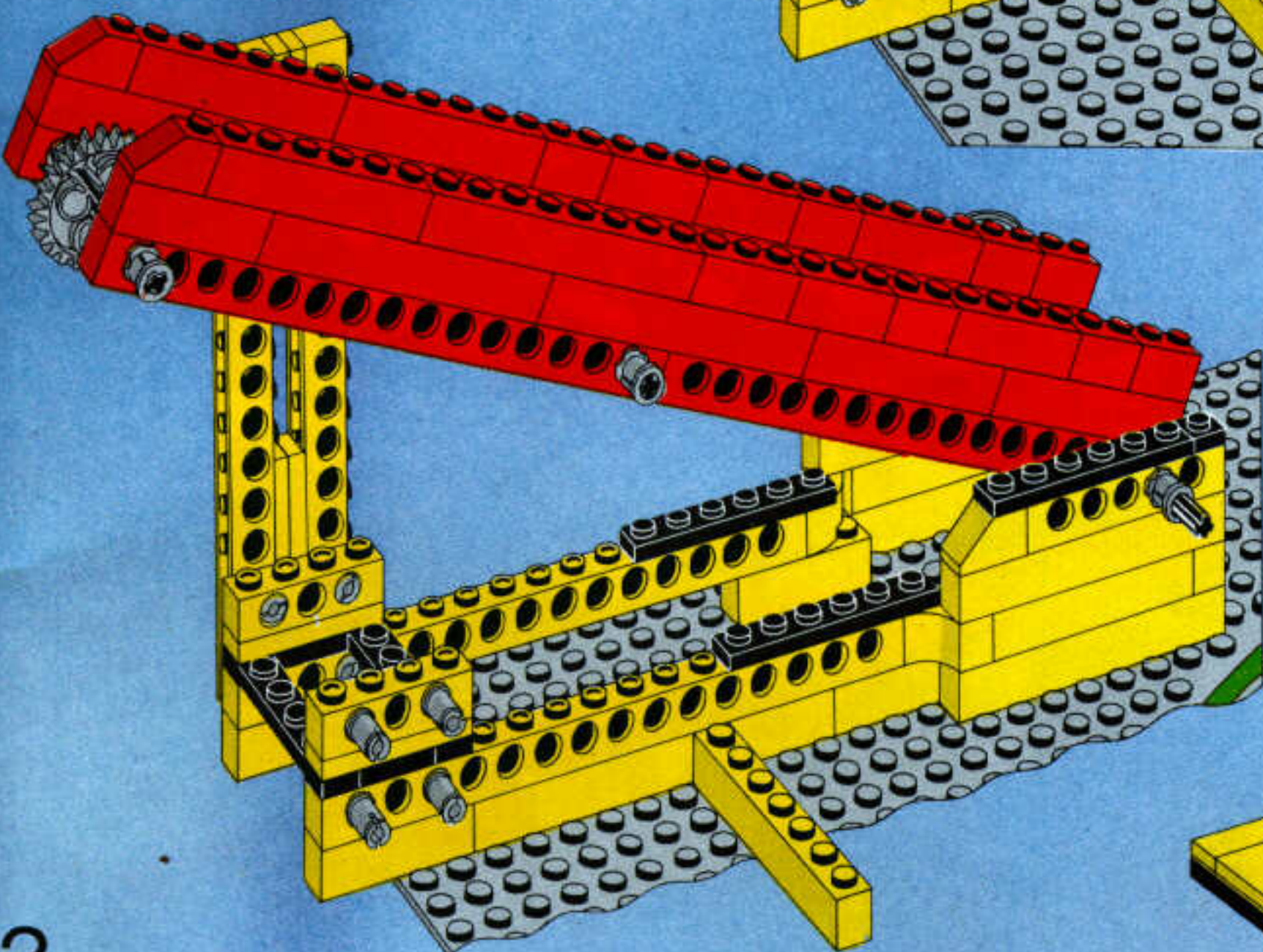

3

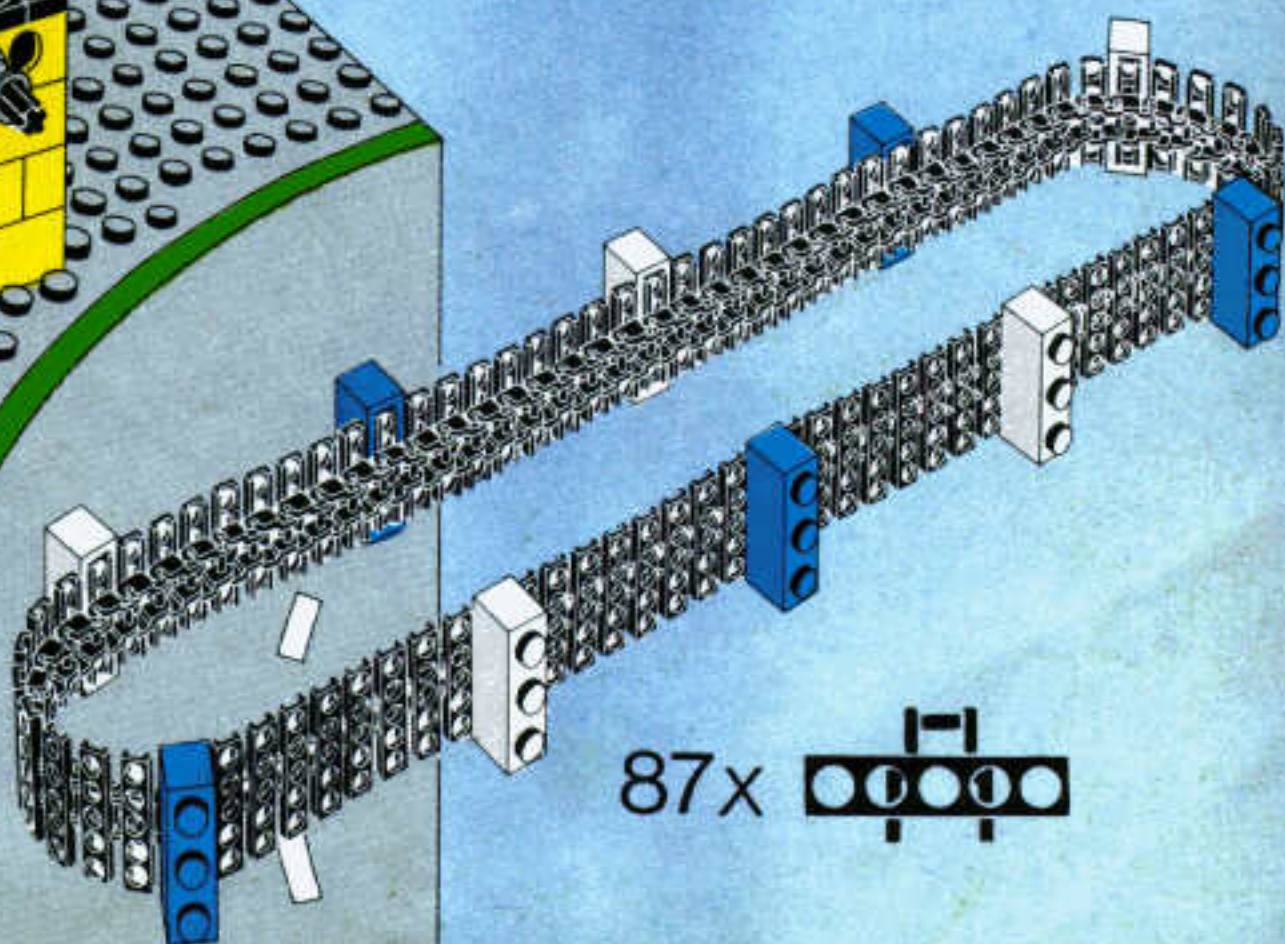
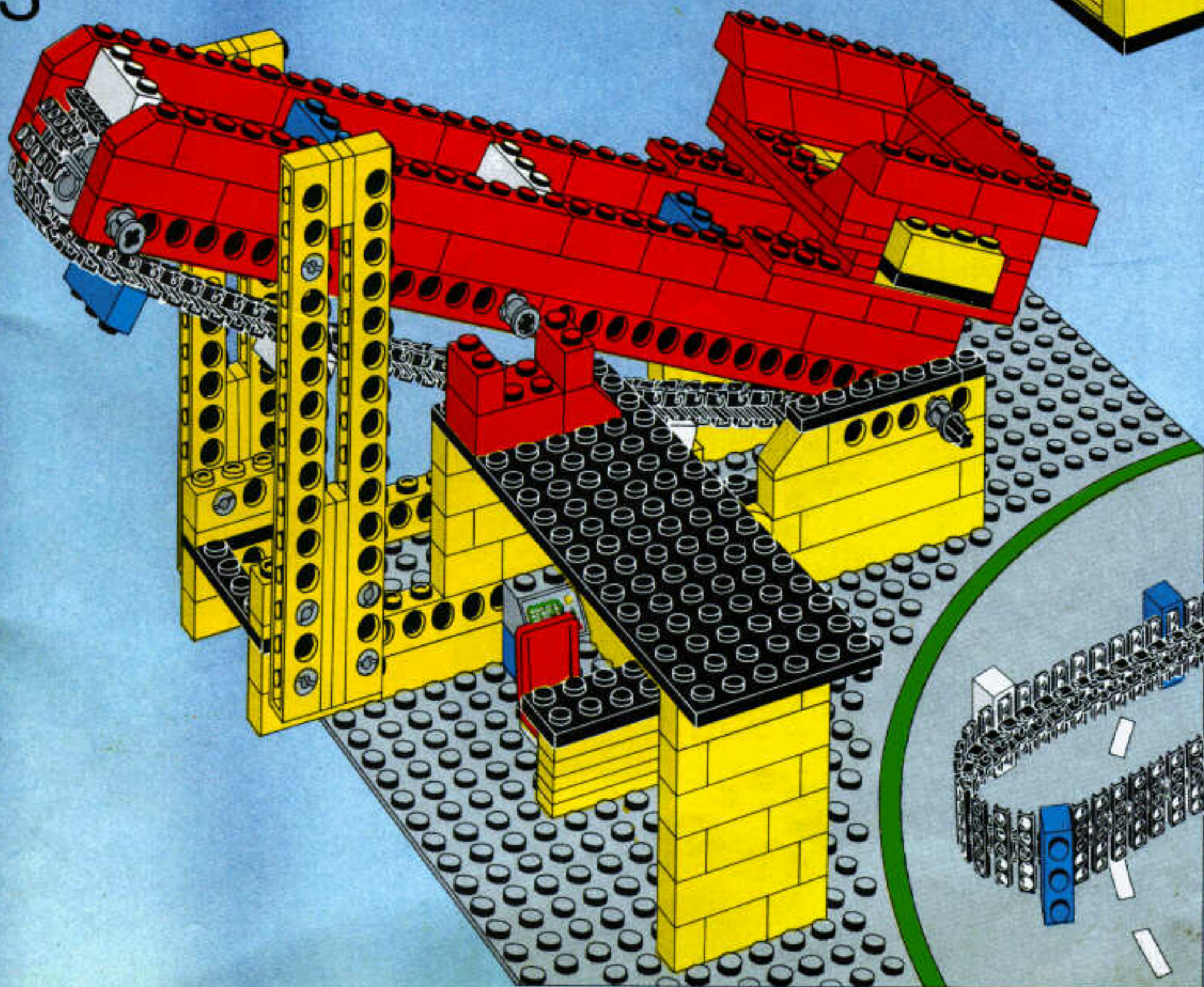





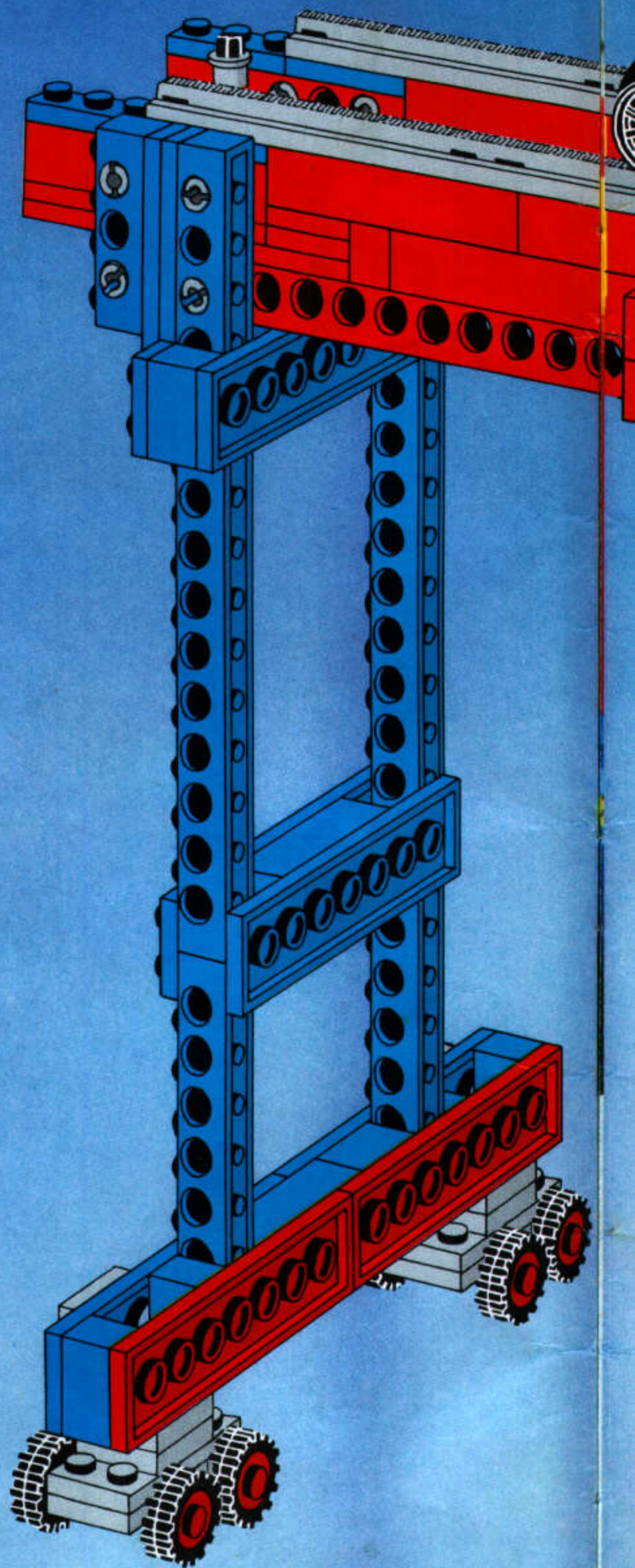
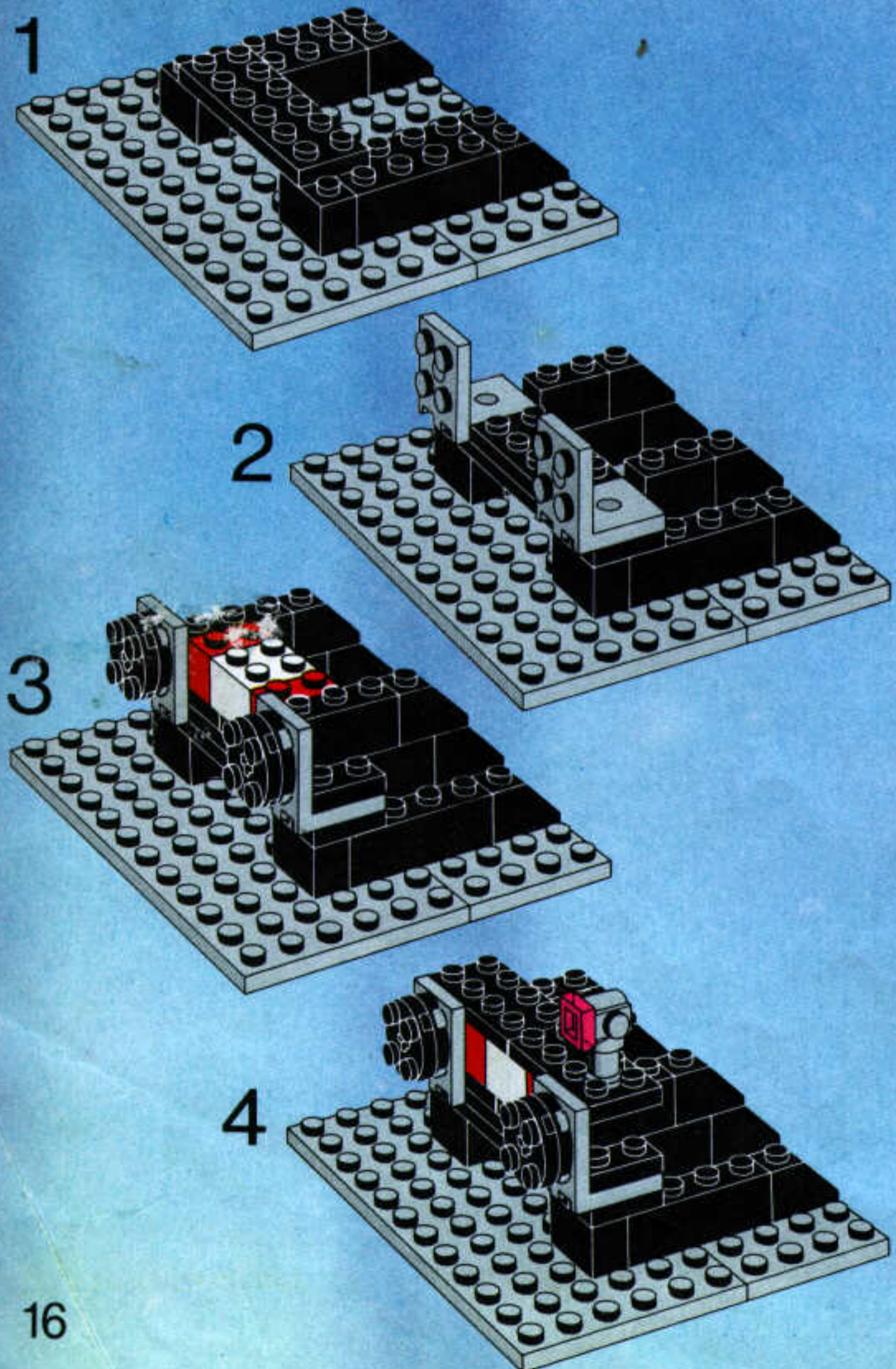



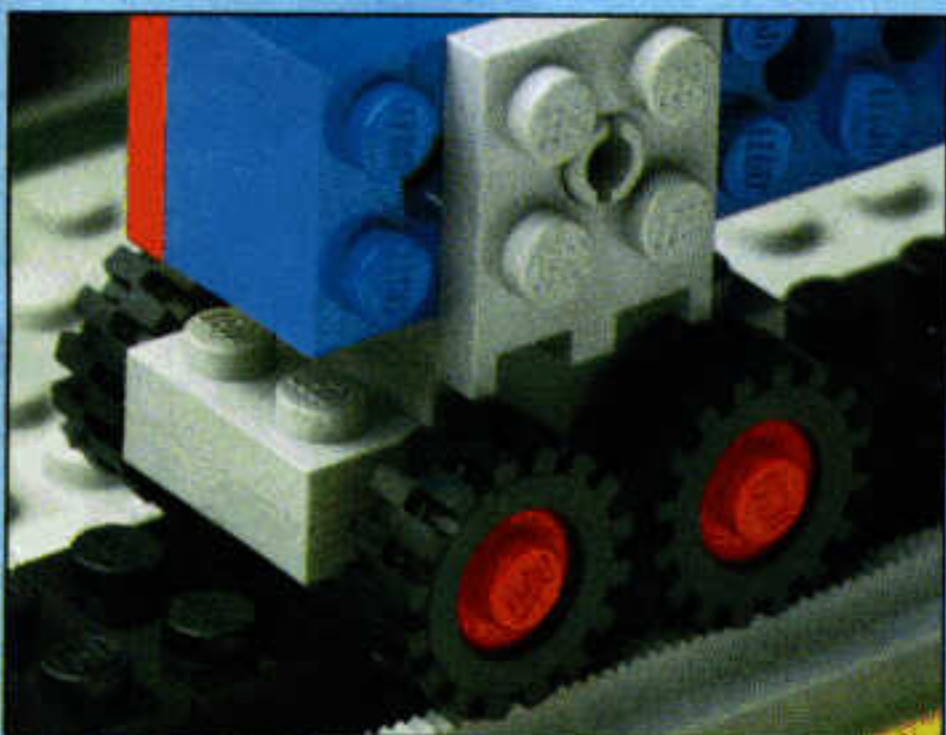
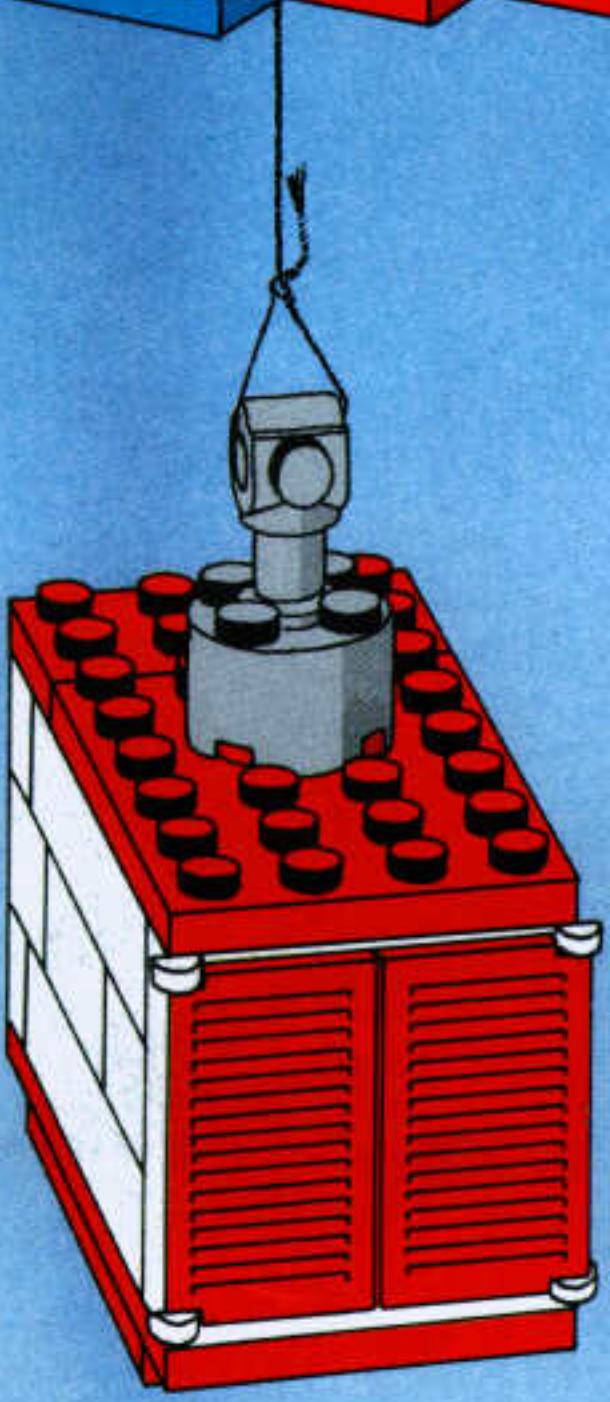
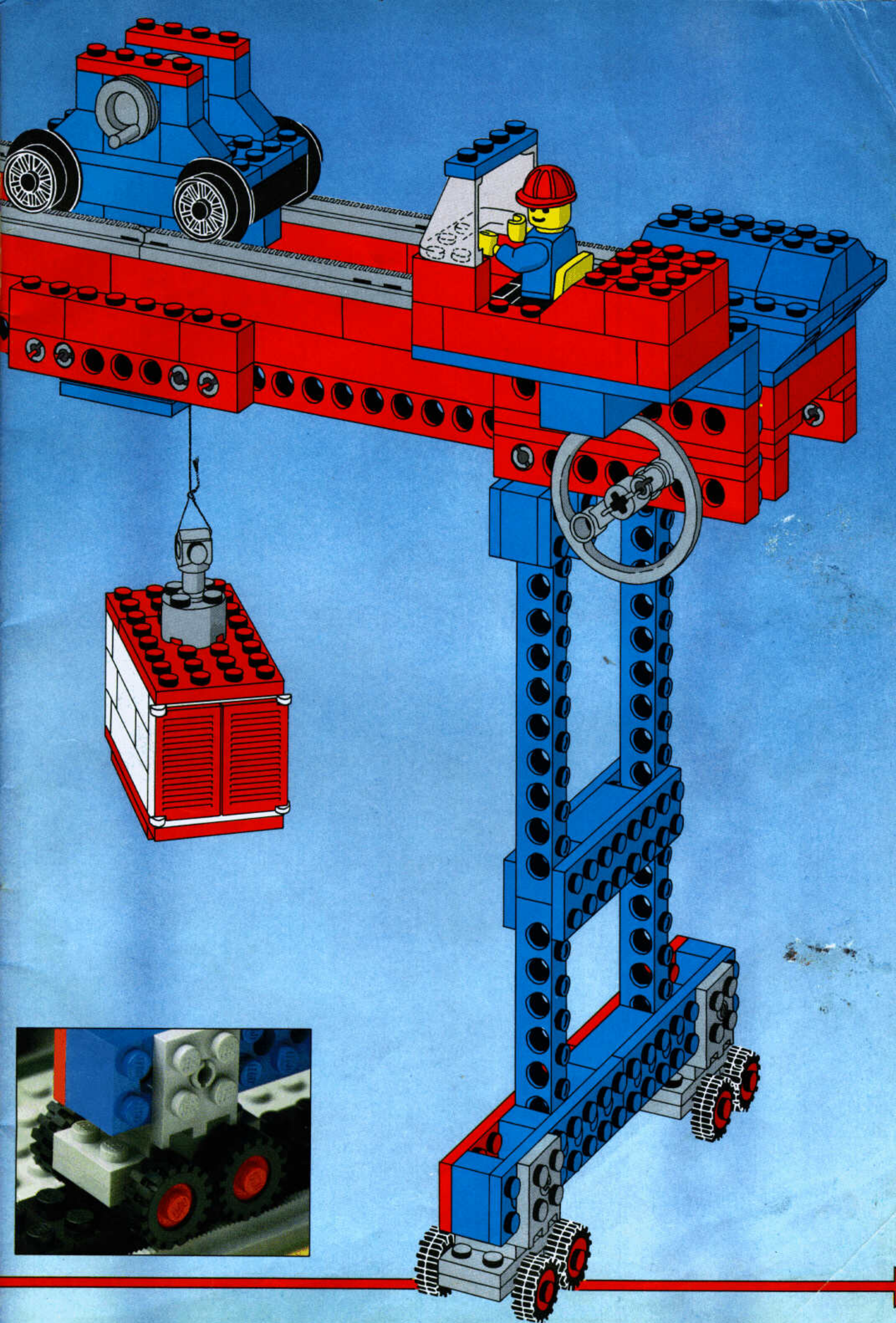

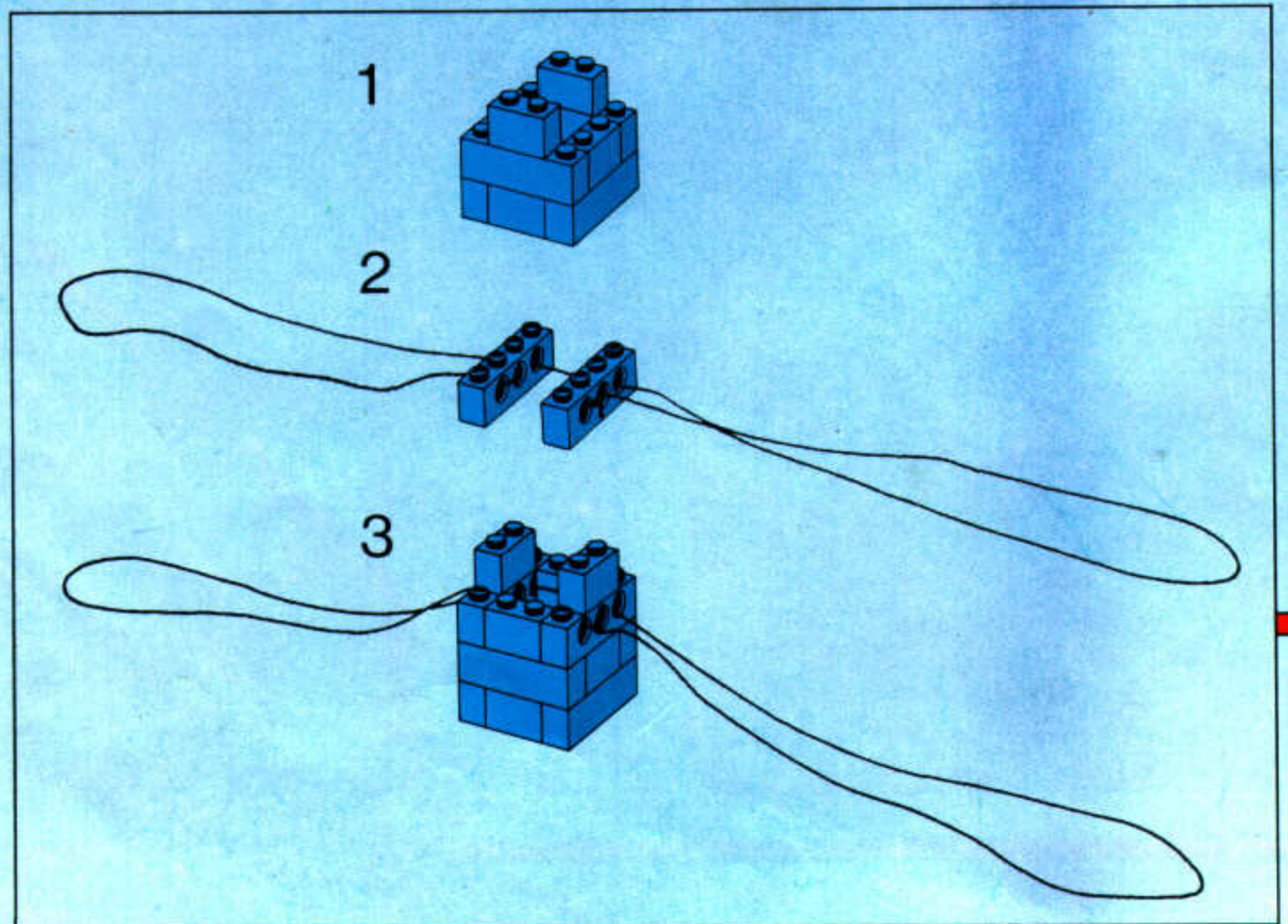
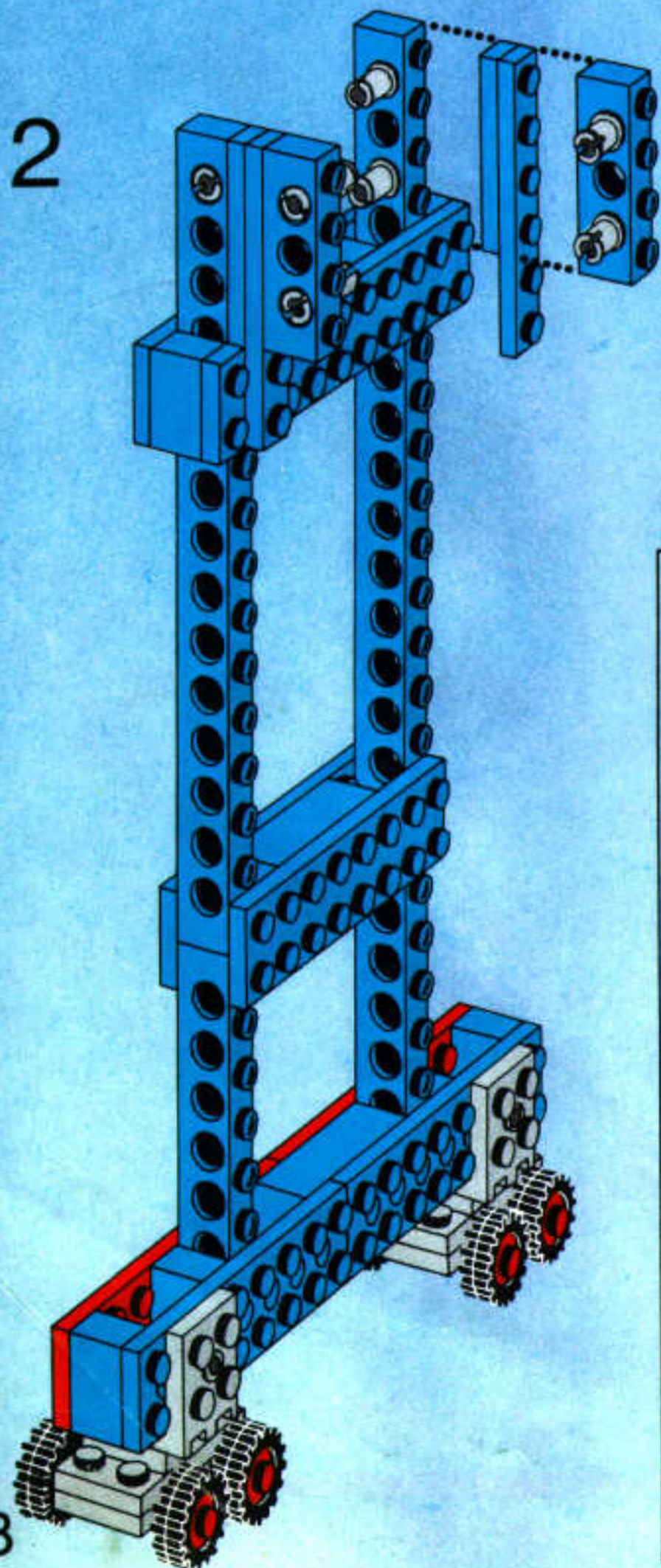
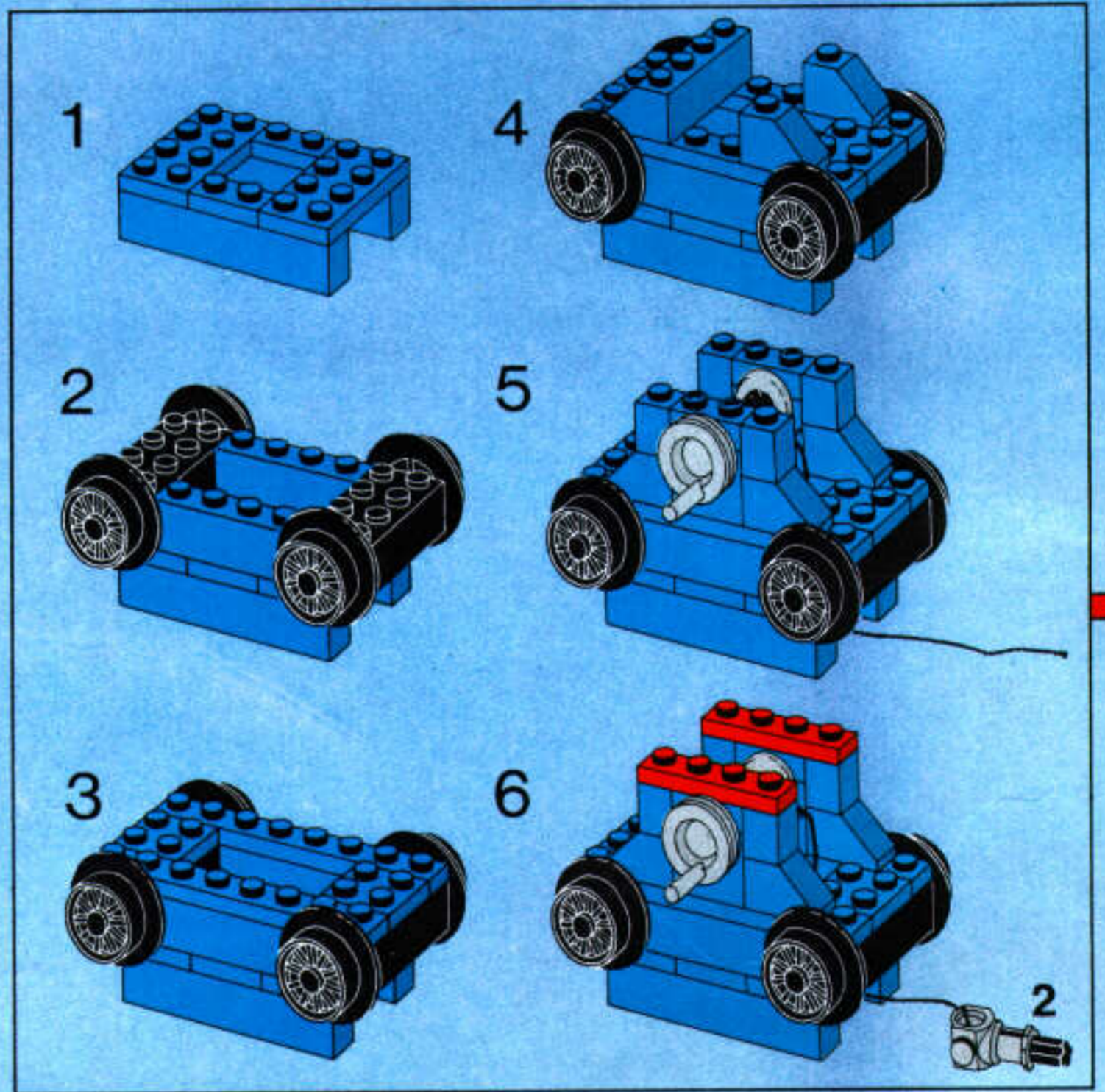
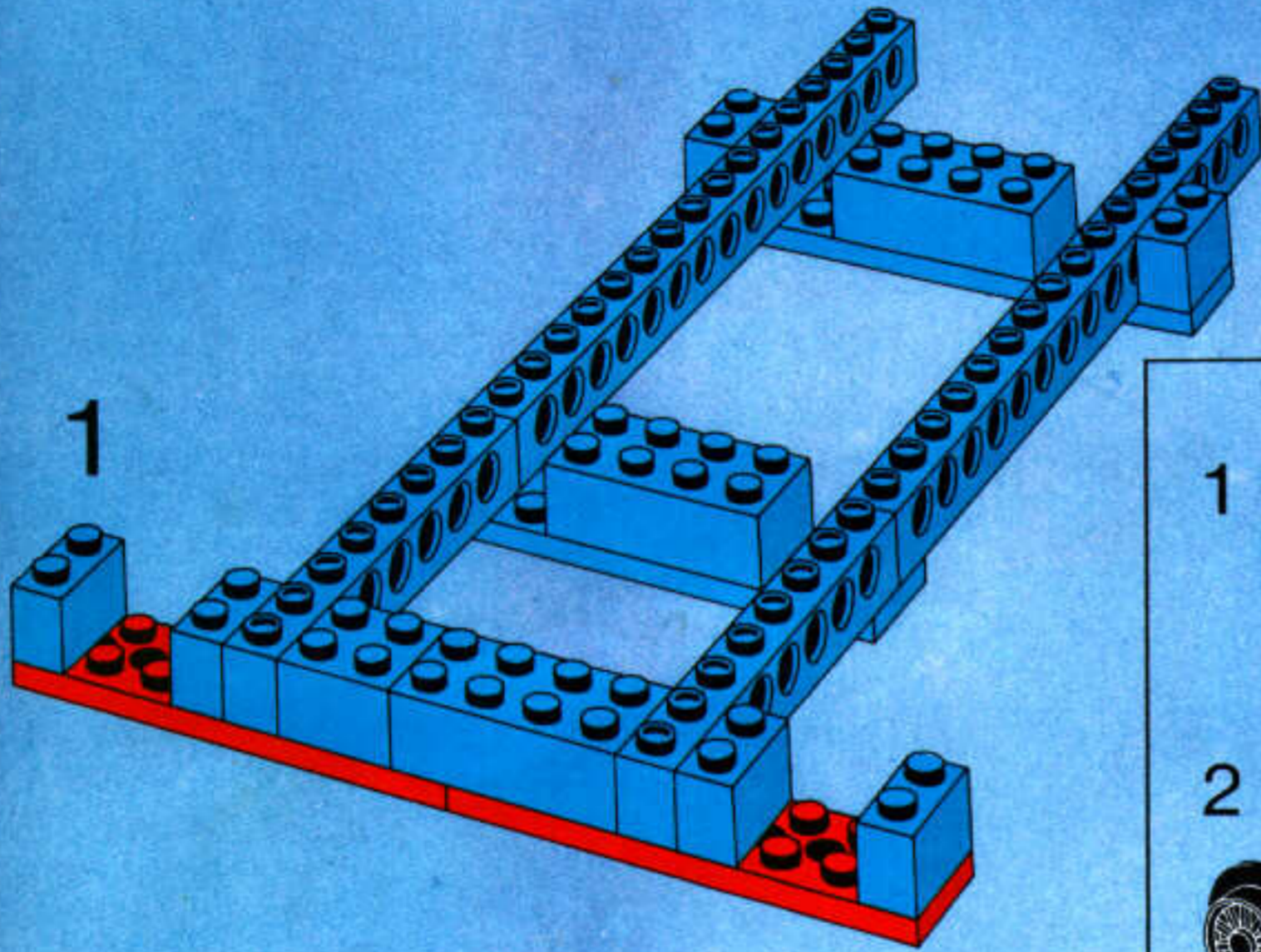
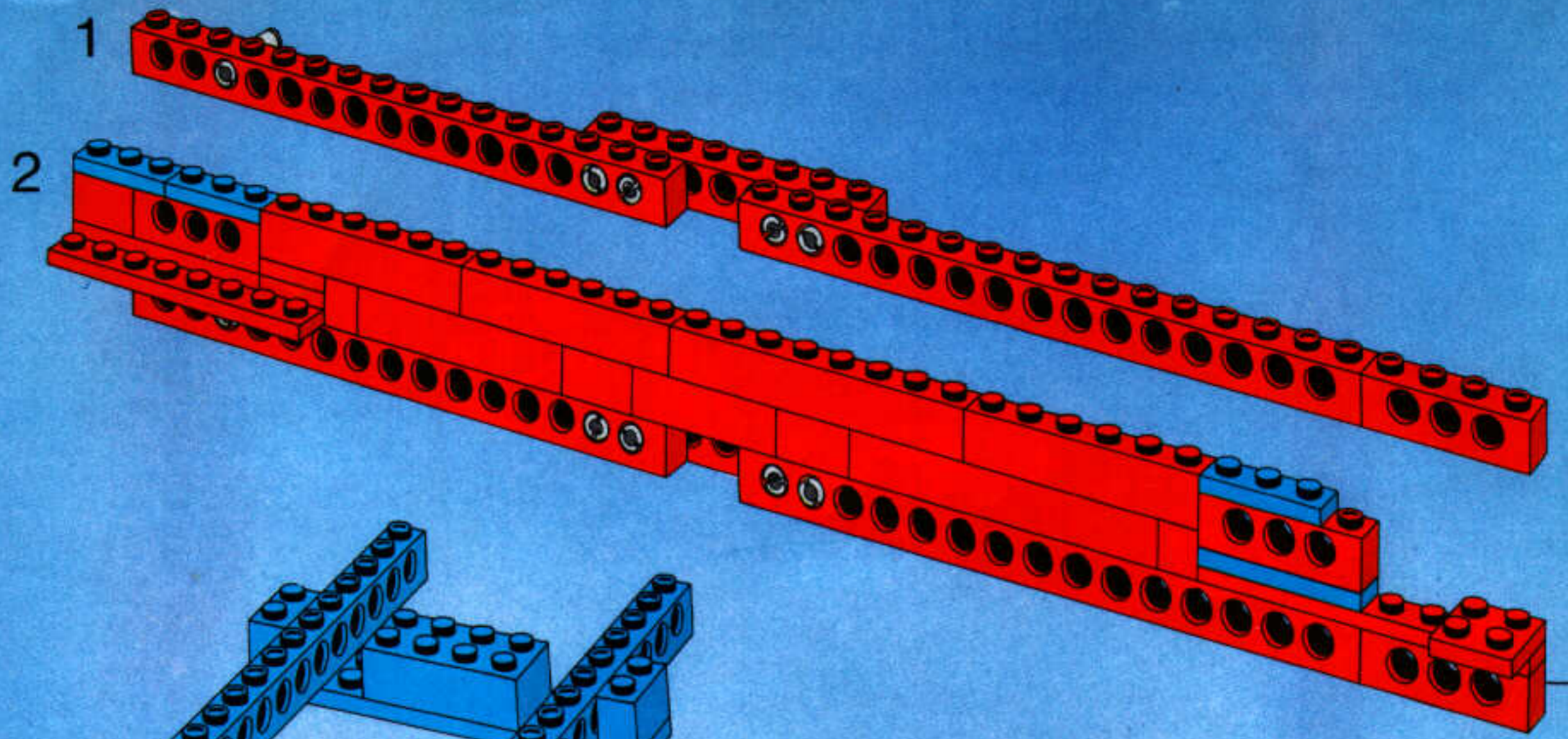

3

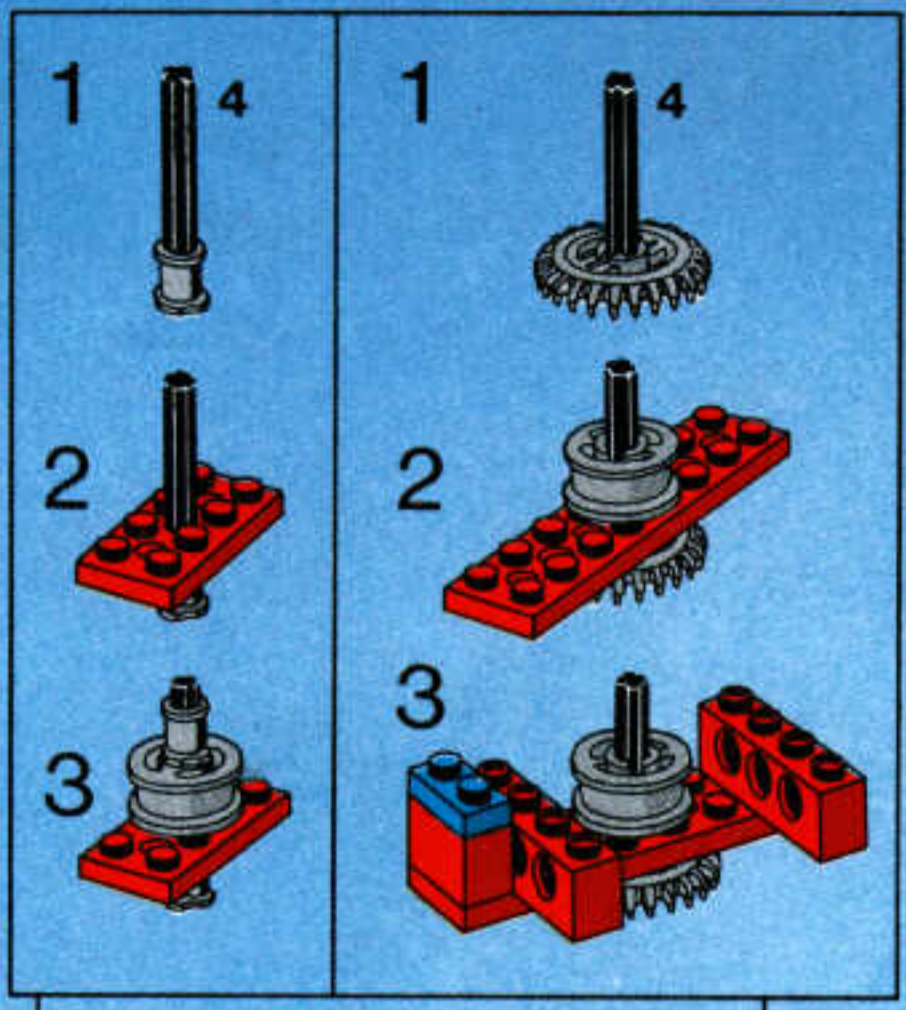

4

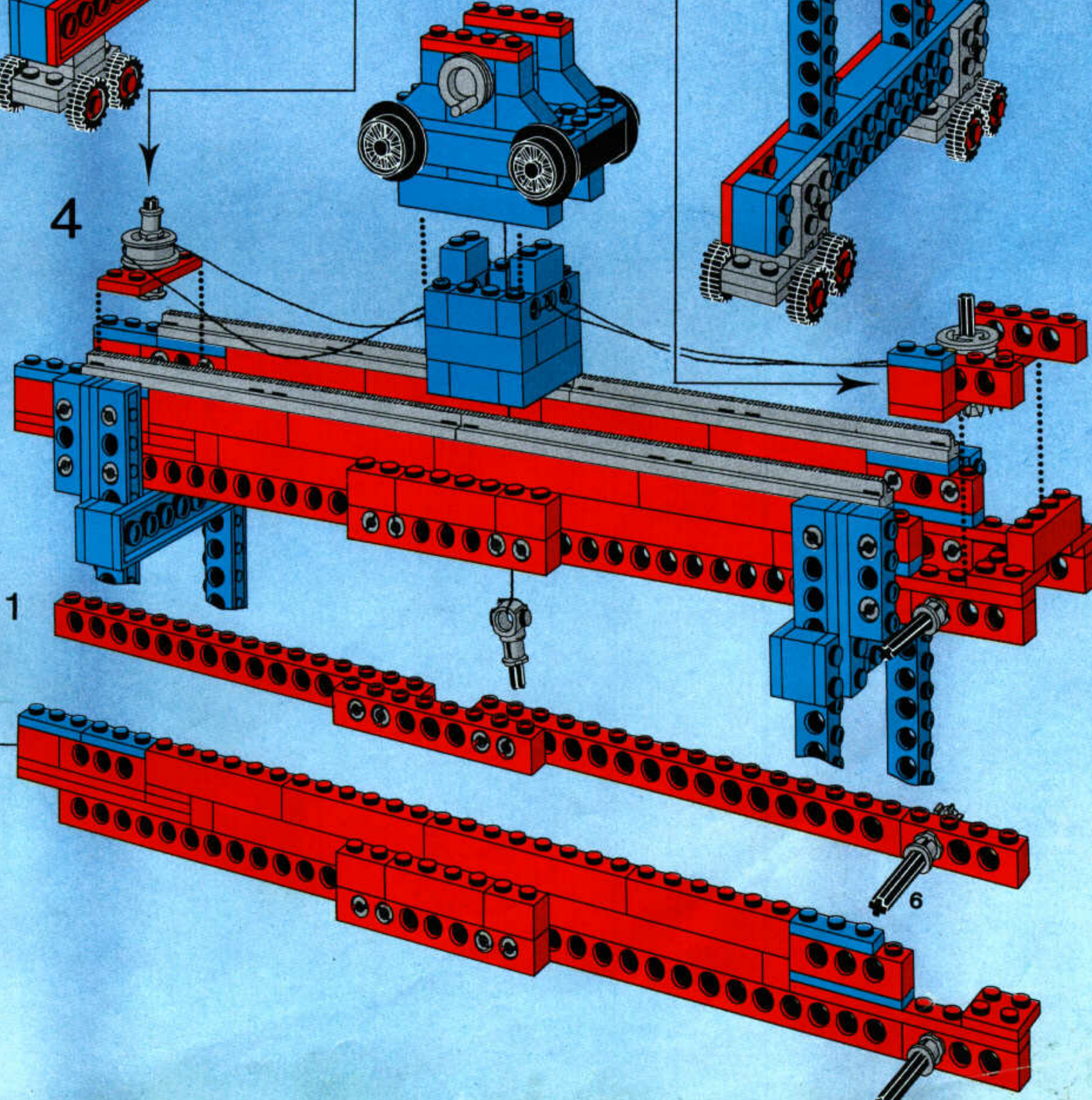

1

2

6



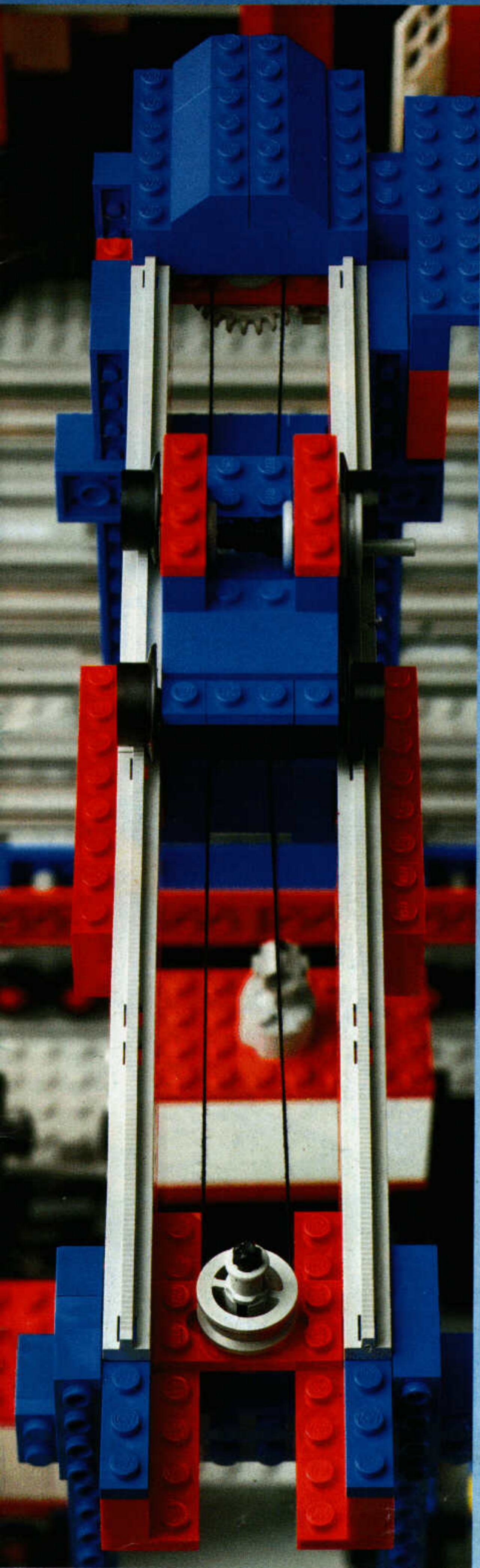



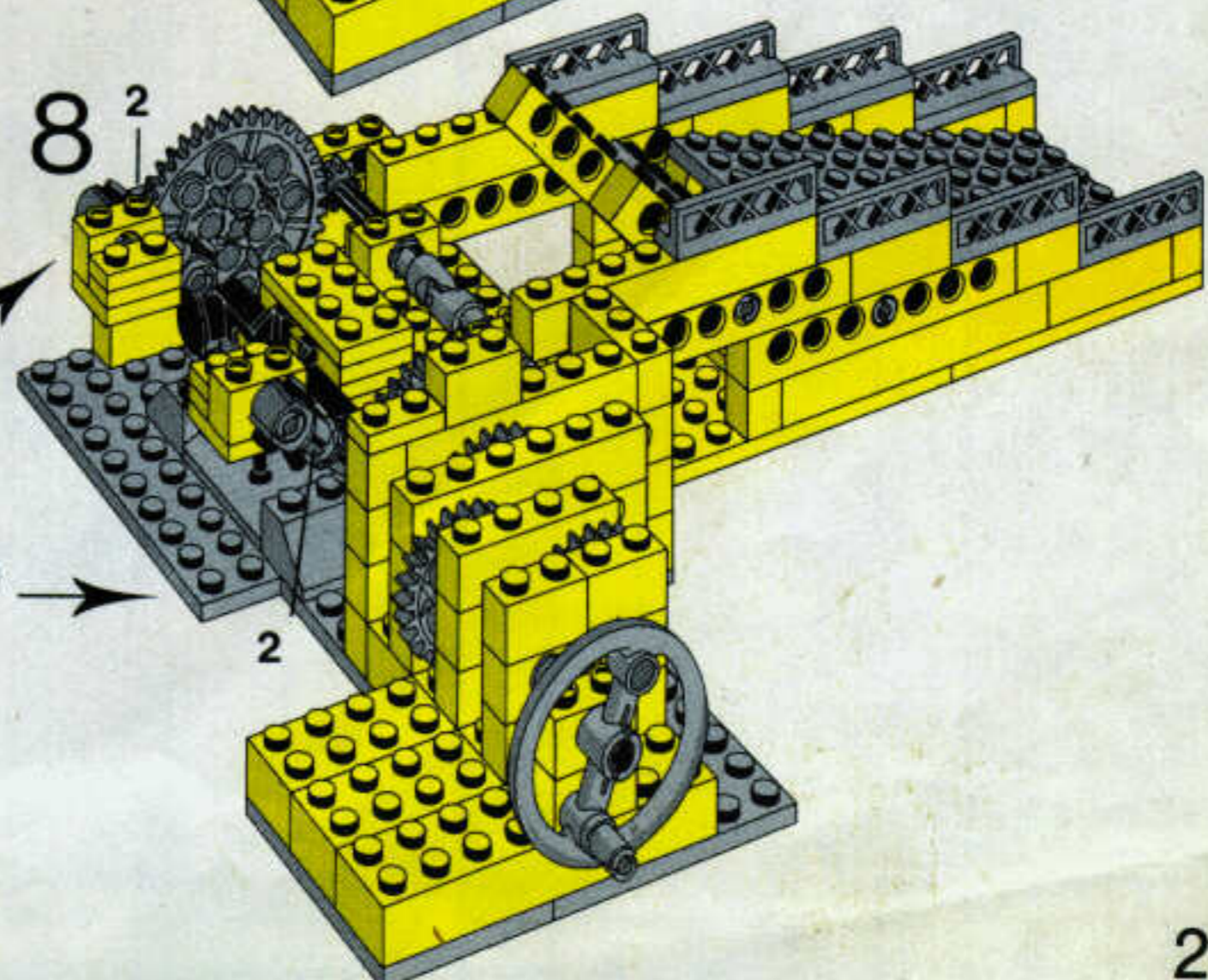
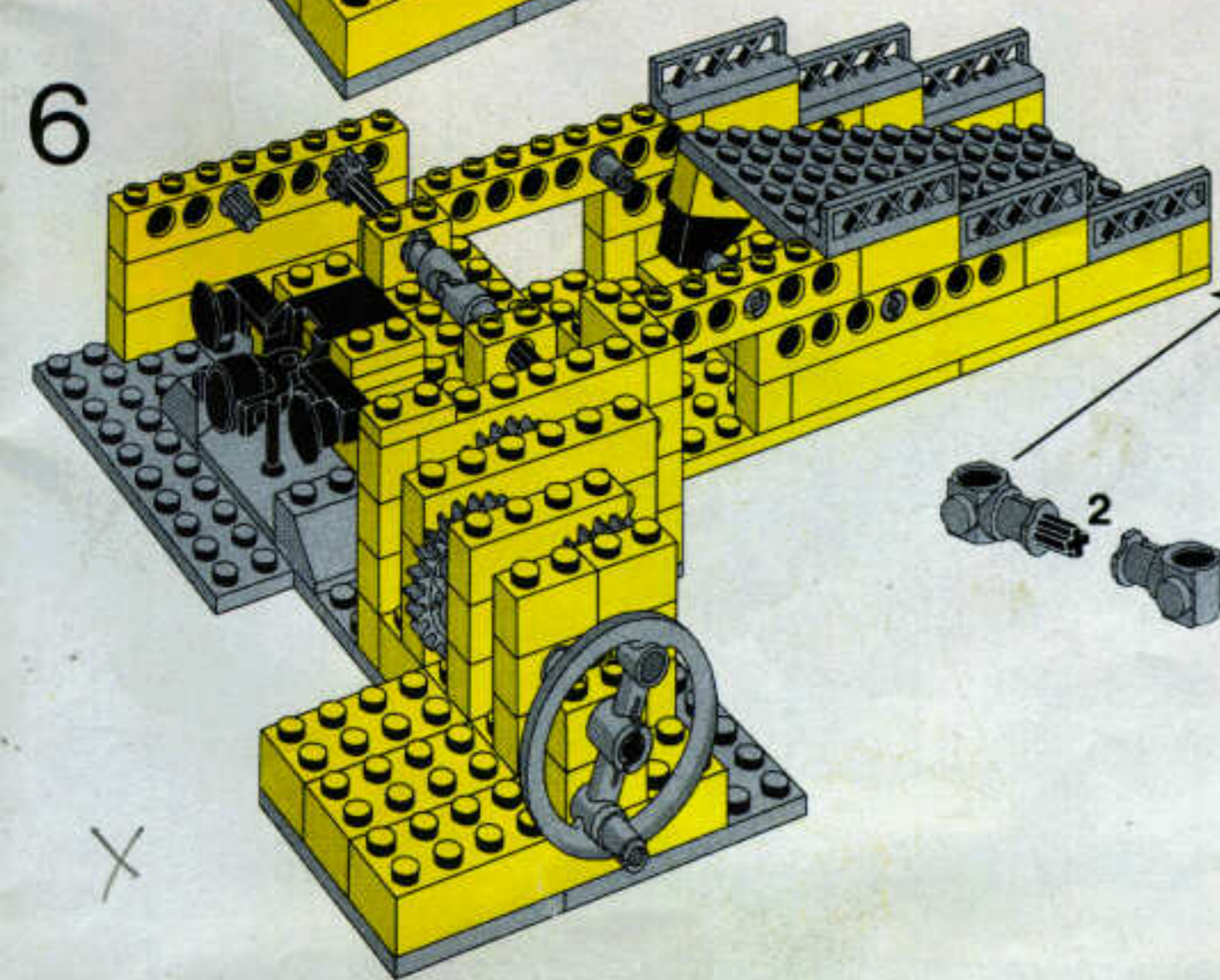
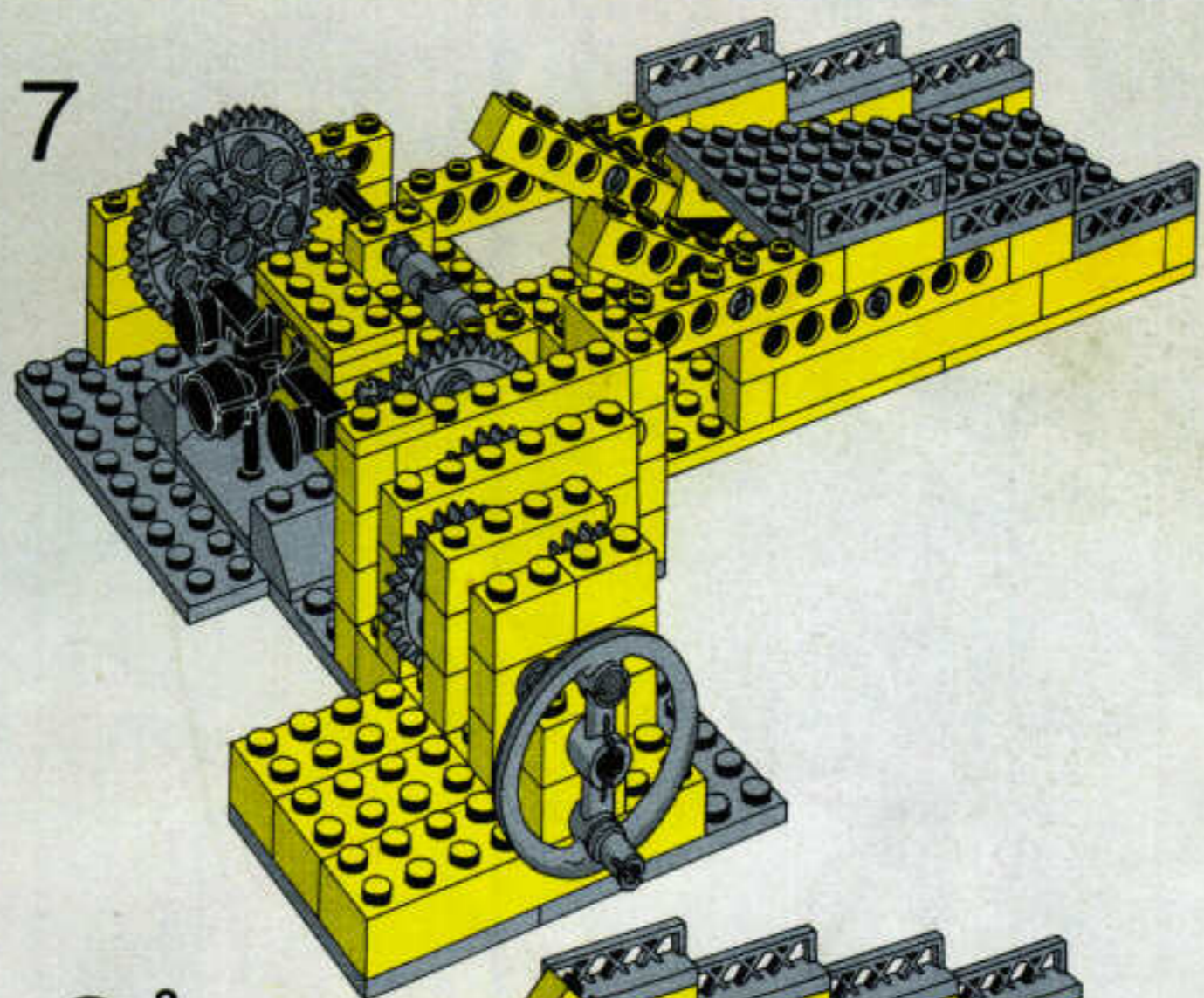
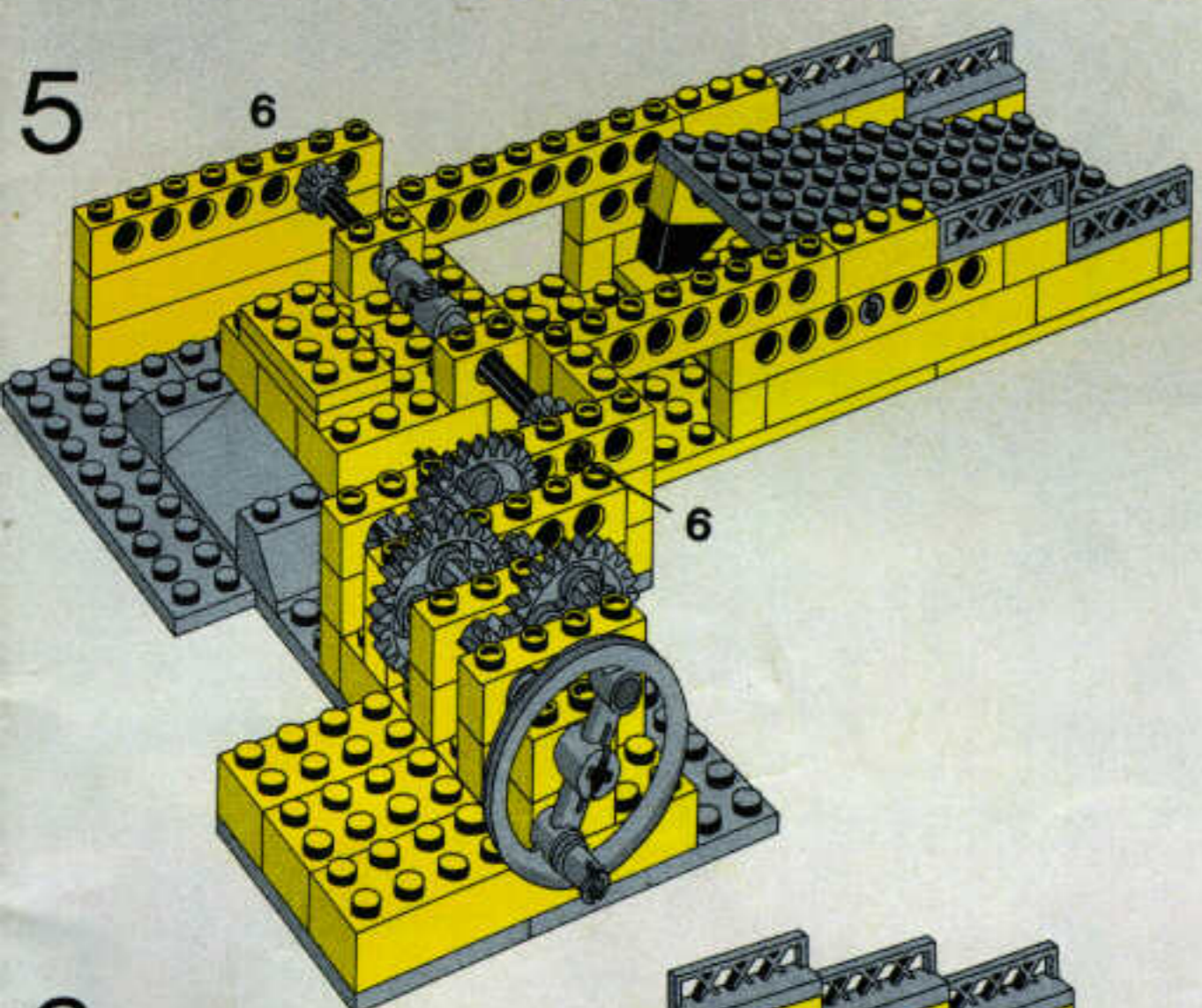
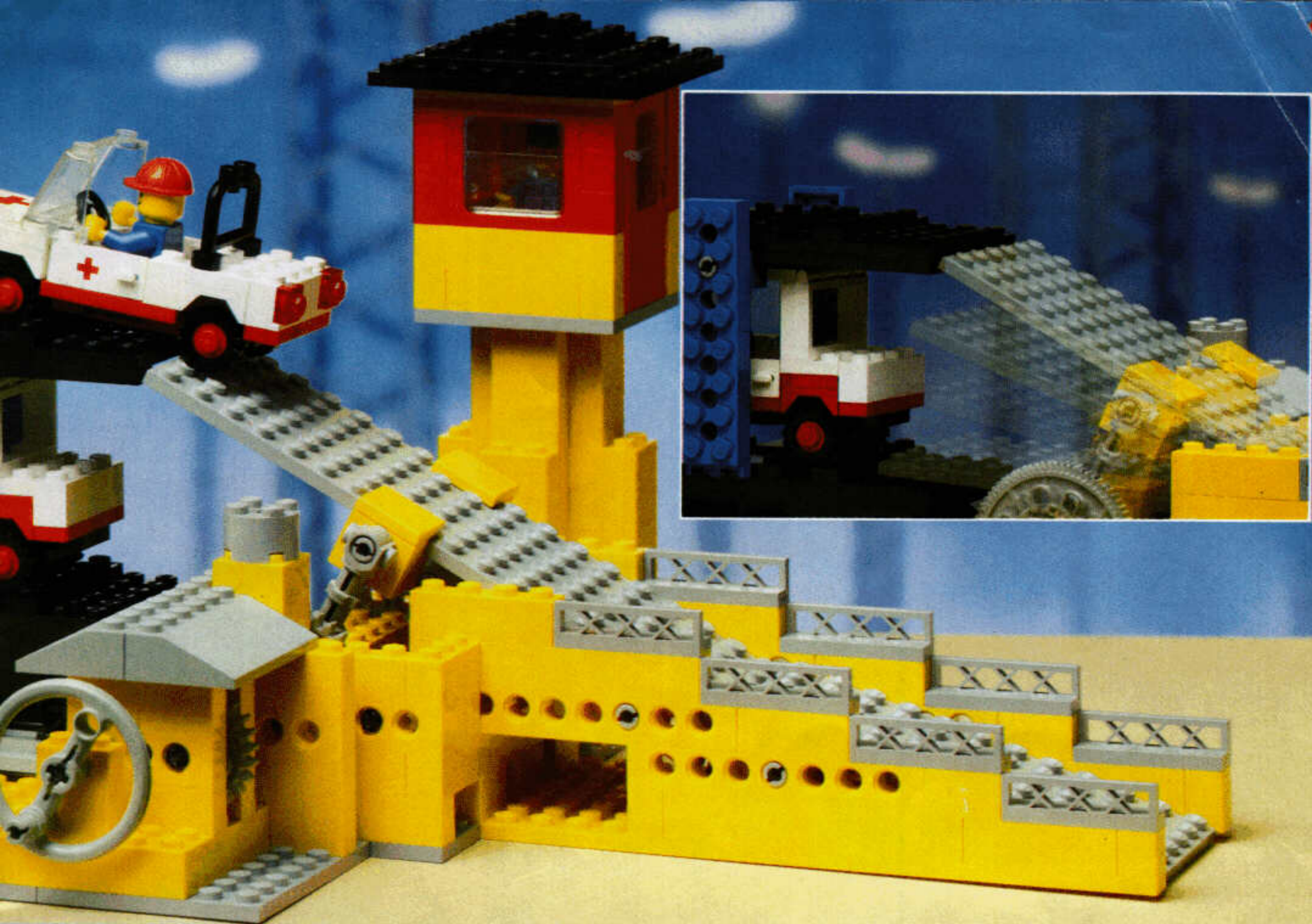

A



B



C





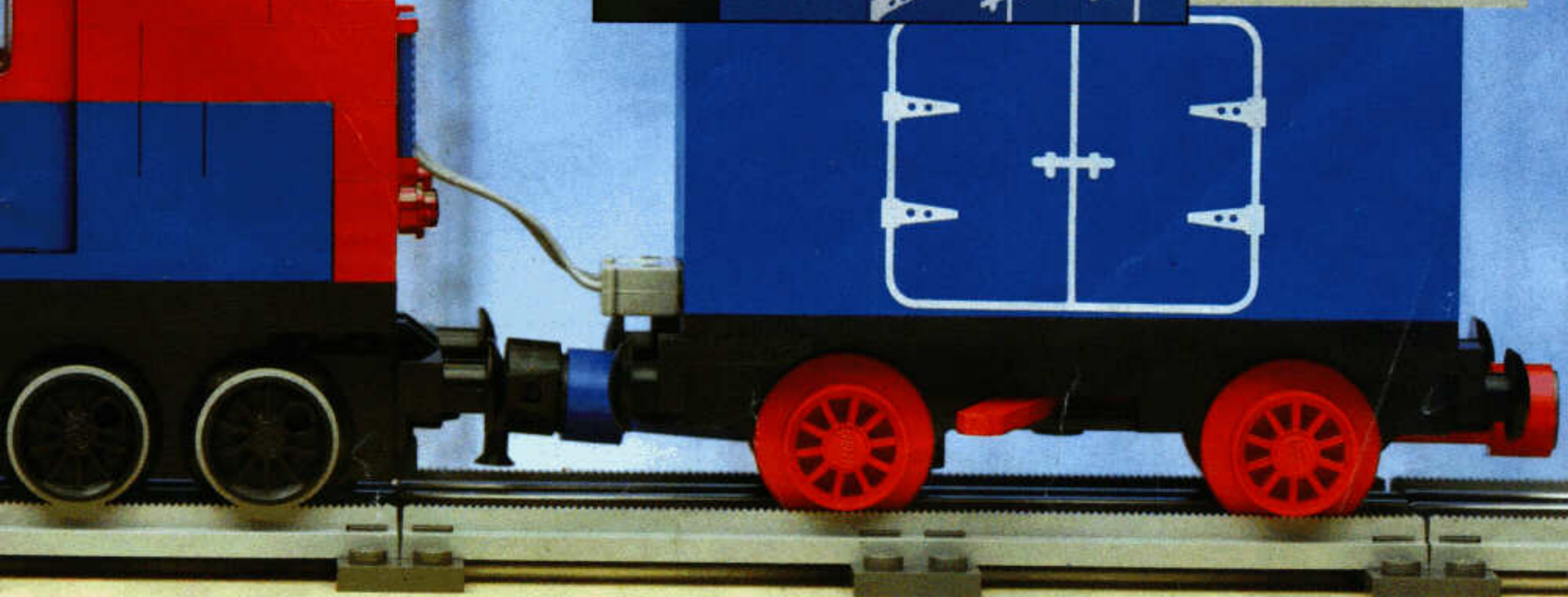
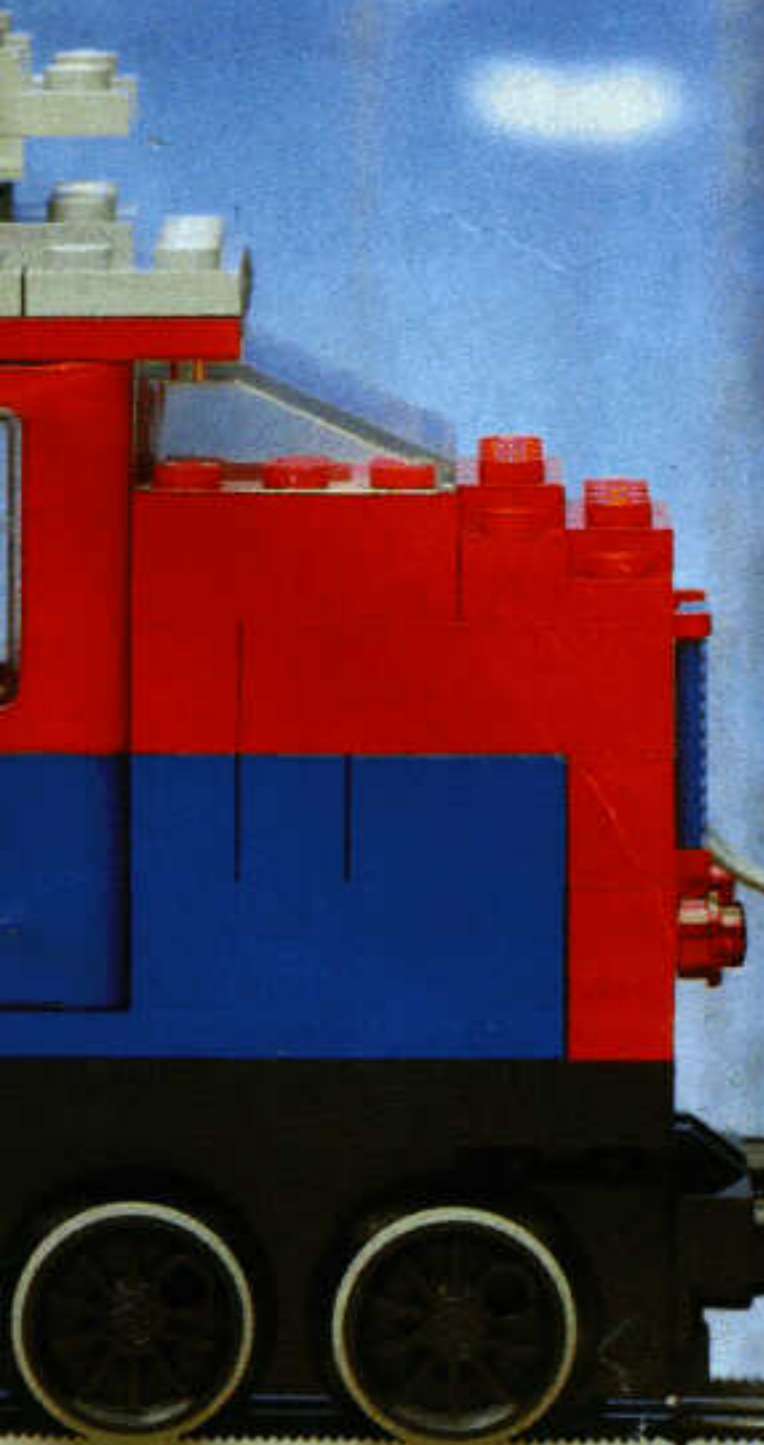
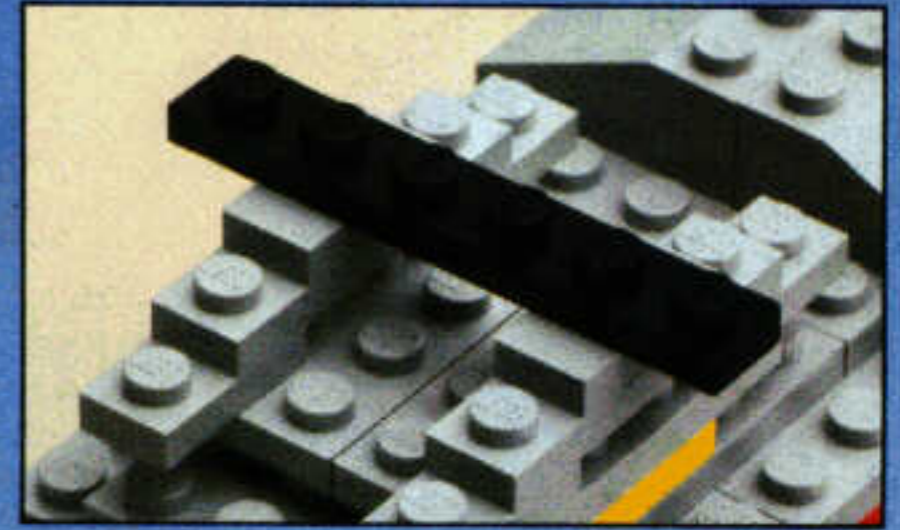
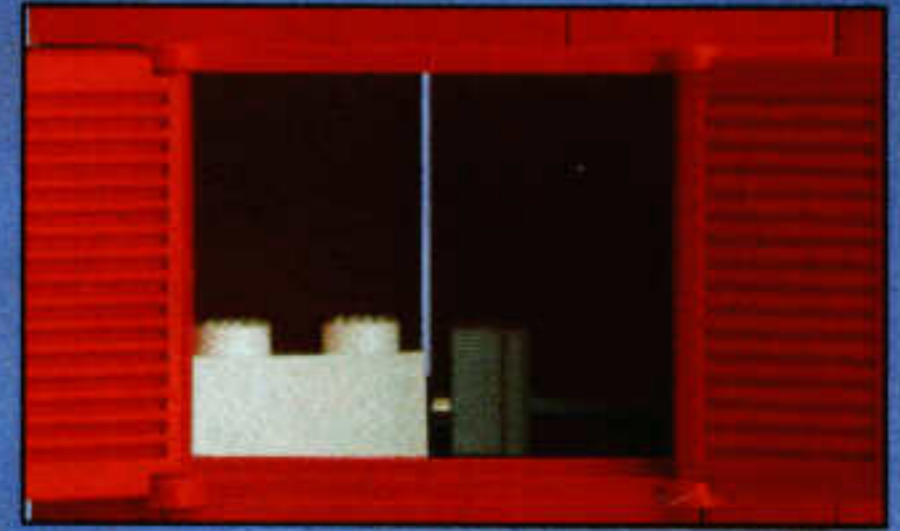
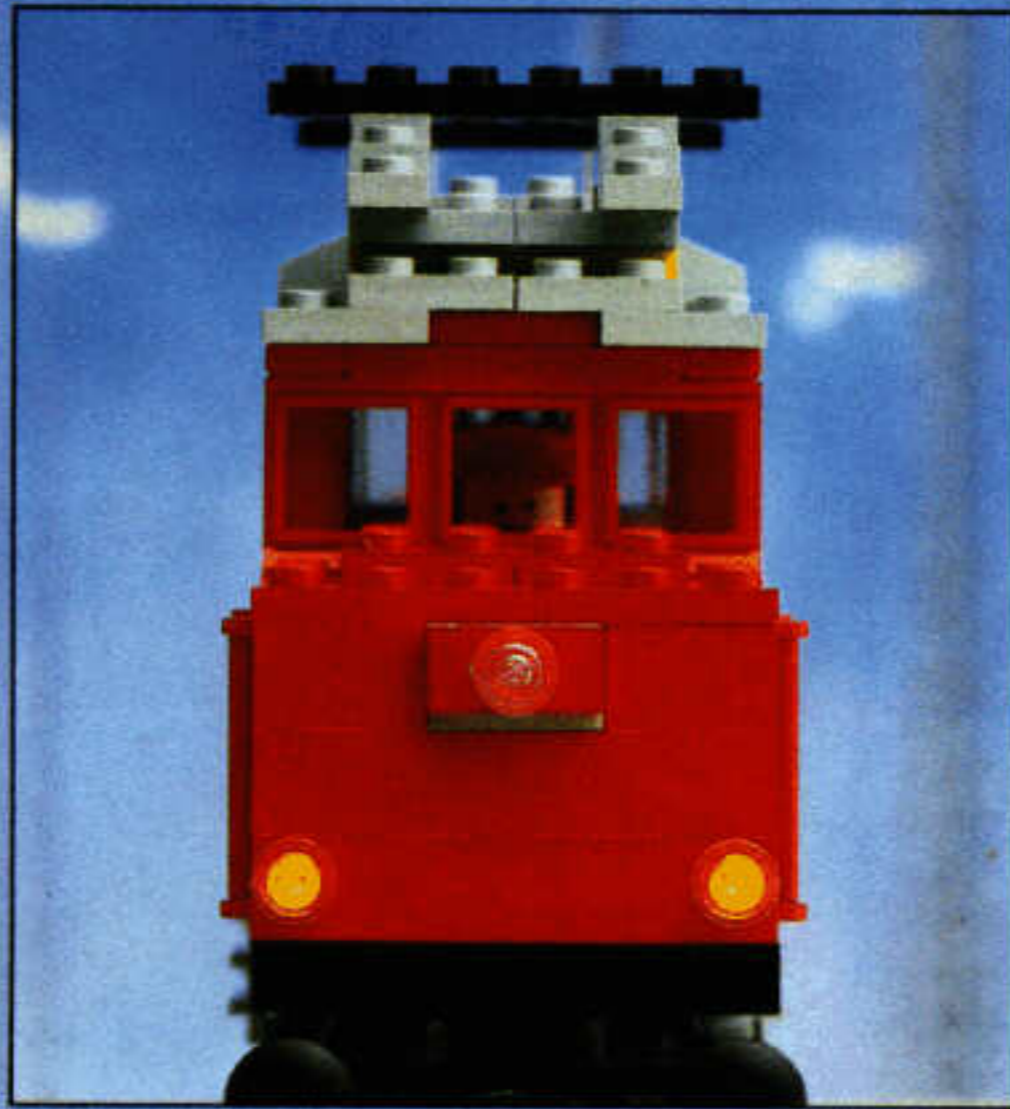
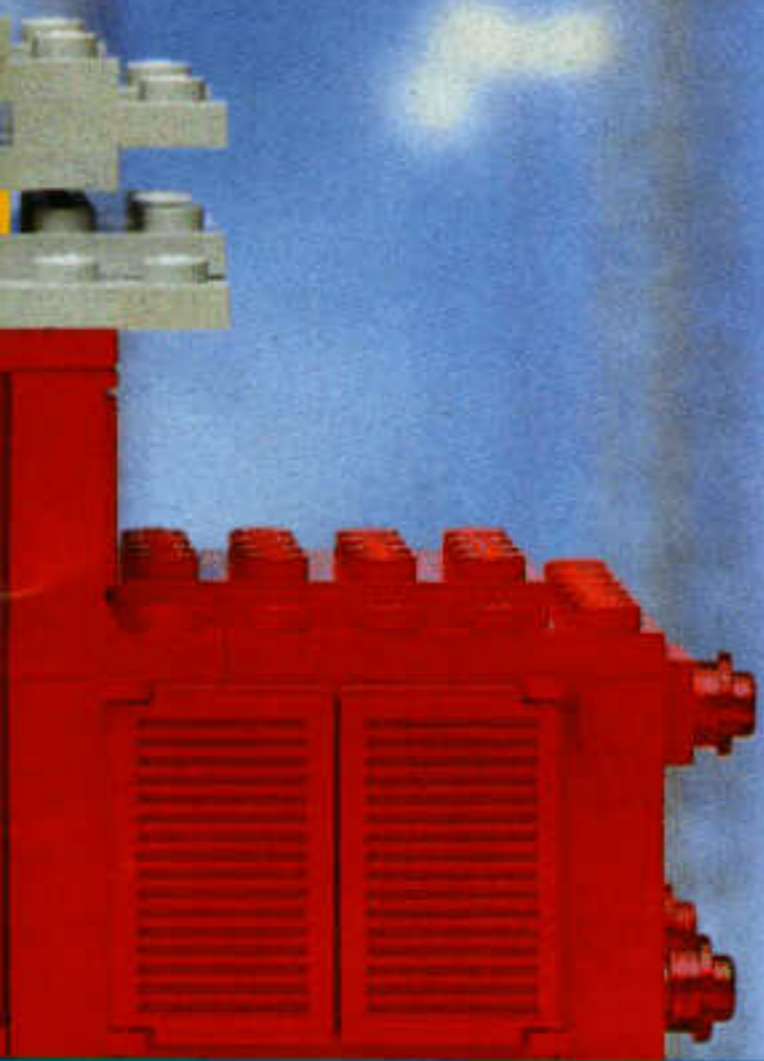
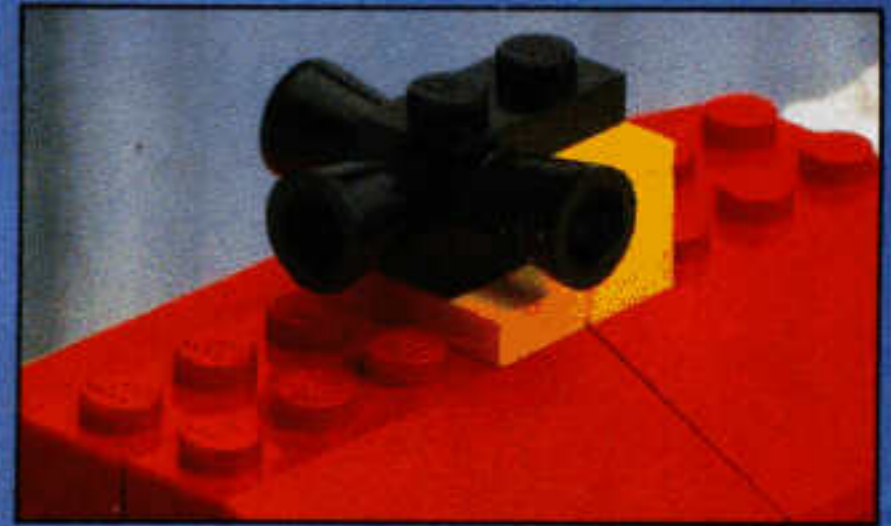
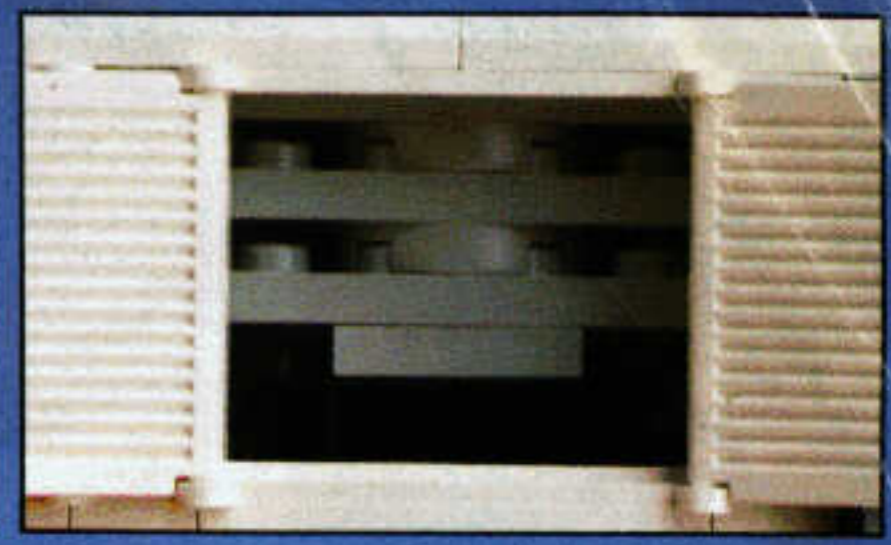

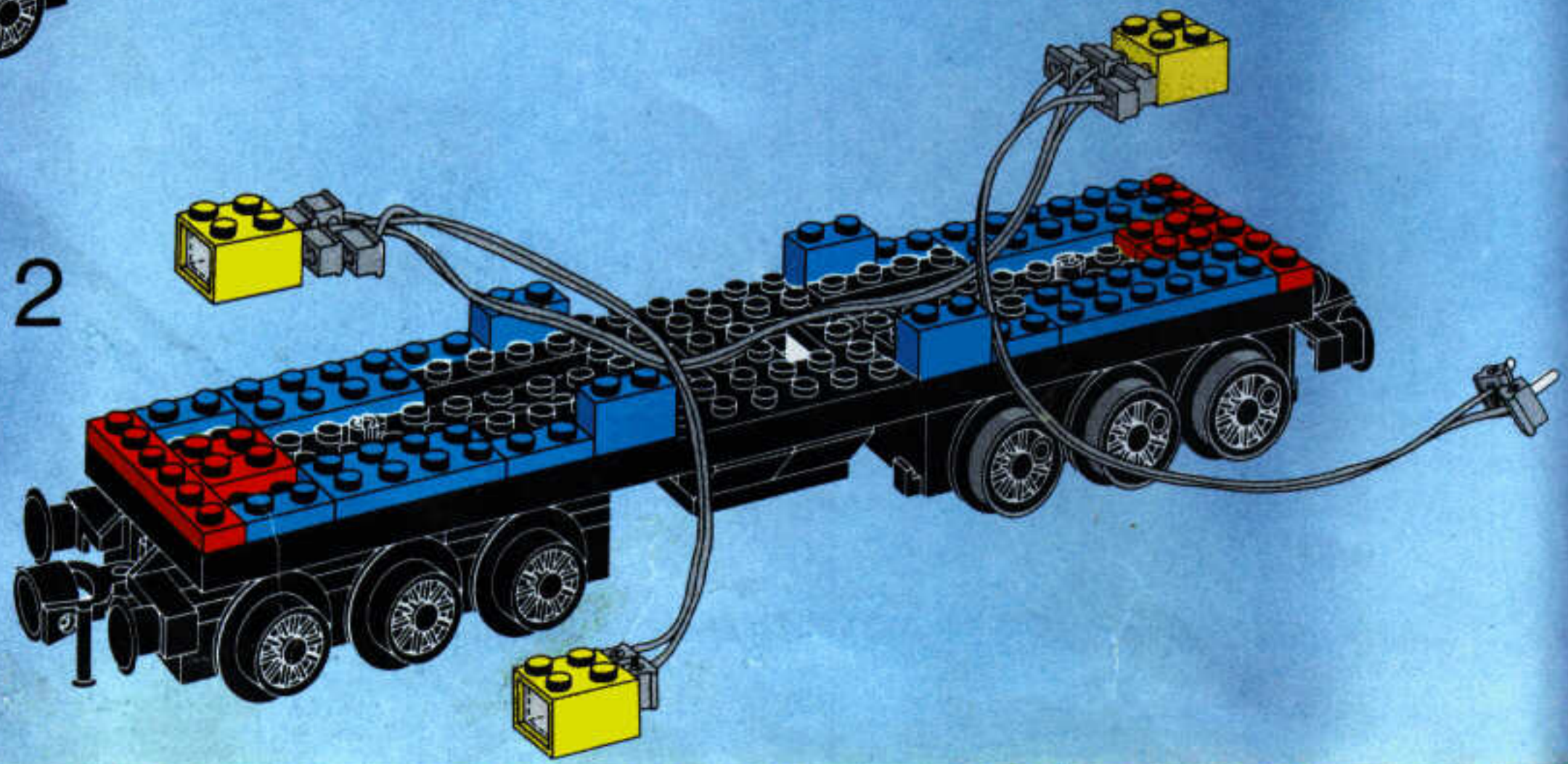
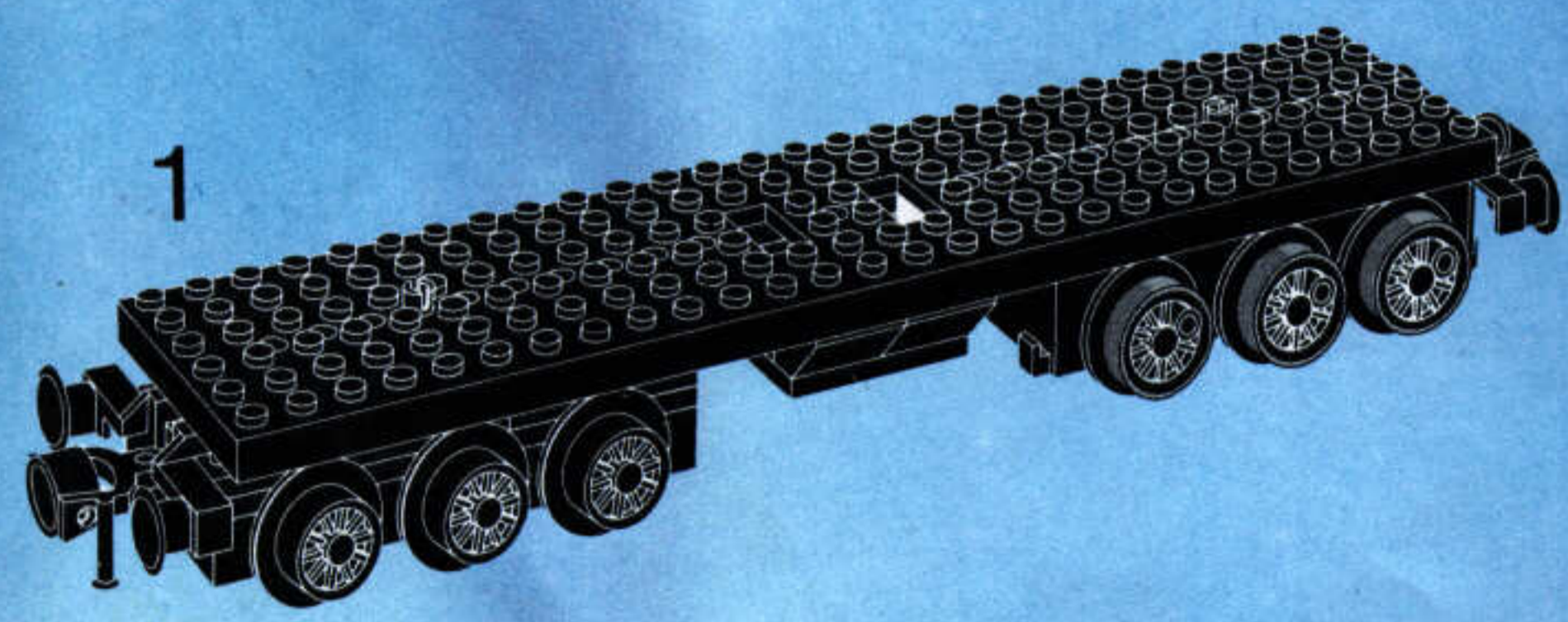
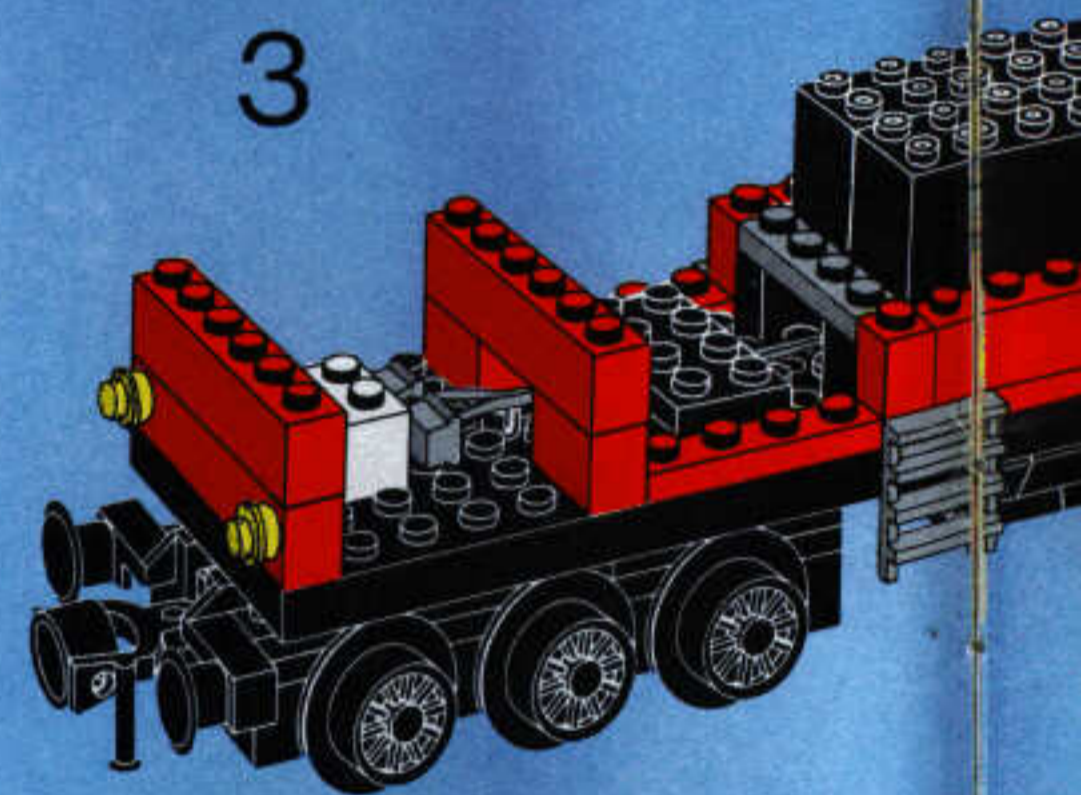
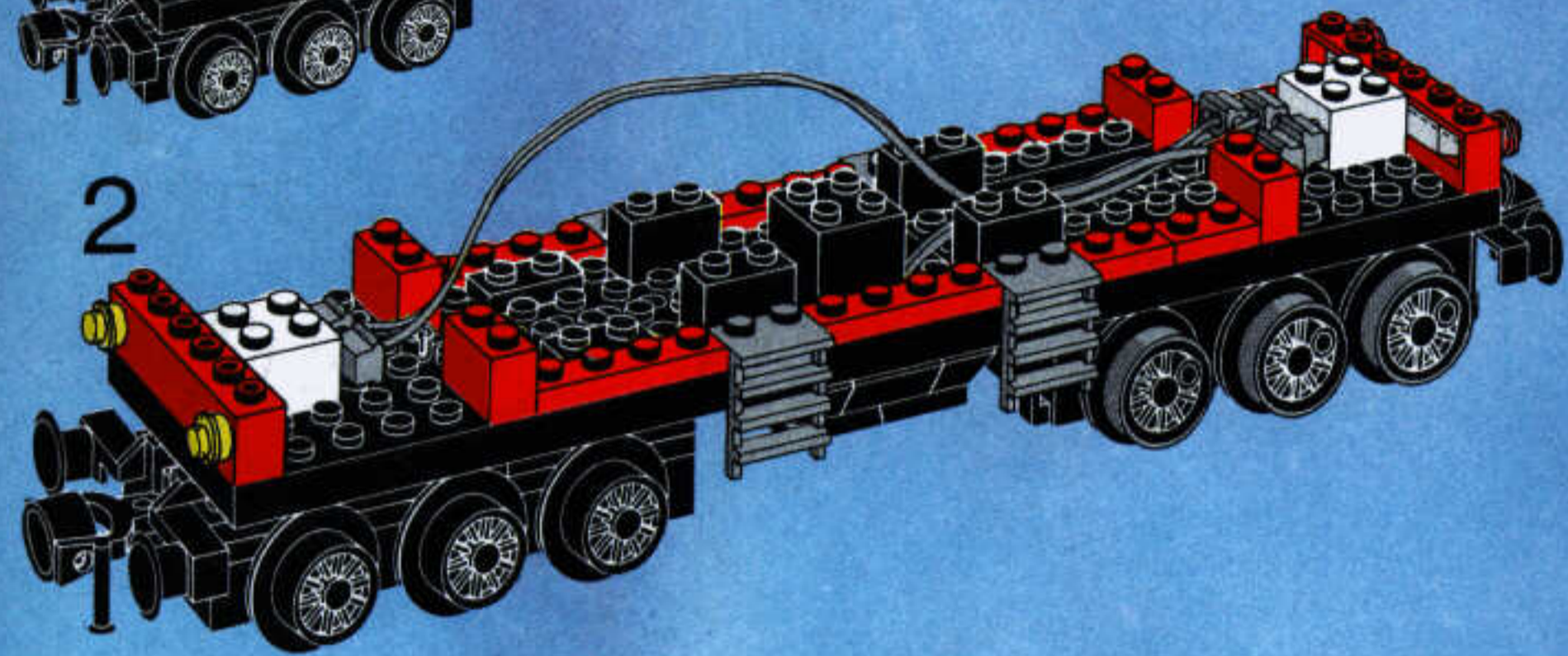
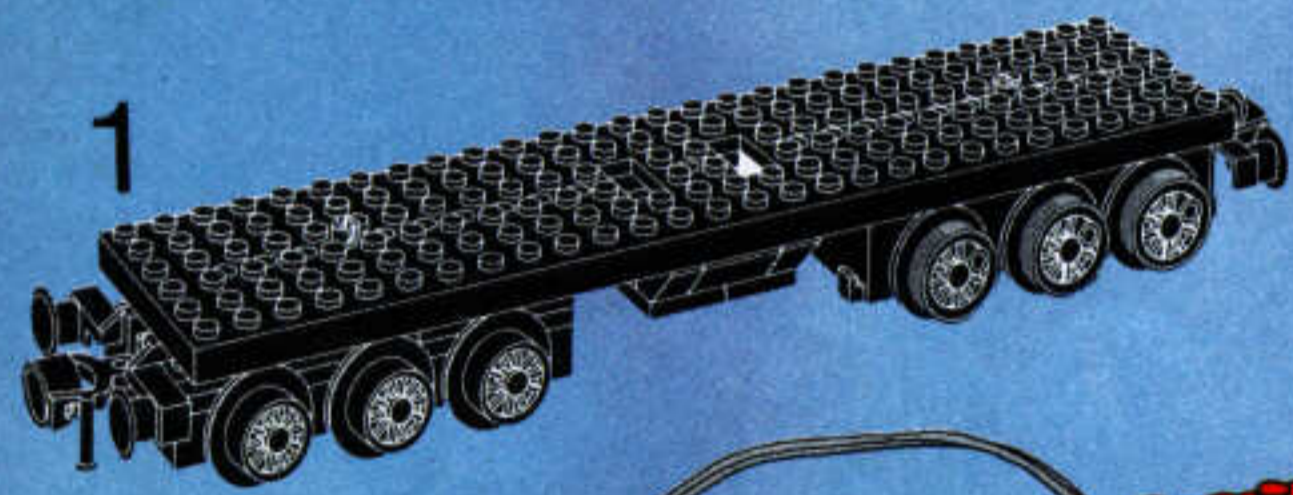
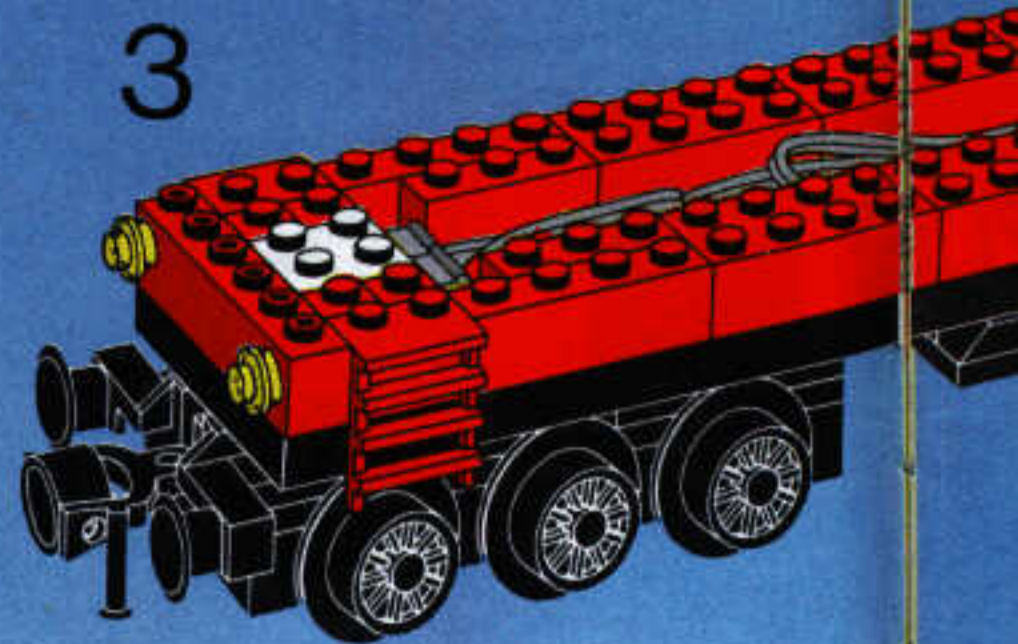
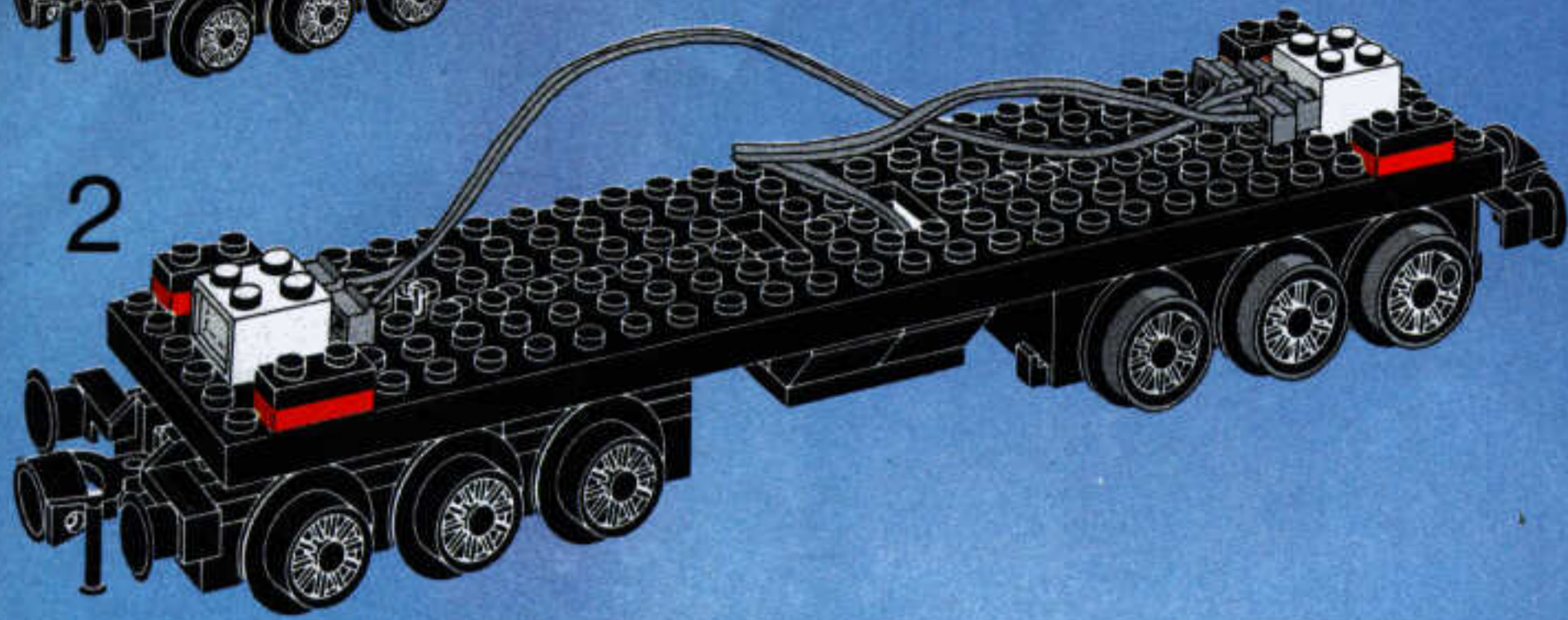
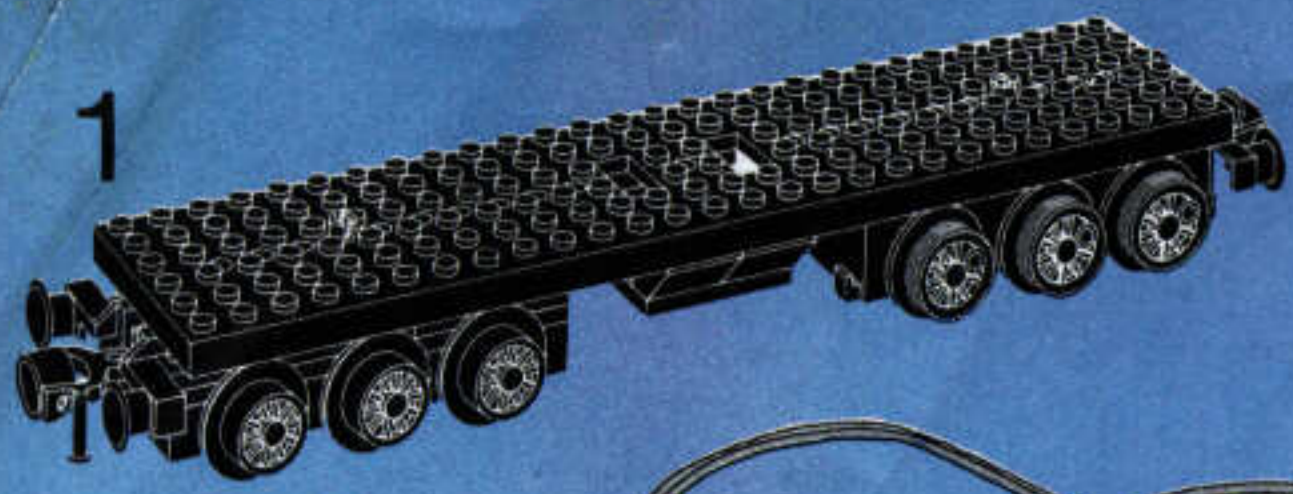

A

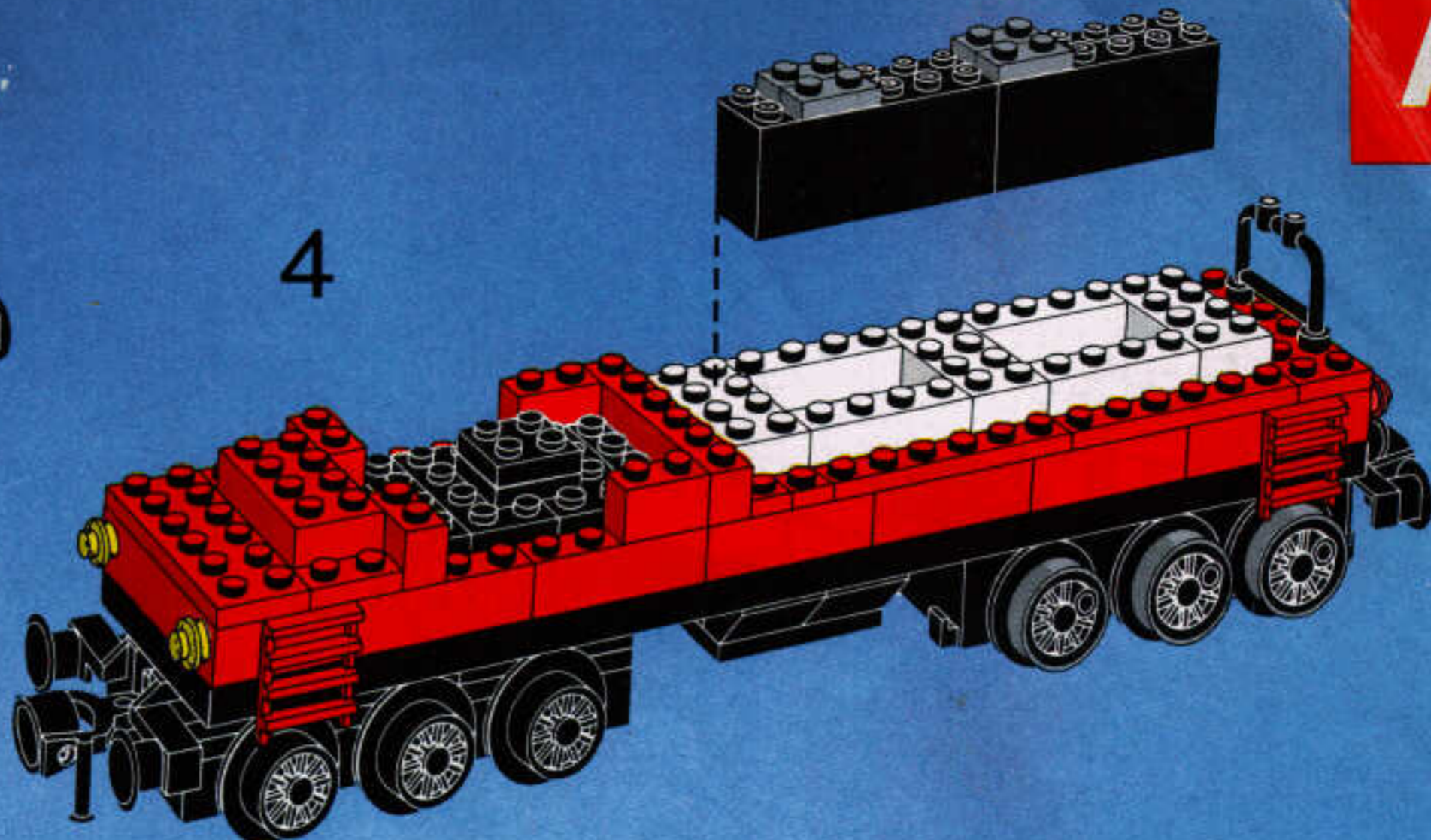
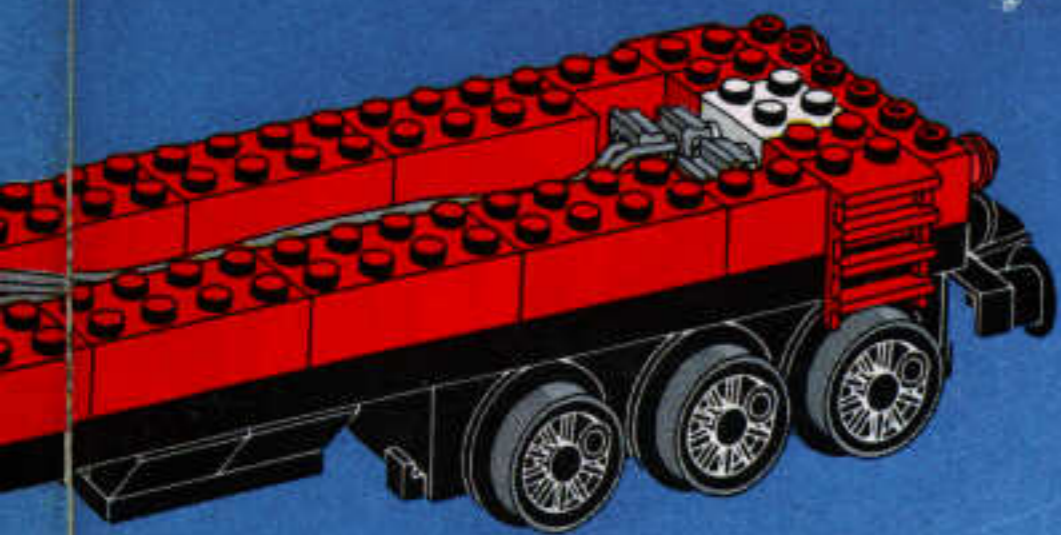

B

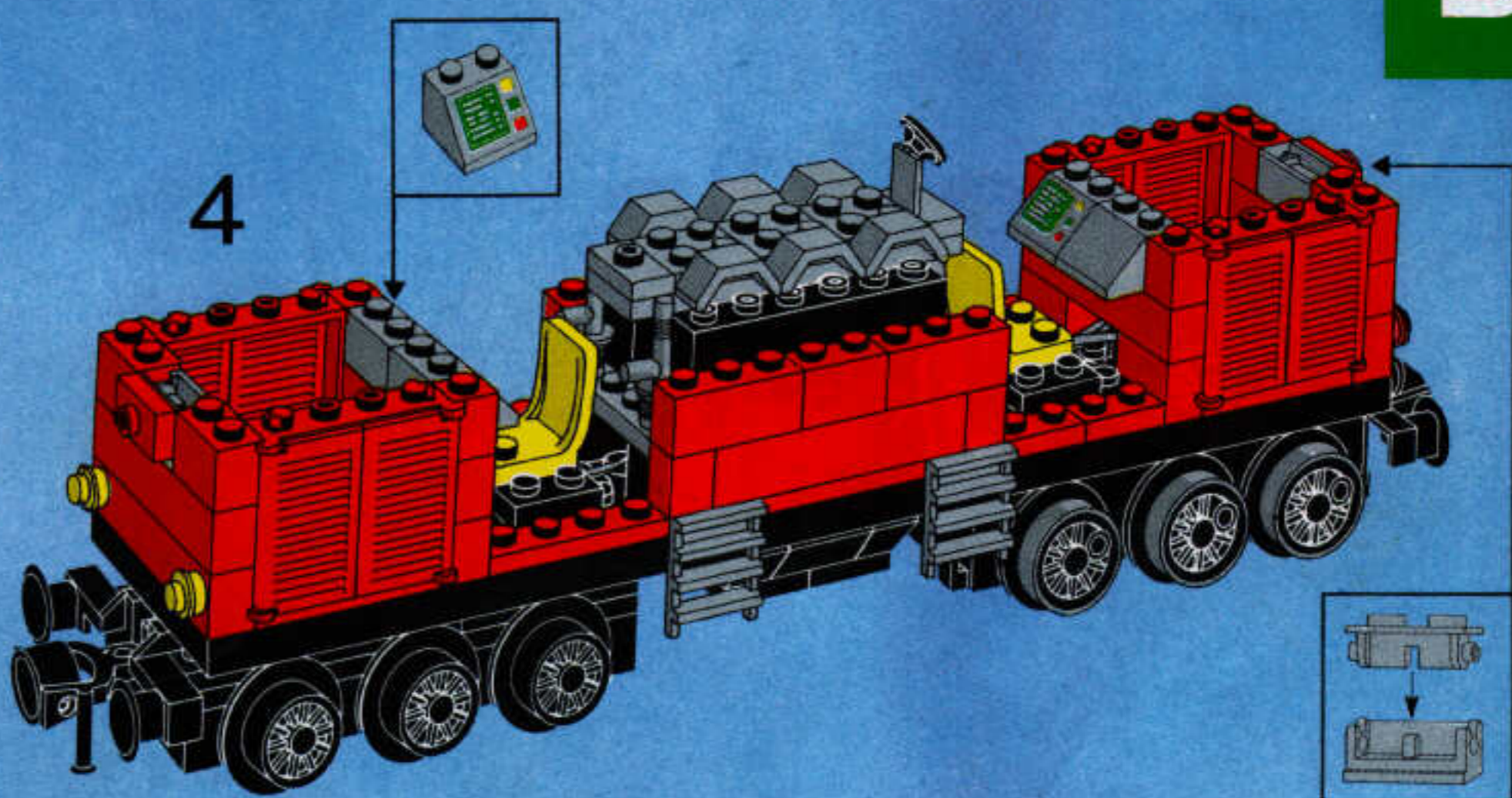
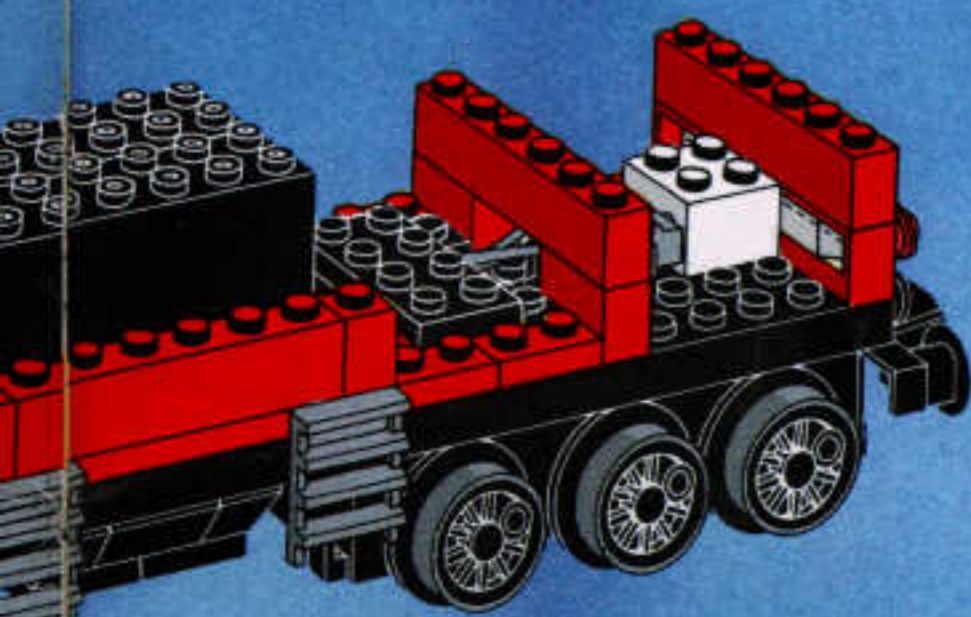

C

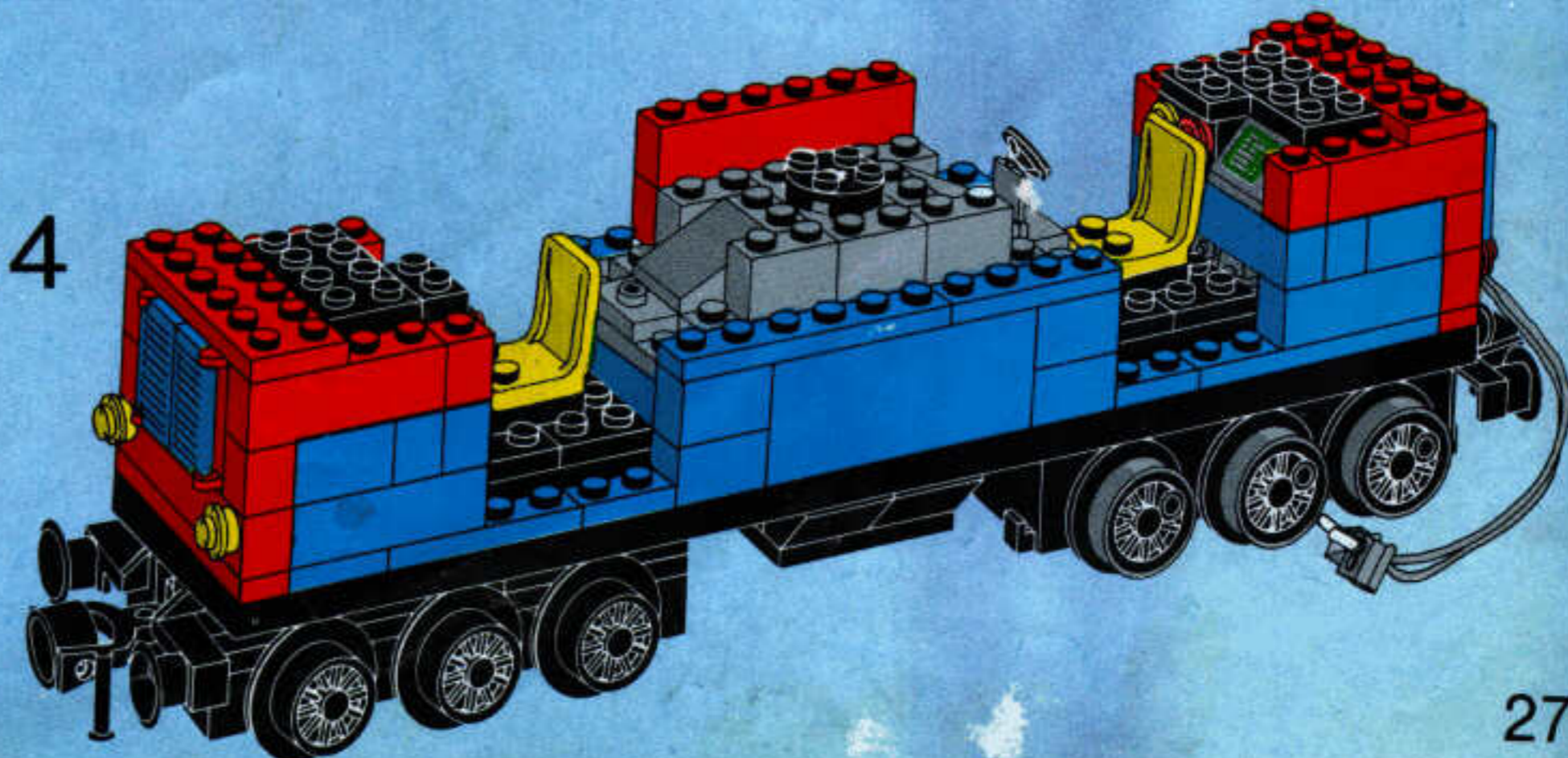
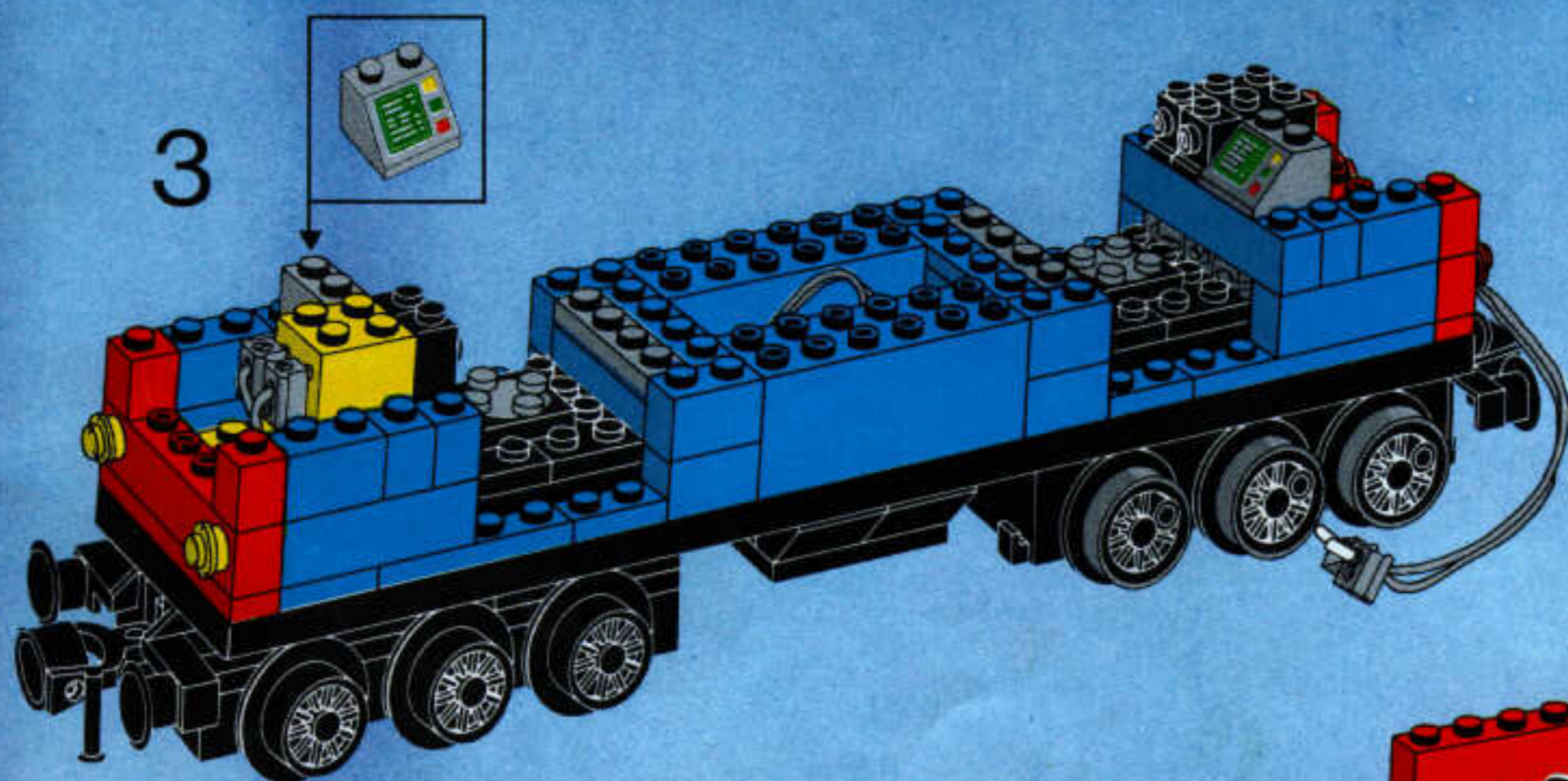

5

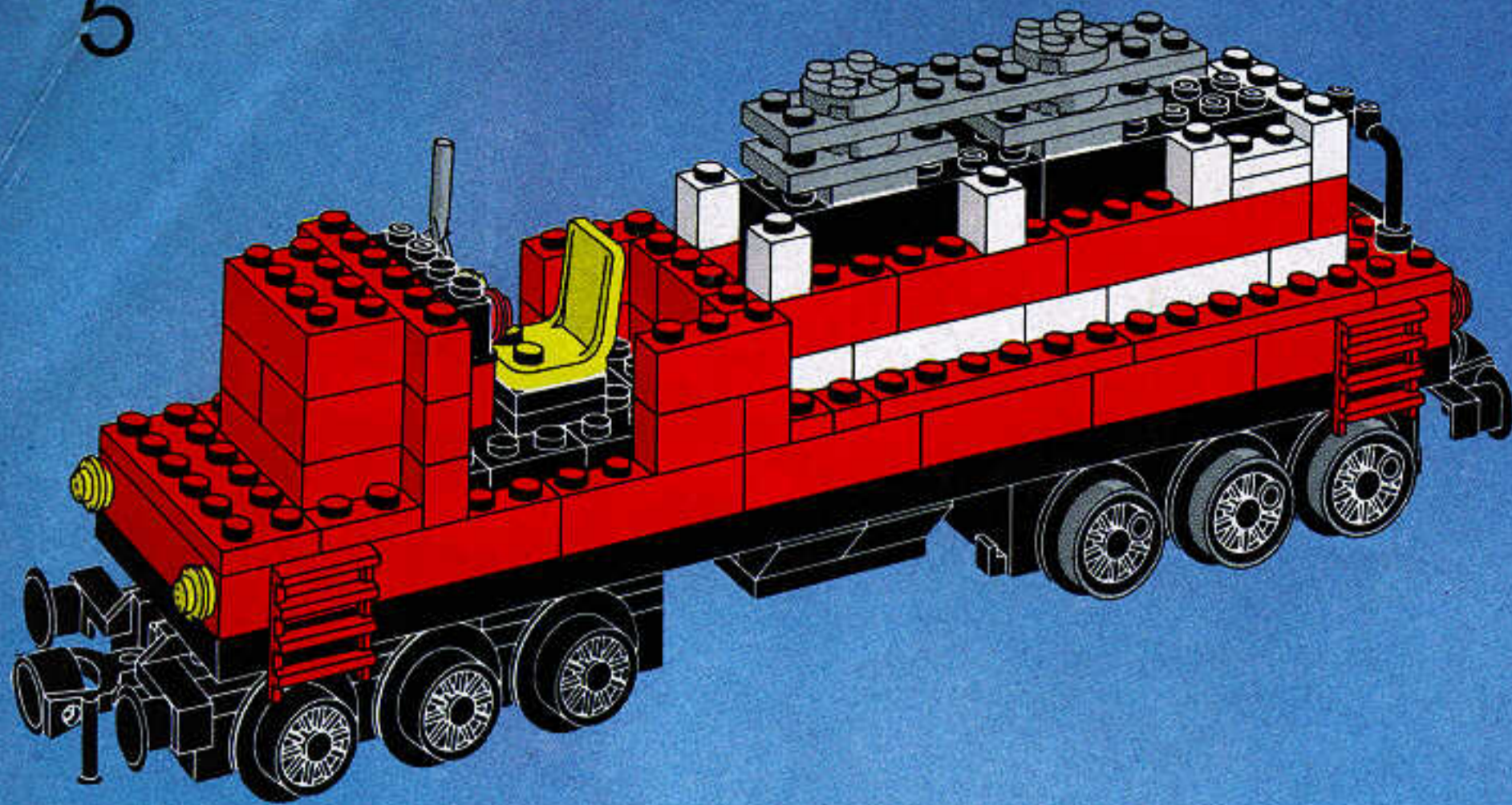

6

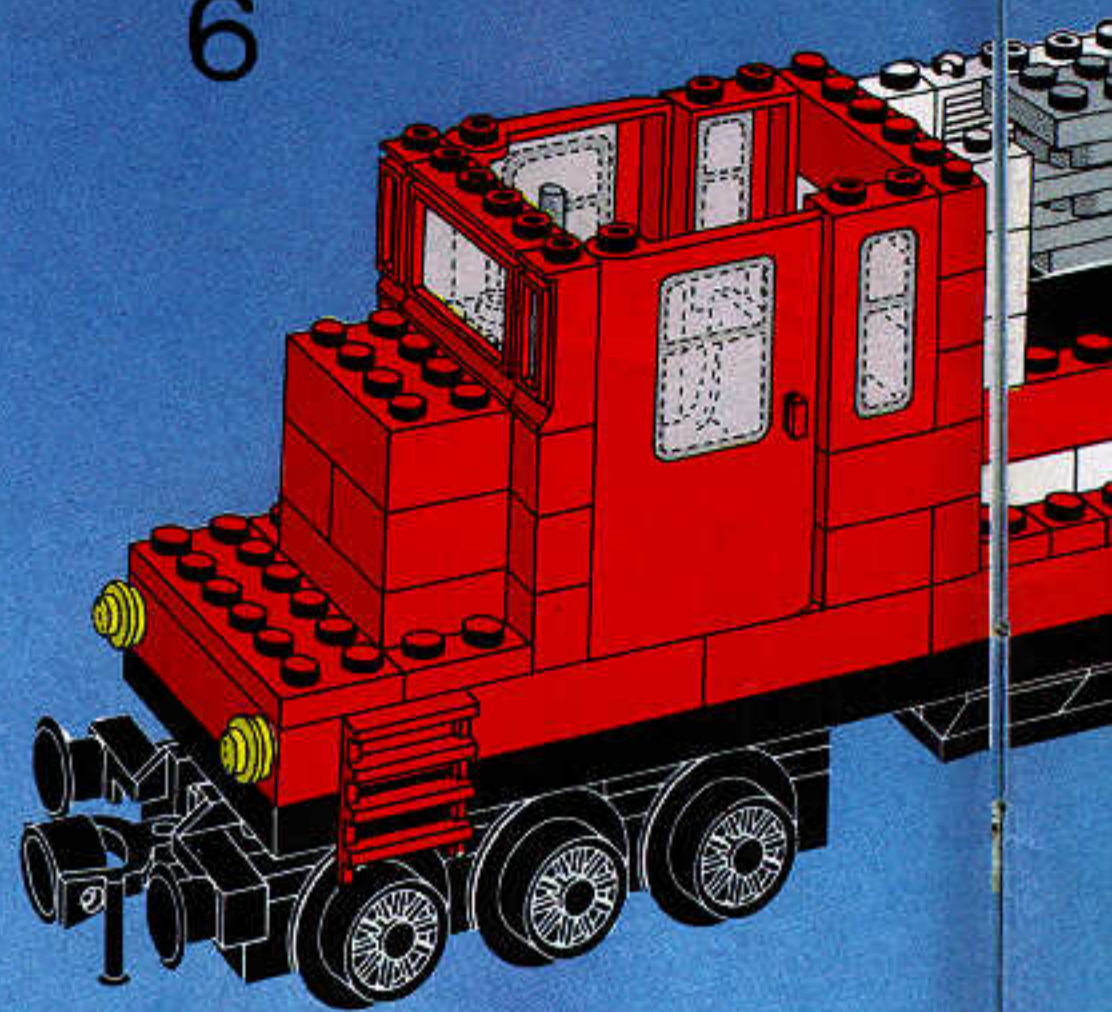

5

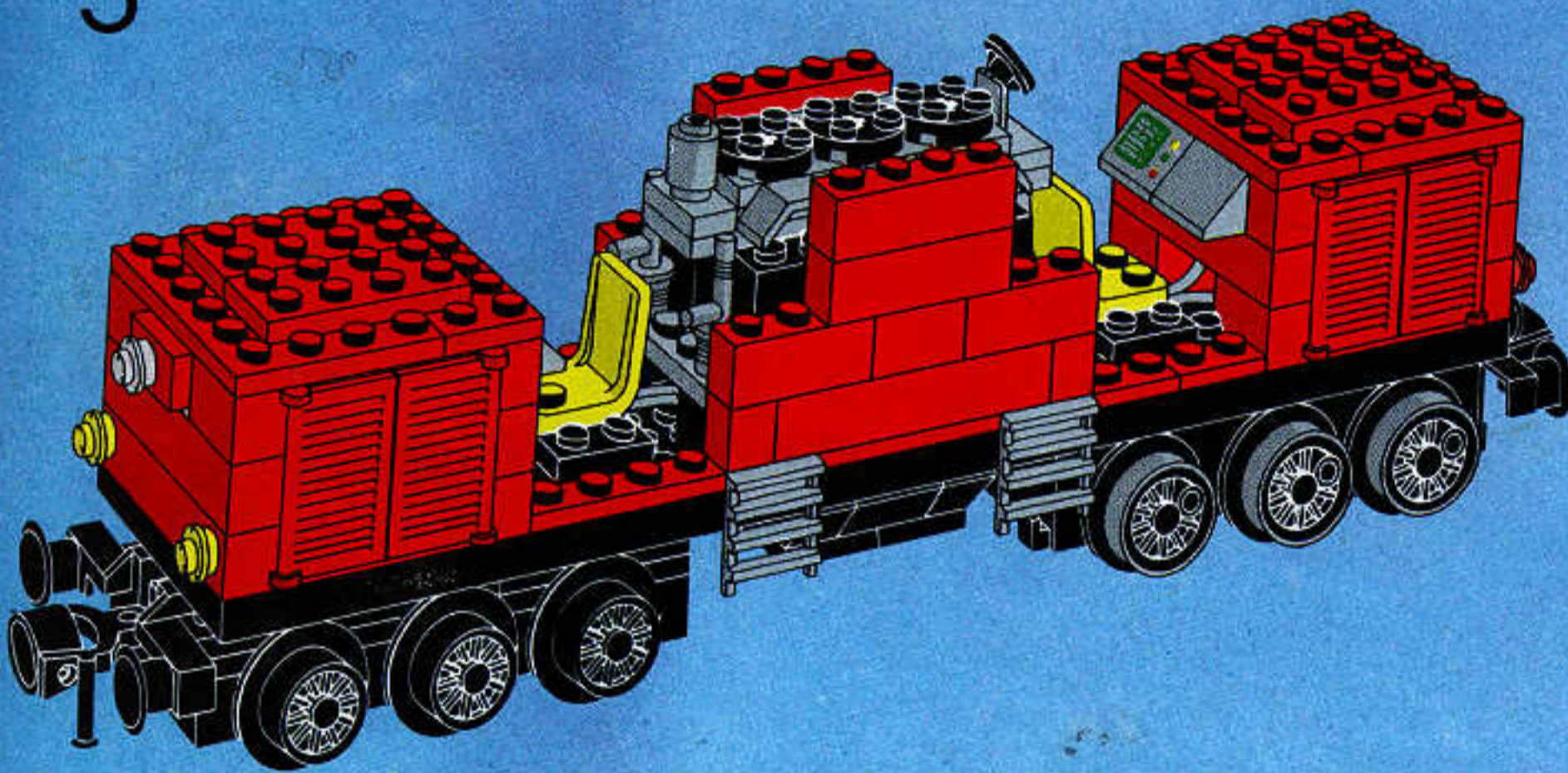

6

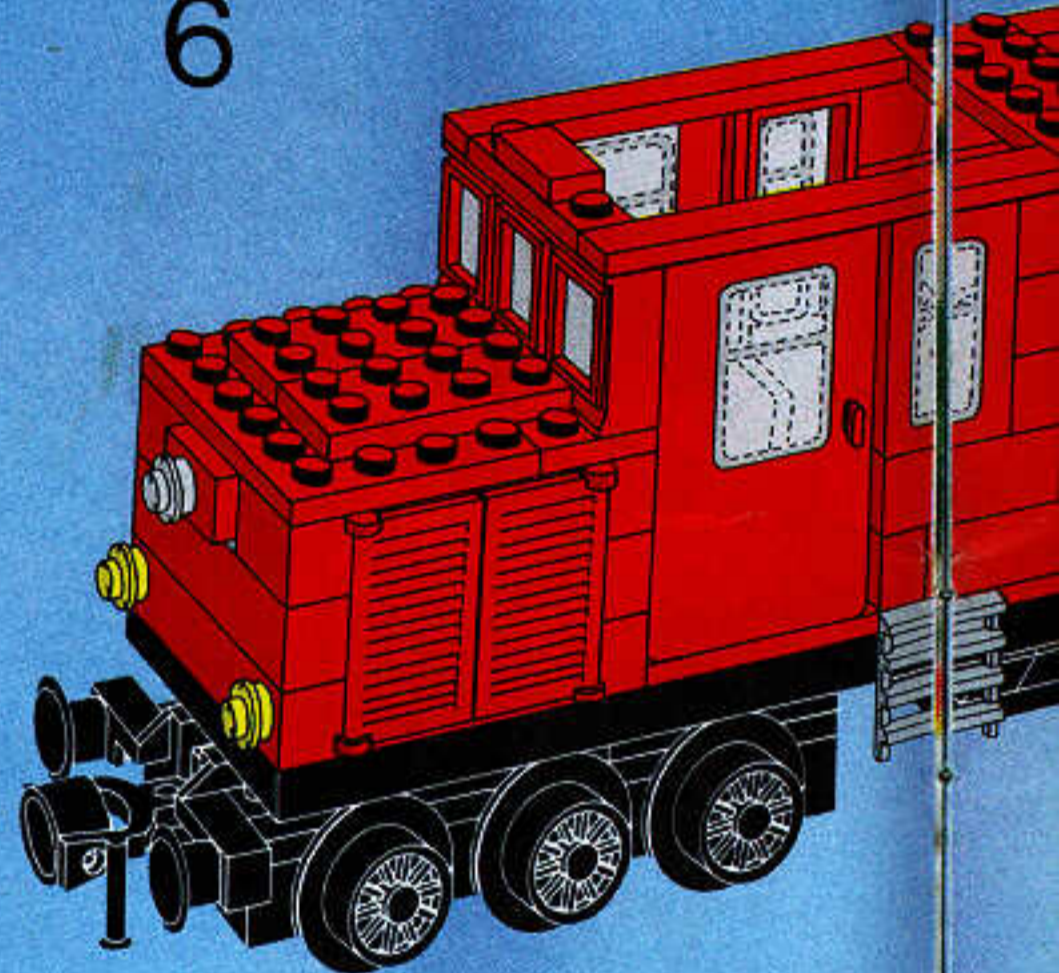

1

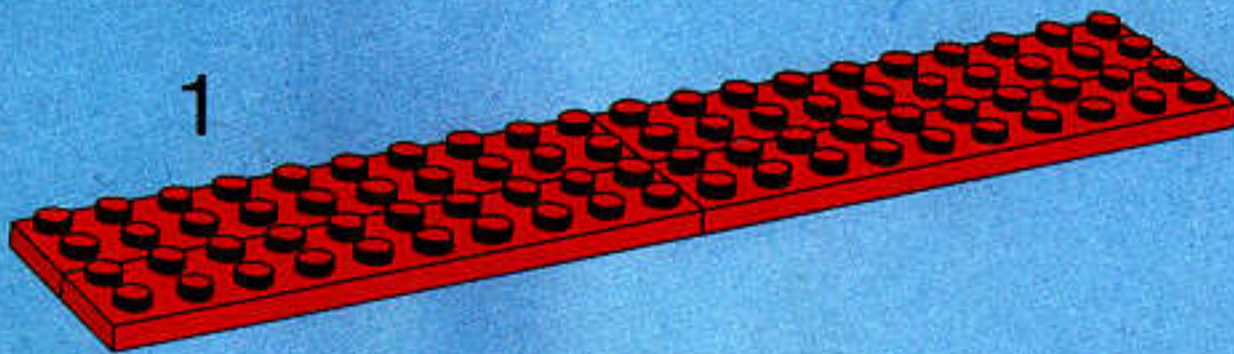

2

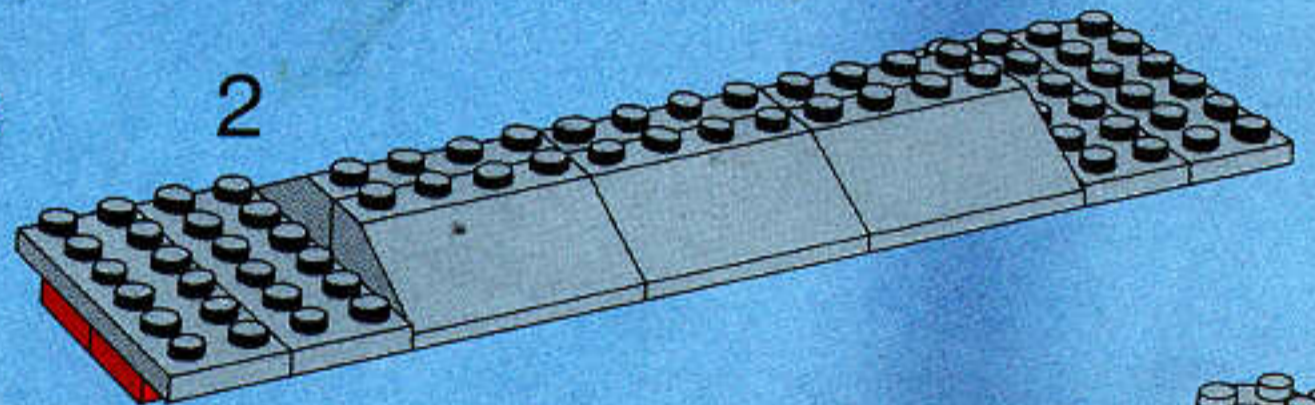

3

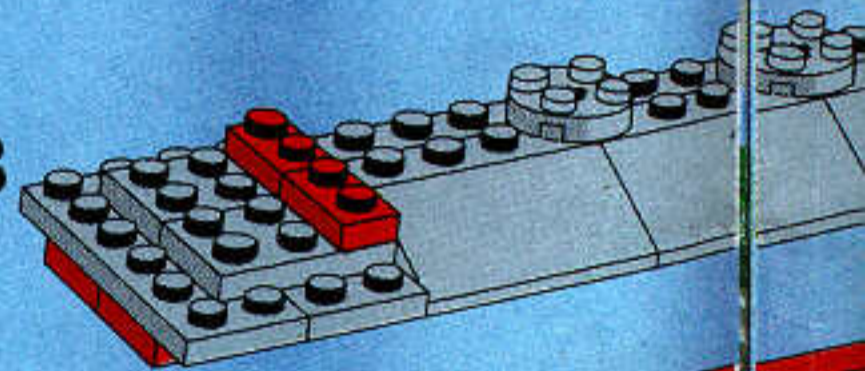

5

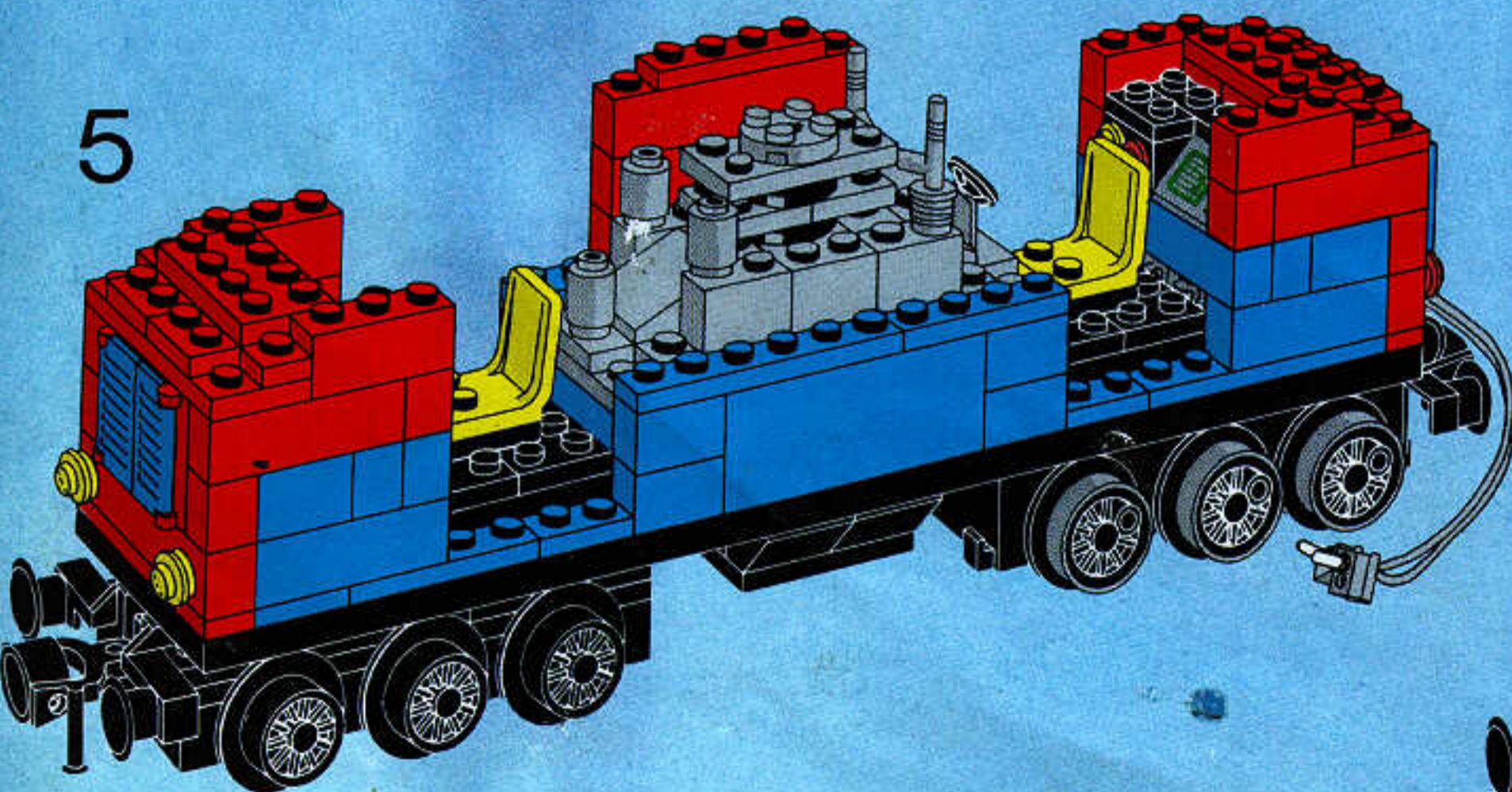

6

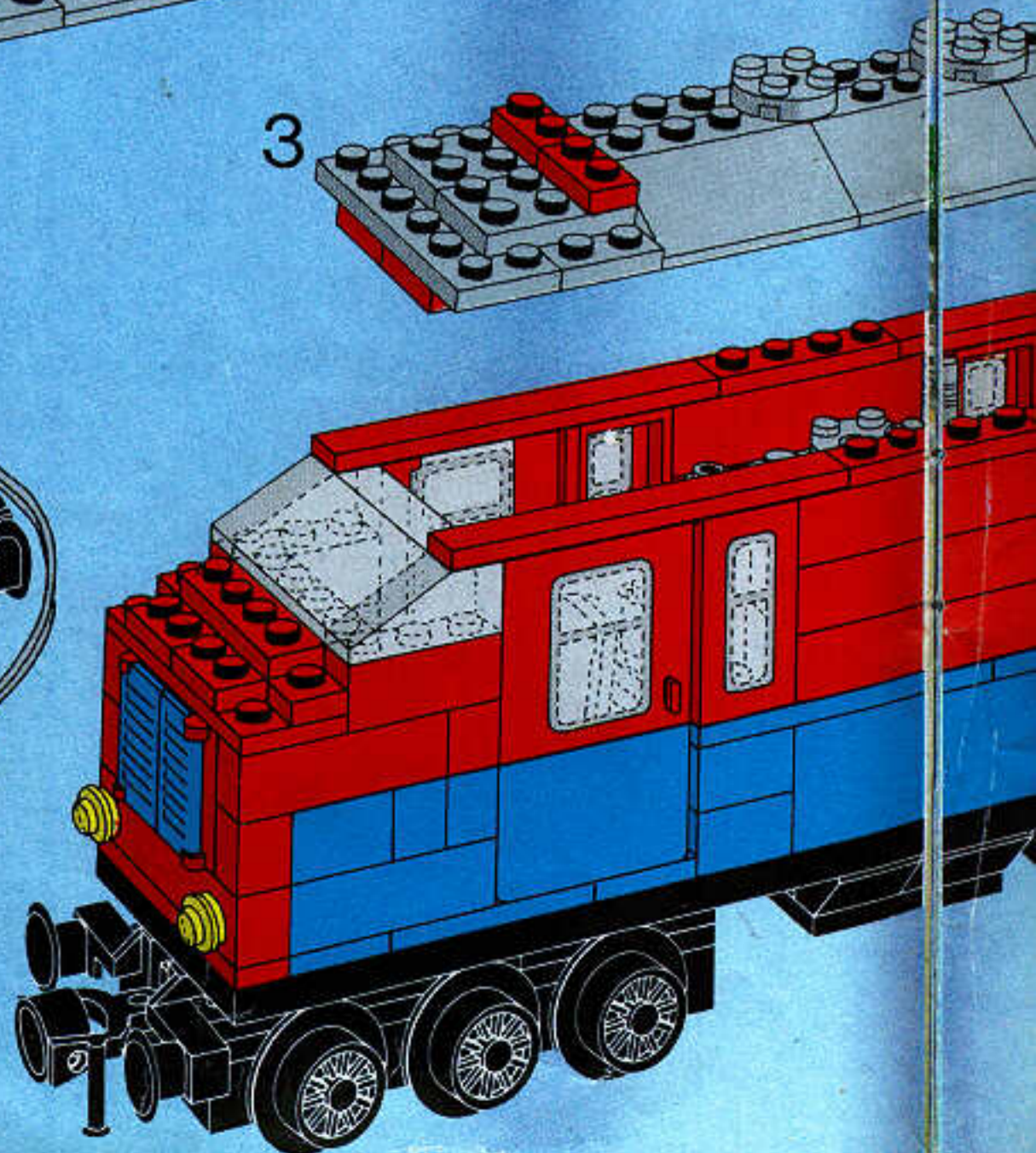

A

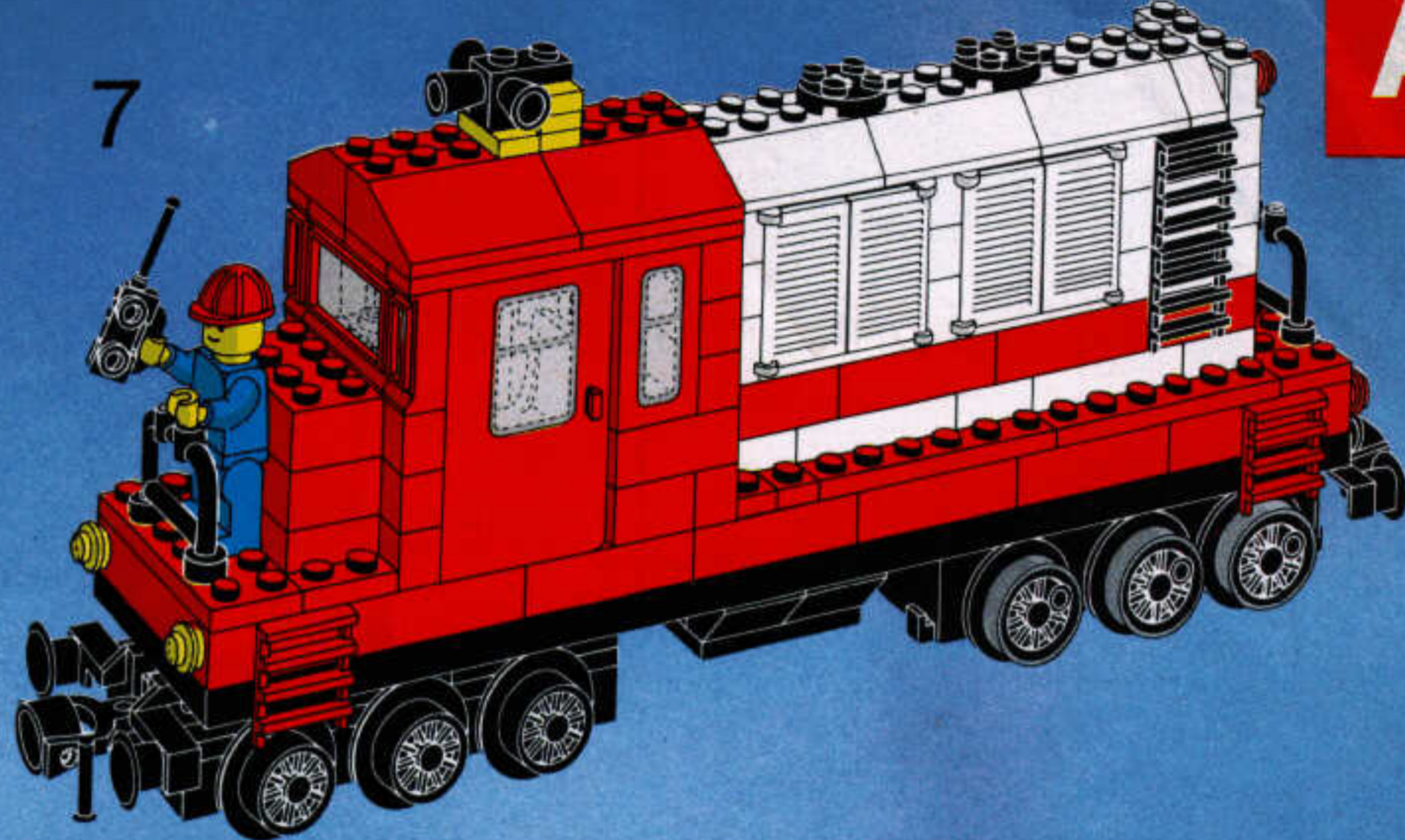
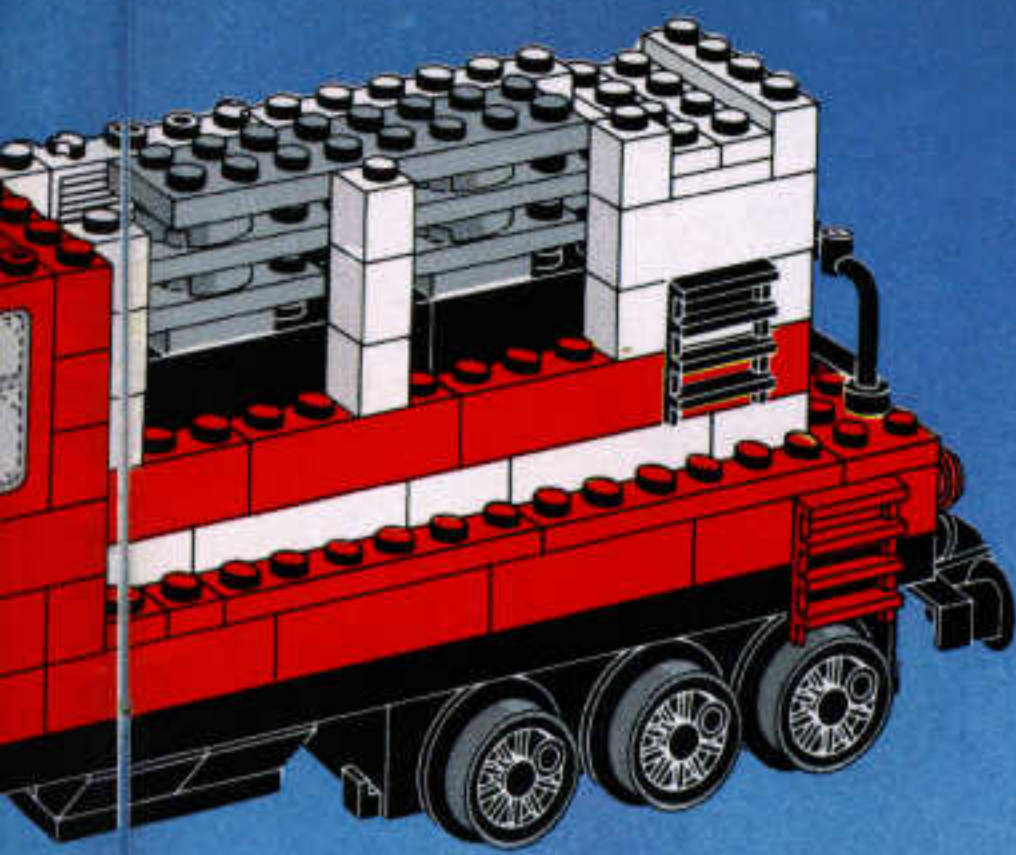

B

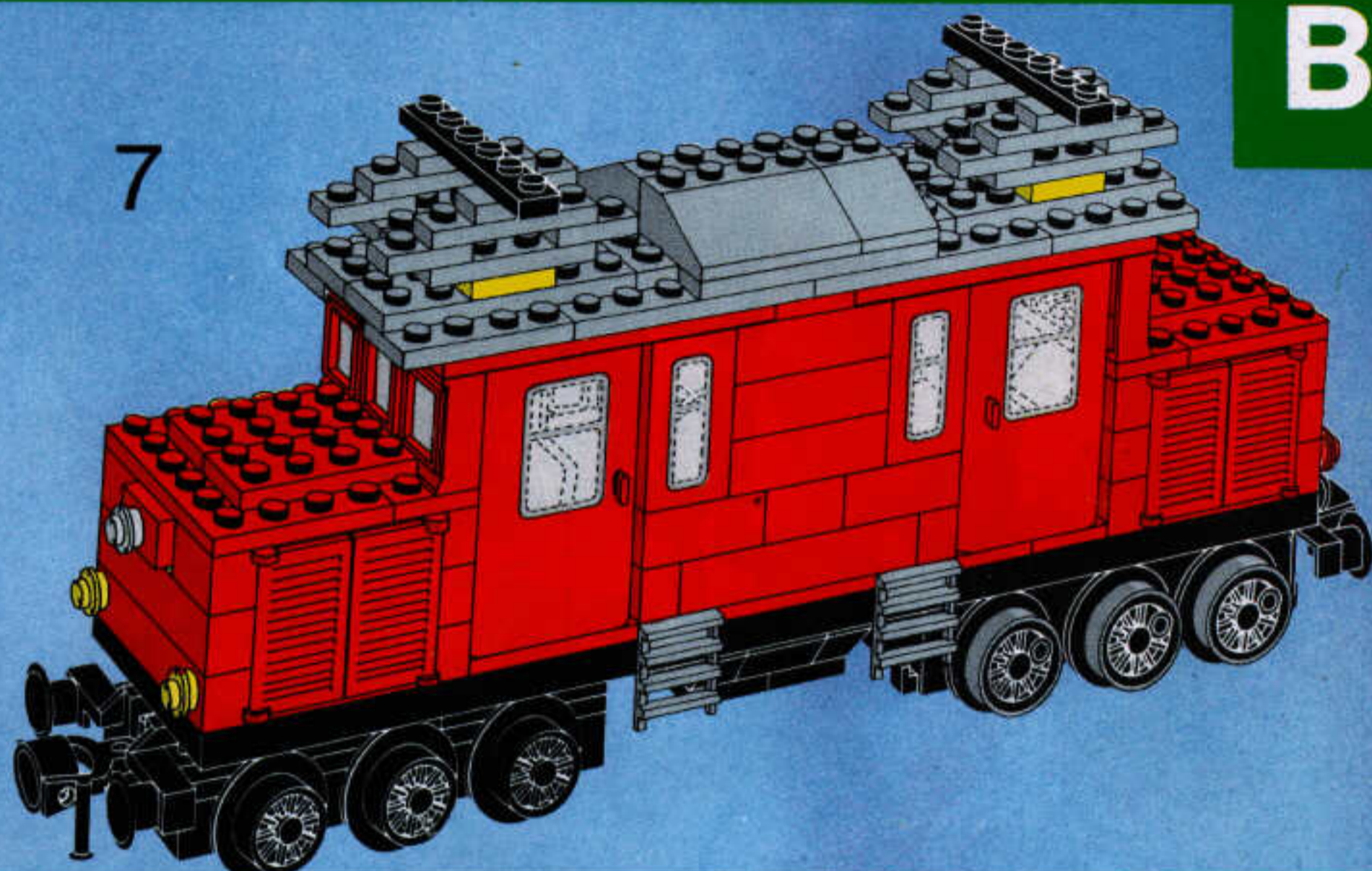
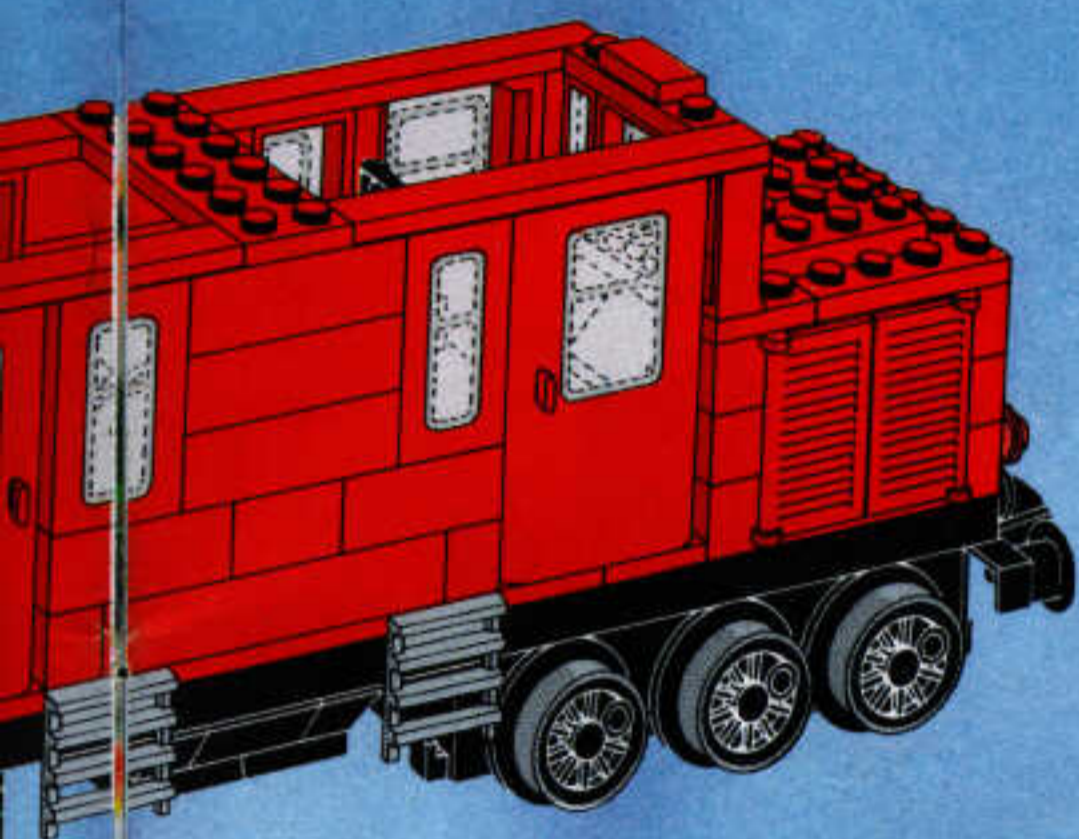

C

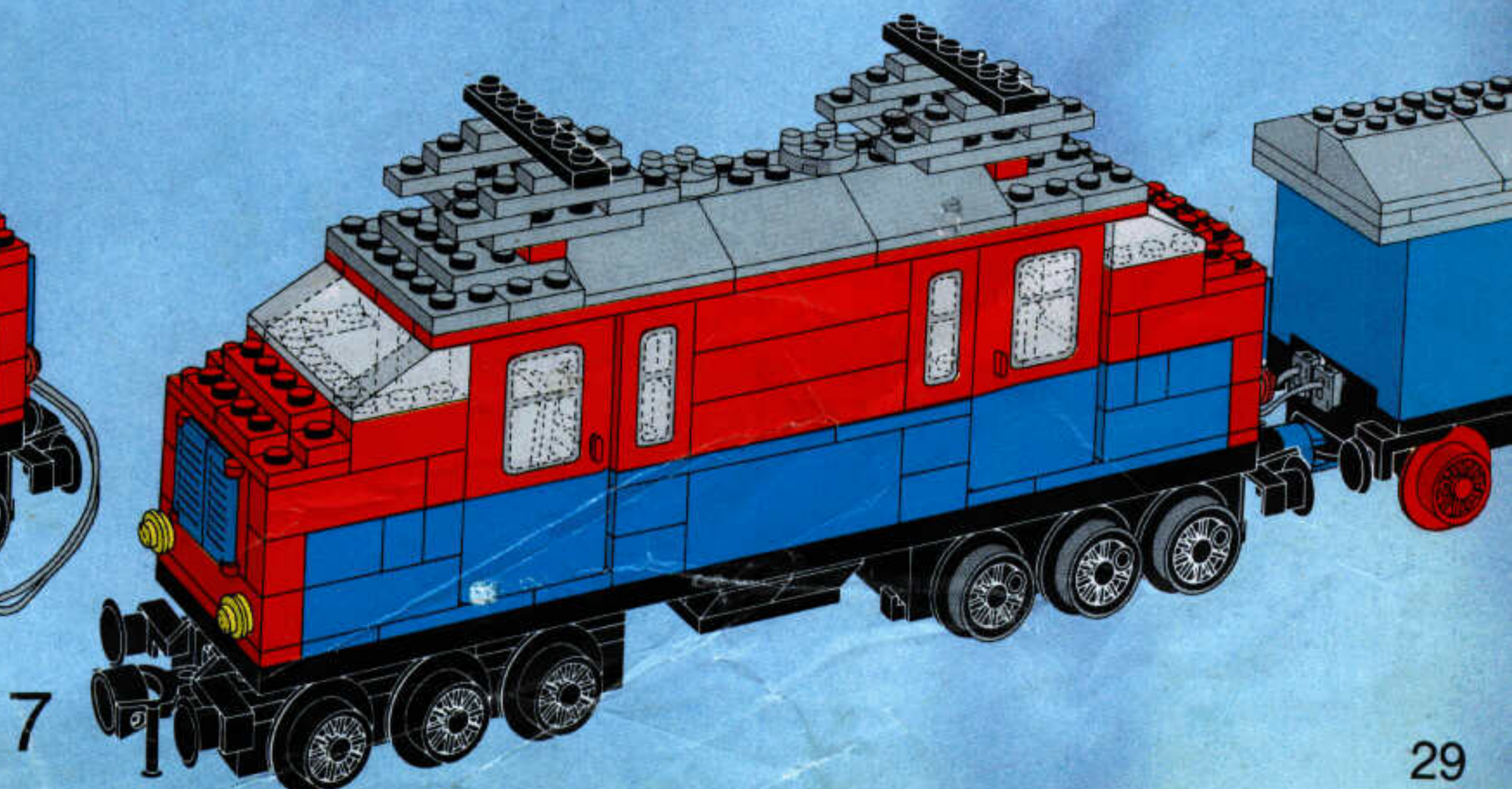
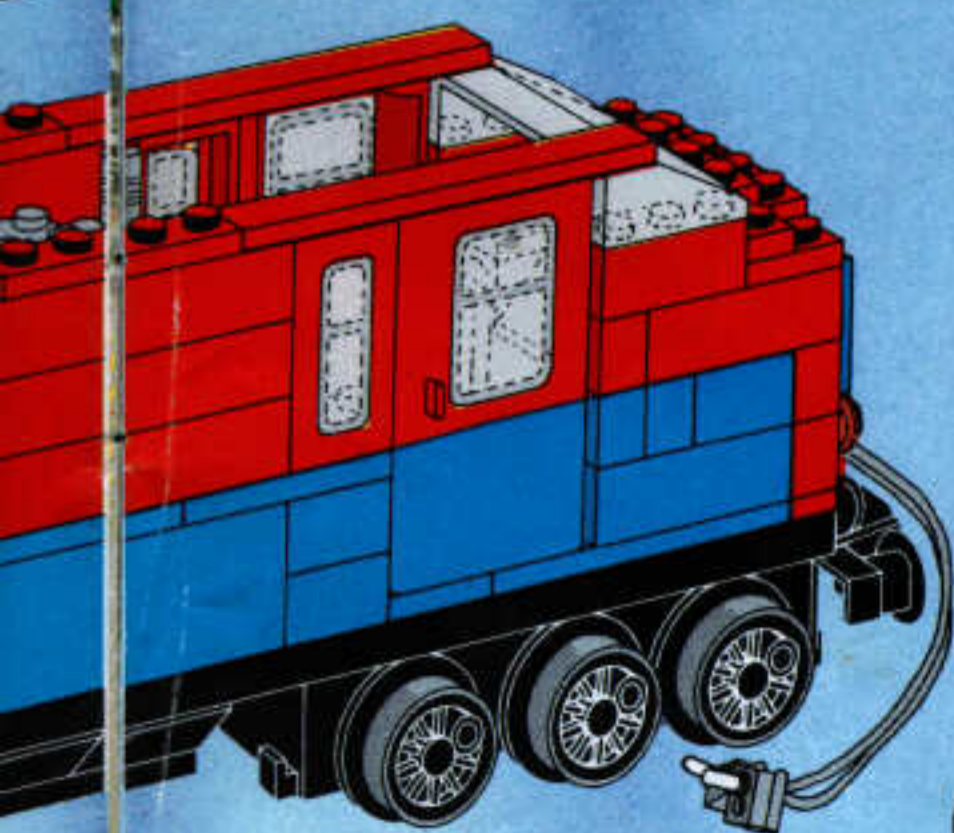
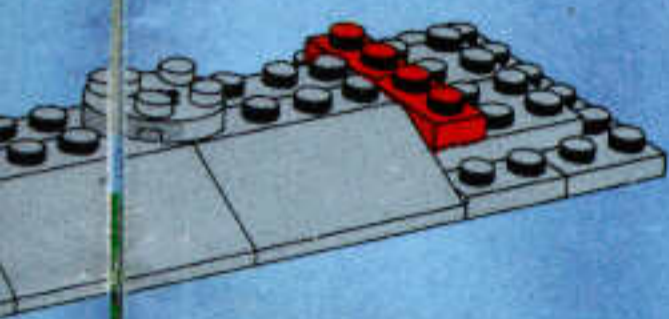



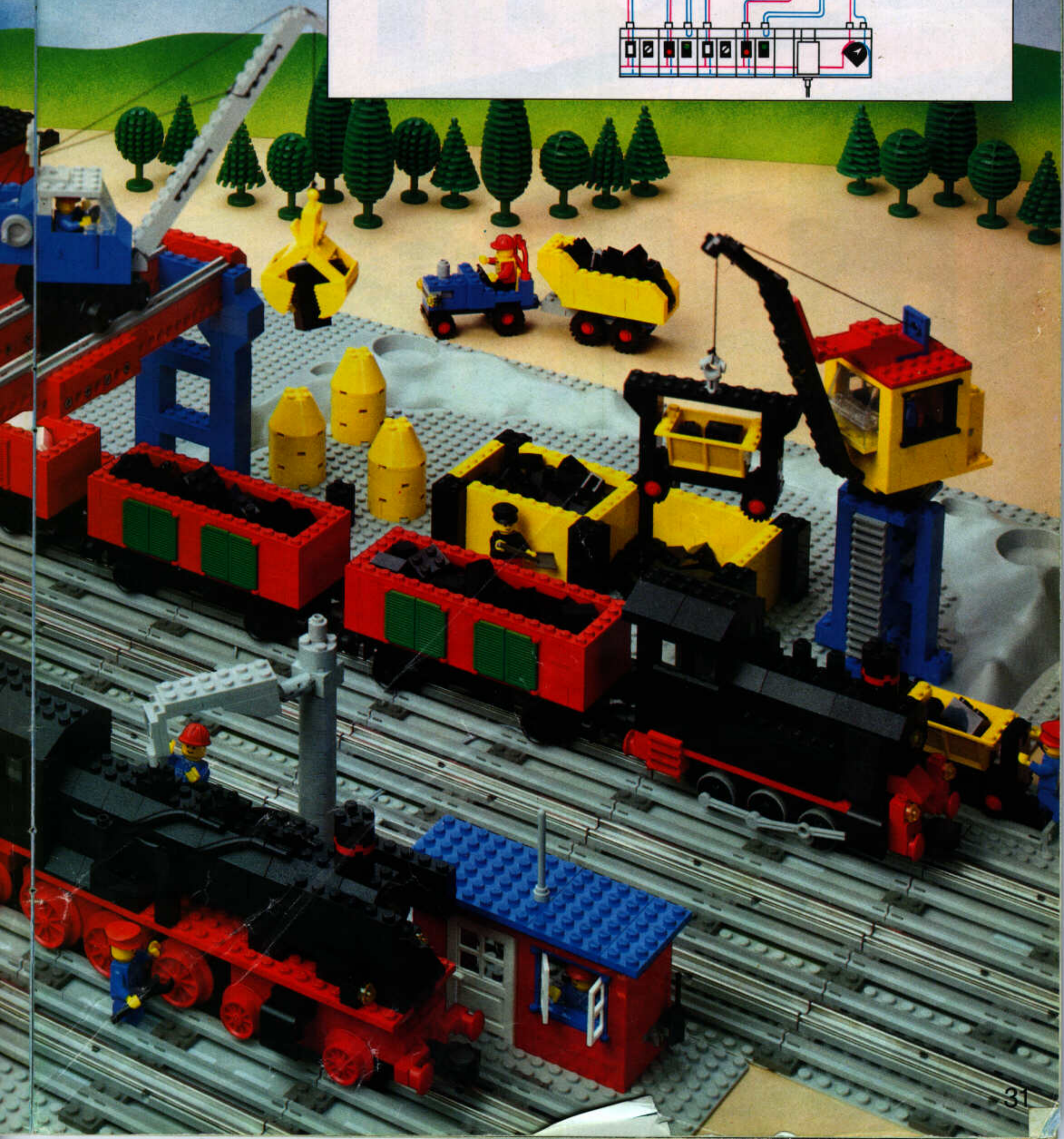
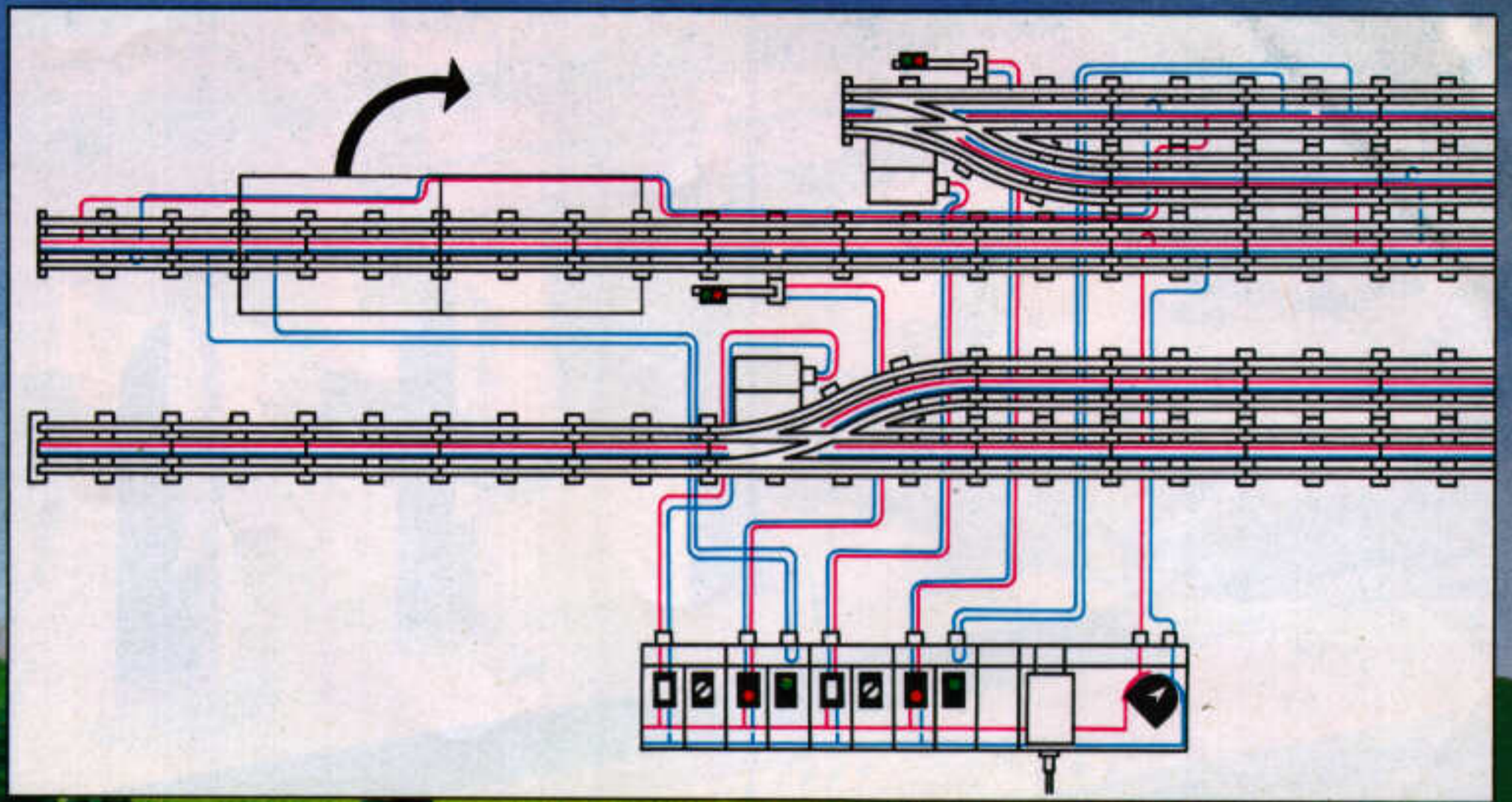

**A****B**



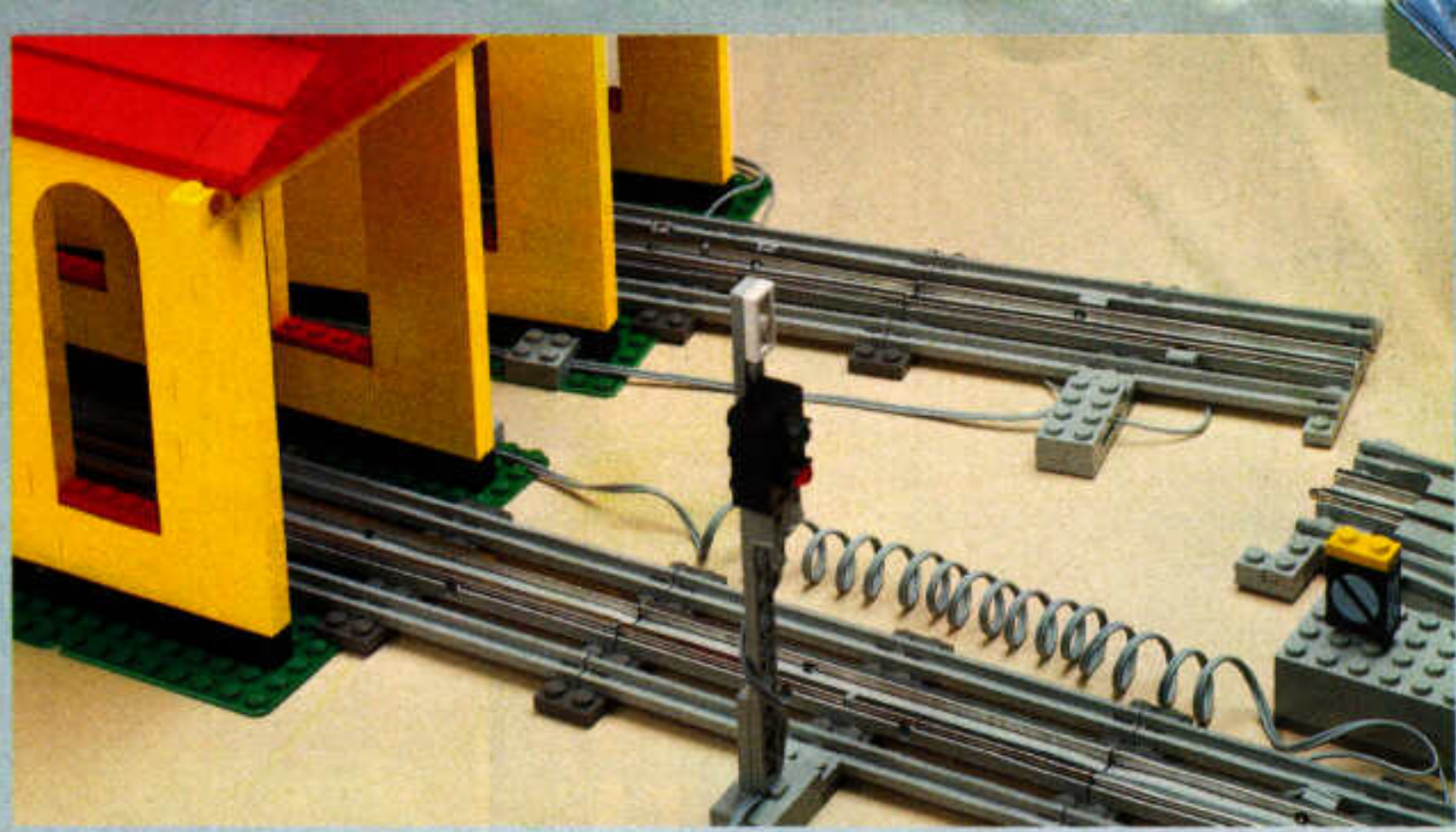

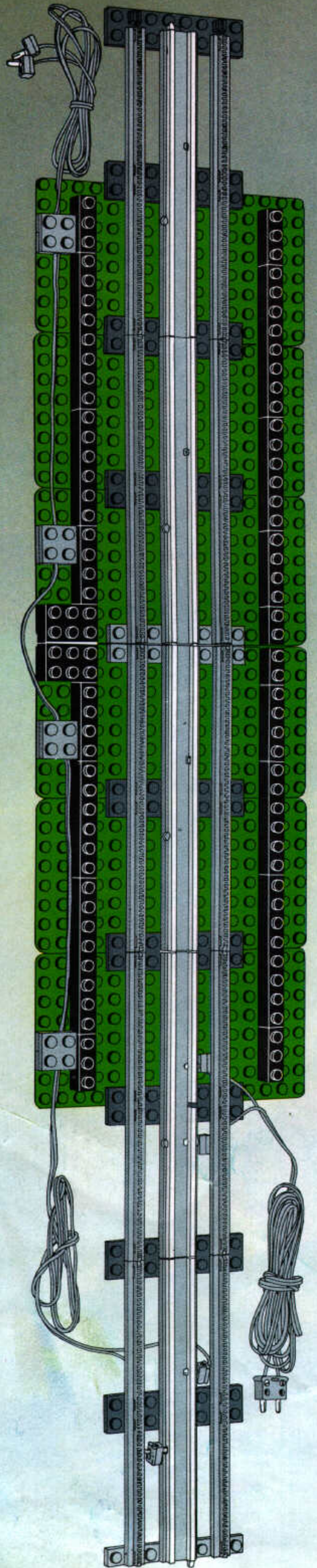
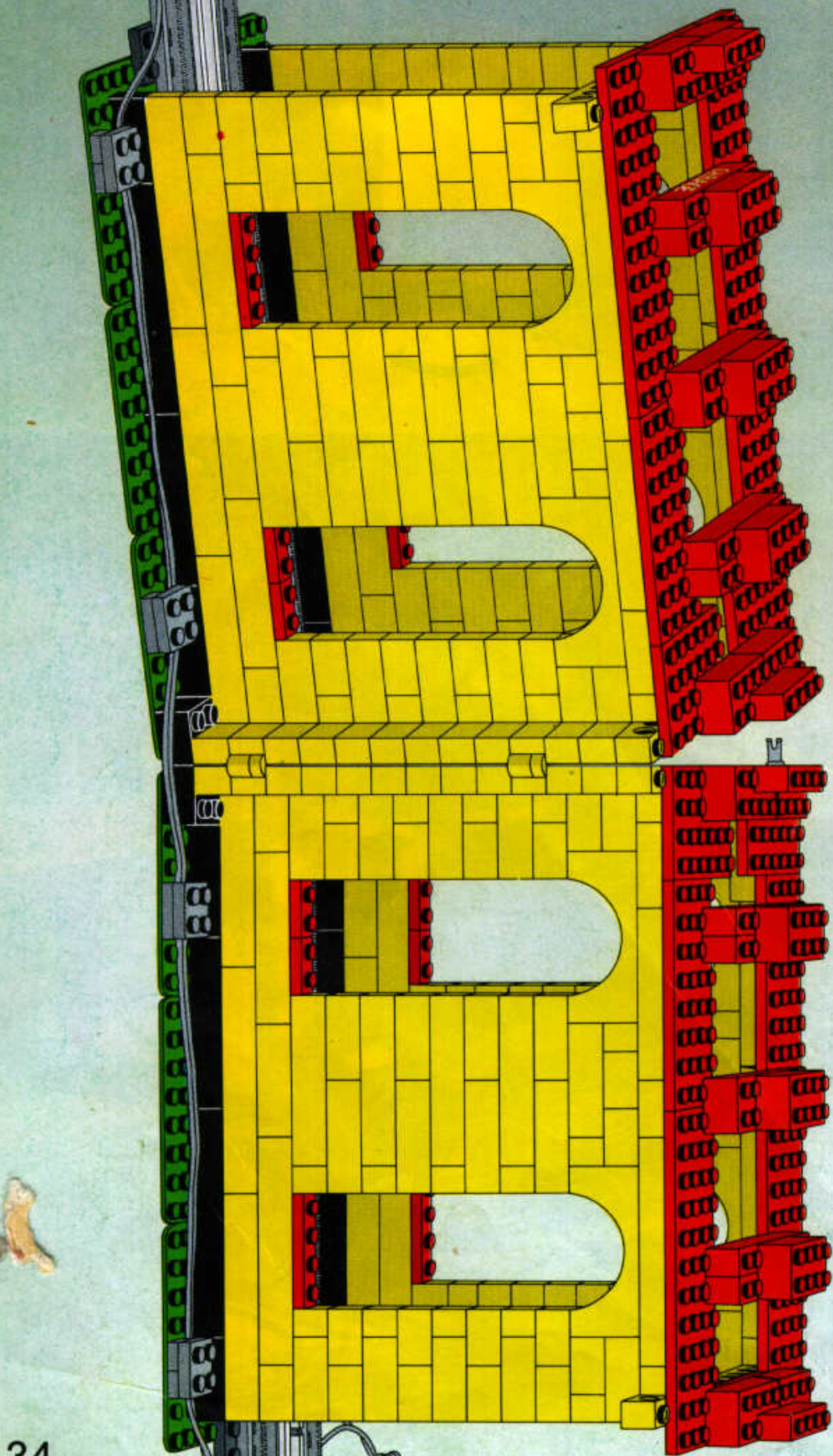
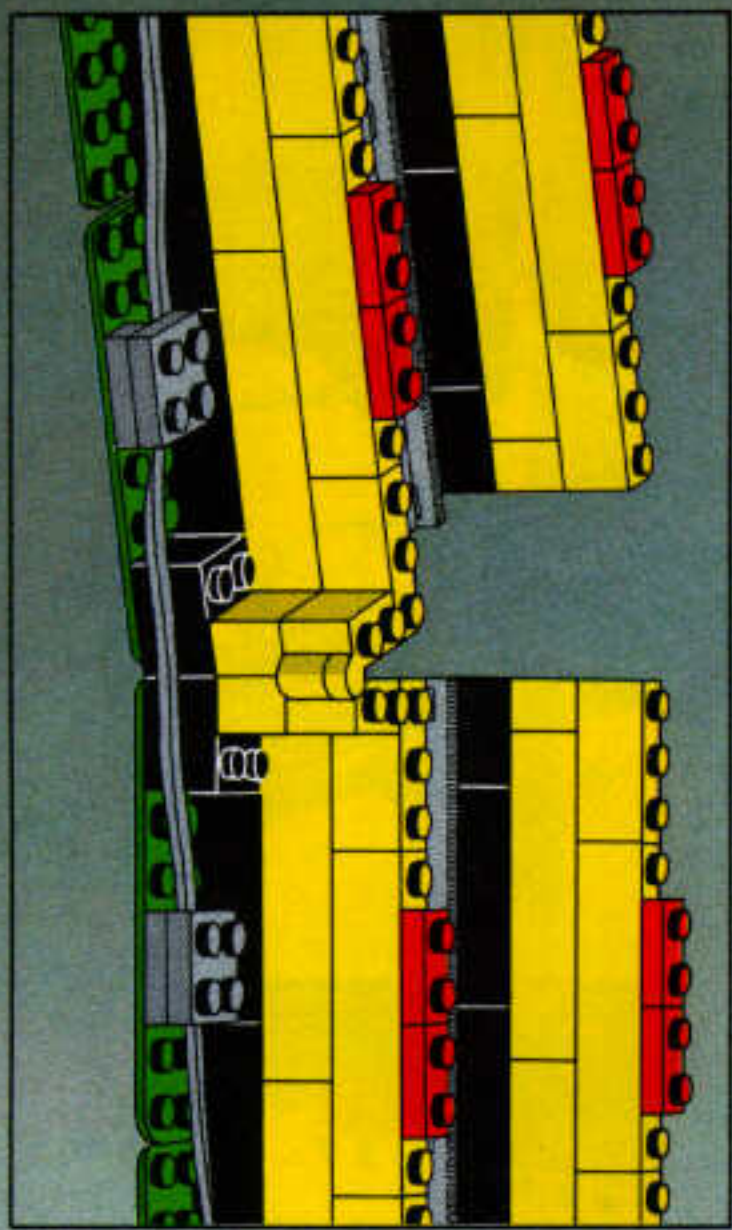
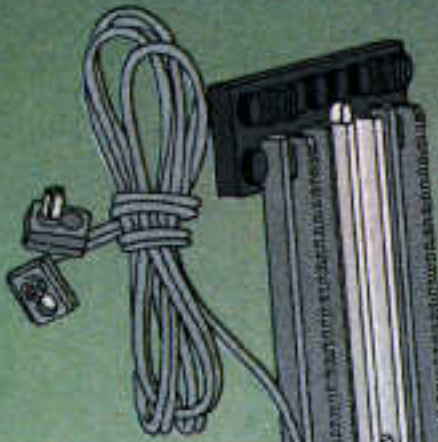

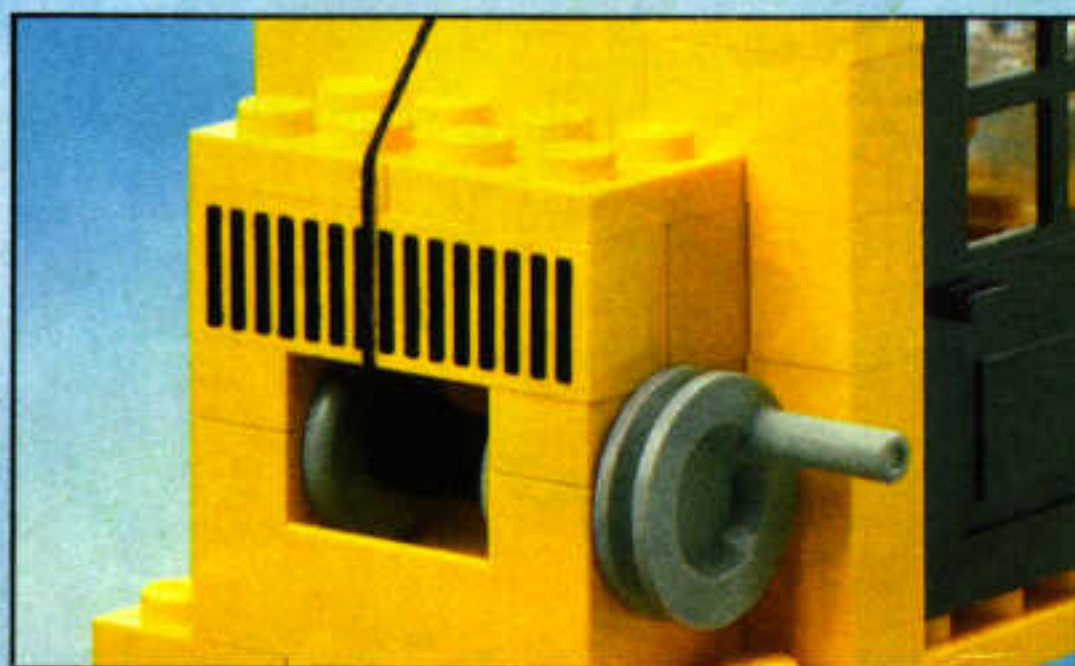
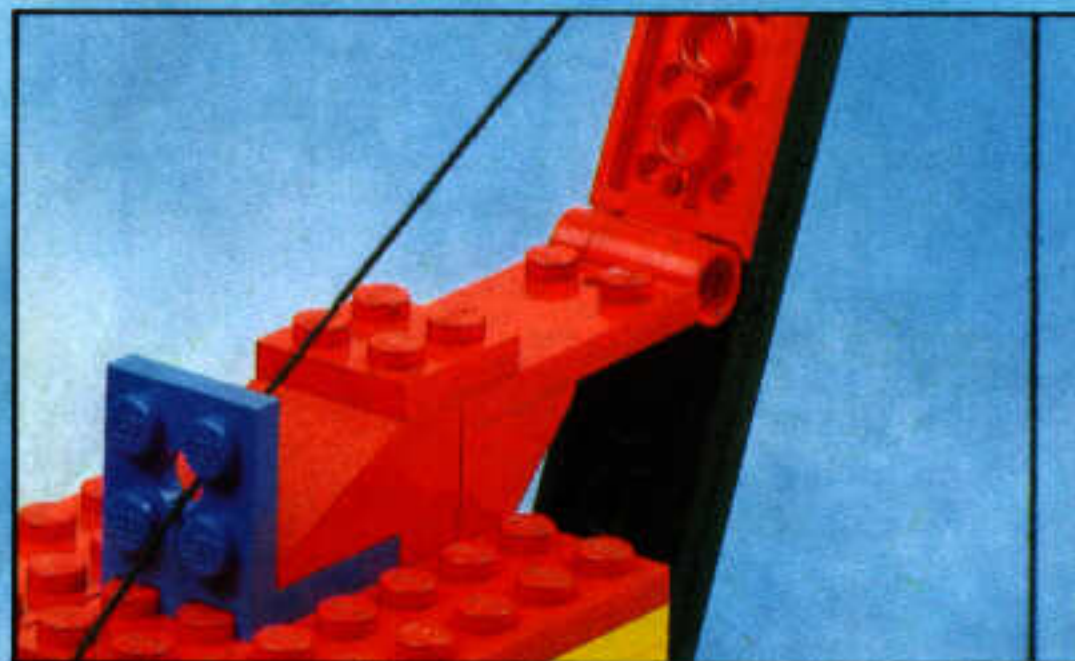
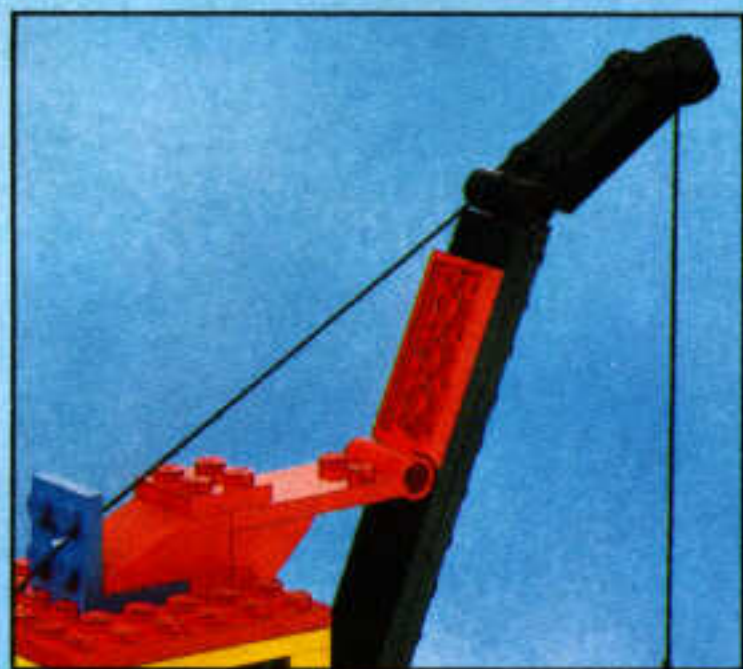

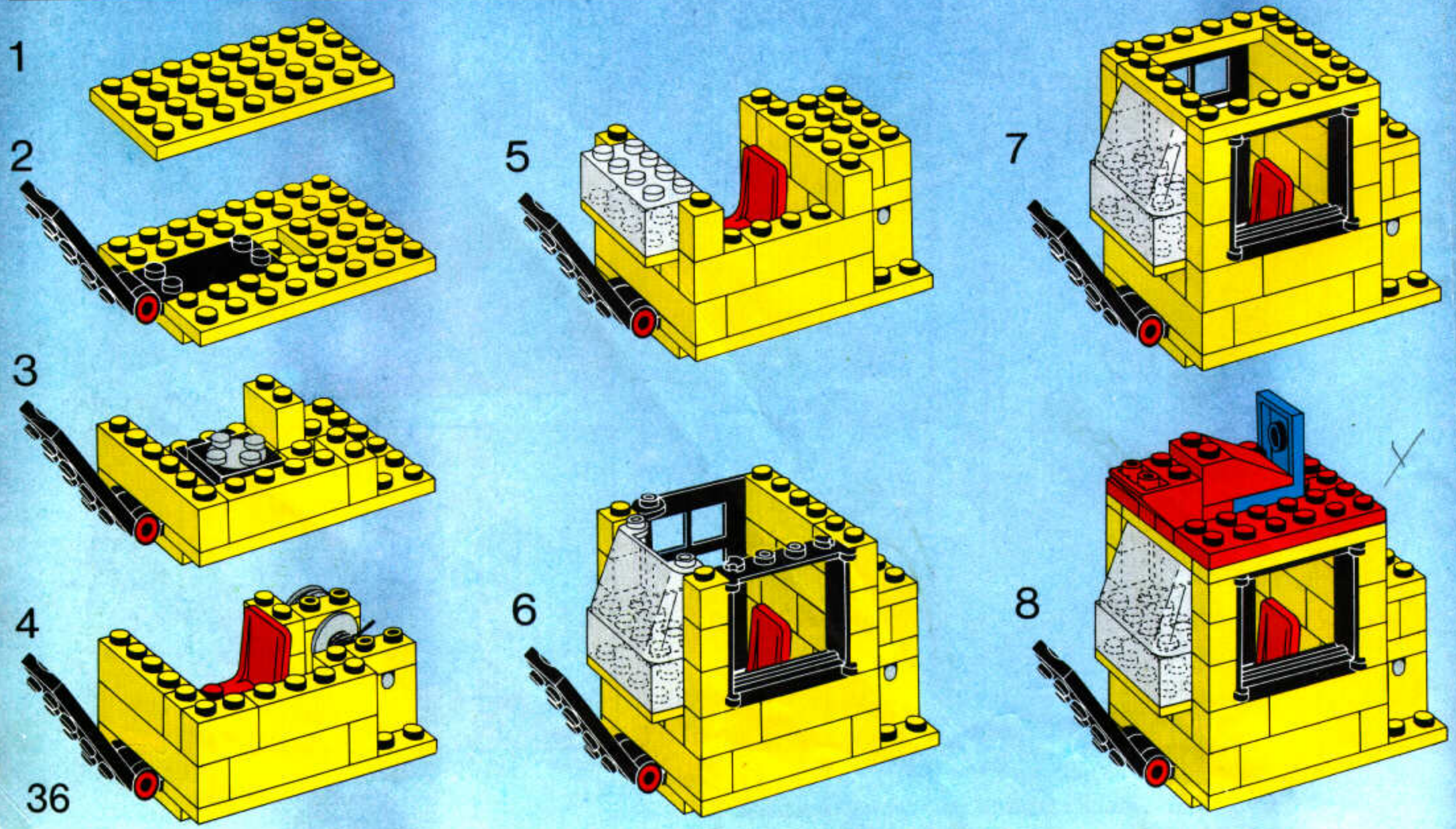
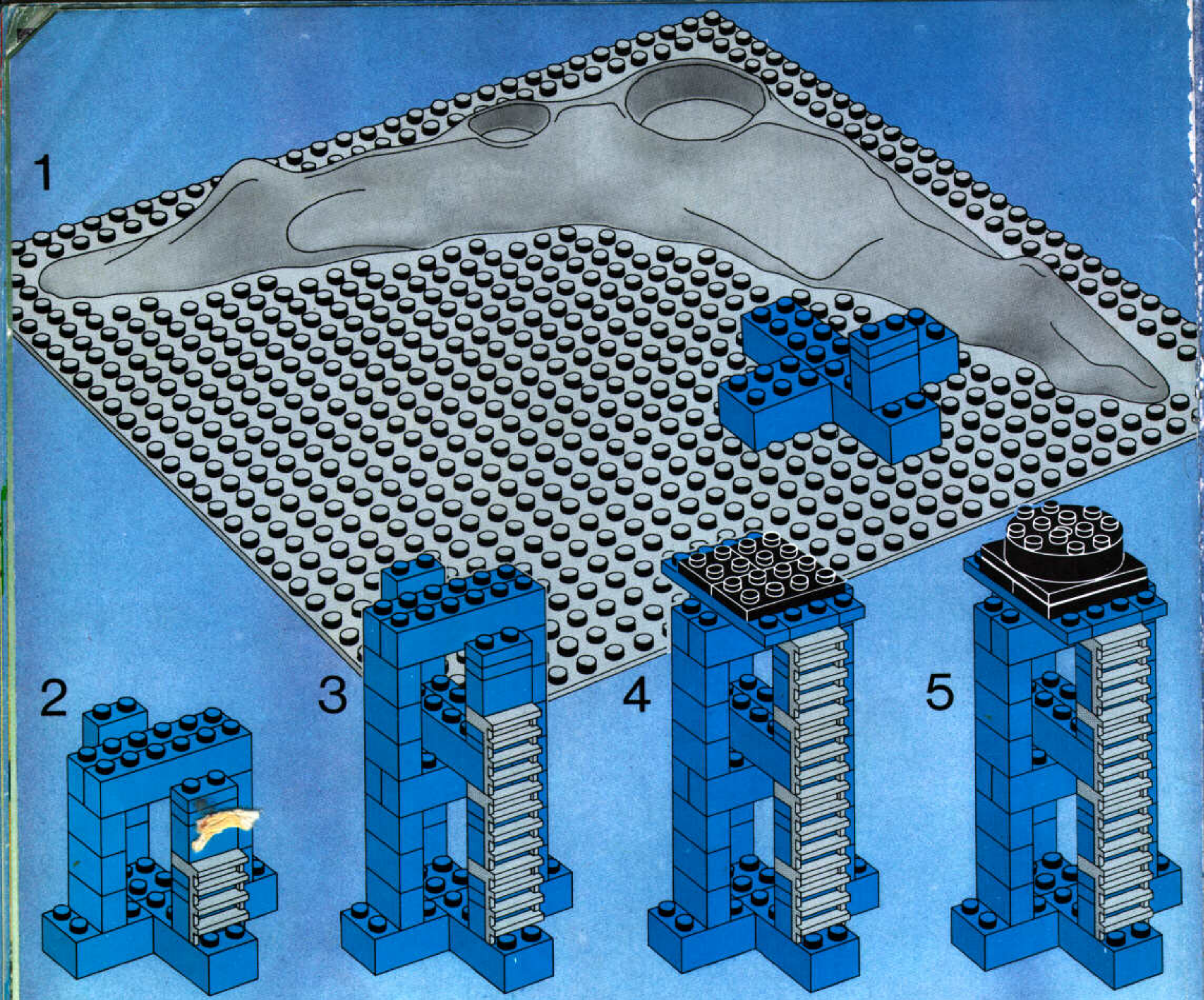

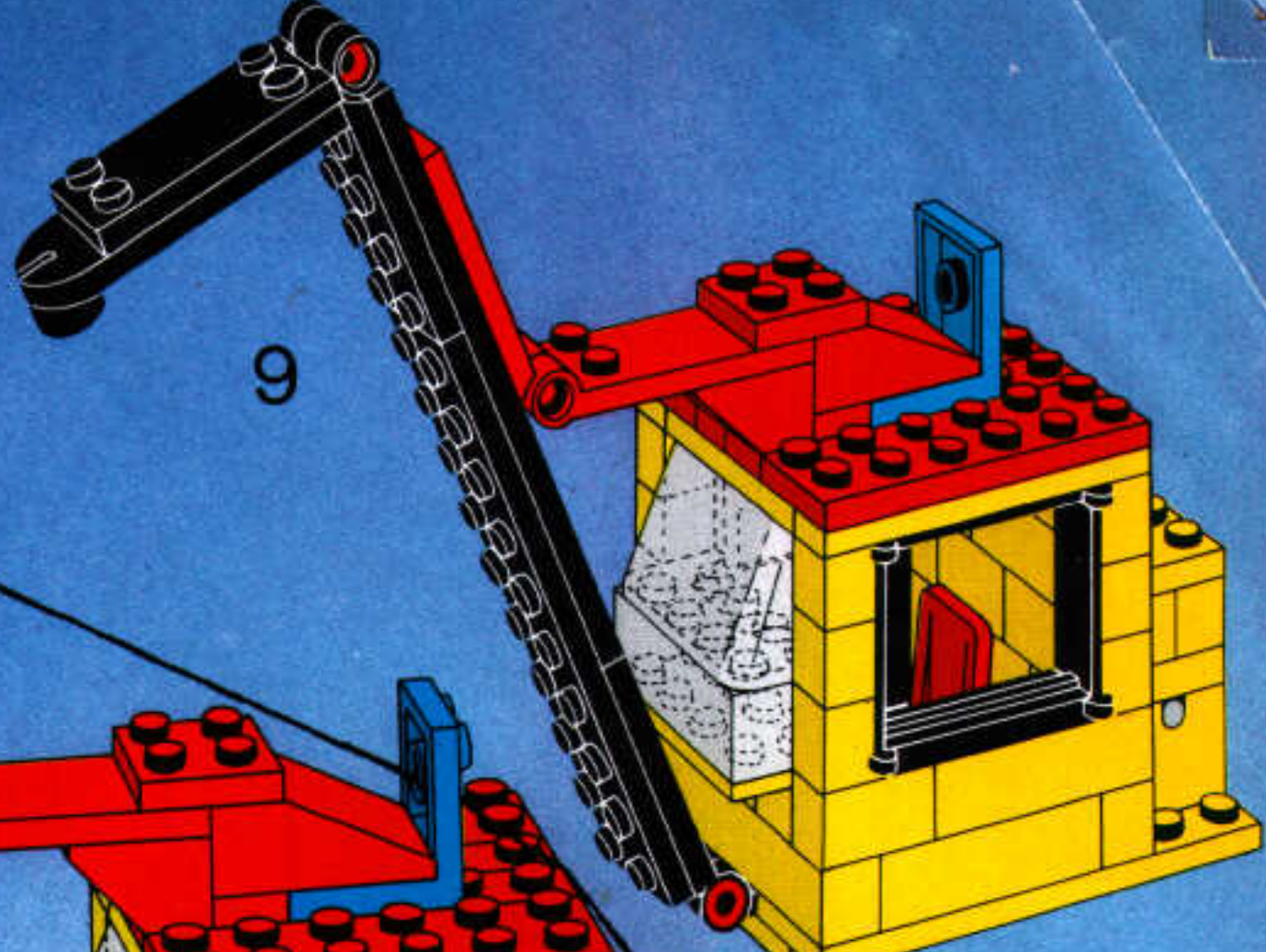
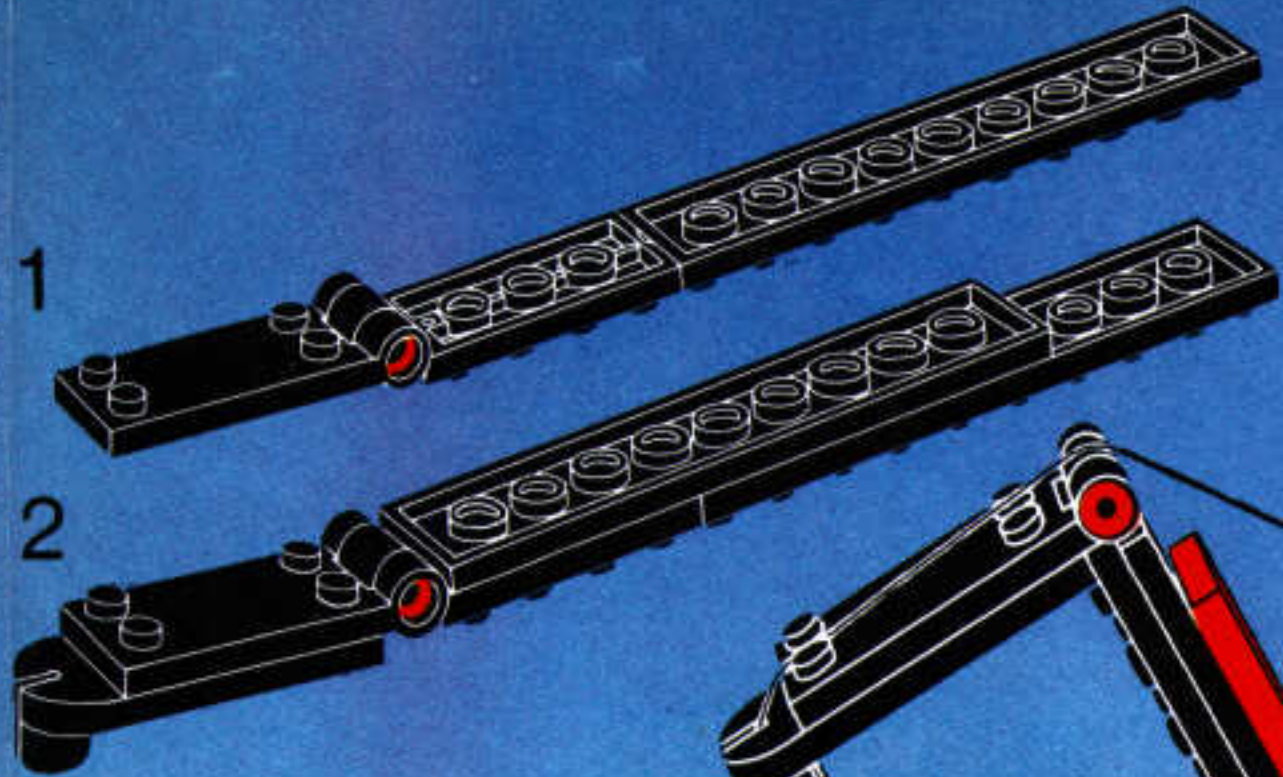
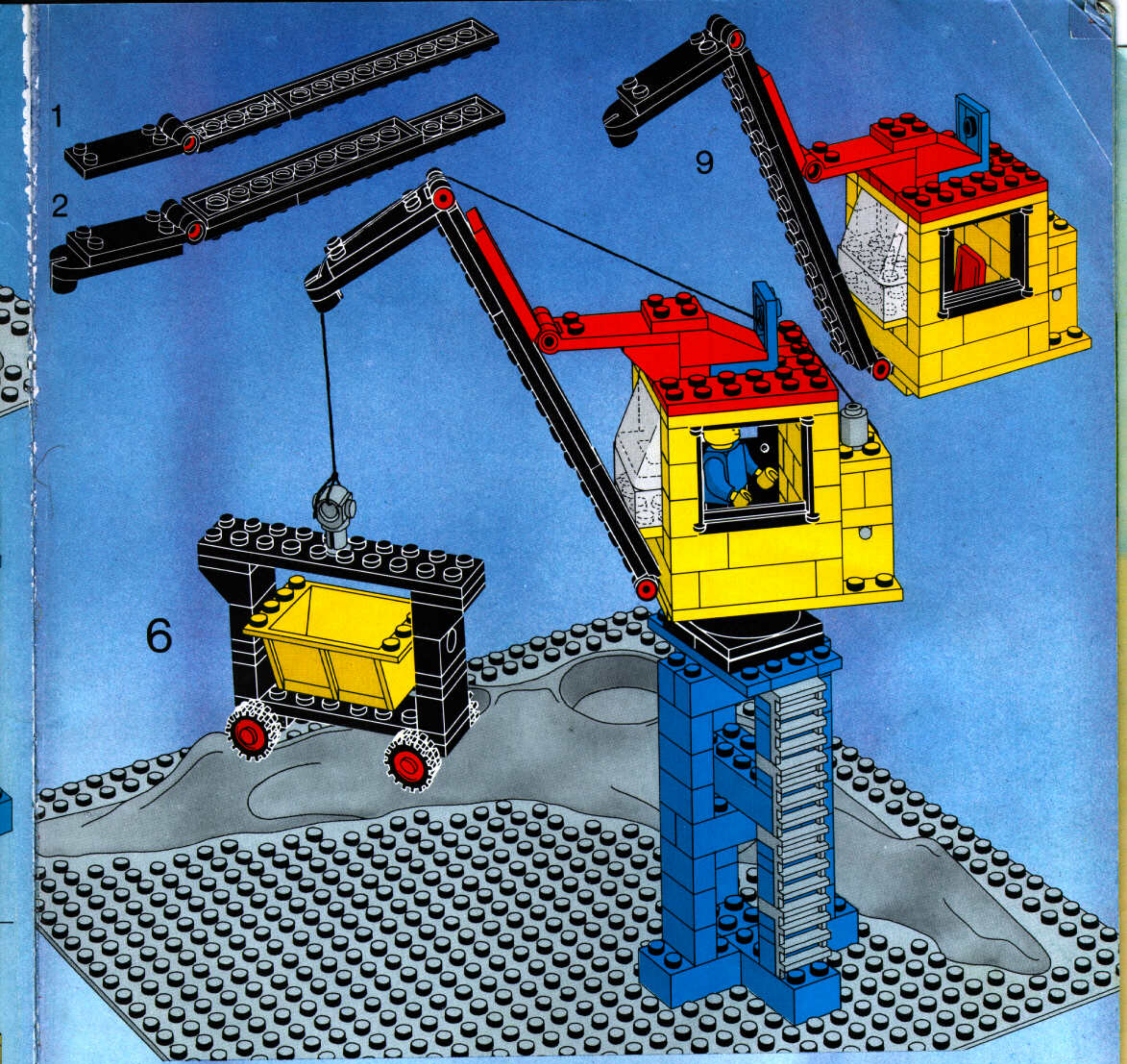

6

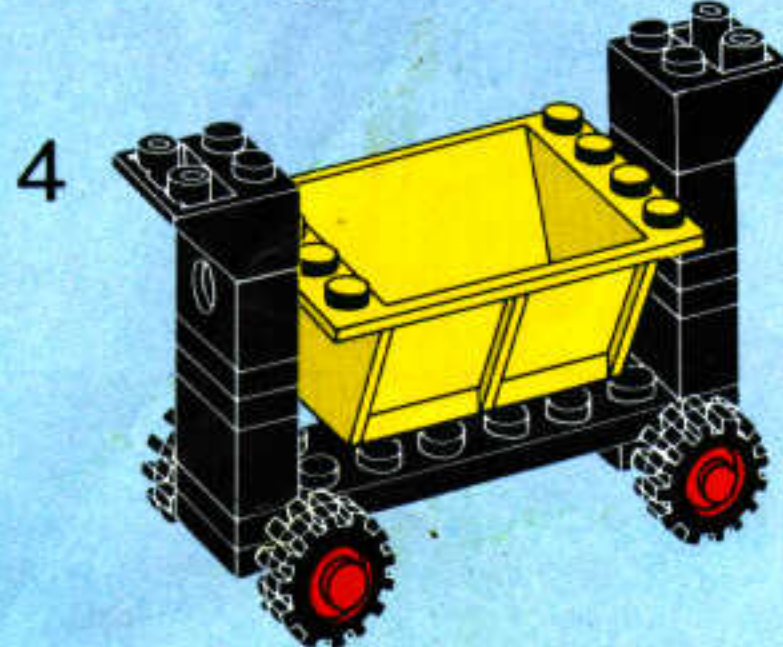
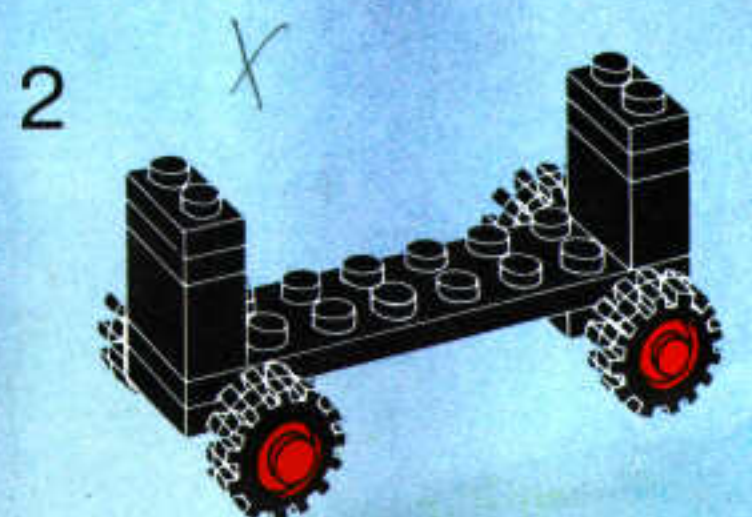
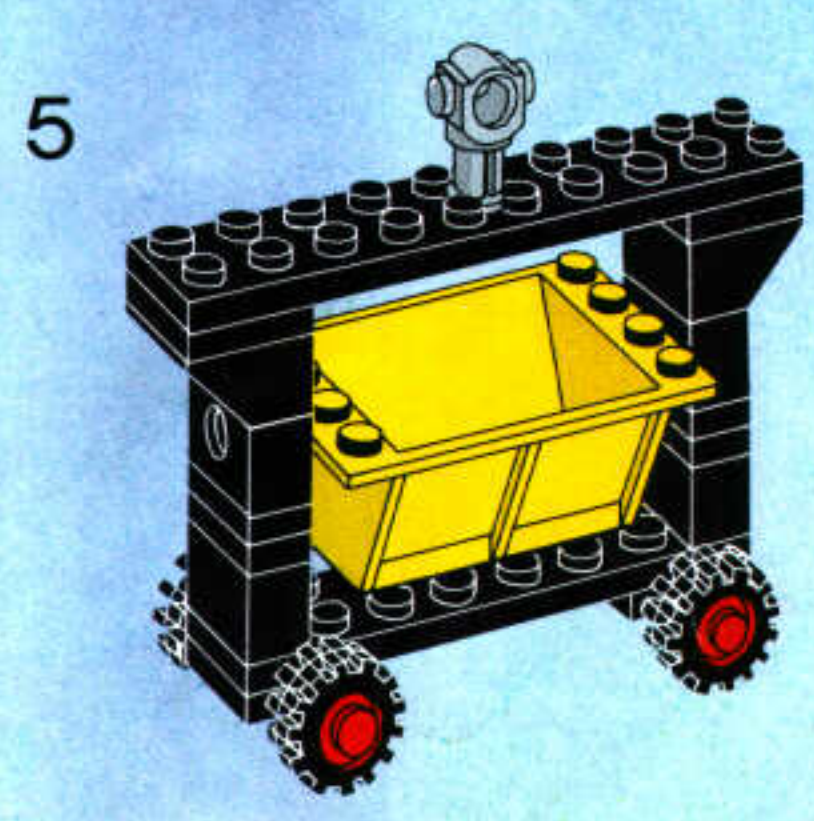
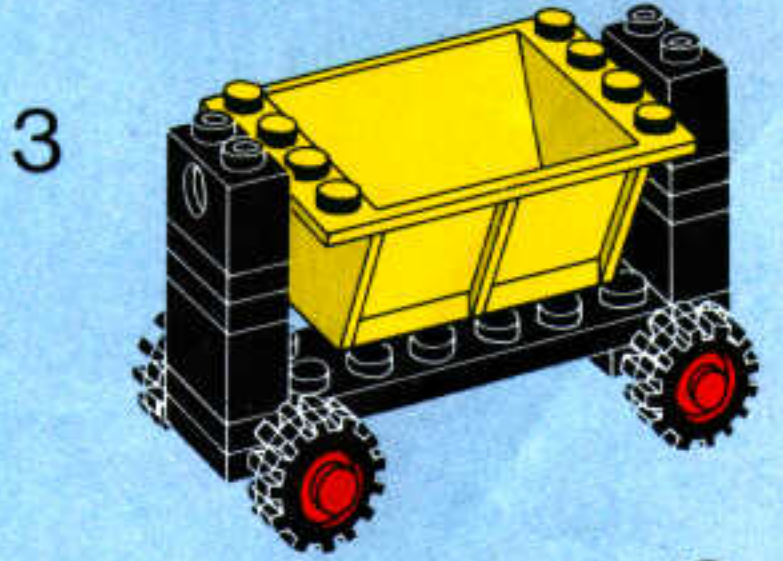
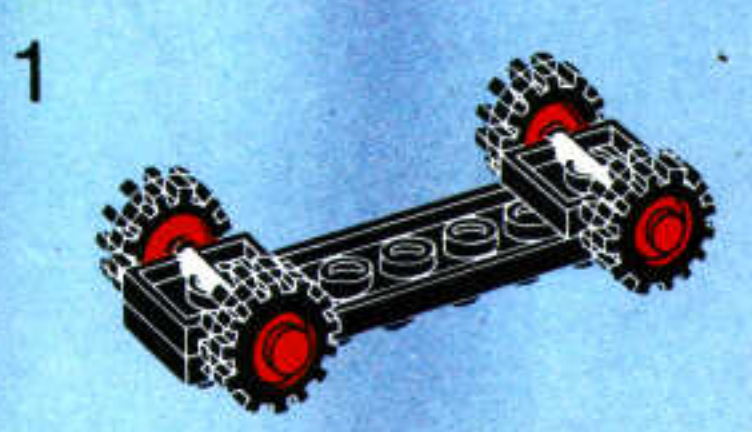

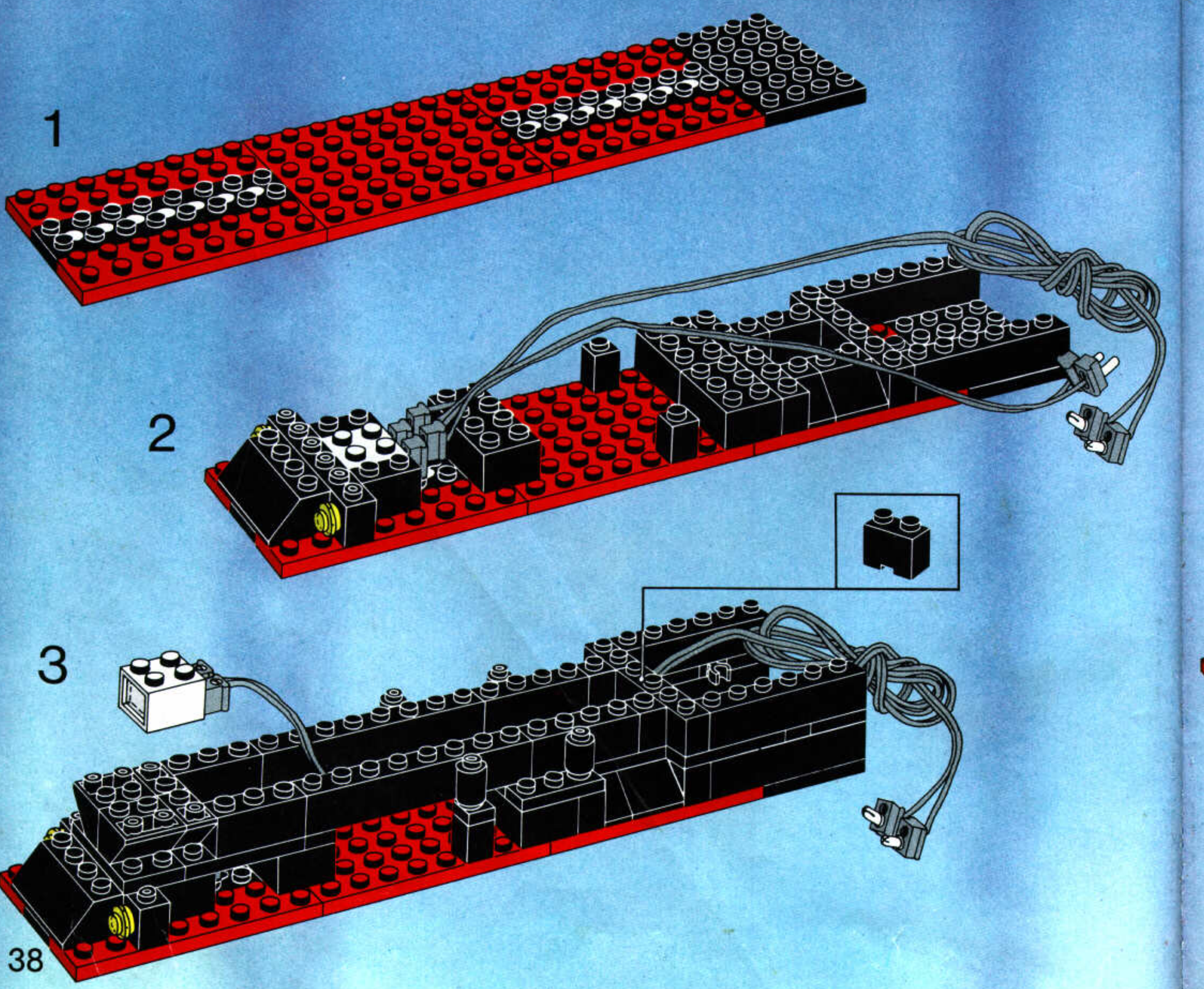

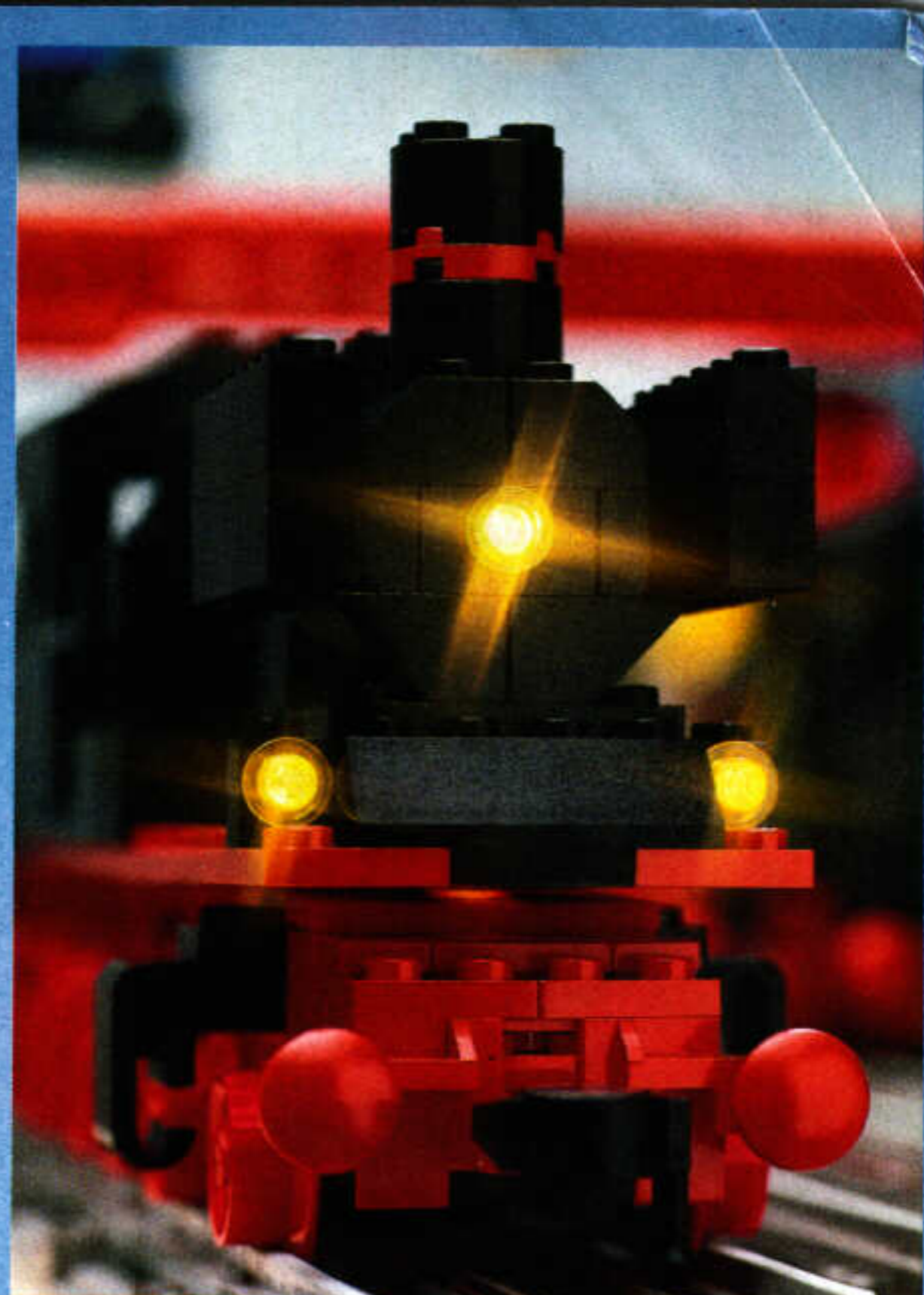

4

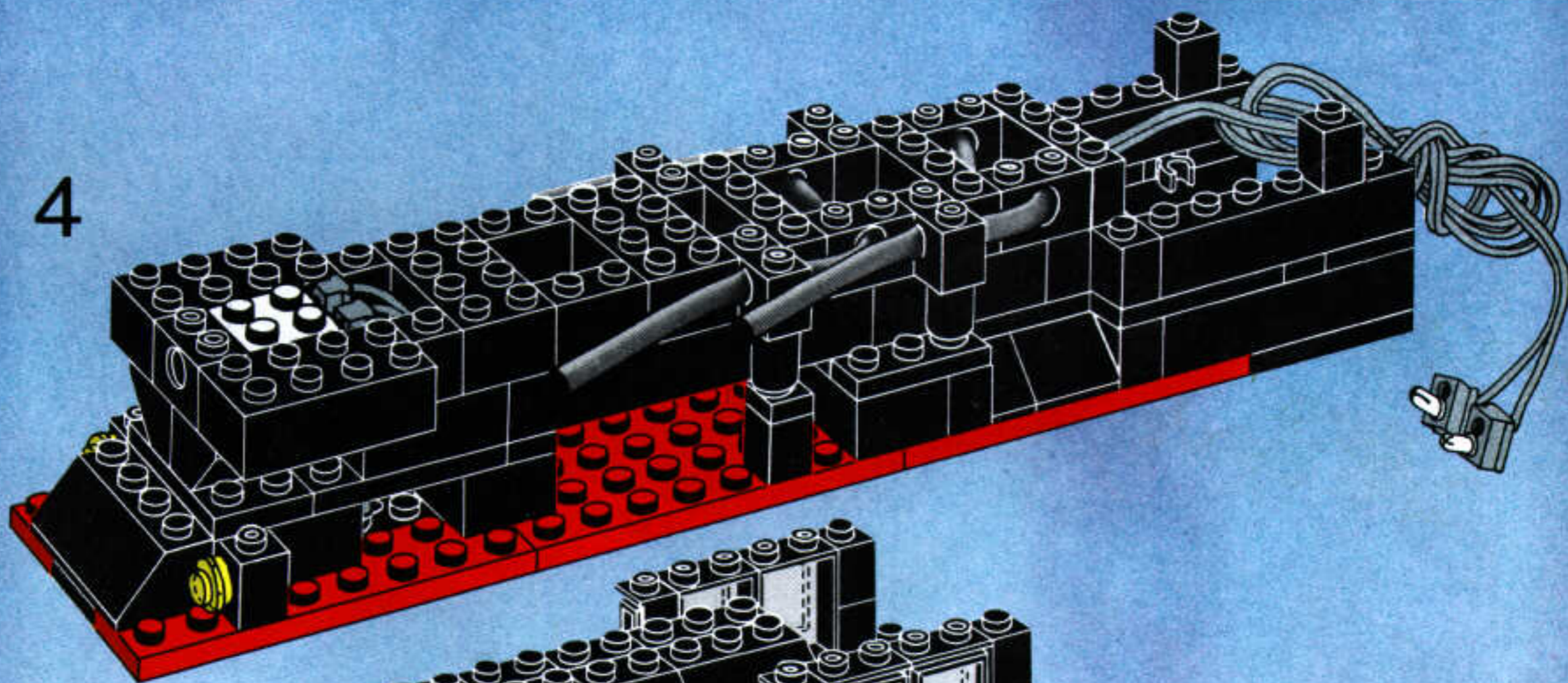

5

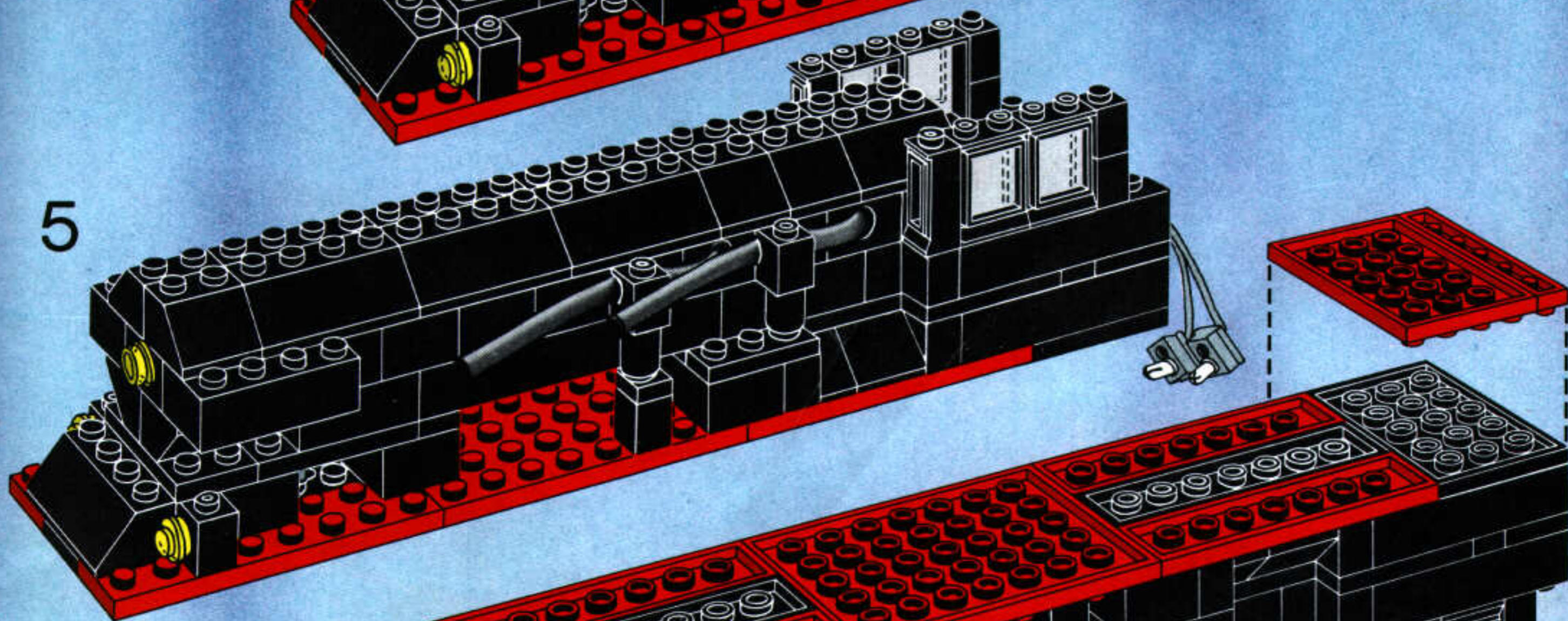

6

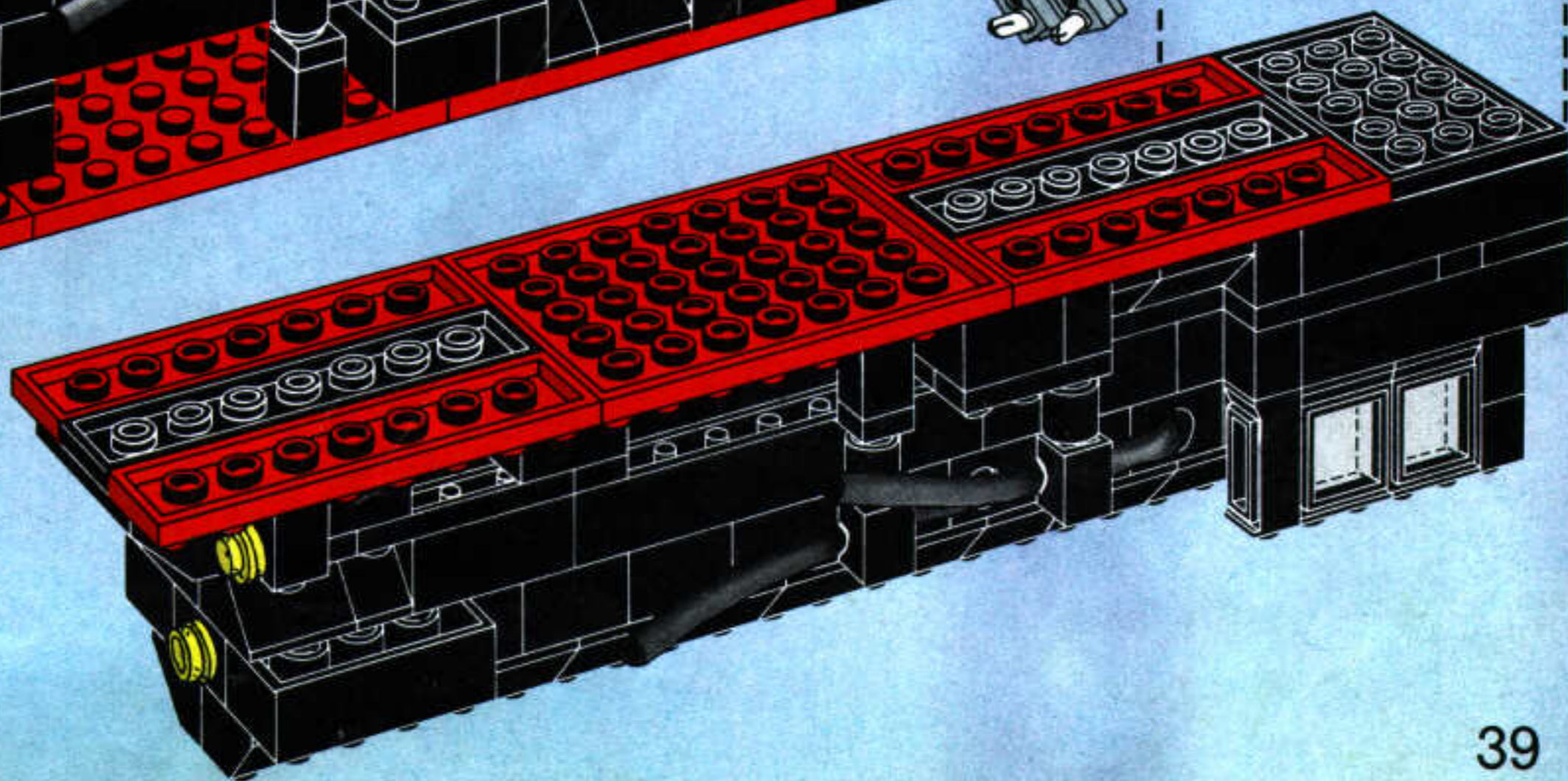

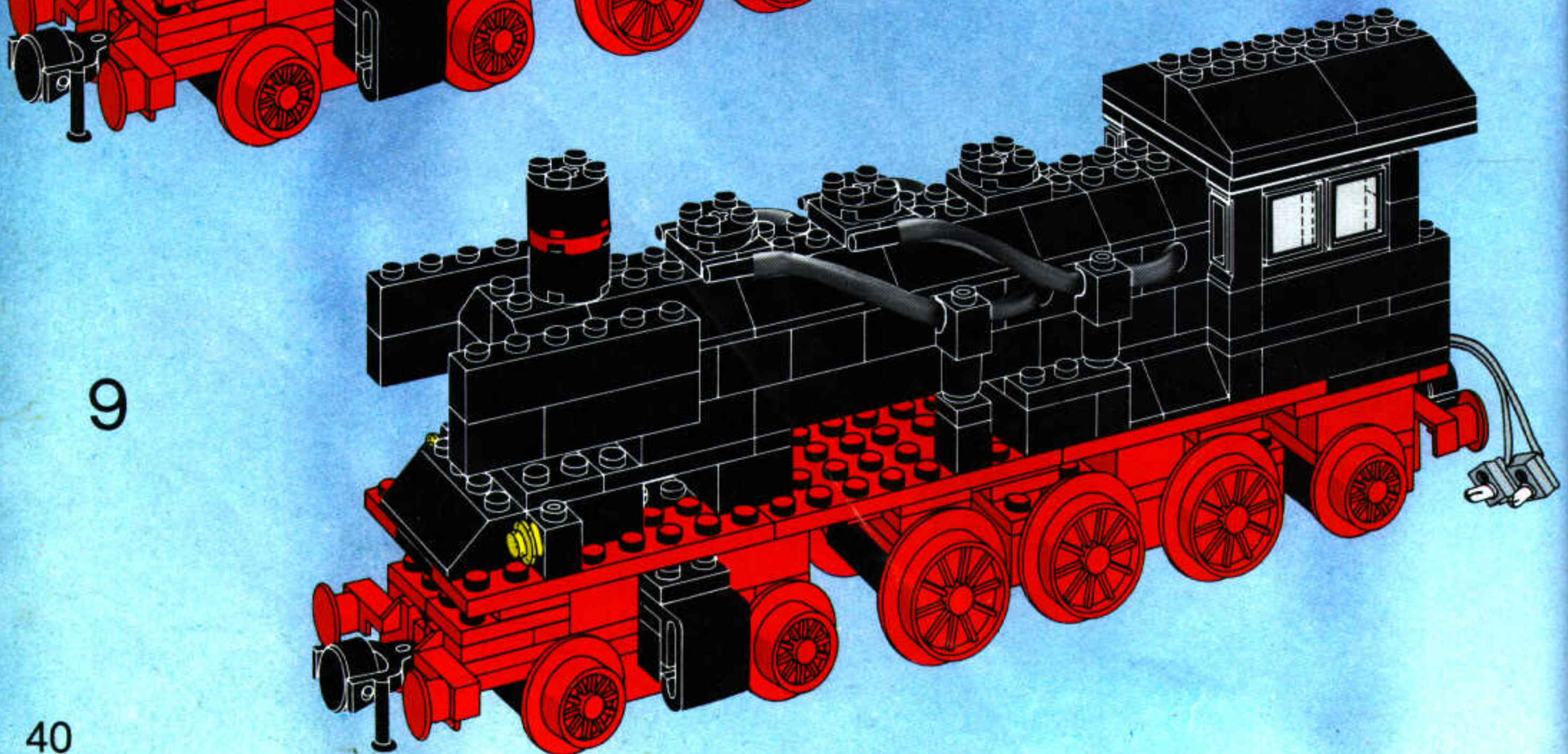
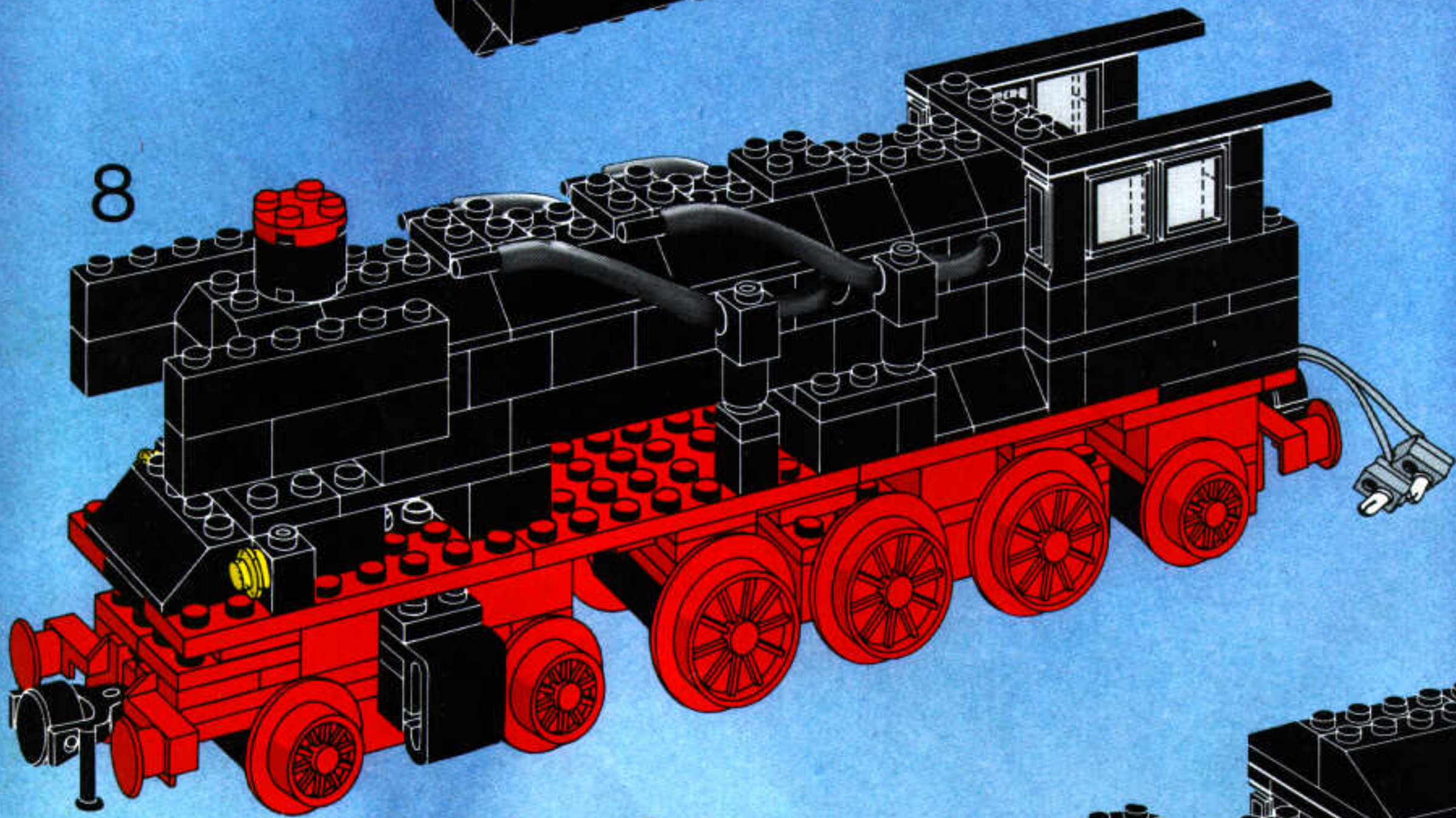
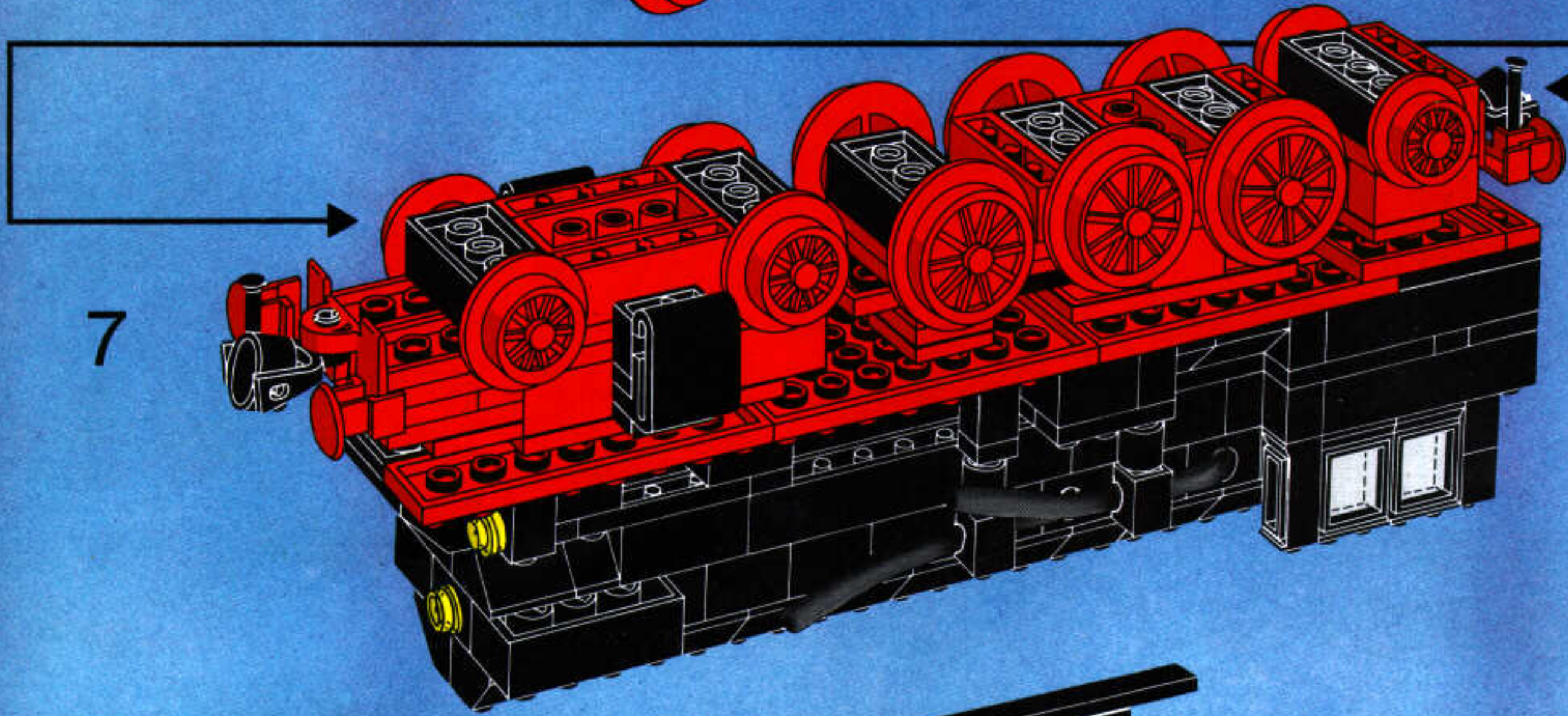
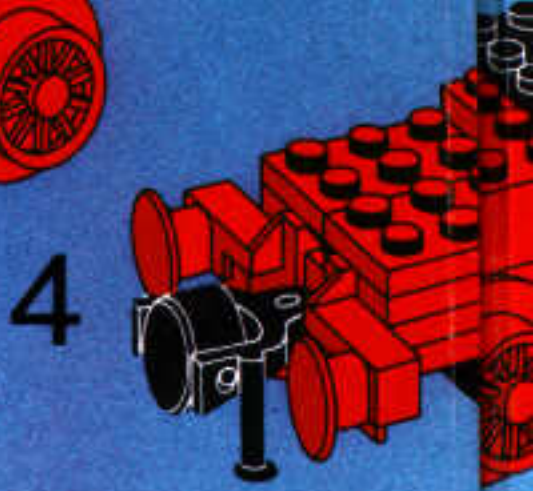
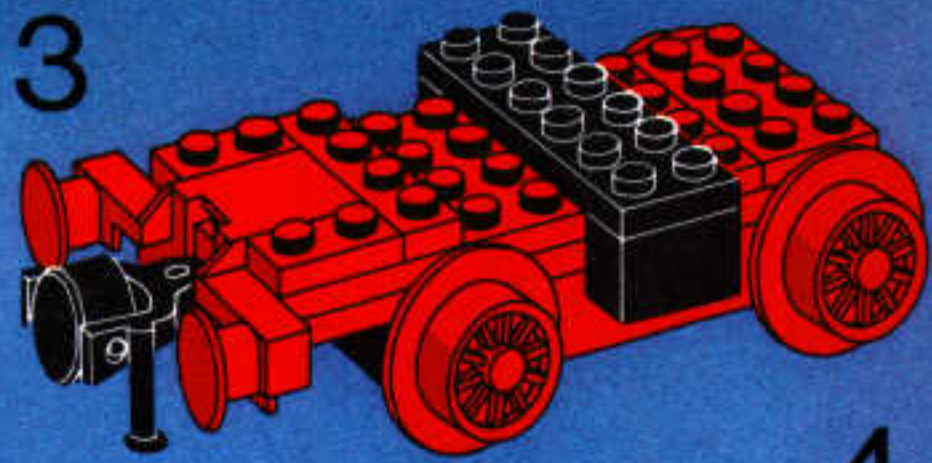
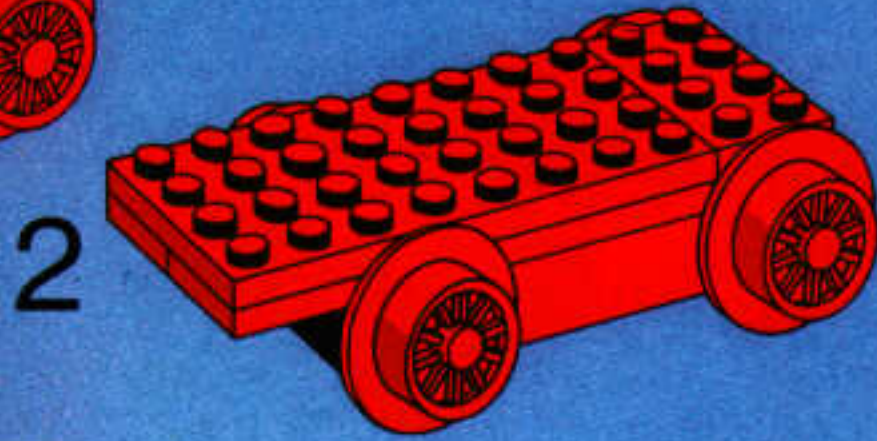
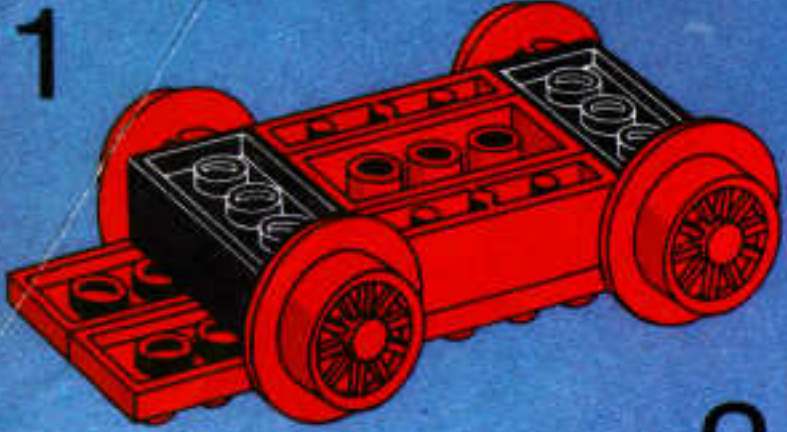



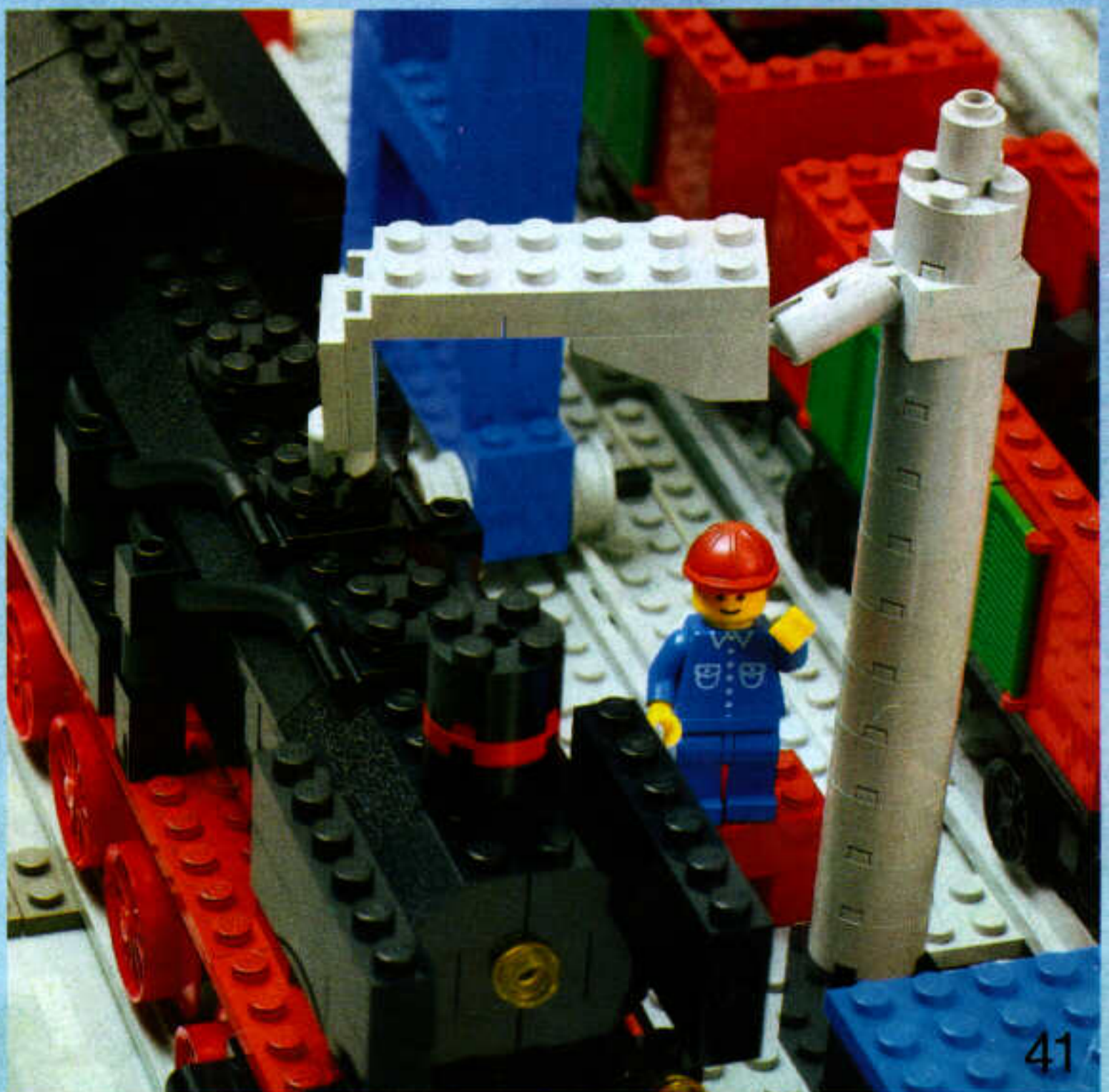
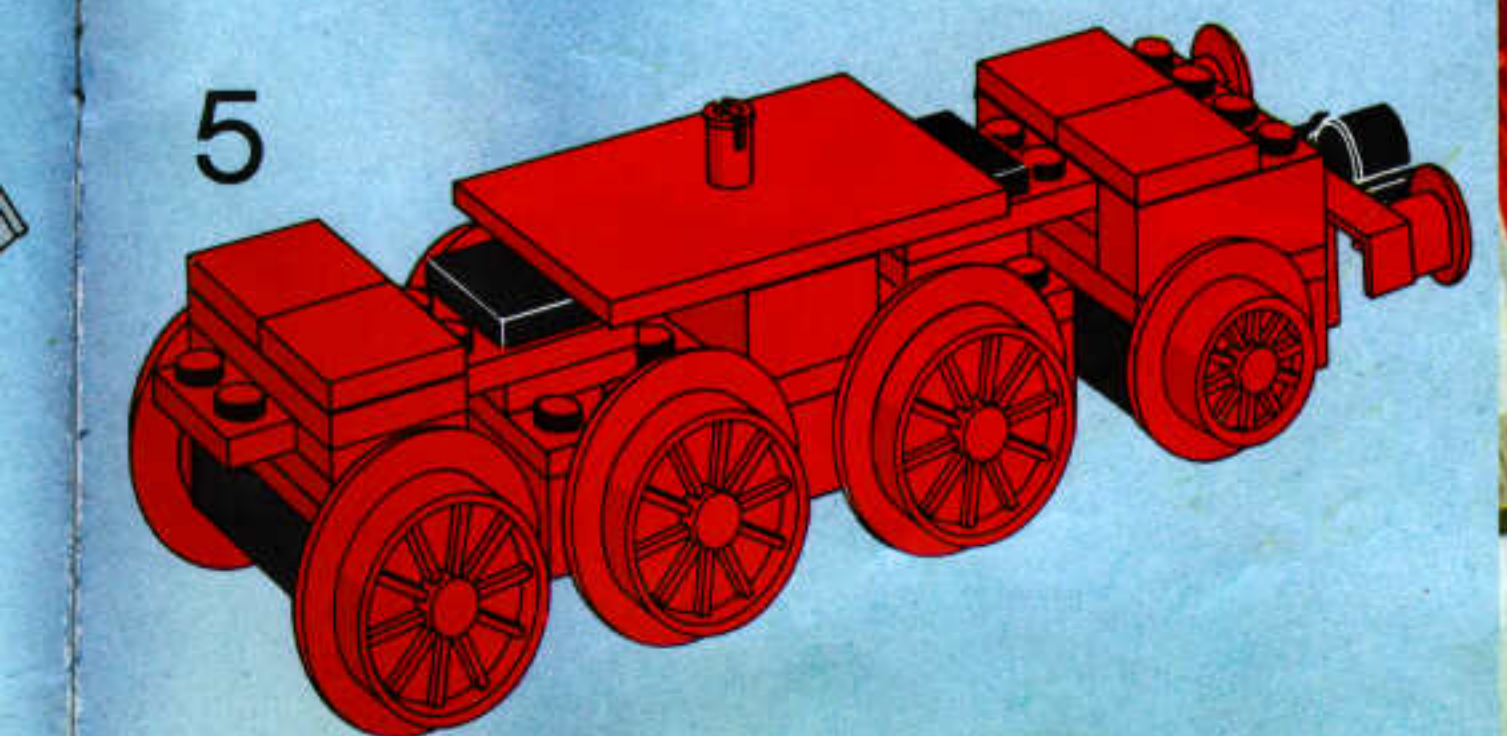
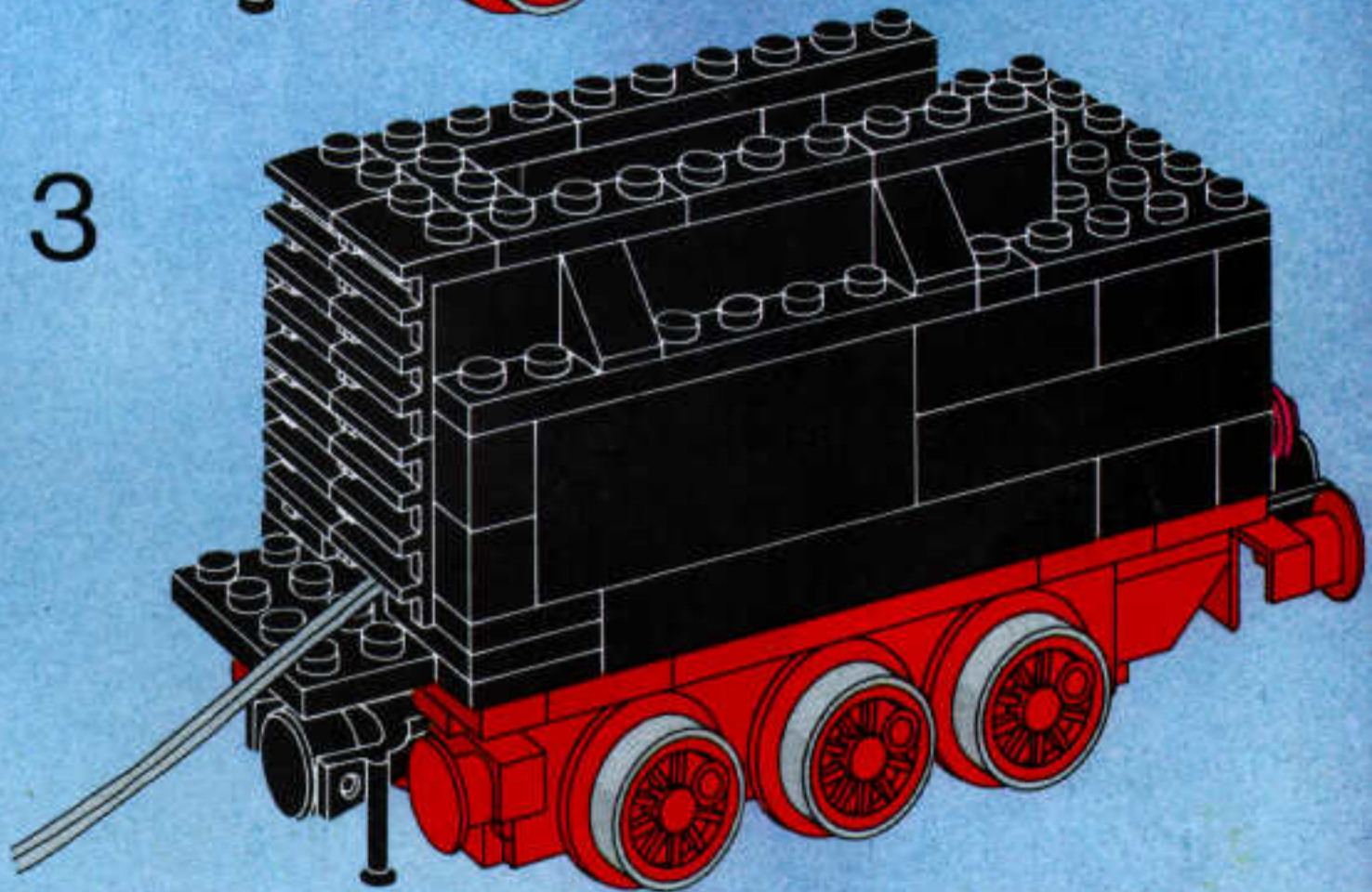
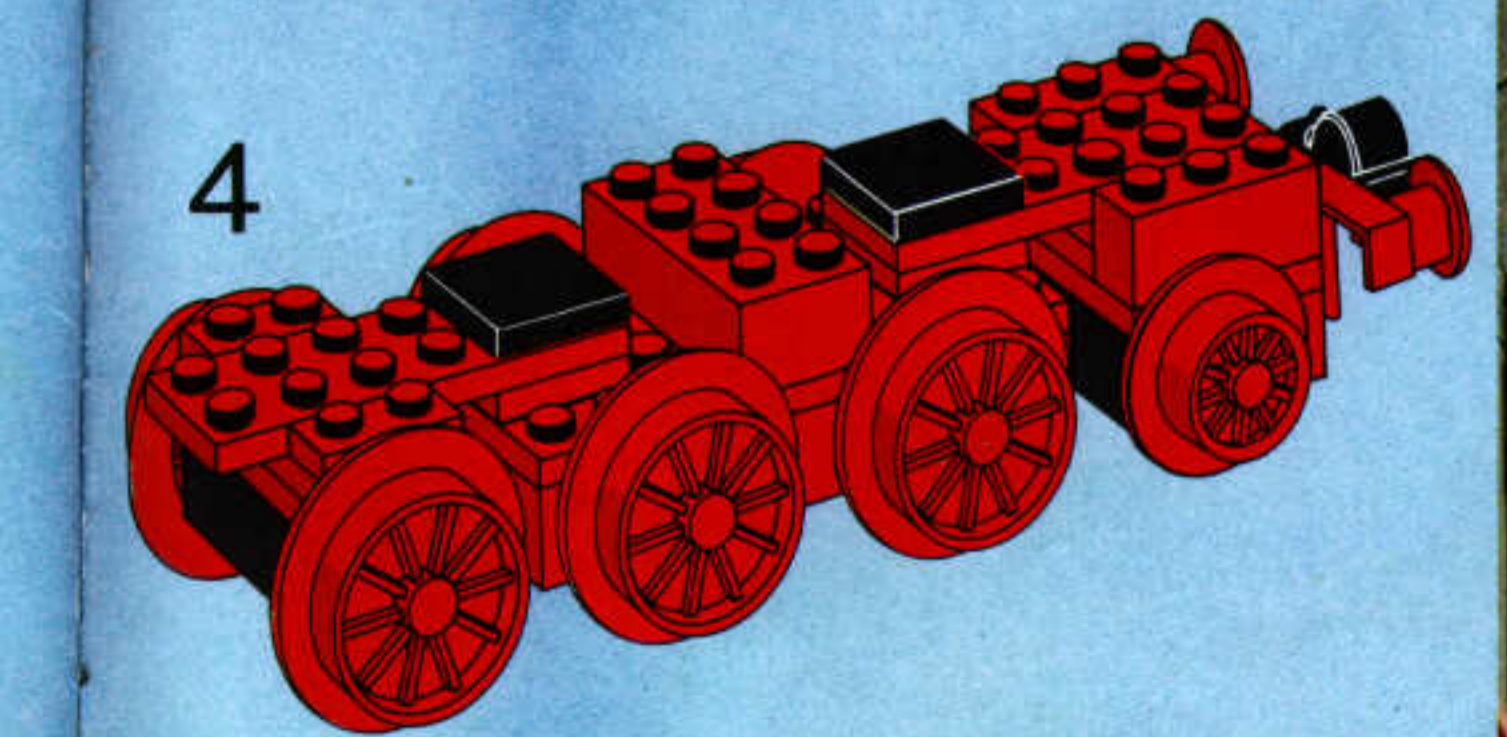
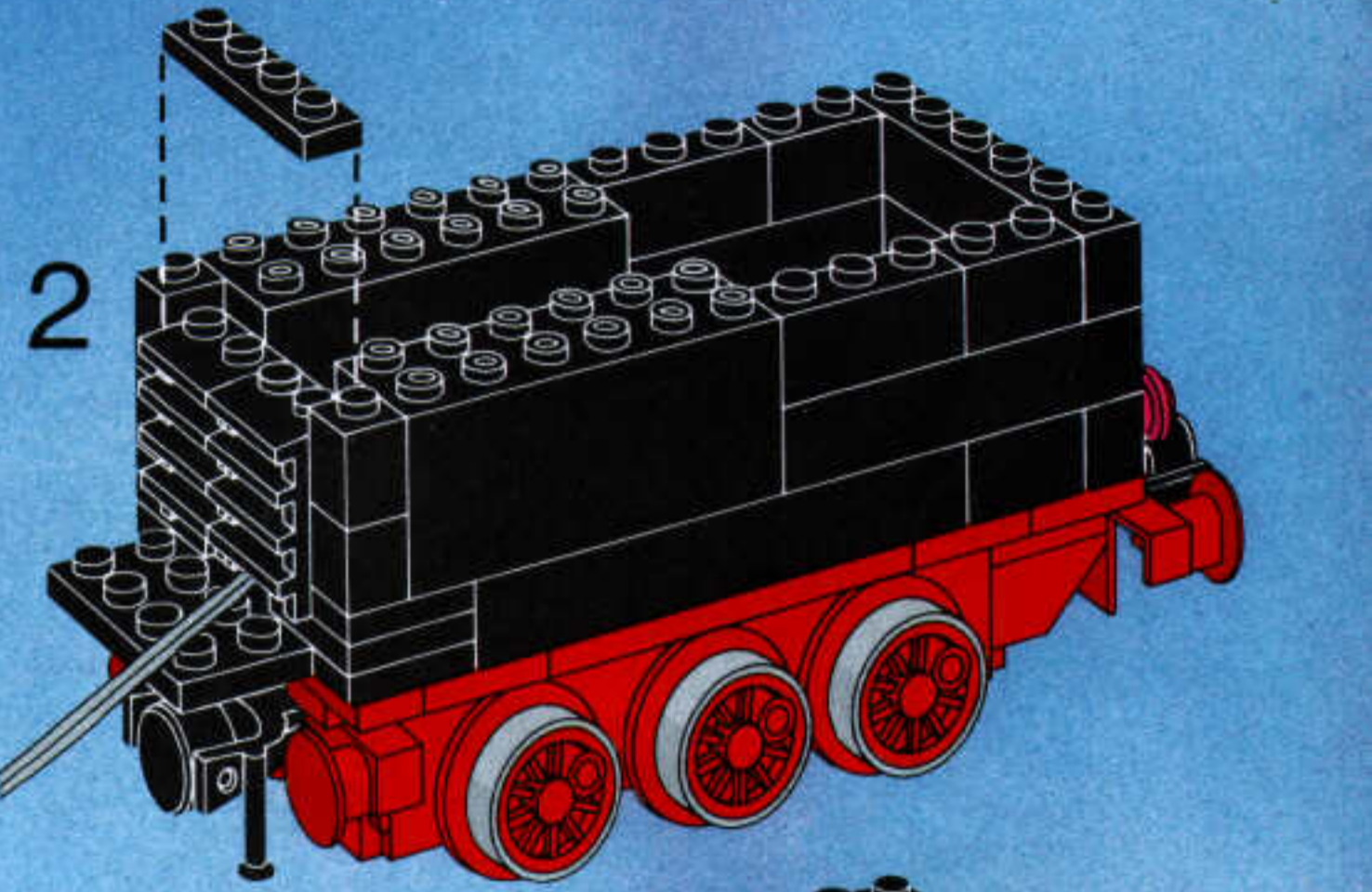
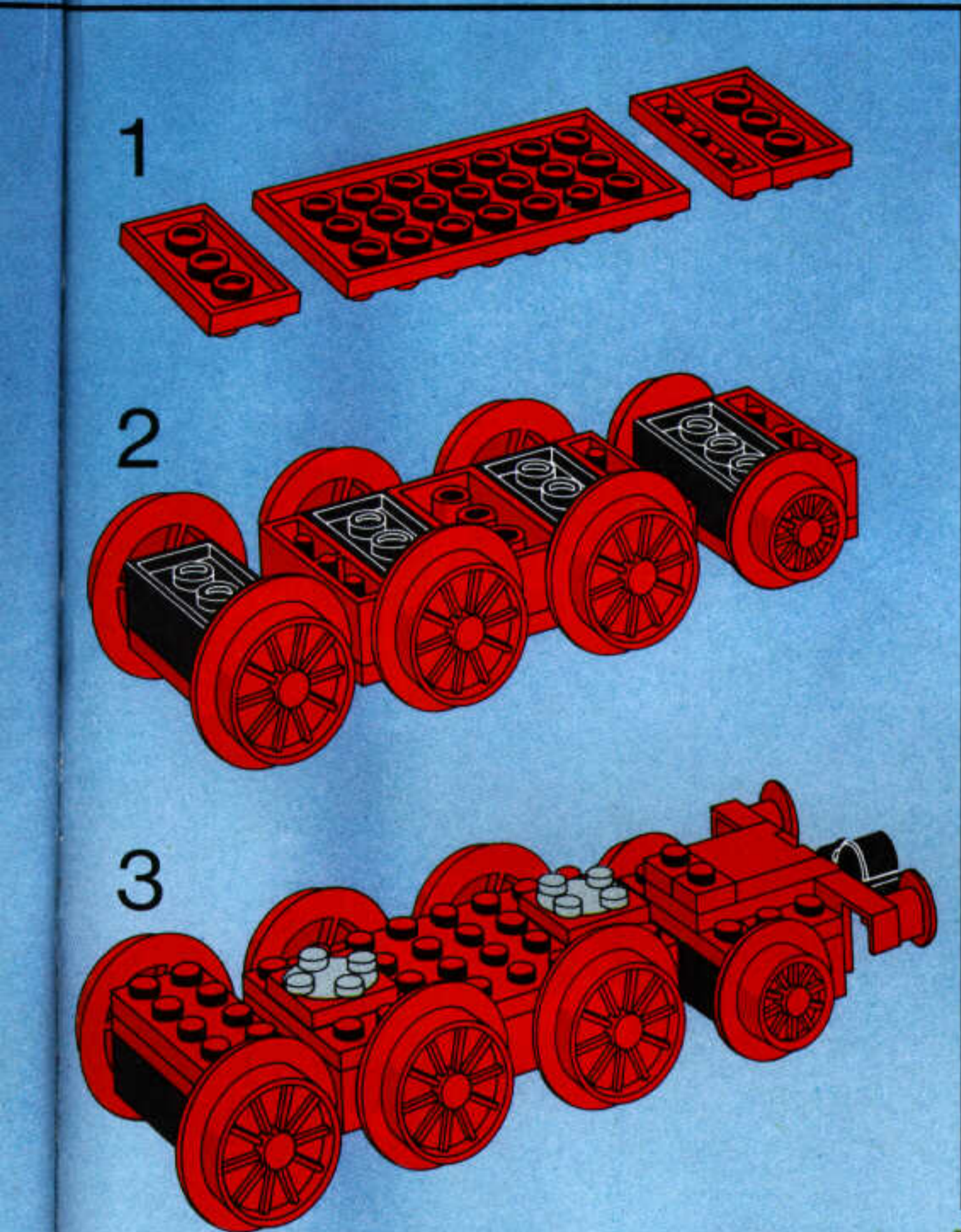
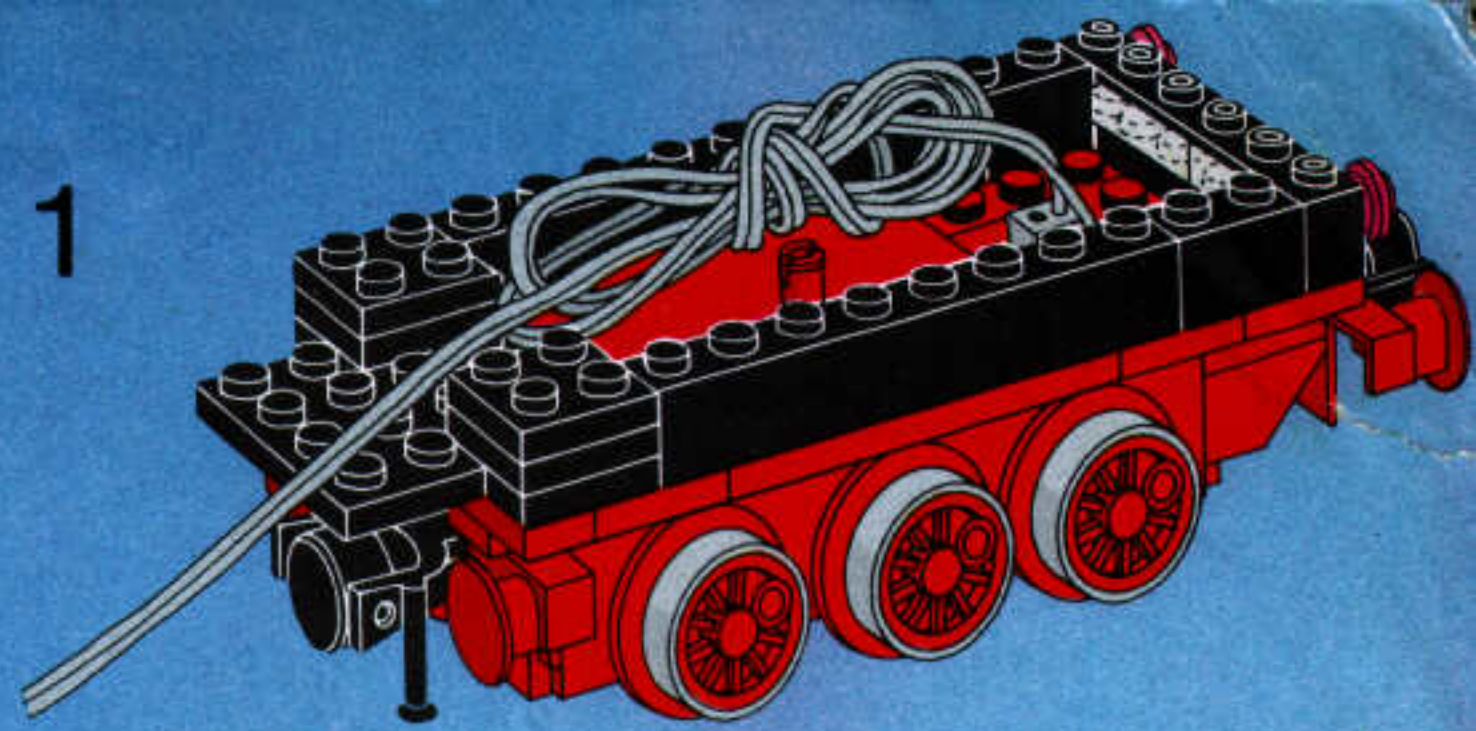
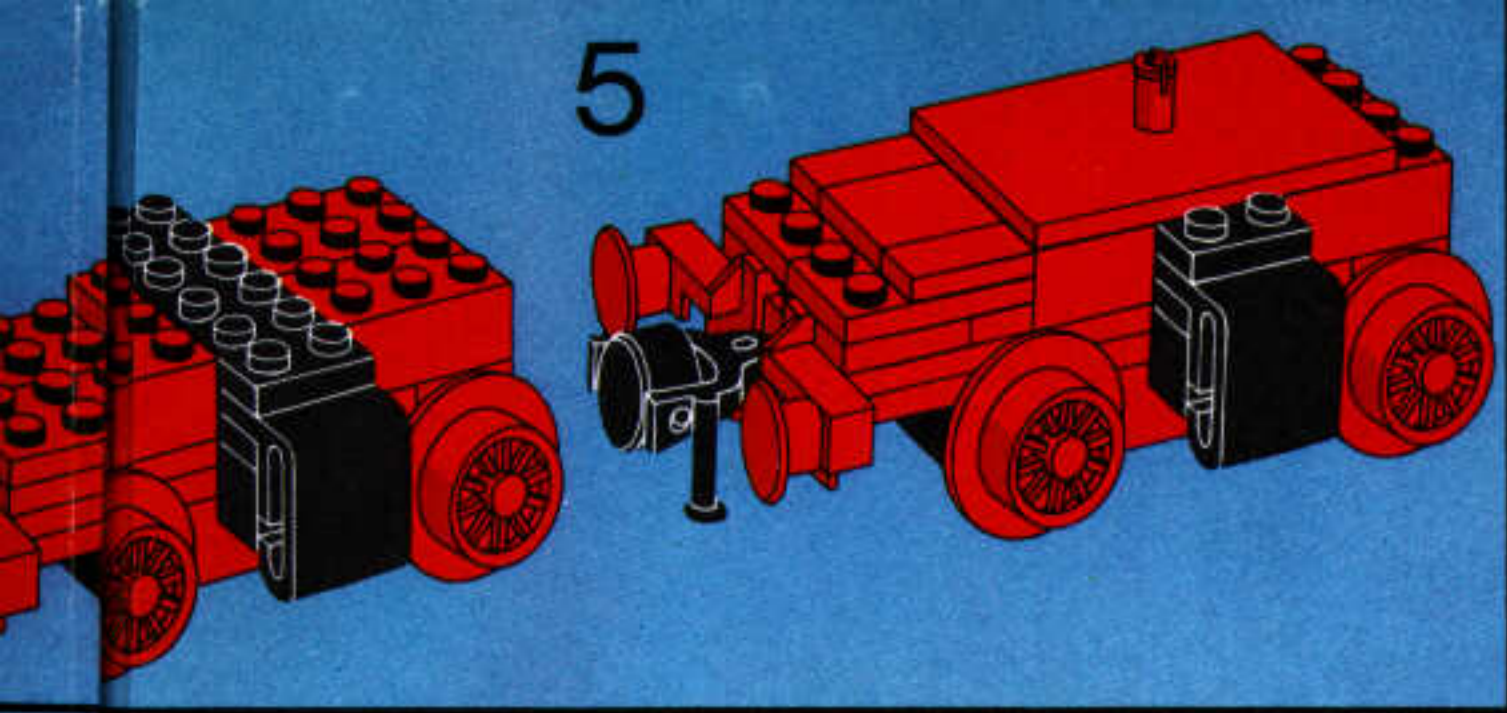

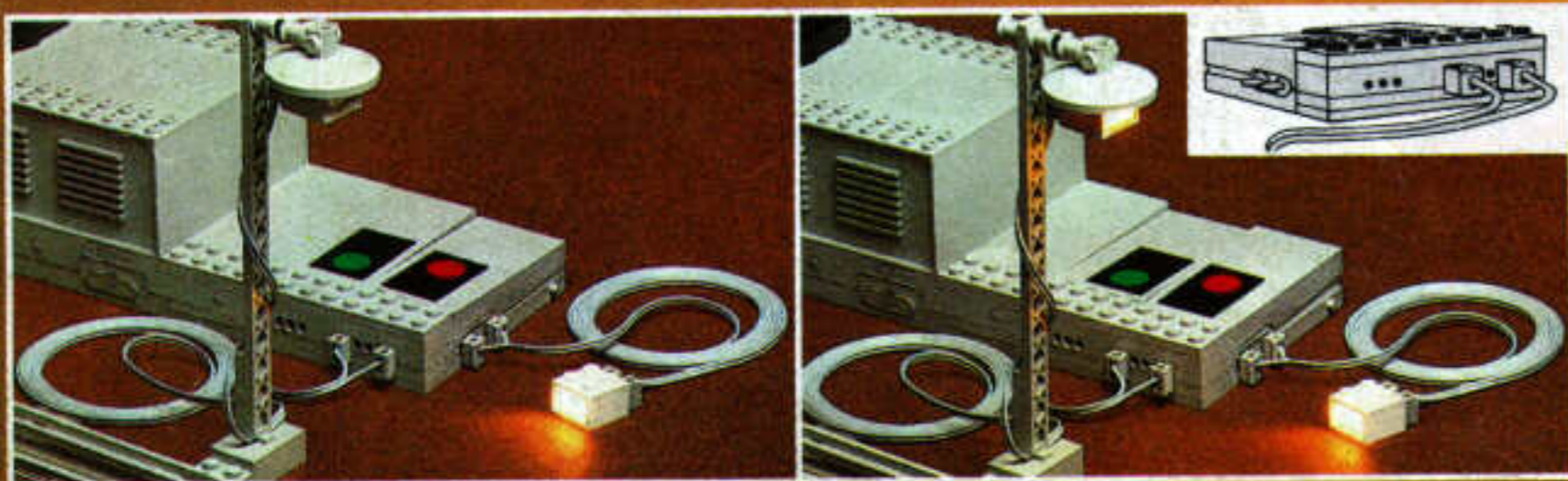



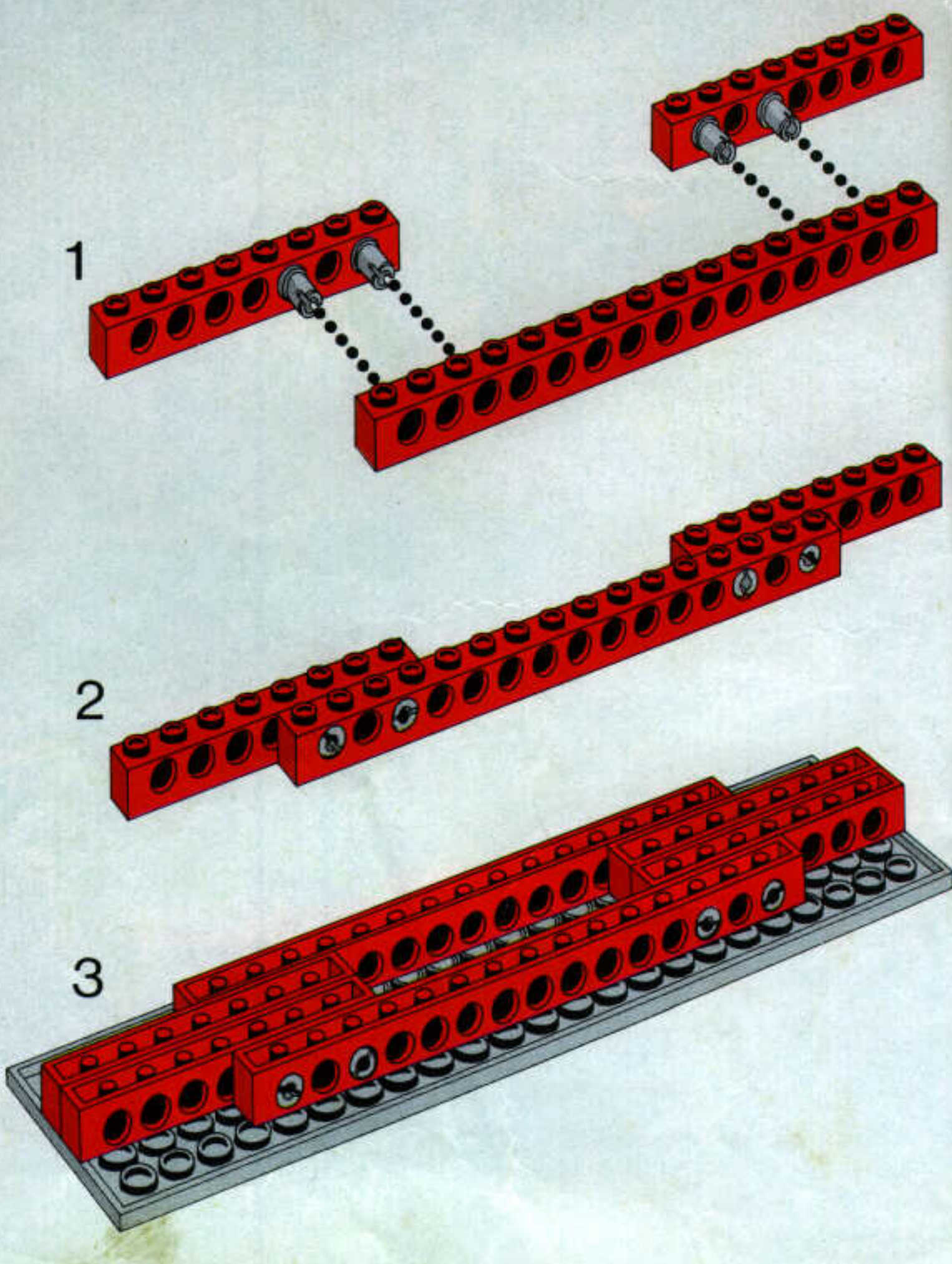
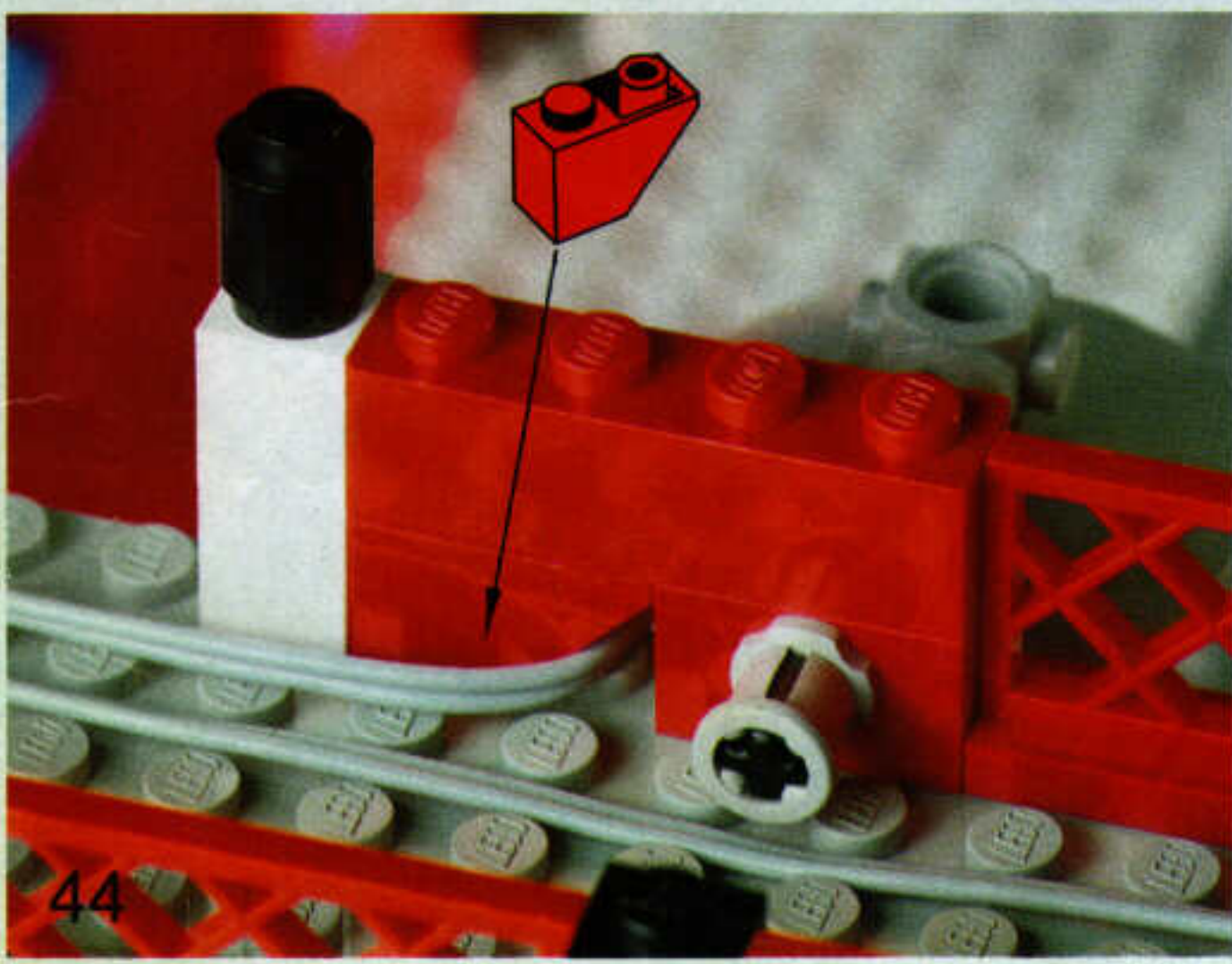
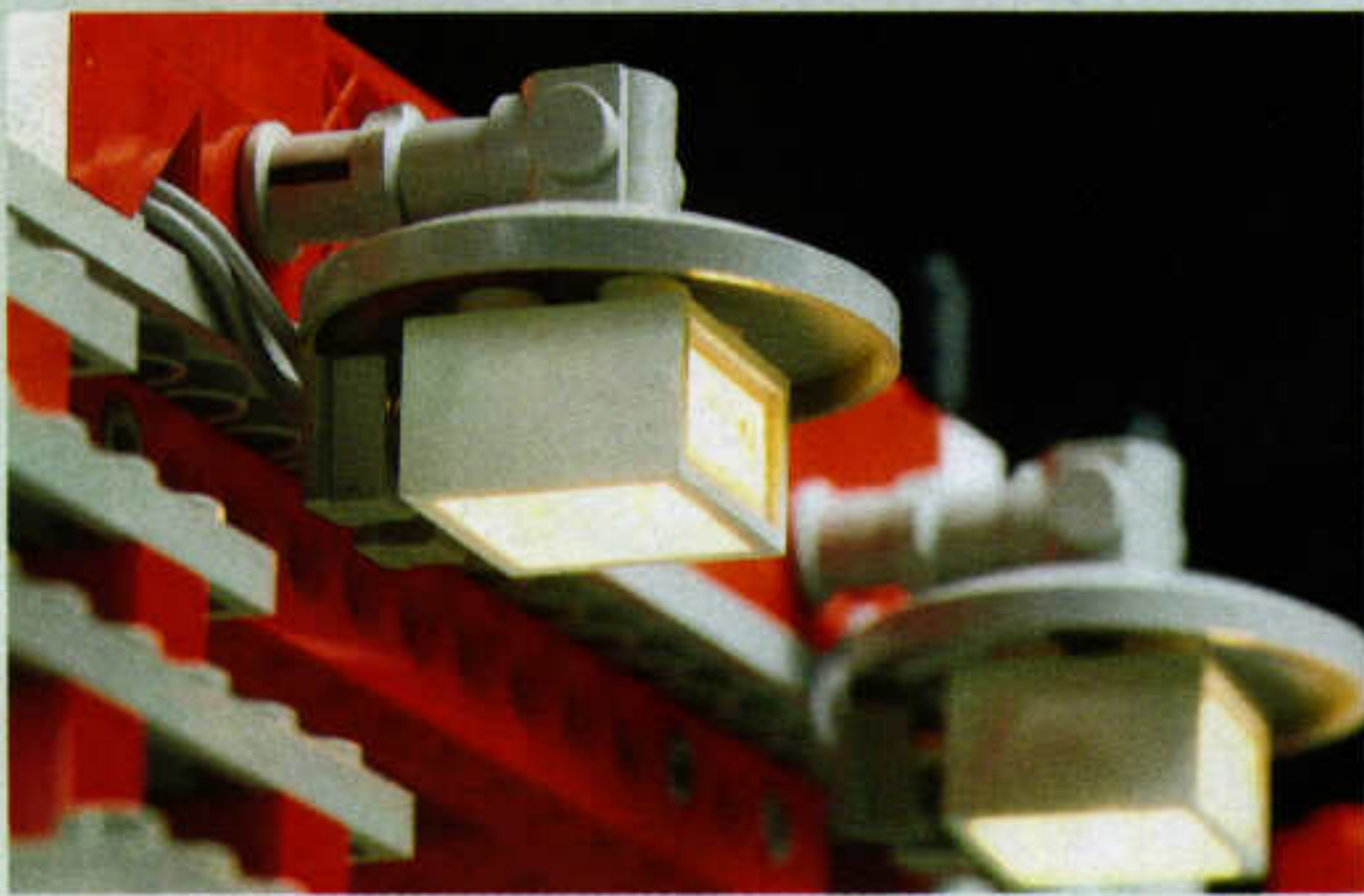

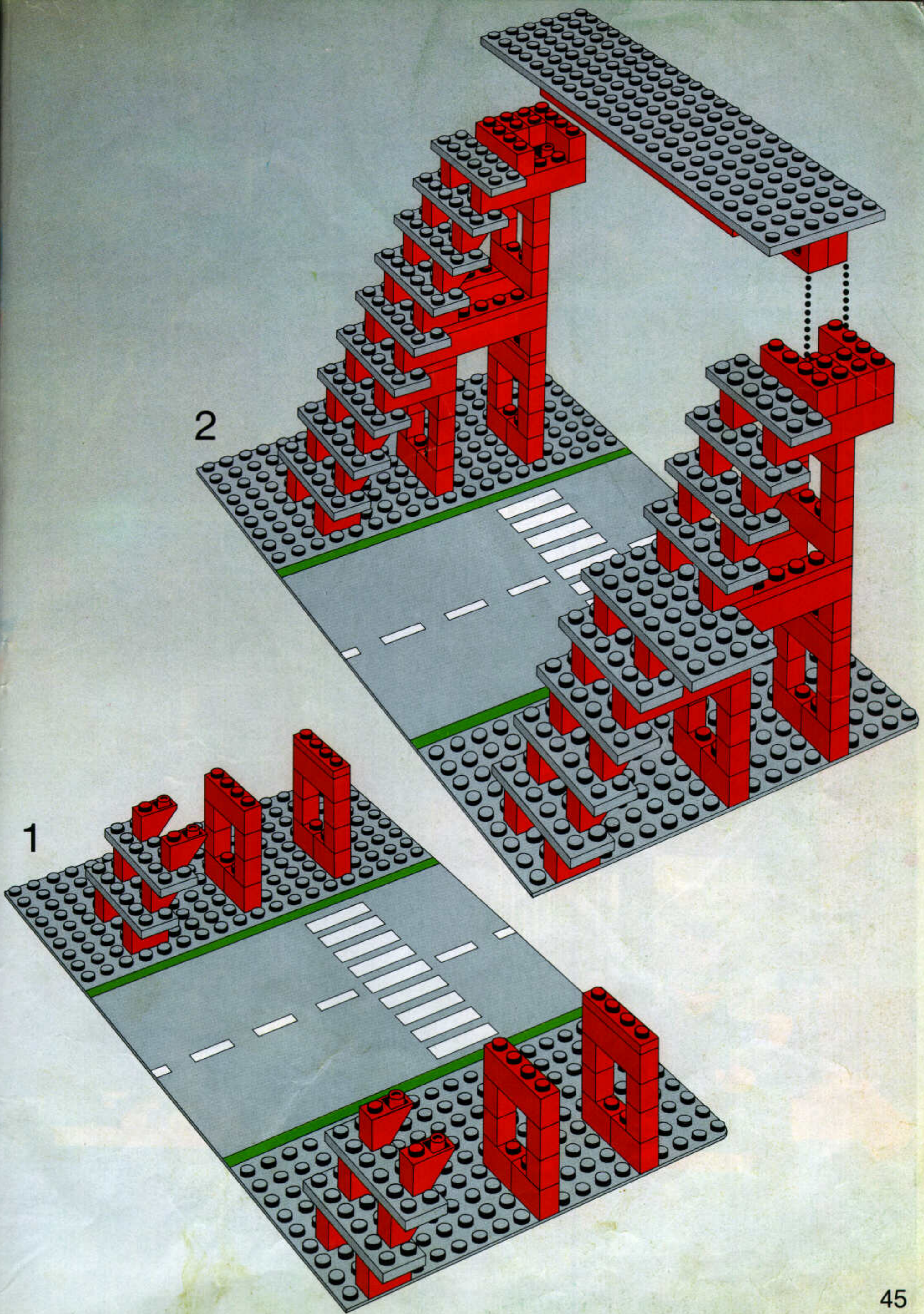

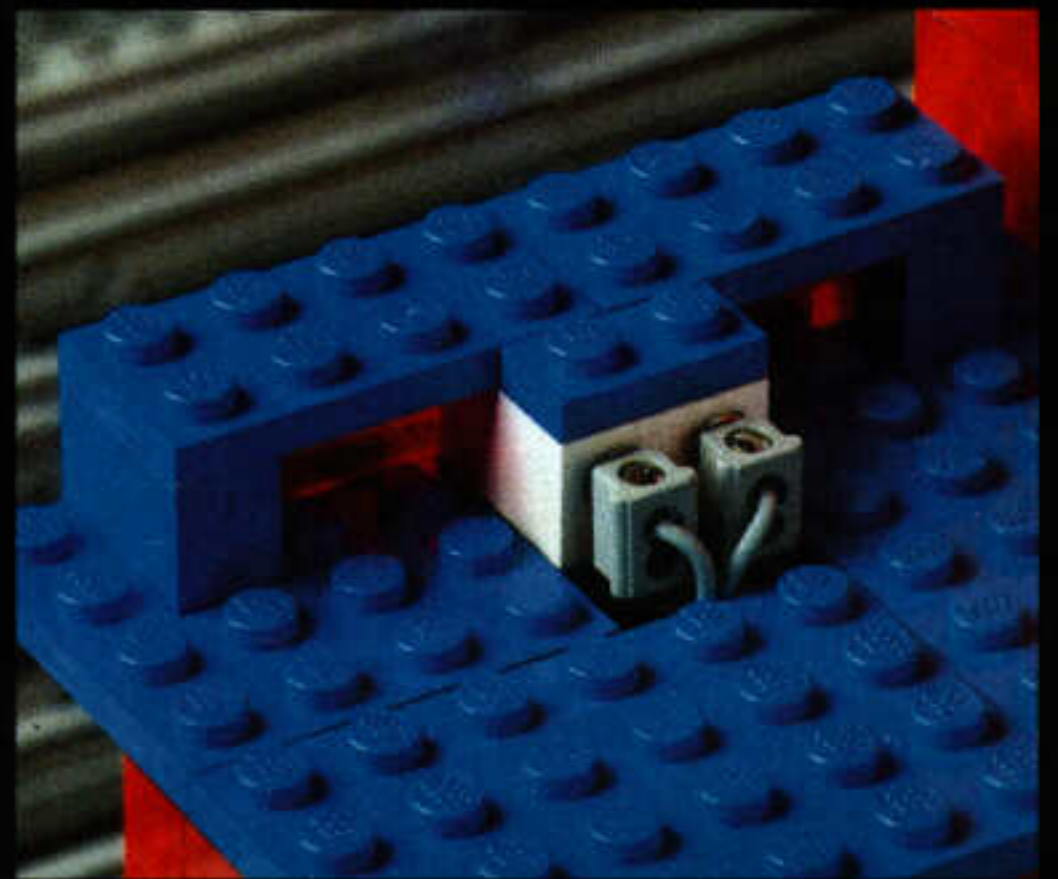

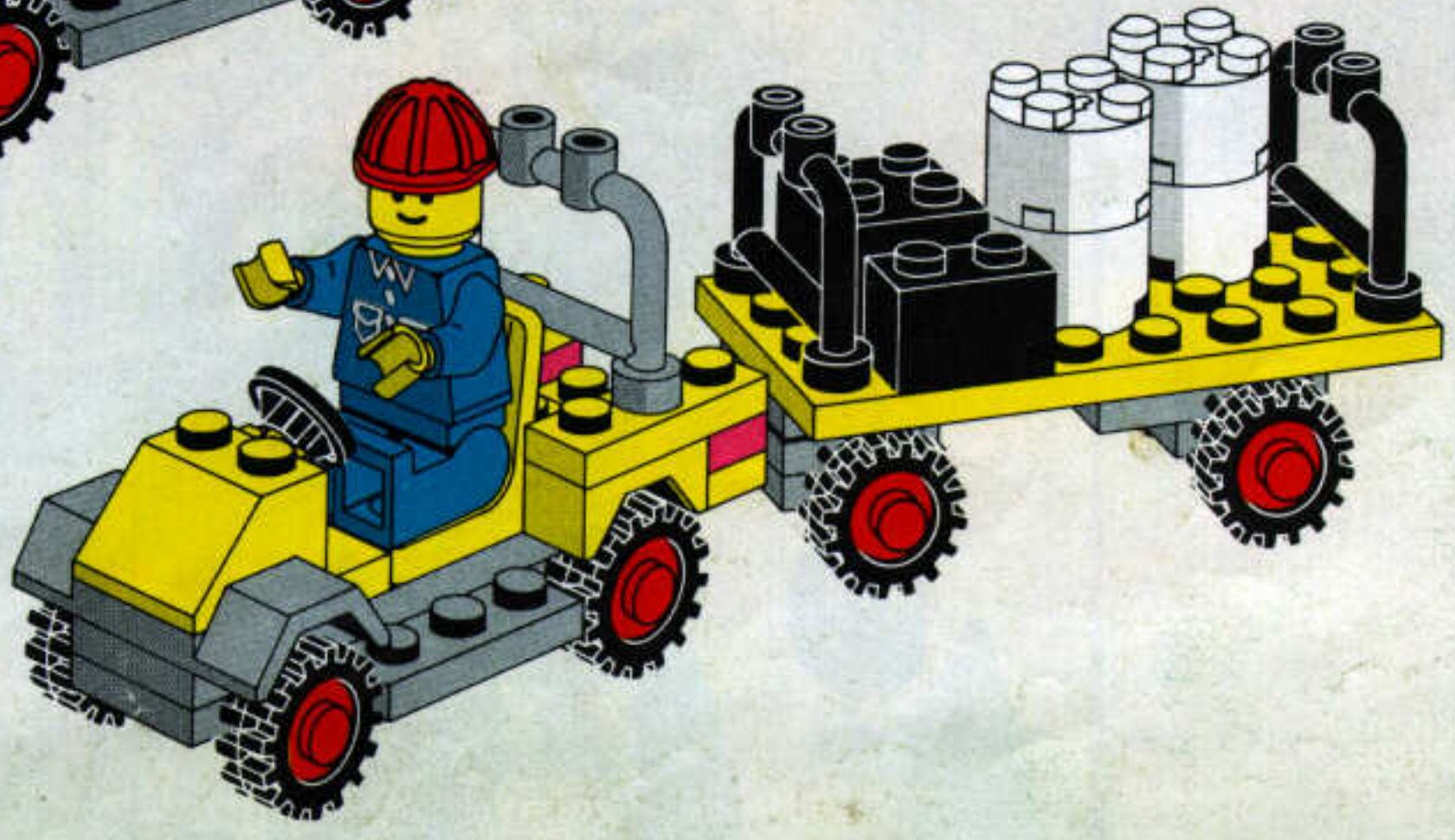
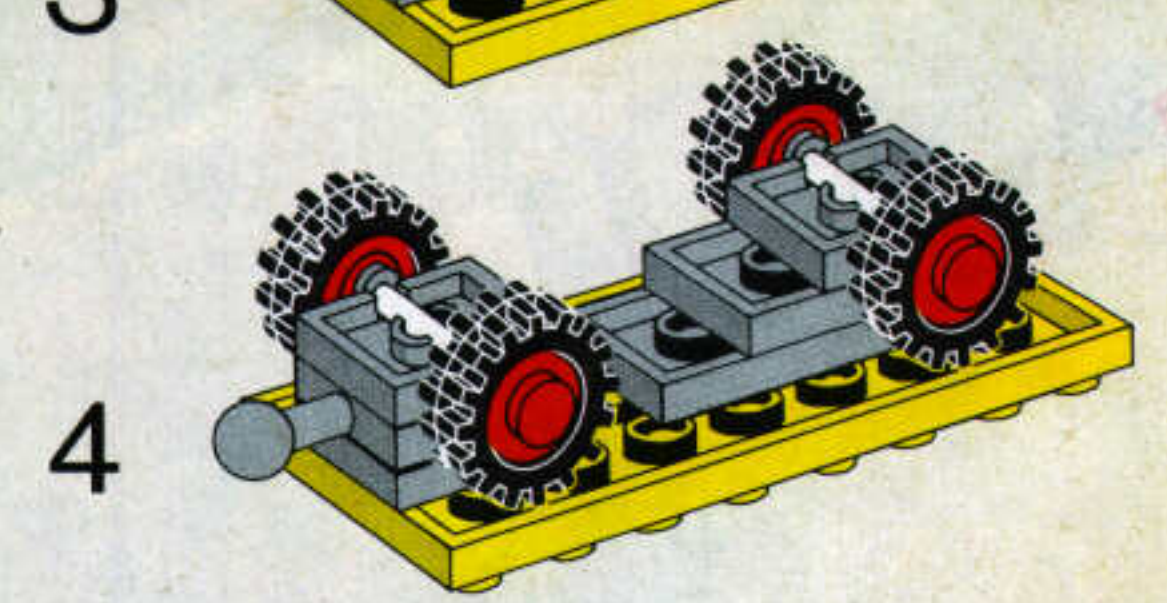
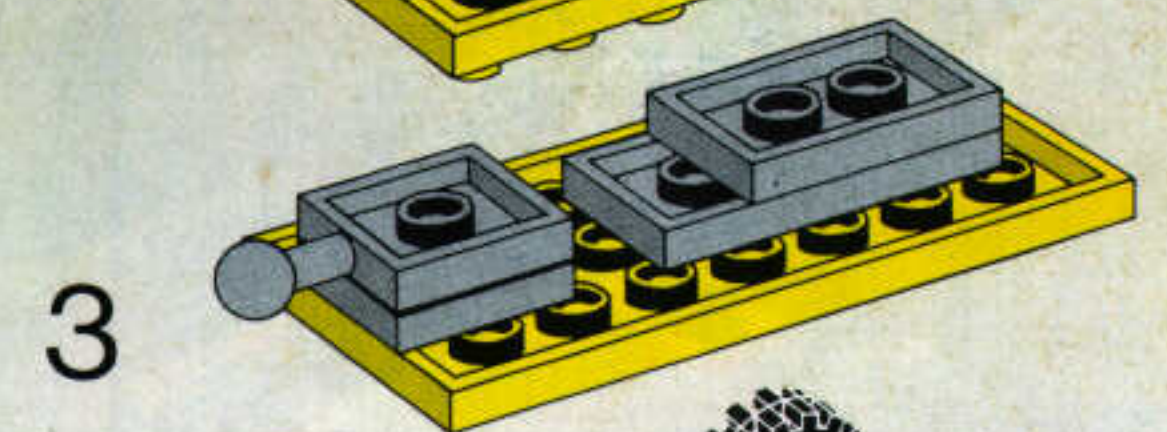
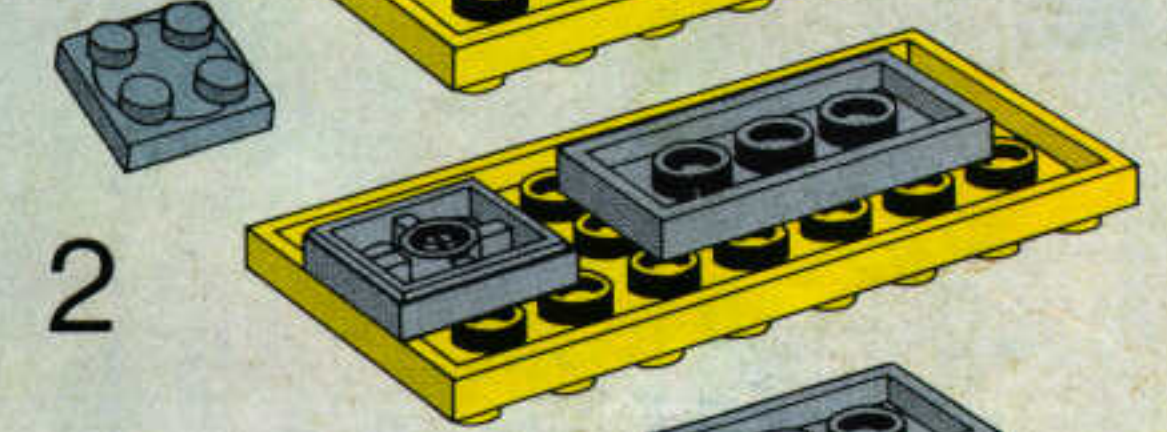
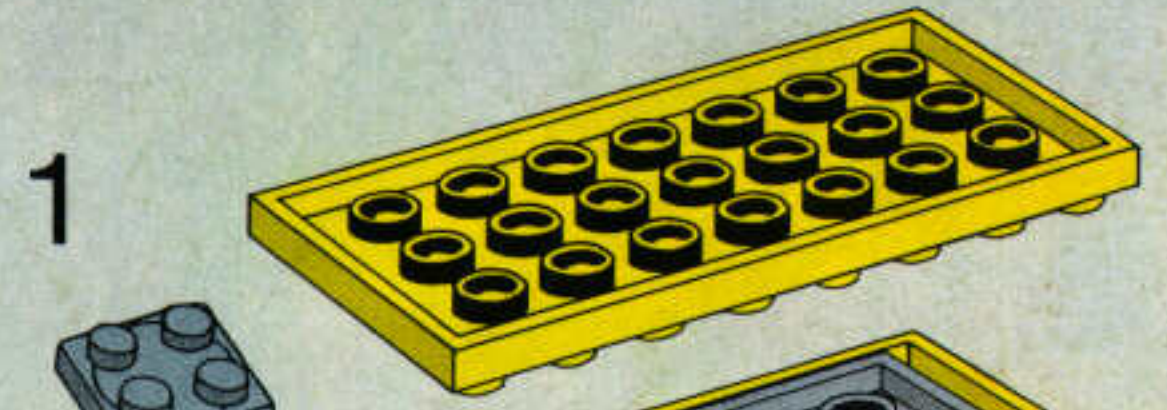
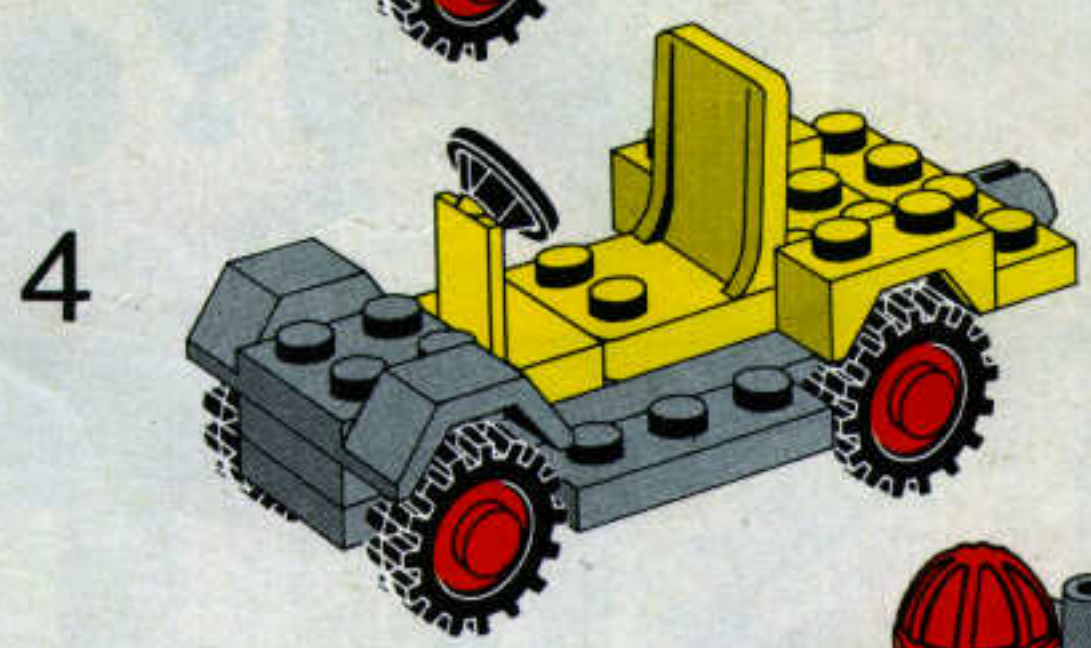
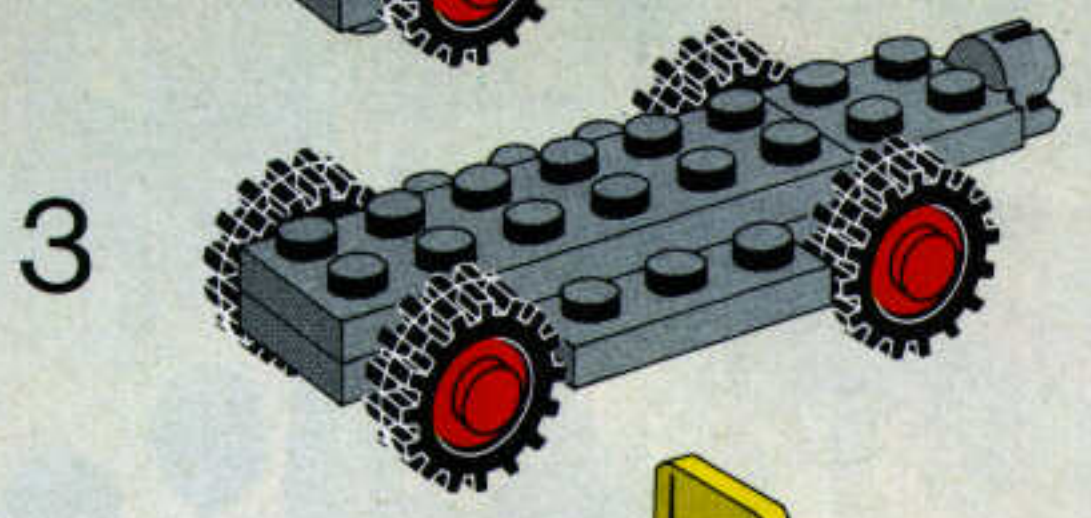
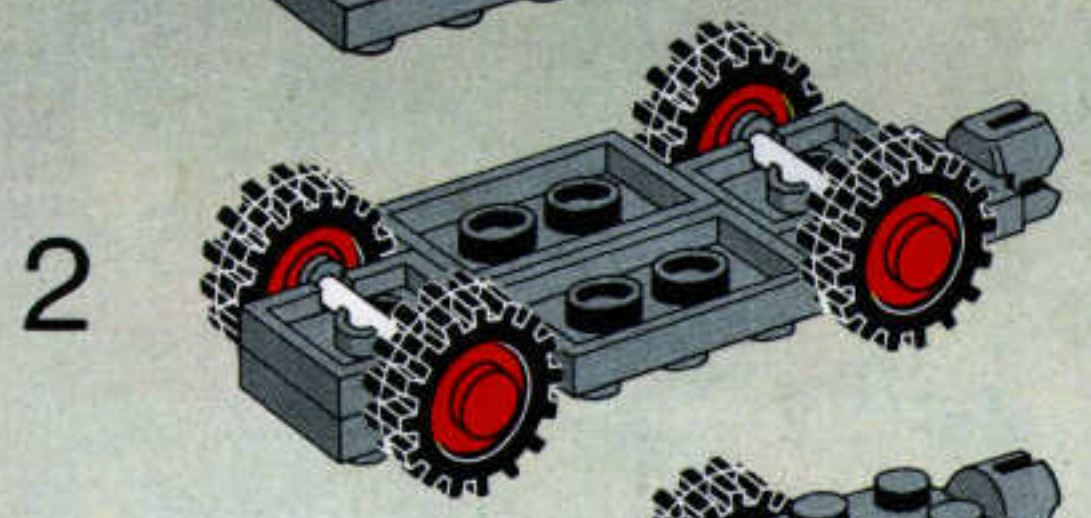
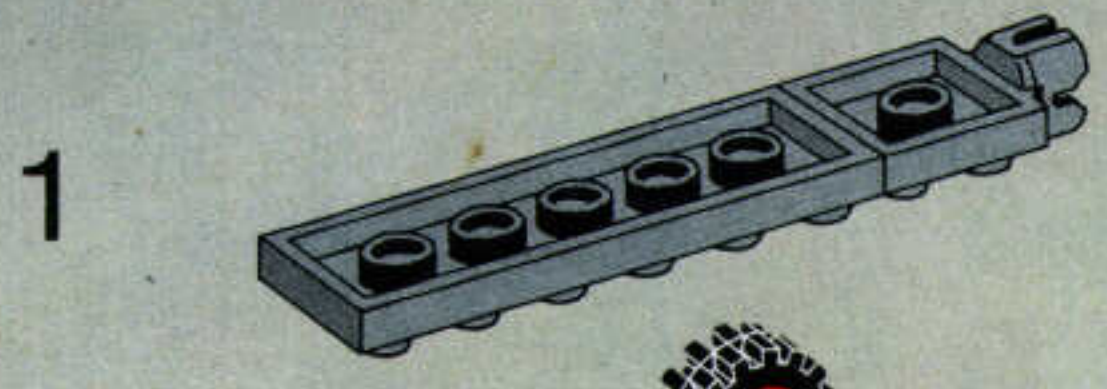
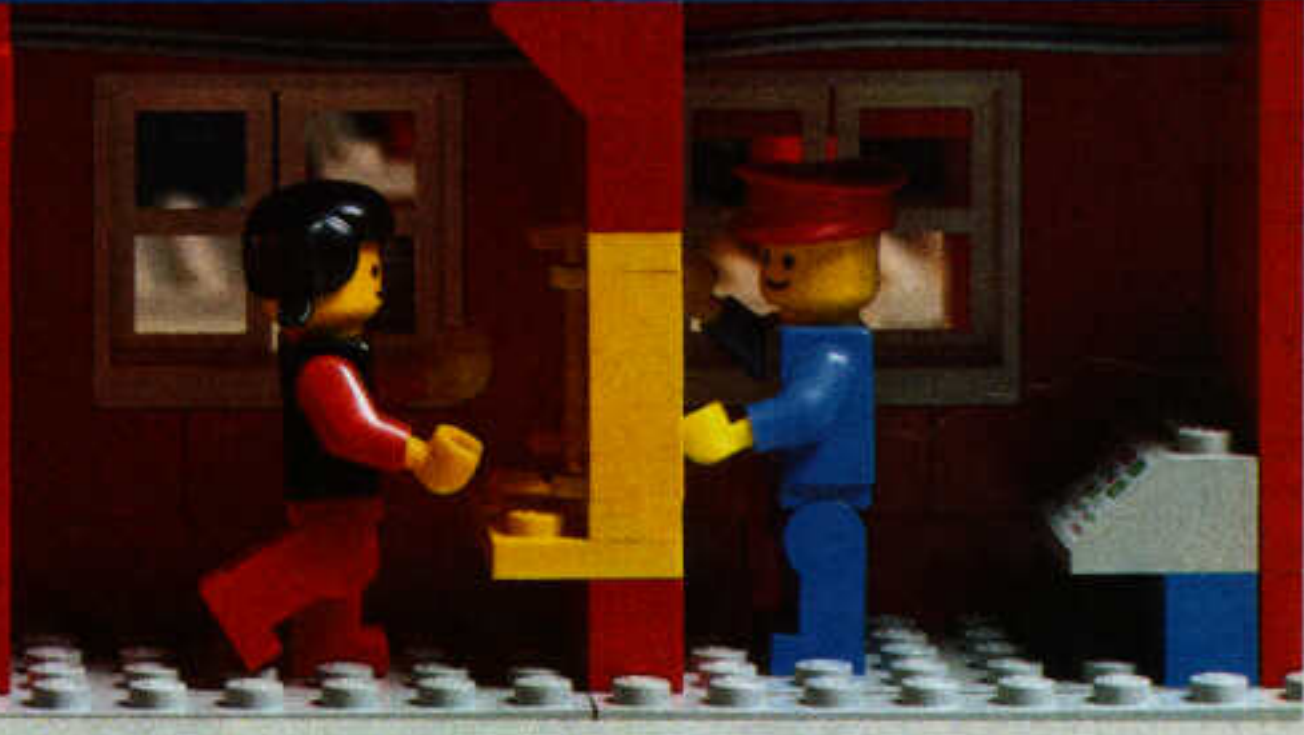





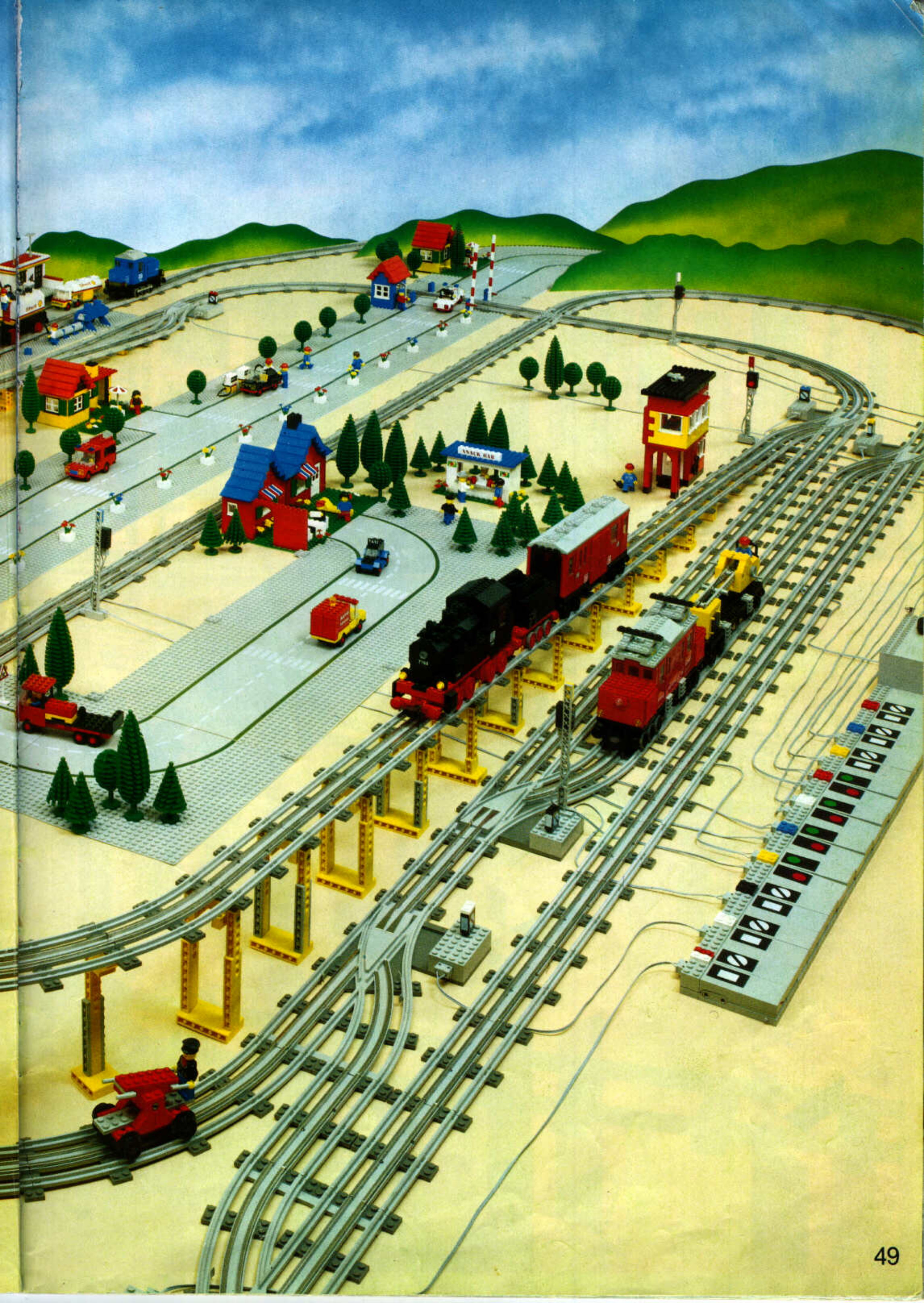

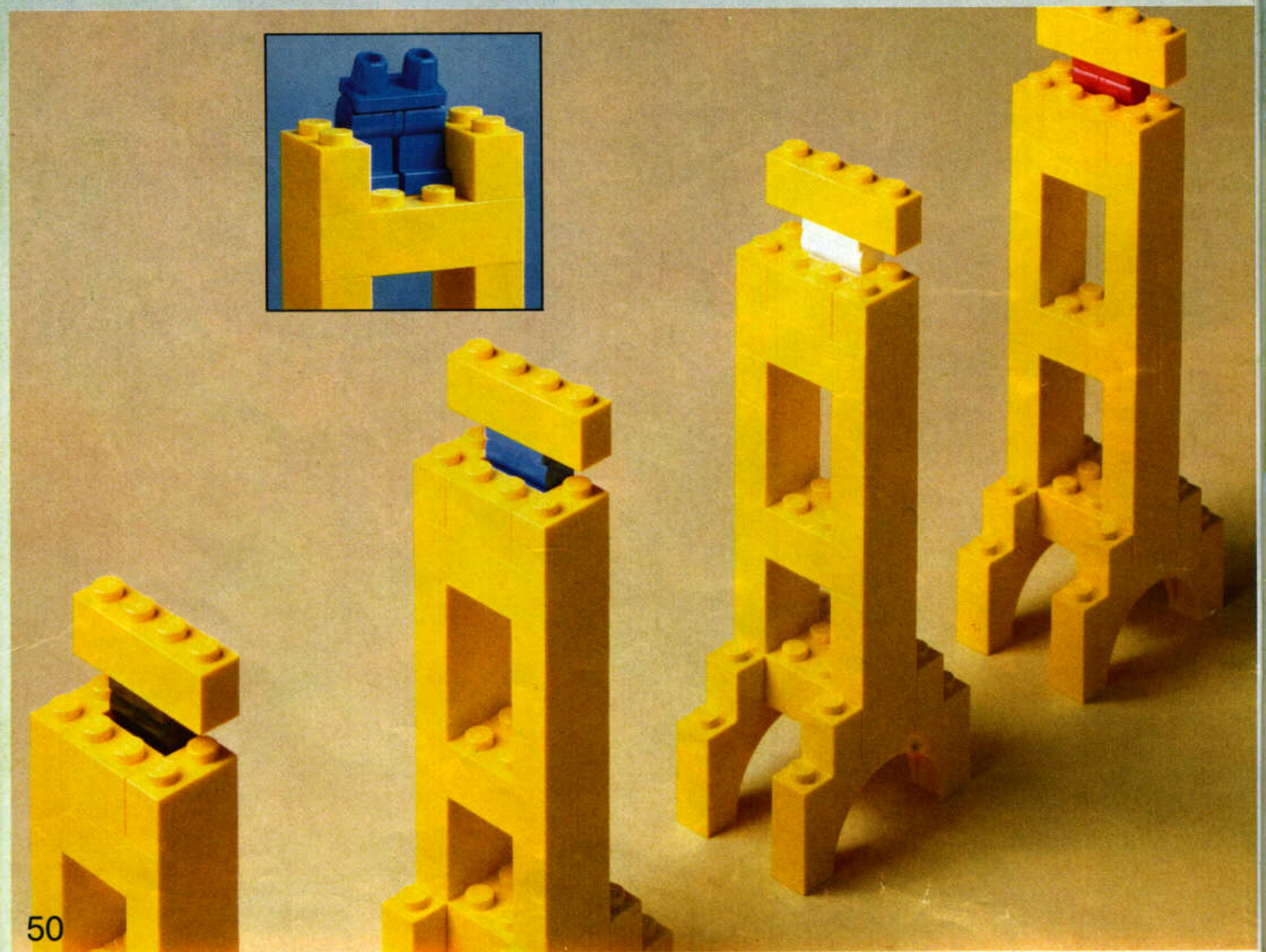
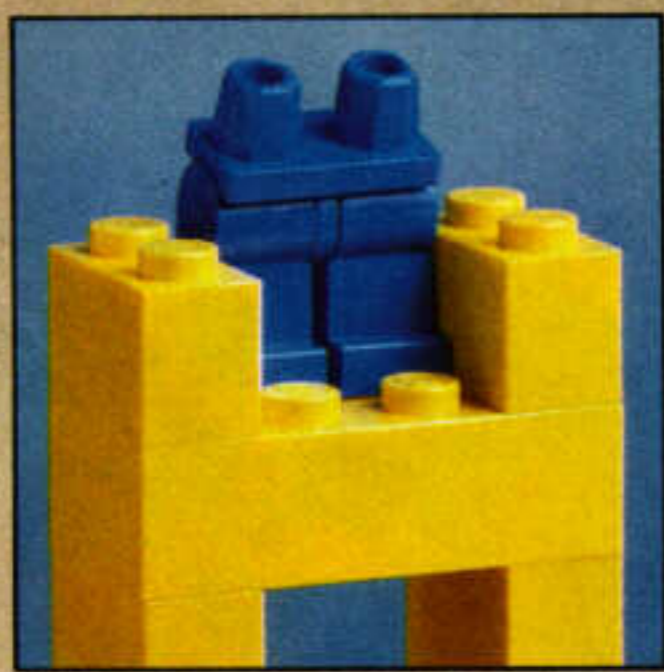

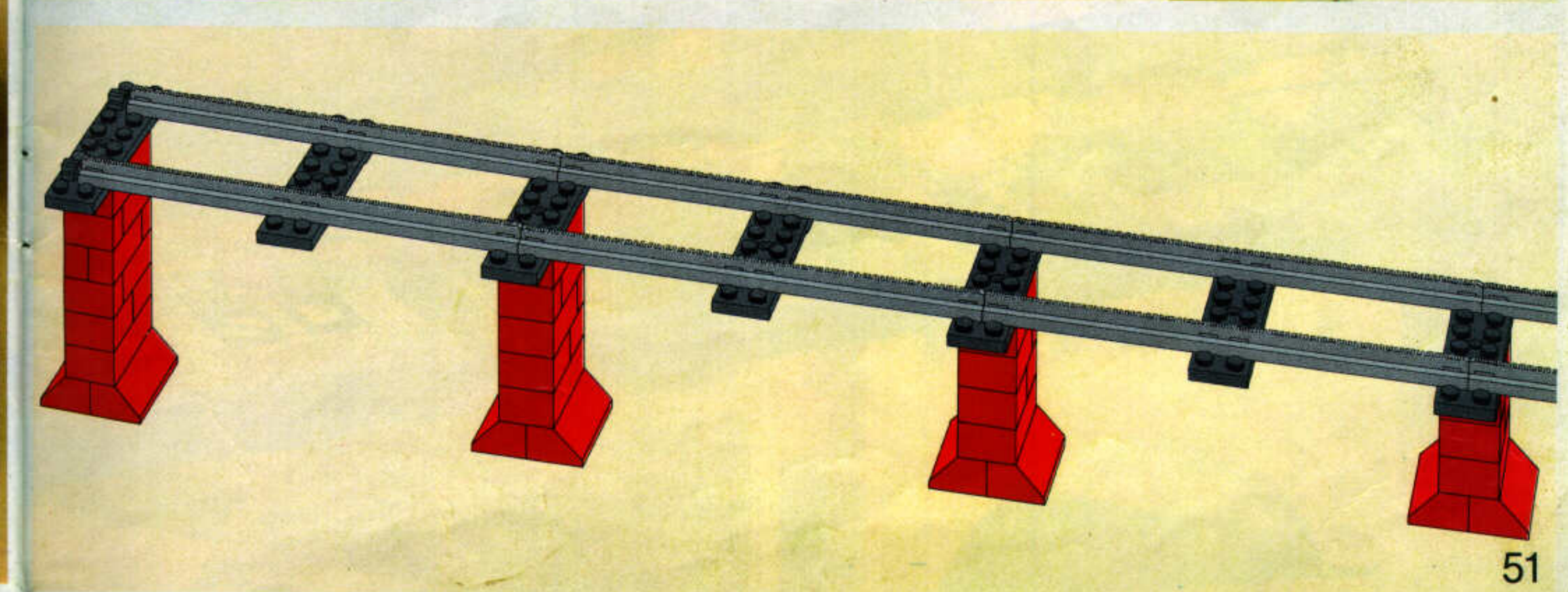
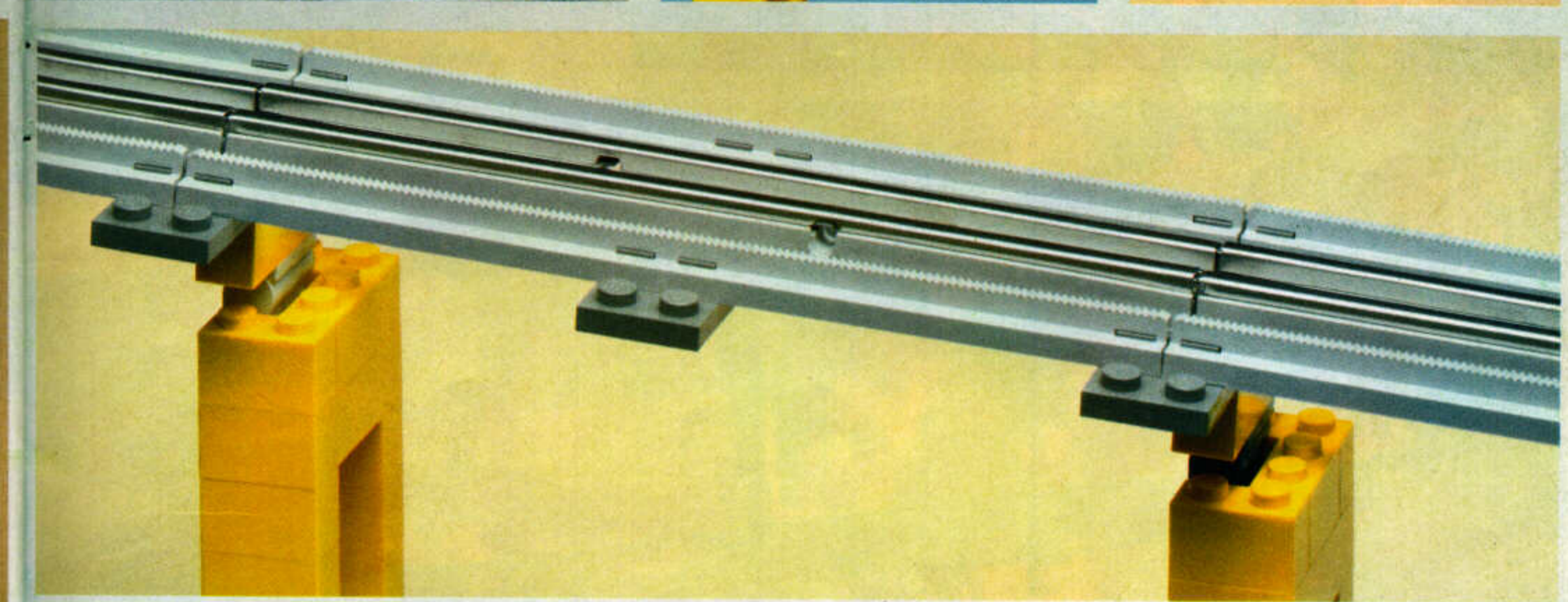
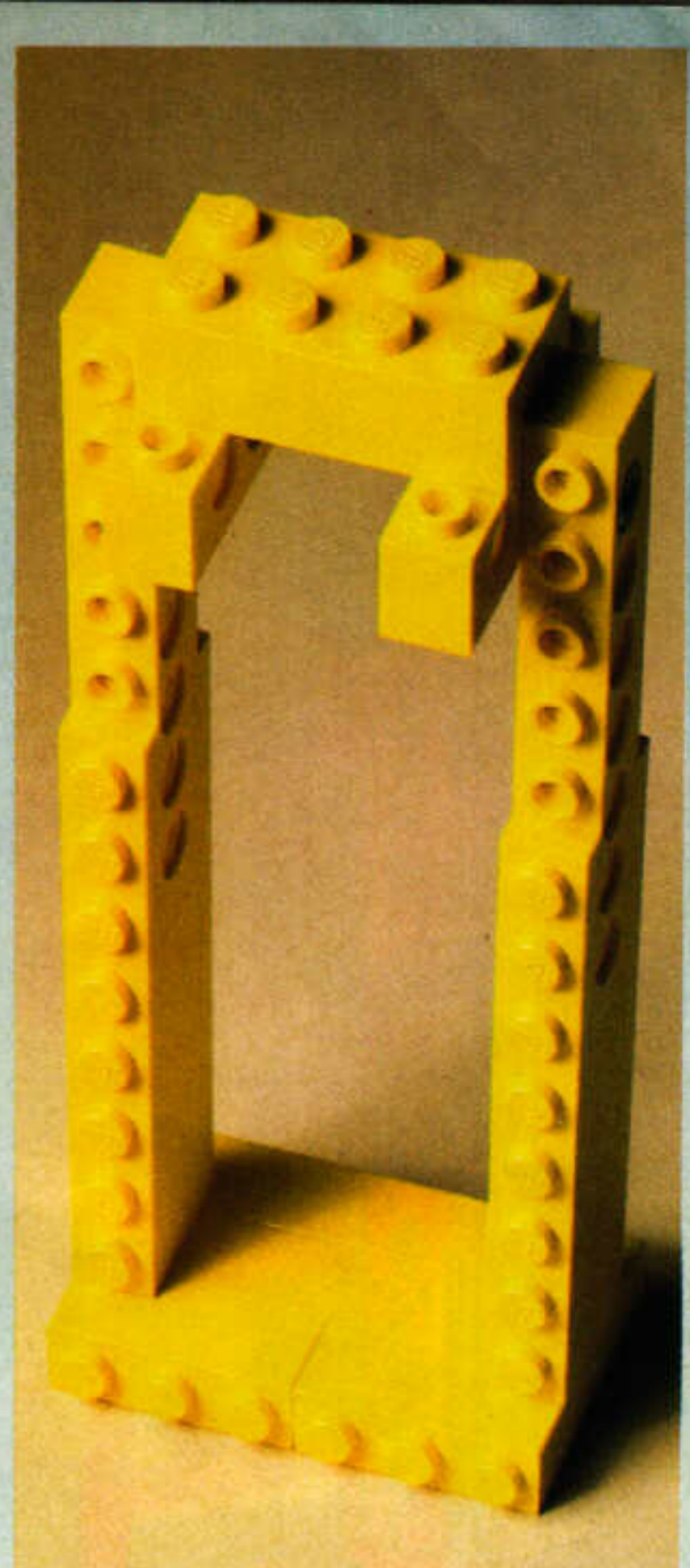
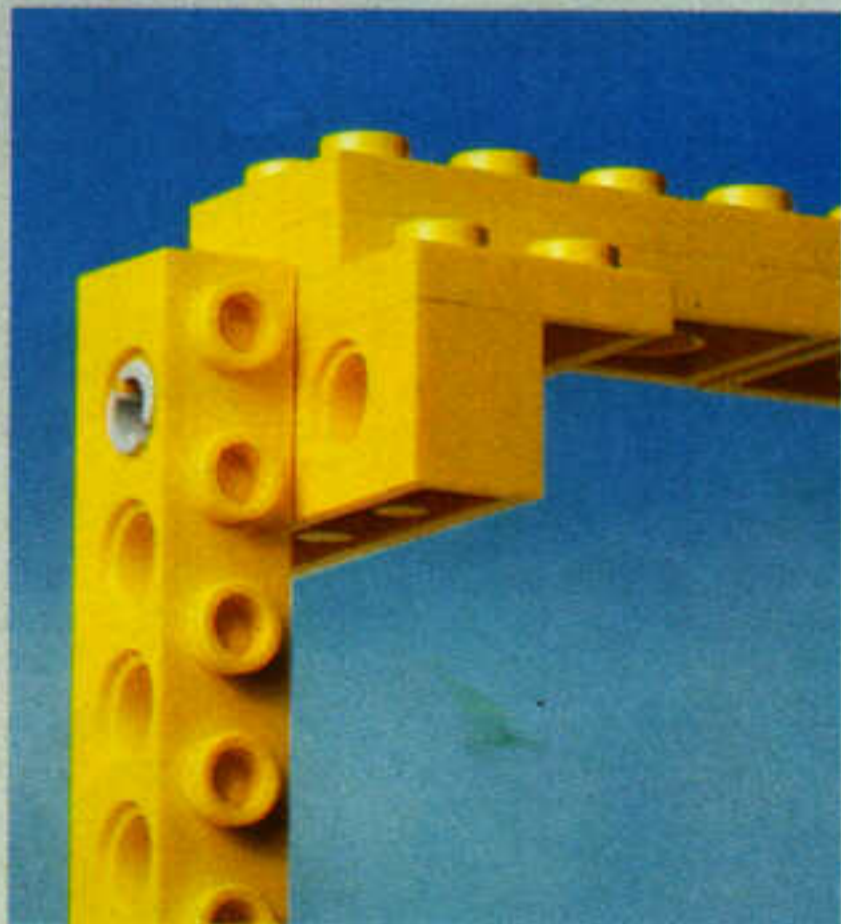

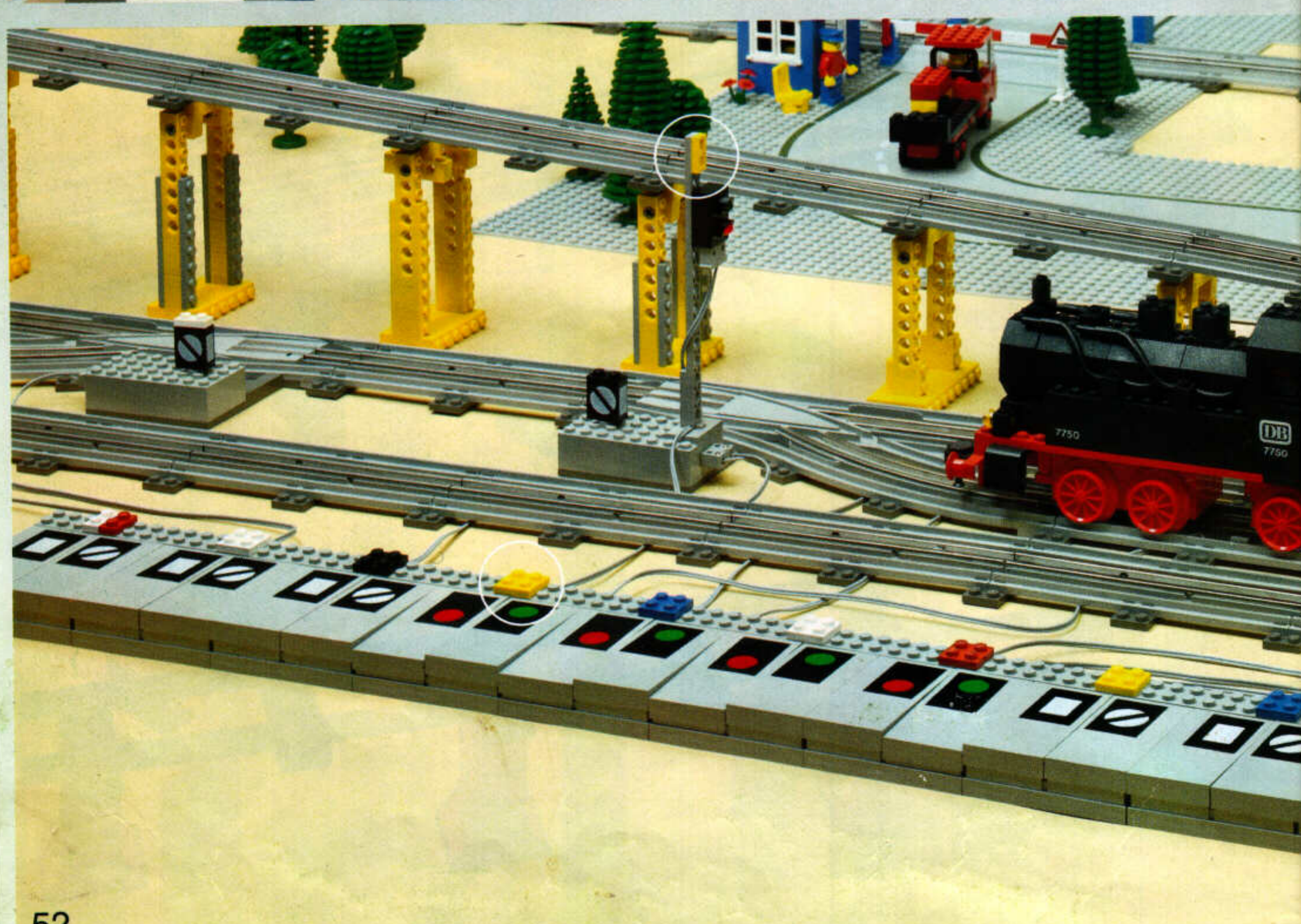
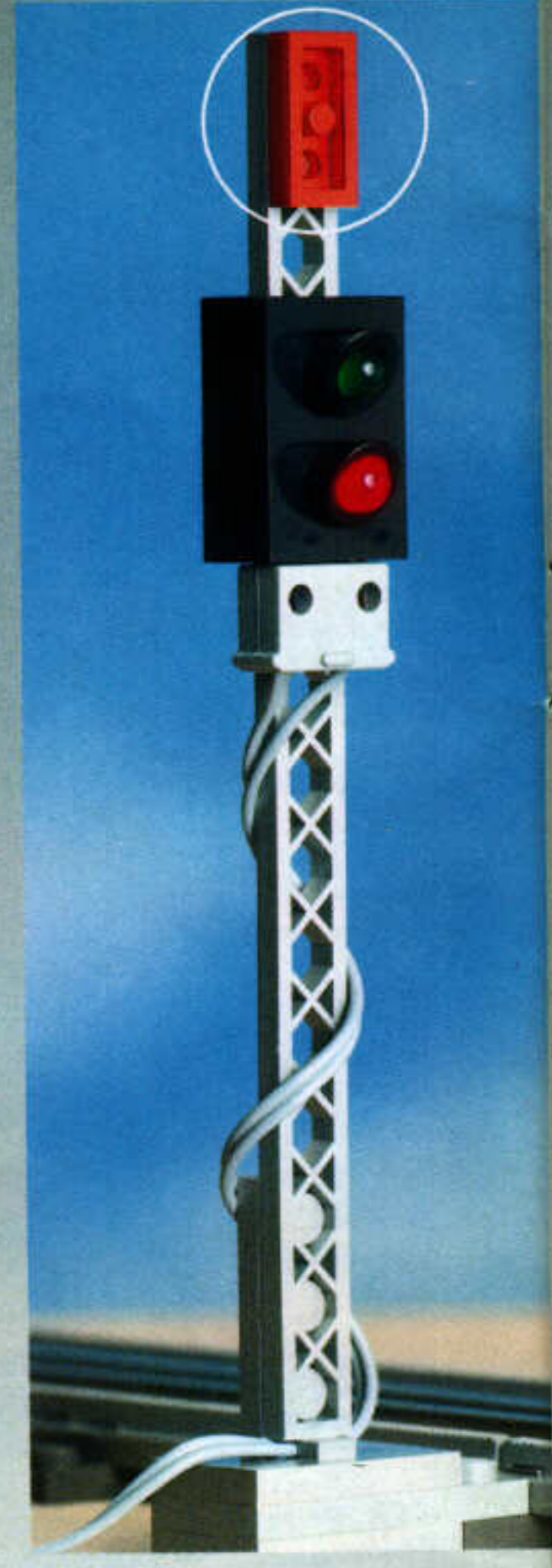
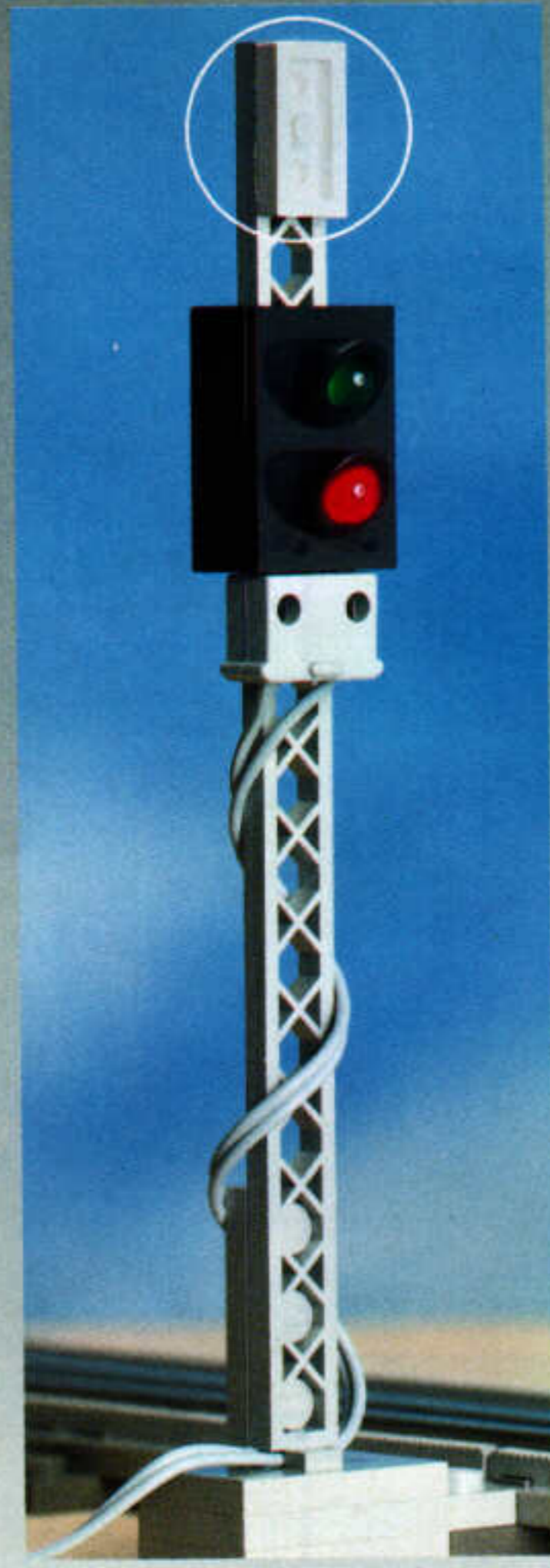
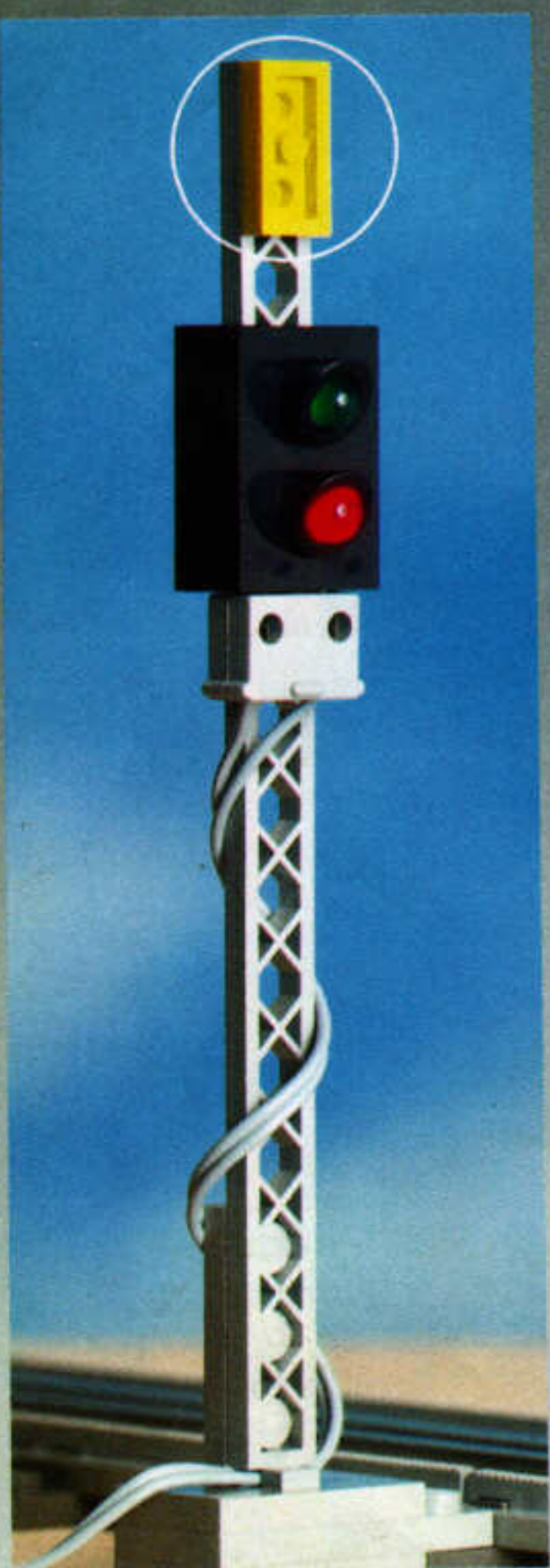

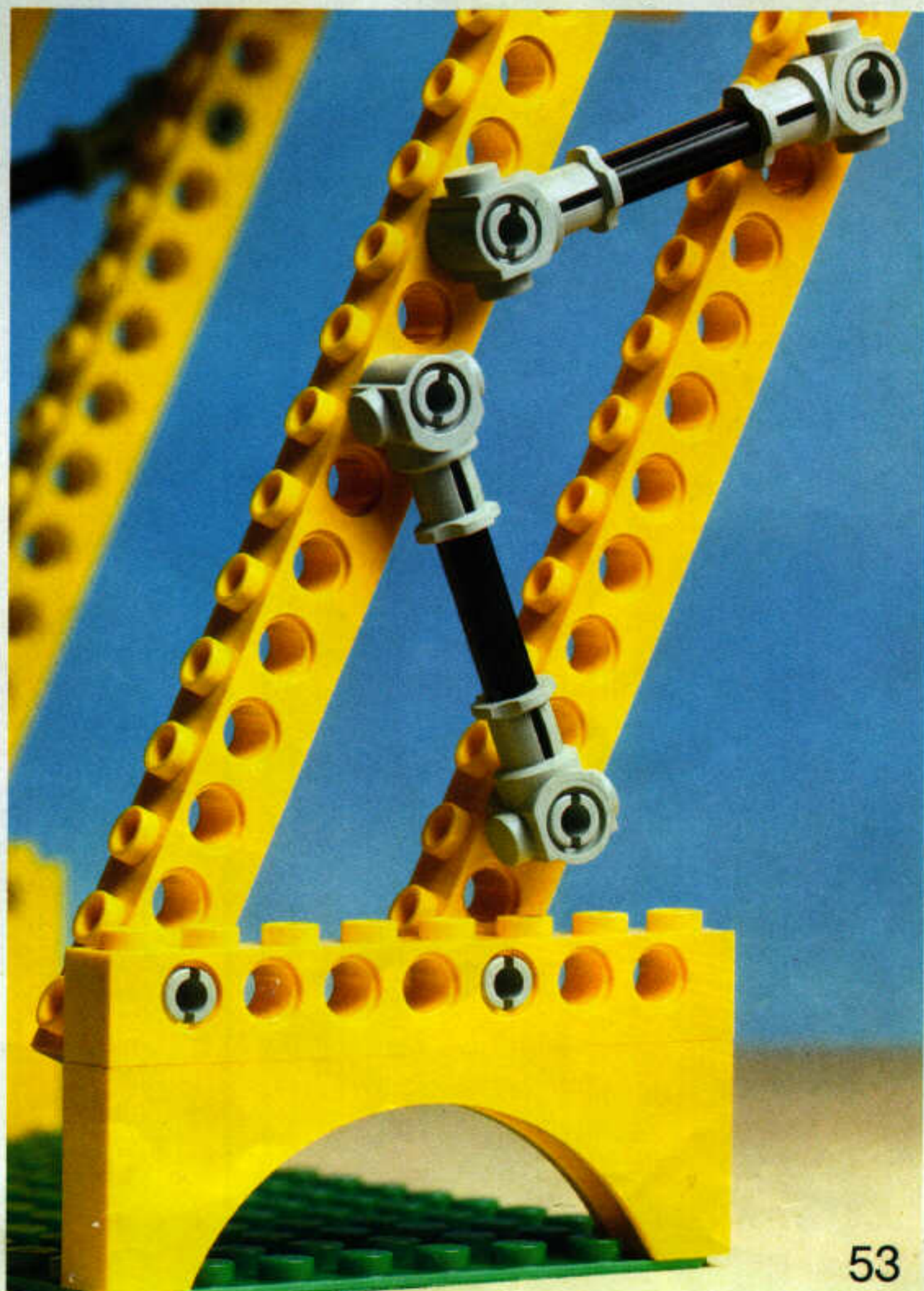

1

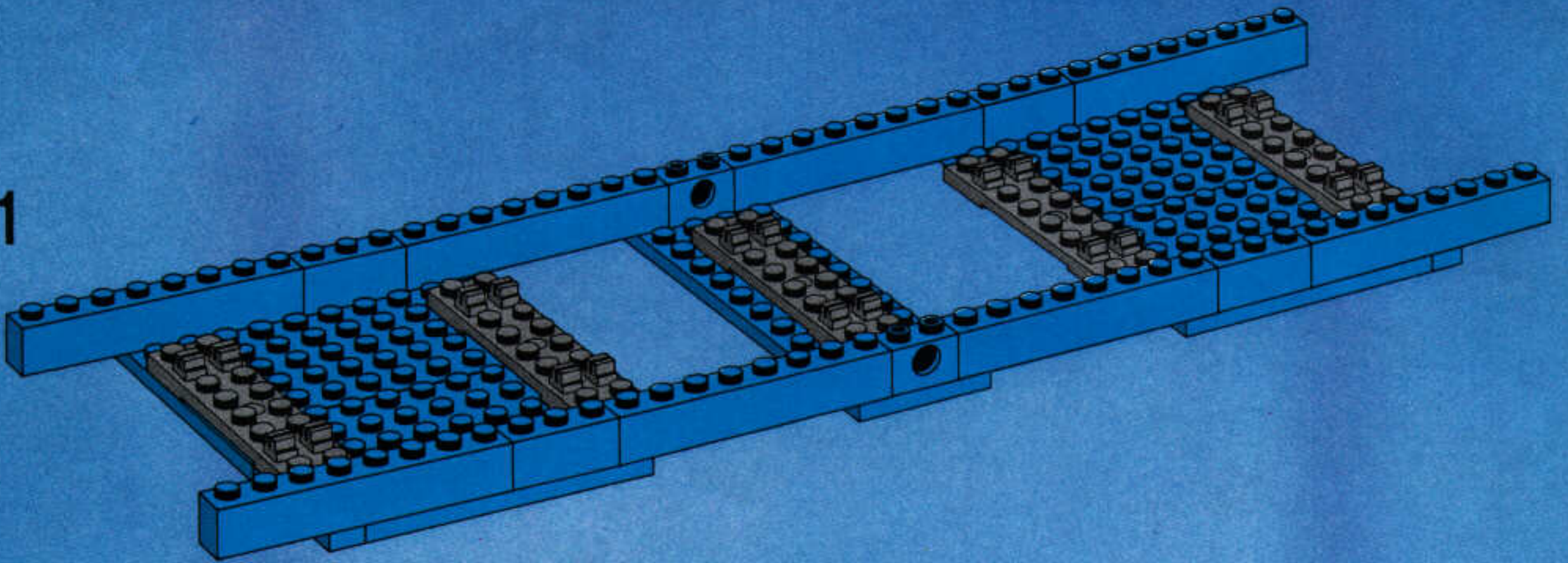

2

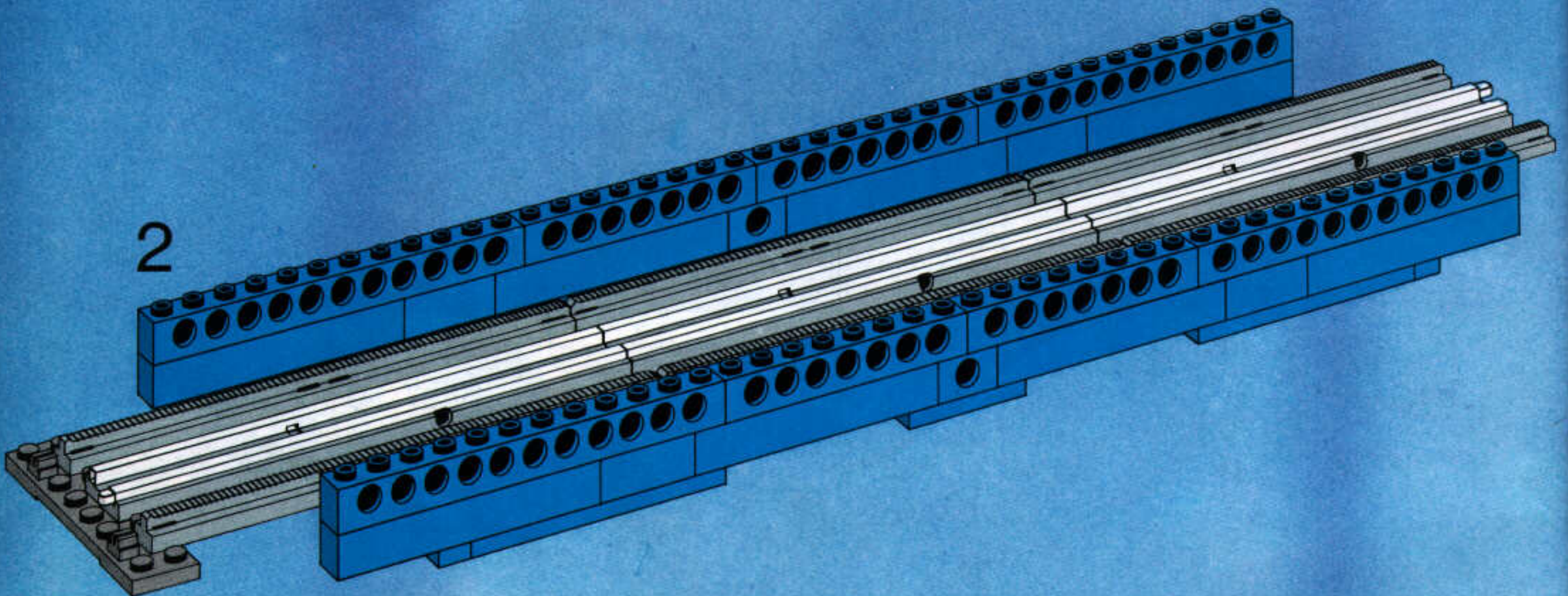

3

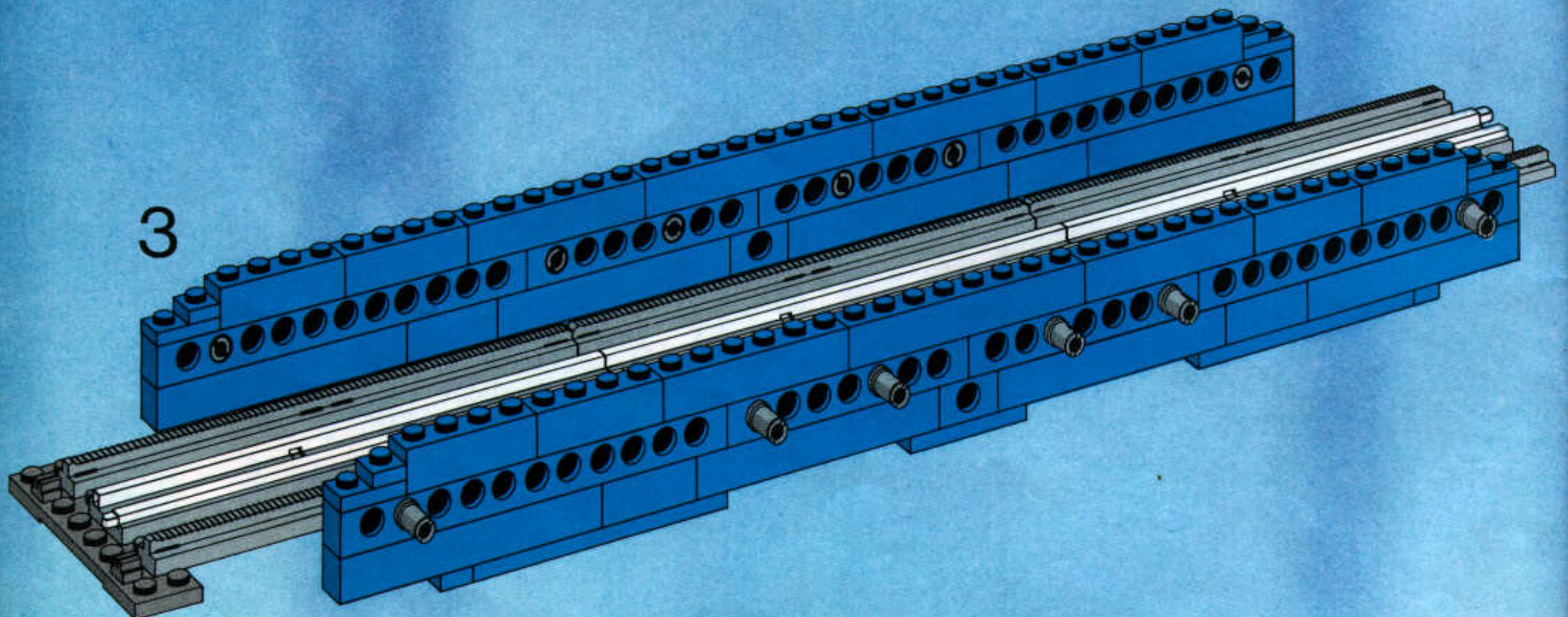



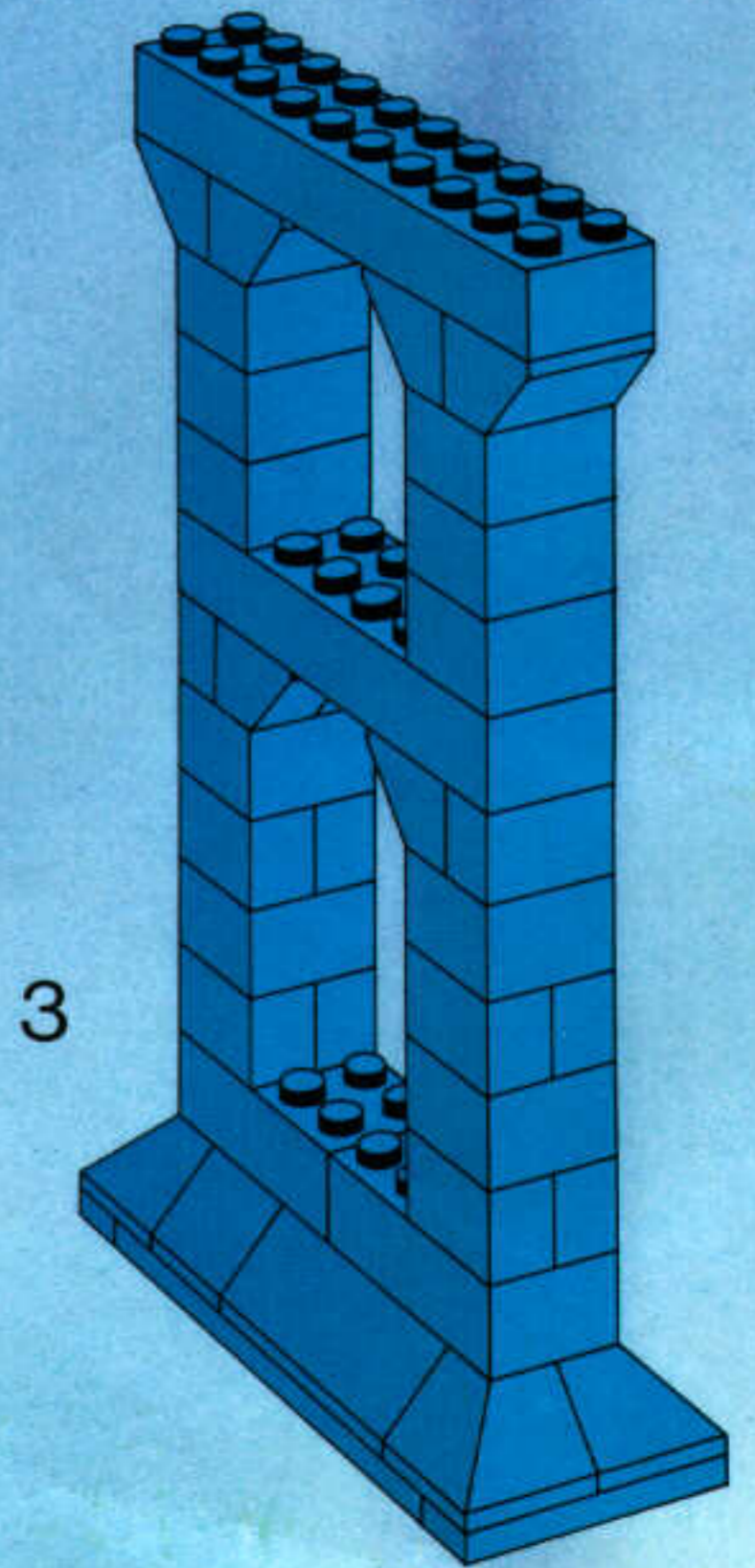
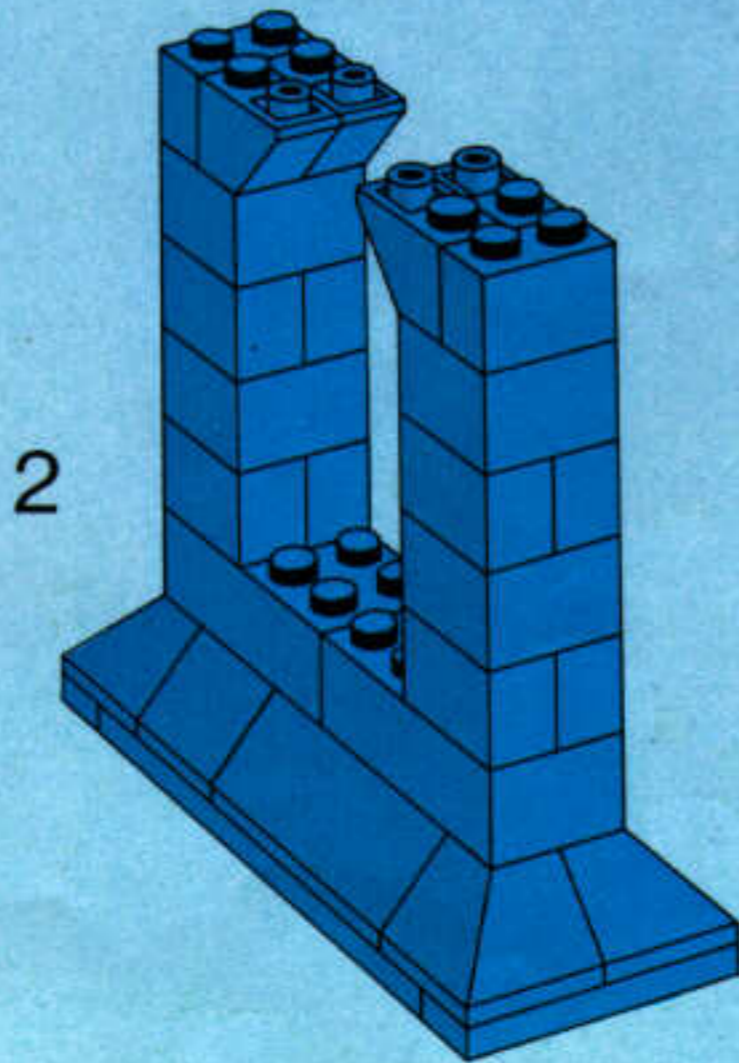
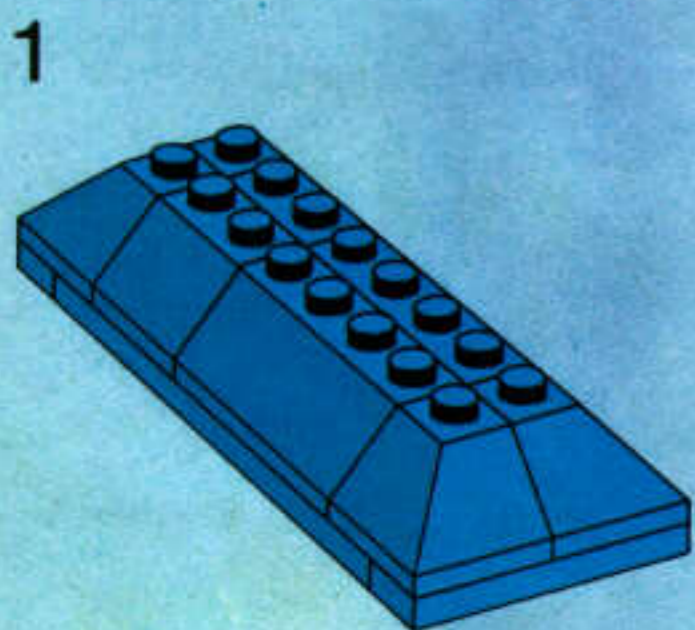
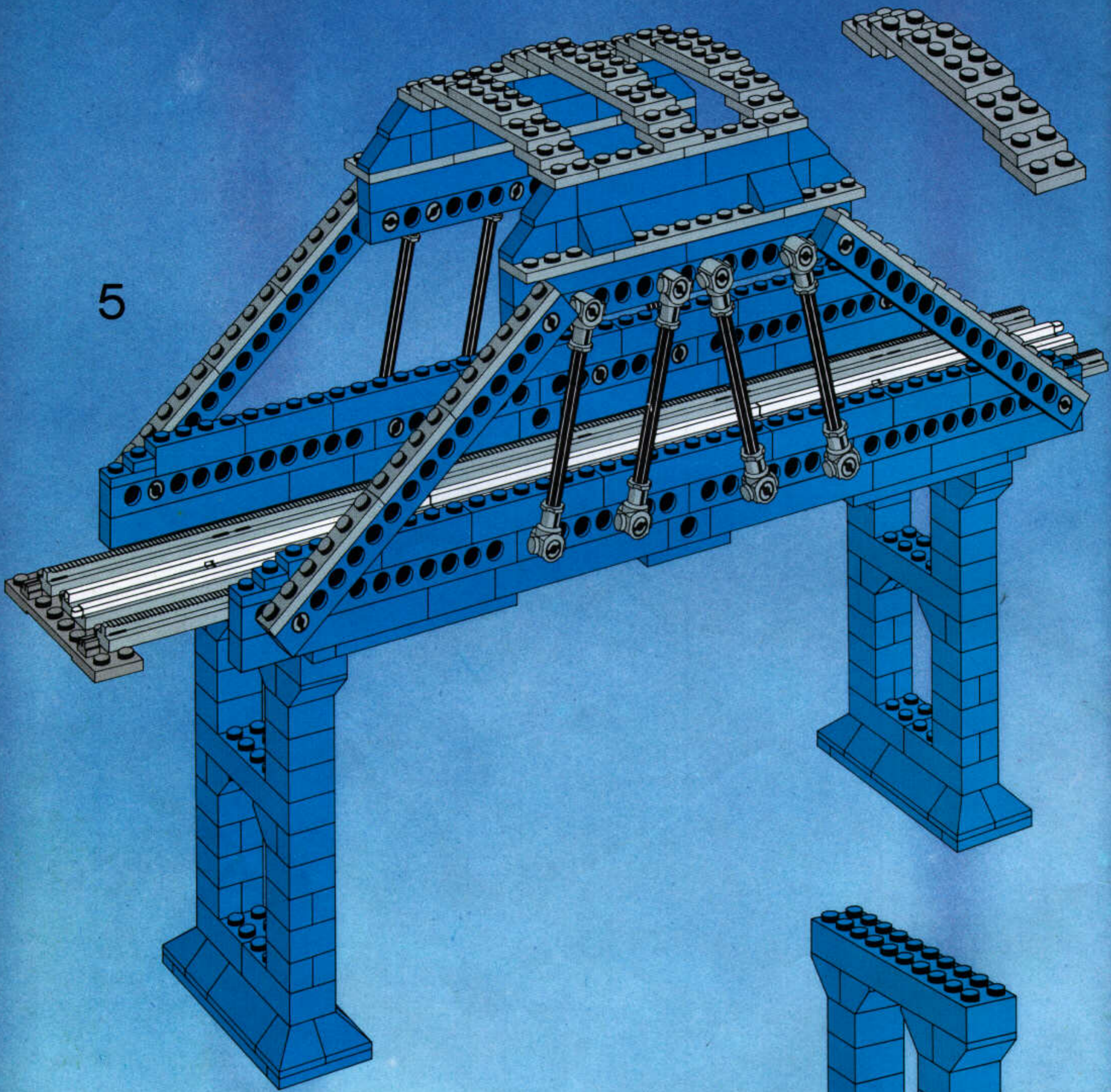



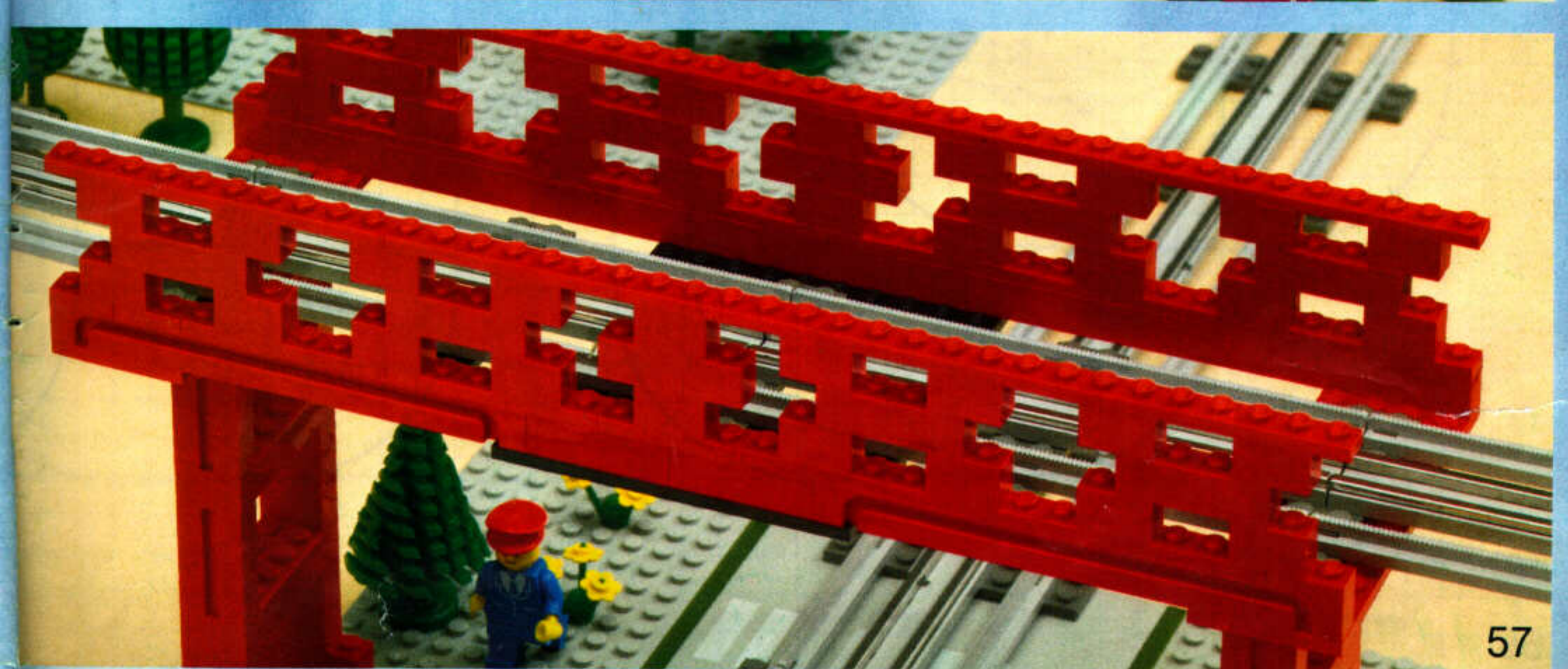
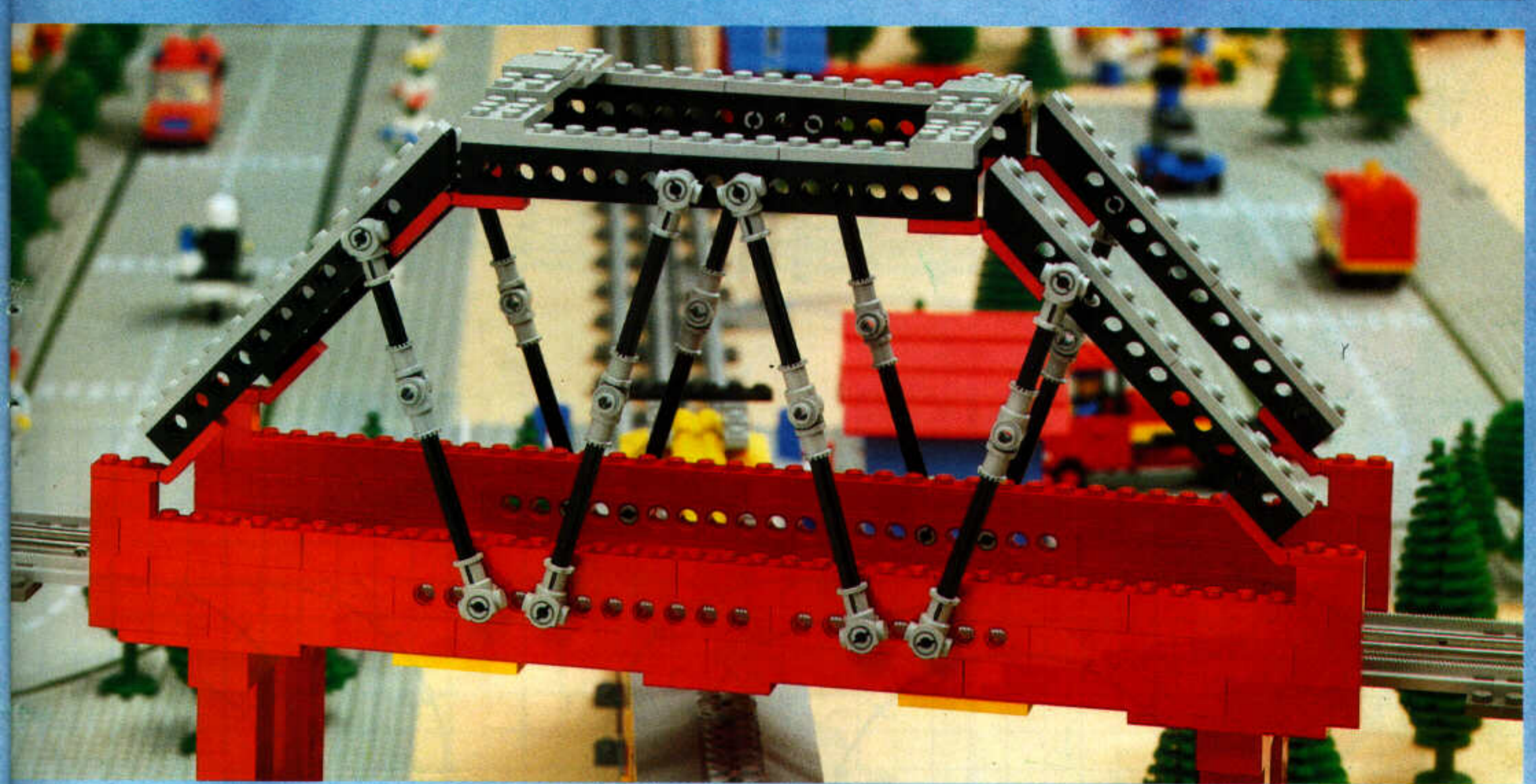
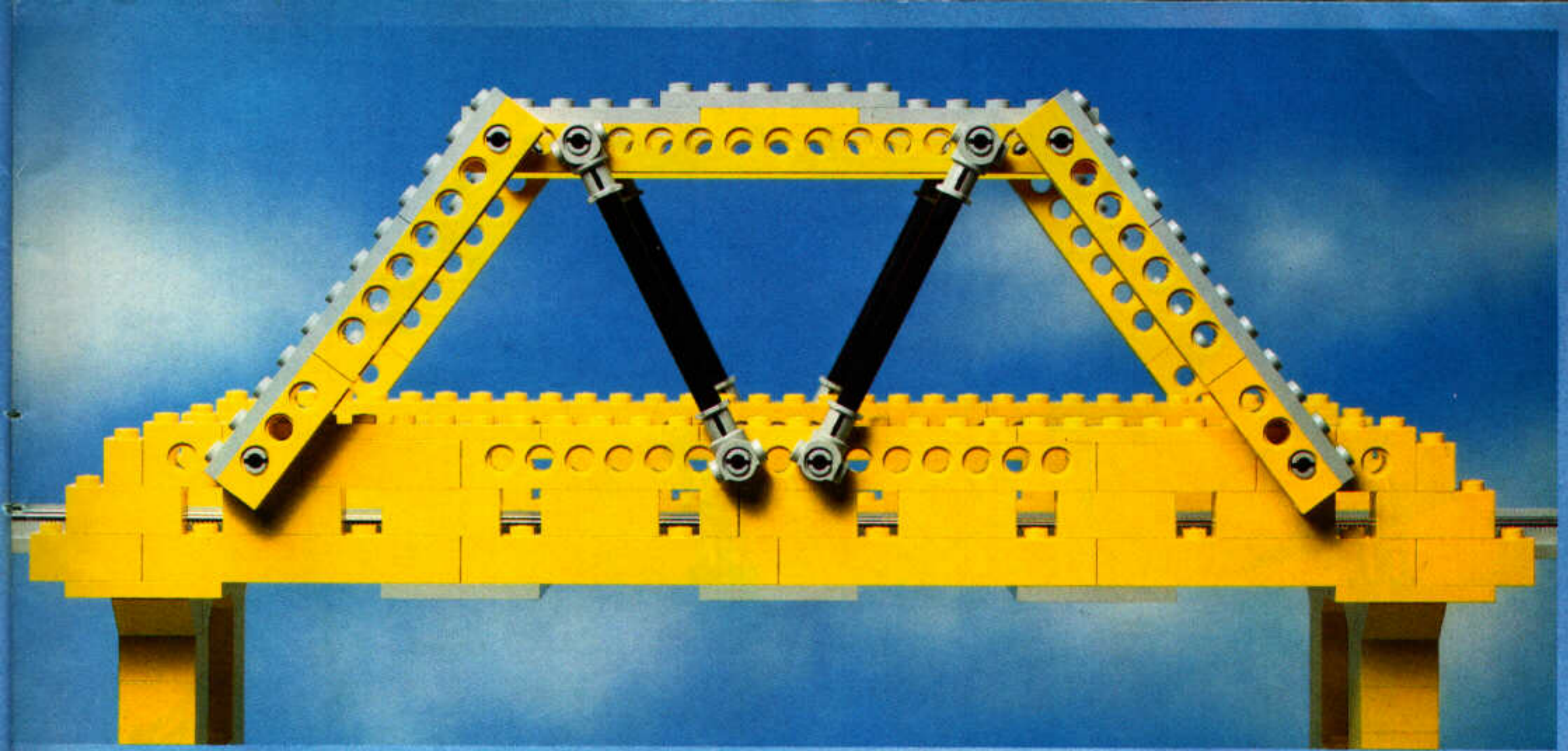

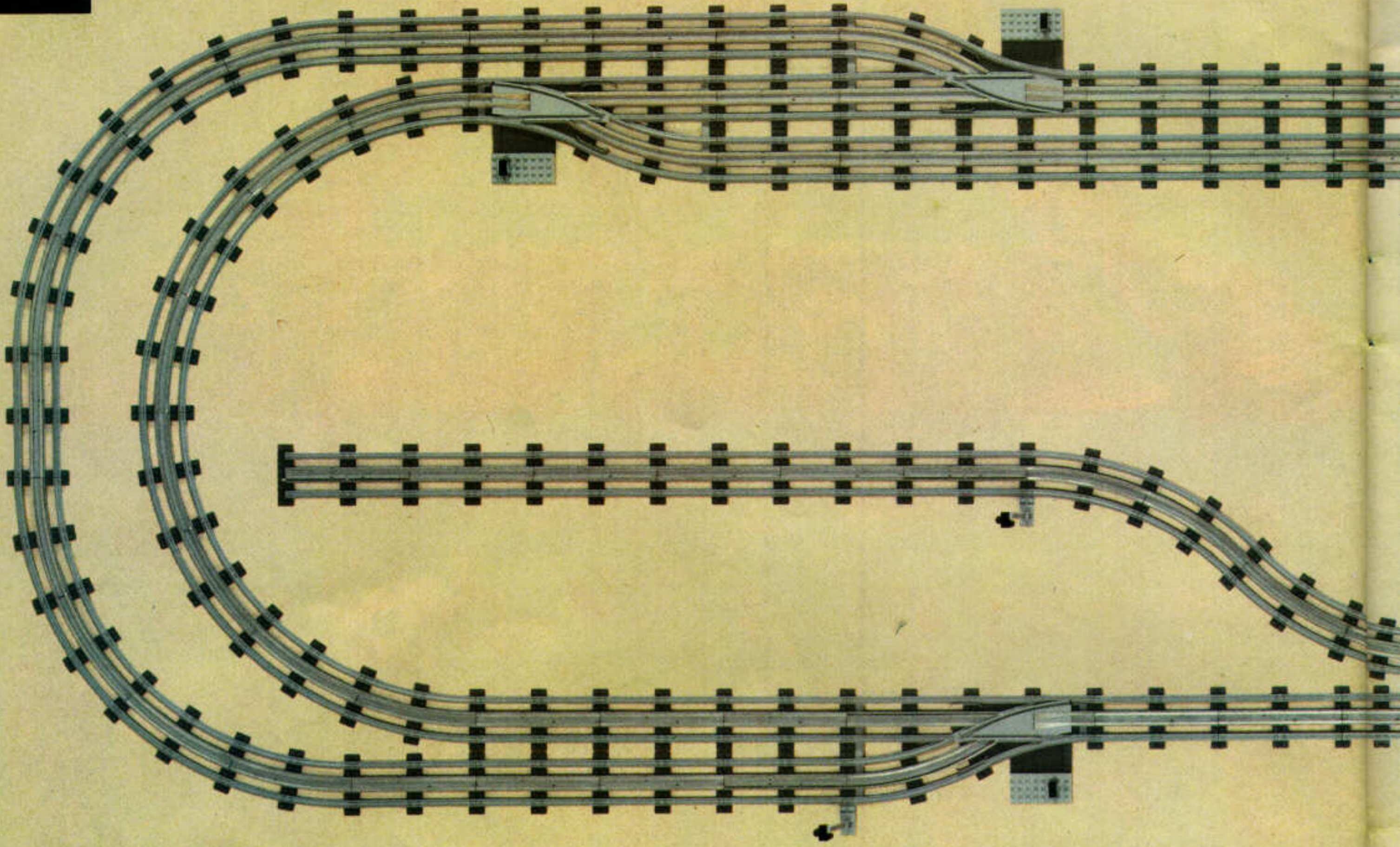
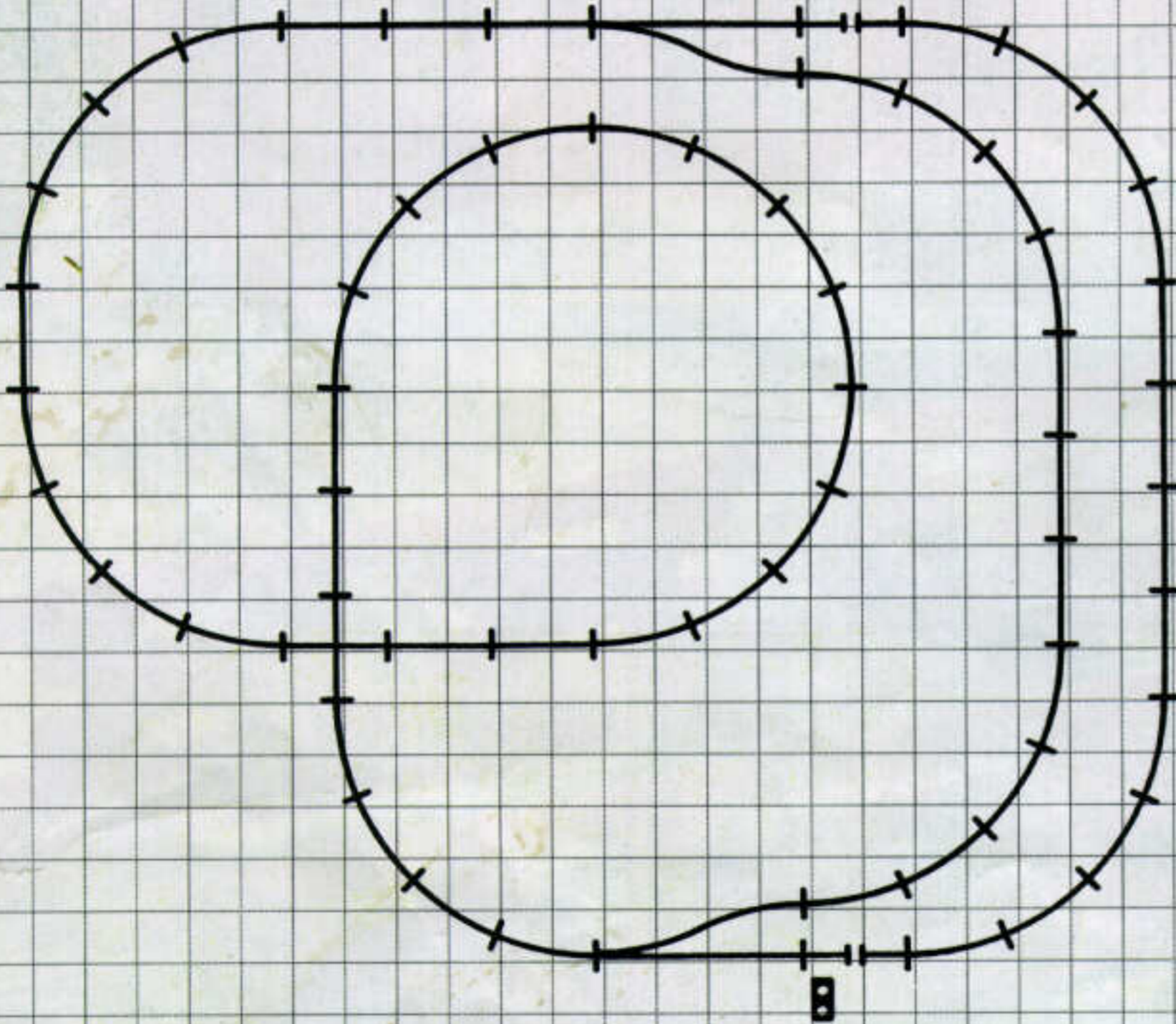
**A****B****B**

1:13

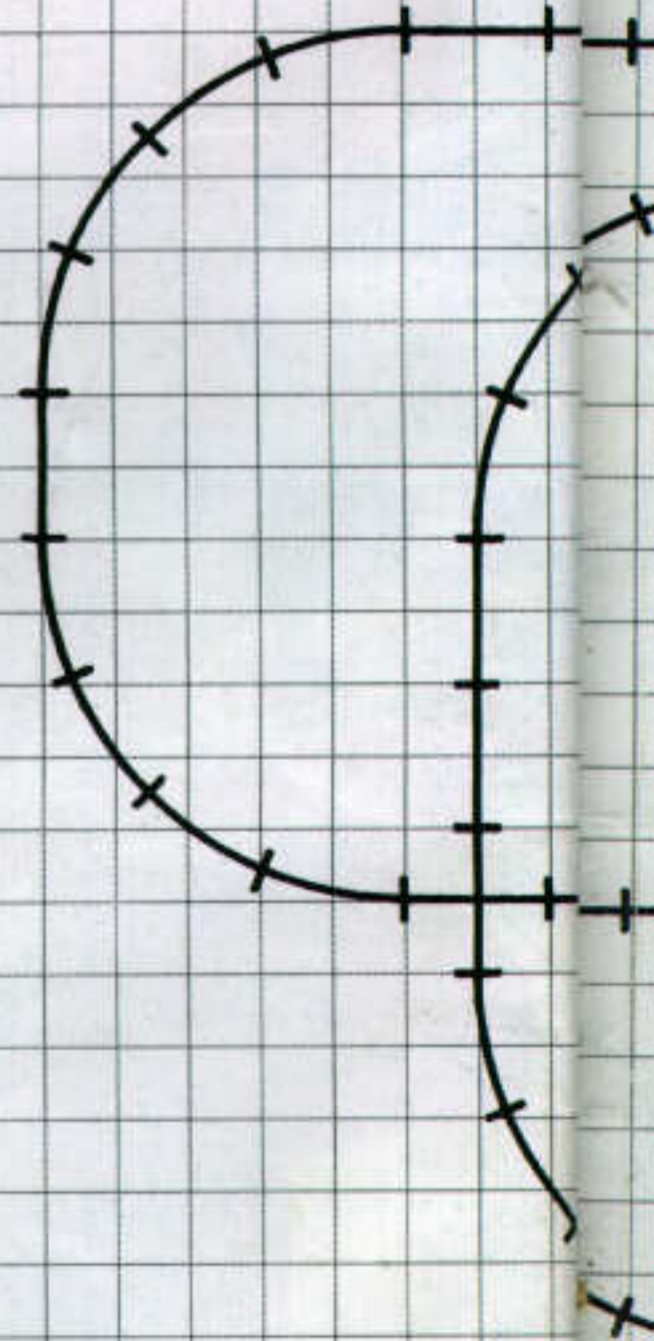
**C**

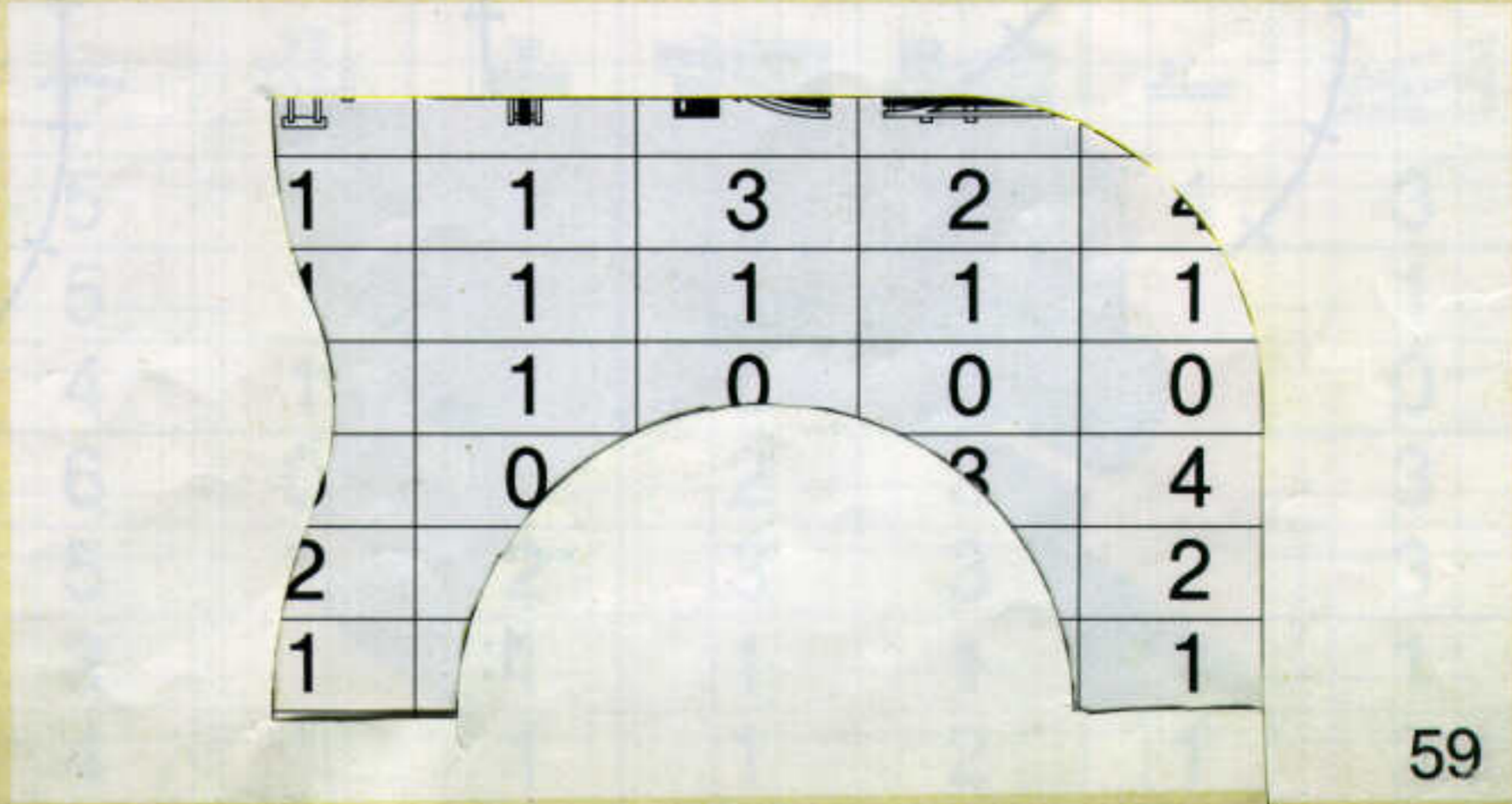
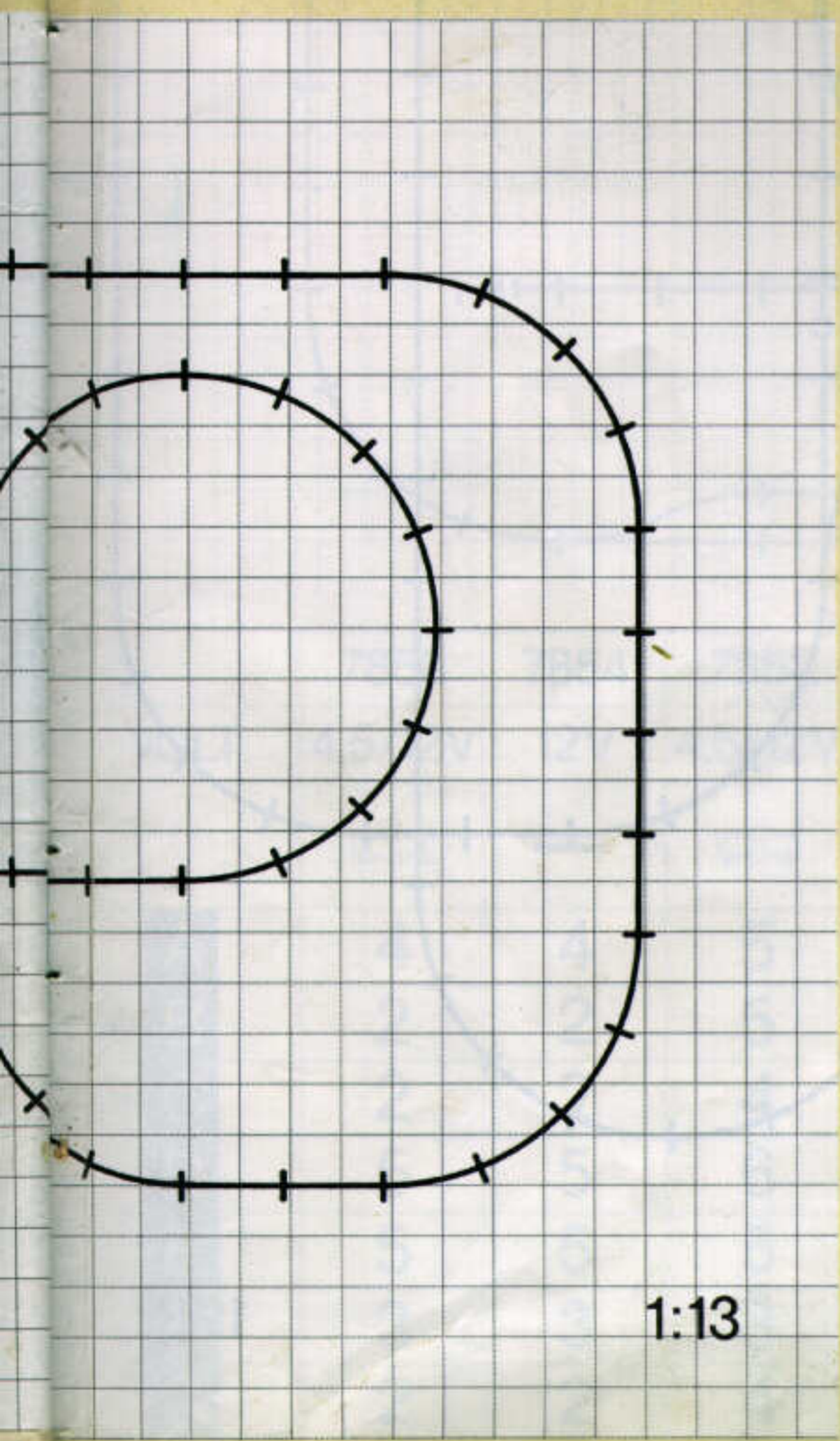
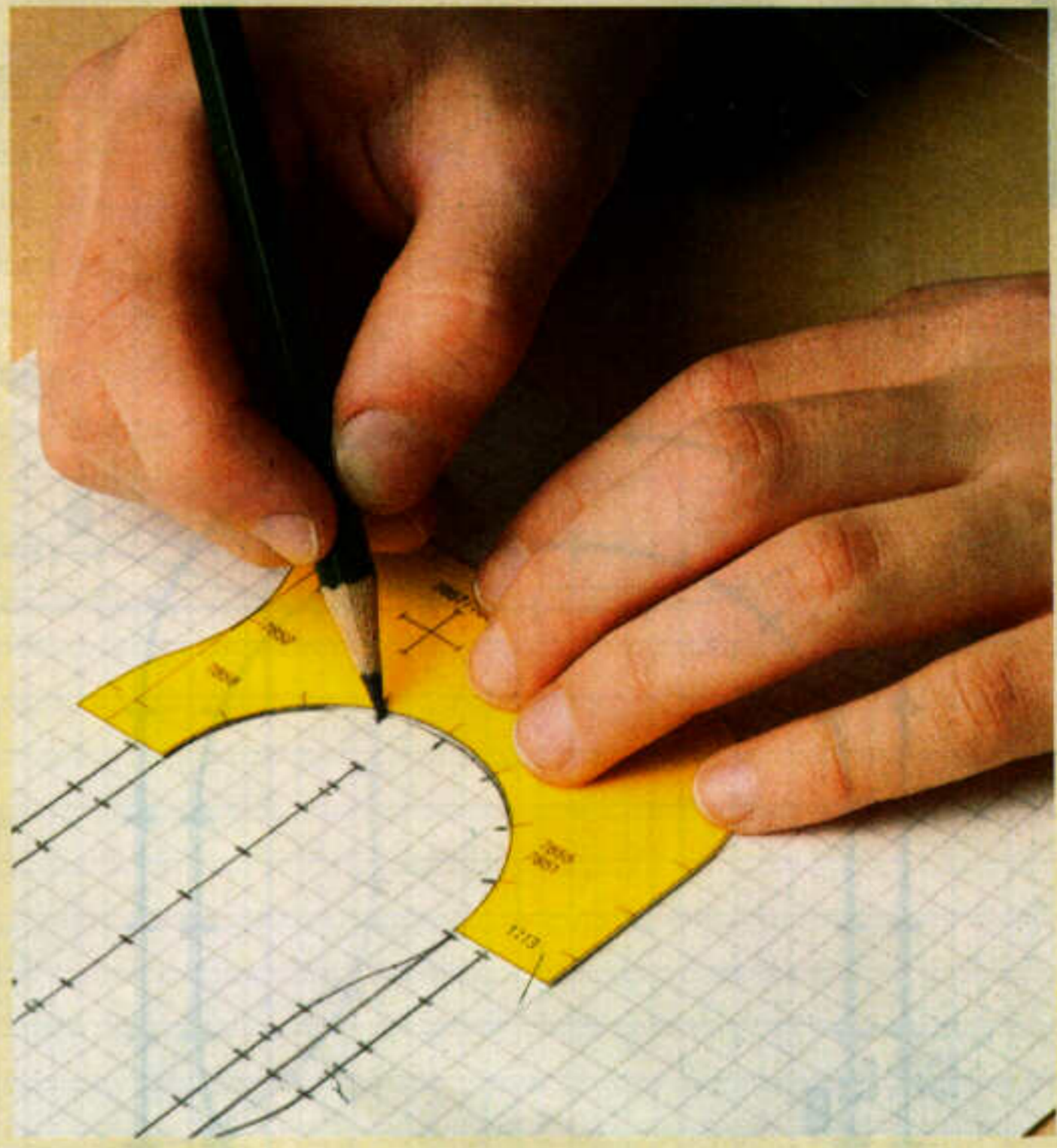
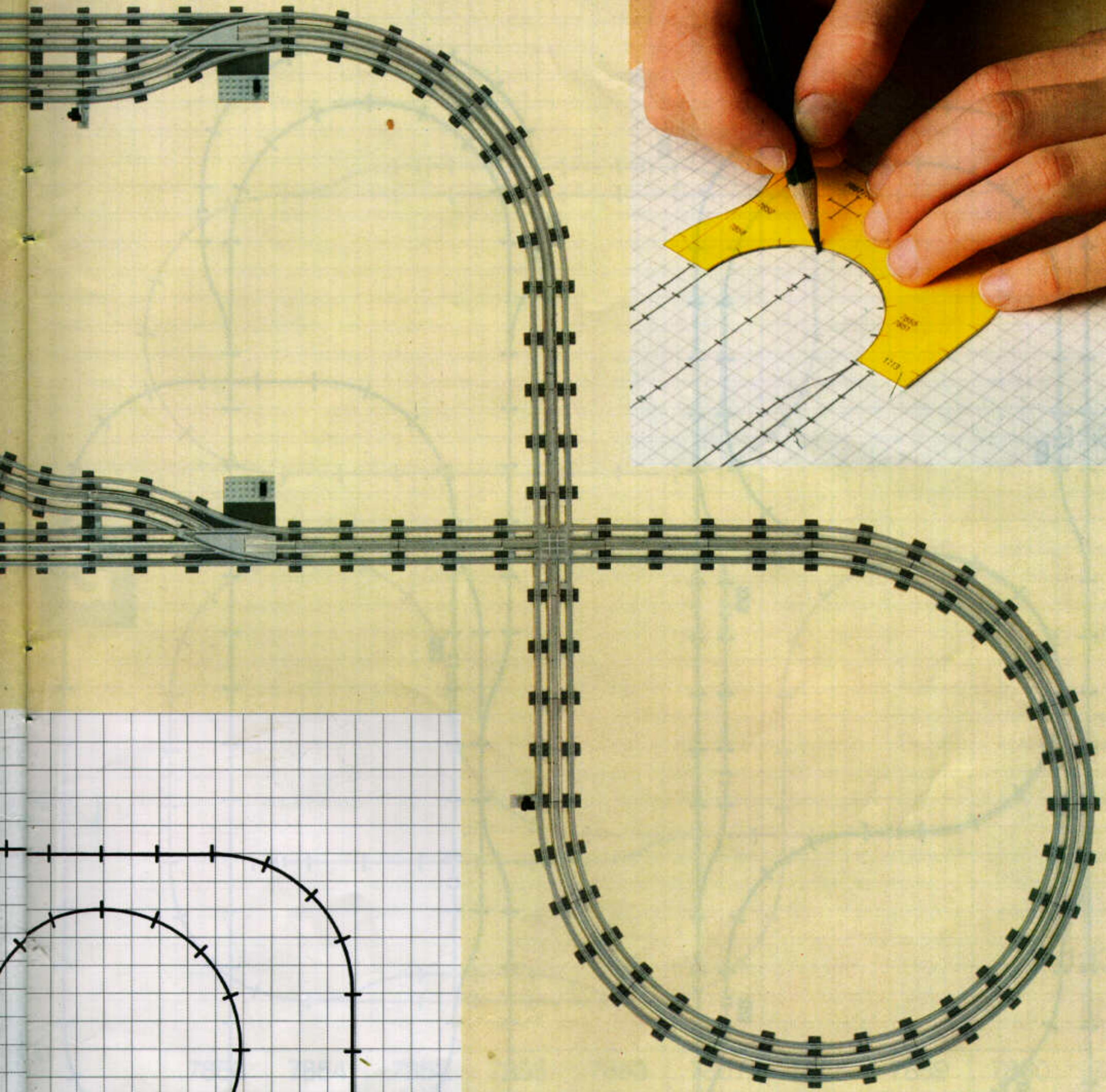

D

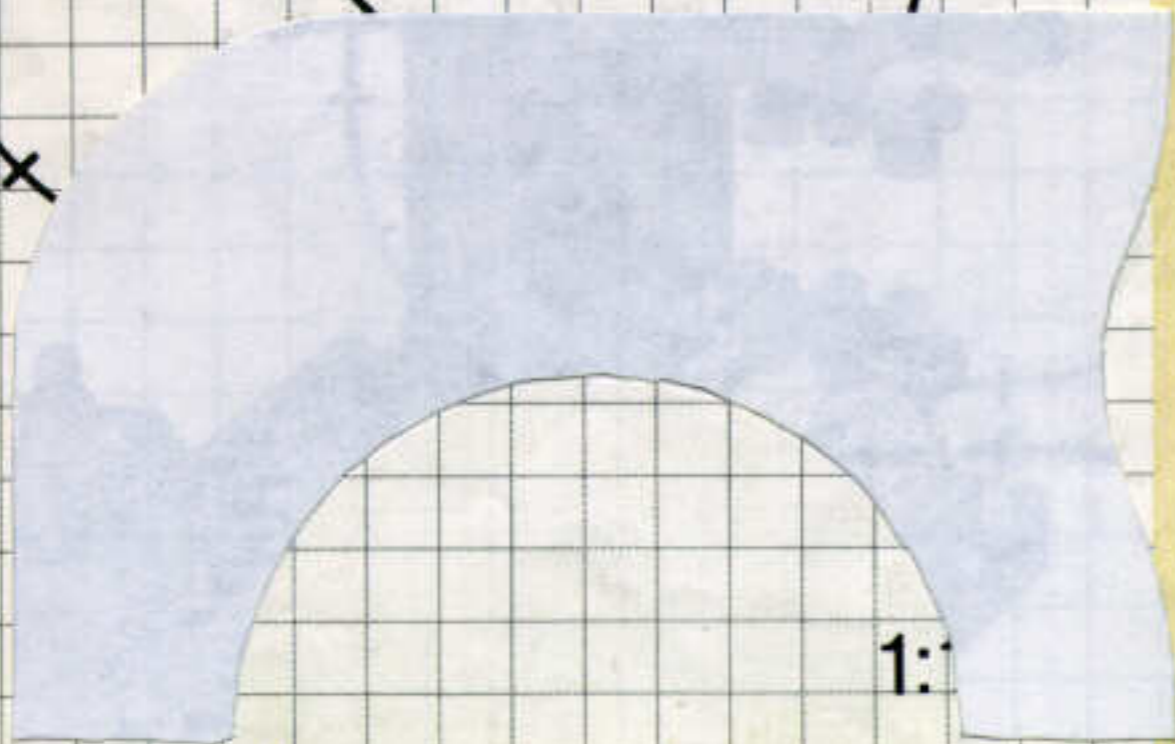
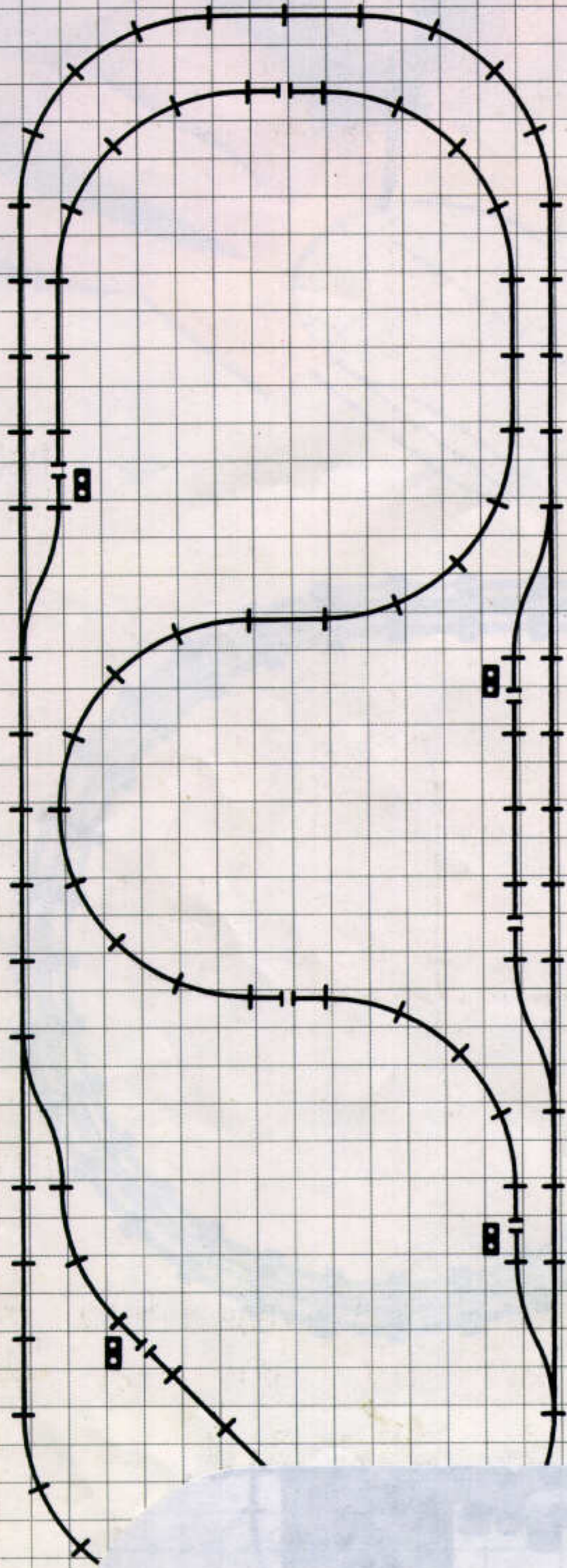

1:

E

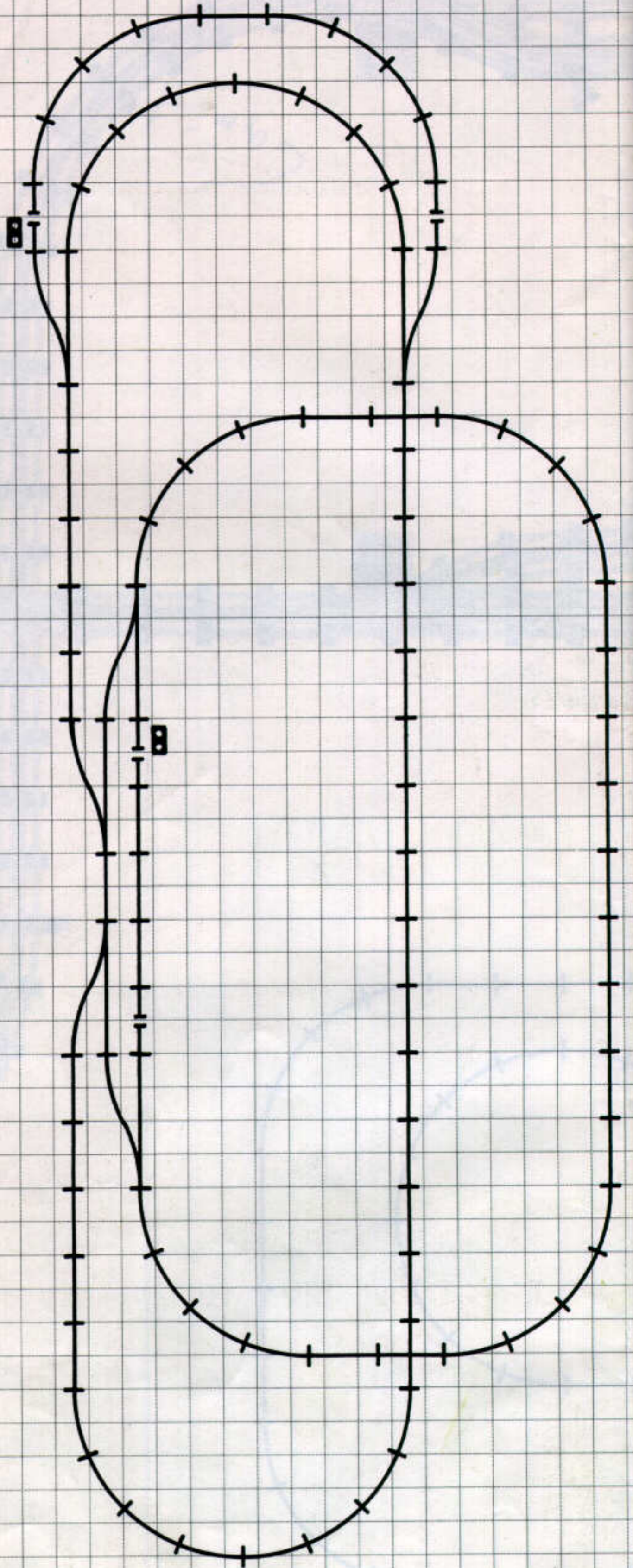

1:13

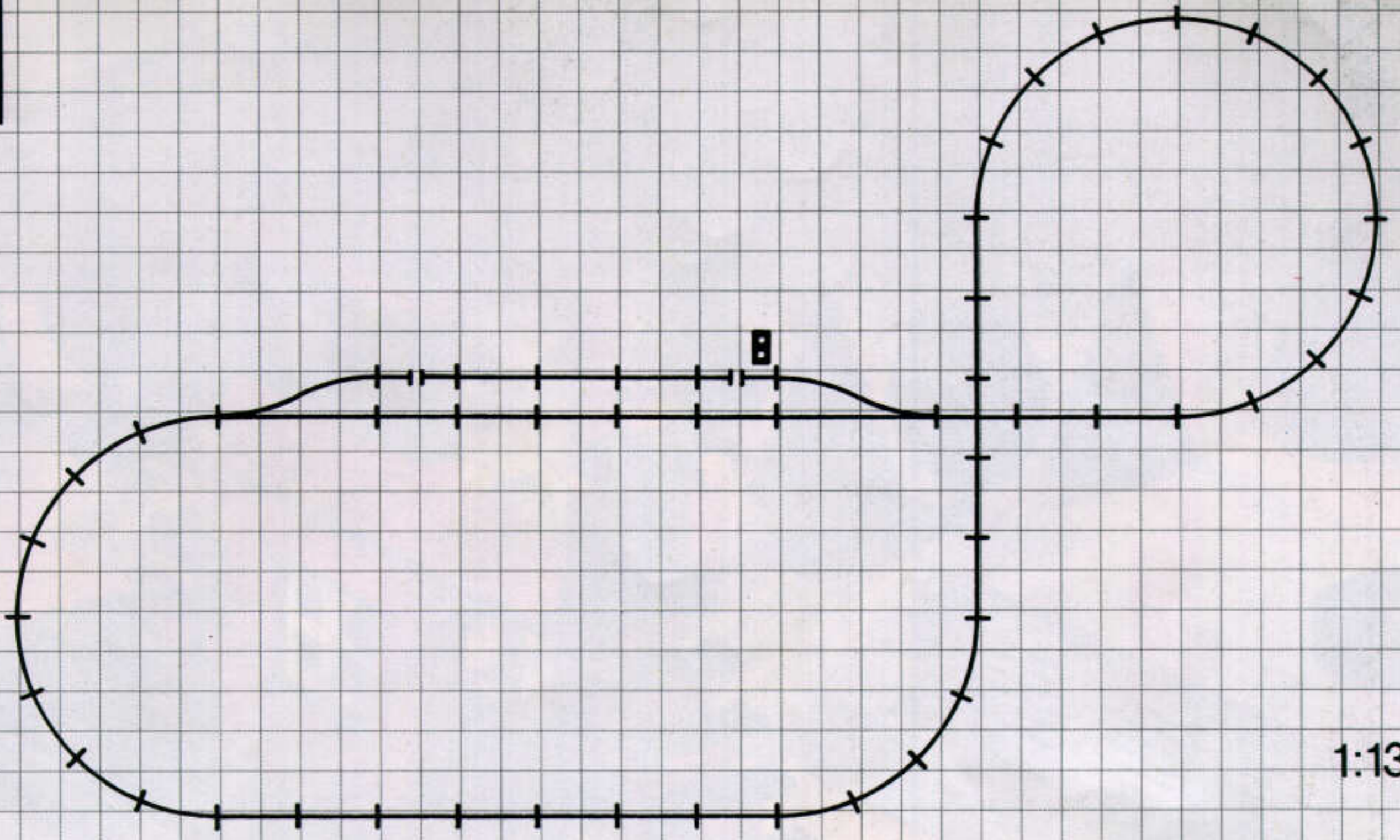
**F**

1:13

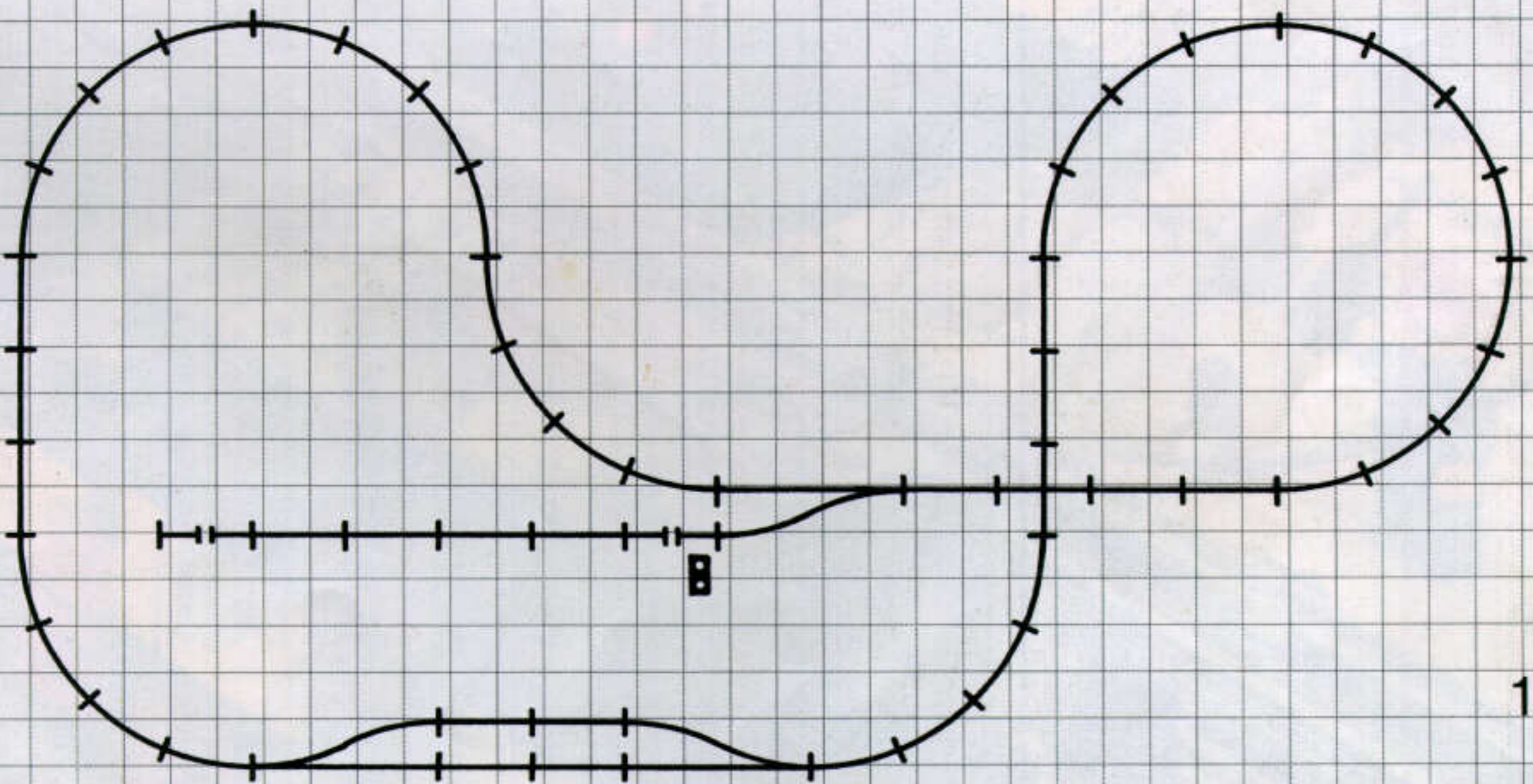
**G**

1:13

	7850	7854	7851	7855	7853	7857	7858	7859	7860	7852
VOLT	4,5/12V	12V	4,5/12V	12V	4,5V	12V	12V	12V	12V	4,5V
<b>A</b>	4	4	5	5	1	1	3	2	4	3
<b>B</b>	2	2	5	5	1	1	1	1	1	1
<b>C</b>	2	2	4	4	1	1	0	0	0	0
<b>D</b>	5	5	6	6	0	0	2	3	4	3
<b>E</b>	5	5	5	5	2	2	3	3	2	3
<b>F</b>	3	3	3	3	1	1	1	1	1	1
<b>G</b>	2	2	4	4	1	1	1	2	1	2



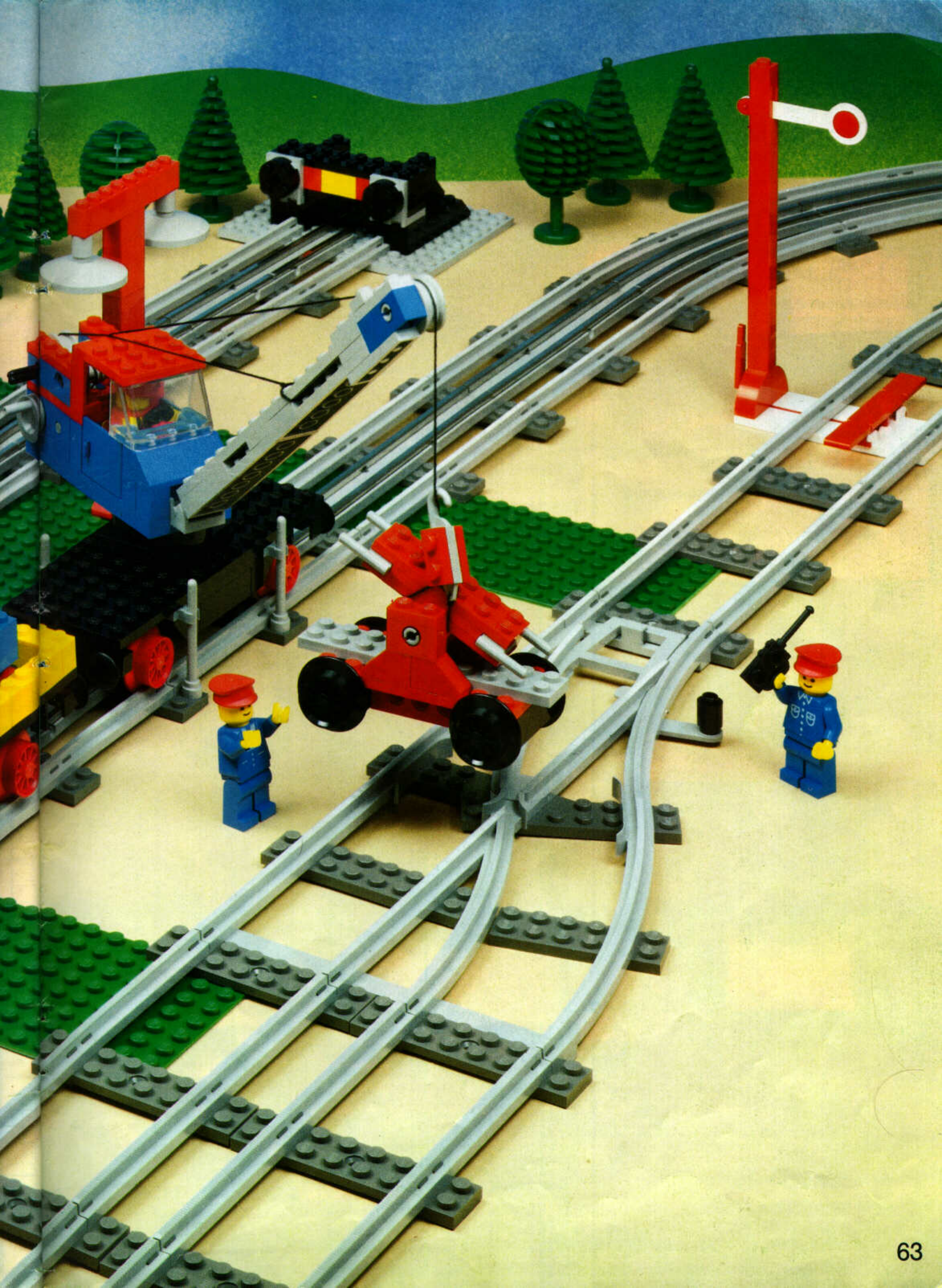

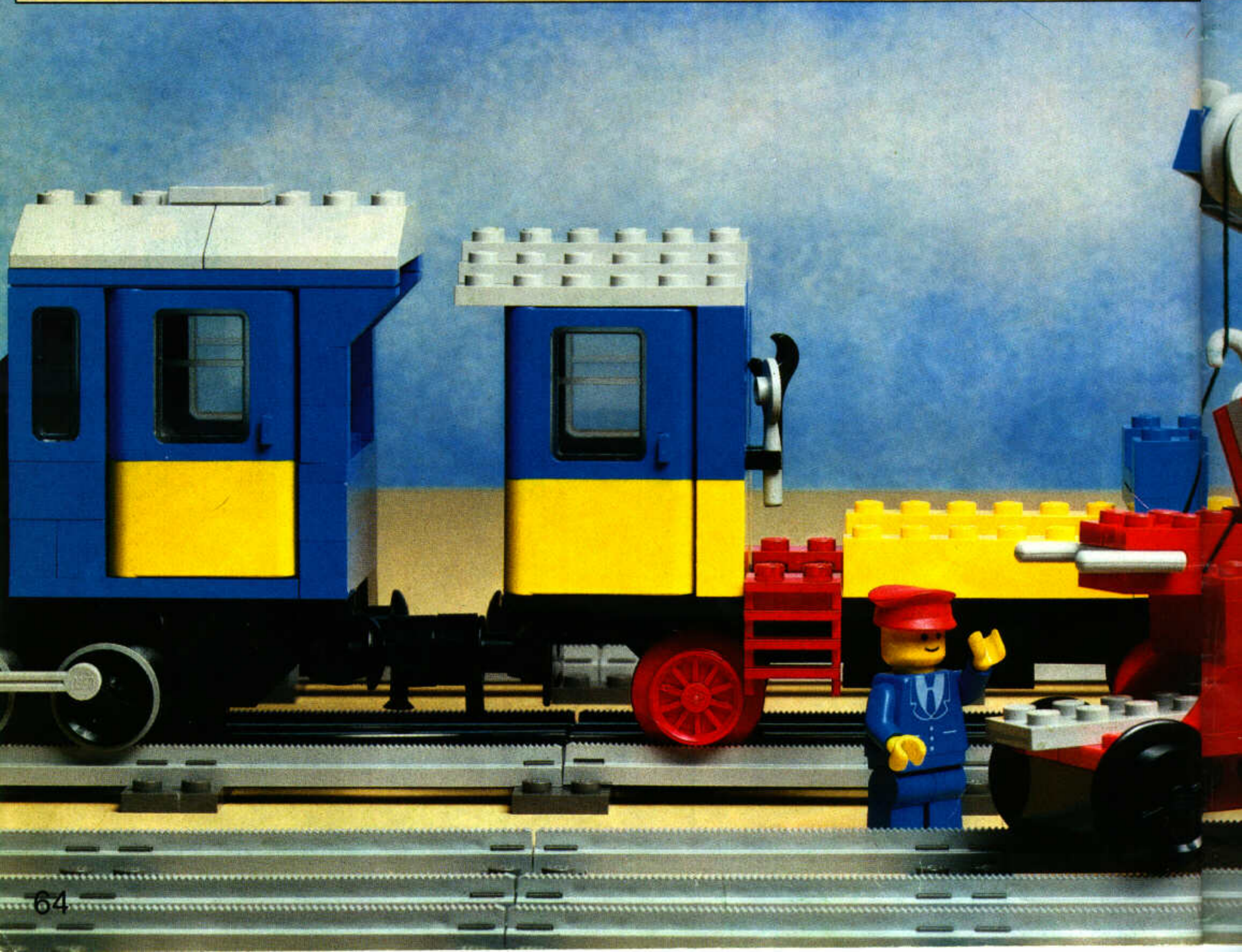
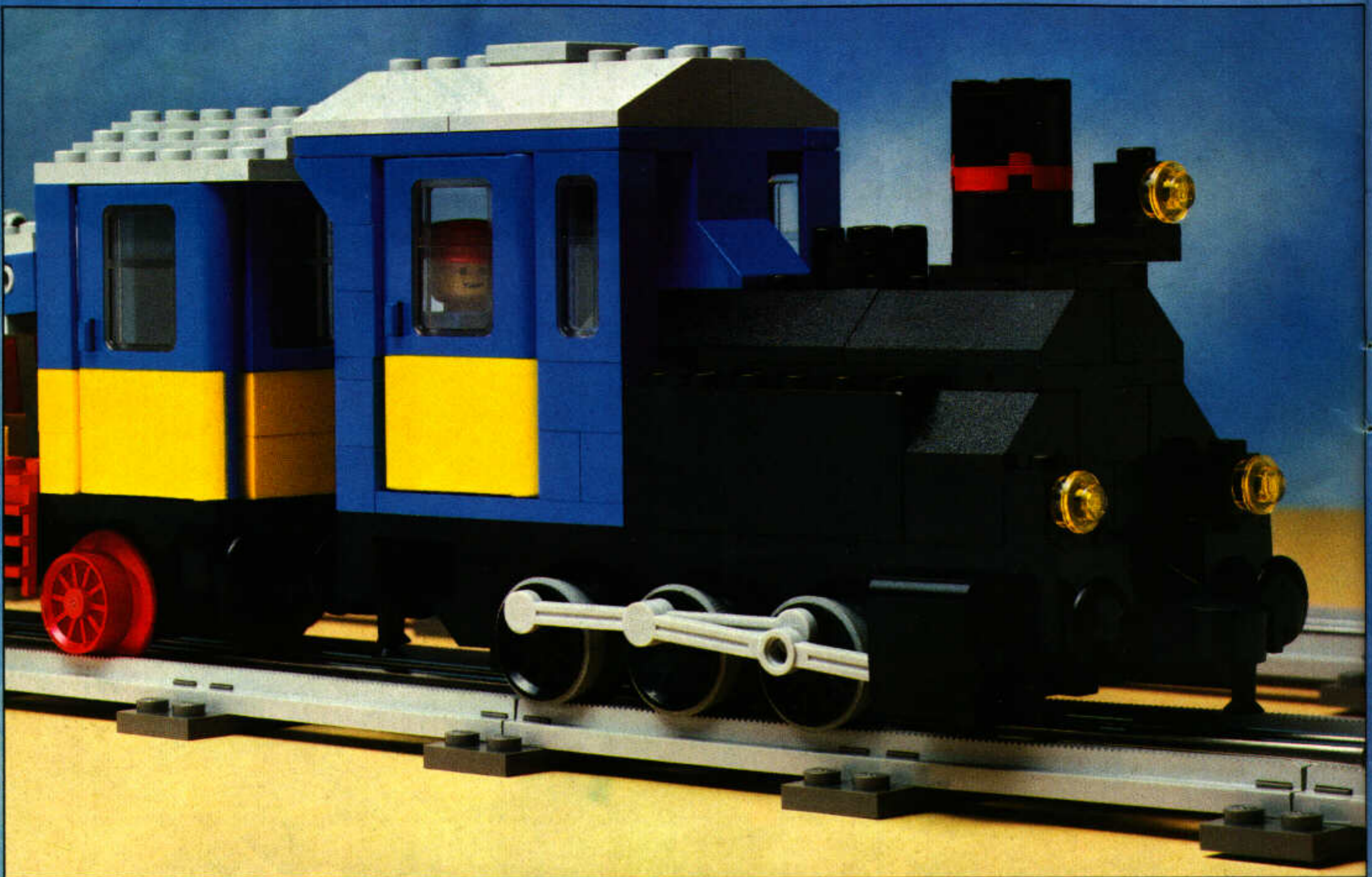



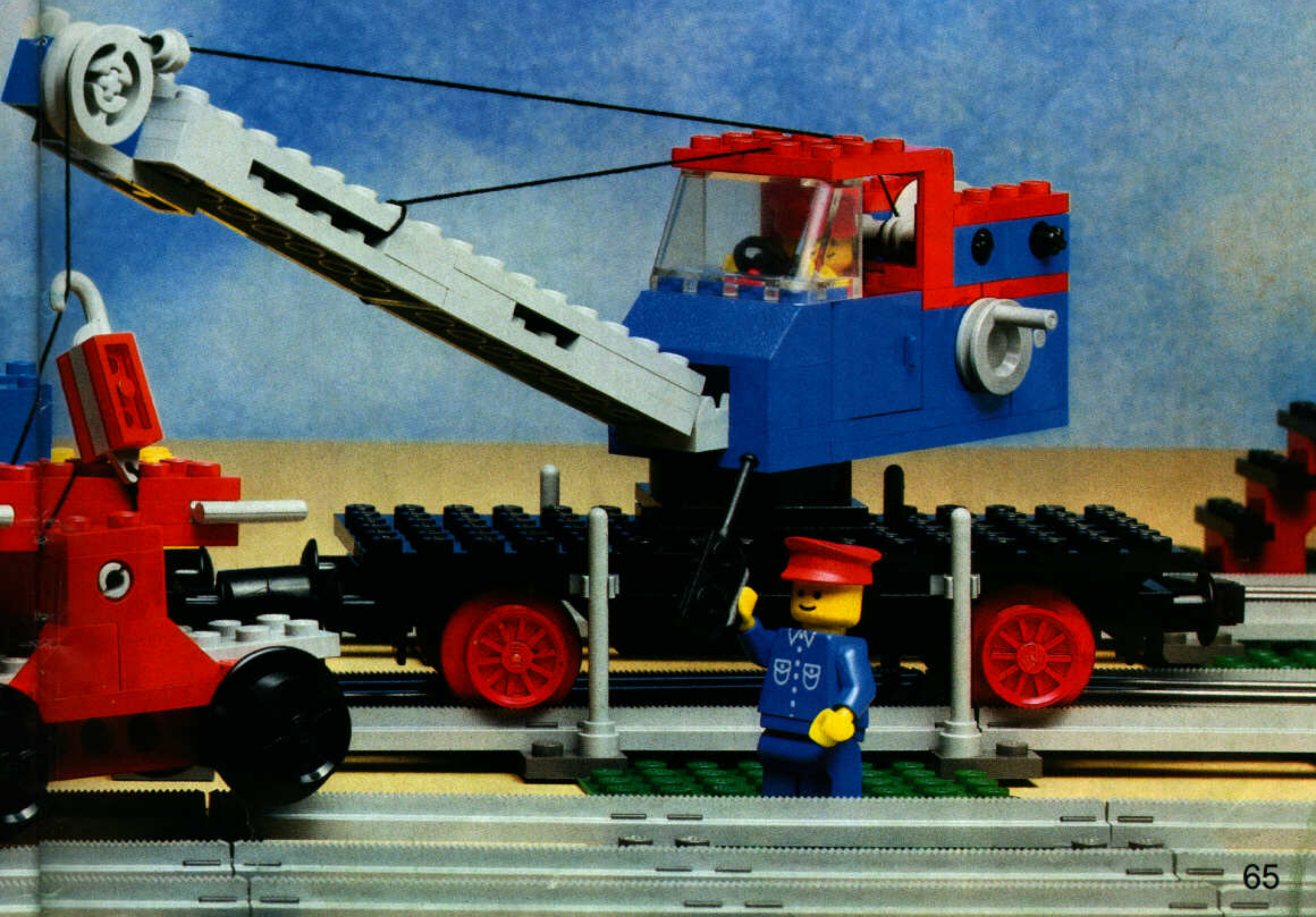
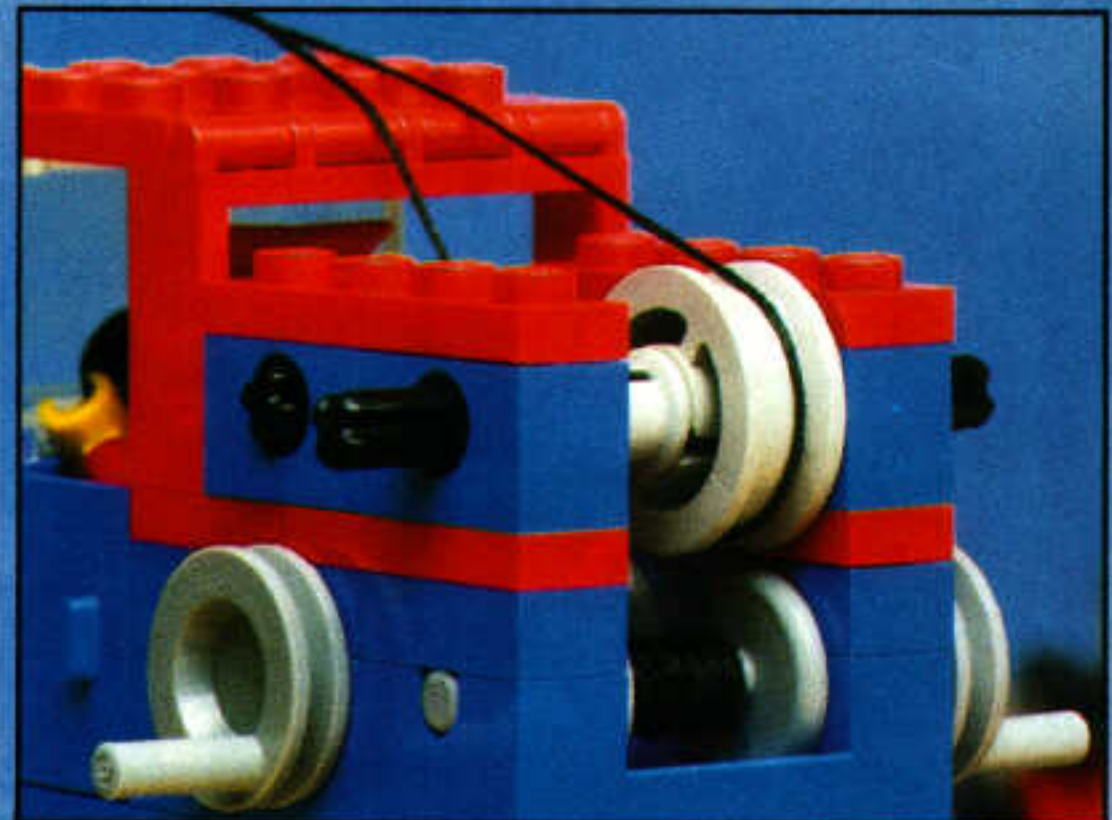
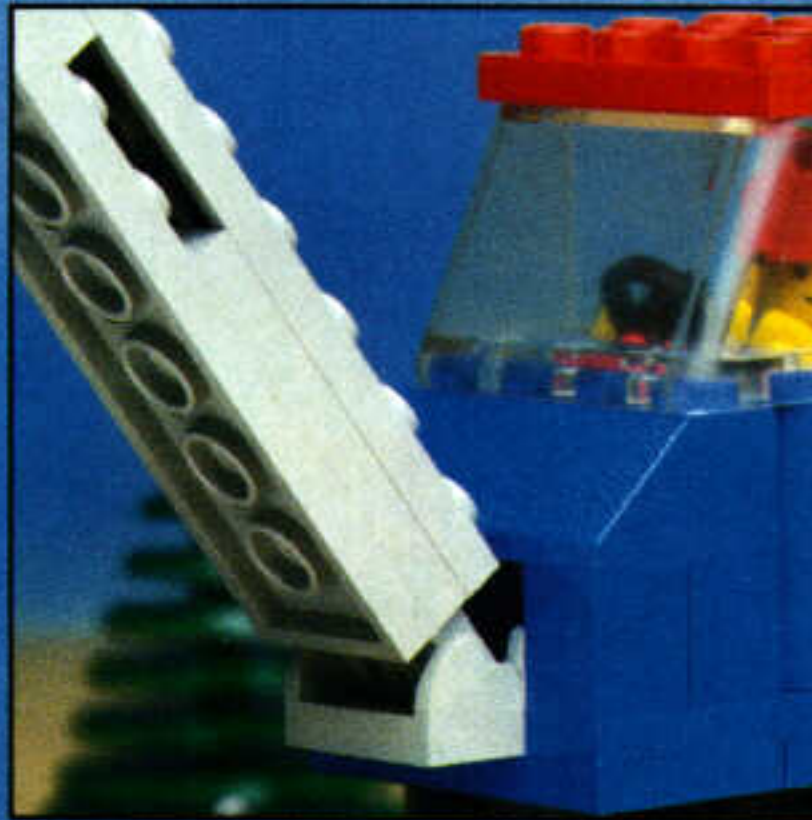
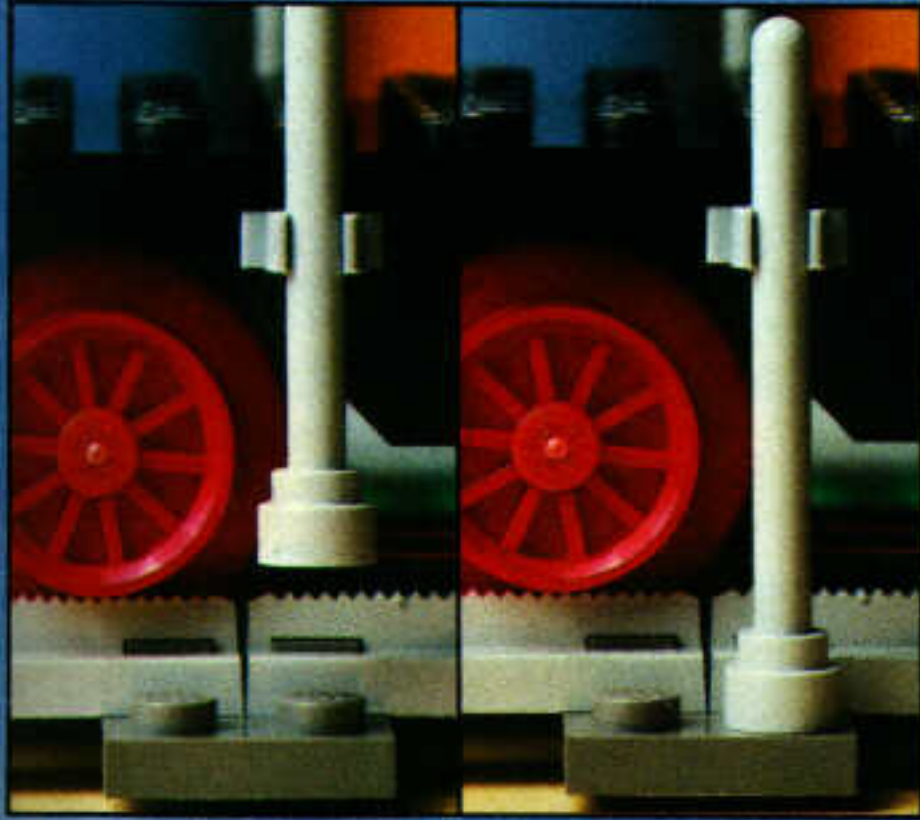
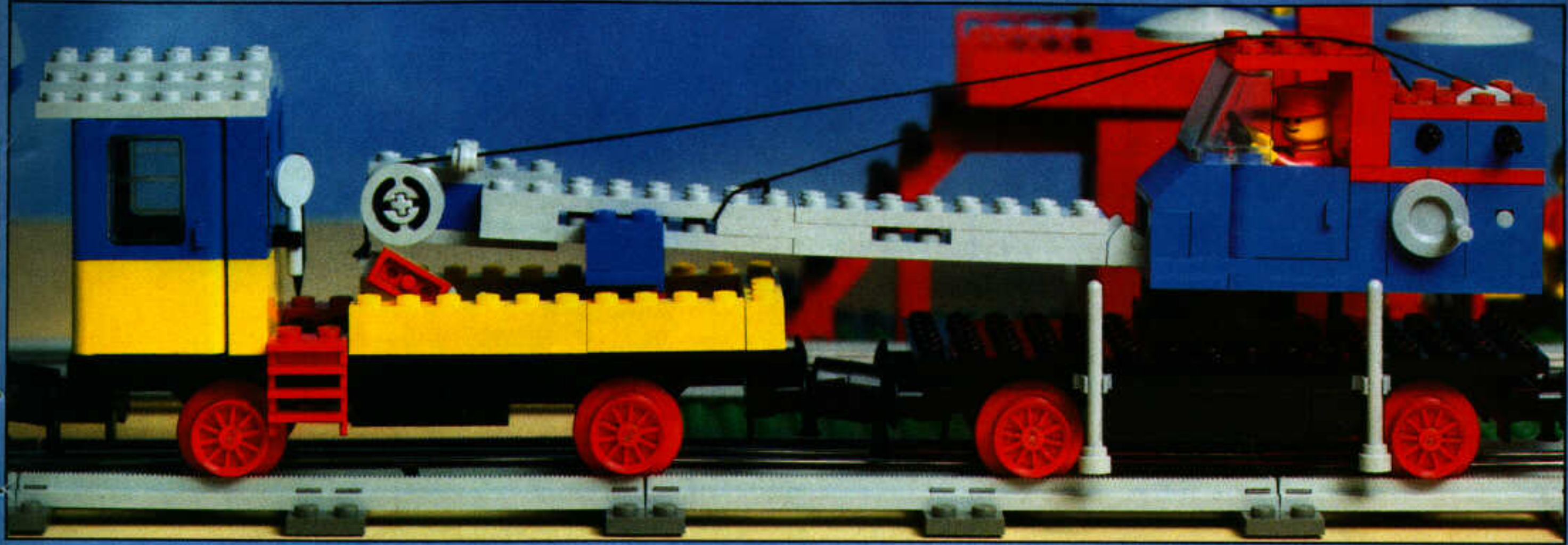



X



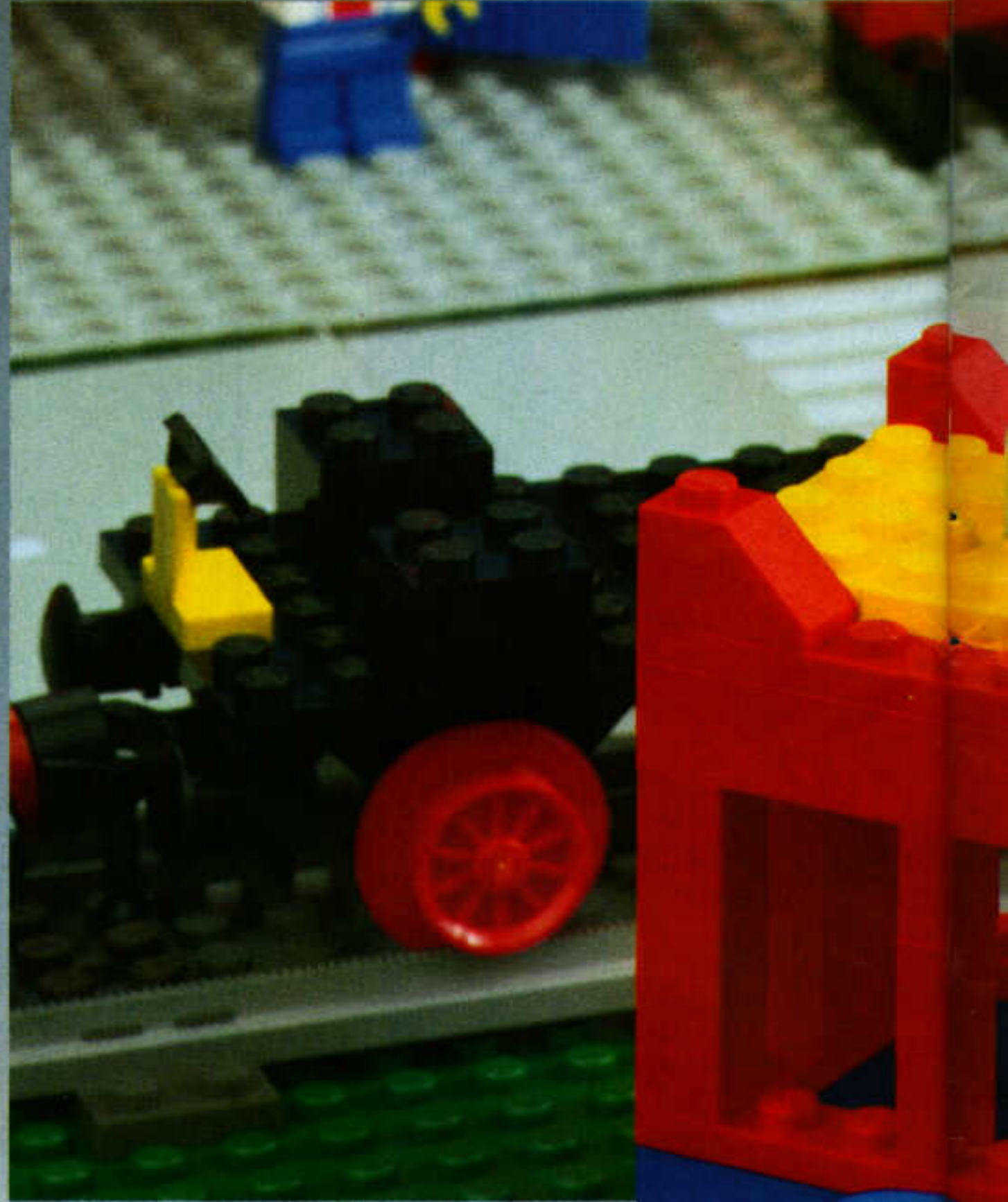
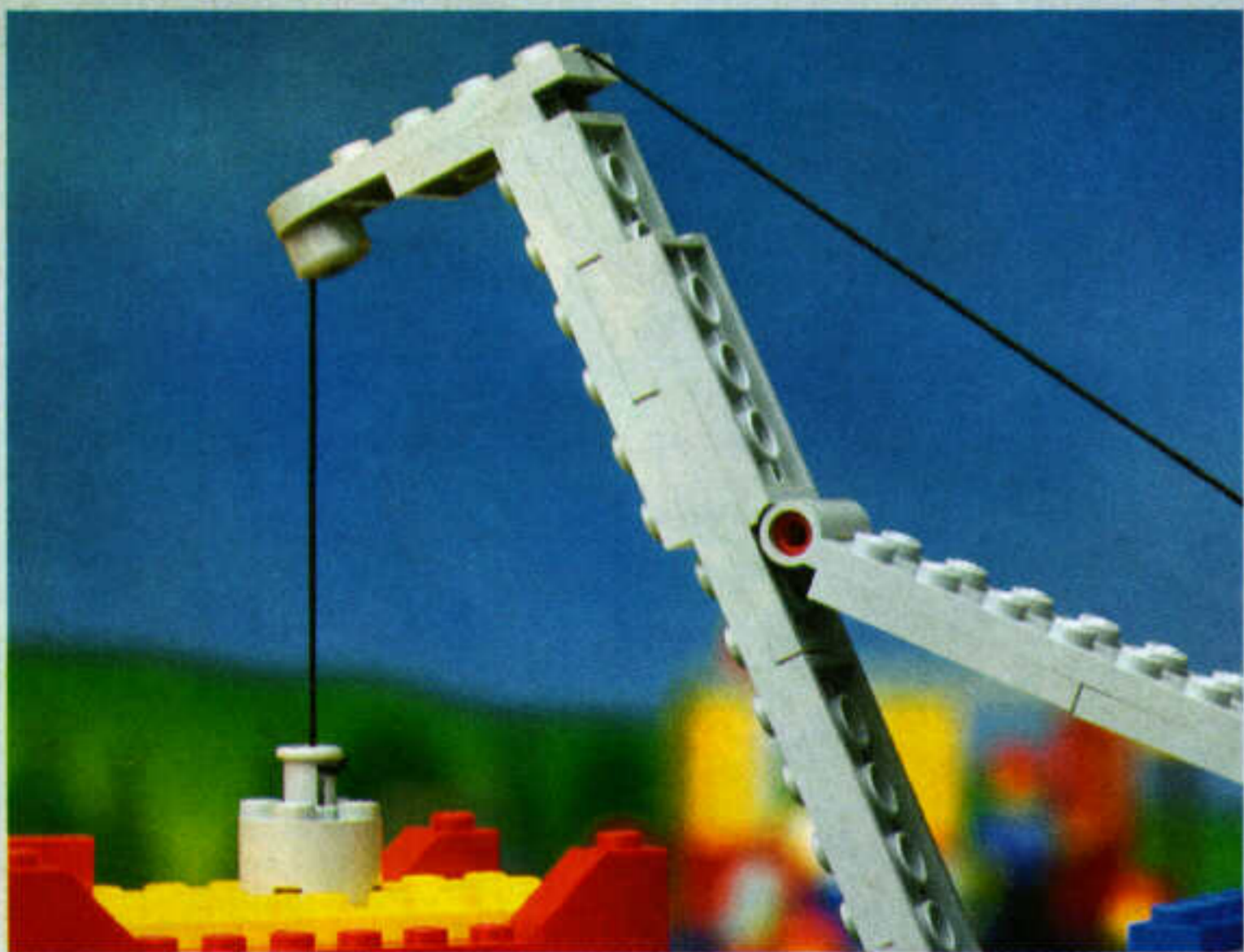
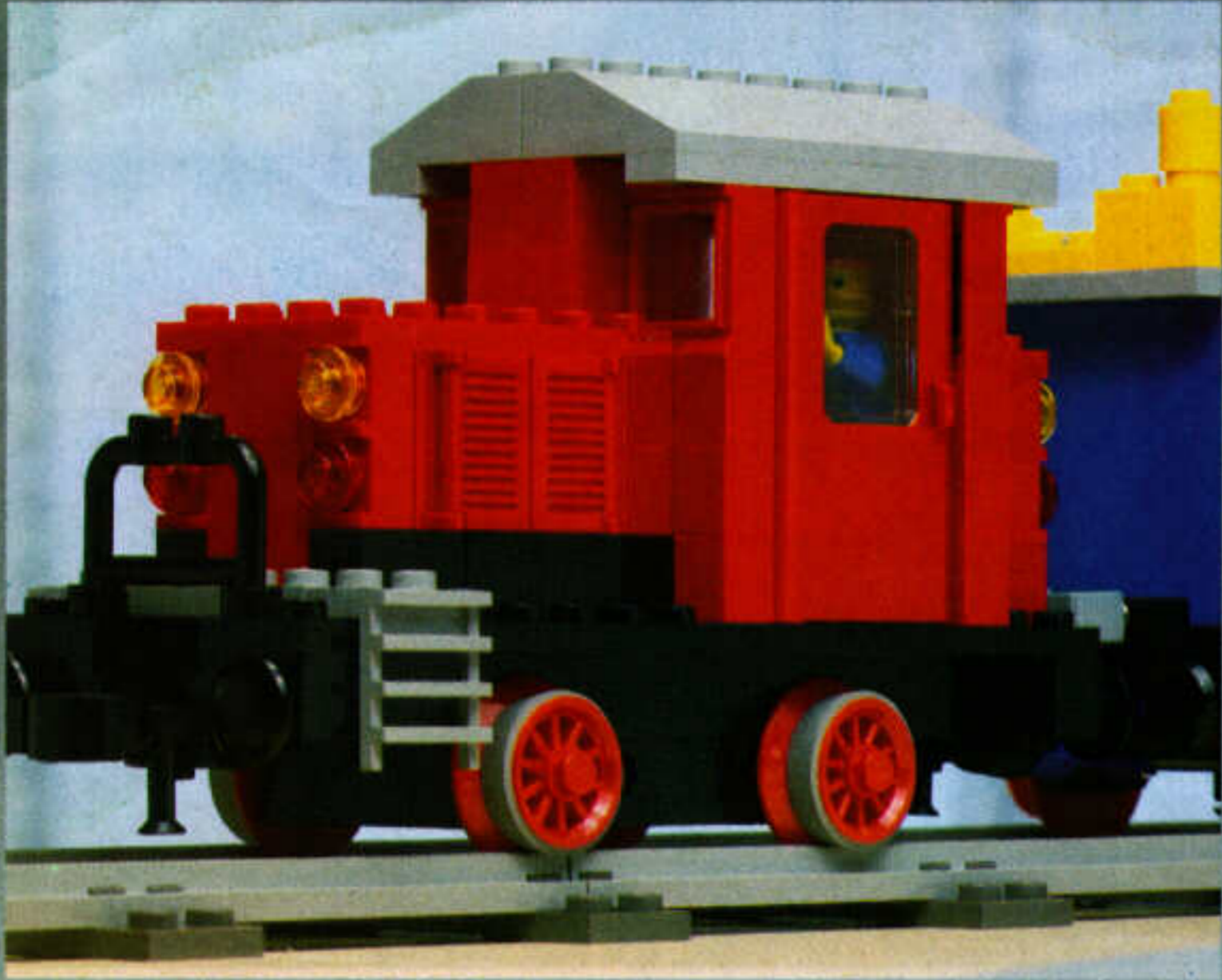

1

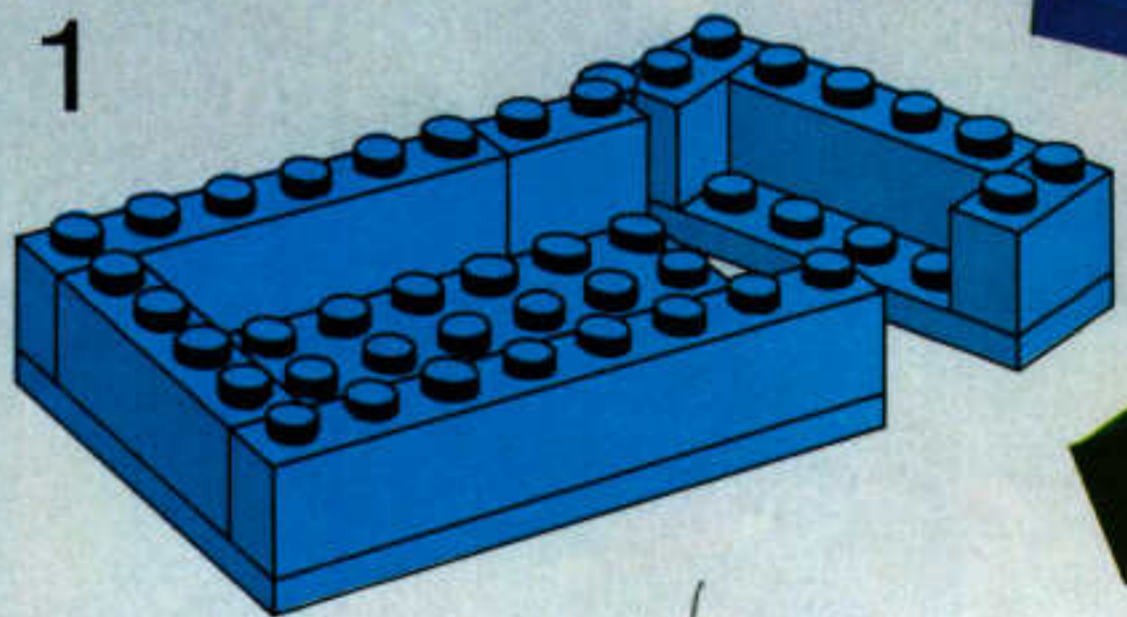

2

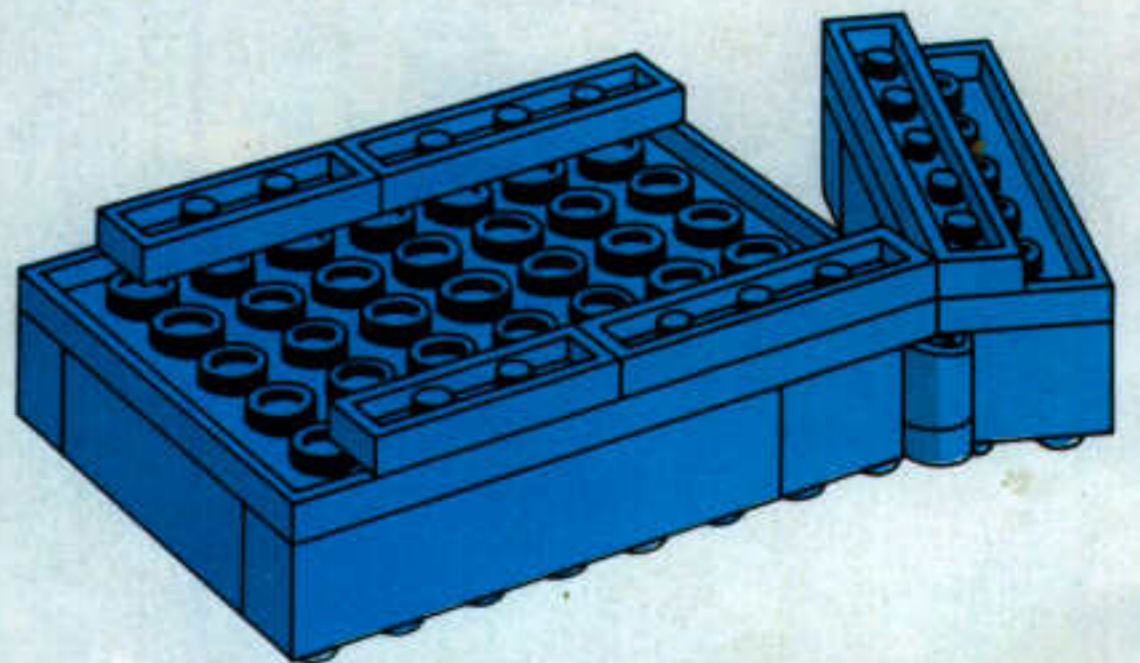

3

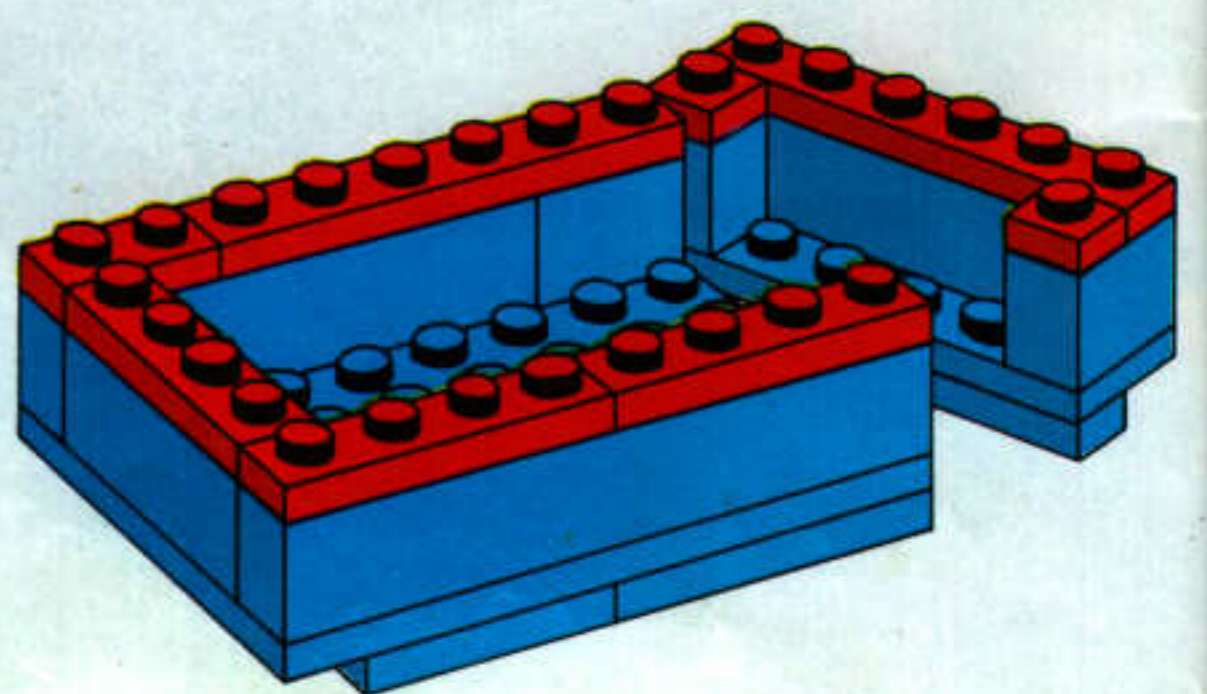



4

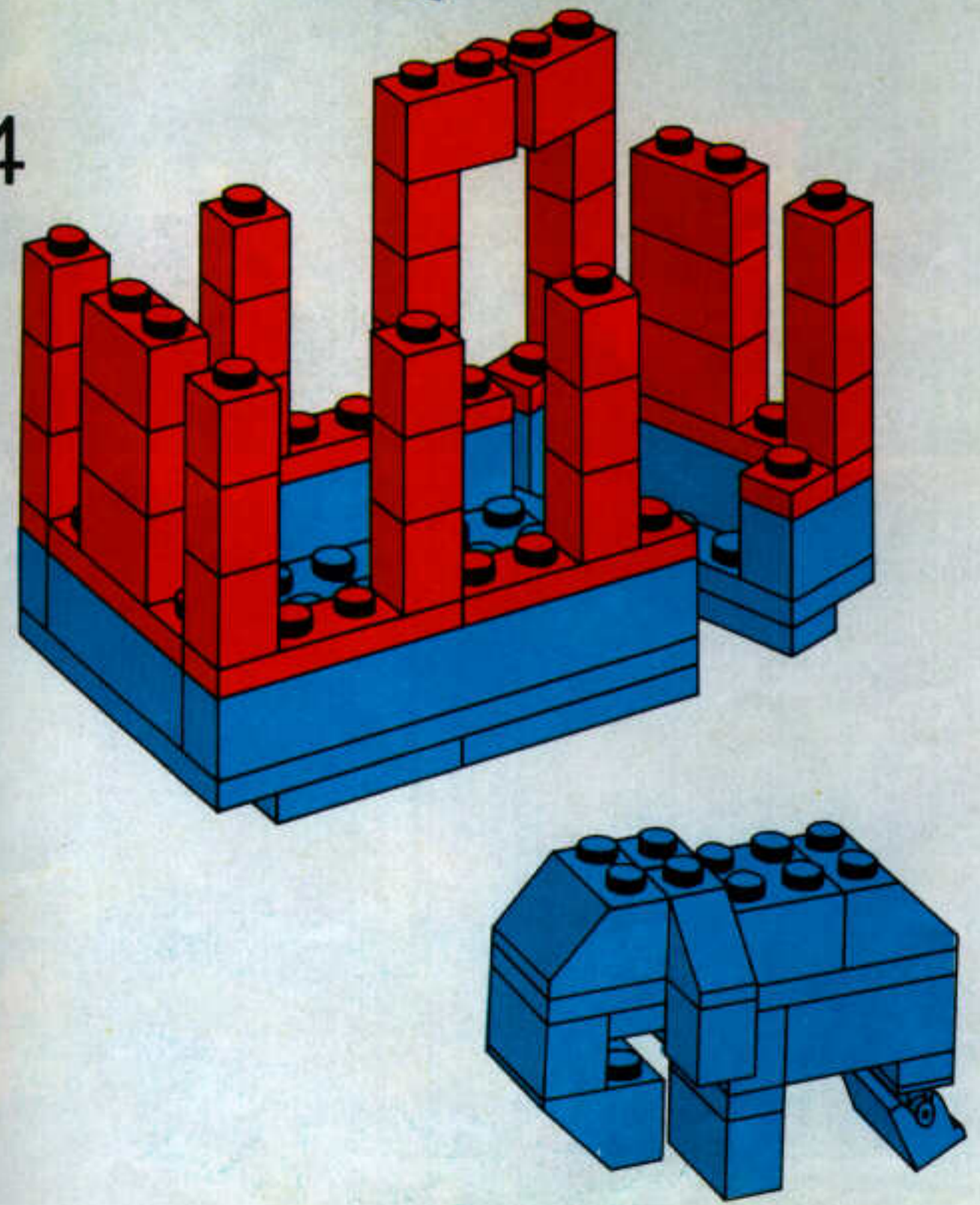

5

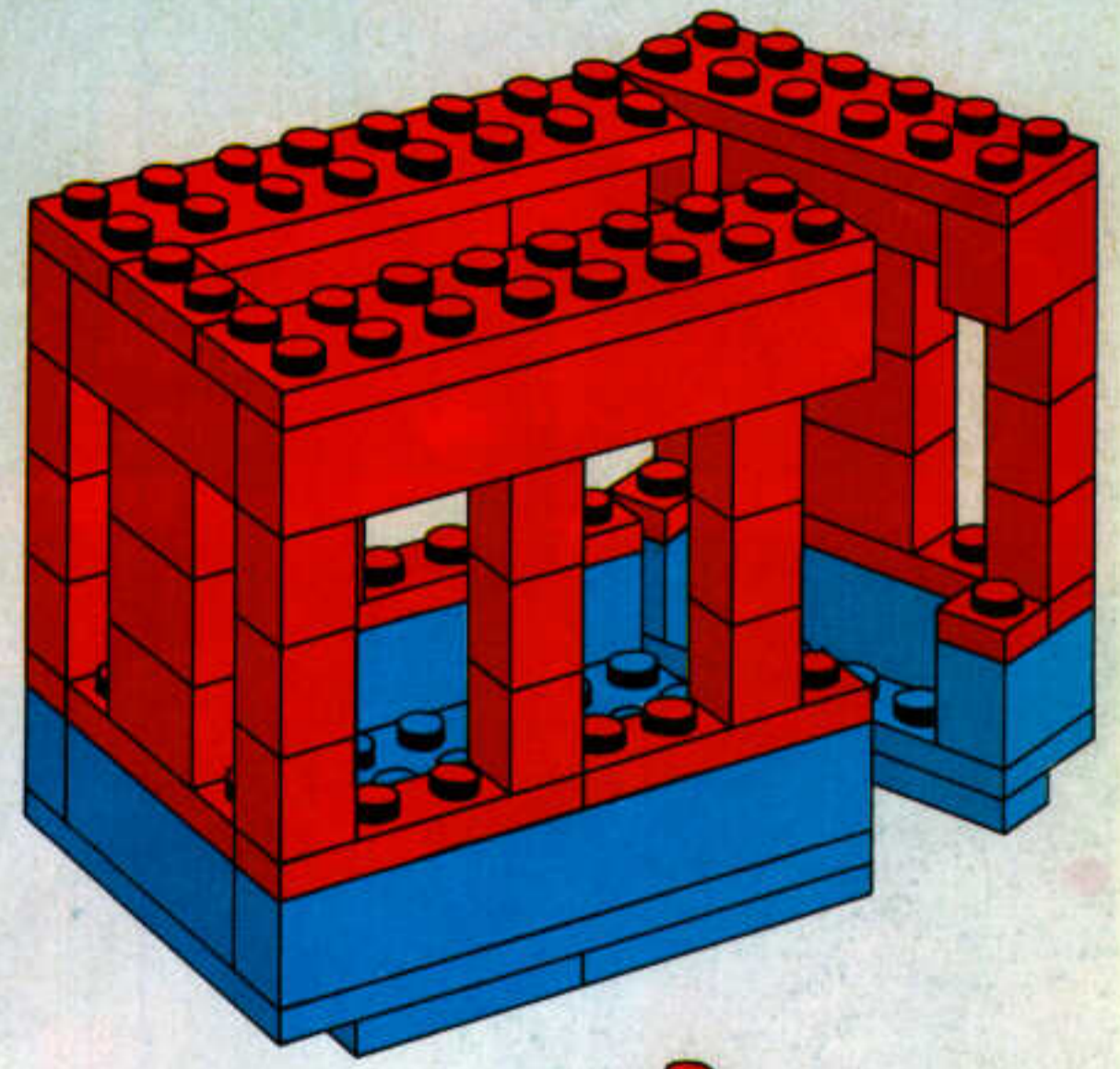

6

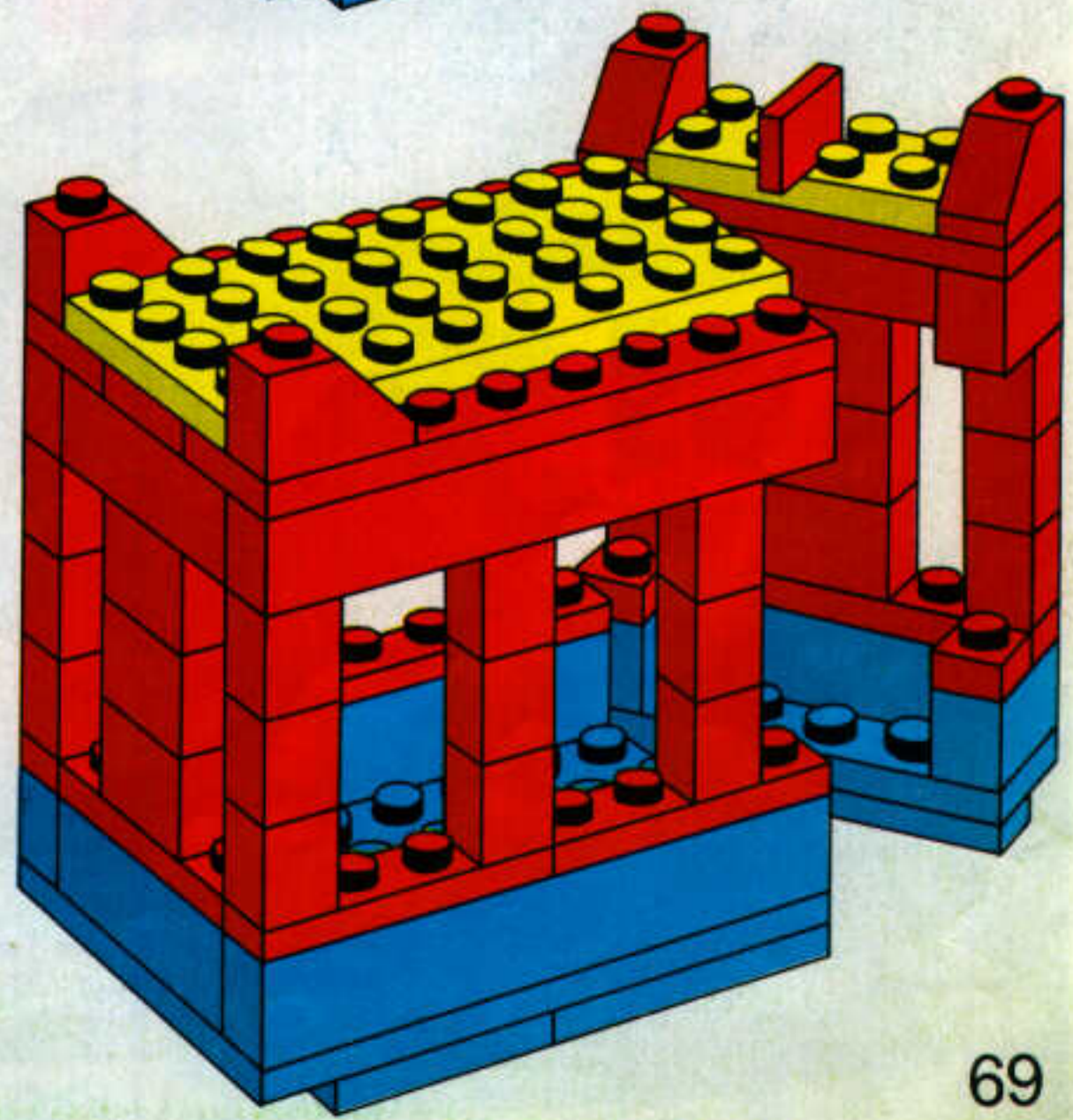

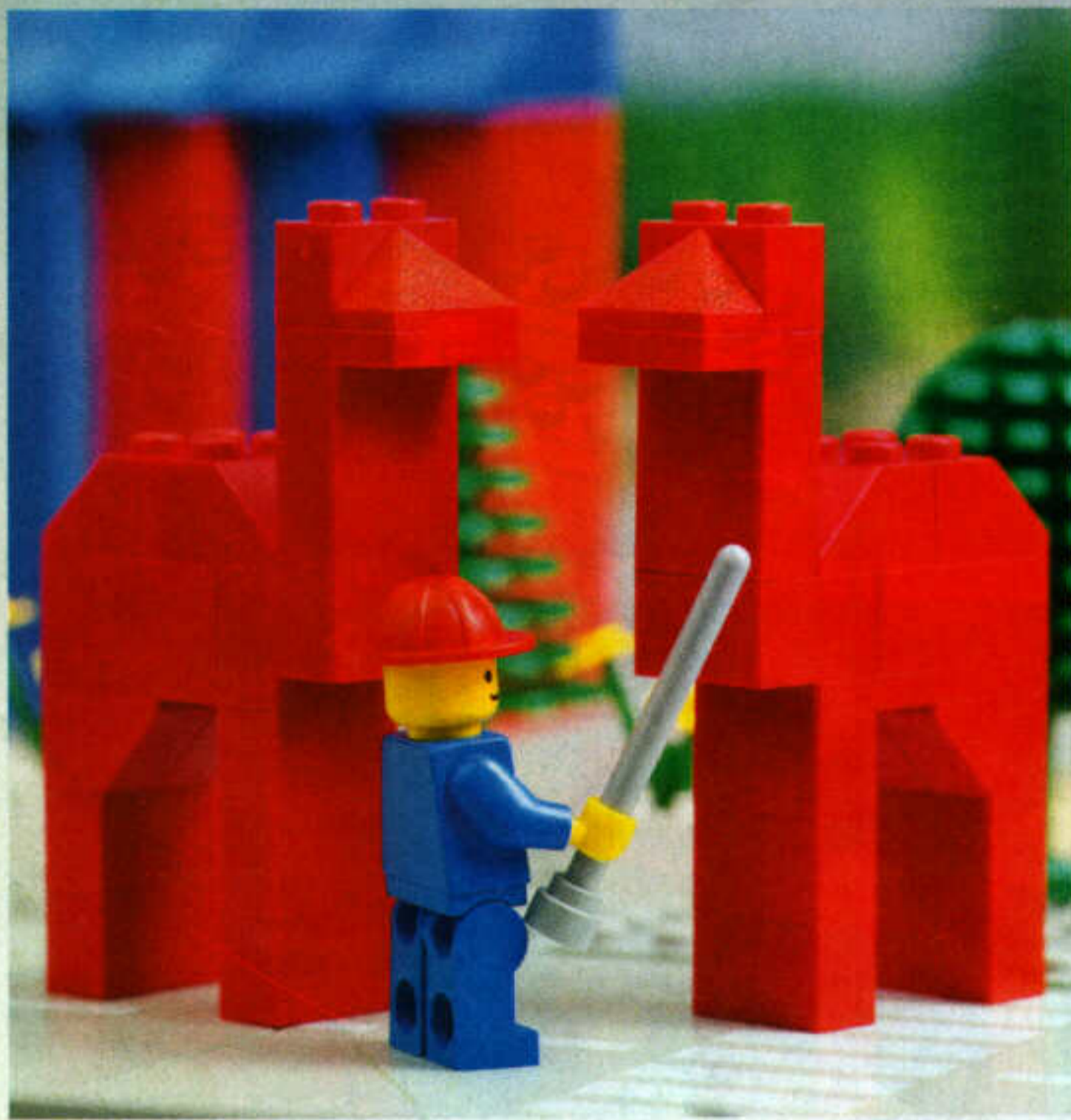
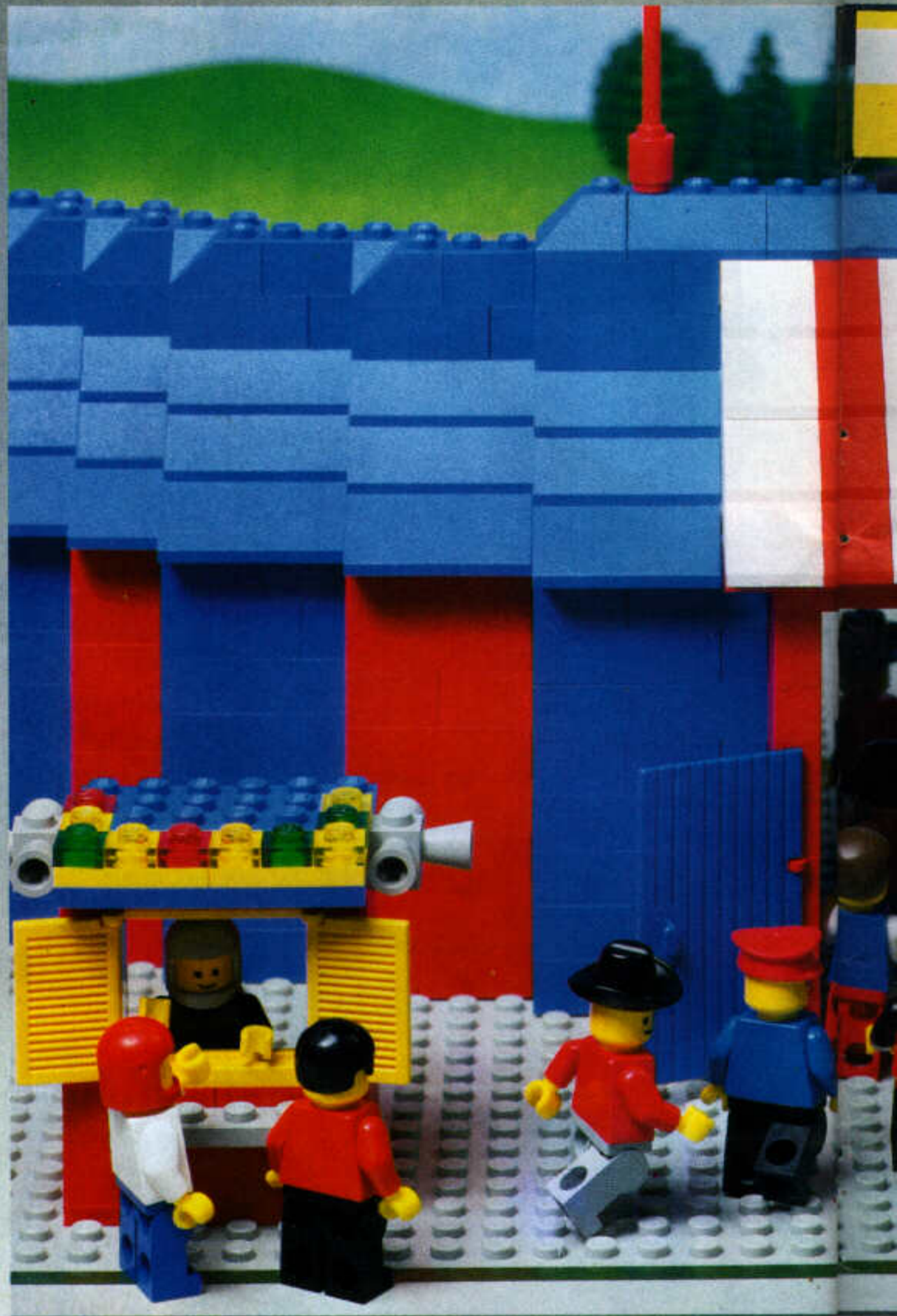
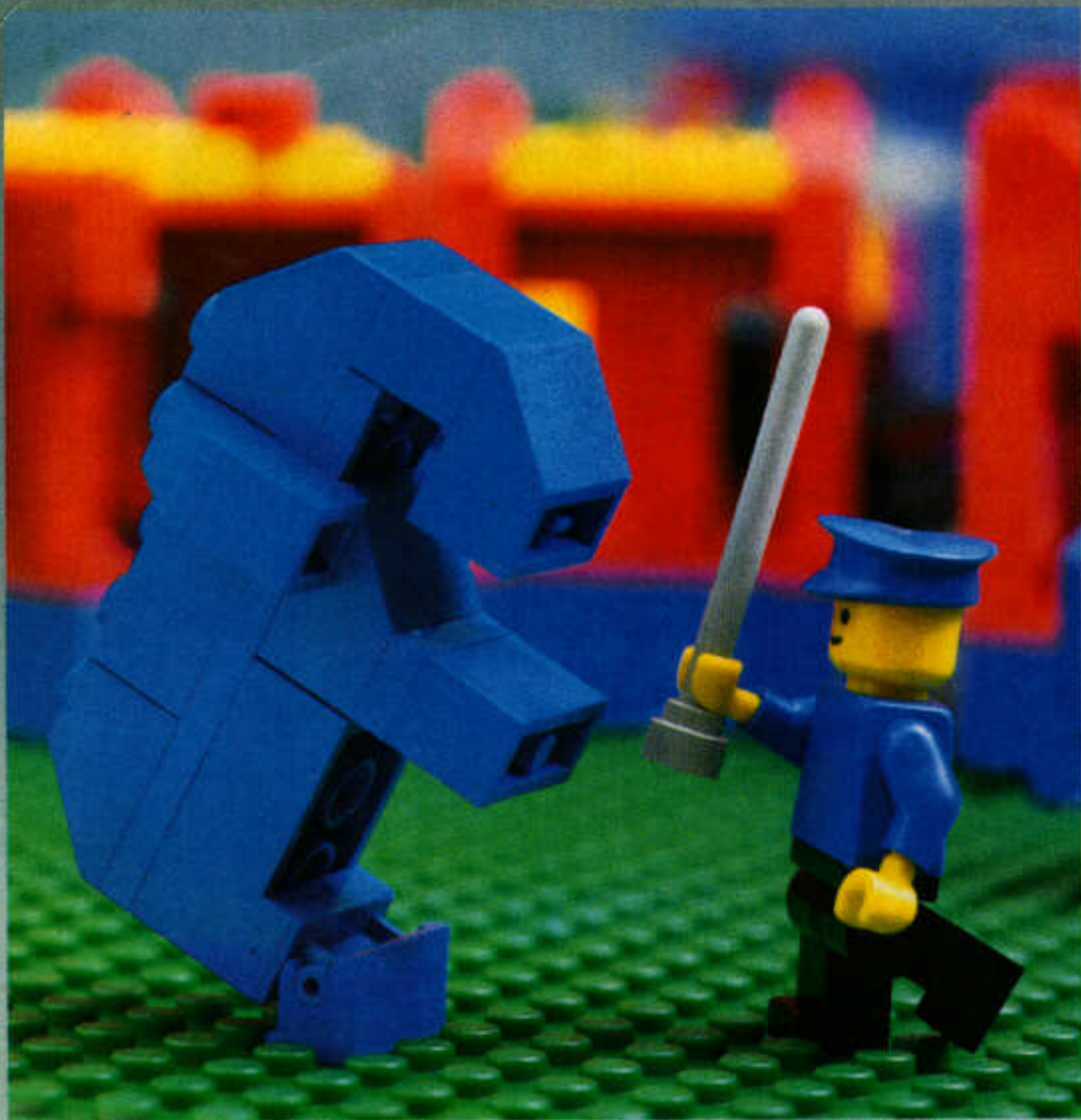



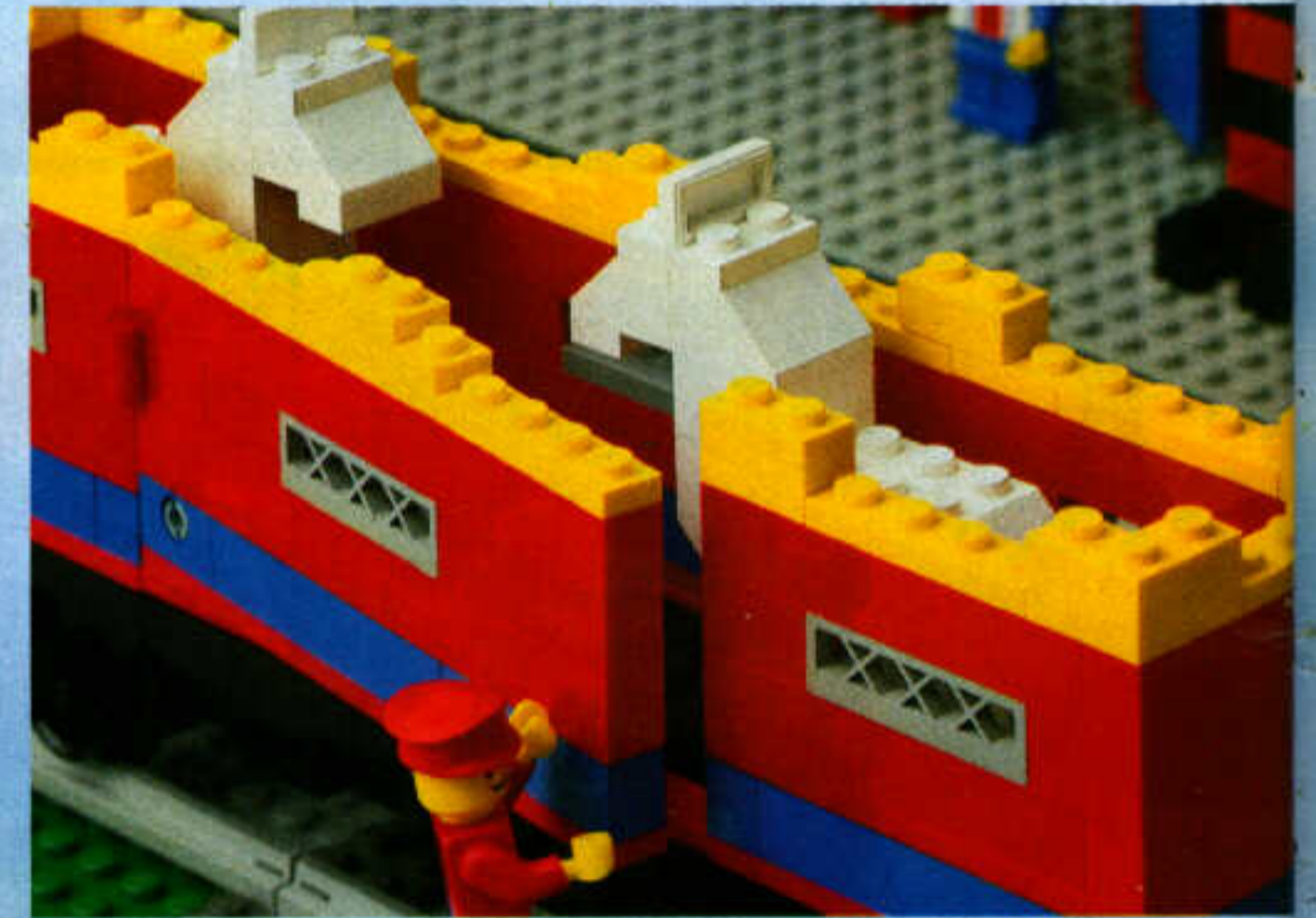
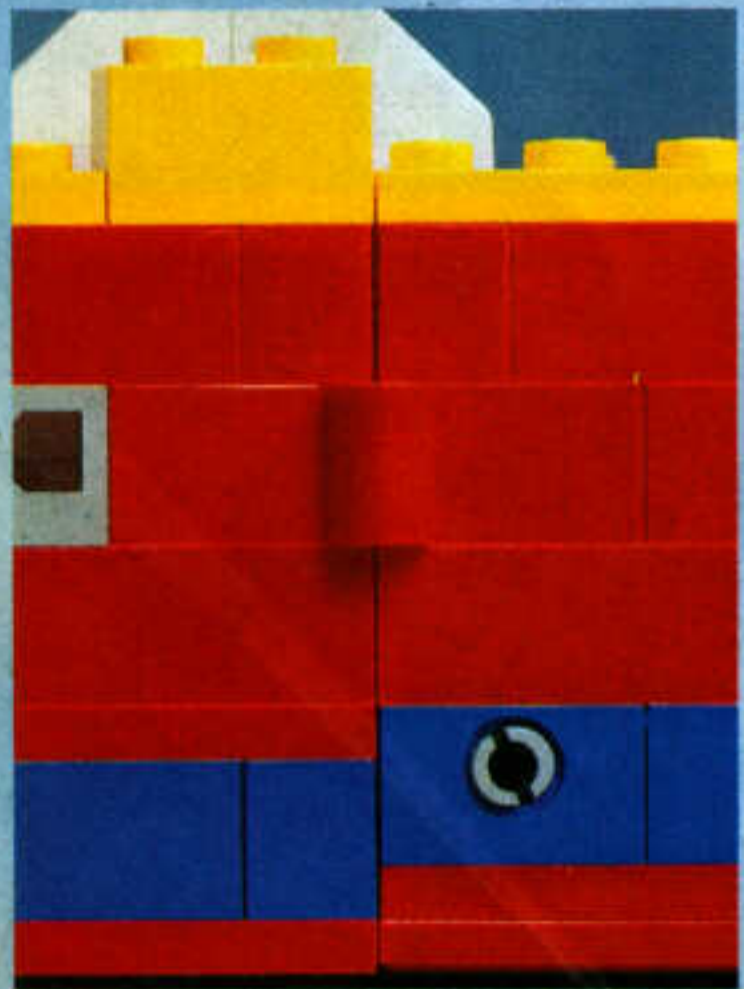
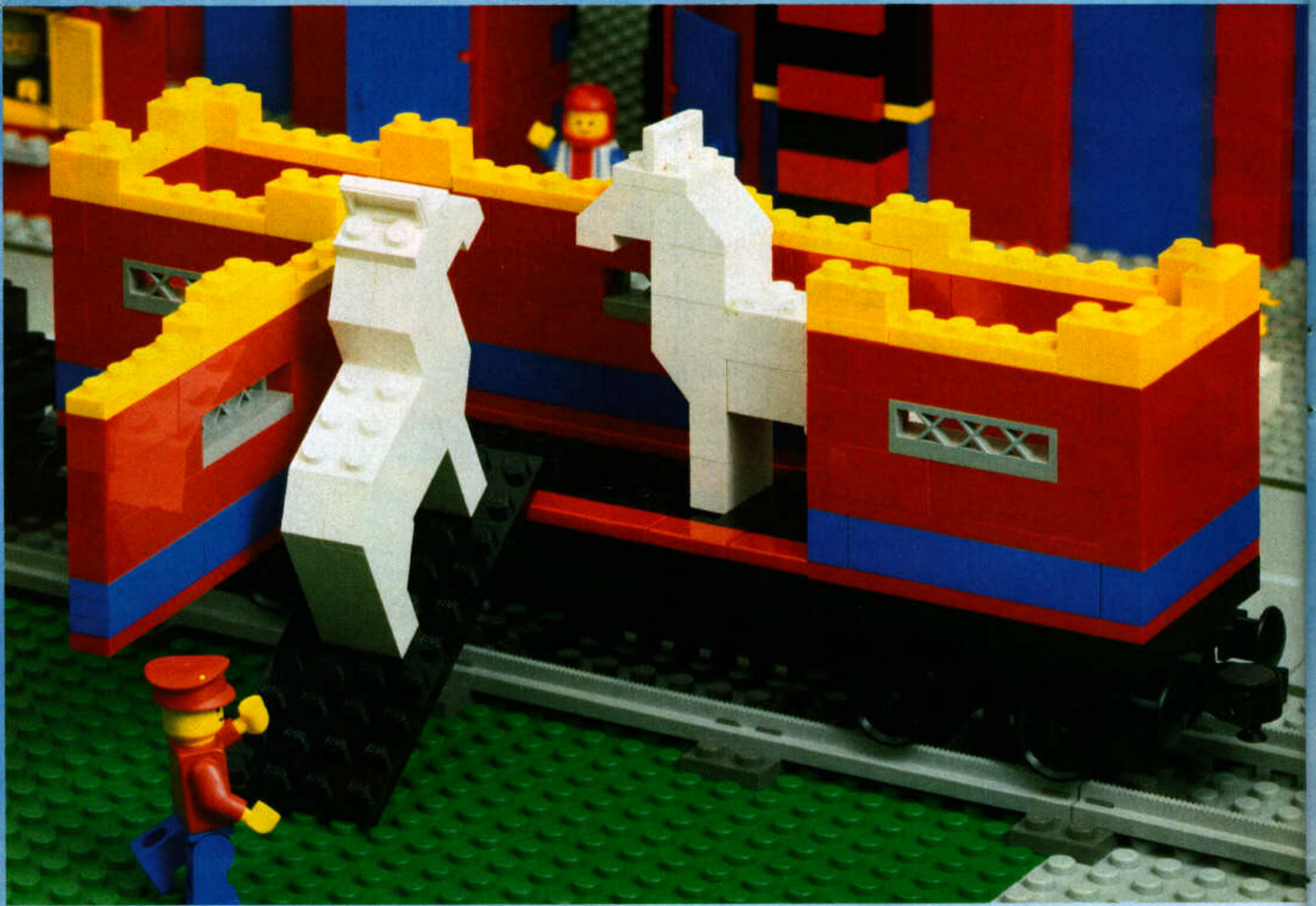



1

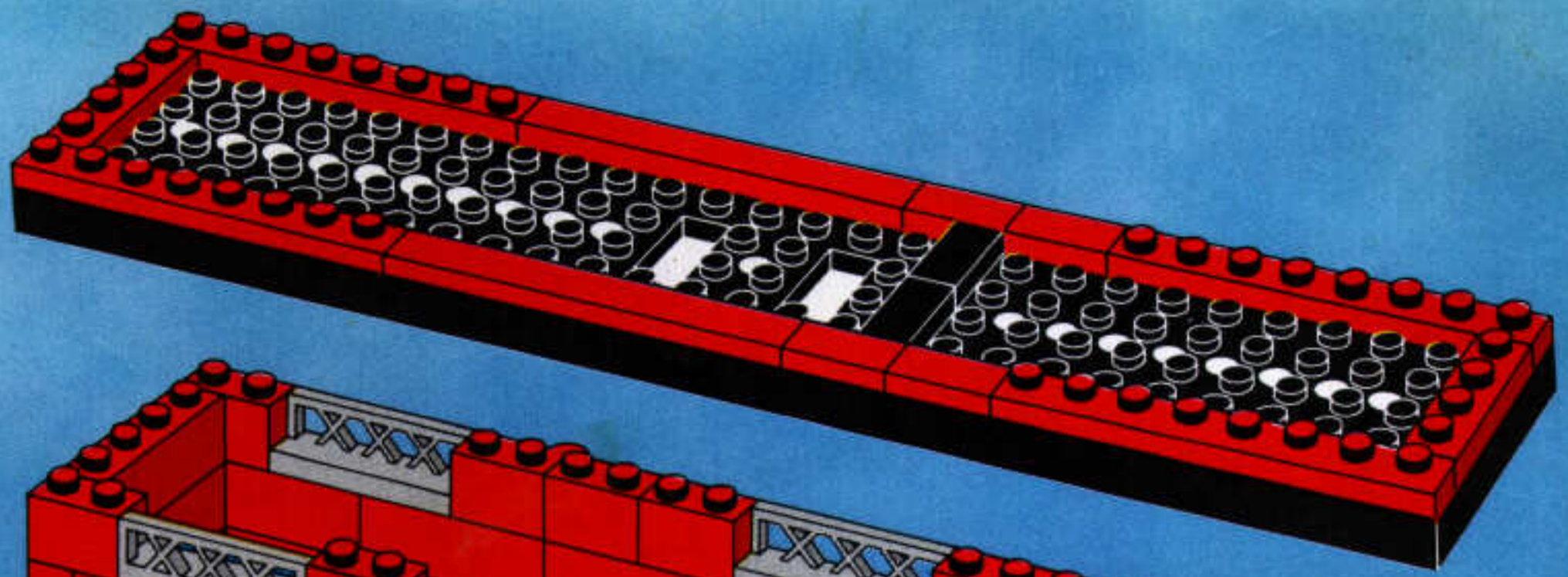

2

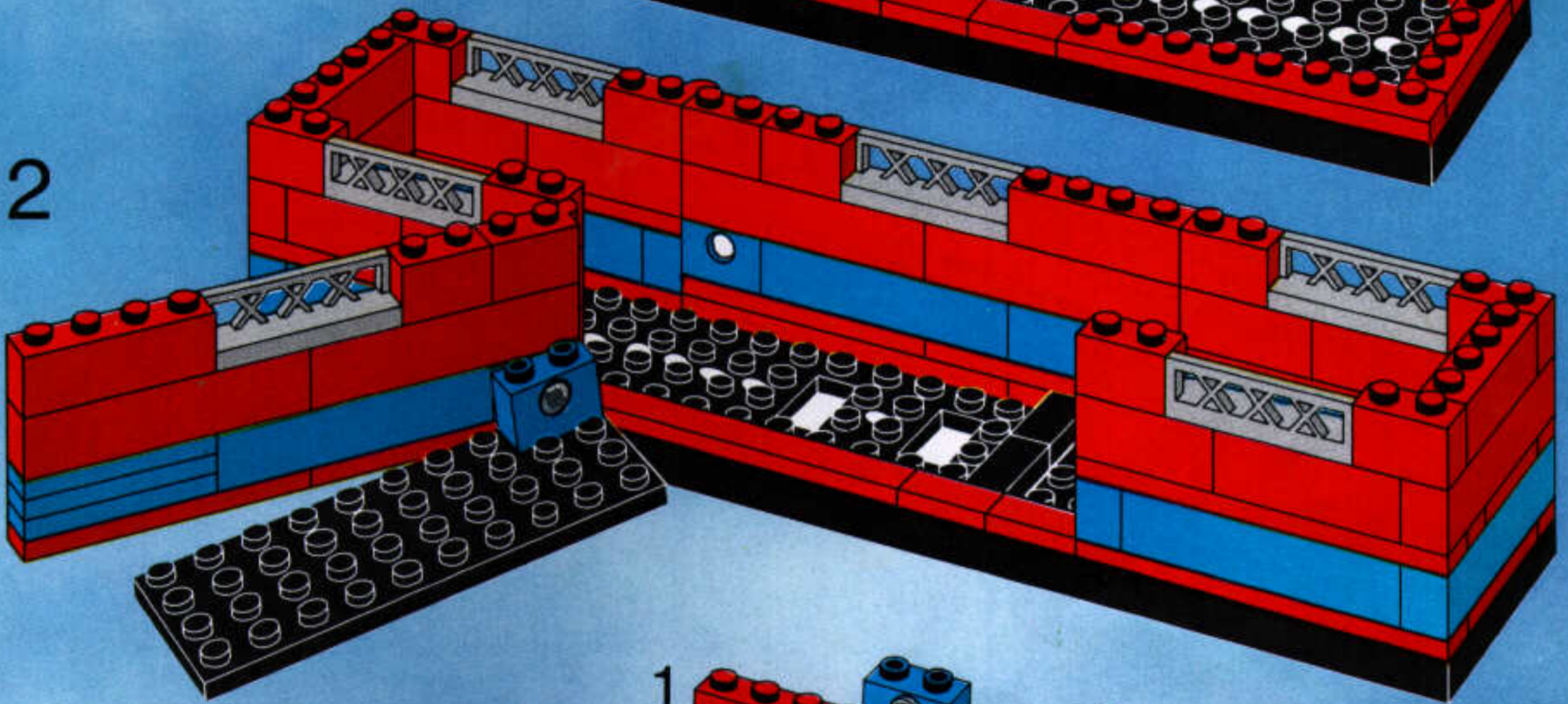

1

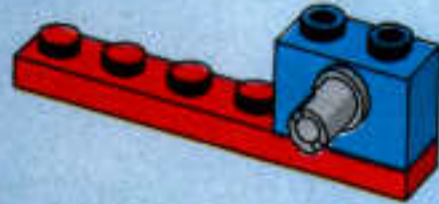

2

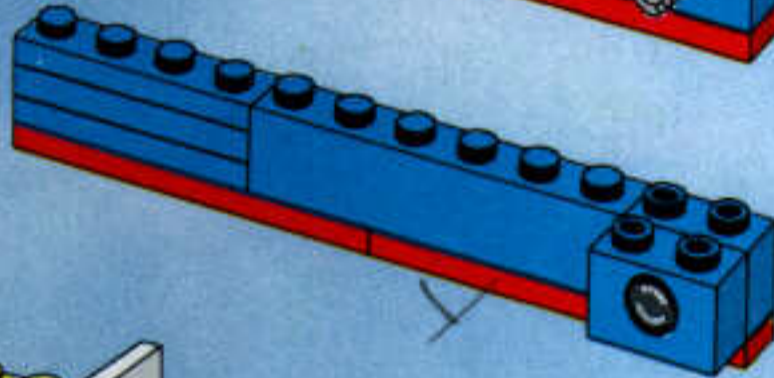

3

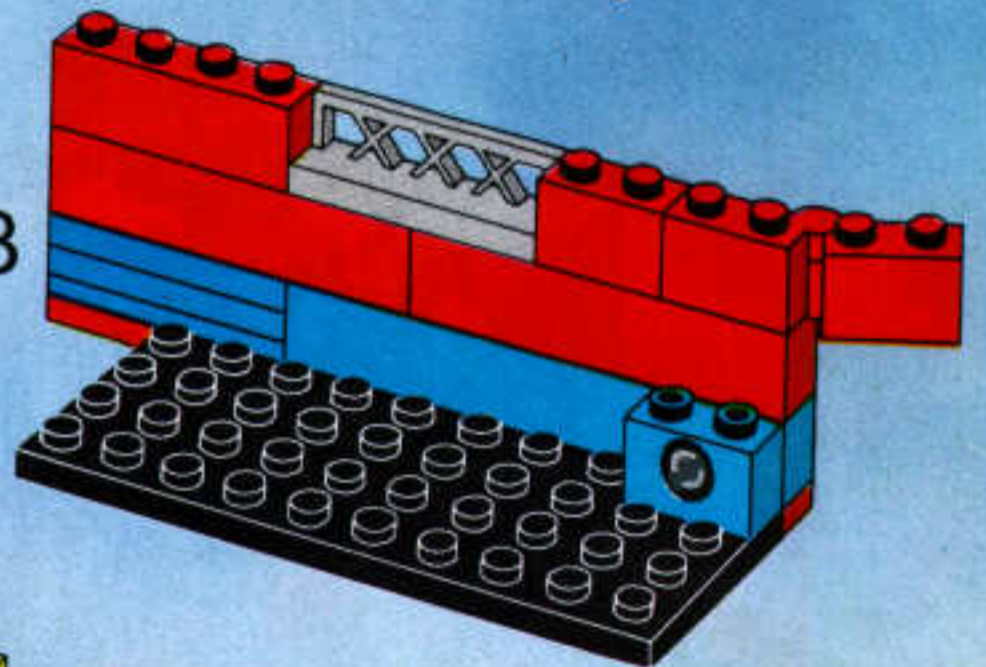

3

