



10132

Harry Potter

CAUTION - ELECTRIC TOY

Not recommended for children under 8 years of age. As with all electric products, precautions should be observed during handling and use to prevent electric shock. For indoor use only.





1



2

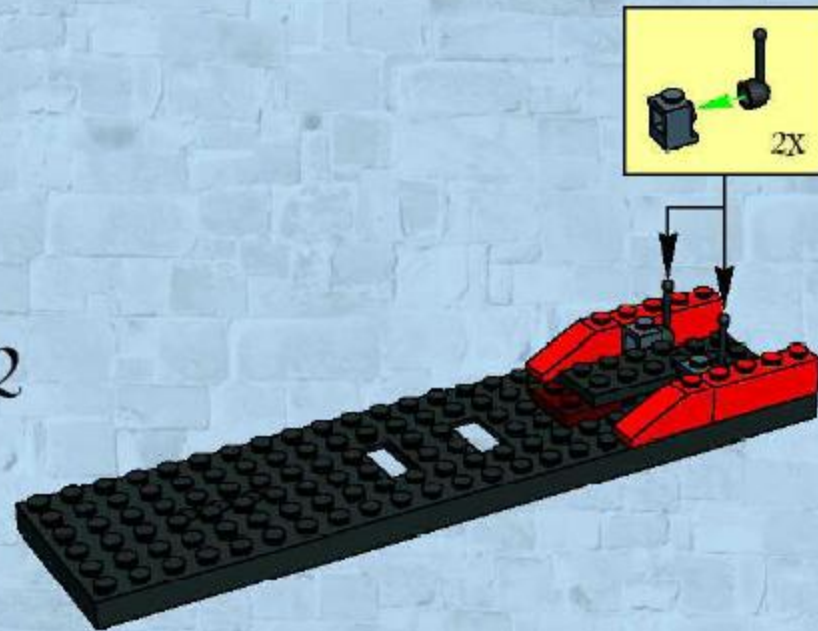



1

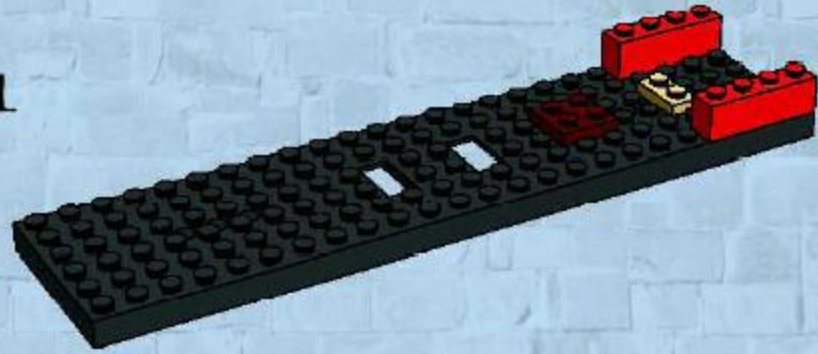

2

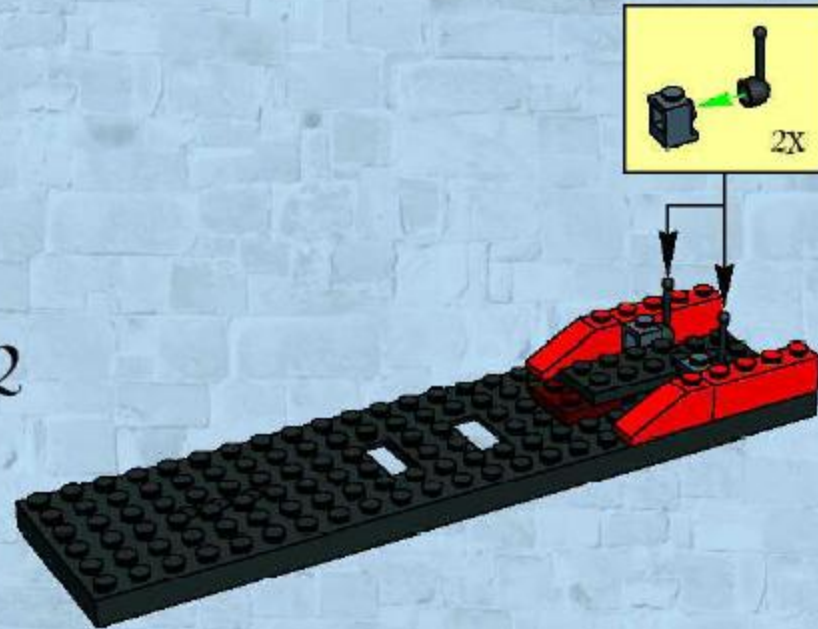

3

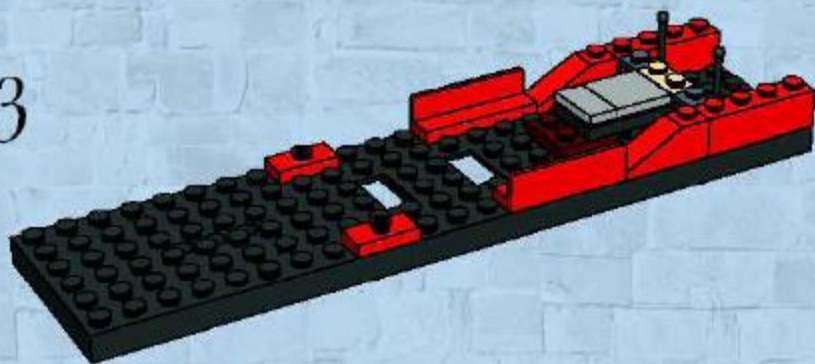

4

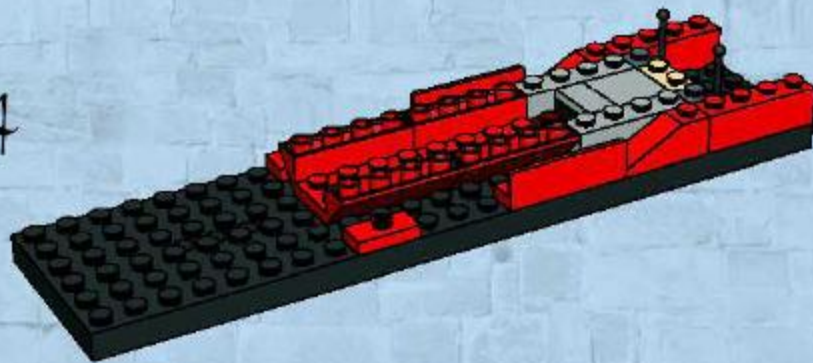

5

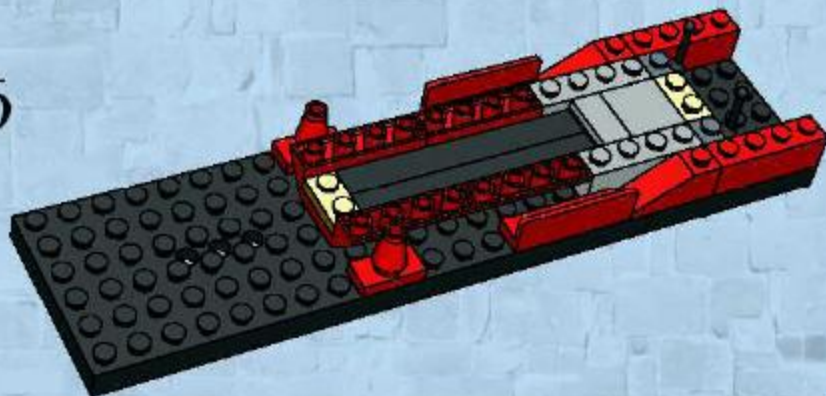

6

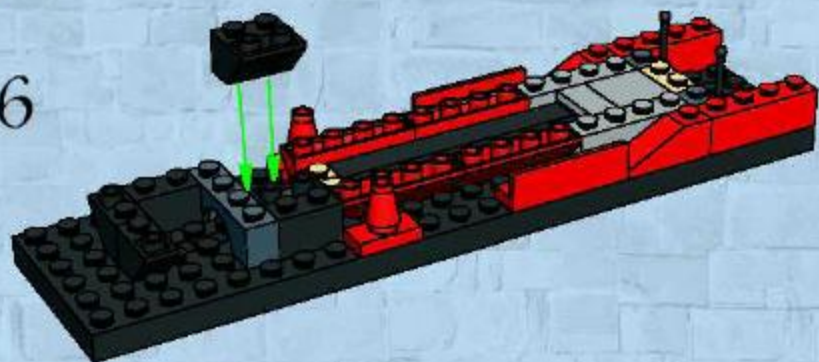

7

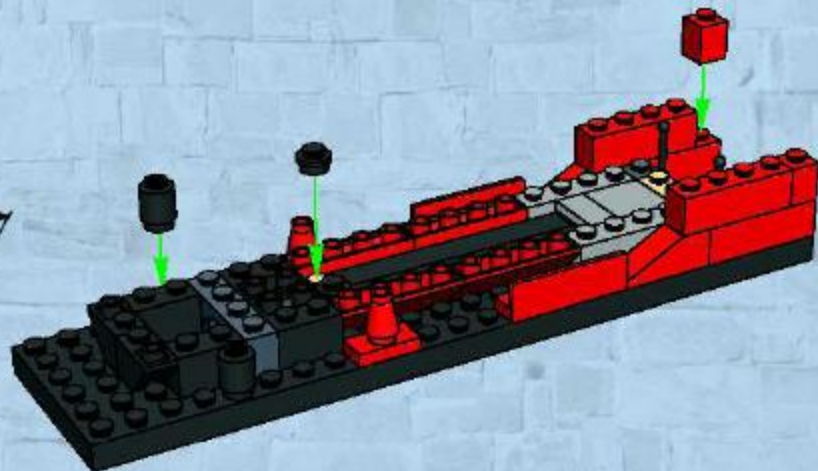

8

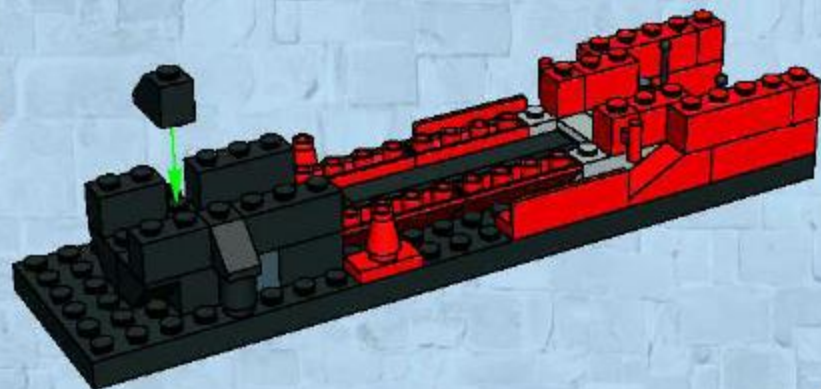

9

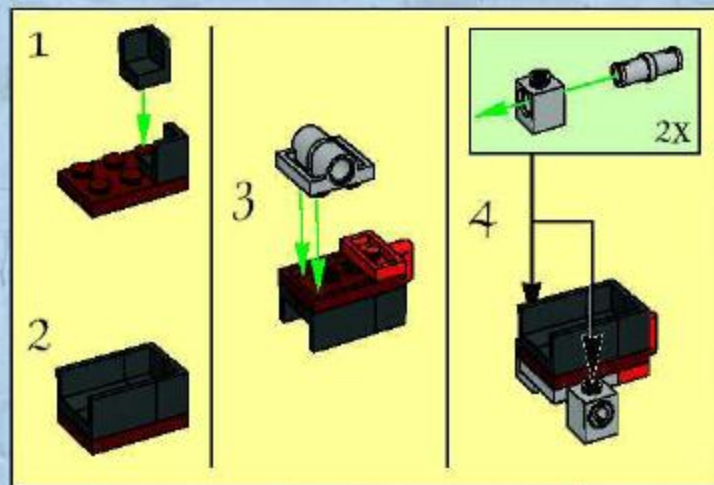
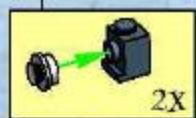
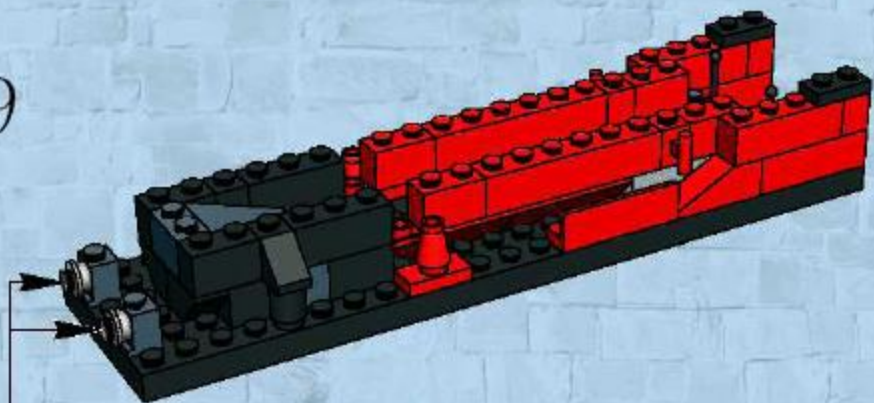

10

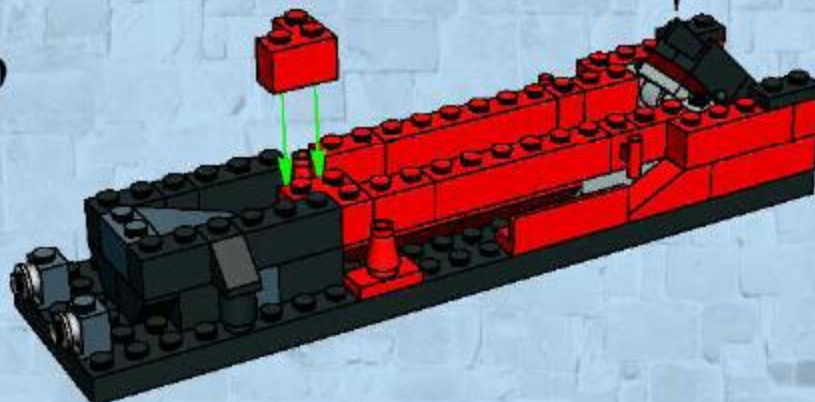

11

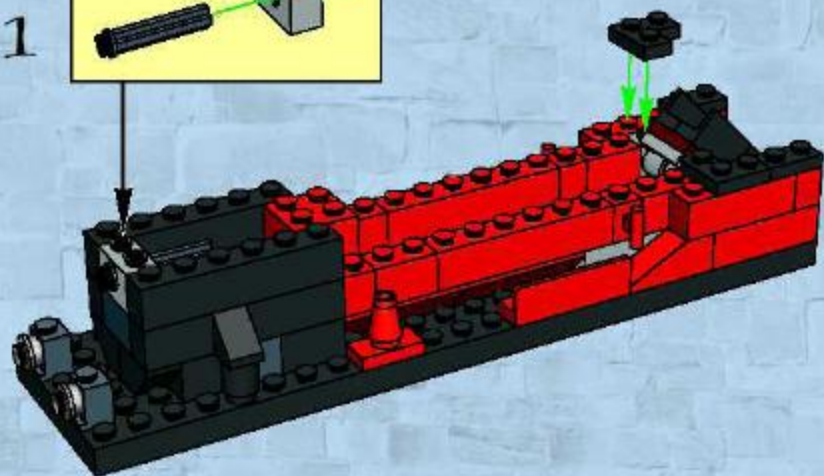
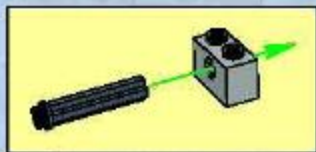

12

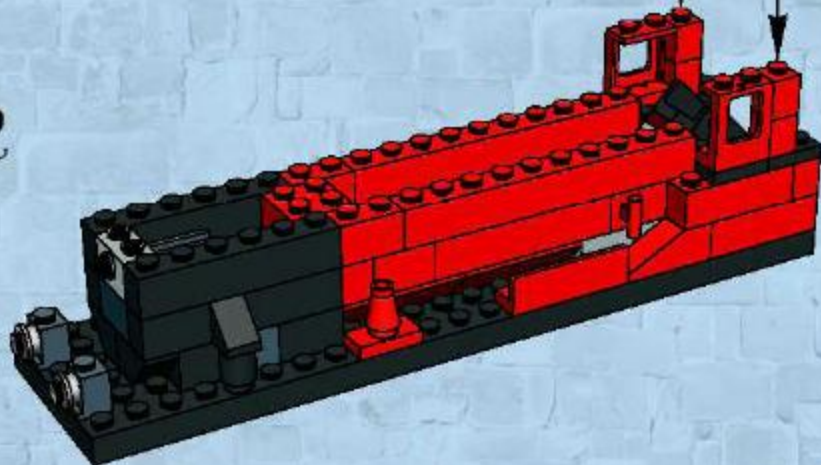
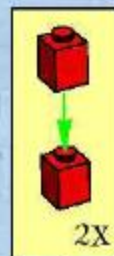

13

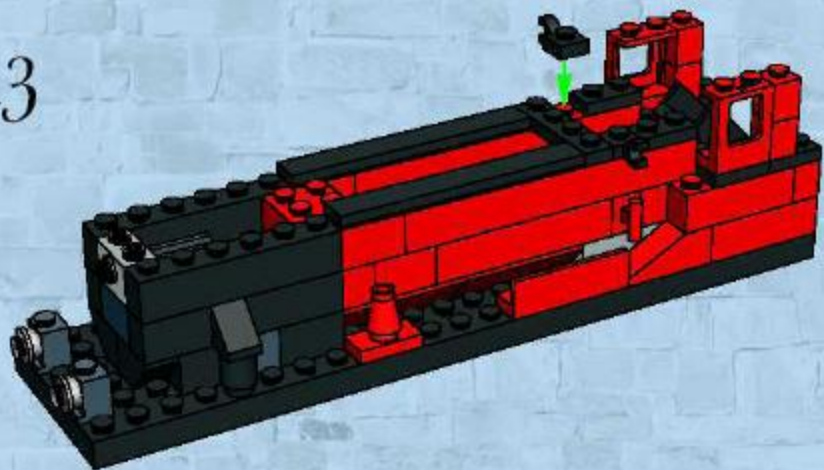

14

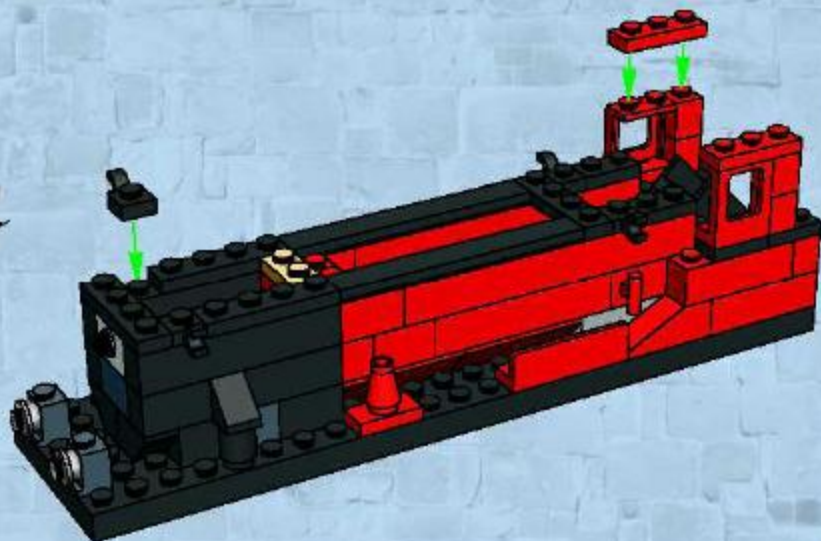

15

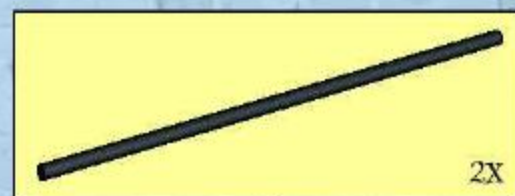
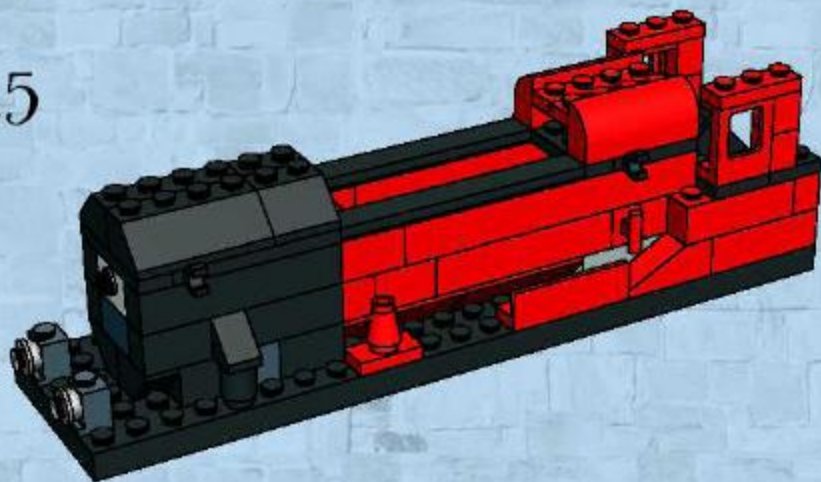

16

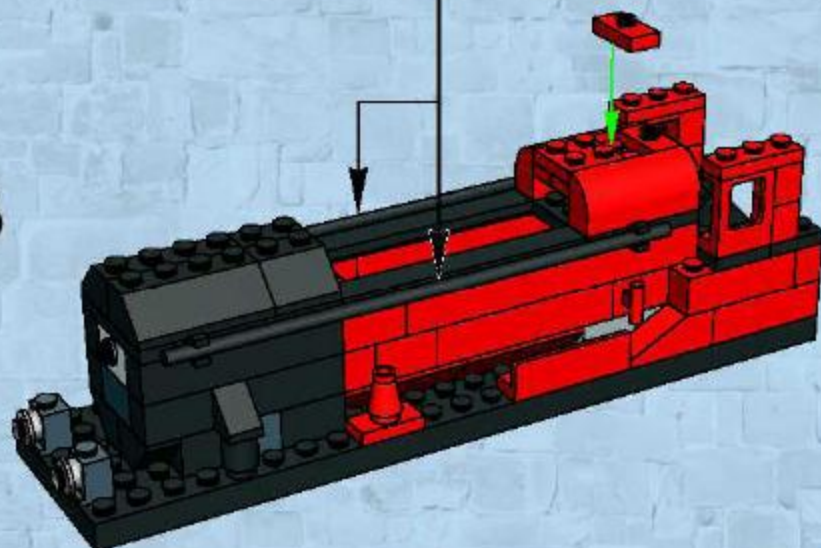

17

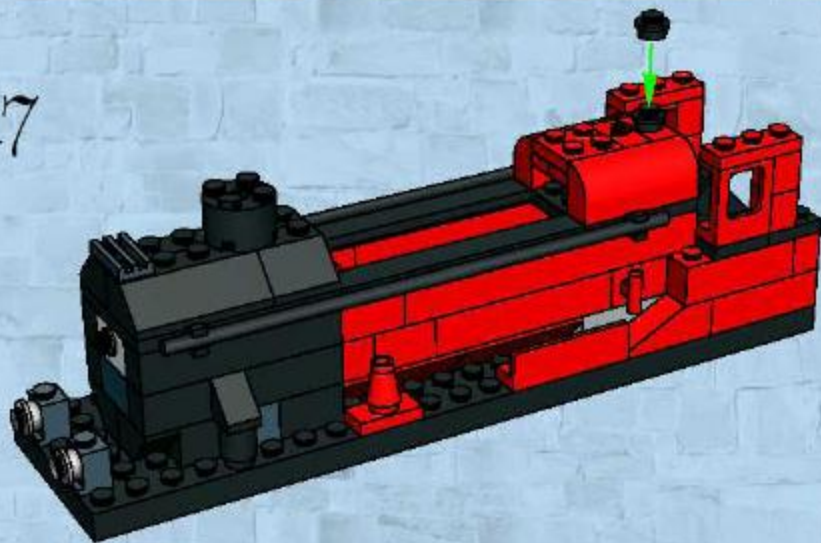

18

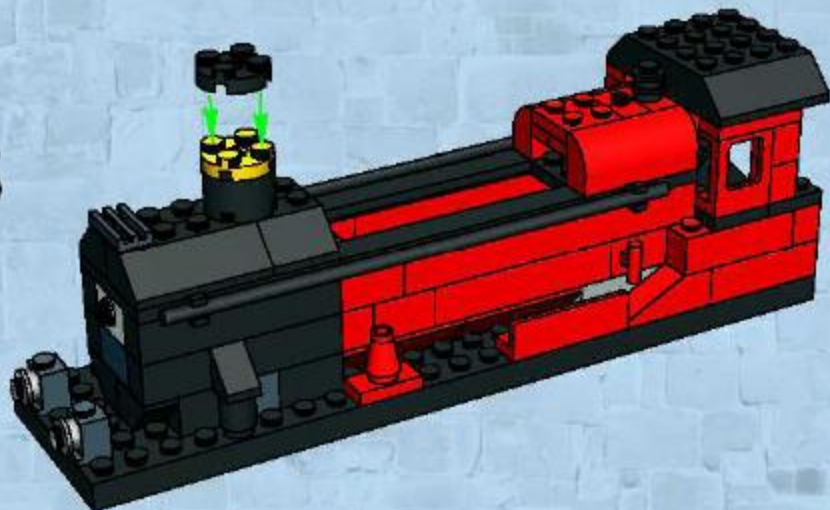

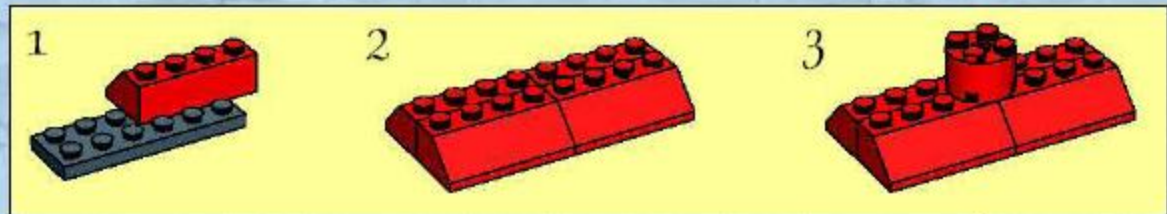

1

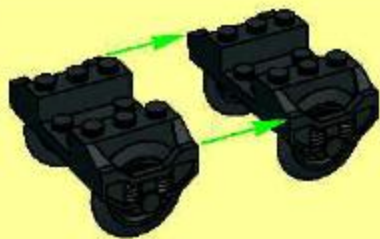

2



3



4

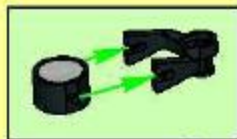

20

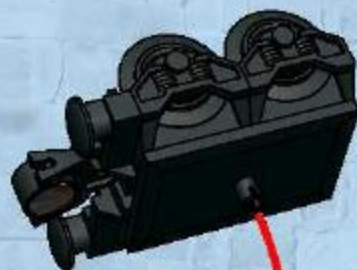

1



2



3



4



21

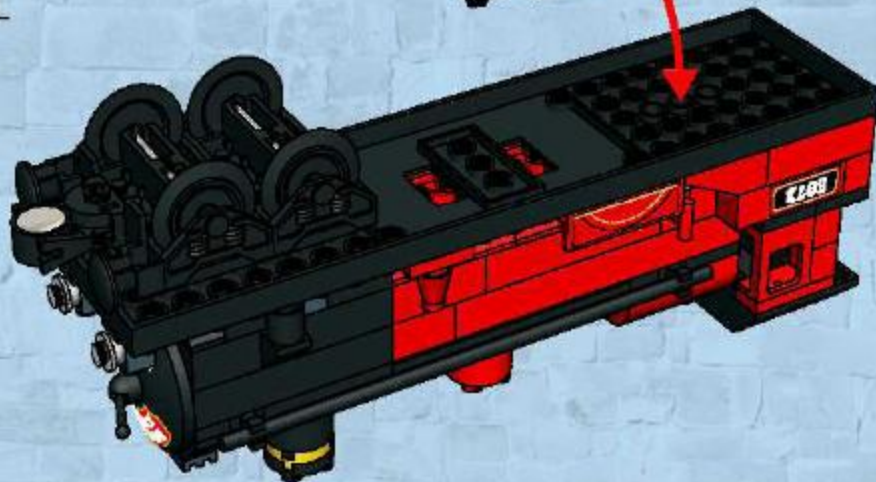

| | | |
|--|------------|---|
| <p>1. Insert the axle into the hole in the black Technic axle connector. Push the axle through the hole in the black Technic axle connector. Push the axle through the hole in the black Technic axle connector. Push the axle through the hole in the black Technic axle connector.</p> | <h1>2</h1> | <p>2. Push the axle through the hole in the black Technic axle connector. Push the axle through the hole in the black Technic axle connector. Push the axle through the hole in the black Technic axle connector.</p> |
| <p>1. Insert the axle into the hole in the black Technic axle connector. Push the axle through the hole in the black Technic axle connector. Push the axle through the hole in the black Technic axle connector.</p> | <h1>2</h1> | <p>2. Push the axle through the hole in the black Technic axle connector. Push the axle through the hole in the black Technic axle connector. Push the axle through the hole in the black Technic axle connector.</p> |



1

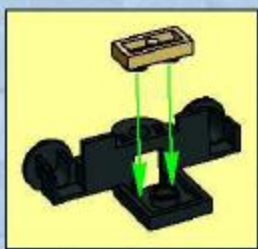
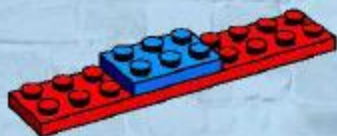

2



3

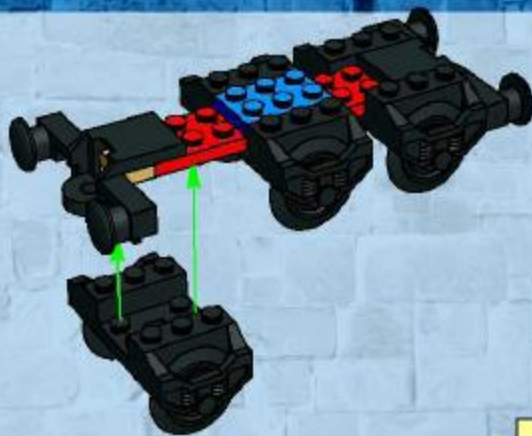

4

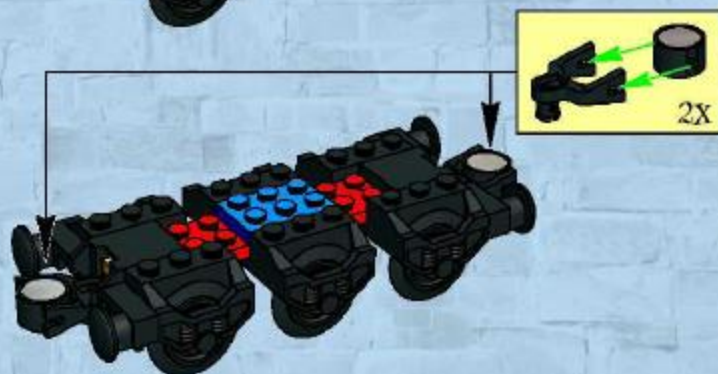

5

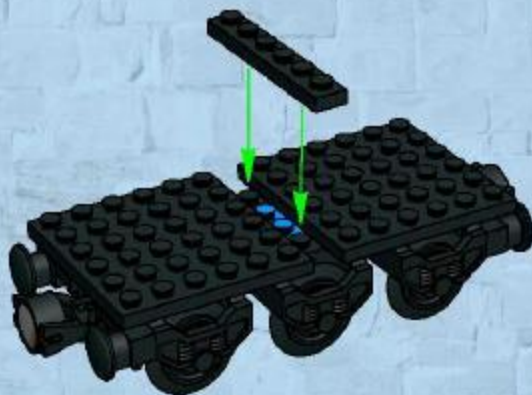

6

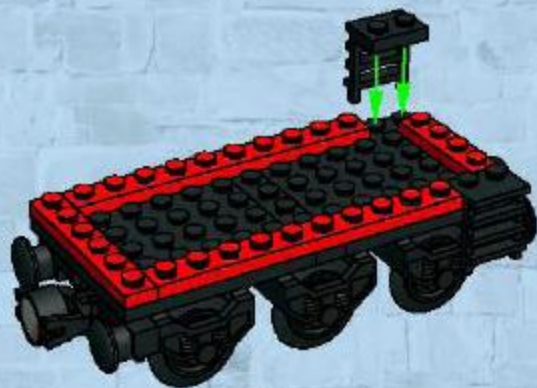

8

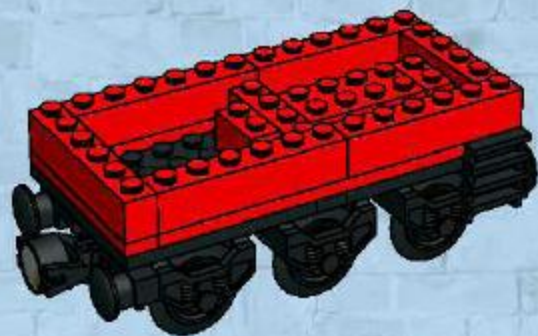

7

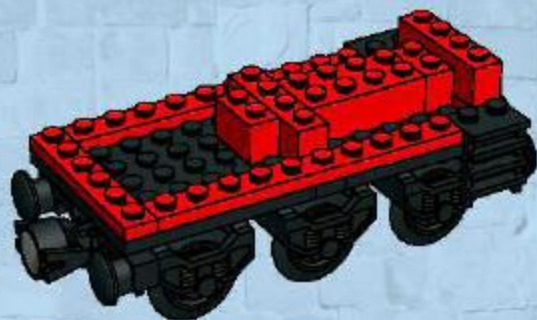

9

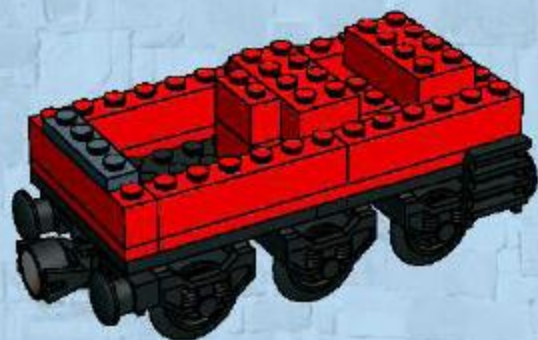

10

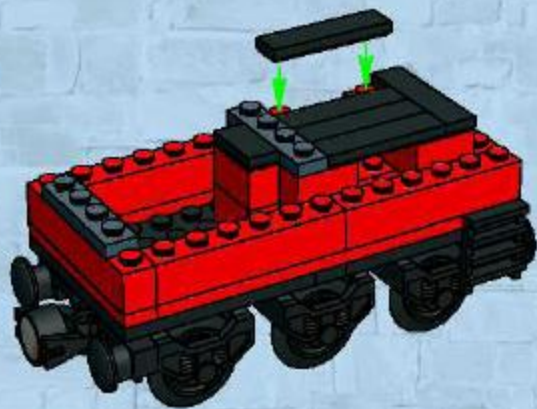

11

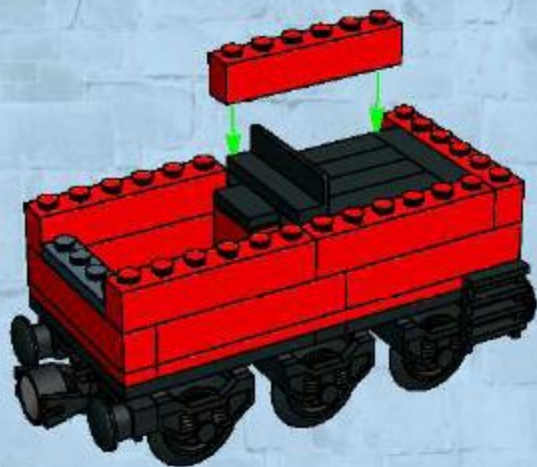

12

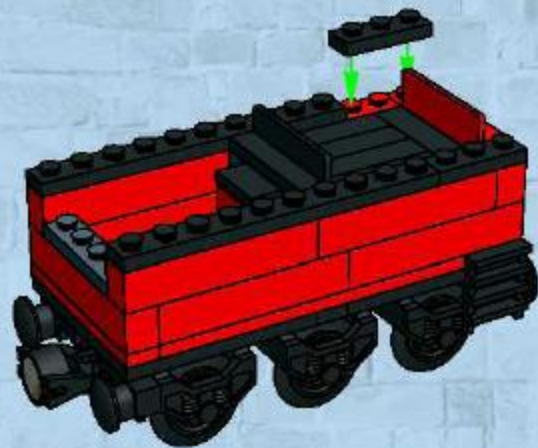

1

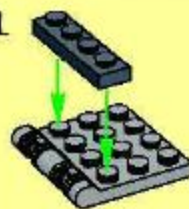

2



3



4



13



15

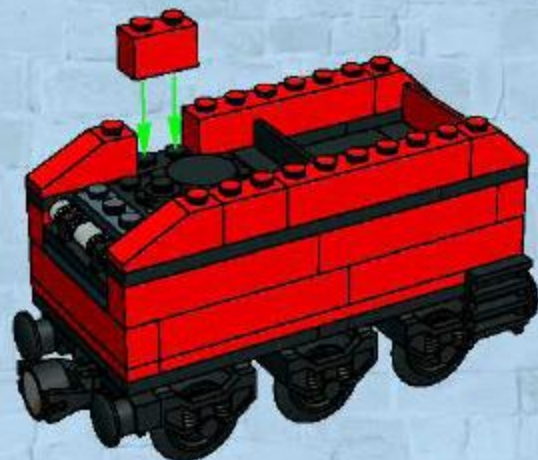

14



16



22



| | |
|---|---|
| <p>3</p> <p>1. Place the black 1x10 Technic plate on the black 1x10 Technic plate. Push the black 1x10 Technic plate into the hole of the black 1x10 Technic plate.</p> | <p>3</p> <p>1. Place the black 1x10 Technic plate on the black 1x10 Technic plate. Push the black 1x10 Technic plate into the hole of the black 1x10 Technic plate.</p> |
|---|---|

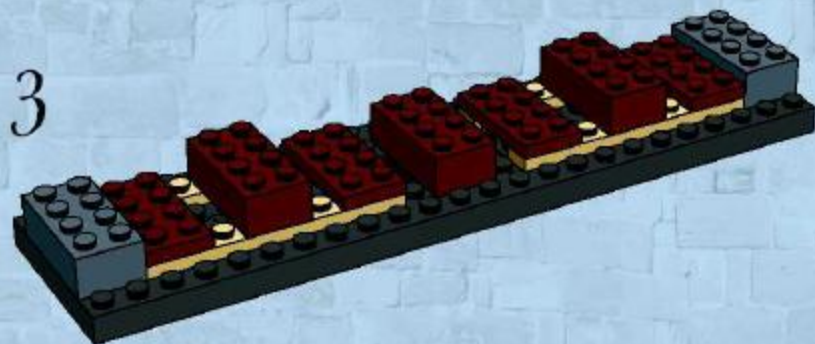
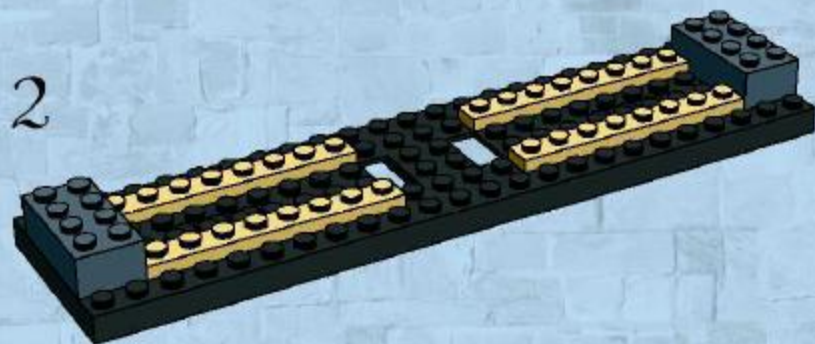

4

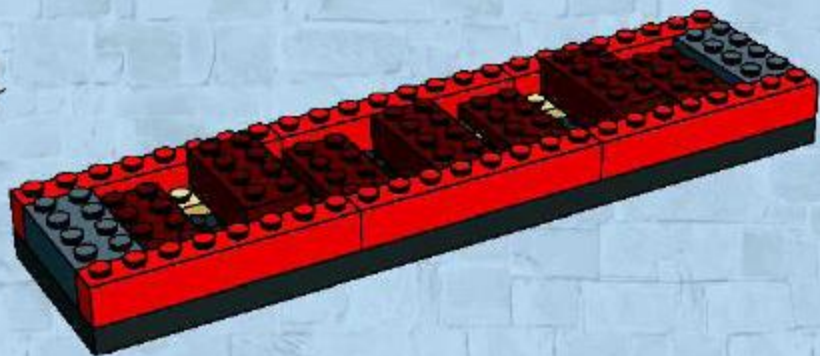

5

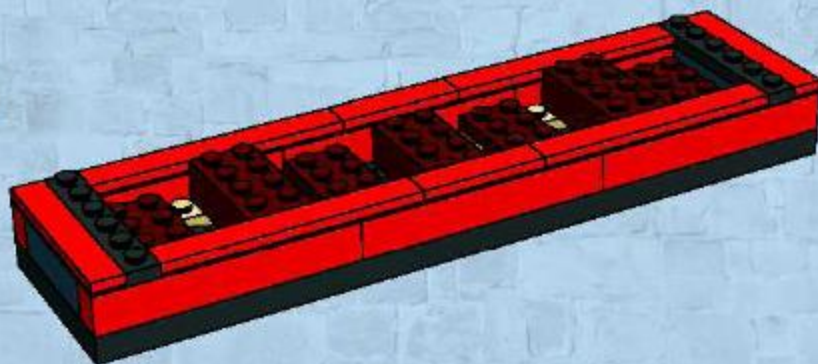

6

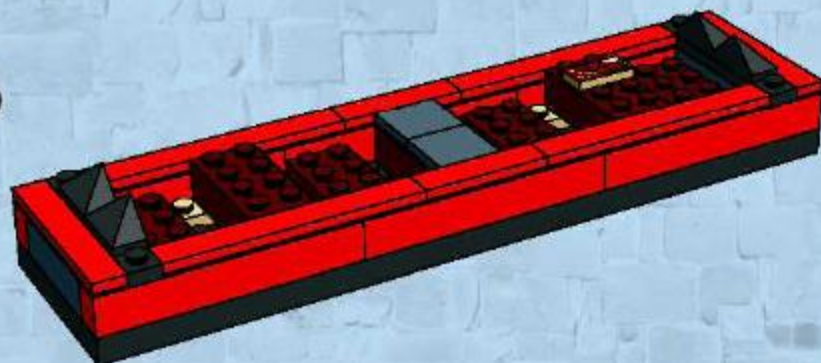

1

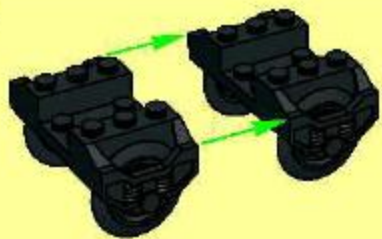

2



3



4

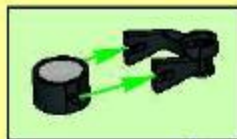

2X

7



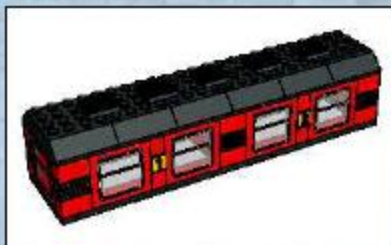

1

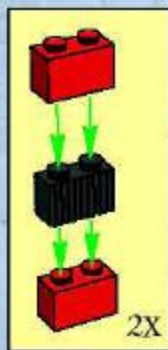
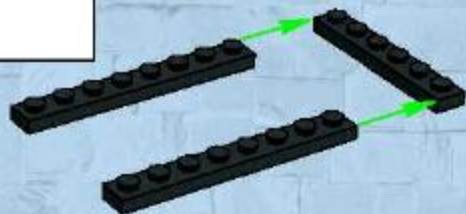

2

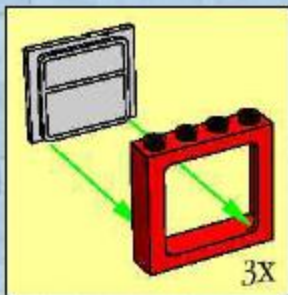
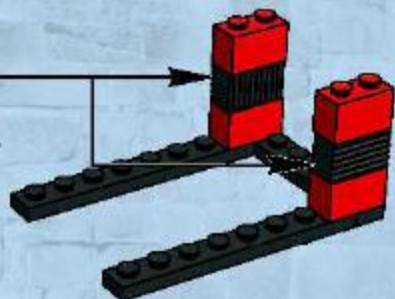

3

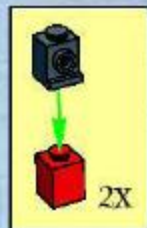
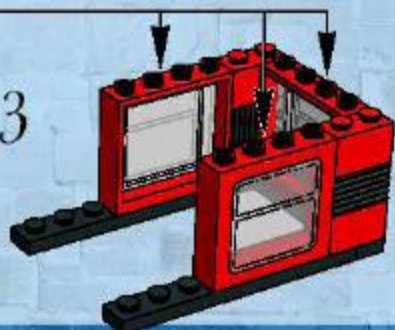

4

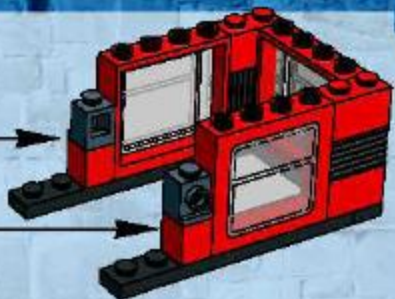

5

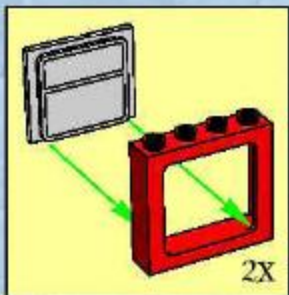
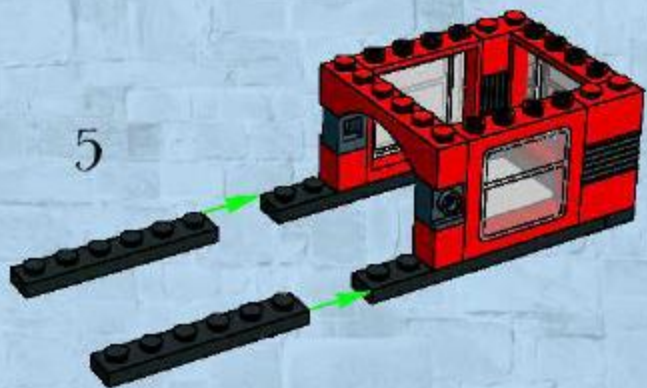

6



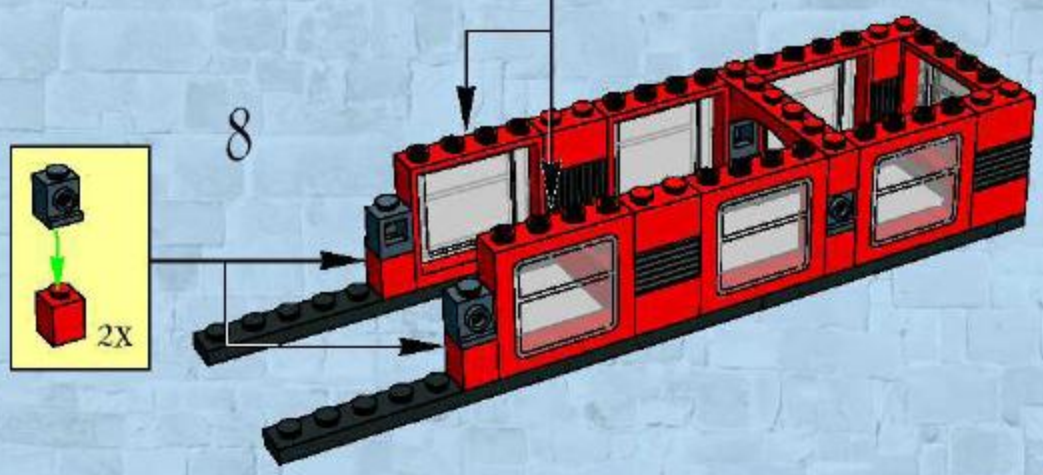
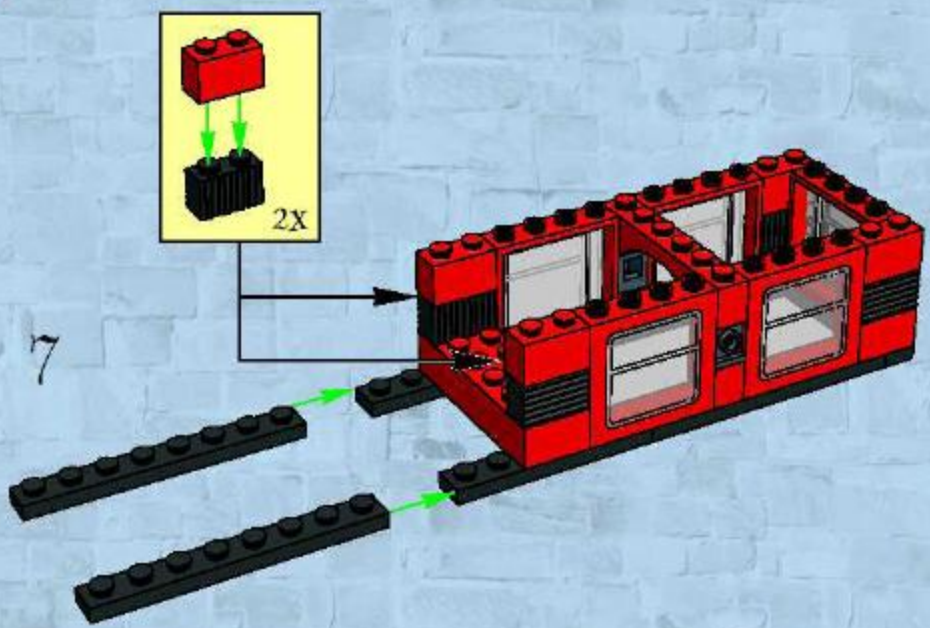

9

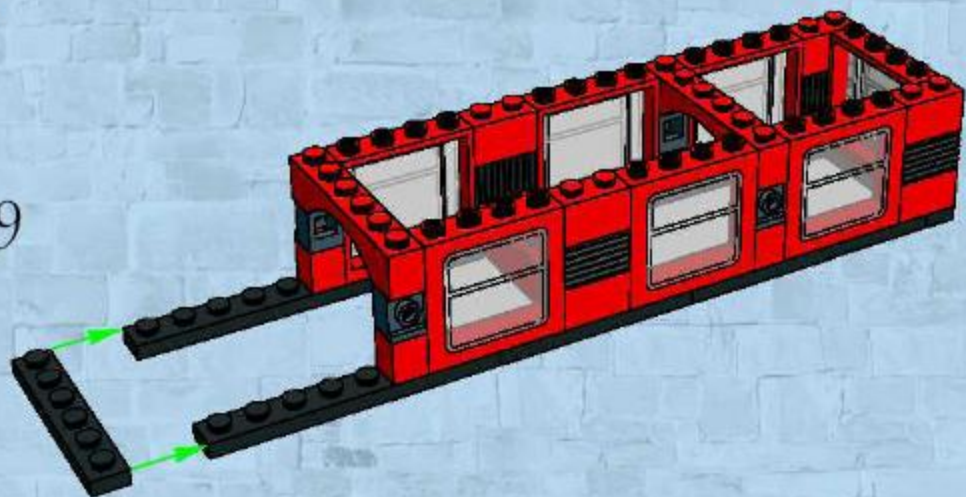

10

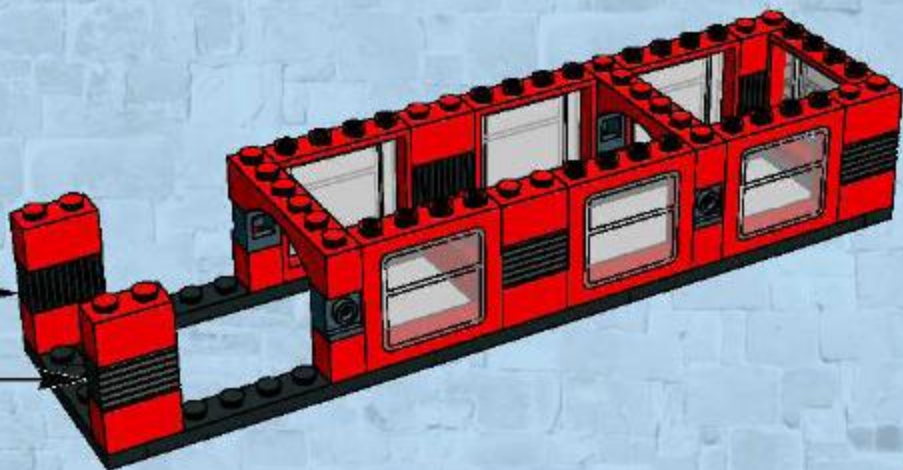
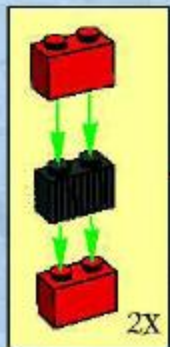

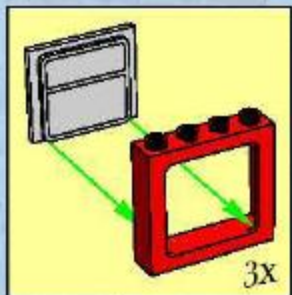

11

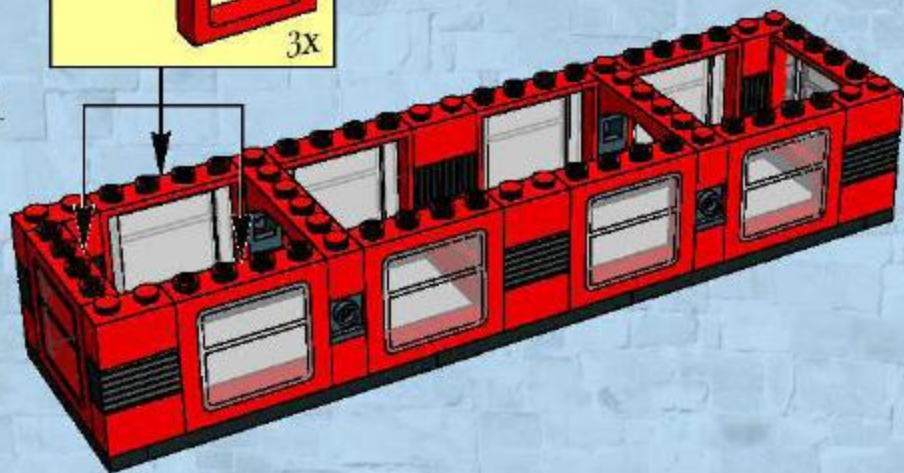

12

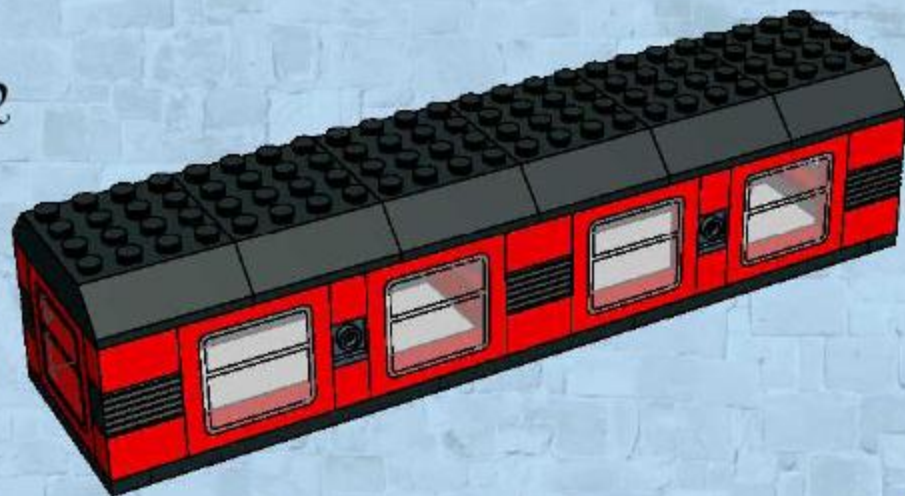

13

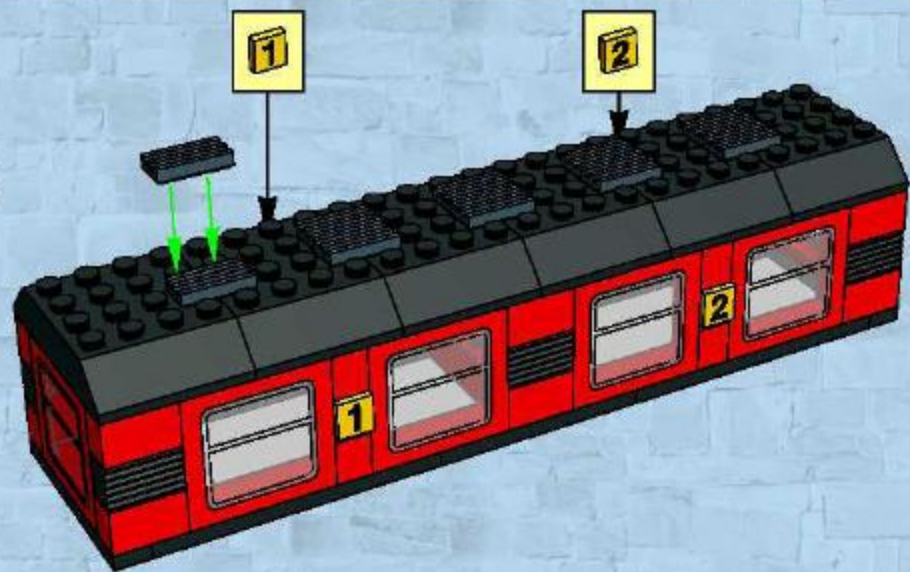

8







+

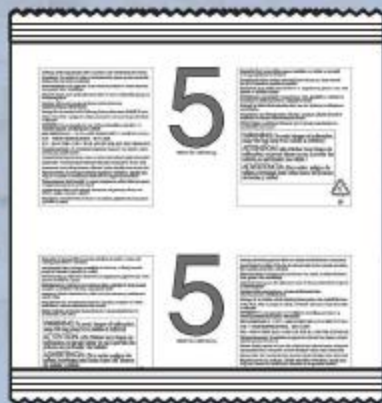

1

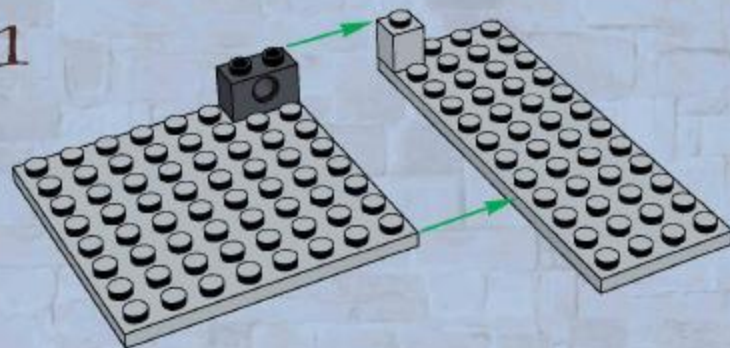

2

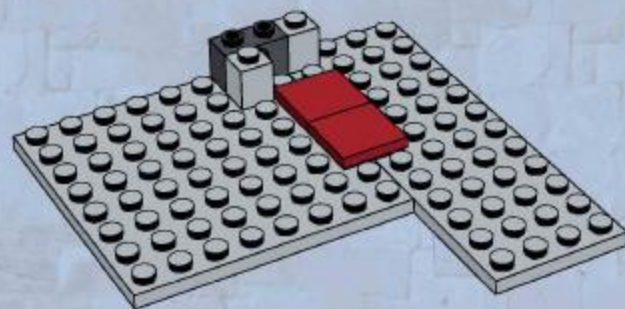

3

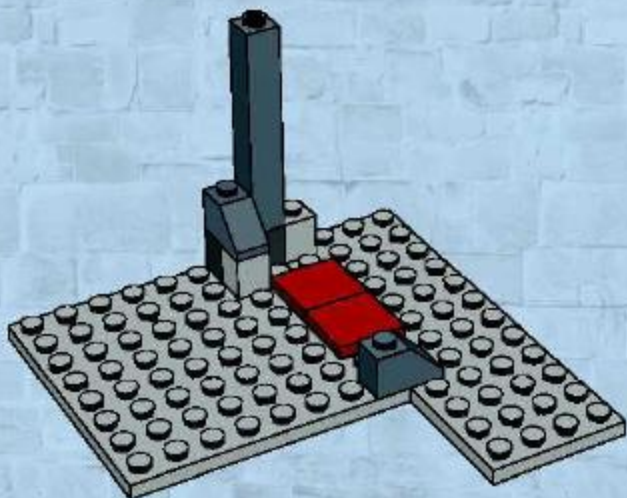

4

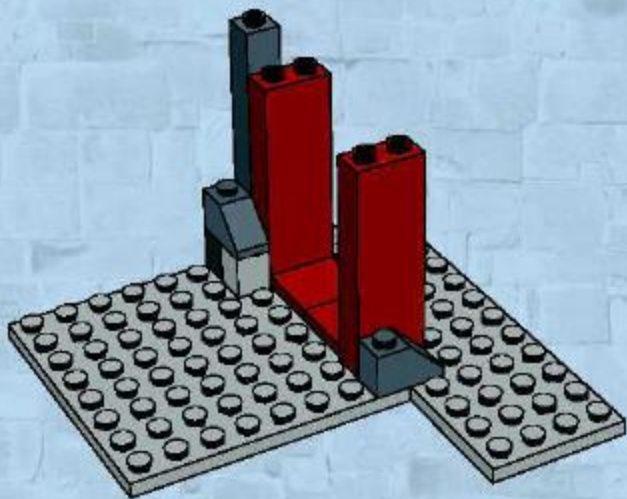

5

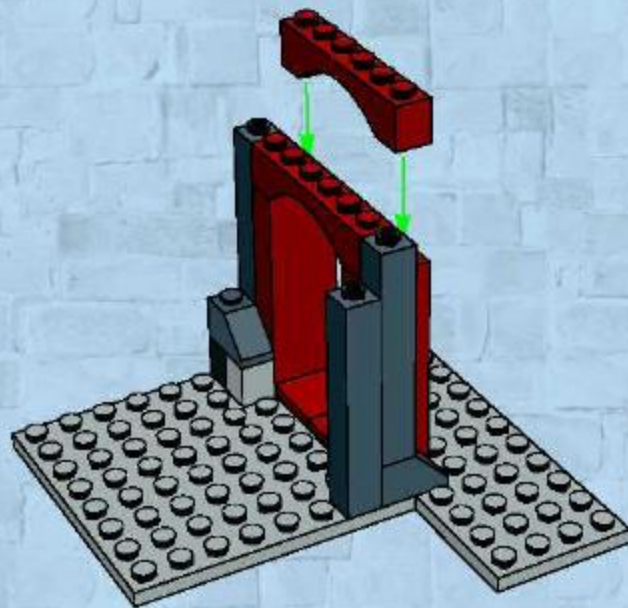

6

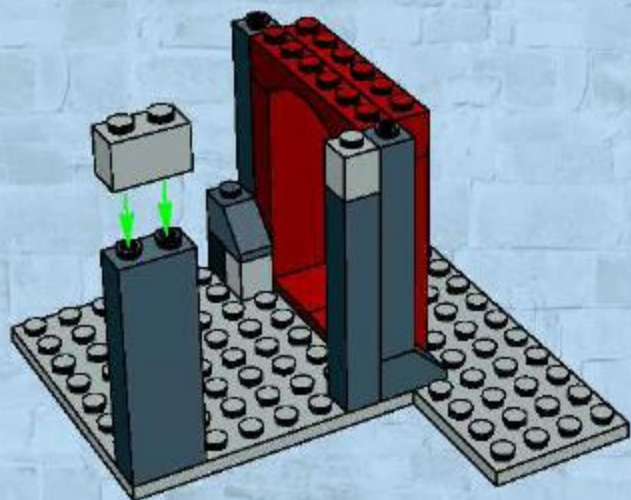

7

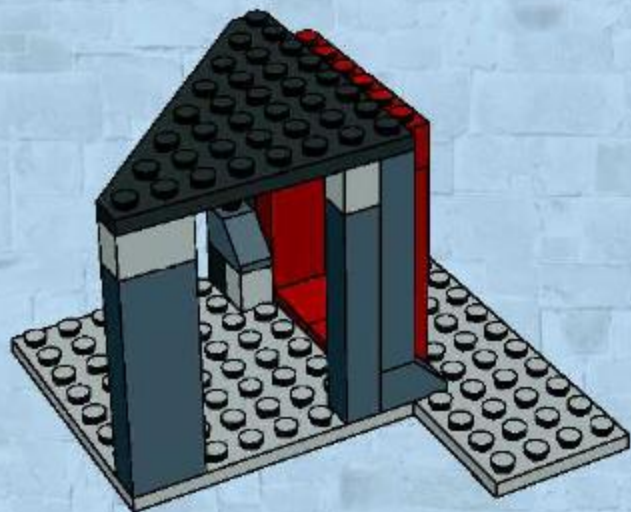

8

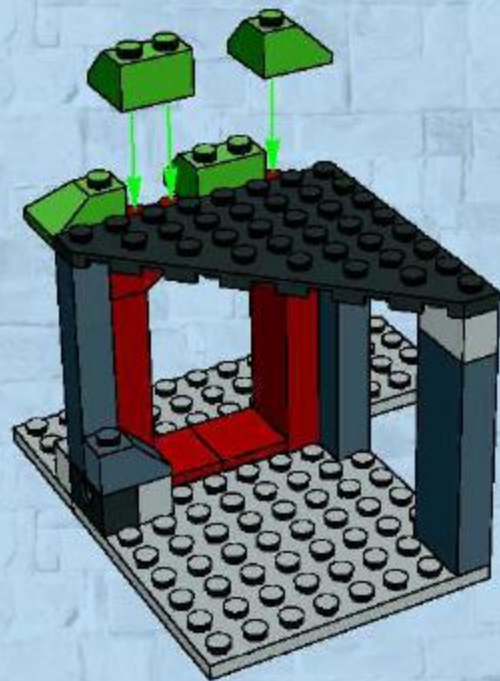

9

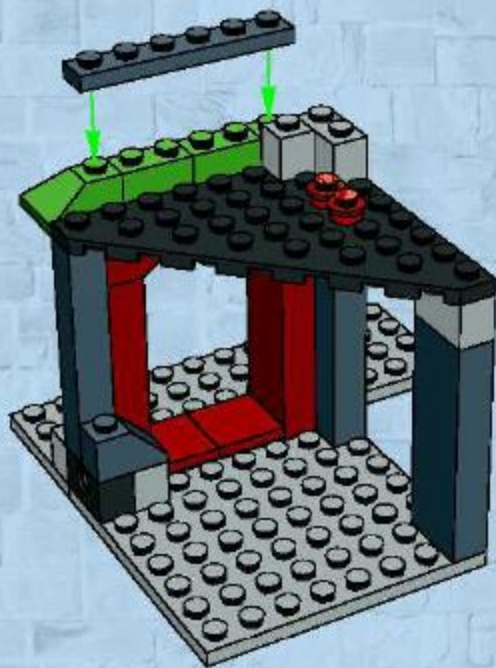

1



2



10

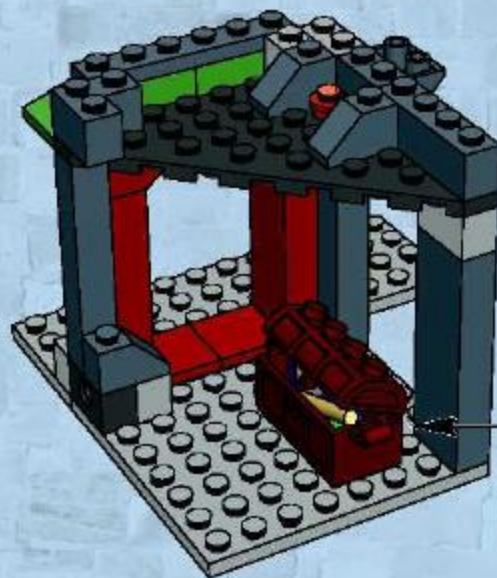

11

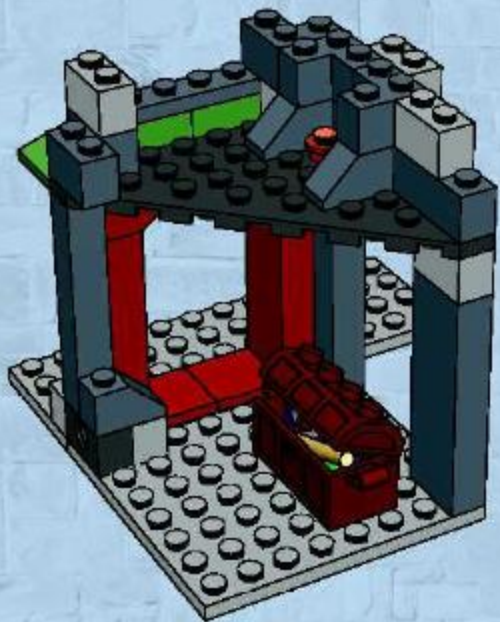

12

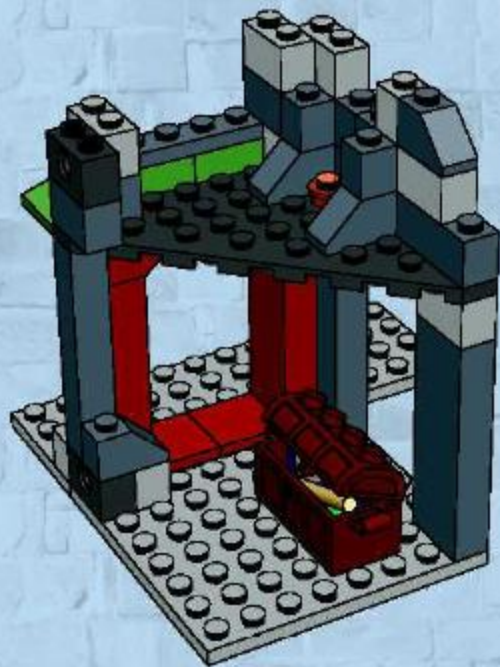

13

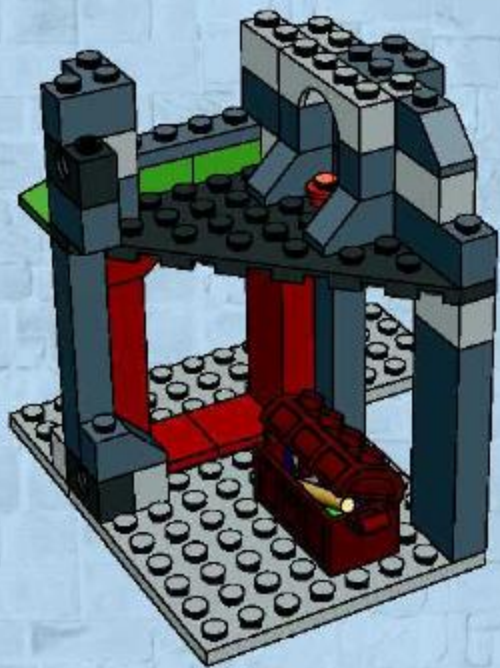

14

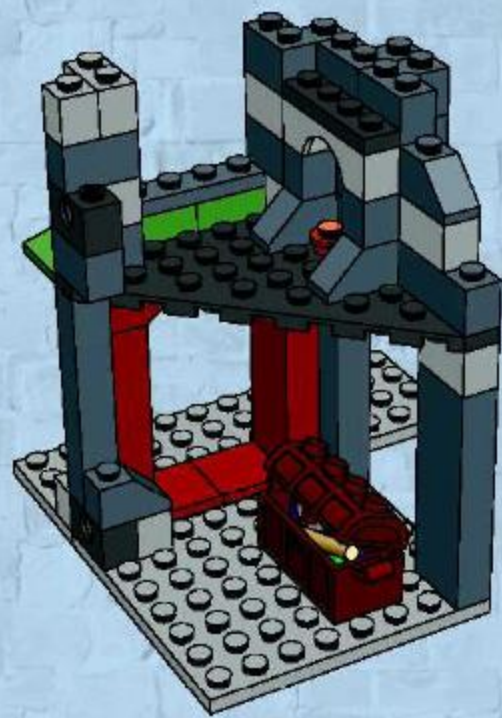

15

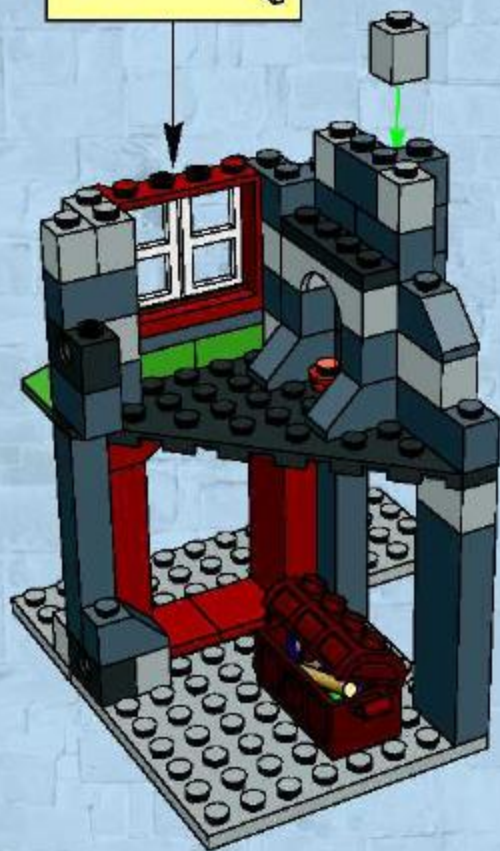
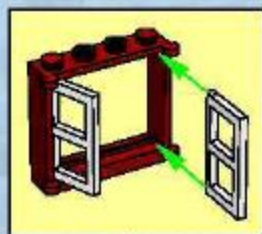

16

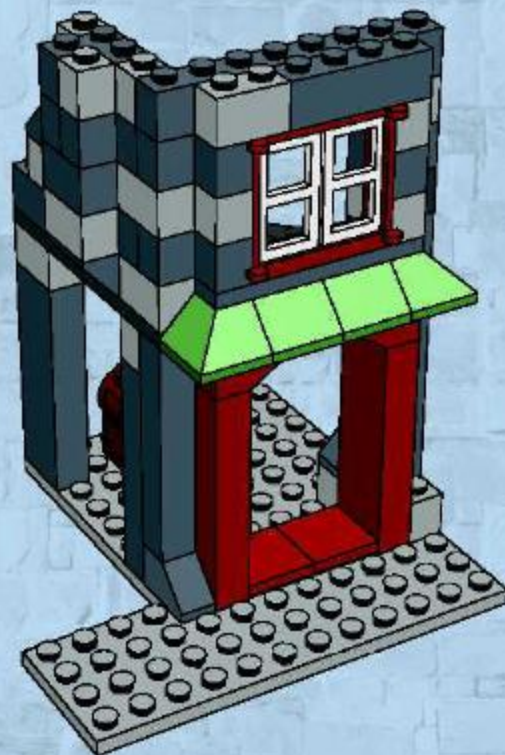

17

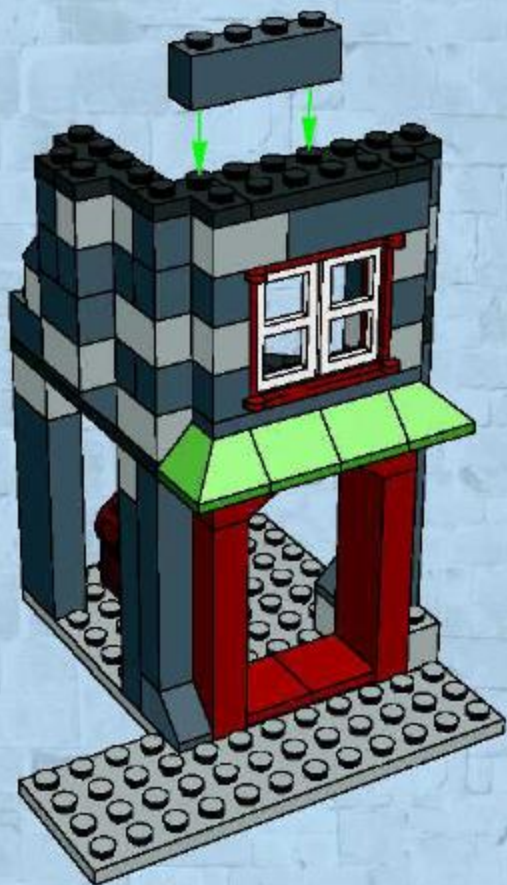

18



19

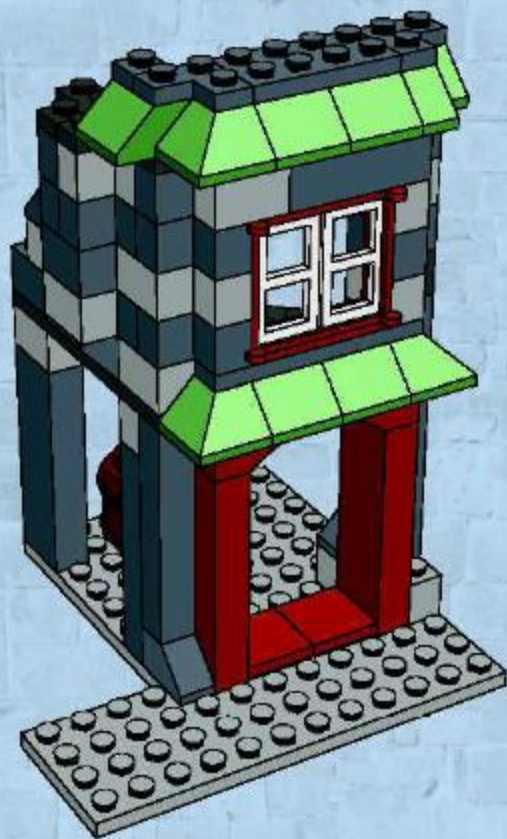

20

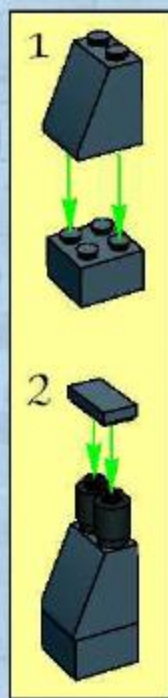

21

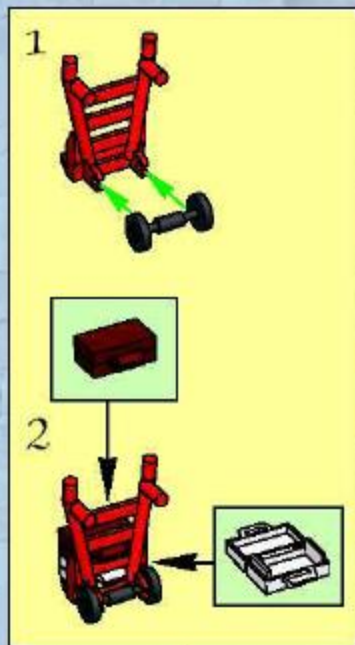
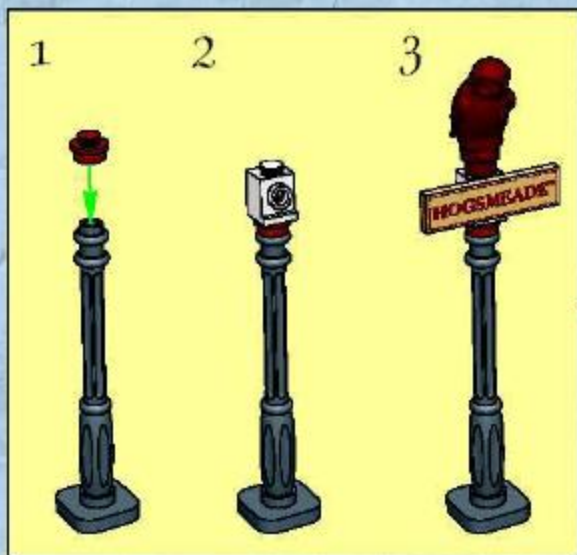



1

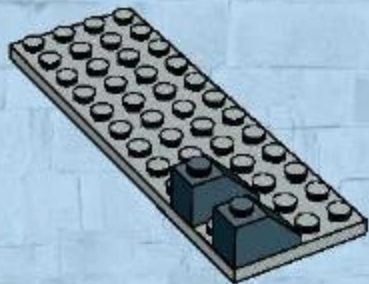

2

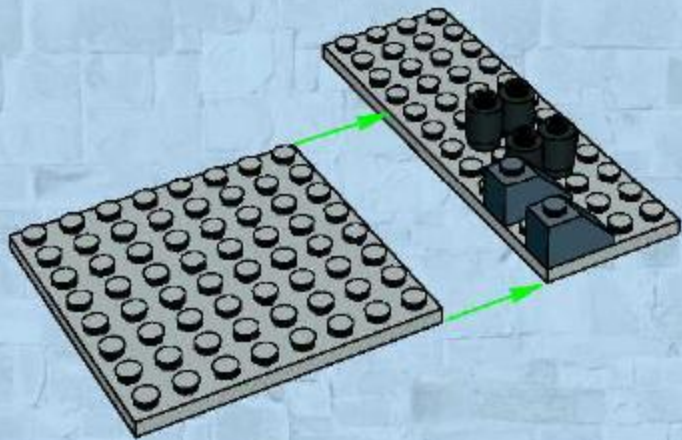

3

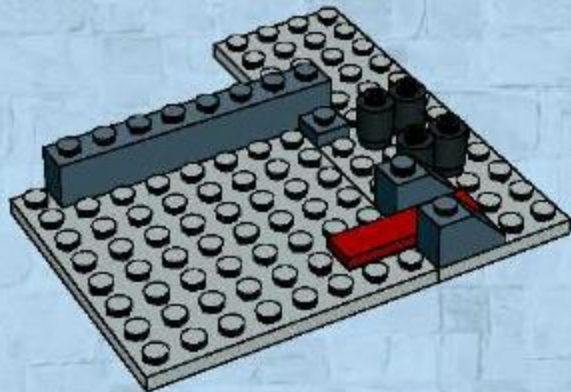

4

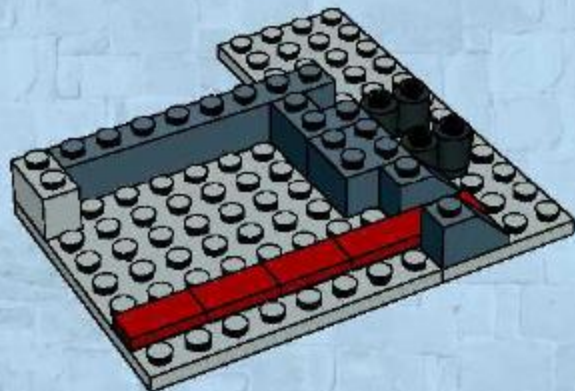

5

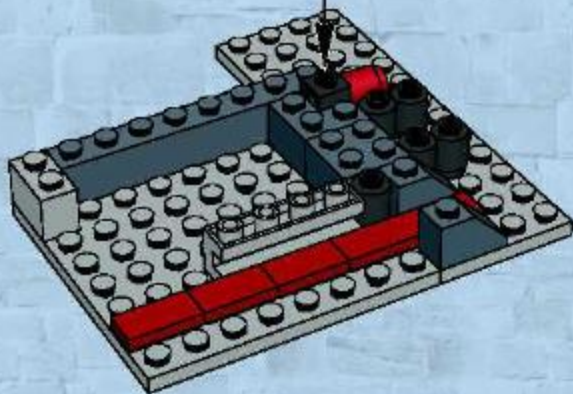
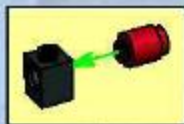

7

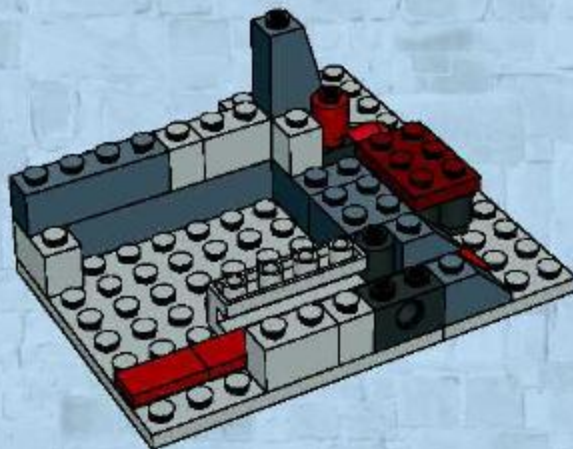

6

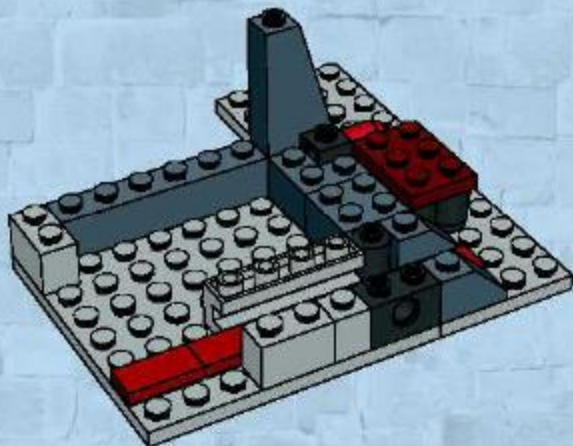

8

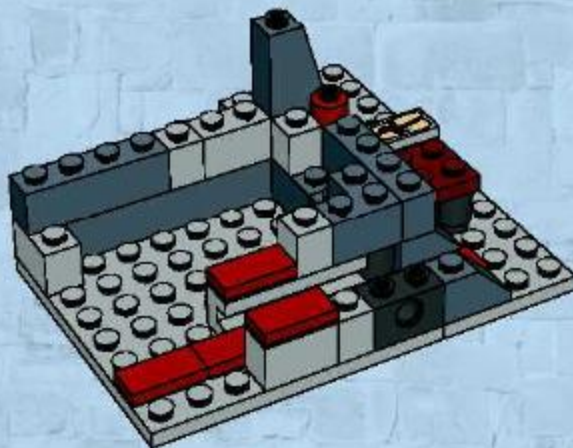

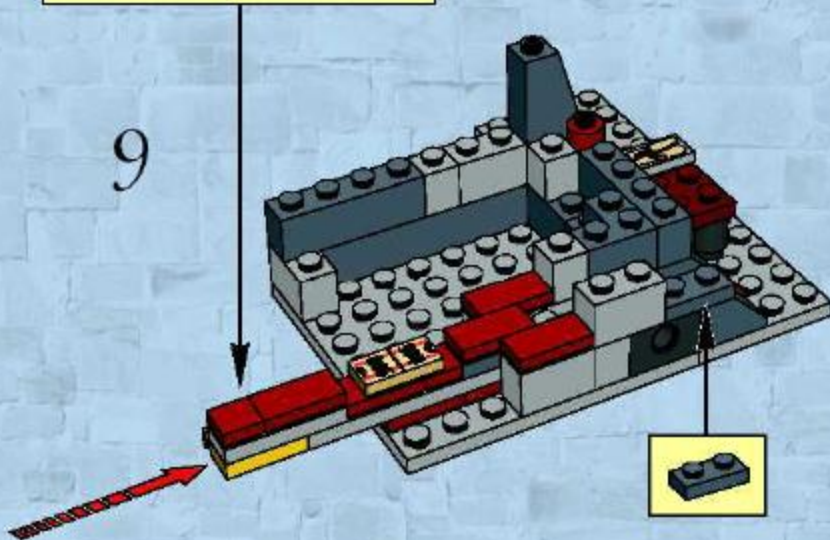
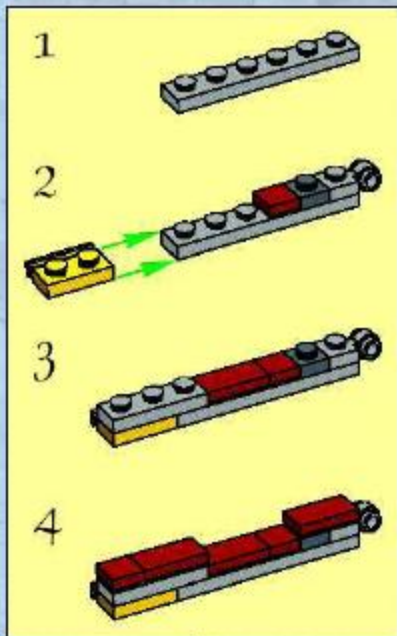

10

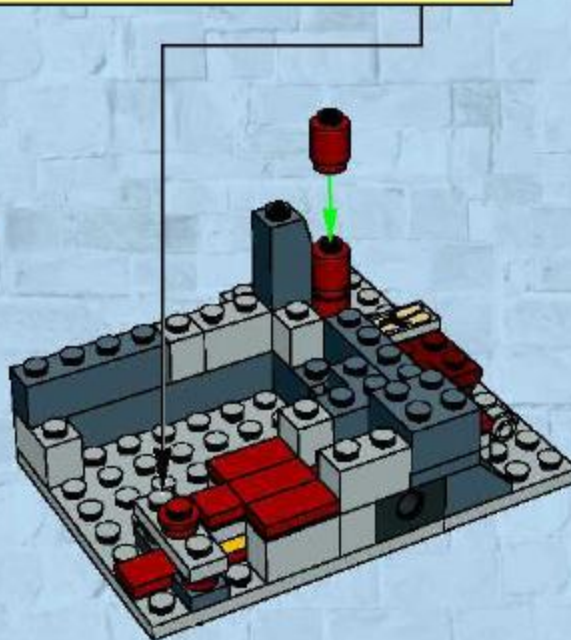

11

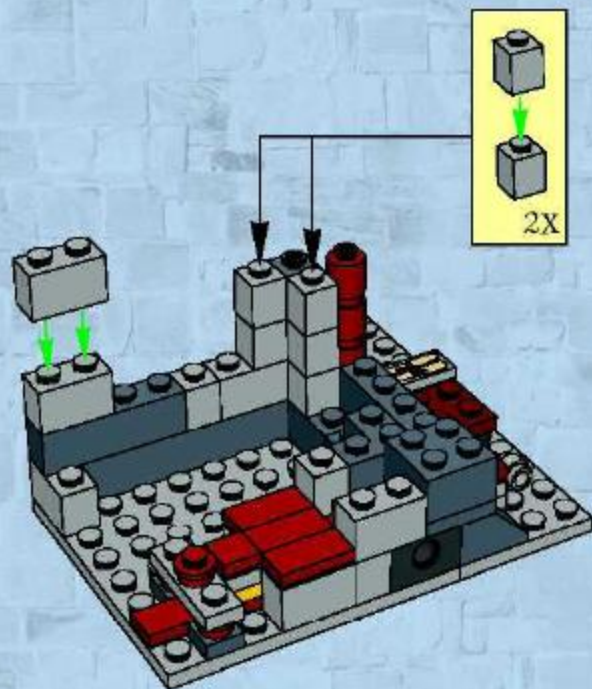

12

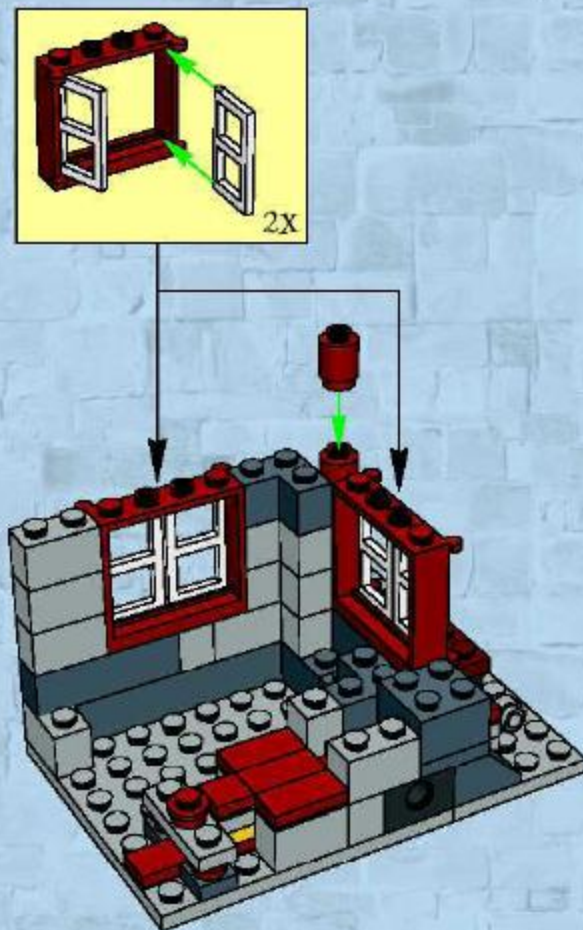

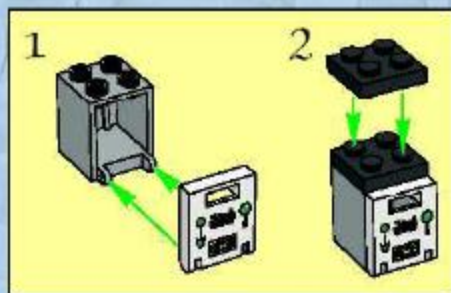

13

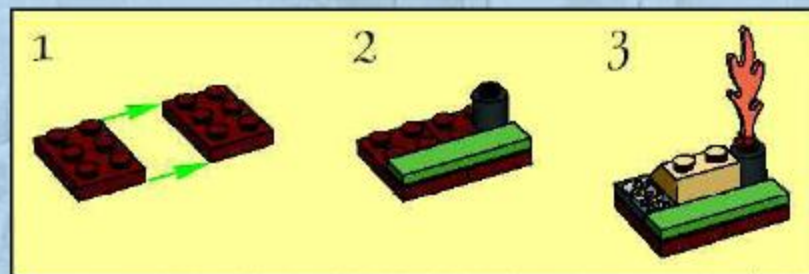
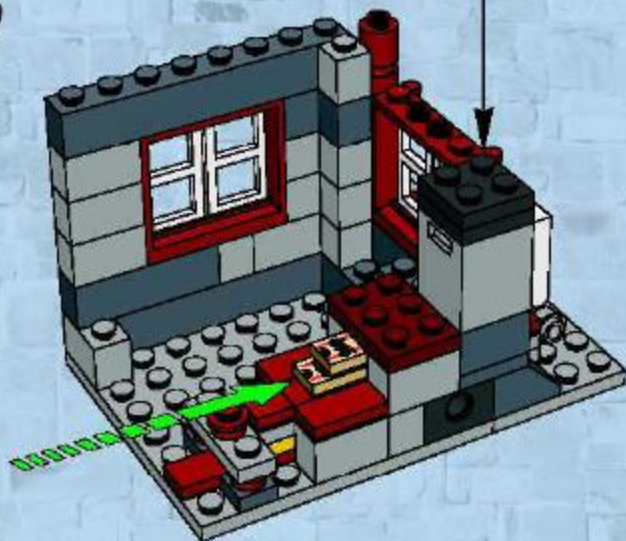

14



15



16



17

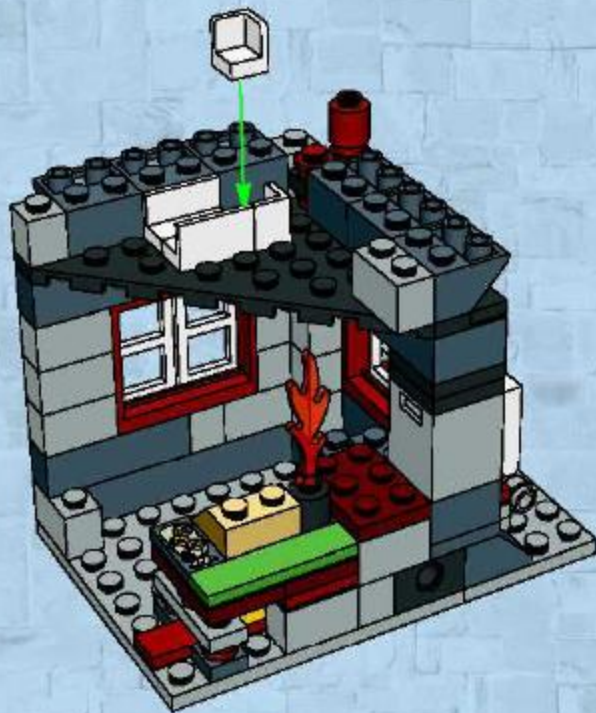

18

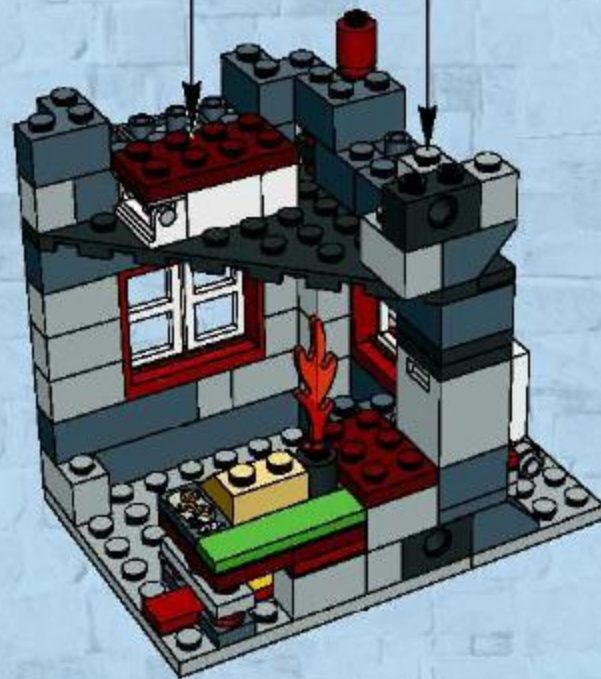
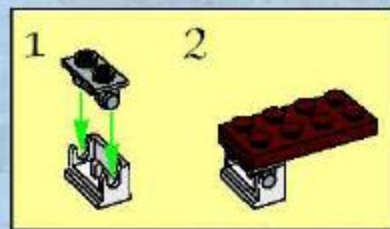

19

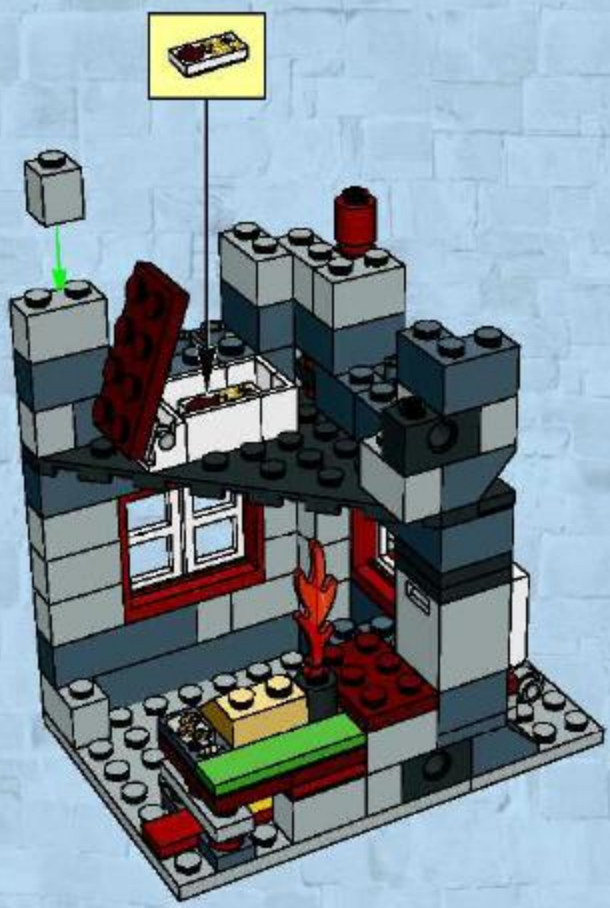

20

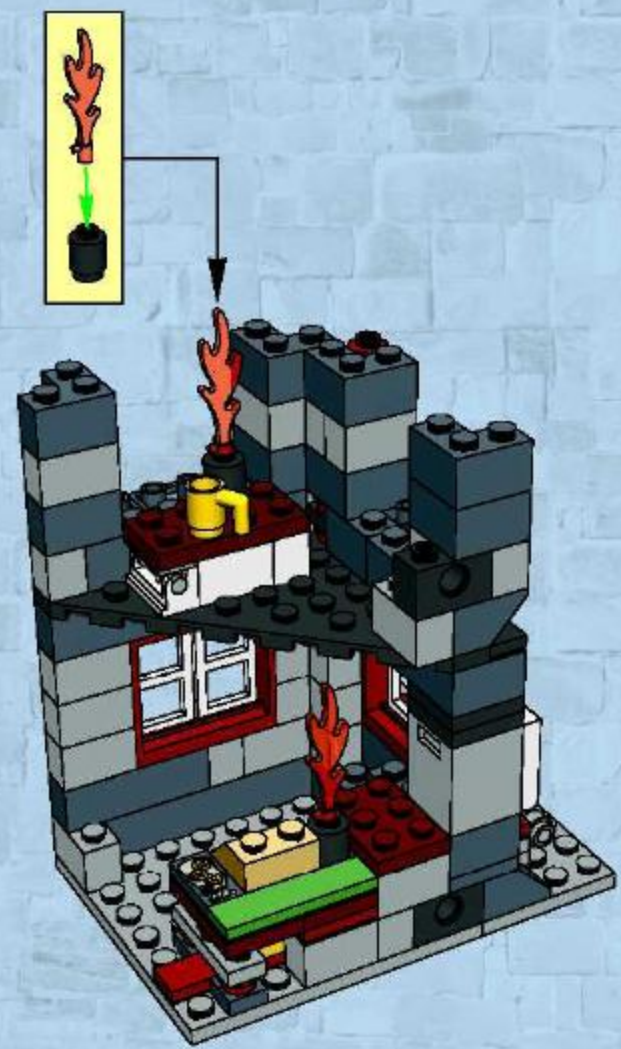

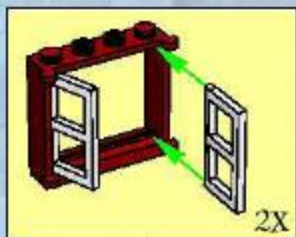

21

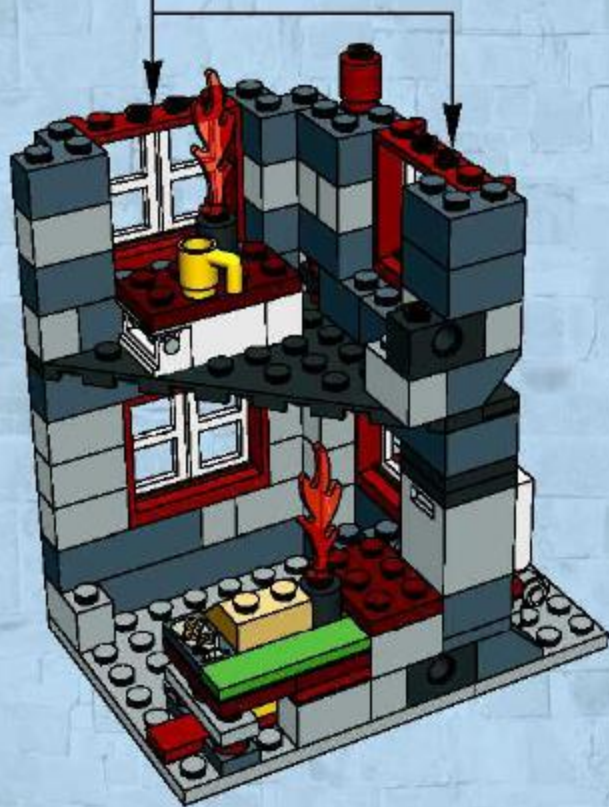

22

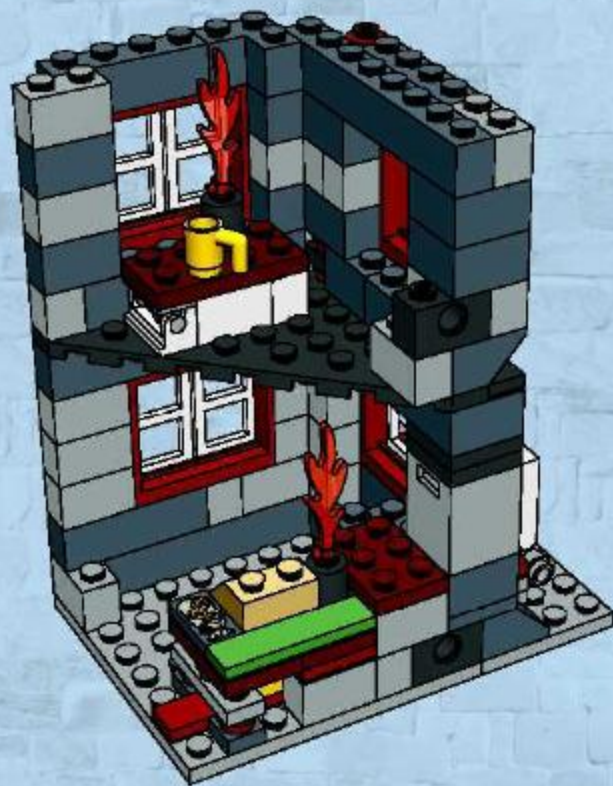

23

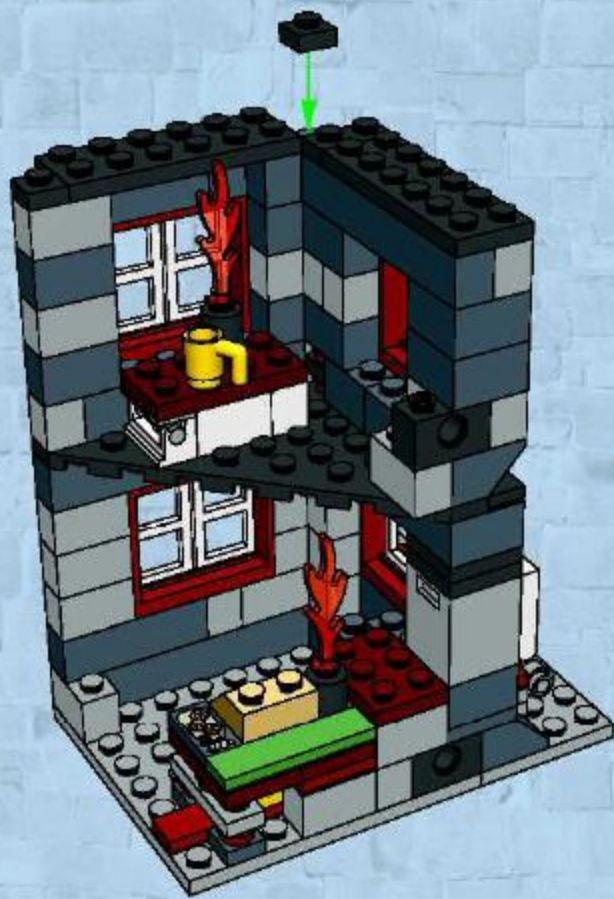

24

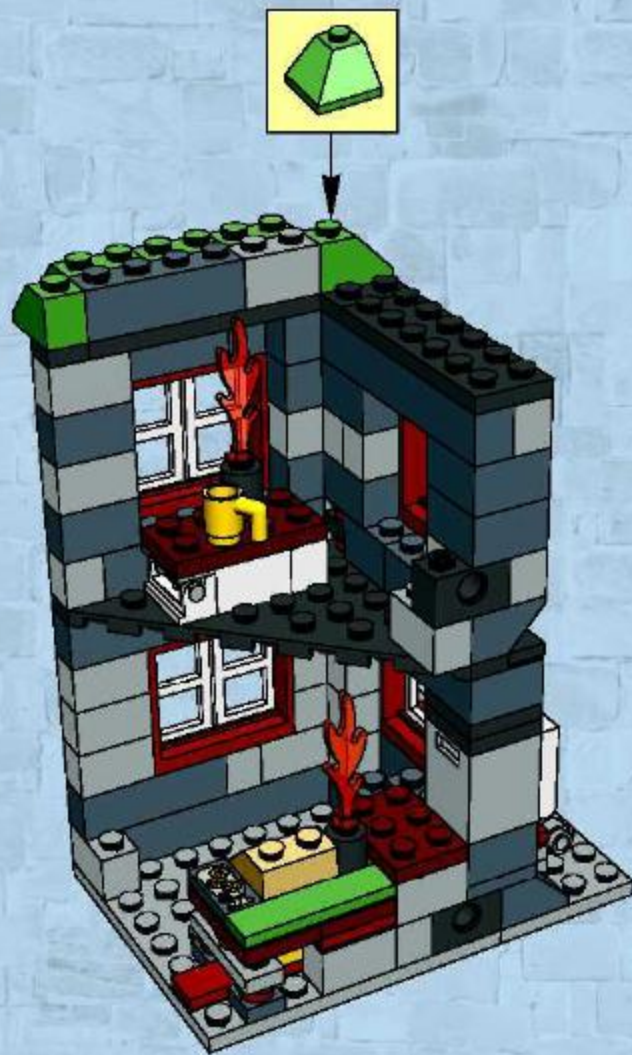

25

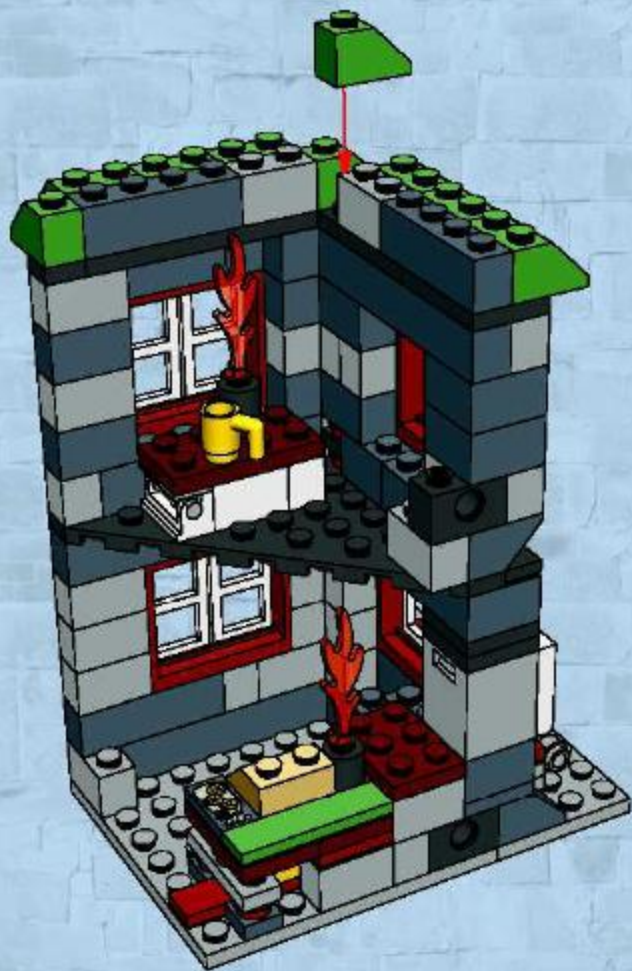

26

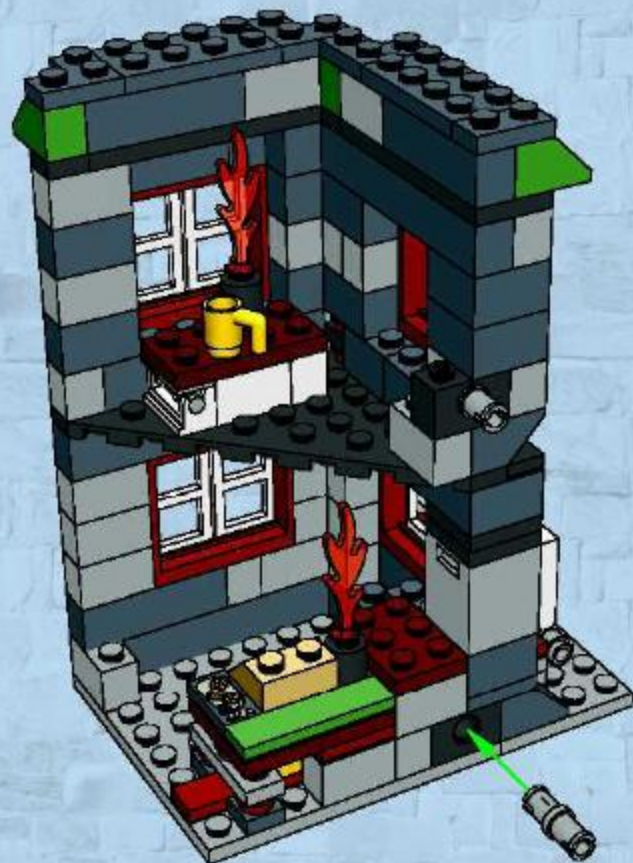

27

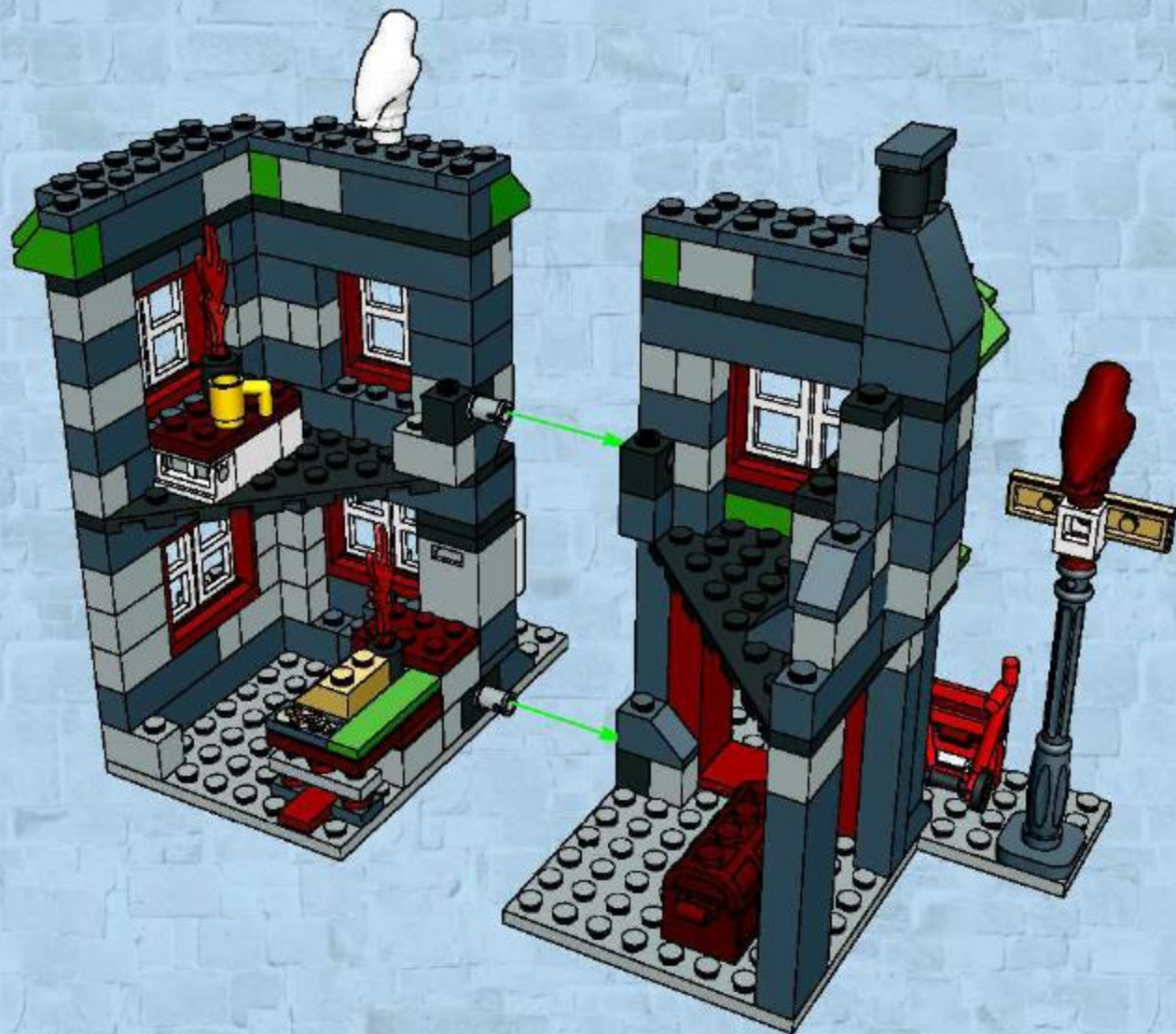

28

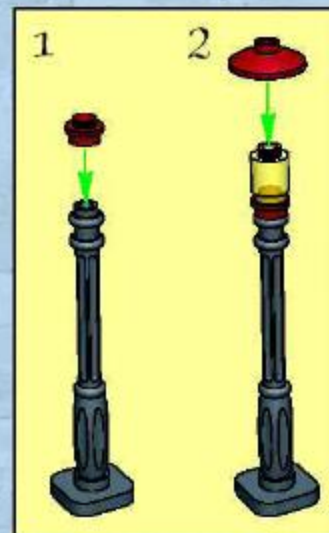







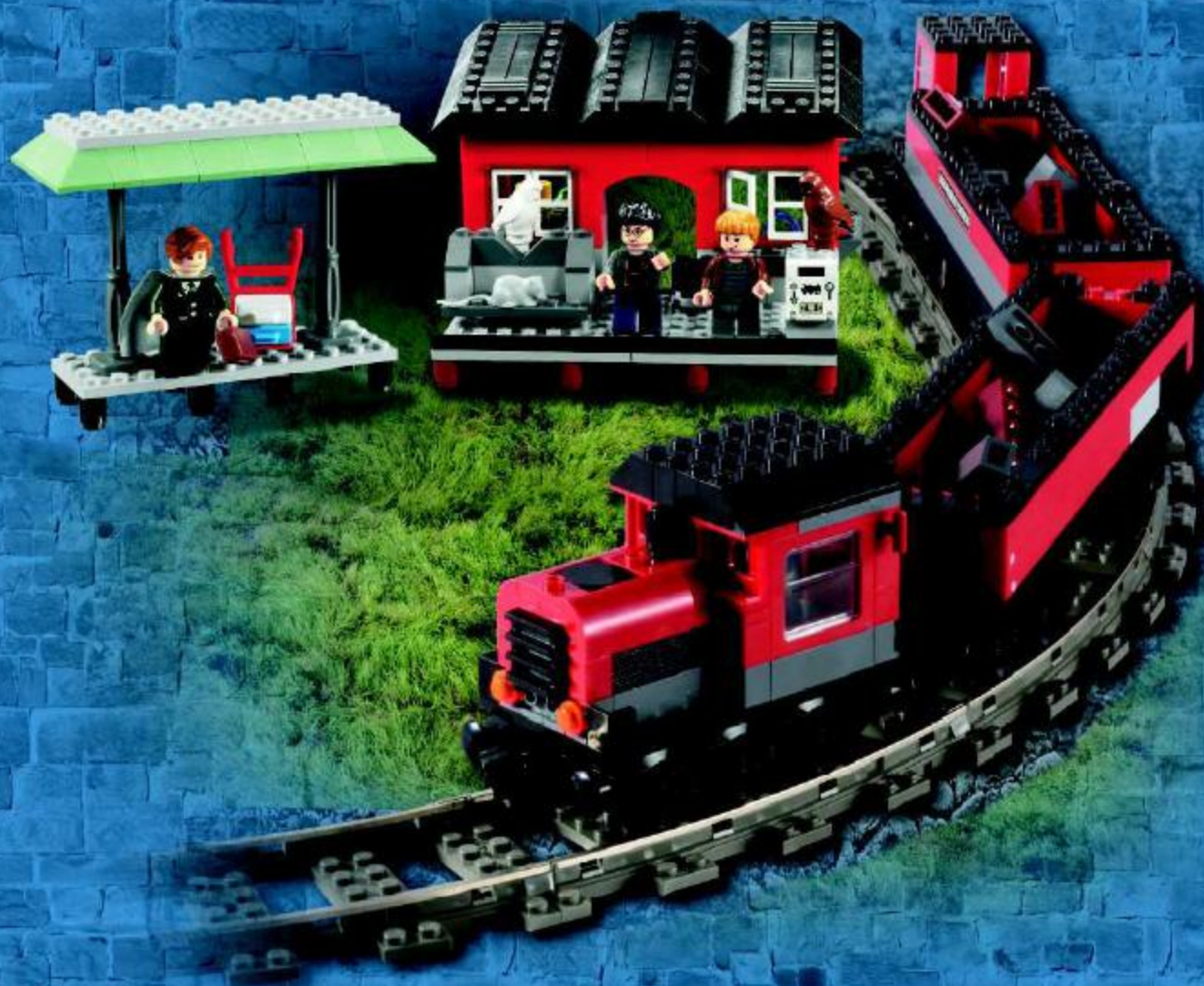

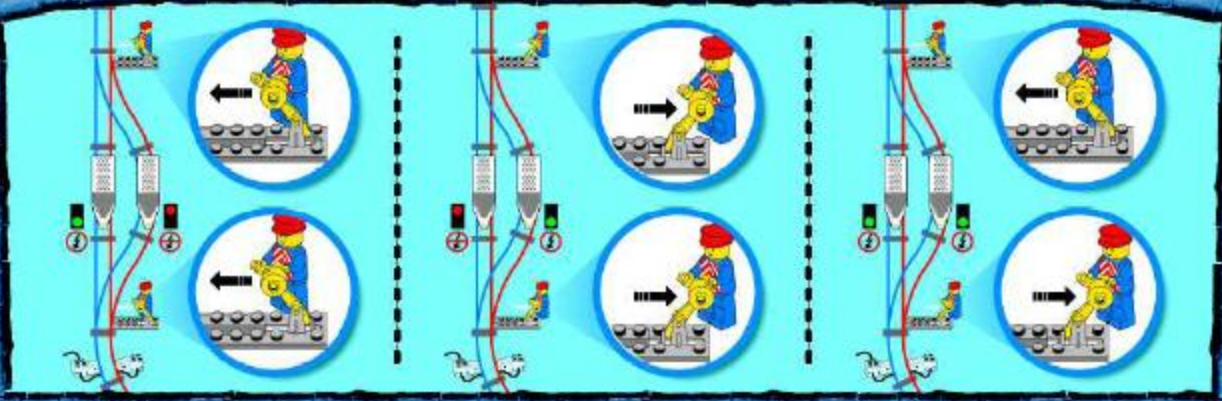
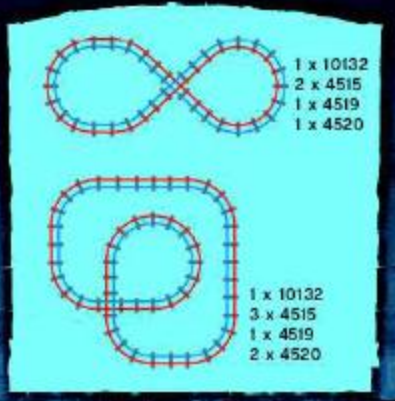
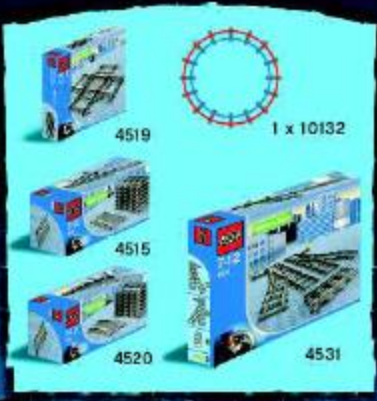



Harry Potter™

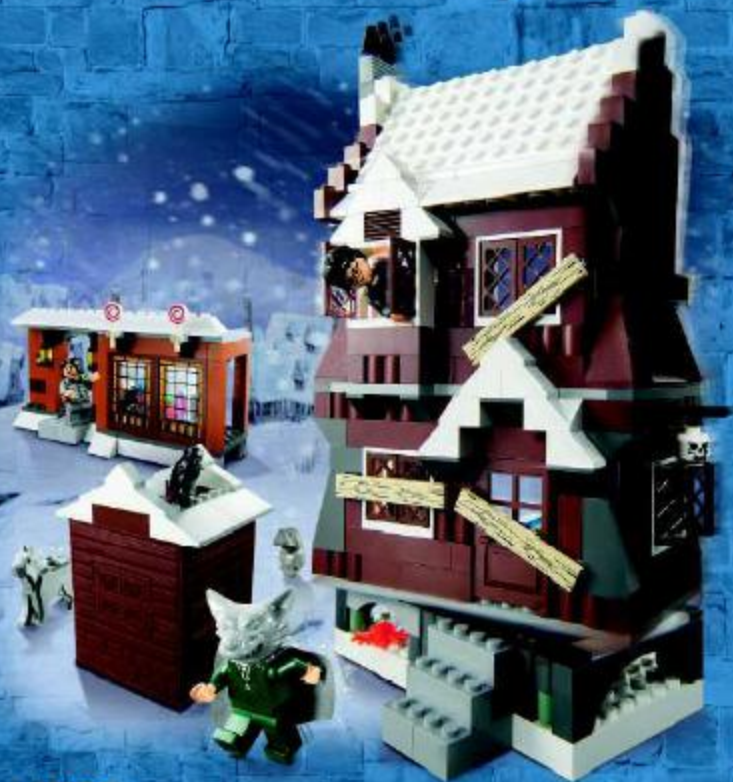

4756



4751



4757



4758



4750



4754



4753



4755



4752

Win! Gagne! Gewinne! 当たります



WIN LEGO® PRODUCTS

We would like to know what you think about your new LEGO® product. If you could help us by answering a few questions you are in with a chance of winning an exciting LEGO prize. It will only take you about 3 minutes! Log on to the web address below for further instructions.

We would really like to hear what you think about your new LEGO product. If you'd like to help us, go to the web address below for further instructions.



Estimado usuario LEGO®

Al contestar algunas preguntas en Inglés, francés, alemán o japonés, en el sitio www.acnielsen.aim.dk/lego, podrás participar en el sorteo de algunos valiosos premios LEGO®.



抽選でレゴ®製品が当たります

私たちは、皆さんが面白いおもいのレゴ®製品についてどんな感想をお持ちか、知りたいと思っています。質問に答えて、楽しいレゴ®製品の開発に参画しますが、アンケートの回答には、ほんの3分ほどしかかかりません！詳しくは、以下のウェブアドレスまでアクセスしてください。



GAGNE DES PRODUITS LEGO®

Nous aimerions savoir ce que tu penses de ton nouveau produit LEGO®. Si tu veux bien nous aider en répondant à quelques questions, tu recevras peut-être bientôt un fantastique prix LEGO. Et cela ne te prendra que 3 minutes environ ! Tu obtiendras davantage d'informations en visitant le site Internet indiqué ci-dessous.

Nous aimerions savoir ce que tu penses de ton nouveau produit LEGO. Si tu souhaites nous aider, rends-toi à l'adresse Internet ci-dessous où tu trouveras des instructions supplémentaires.



Caro Consumidor da LEGO®

Ao responder a algumas perguntas em Inglês, Francês, Alemão ou Japonês no endereço www.acnielsen.aim.dk/lego irá participar num concurso para ganhar valiosos prémios da LEGO®.



GEWINNE LEGO® PRODUKTE

Wir sind sehr an deiner Meinung über dein neues LEGO® Produkt interessiert. Wenn du uns den Gefallen tust und ein paar Fragen beantwortest, kannst du einen tollen LEGO Preis gewinnen. Das Ganze dauert nur etwa 3 Minuten! Gehe einfach zu der unten angegebenen Webadresse - dort findest du weitere Informationen.

Wir möchten gerne wissen, was Sie von Ihrem neuen LEGO Produkt halten. Wenn Sie uns helfen möchten, besuchen Sie bitte die u.a. Website, auf der Sie alles Weitere erfahren.



Kedves új LEGO® Vásárló

Ha ellátogat az www.acnielsen.aim.dk/lego honlapra és ott angol, francia, német vagy japán nyelven megválaszolsz néhány kérdést, akkor részt vehetsz egy versenyben, amelyben értékes LEGO® díjakat nyerhetsz.

www.acnielsen.aim.dk/LEGO





Harry Potter

ATTENTION - JOUET ÉLECTRIQUE

Non recommandé pour les enfants de moins de 8 ans. Comme avec tous les produits électriques, certaines précautions doivent être observées pendant la manipulation et l'utilisation pour éviter des secousses électriques. Utiliser seulement à l'intérieur.

PRECAUCIÓN - JUGUETE ELÉCTRICO

No se recomienda para niños menores de 8 años de edad. Como es el caso con todos los productos eléctricos, debieran tomarse precauciones durante su manejo y uso para evitar el choque eléctrico. Para uso exclusivamente bajo techo.

www.LEGO.com/harrypotter

HARRY POTTER, characters, names and related indicia are trademarks of and © Warner Bros. Entertainment Inc.
HARRY POTTER, les noms des personnages, leurs représentations et leurs insignes sont des propriétés et des marques de commerce de Warner Bros. Entertainment Inc.
Los personajes, nombres y temas relacionados con HARRY POTTER son marcas registradas de la Warner Bros. Entertainment Inc.

WB SHIELD: TM & © Warner Bros. Entertainment Inc.

Harry Potter Publishing Rights © J.K. Rowling. Droits de publication Harry Potter © J.K. Rowling. Harry Potter Derechos Reservados © J.K. Rowling.
(s04)

