

LEGO

Castle

7038



1

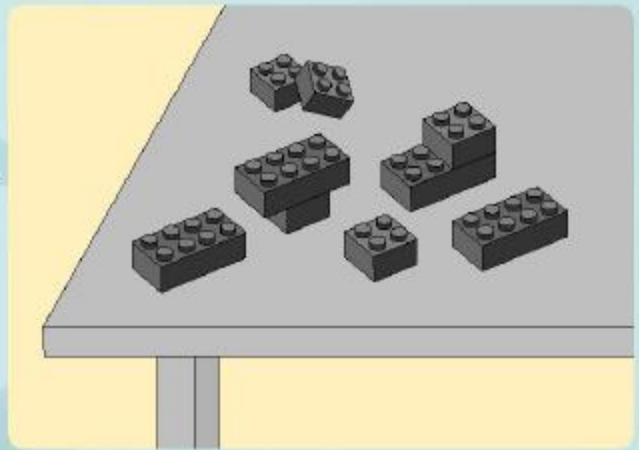
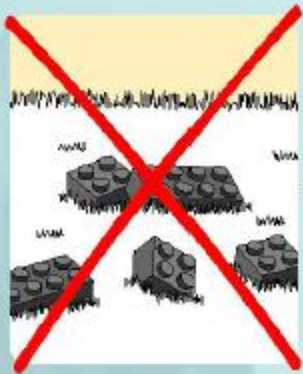

2

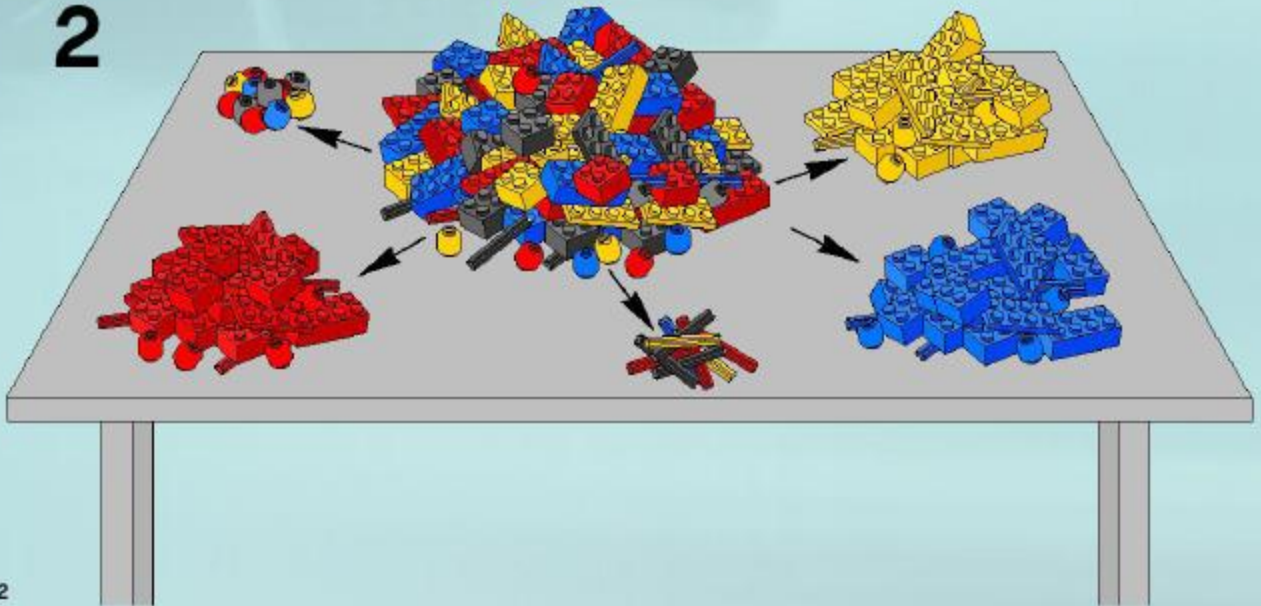

3

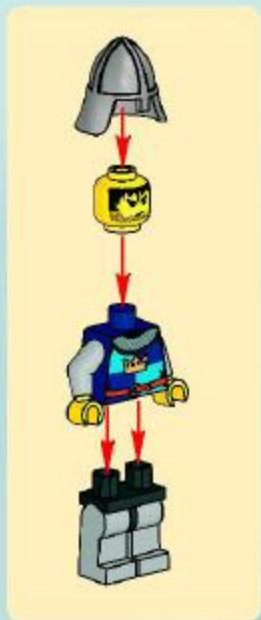



2

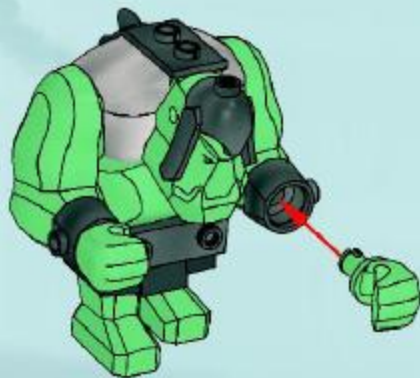

1

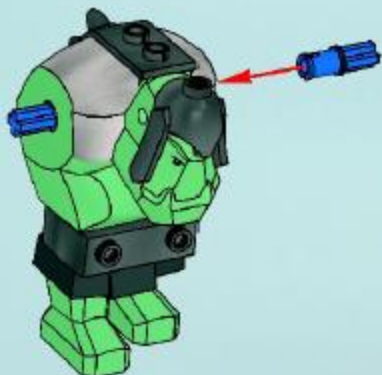

3



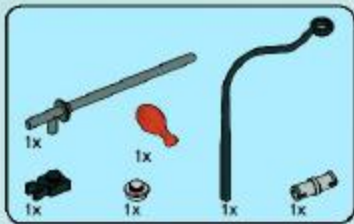

1



1

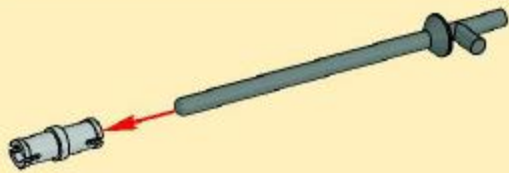

2

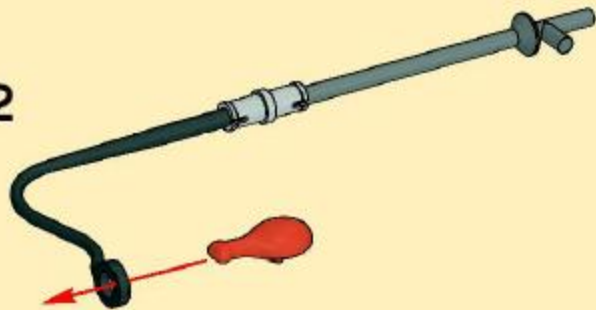

3

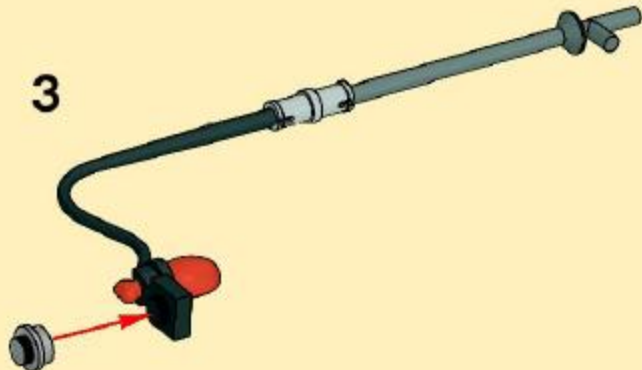

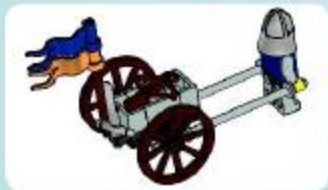

1



2

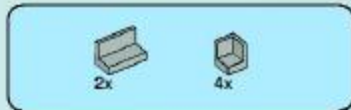
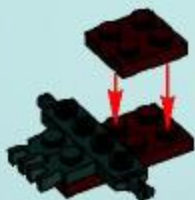

3



4





5

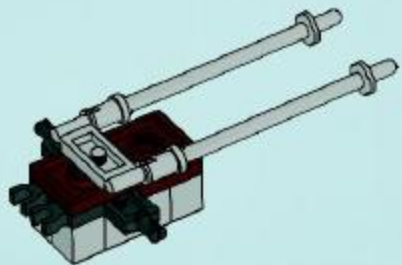

6

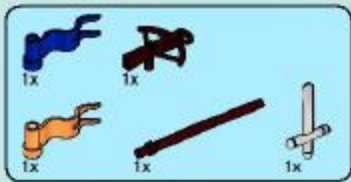
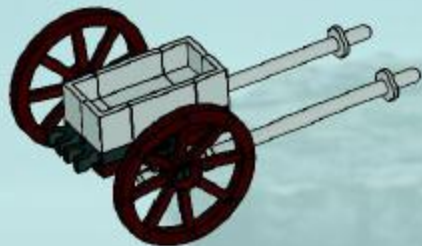

7

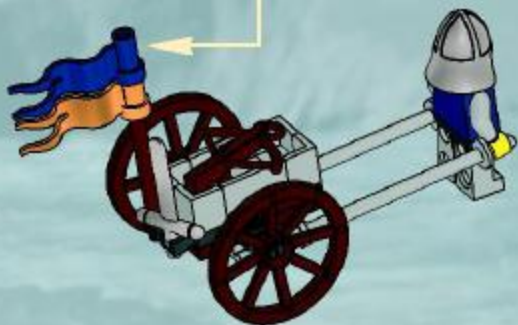
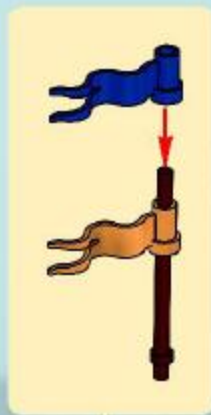



2x

1





2



3





1

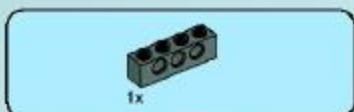

2



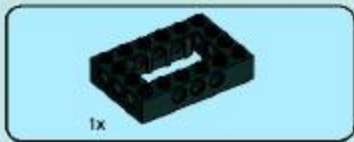

3

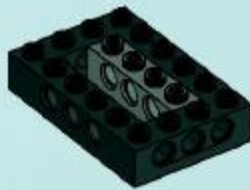

4





1x

5



2x

6

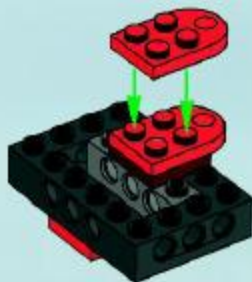



7

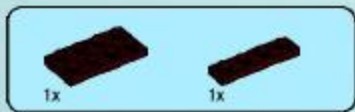

8





4x

9



2x

10





11

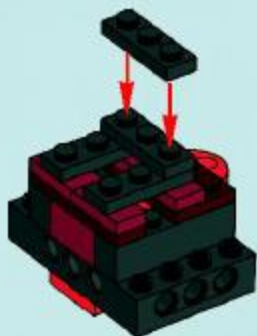

12



13

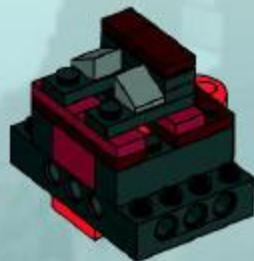



14

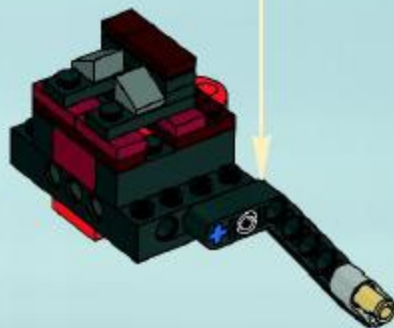
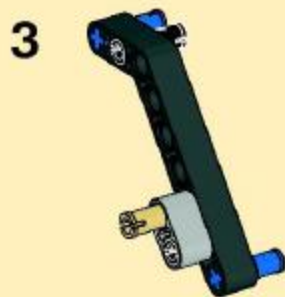
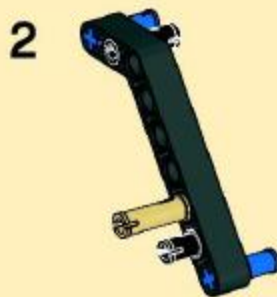
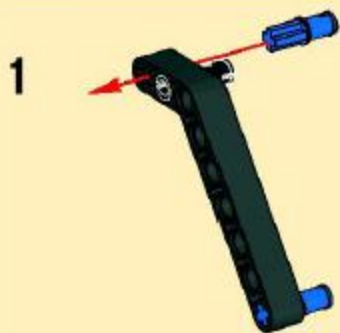

15



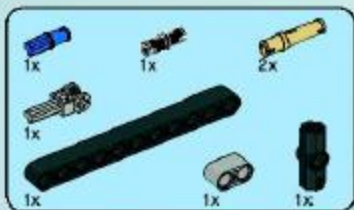

16

1

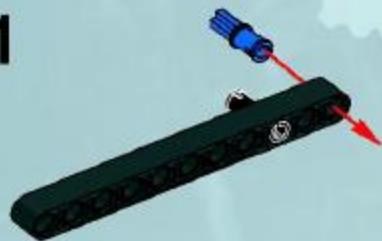

2



3



4

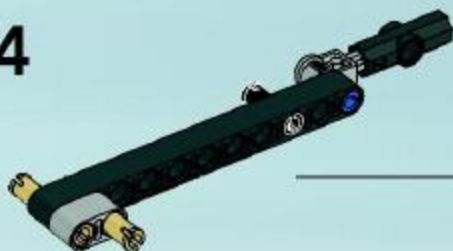



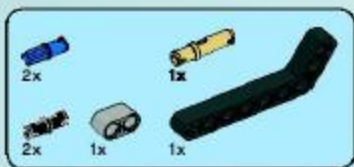

17

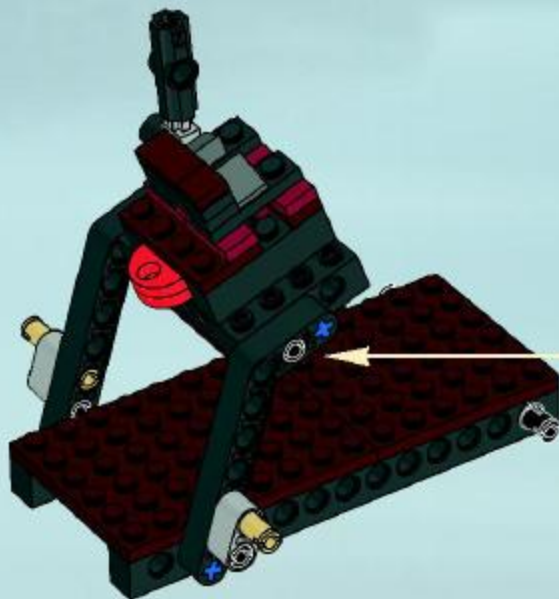
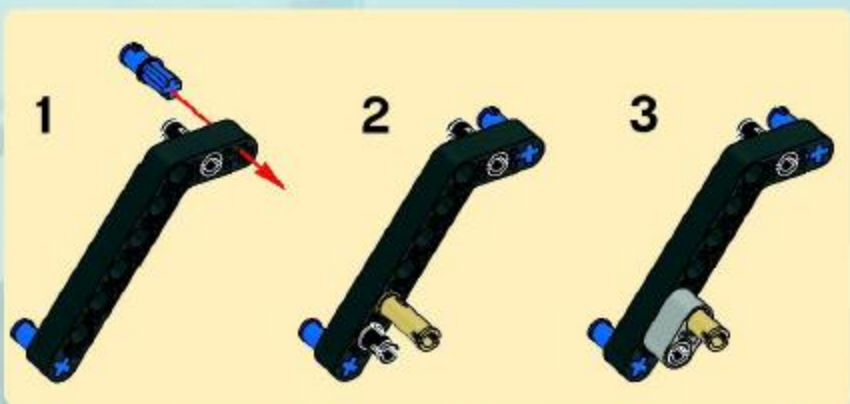

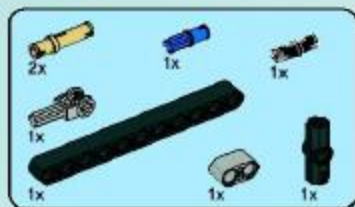

18

1



2



3



4

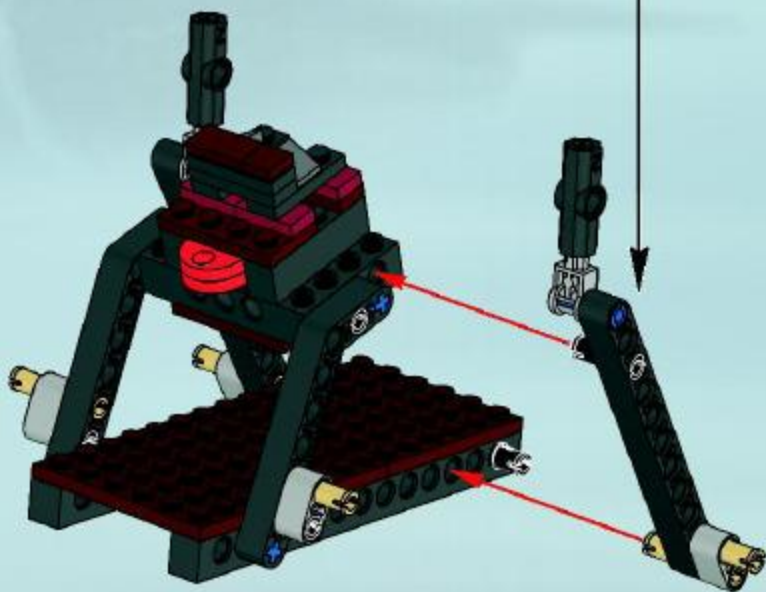



19





20

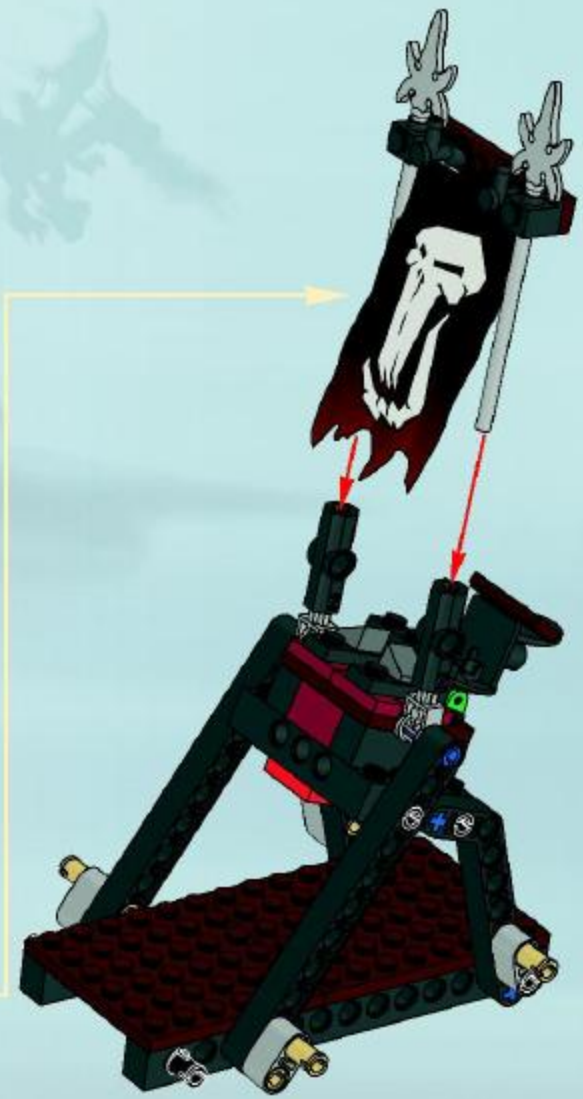
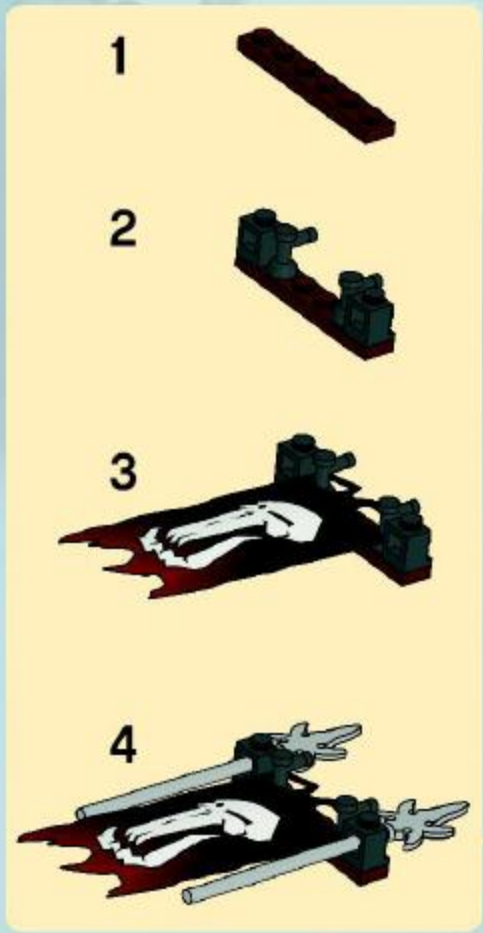



21

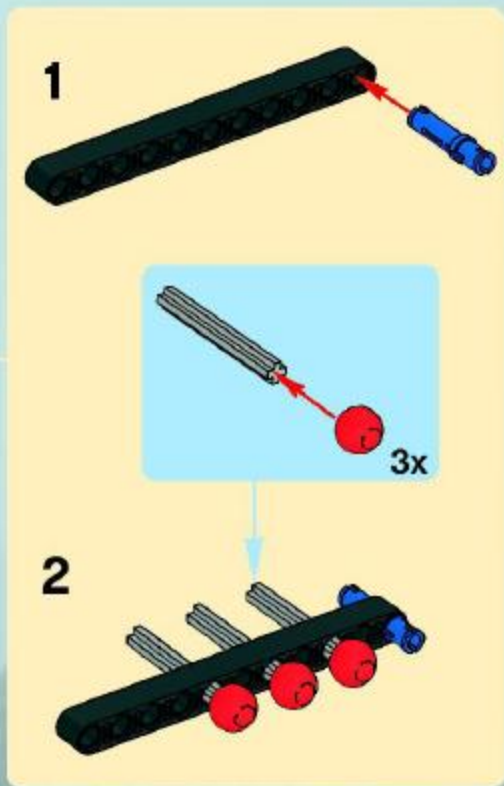
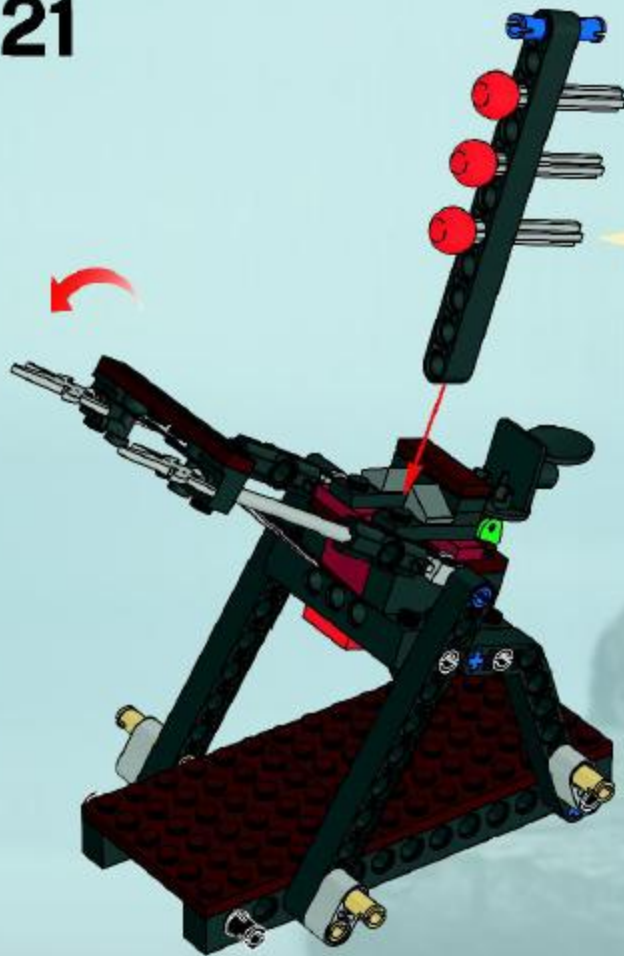



1



2



3



4





2x



2x

5



1x

6



4x



4x

7

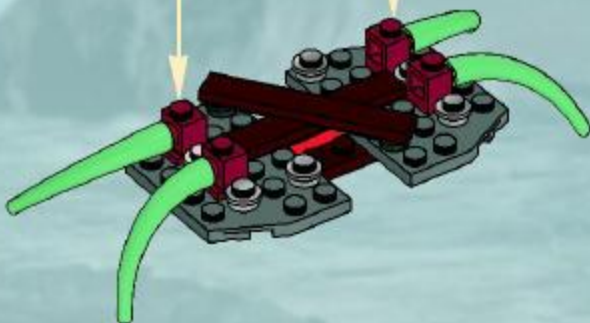
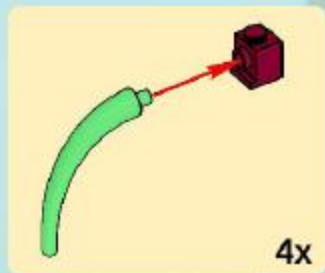



2x

8

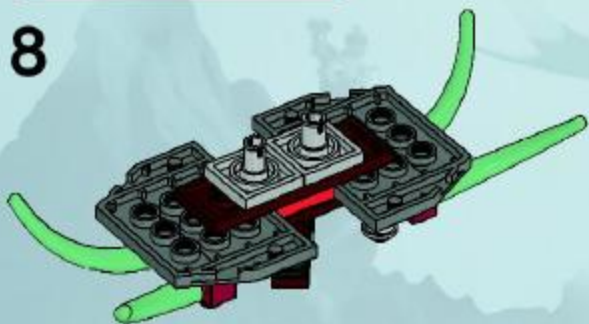



22





23



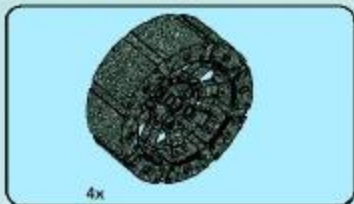

24





Customer Service
Kundenservice
Service Consommateurs
Servicio Al Consumidor

www.lego.com/service or dial



: 00800 5346 5555

: 1-800-422-5346





7094



7048



7040



7038



7037



club™



FREE LEGO Magazine • GRATUIT • GRATIS LEGO Magazin

Join Today!

**Abonne-toi
dès aujourd'hui !**

Meld je nu aan!

Jetzt anmelden!



  US & Canada only

1-866-534-6258 / 1-877-518-5346

(M.F. 00000)



00800 5346 5555

www.LEGOclub.com

**VISIT THE WORLD'S
BIGGEST LEGO® SHOP!
www.LEGOshop.com**

www.acnielsen.aim.dk/LEGO



WIN LEGO® PRODUCTS

No purchase necessary.
Open to residents of all countries where
not prohibited.
Go to www. for official rules and details.

WIN LEGO® PRODUCTEN

Kopen niet nodig.
Open voor alle leeftijden, en in alle landen
waar geen verbod geldt.
Ga naar www. voor officiële regels en details.

GEWINNE LEGO® PRODUKTE

Die Teilnahme am Gewinnspiel führt zu
keinerlei Kaufverpflichtungen.
Sie können in allen nicht ausgeschlossenen
Ländern teilnehmen.
Die offiziellen Regeln und nähere Informationen
finden Sie unter www.

GAGNE DES PRODUITS LEGO®

Aucun achat n'est nécessaire.
Ouvert à tous les âges et aux résidents de
tous les pays, sauf en cas d'interdiction.
Rendez-vous sur www. pour obtenir plus
de détails et le règlement officiel.

レゴ®製品を「当てよう」

購入は不要です。
禁止されていない限り、あらゆる
年代およびあらゆる国の居住者の
方々にご利用いただけます。
公認規則および詳細につきましては、
www.をご覧ください。

