



AGENTS

8636



1

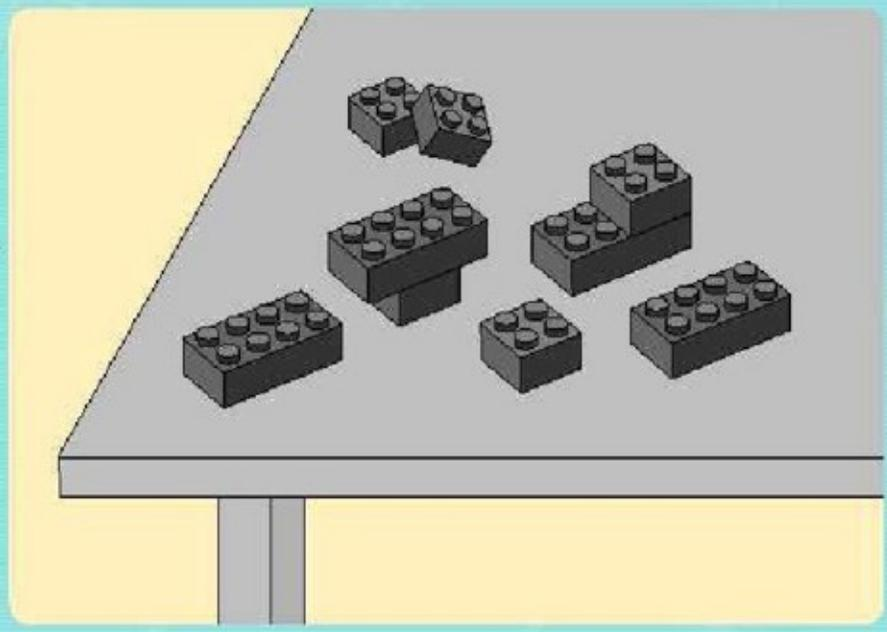

2





3



4

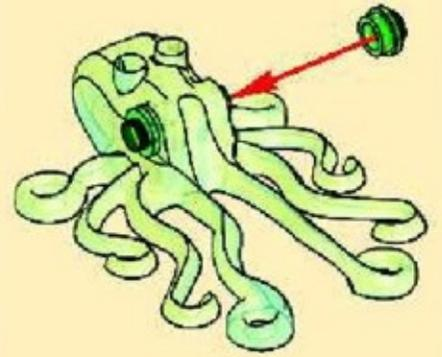

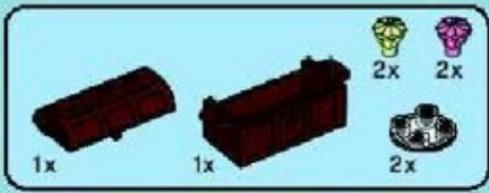

1

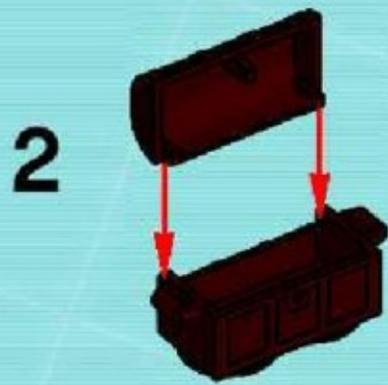
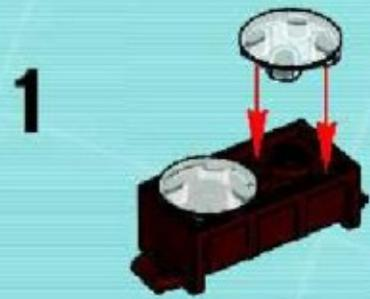

3



4





1



2

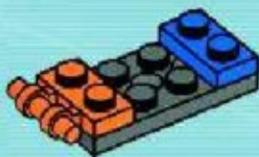

3

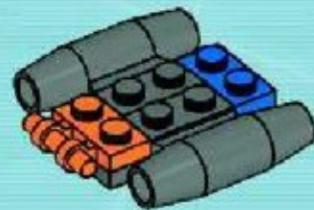

4





2x

5

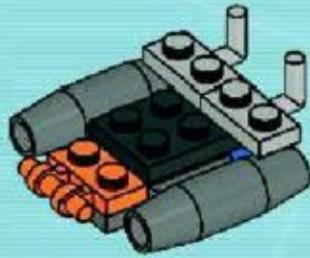

1x

6

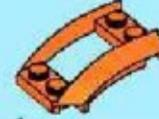
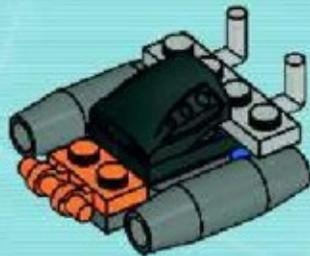

1x

7

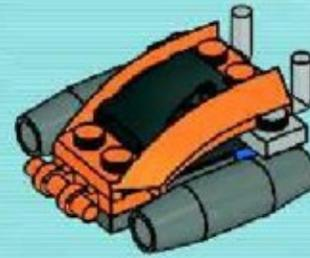

1x

8

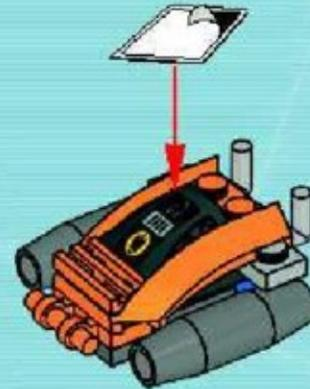

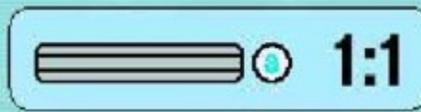
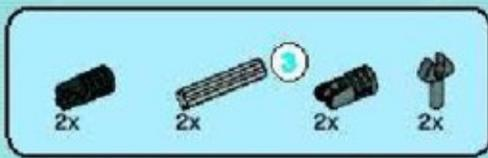

9

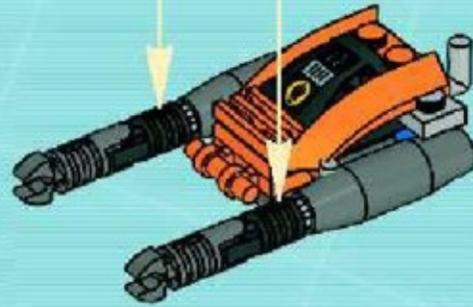
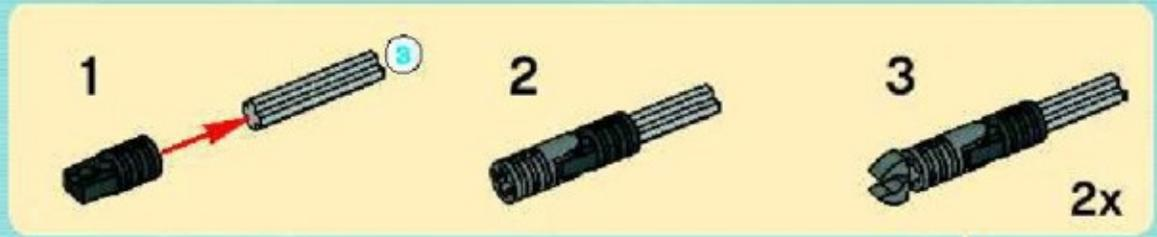

10

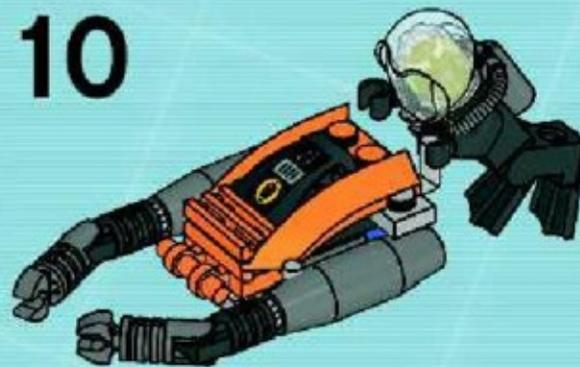



1



2

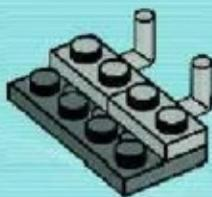

3

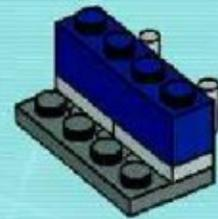

4

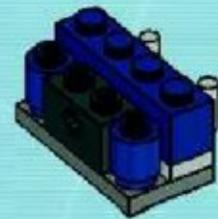



9  1:1

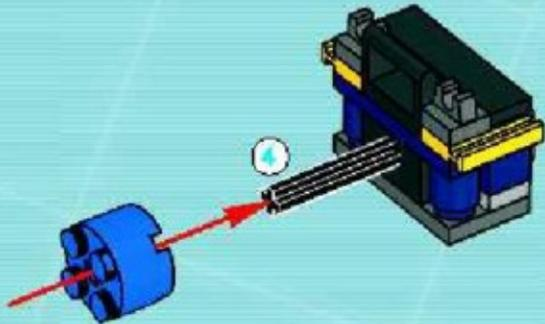

10

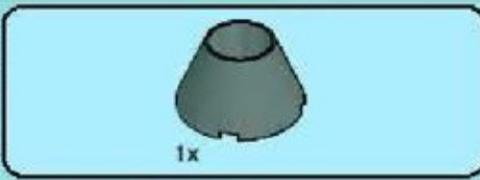
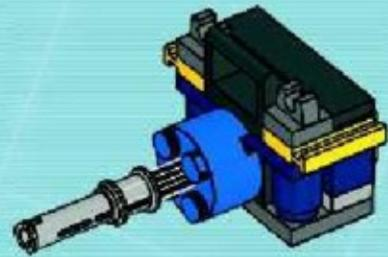

11

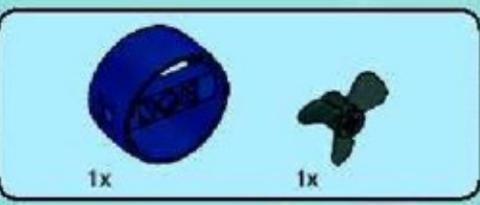
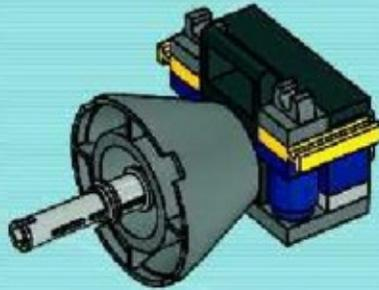

12

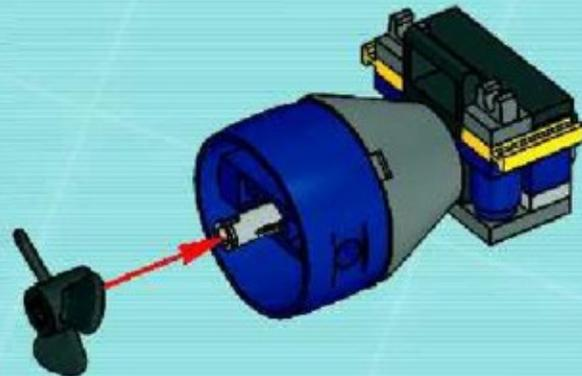



13



14

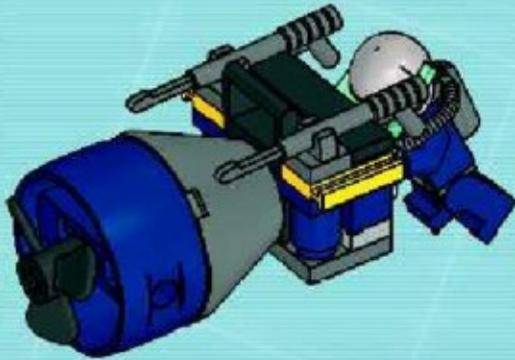

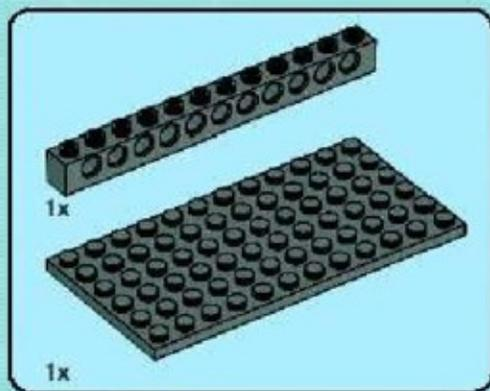

1

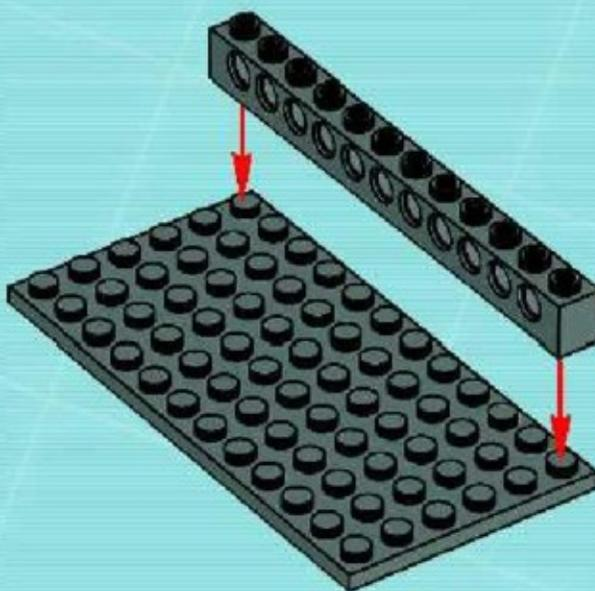



2

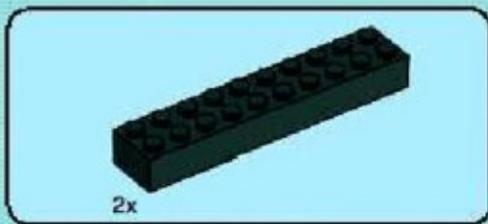
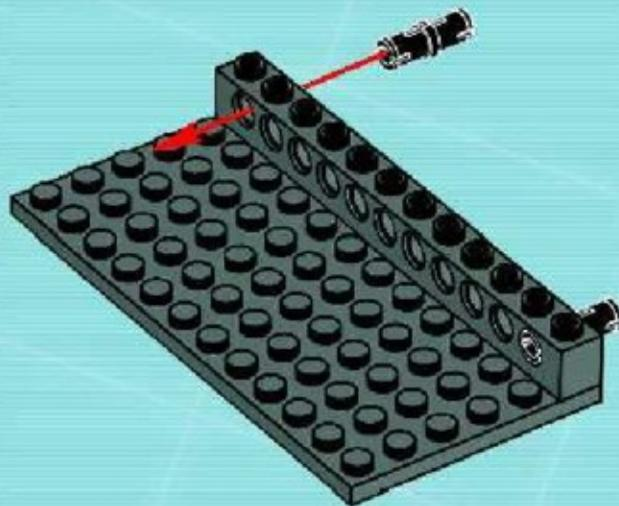

3

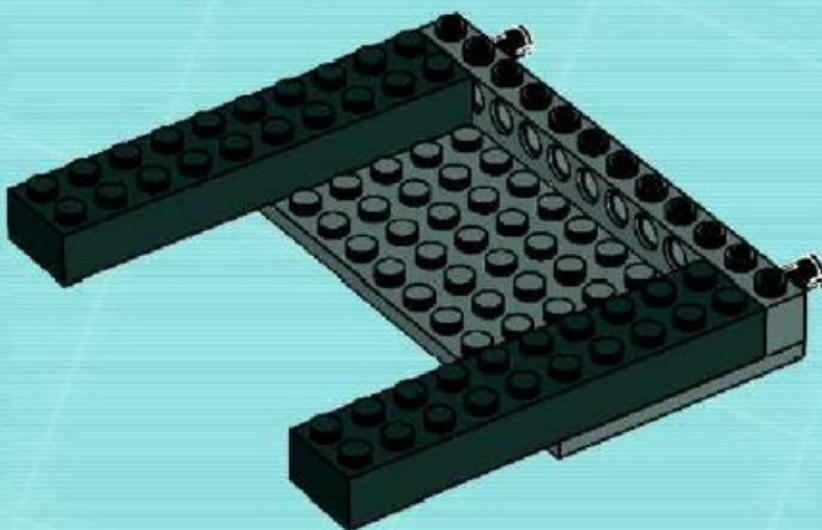

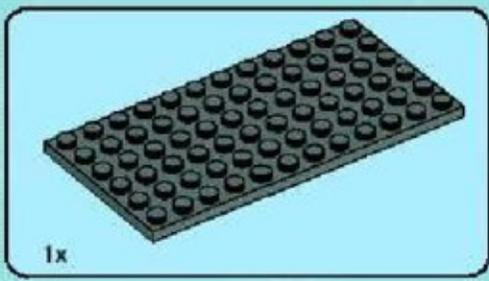

4

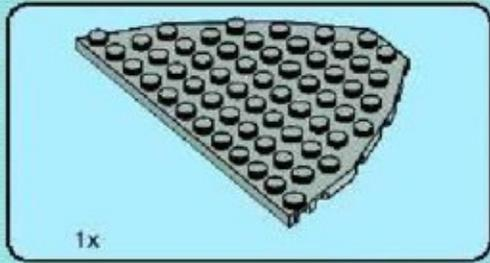
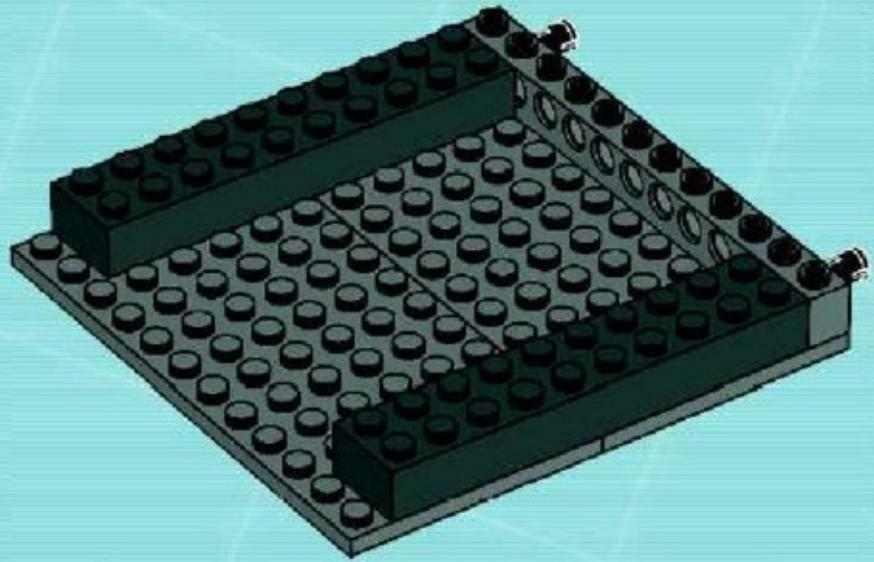

5

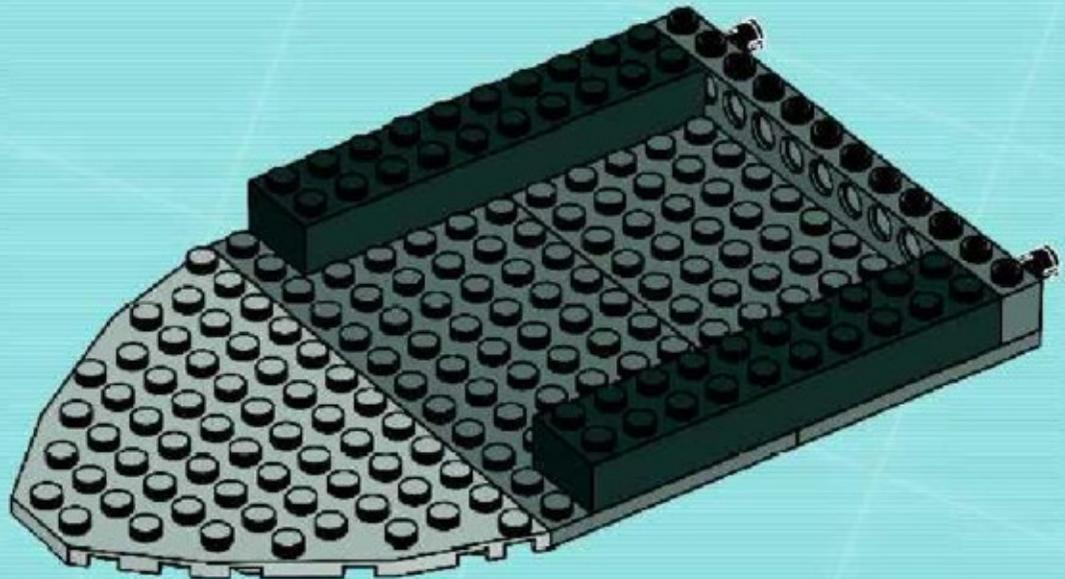



6

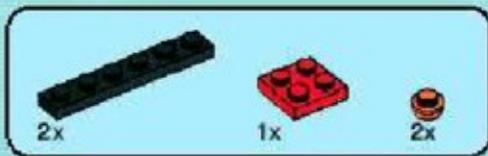

7





10x

8



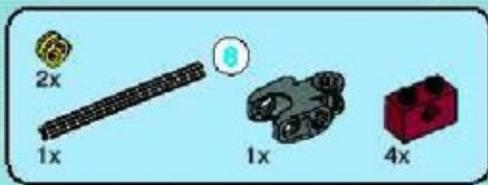

9

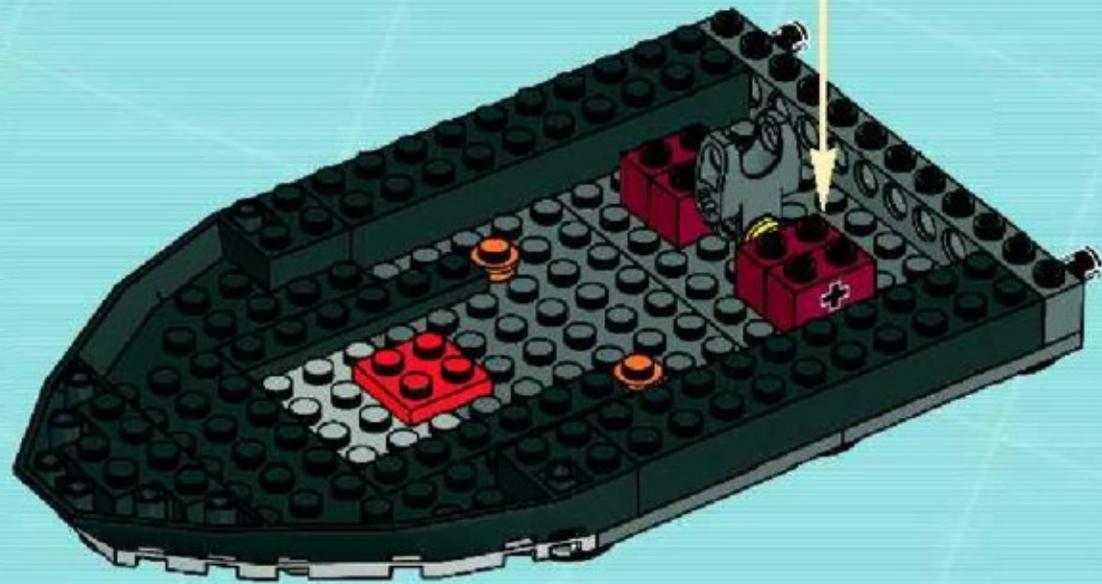
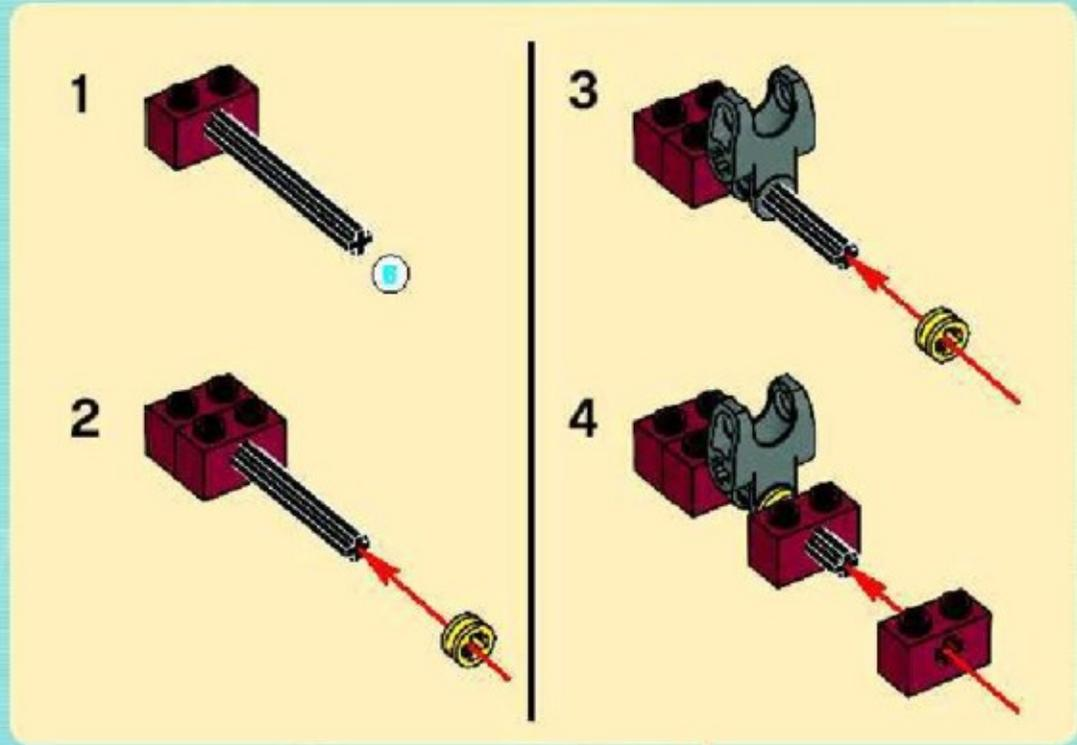

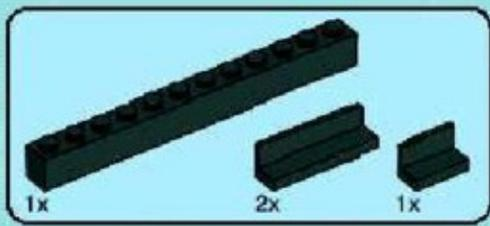

10



11



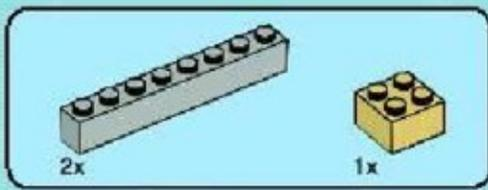

12

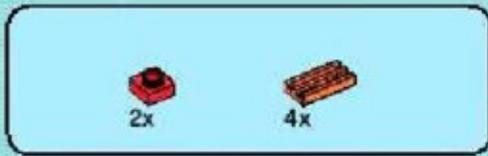
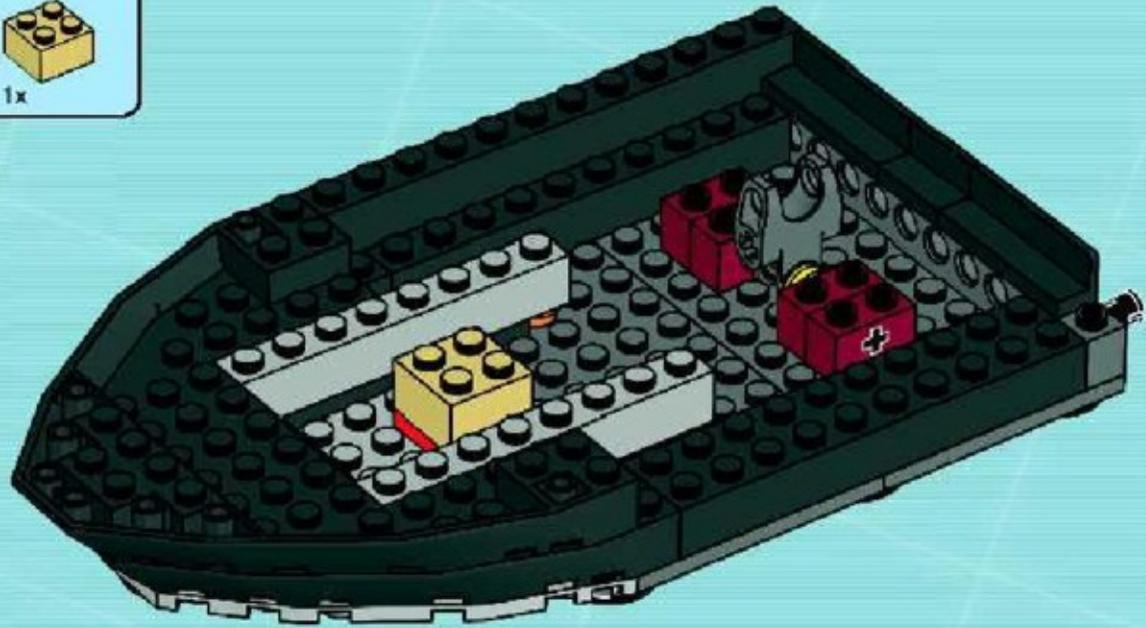

13

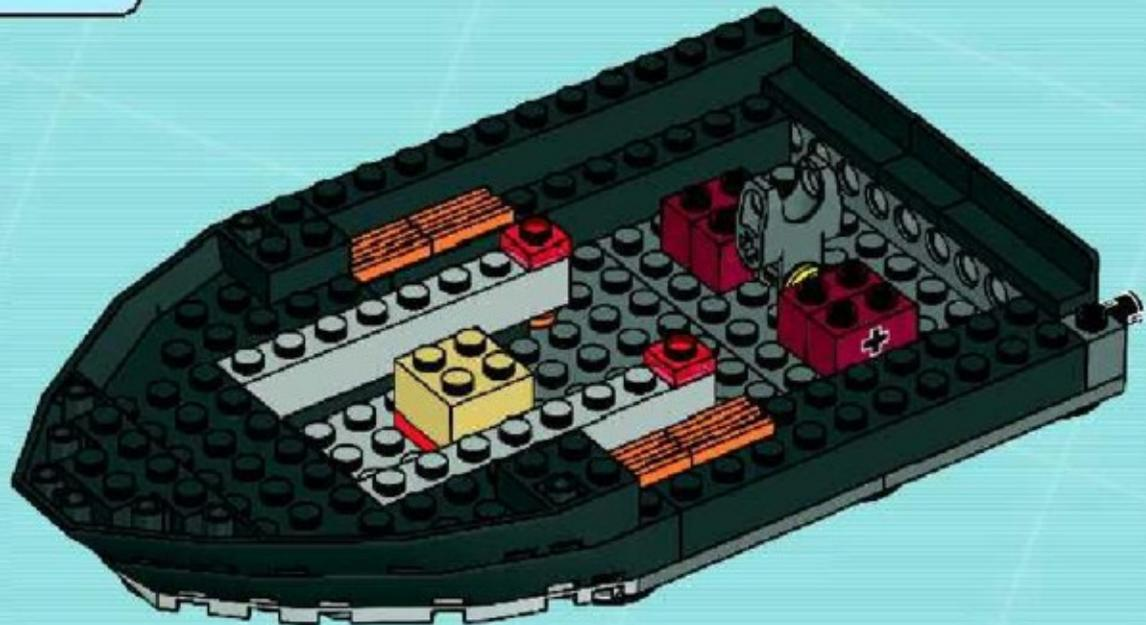

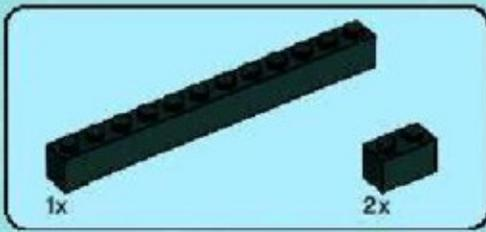

14

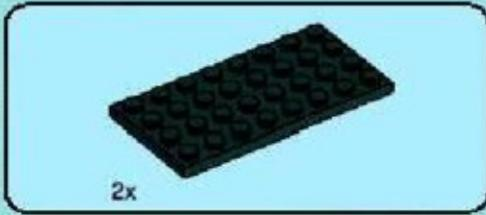
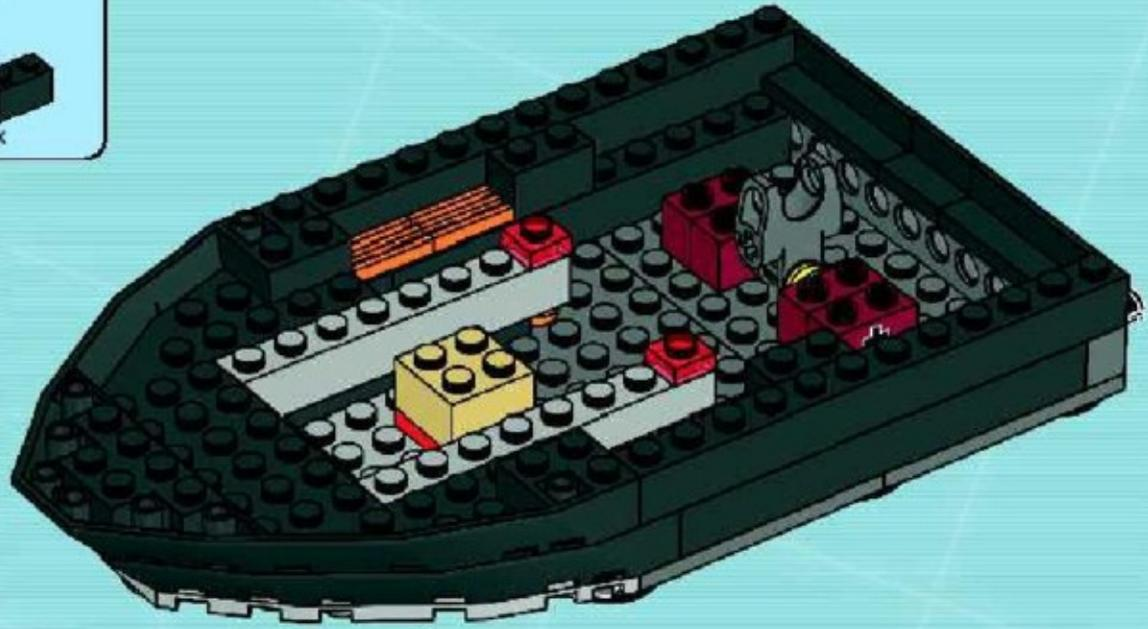

15

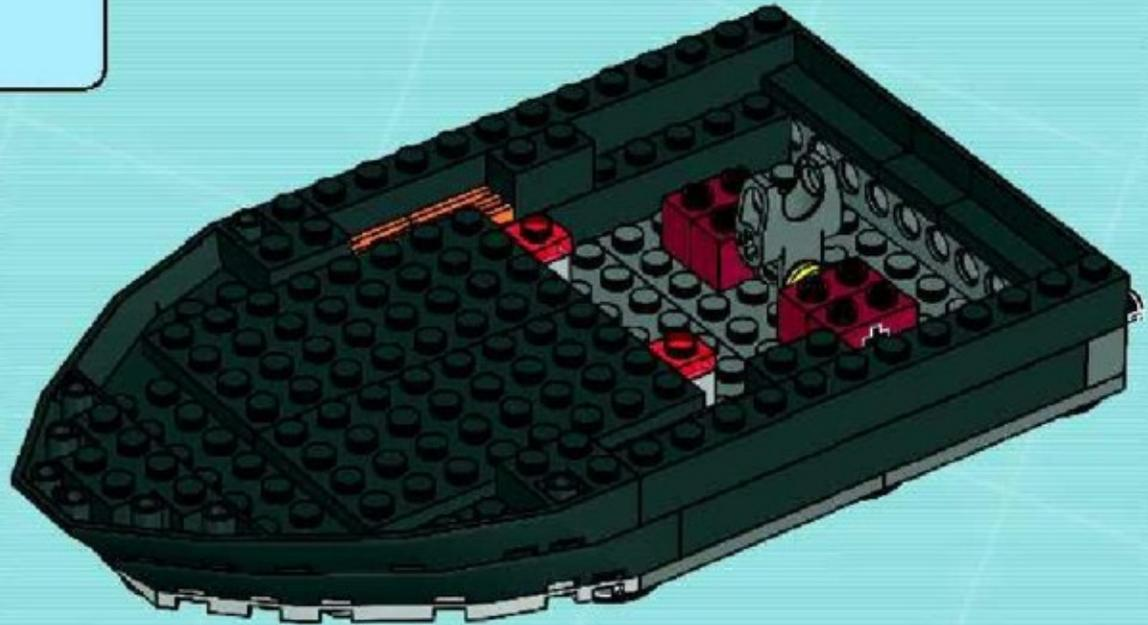



16

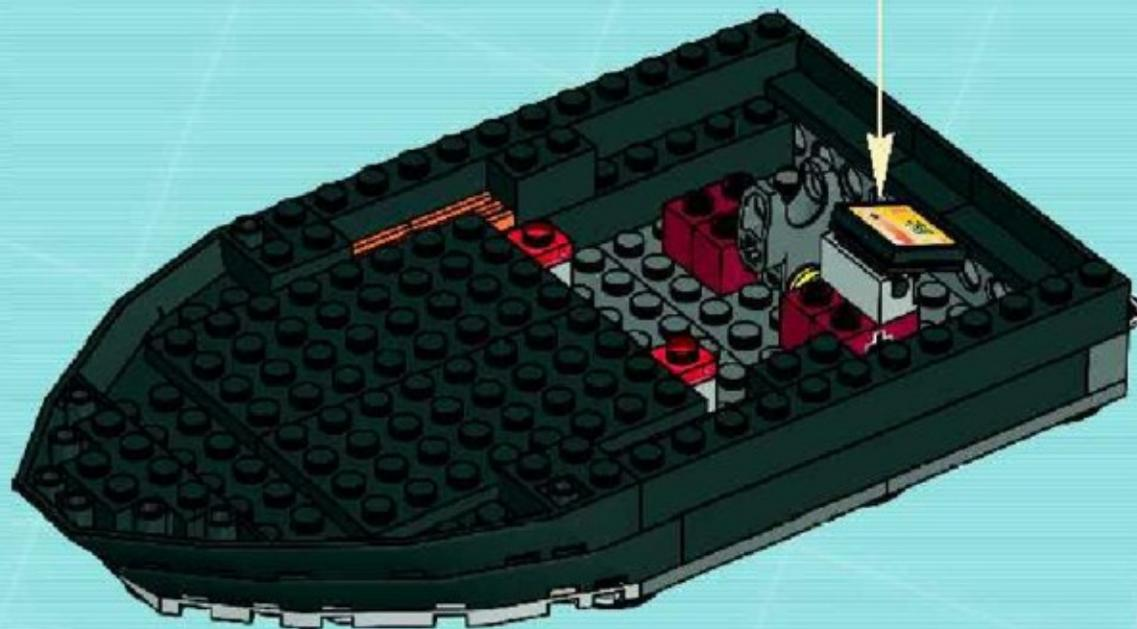
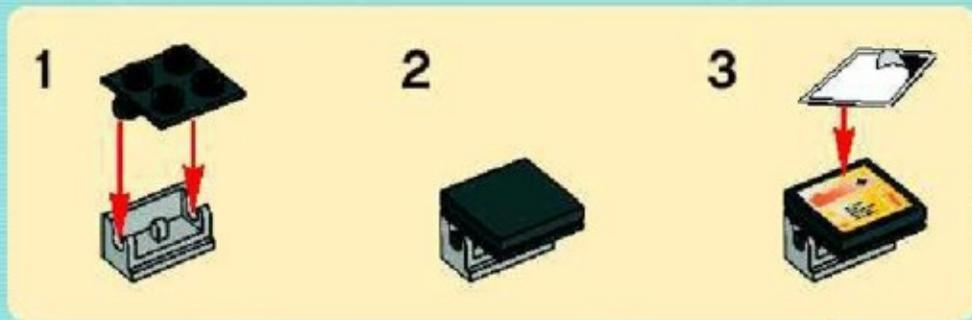



17

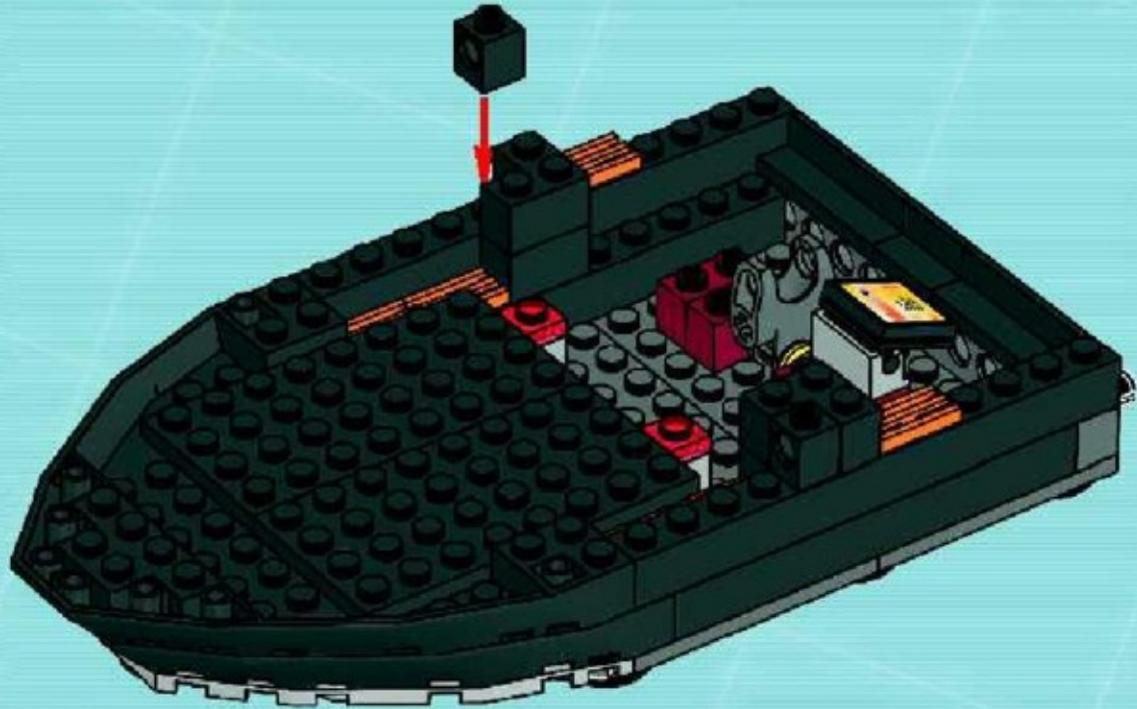

18

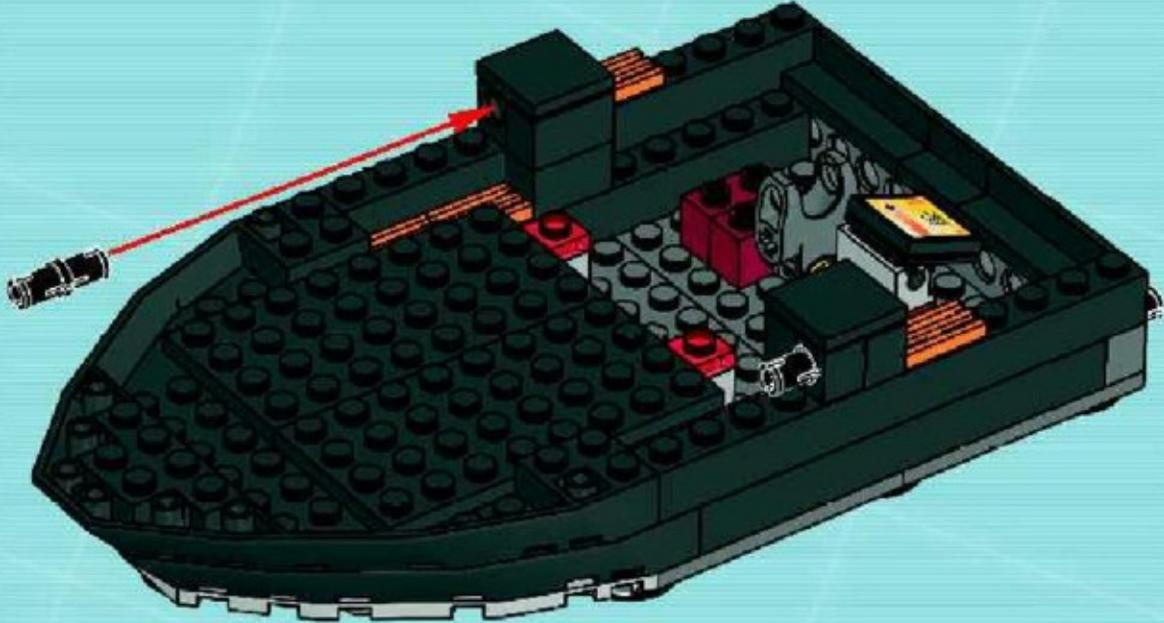



19

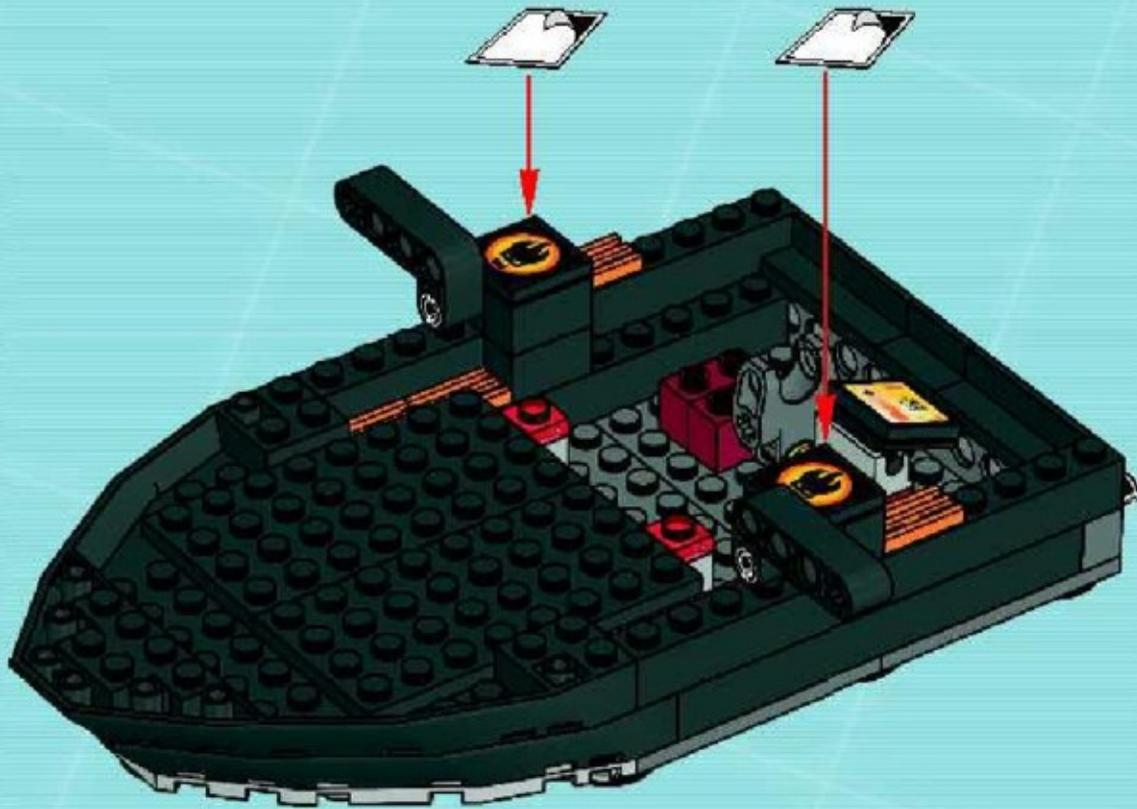



20

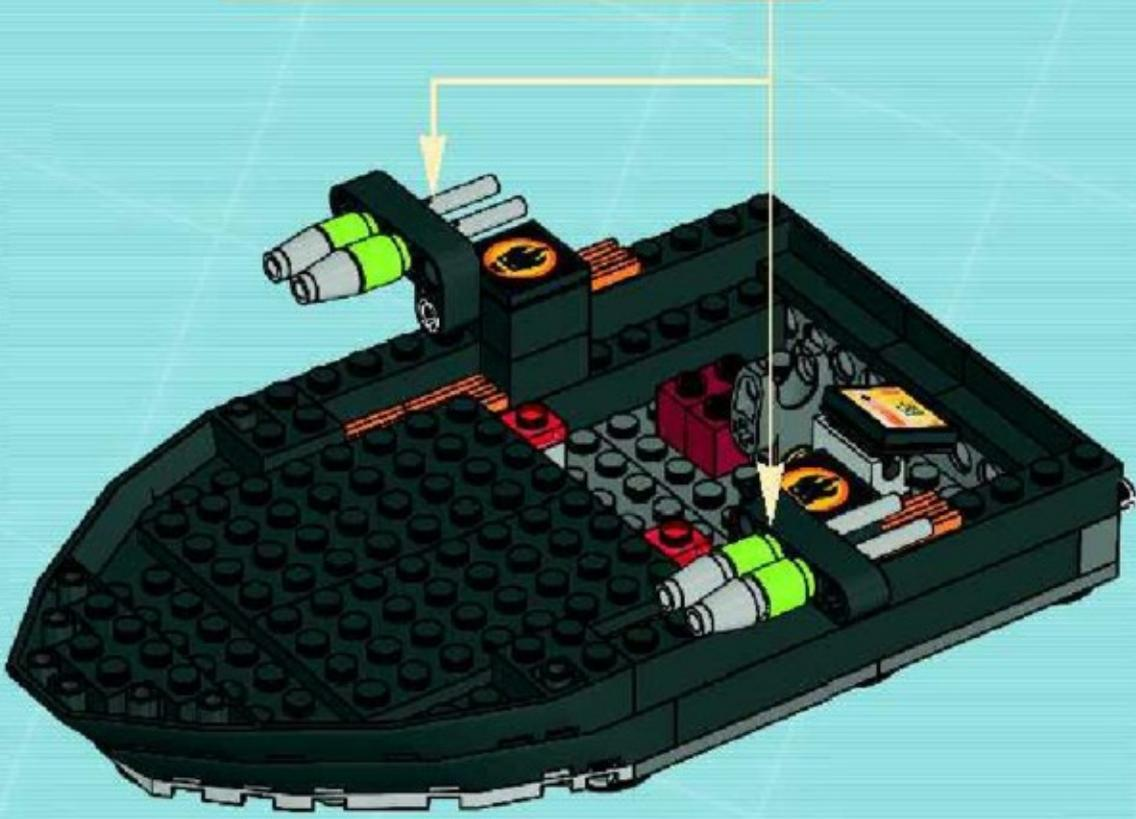
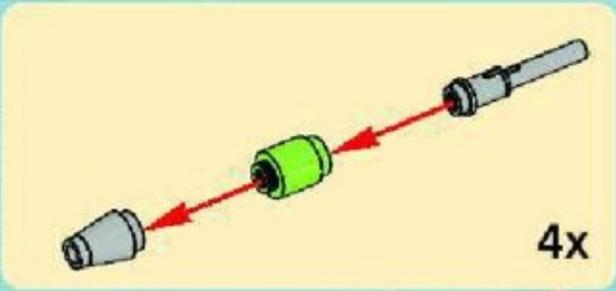

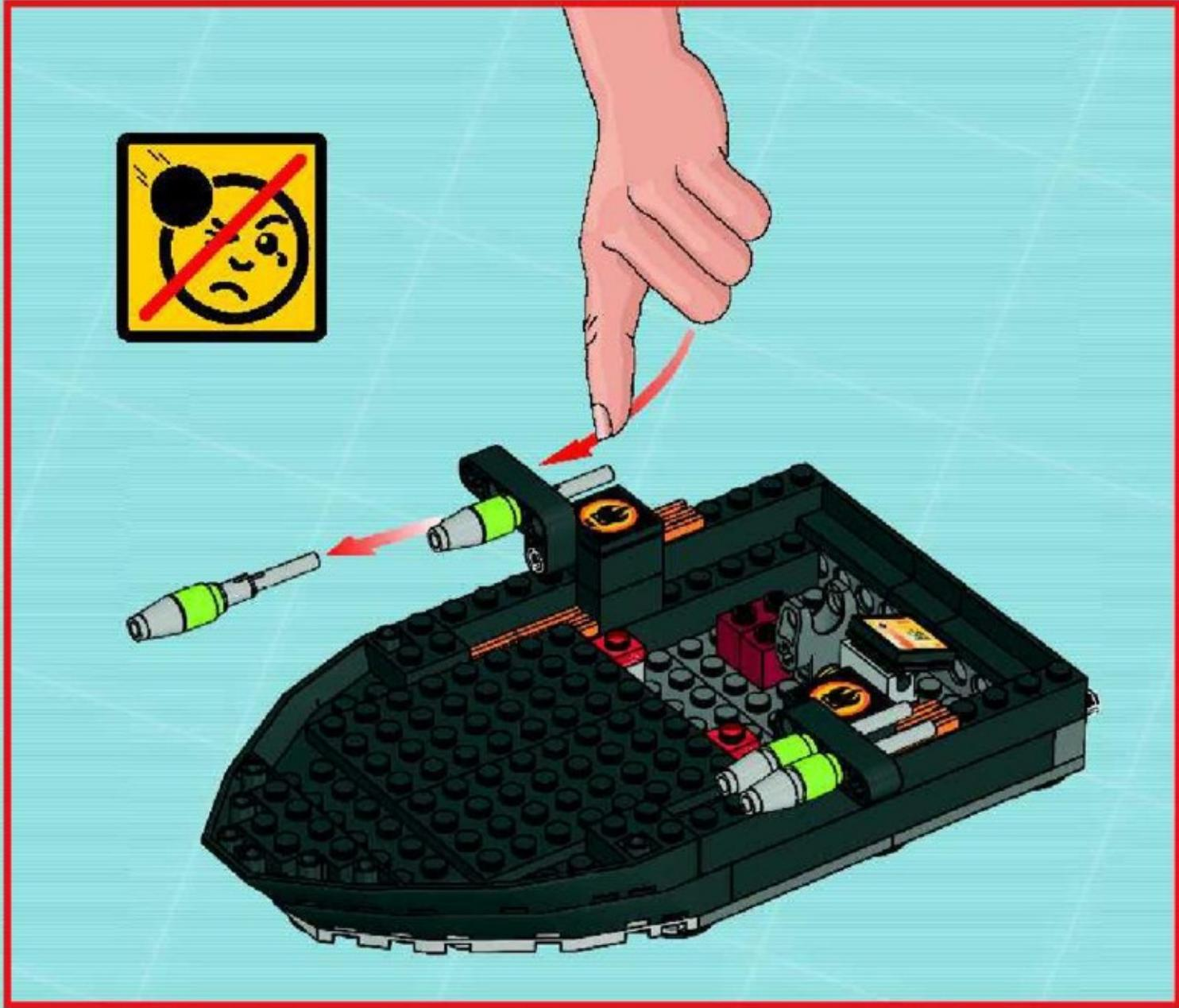



21

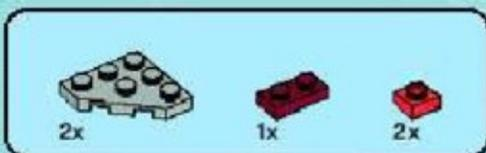
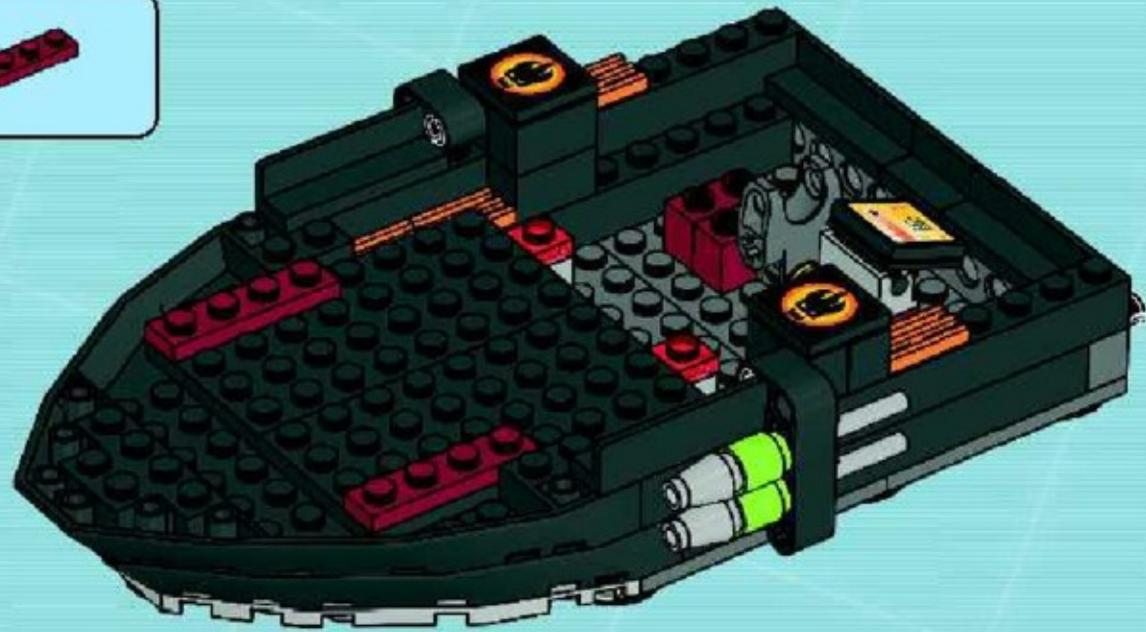

22

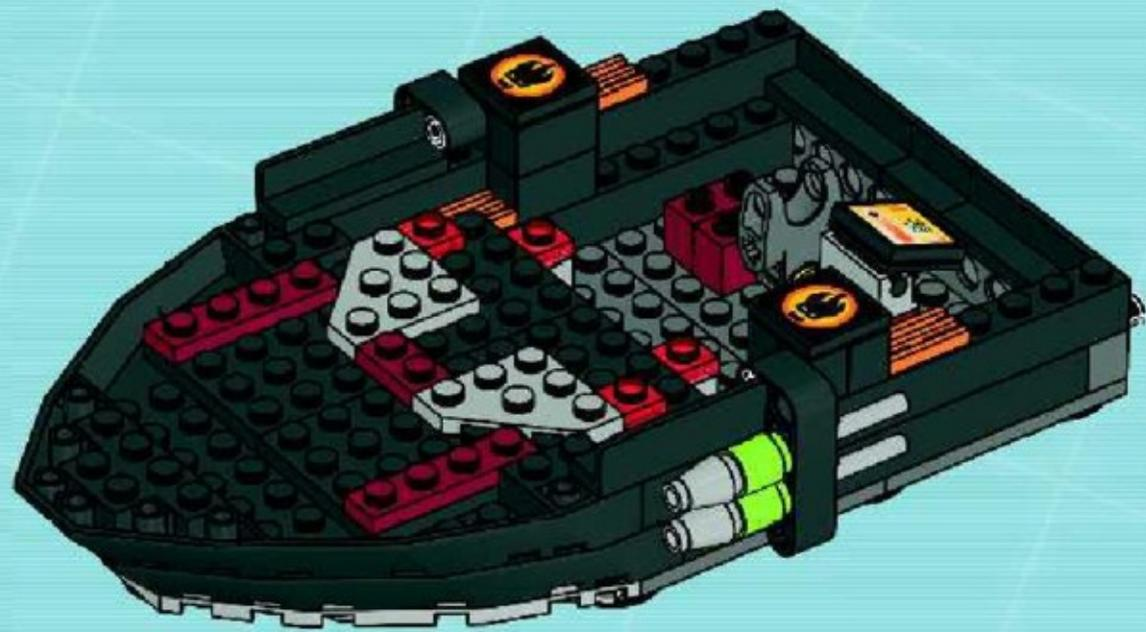

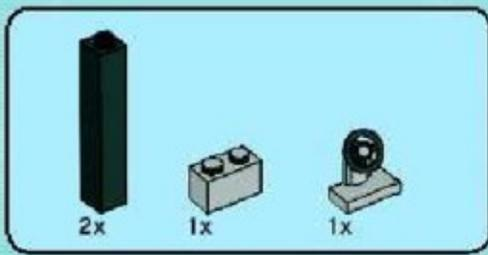

23

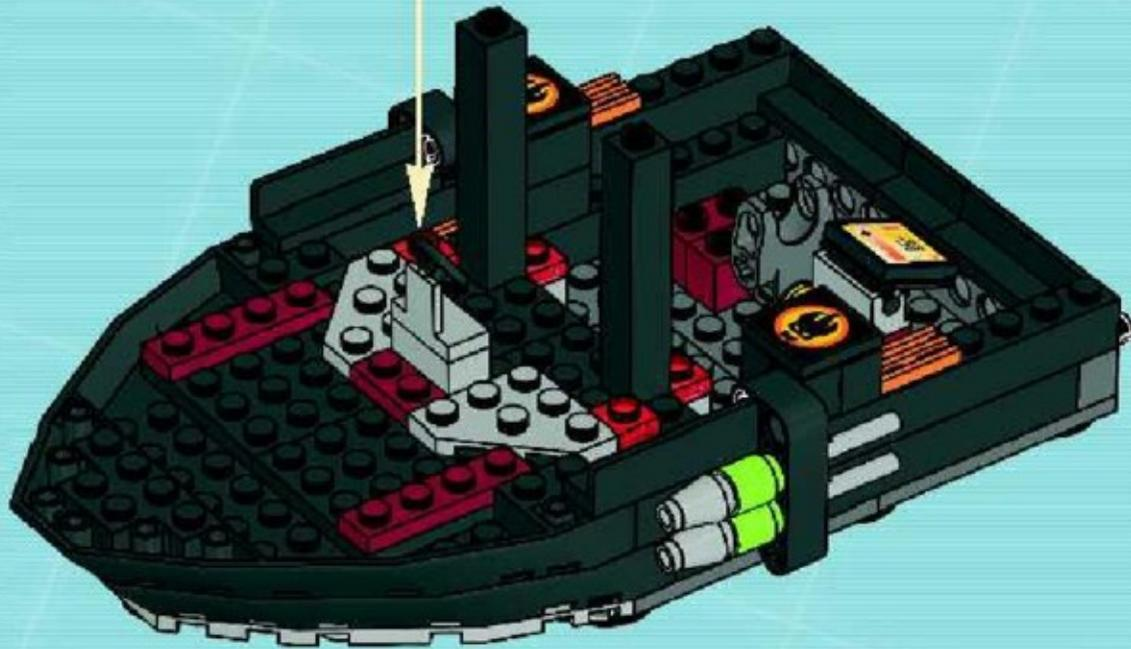
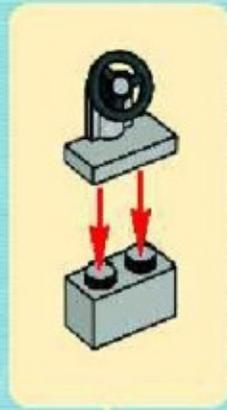

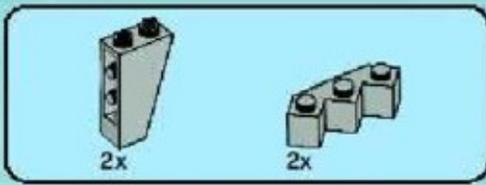

24

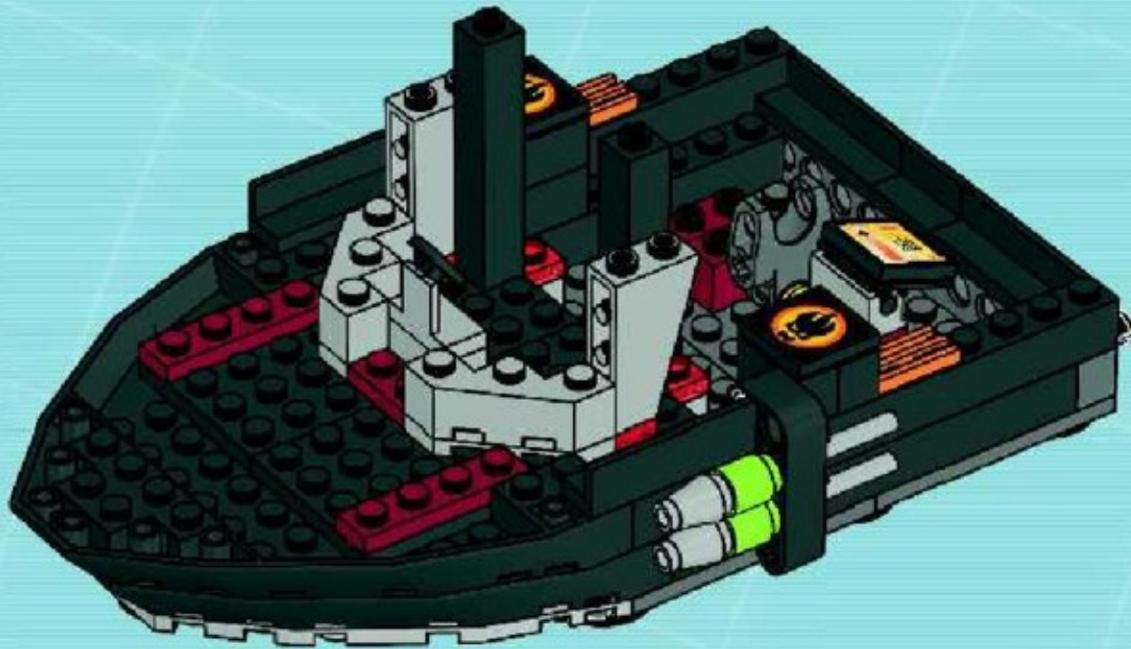

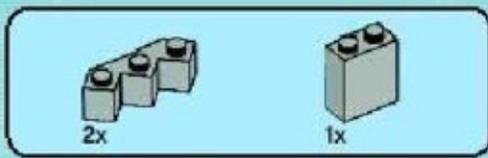

25

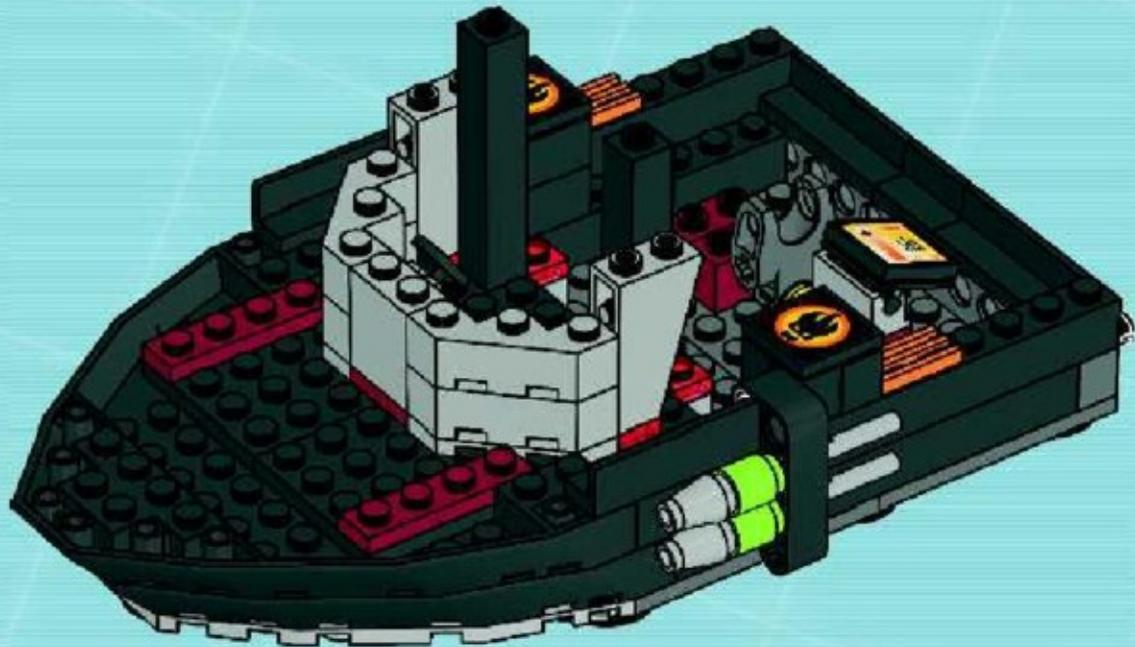



26

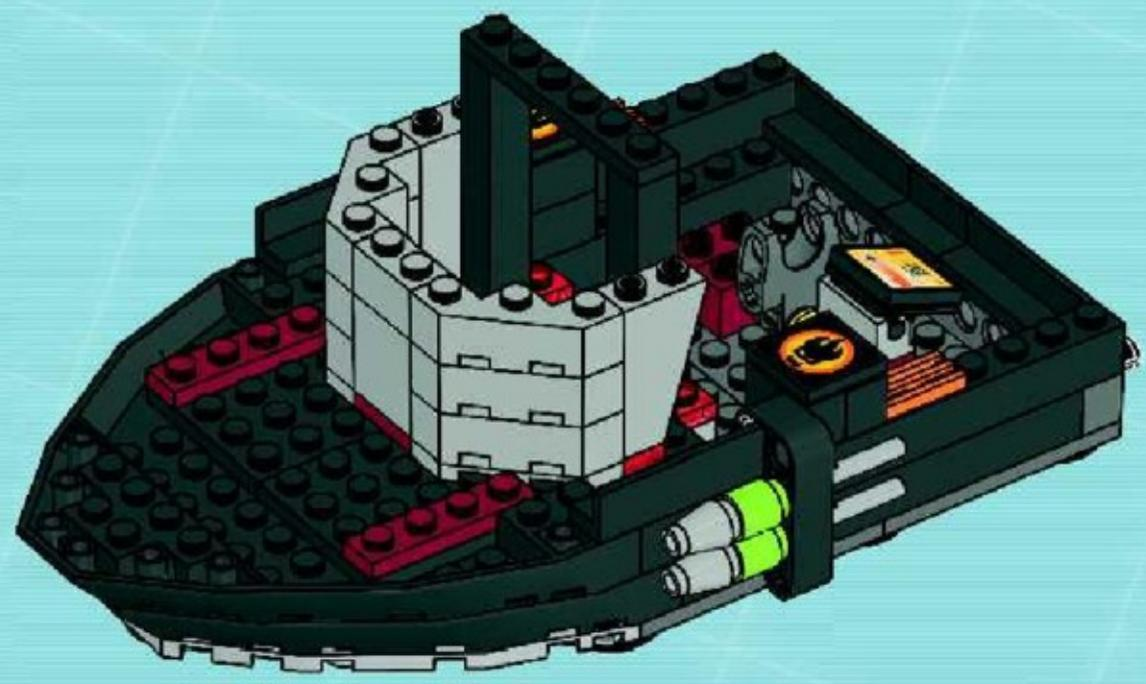

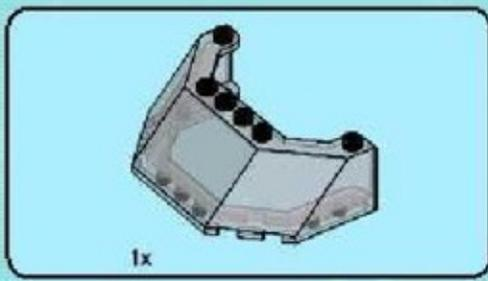

27

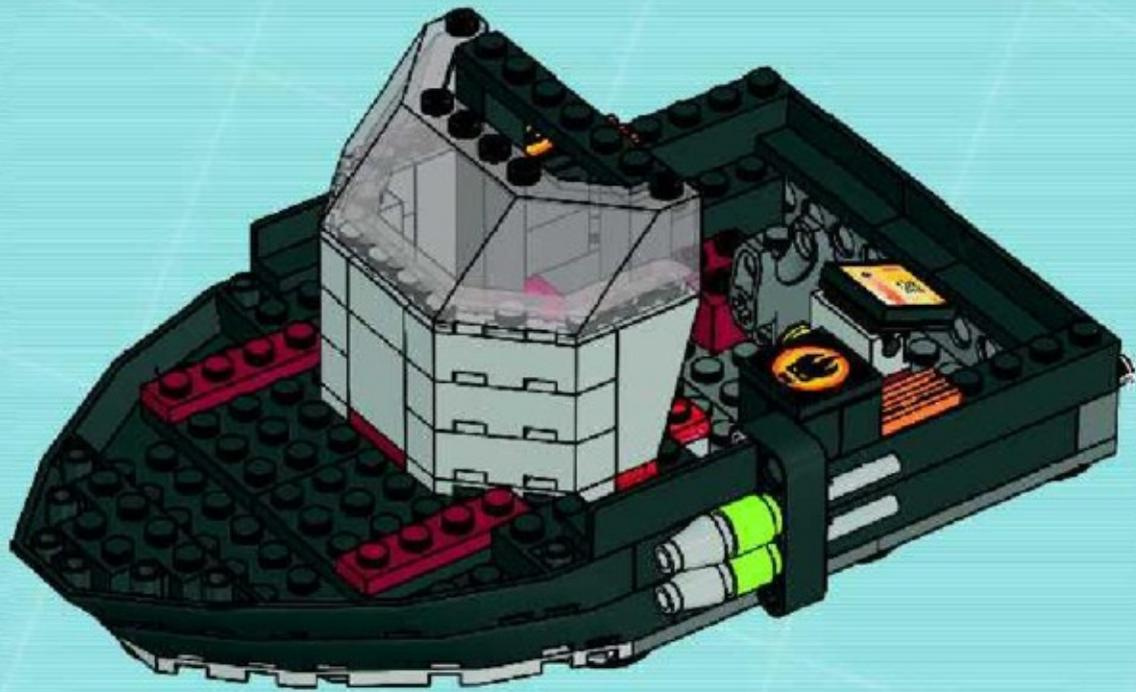



1x



2x

28

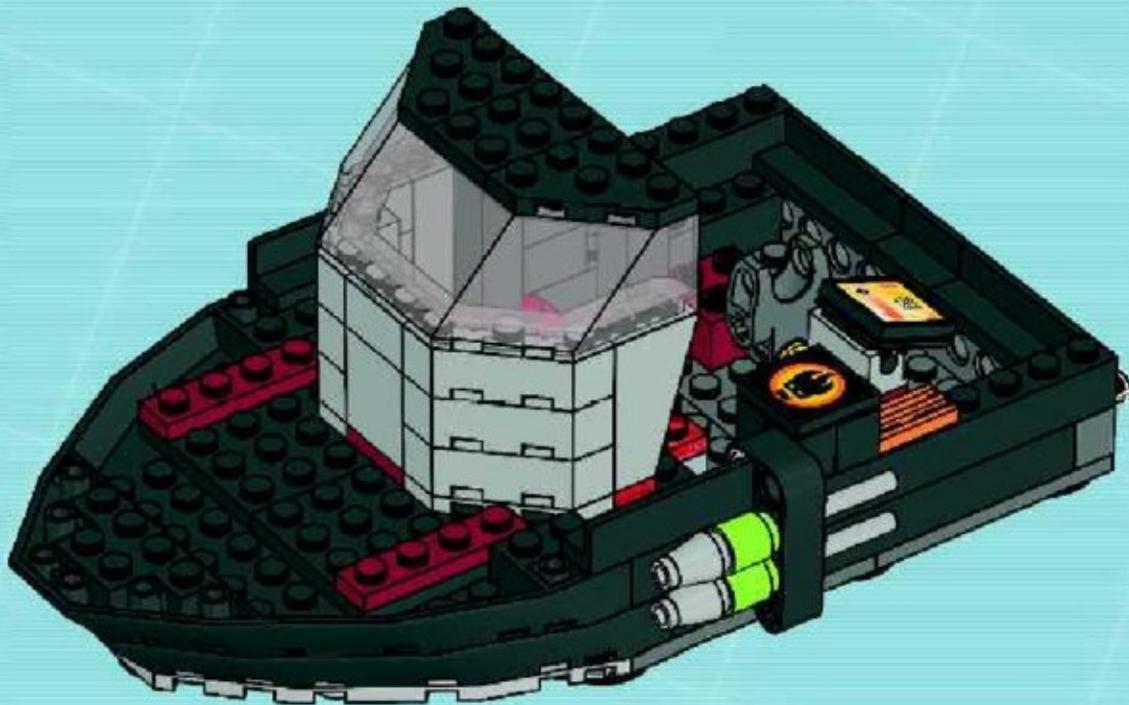

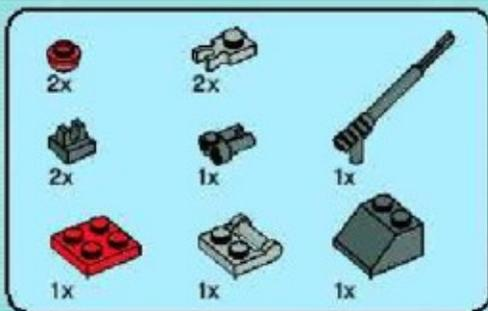

29

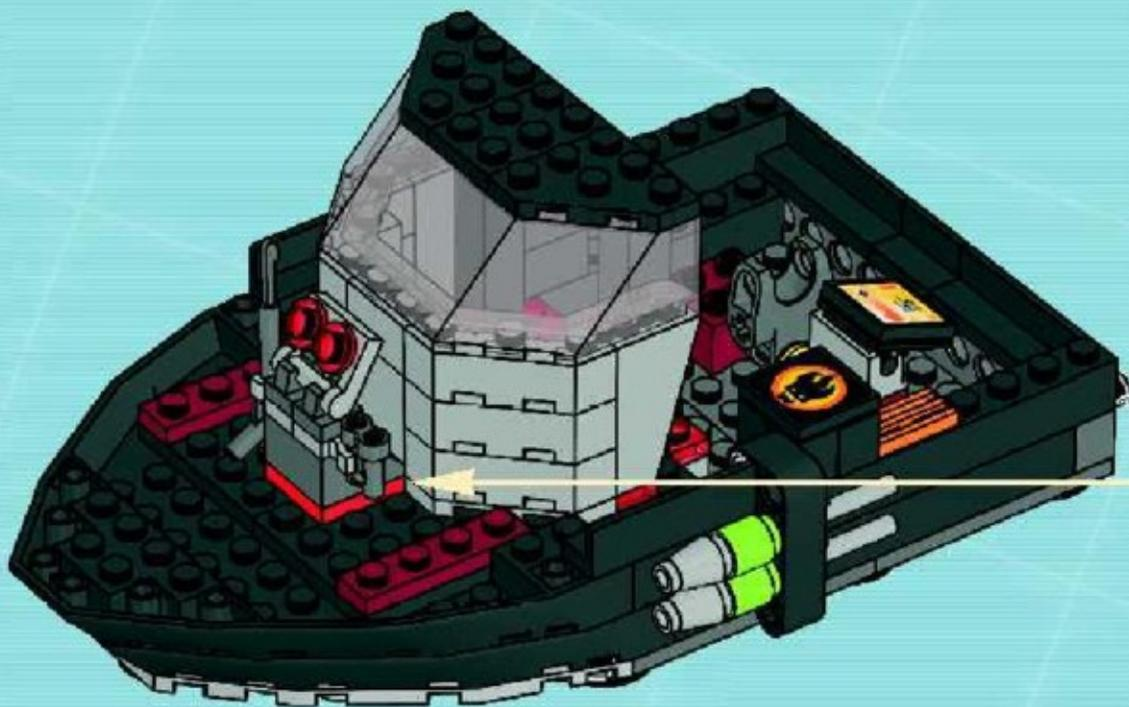
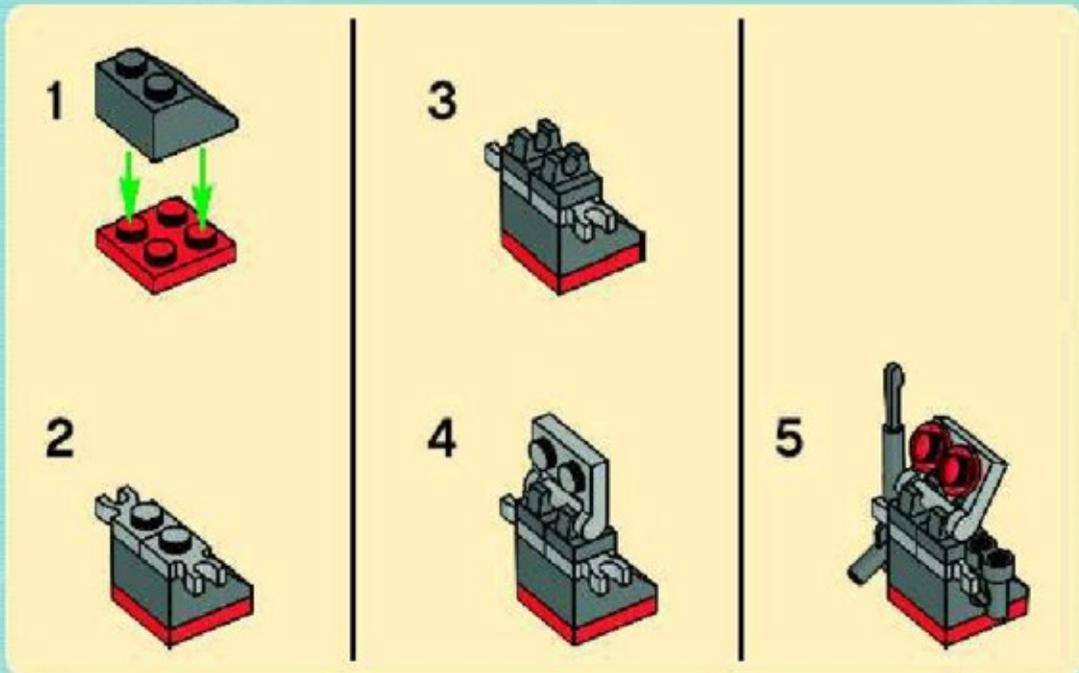



30

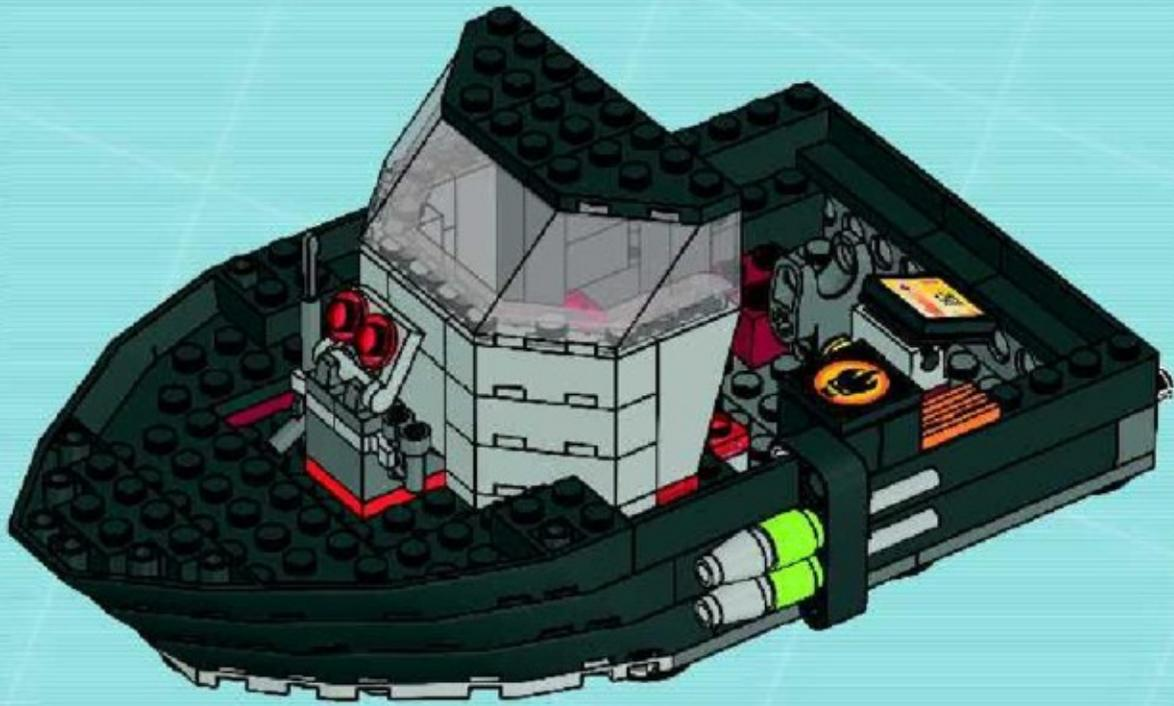



31

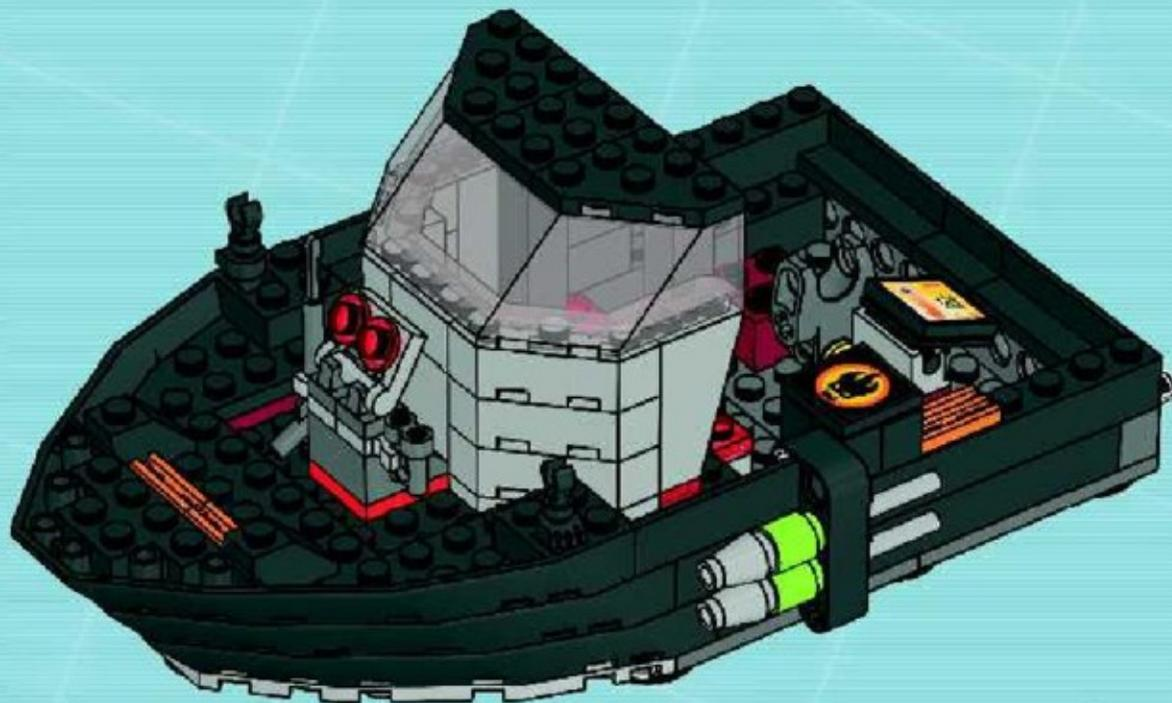

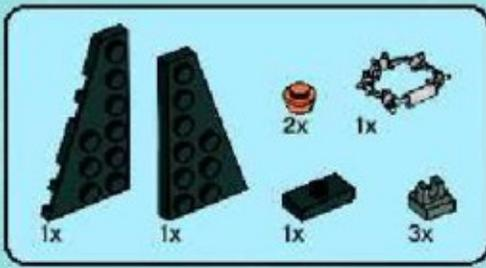

32

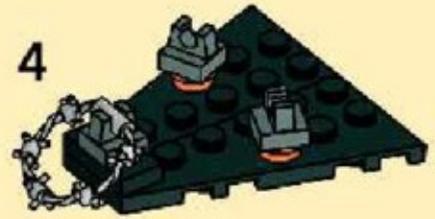
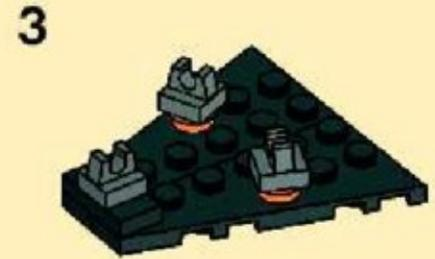
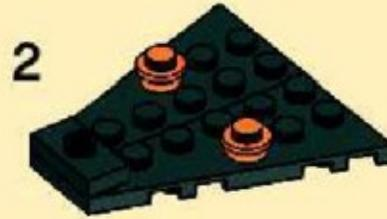
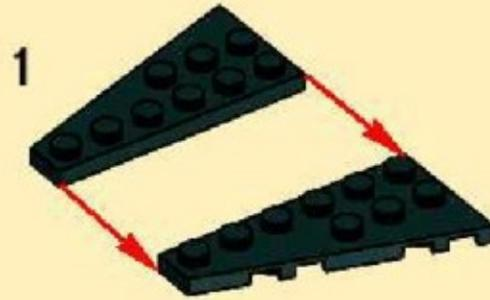

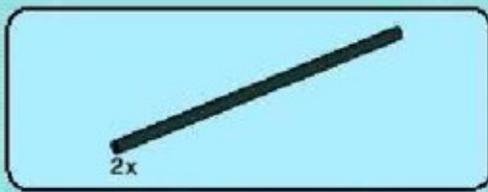

33

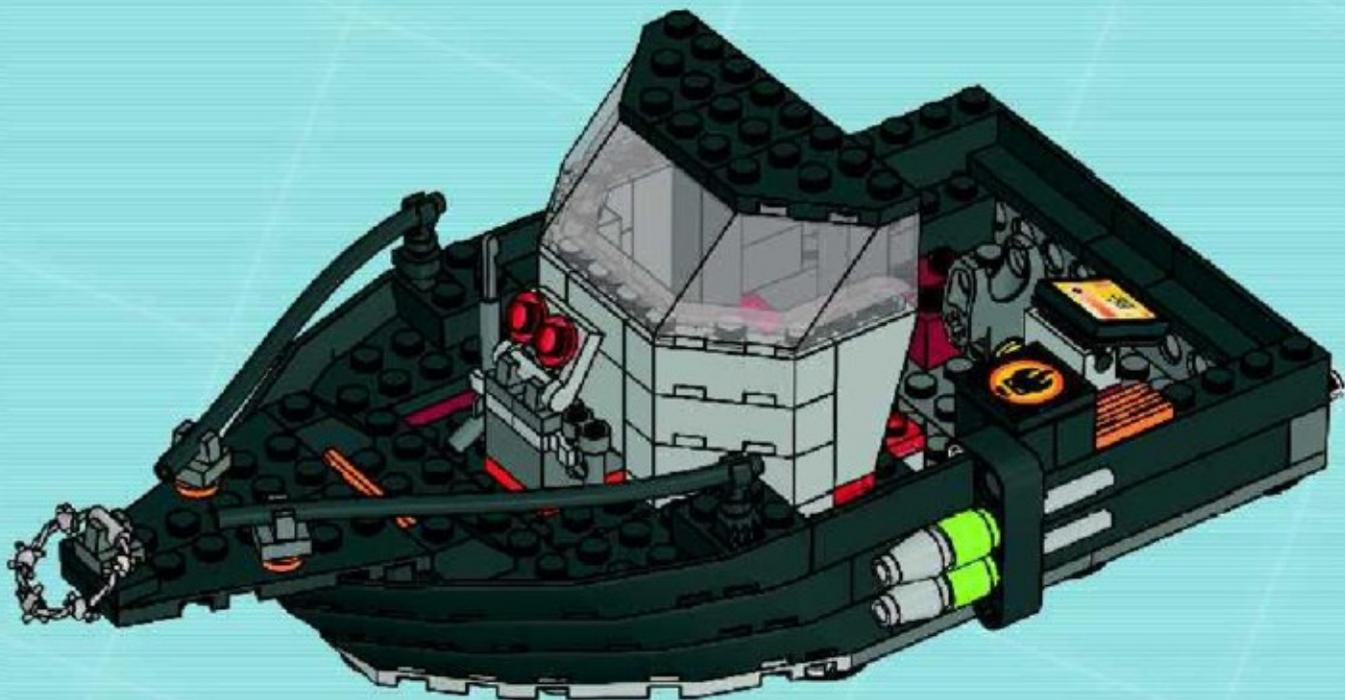



34

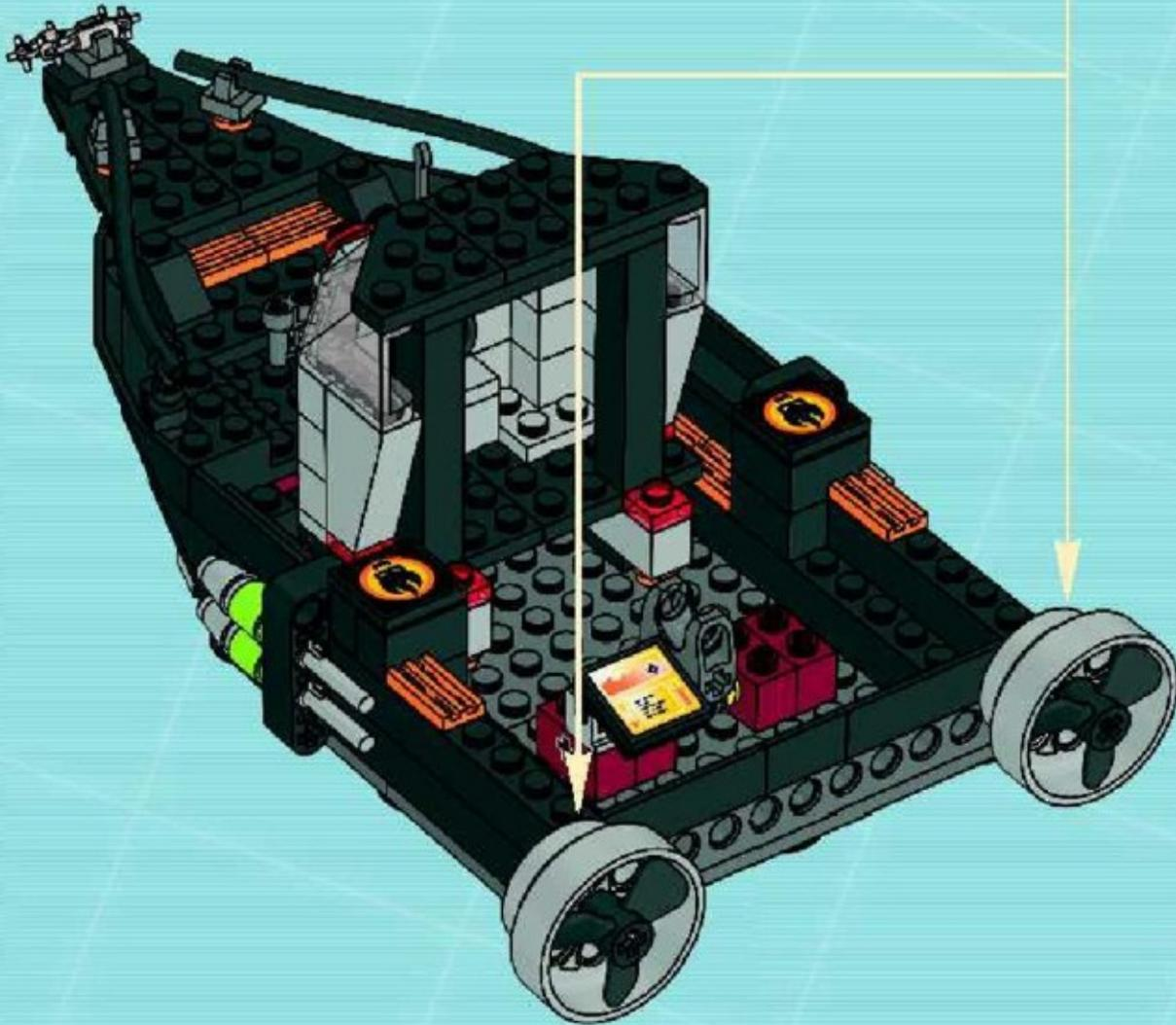
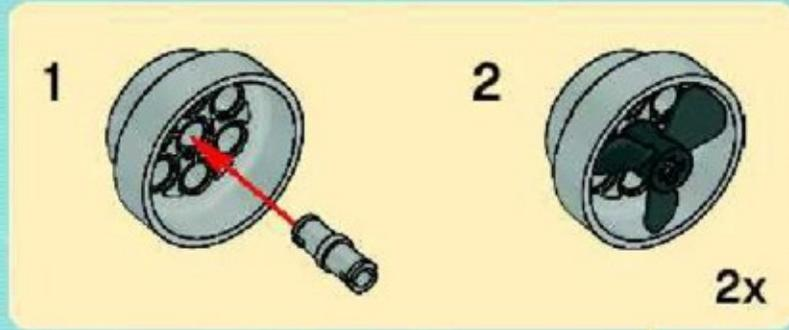

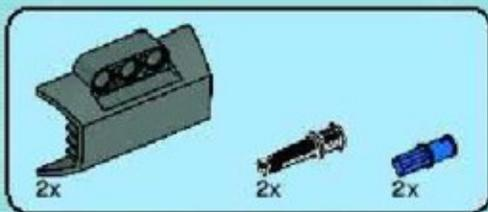

35

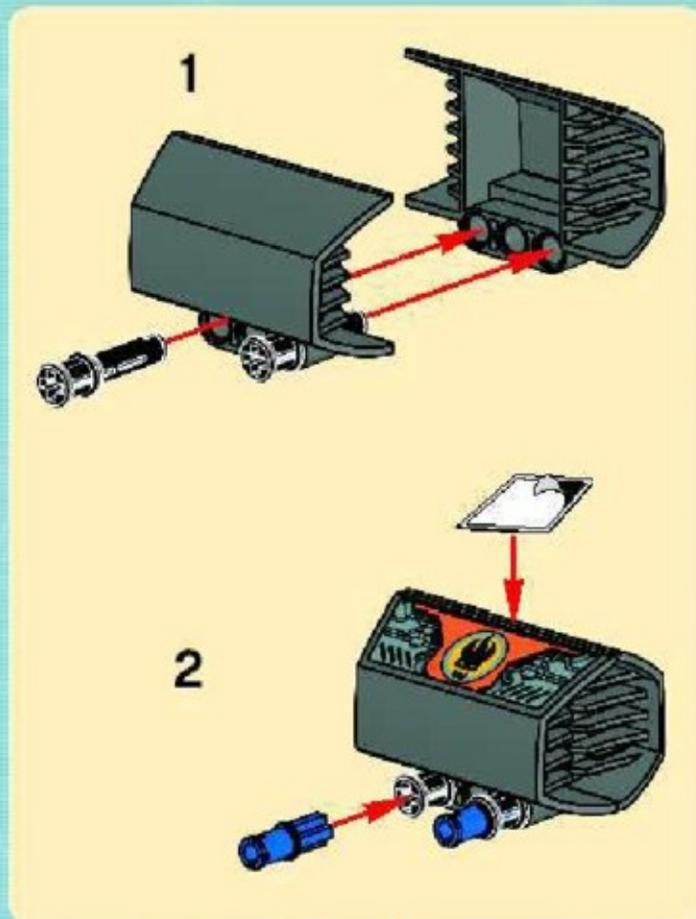
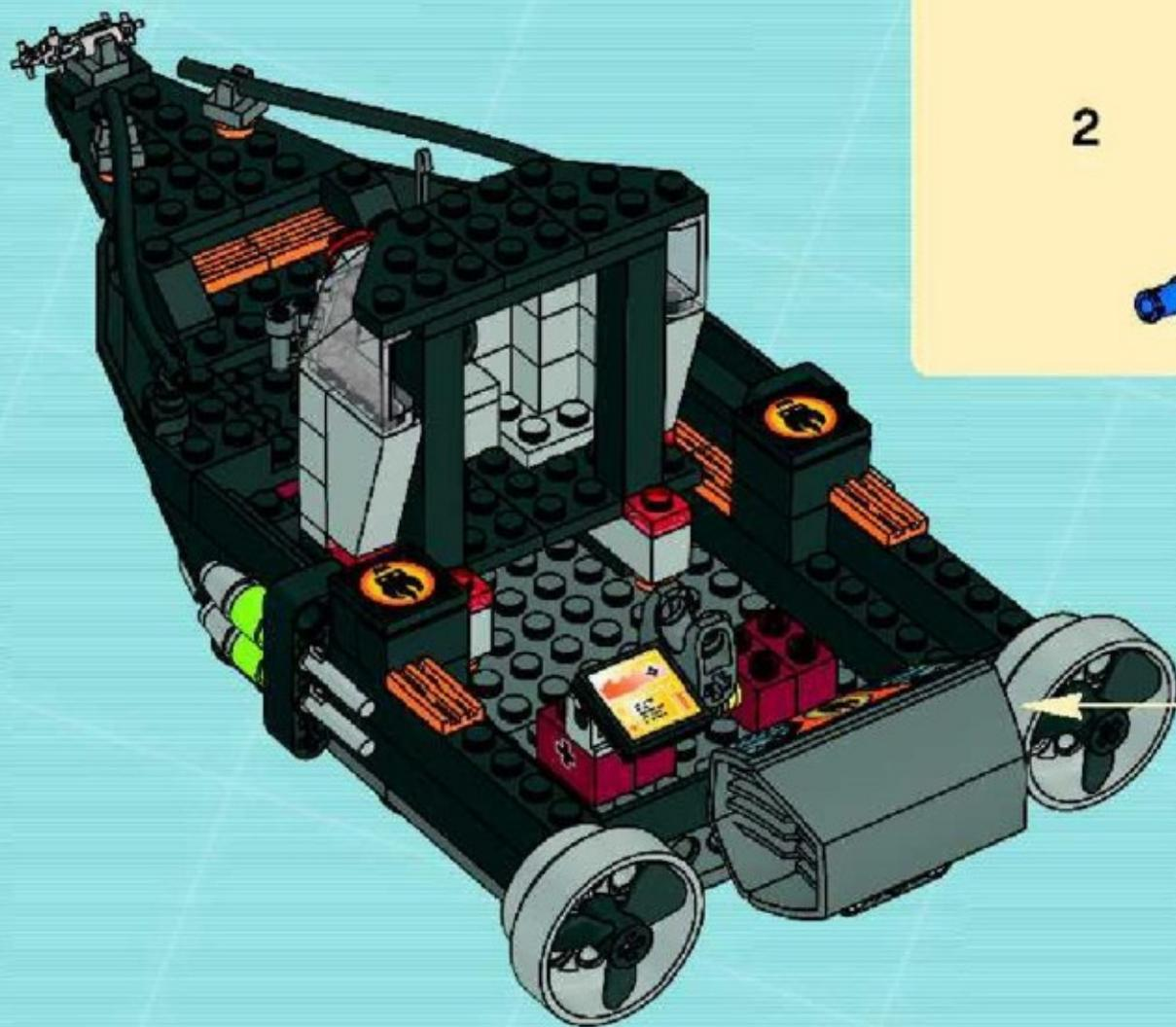

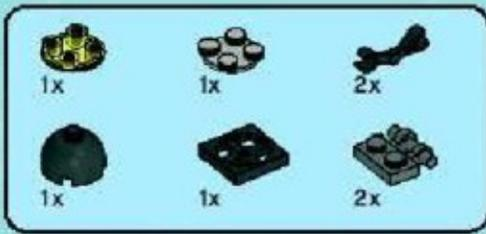

36

1



2



3



4



5



6







2x



4x

37

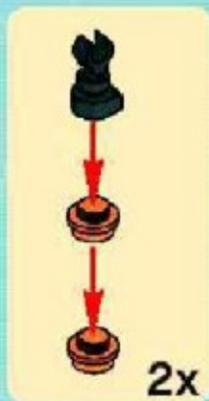



38

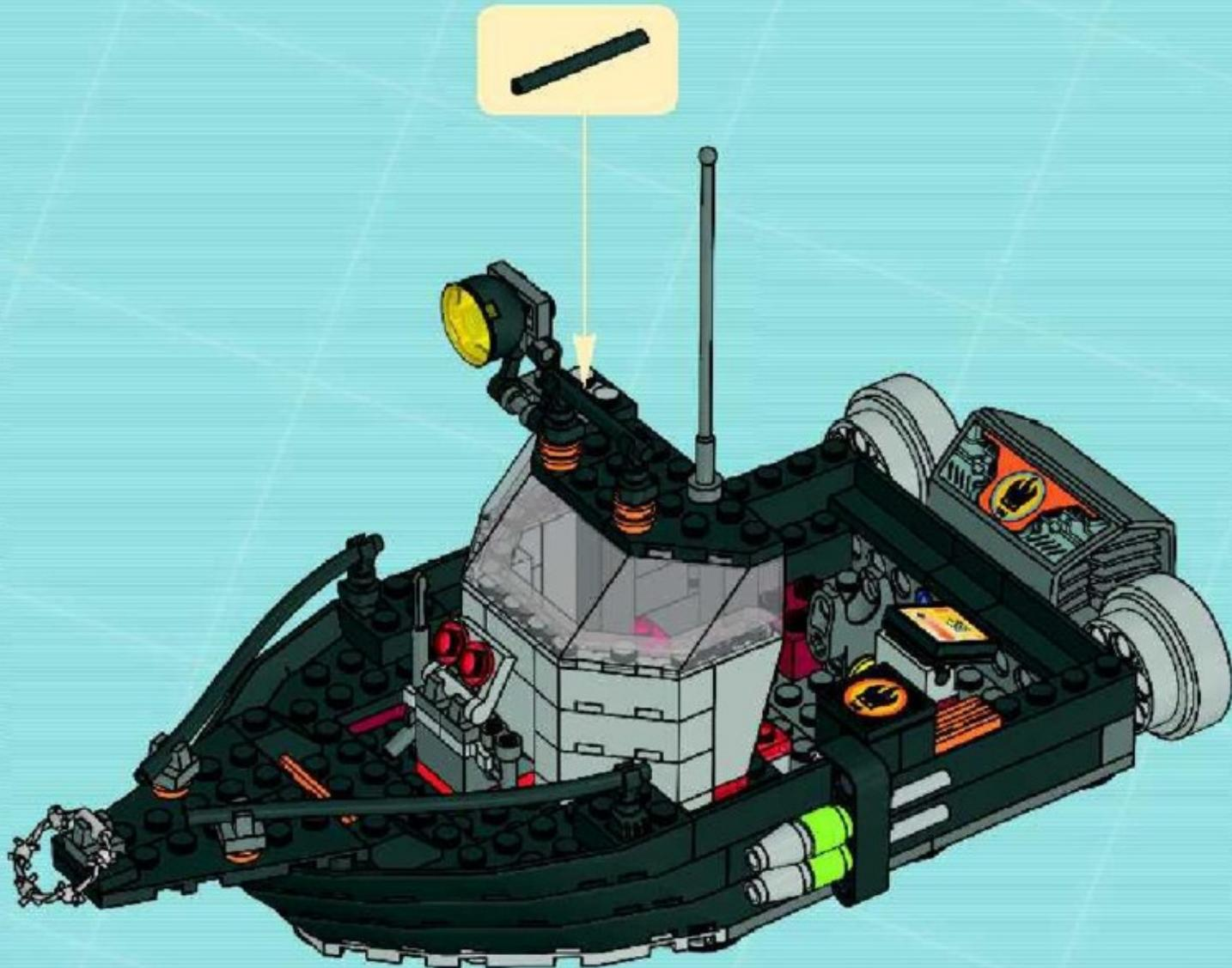

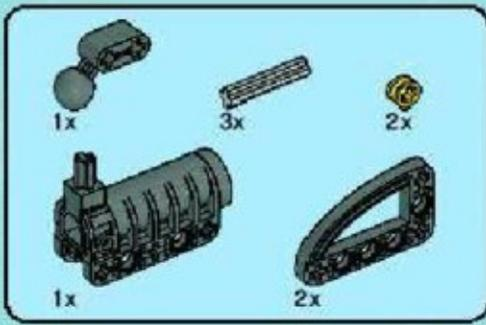

39

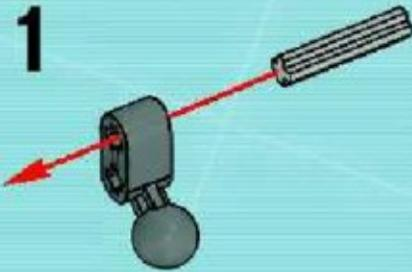

2



3



4

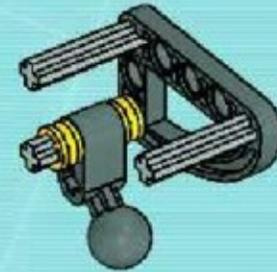

5



6

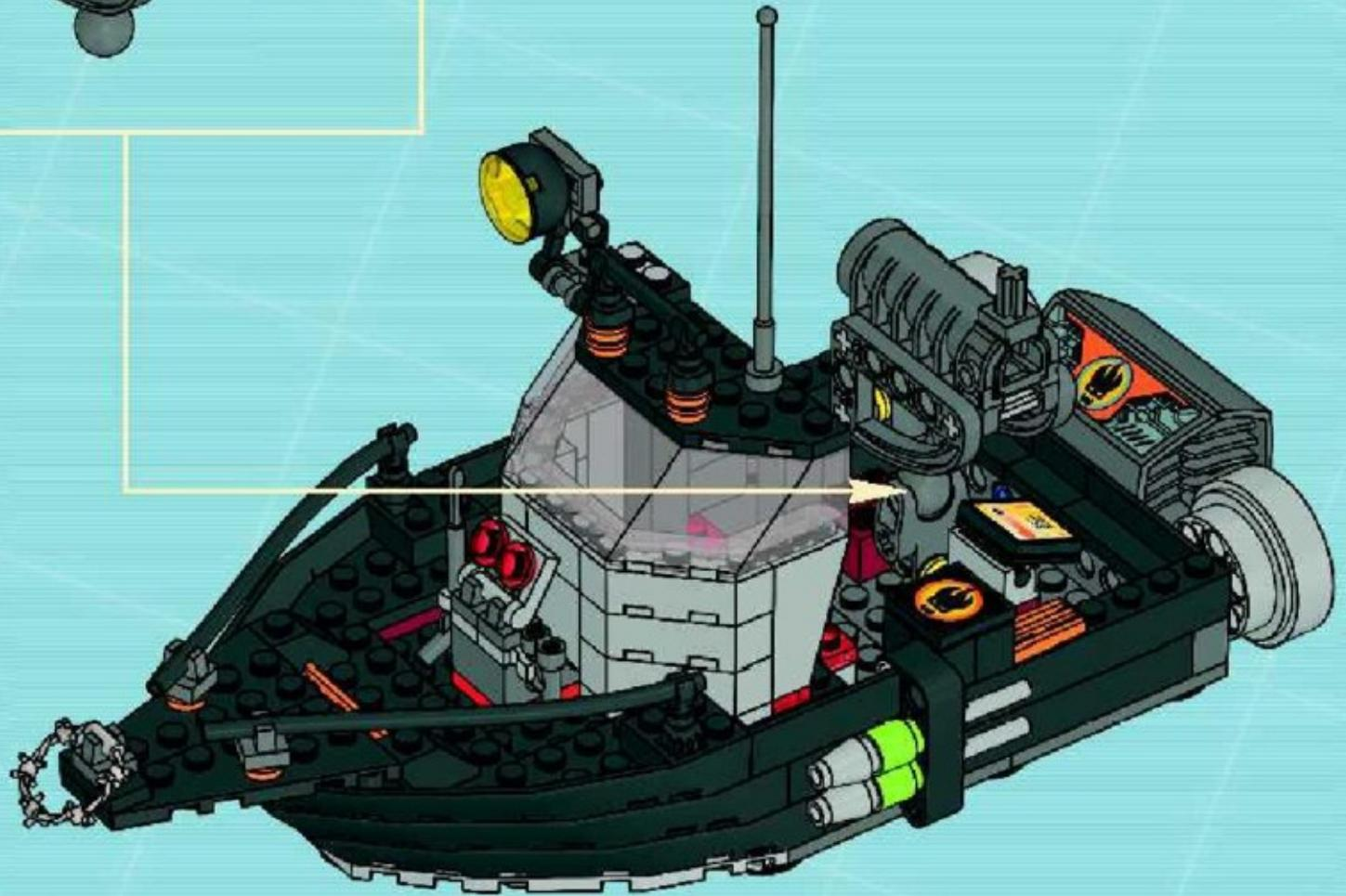



40

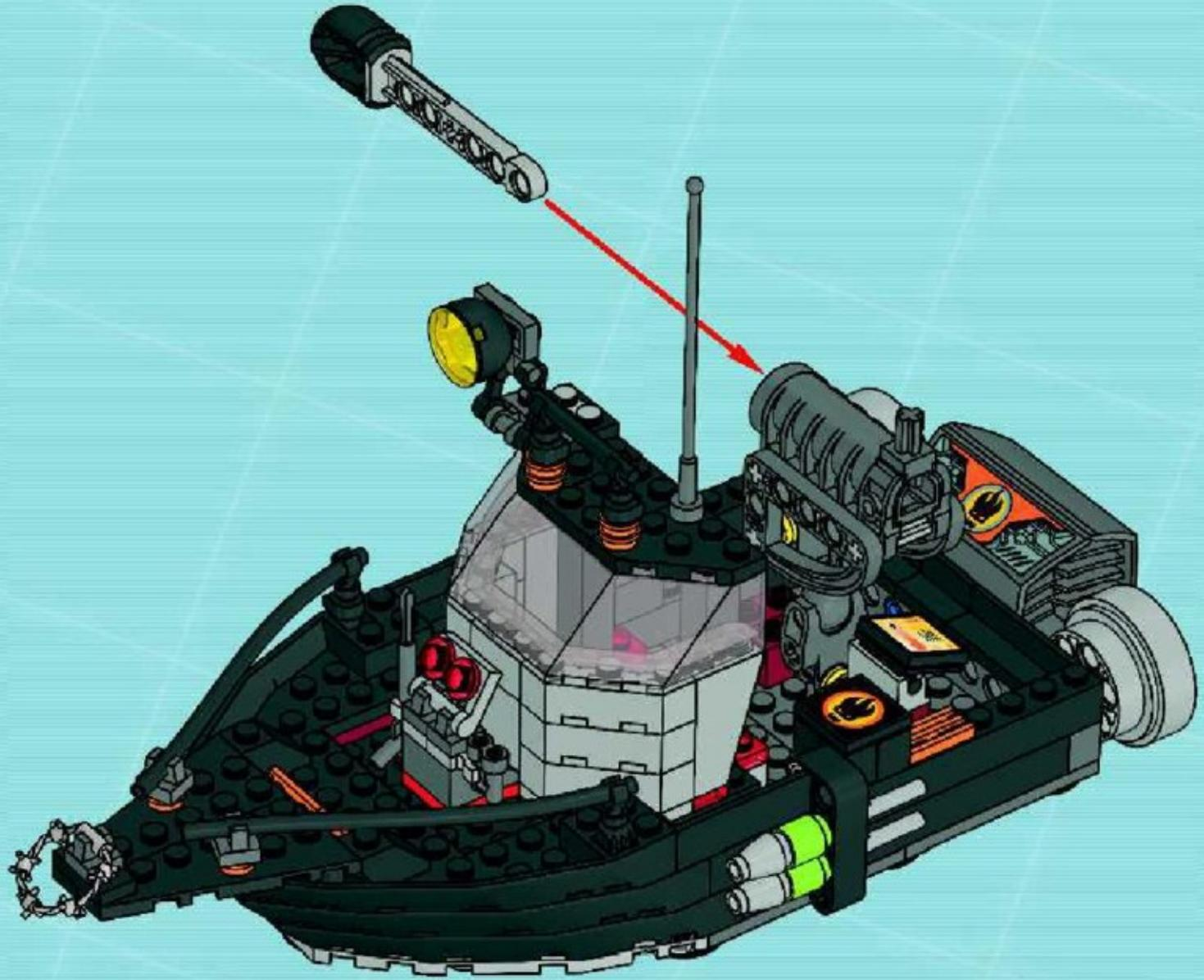



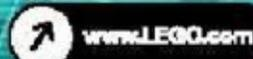



AGENTS

A small illustration of three LEGO Agents characters: a man in a blue uniform, a woman in a blue uniform, and a character in a green and black tactical suit.

8636



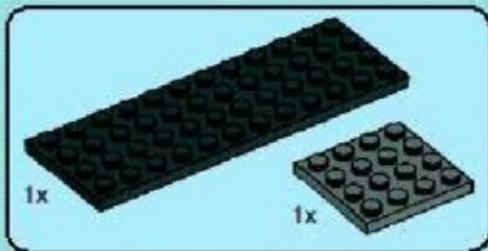
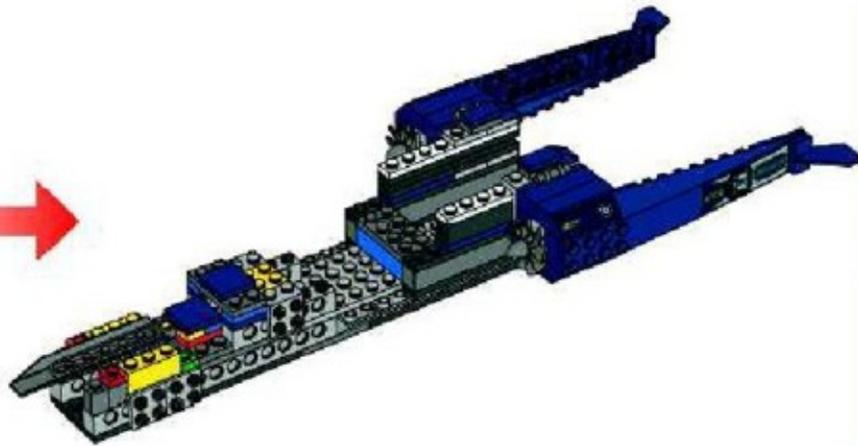

1

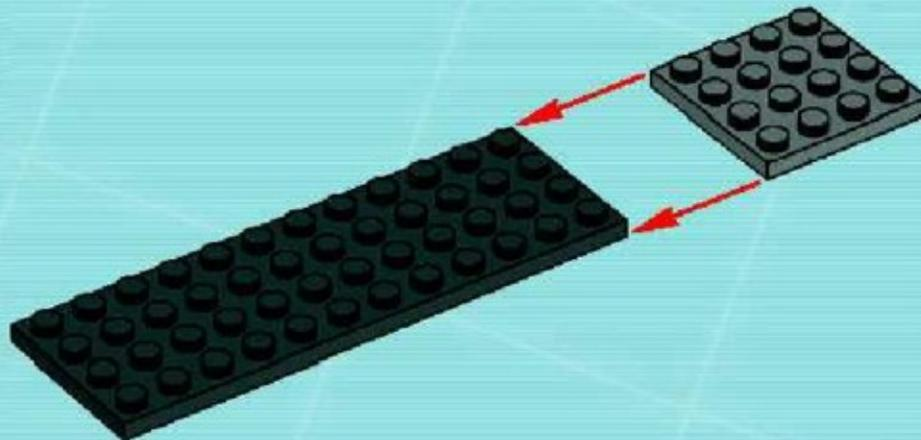

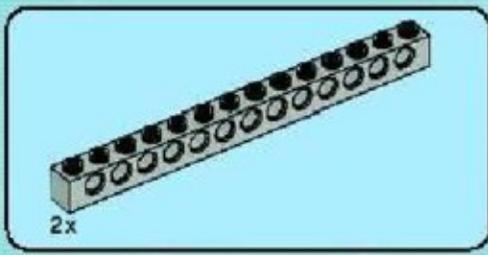

2

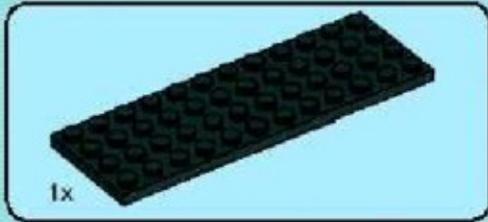
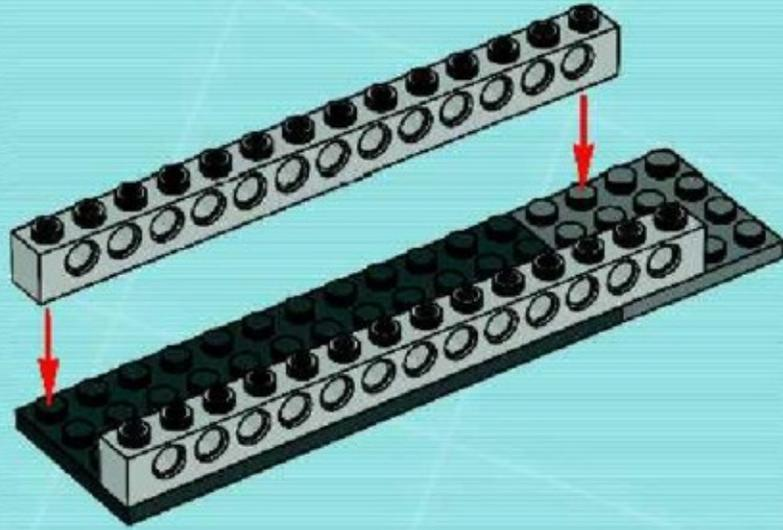

3

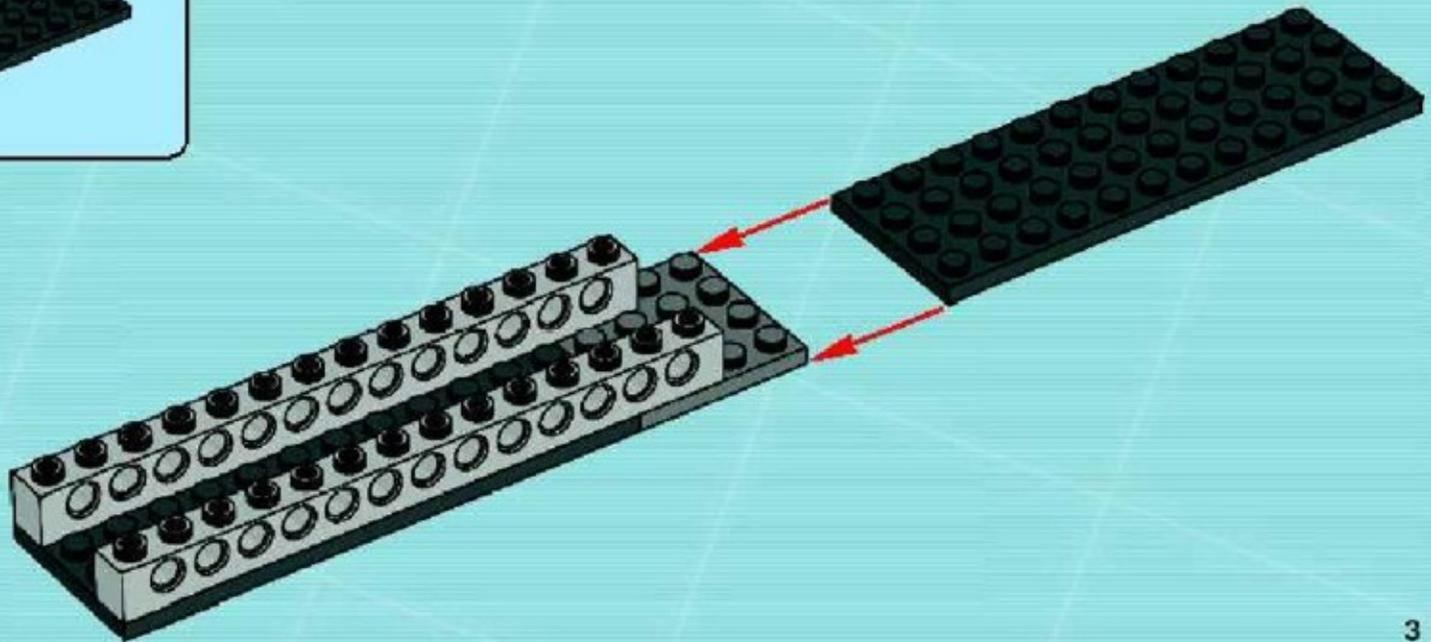

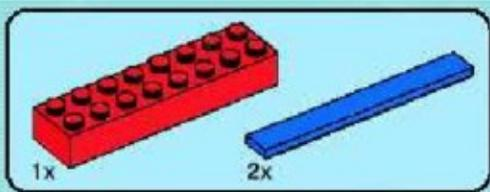

4

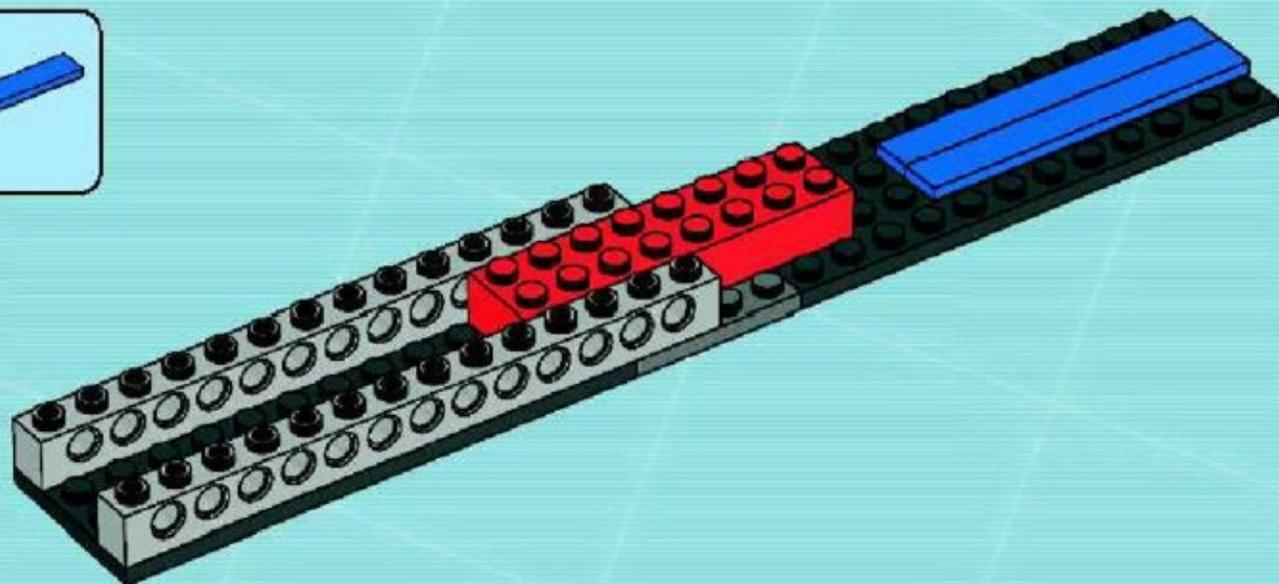

5

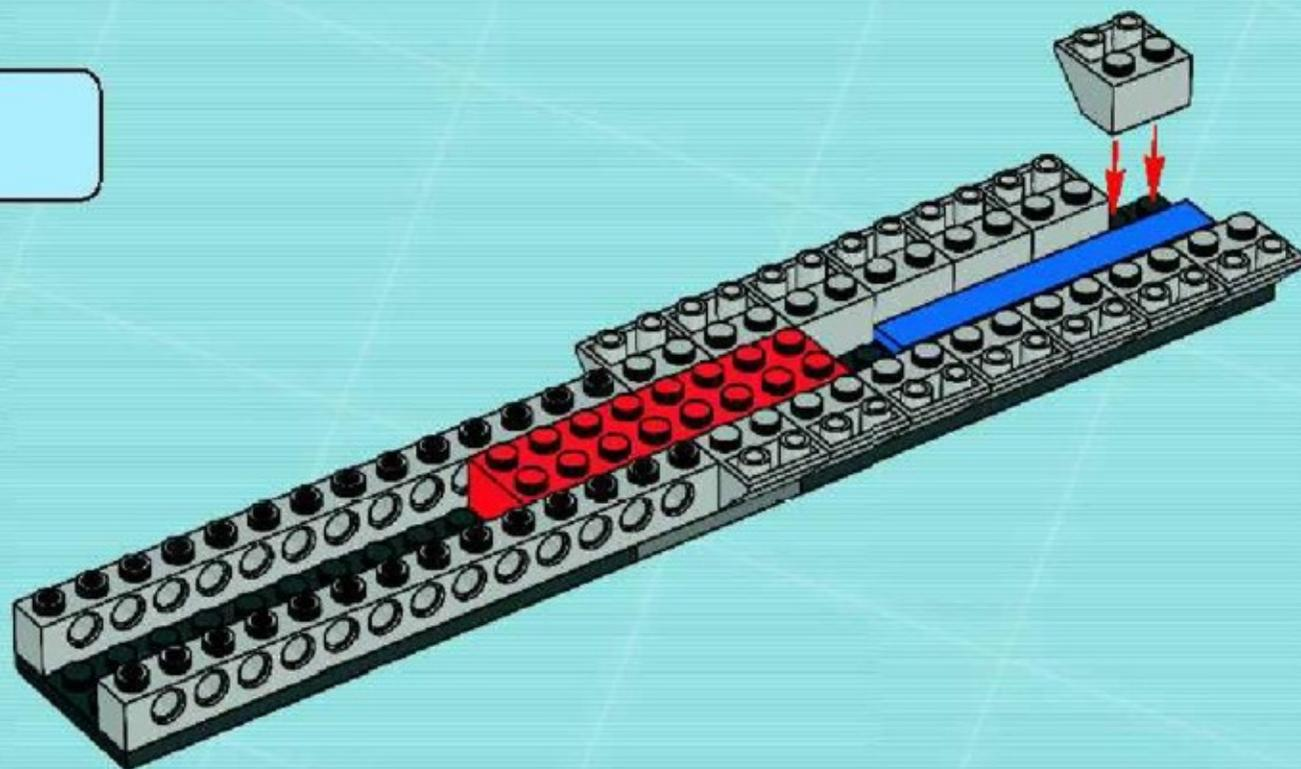

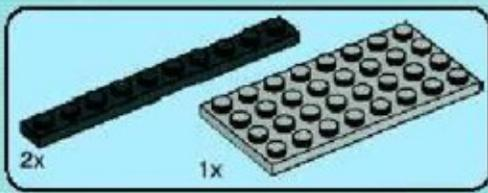

6

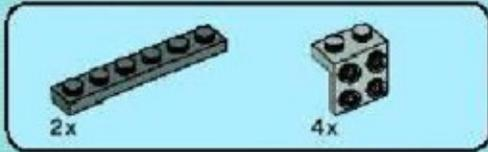
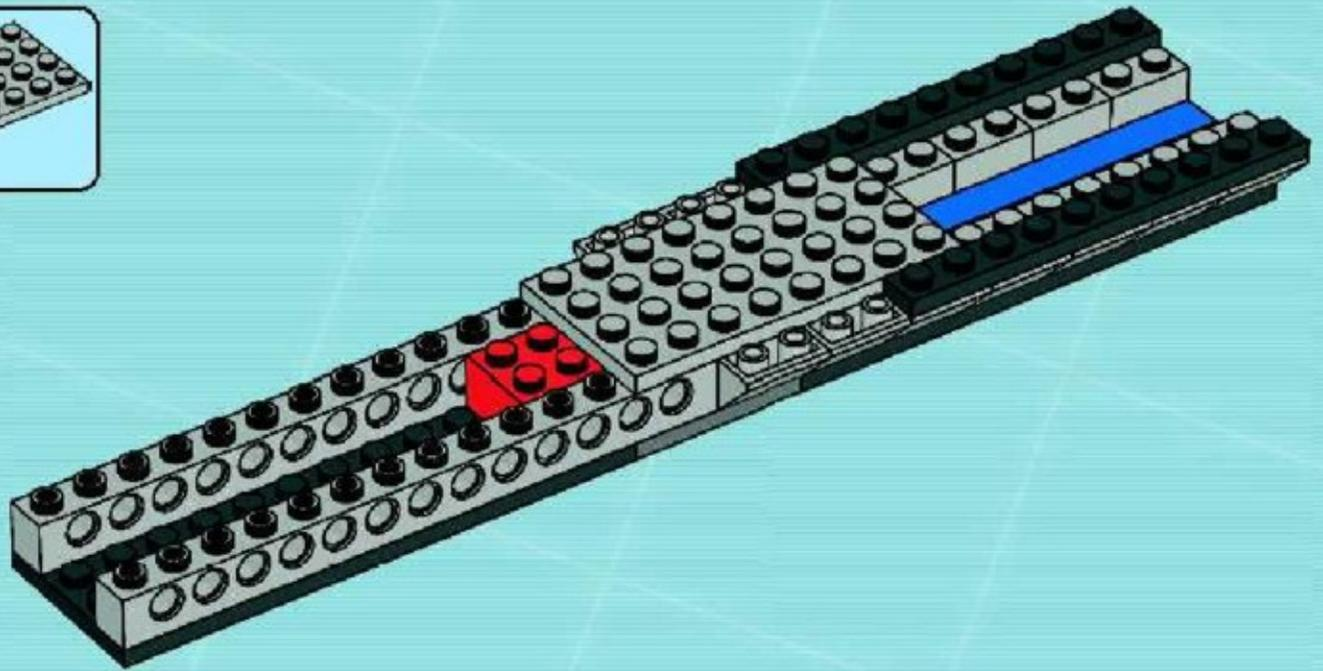

7

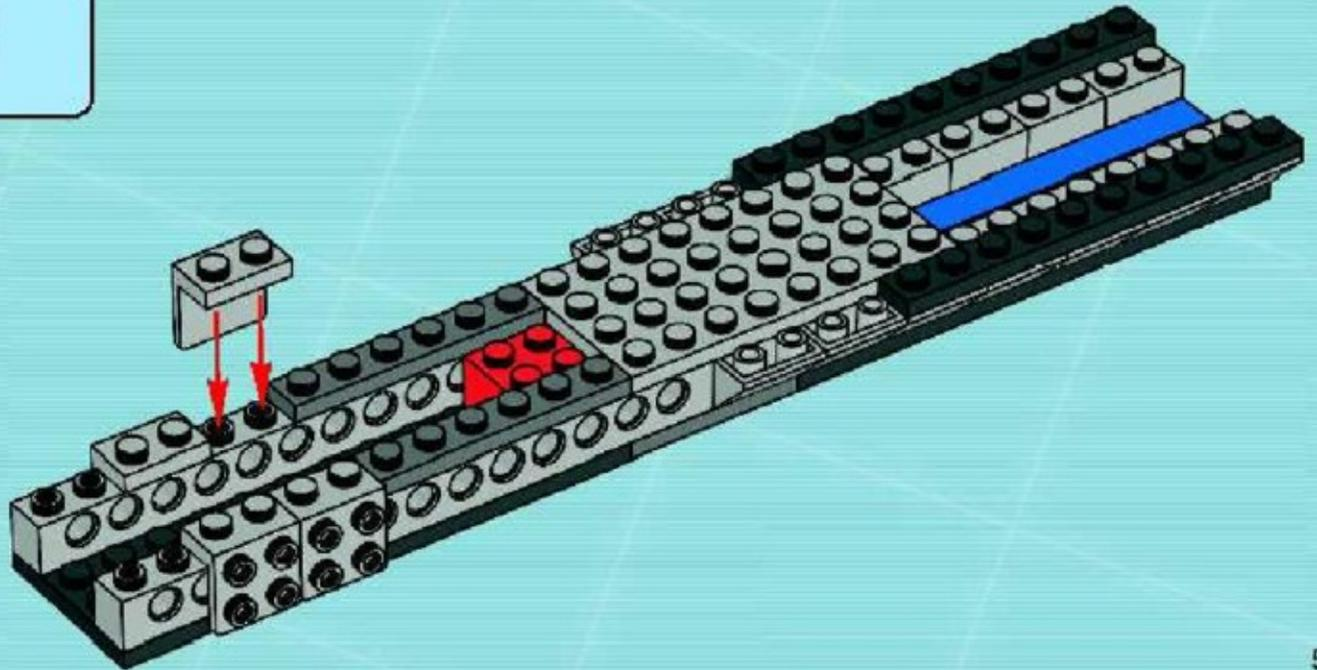



8

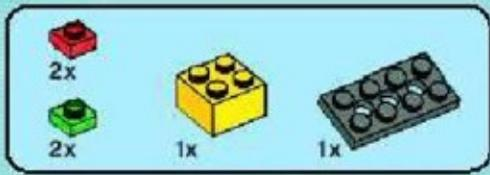

9

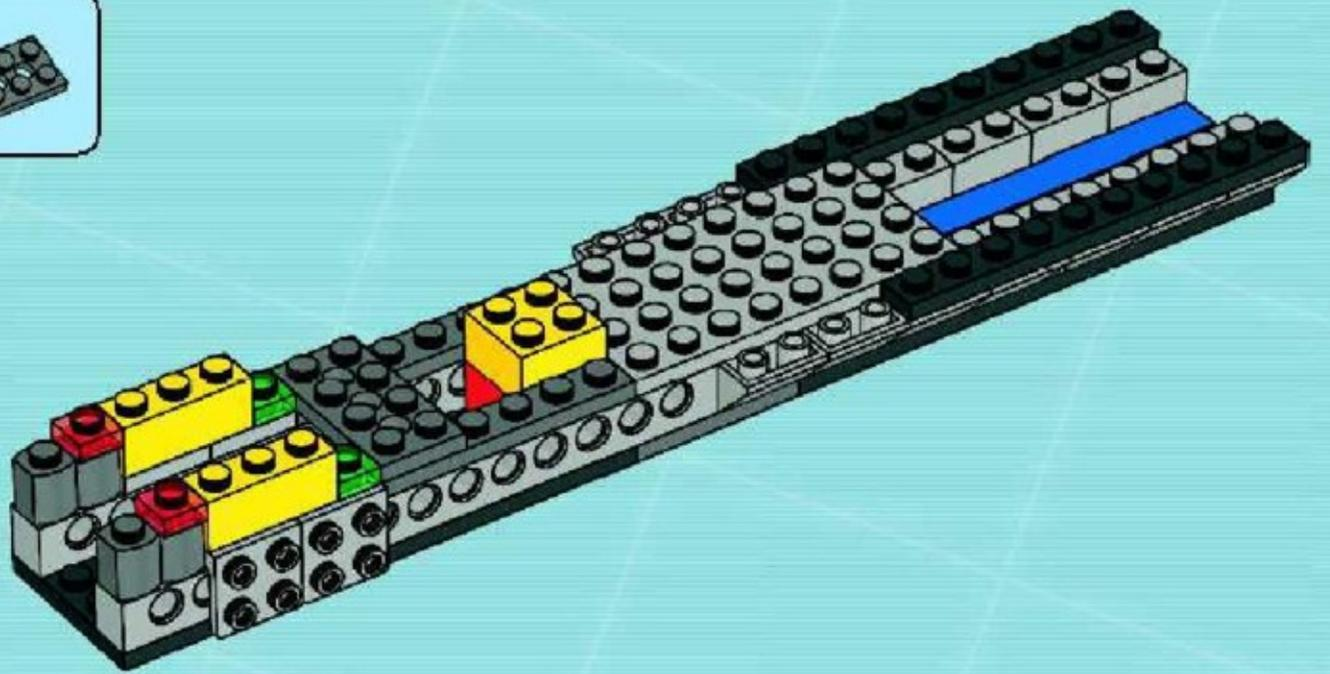



10

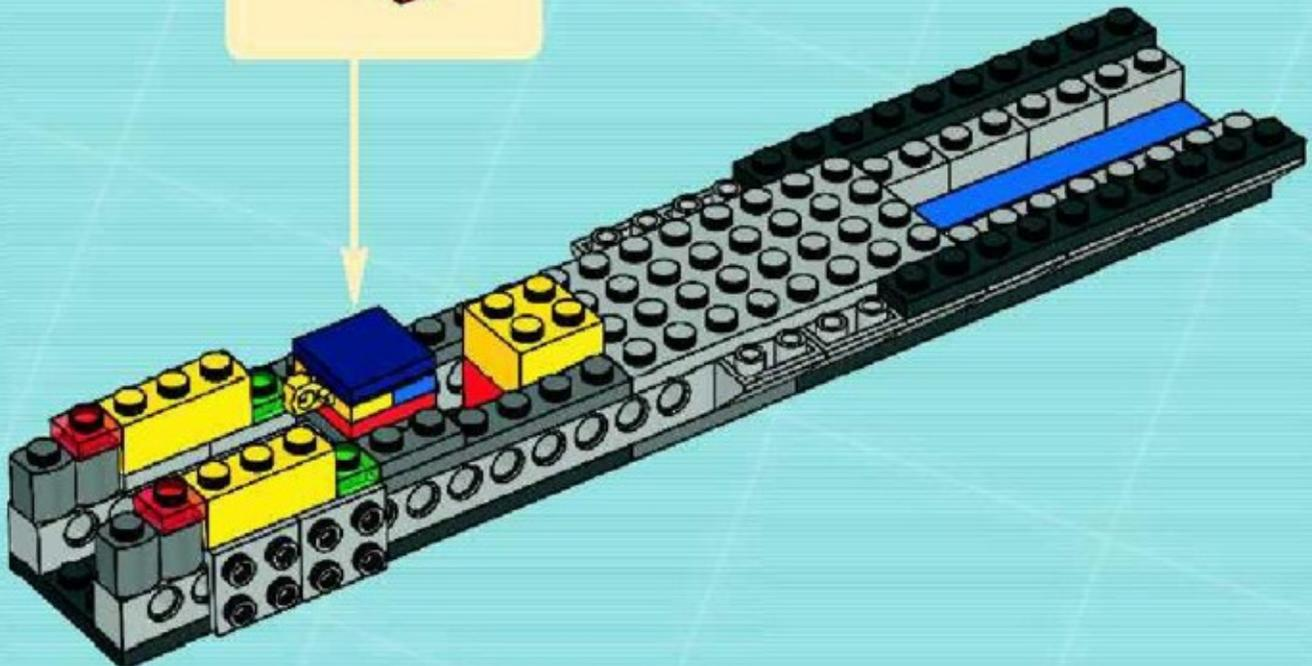
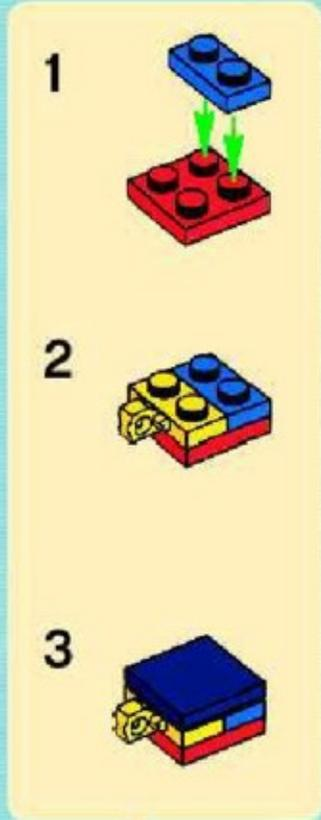

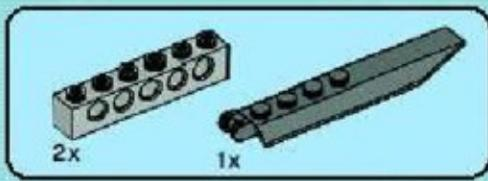

11

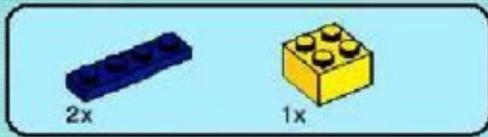
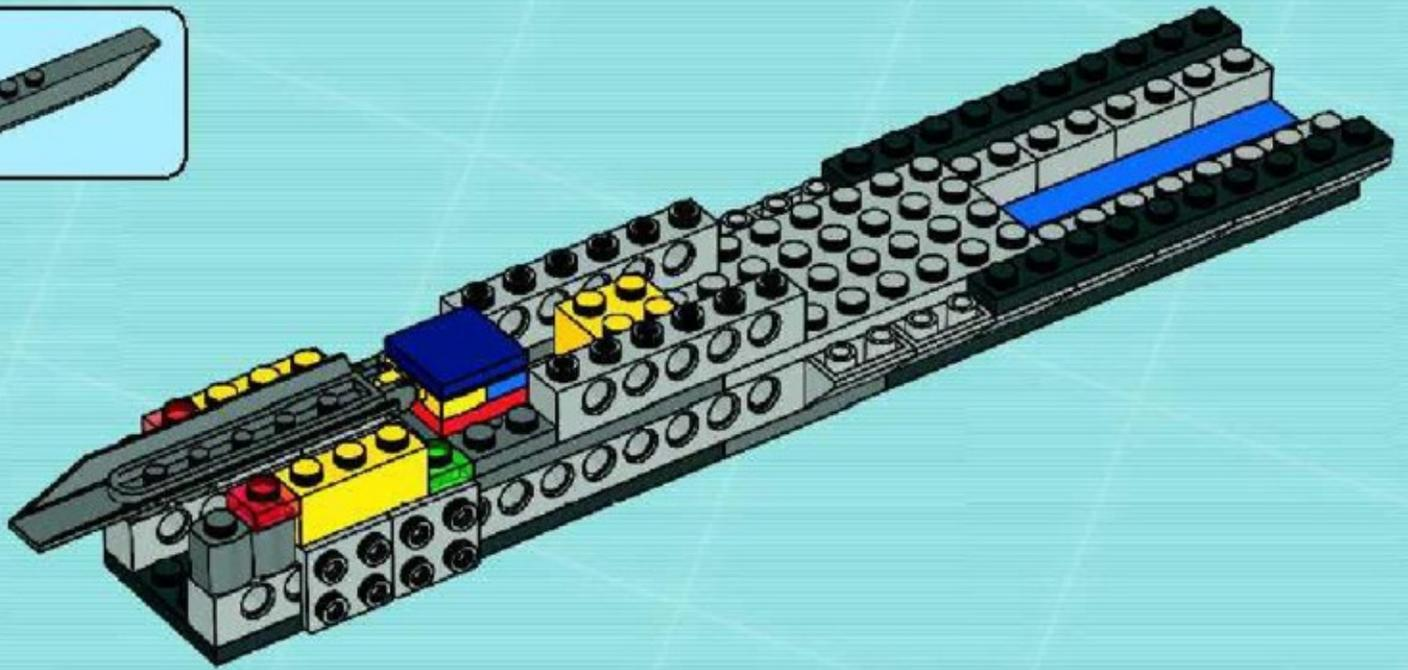

12

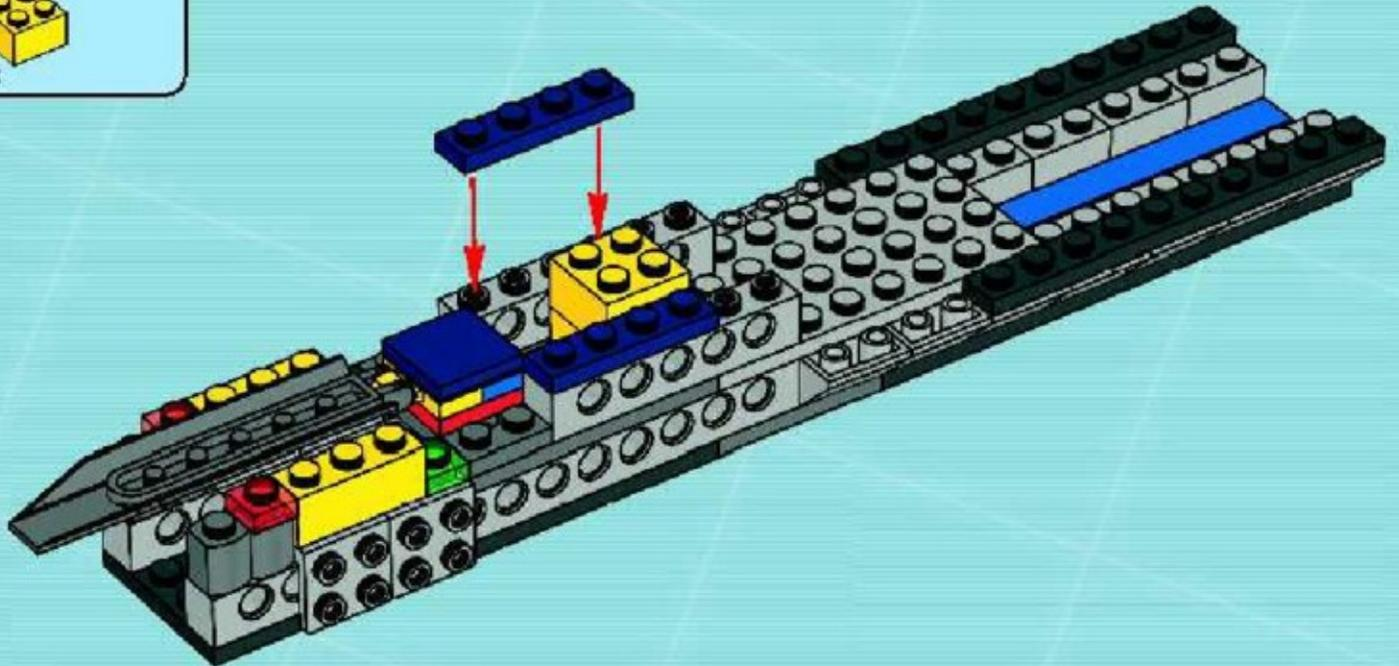



13

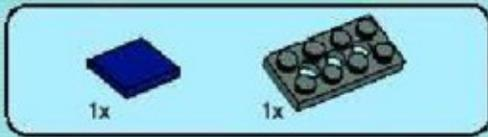
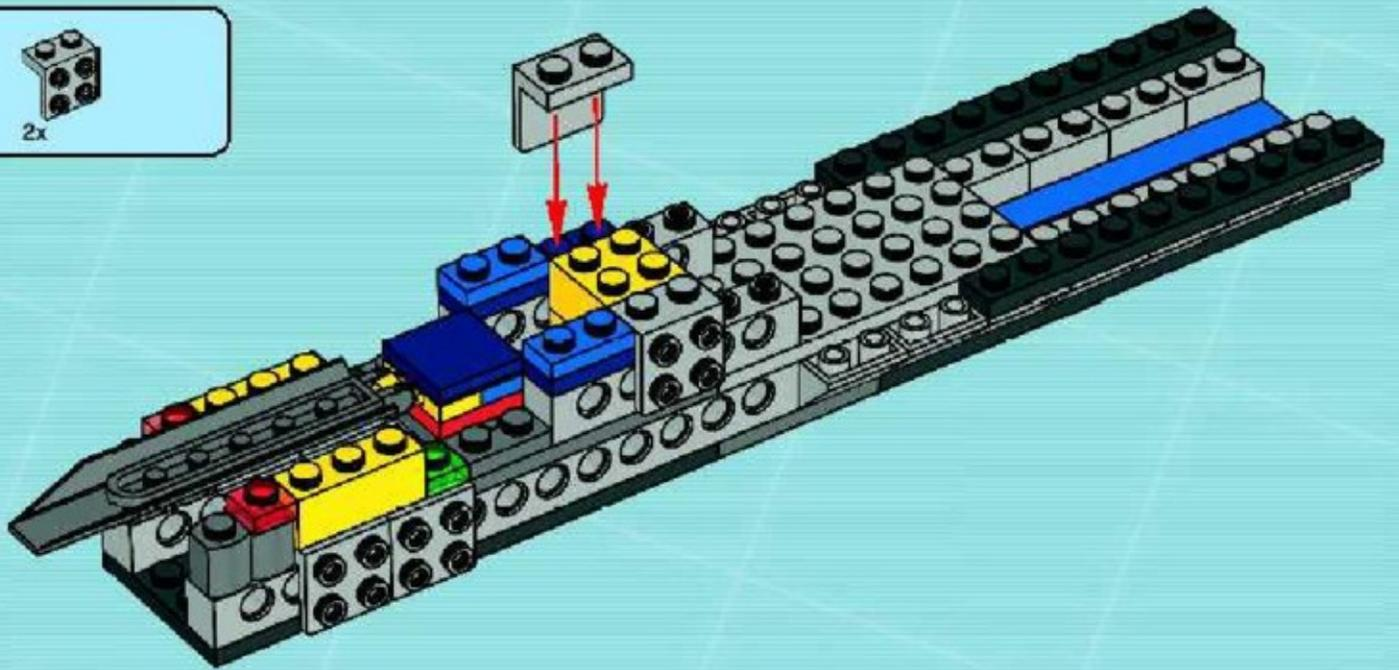

14

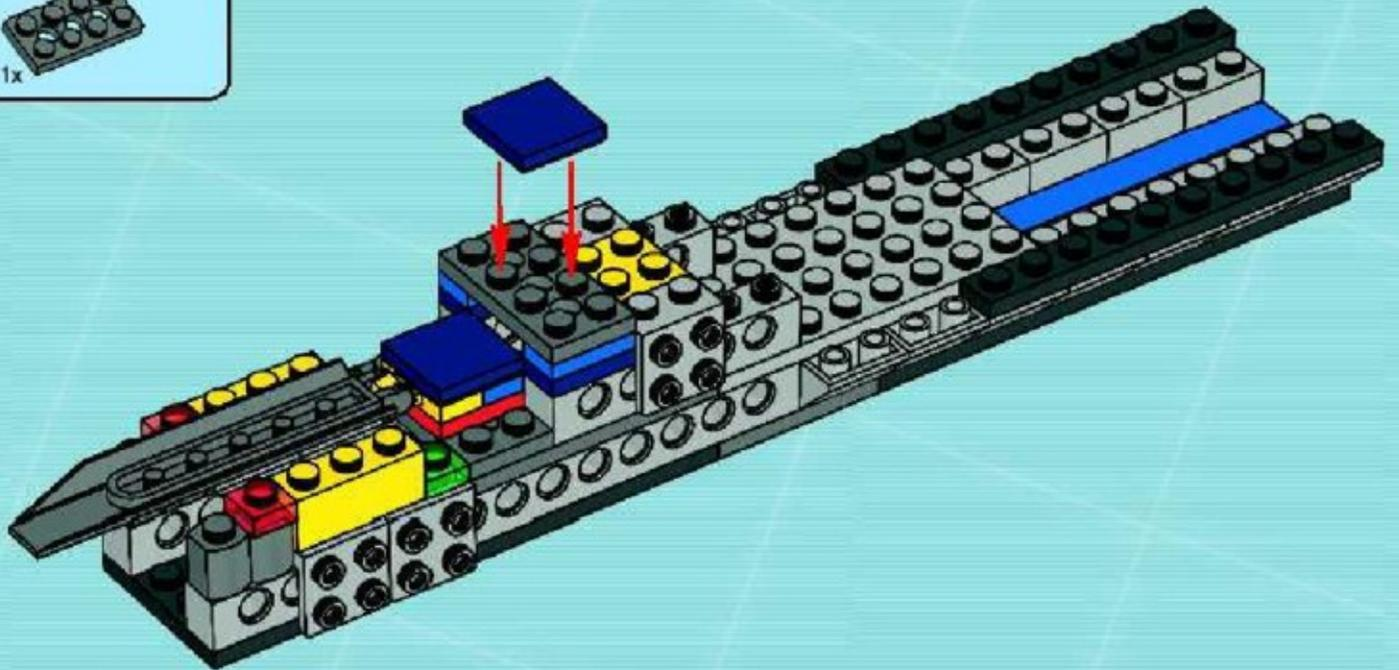

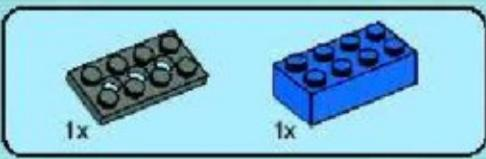

15

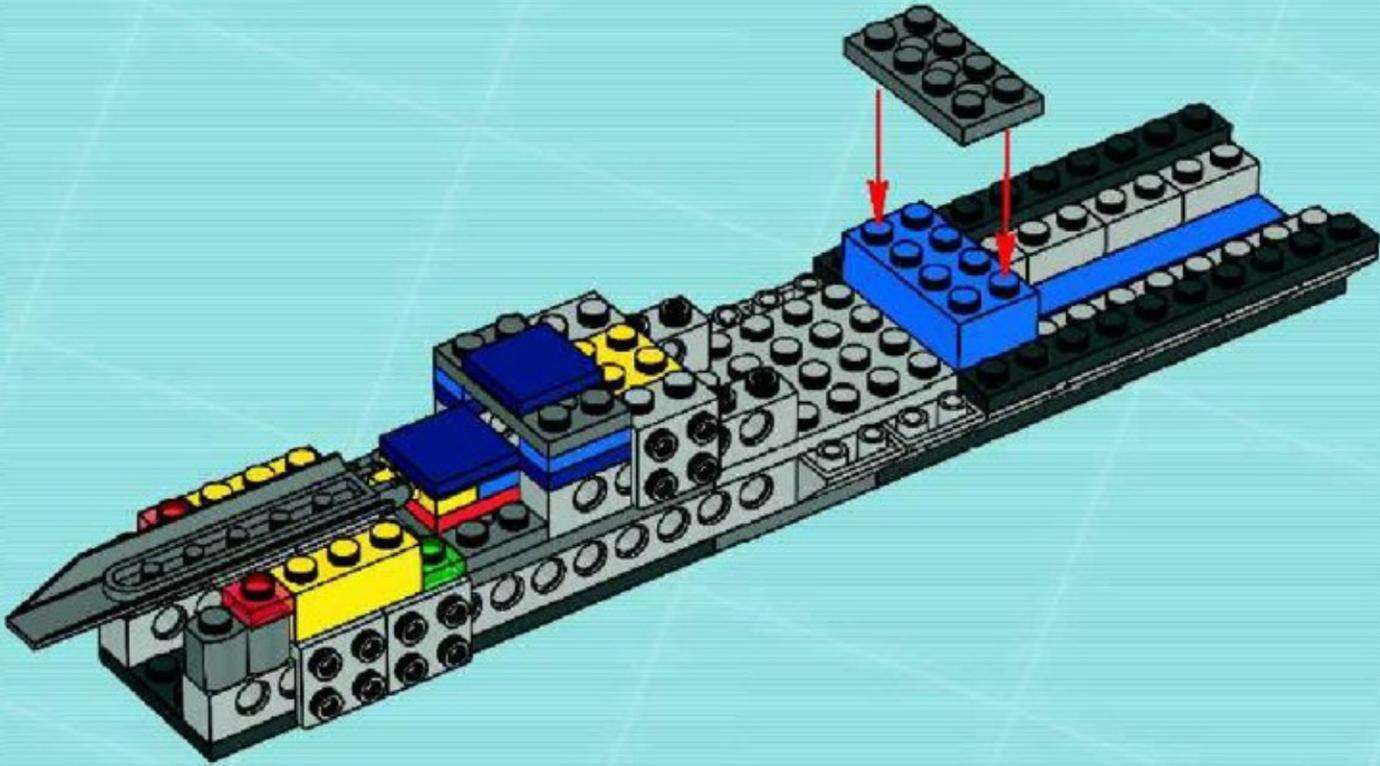

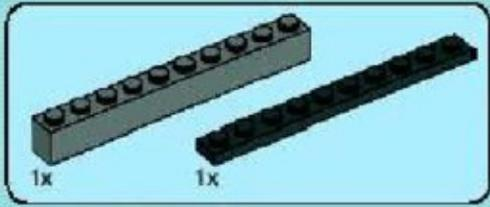
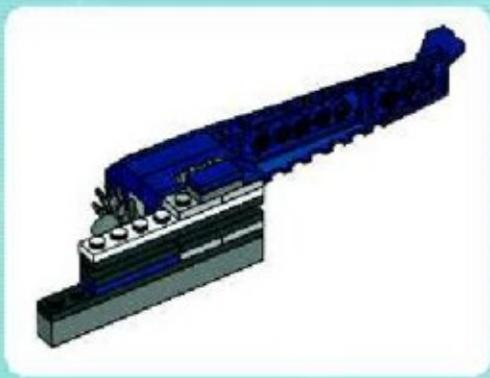

1

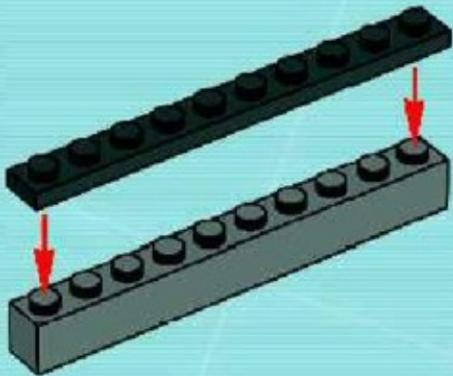

2

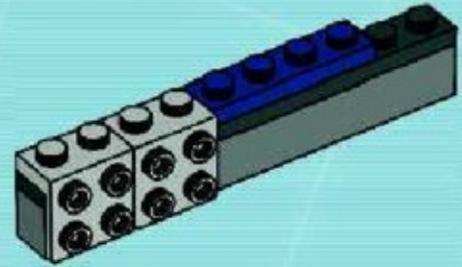

3

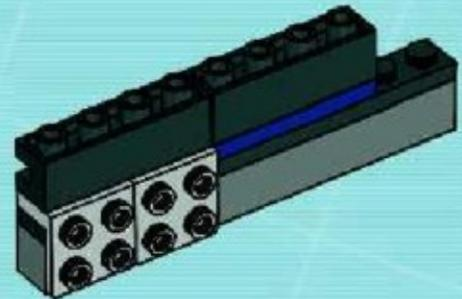

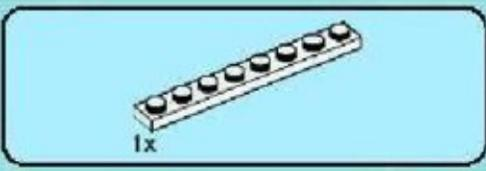

4

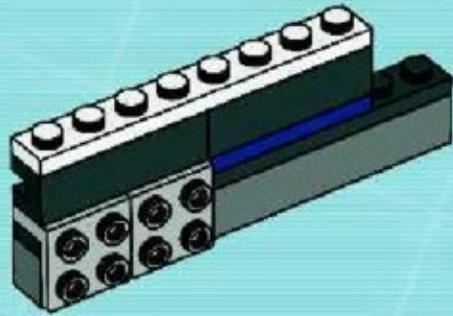

5

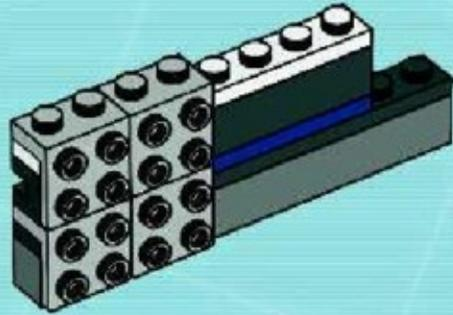

6

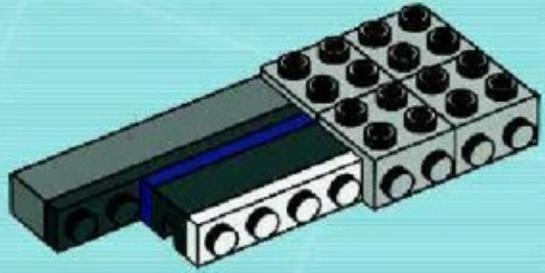

7

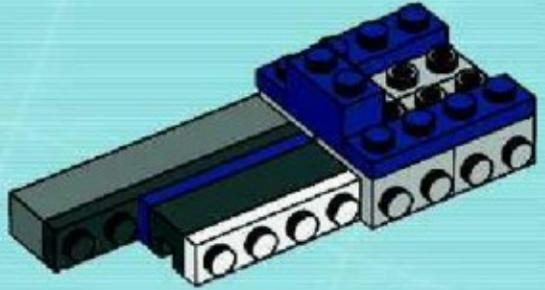

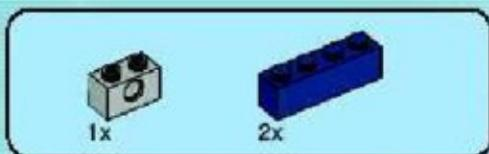

8

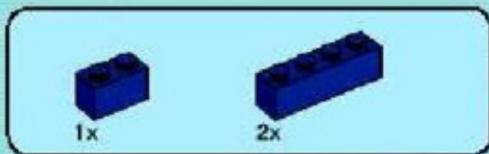
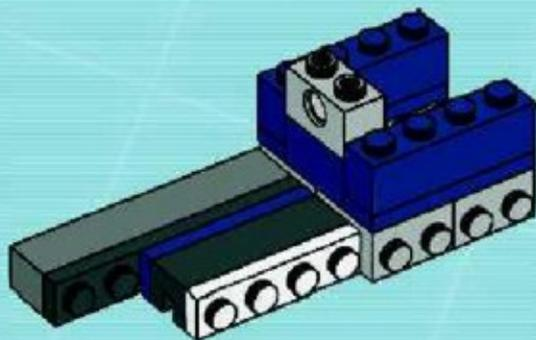

9

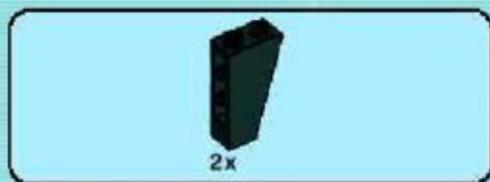
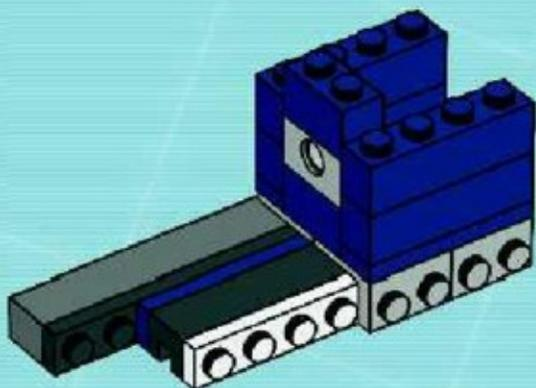

10

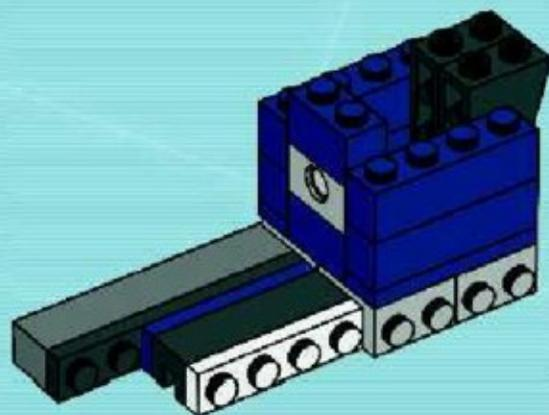

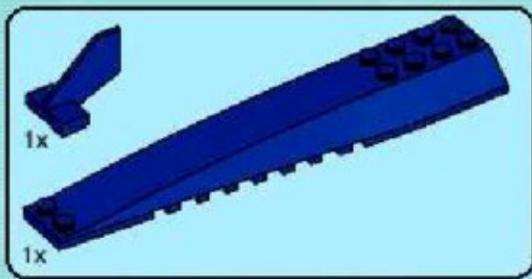

11

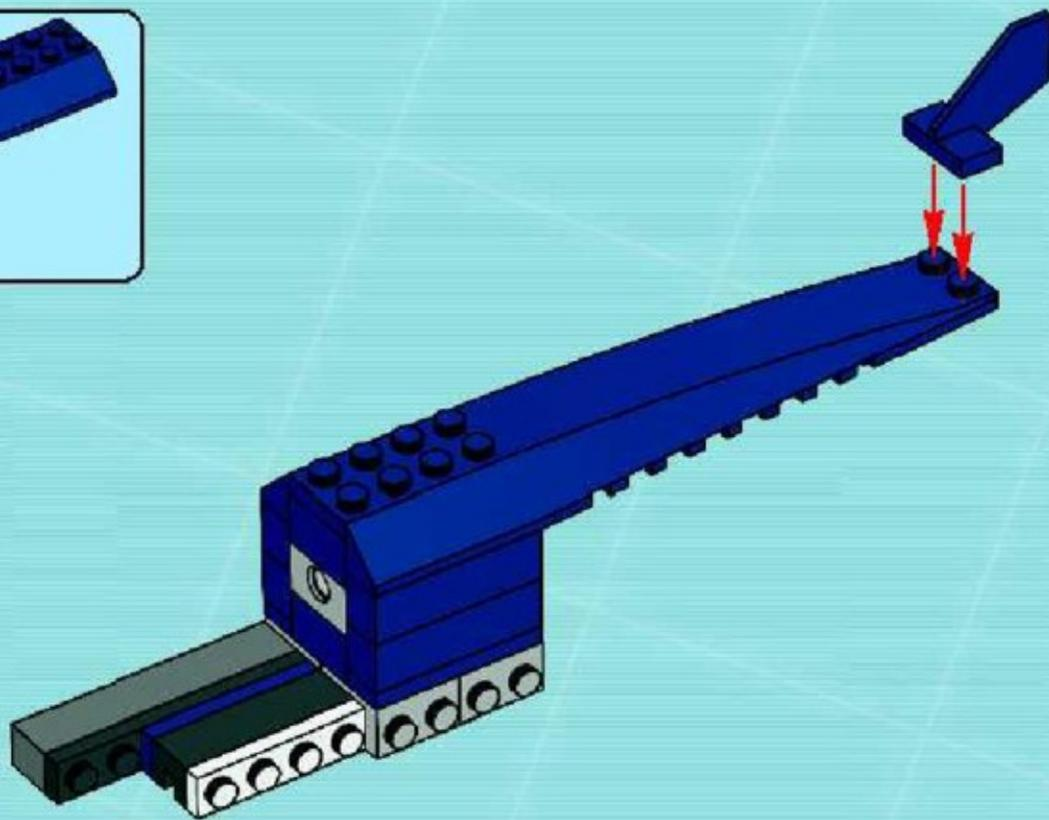

12

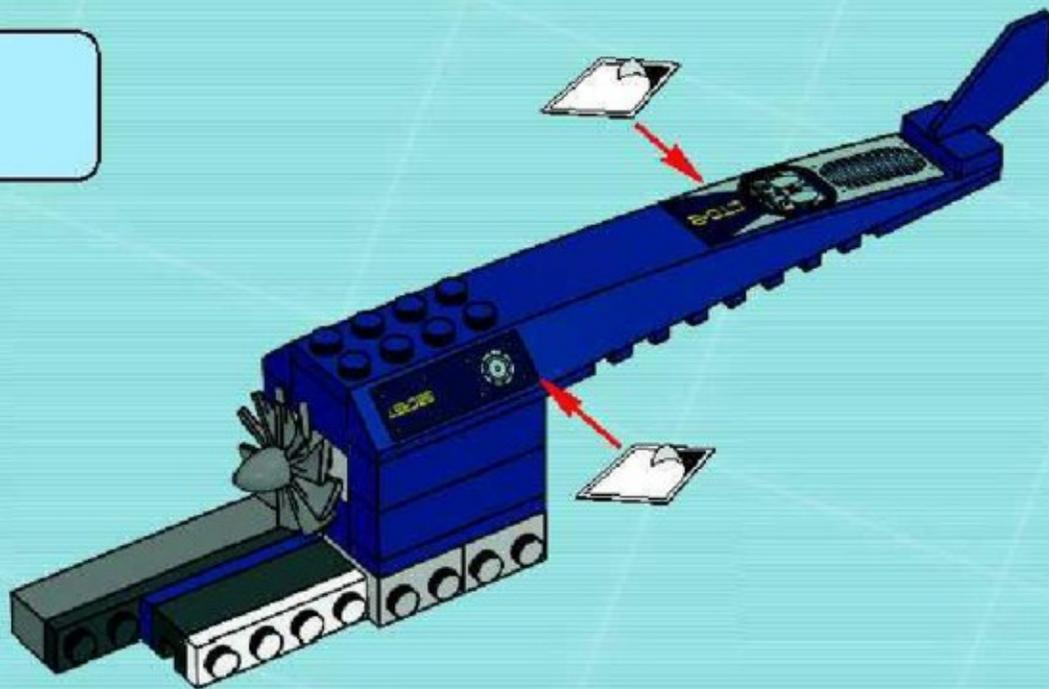

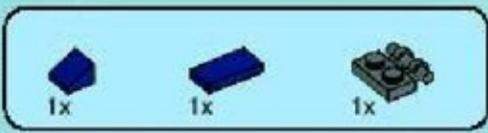

13

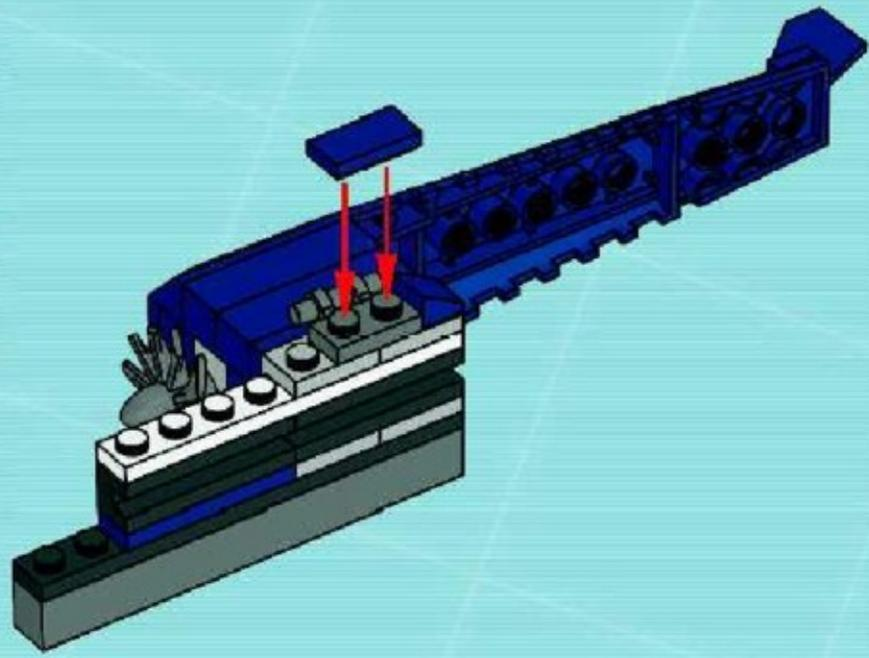

16

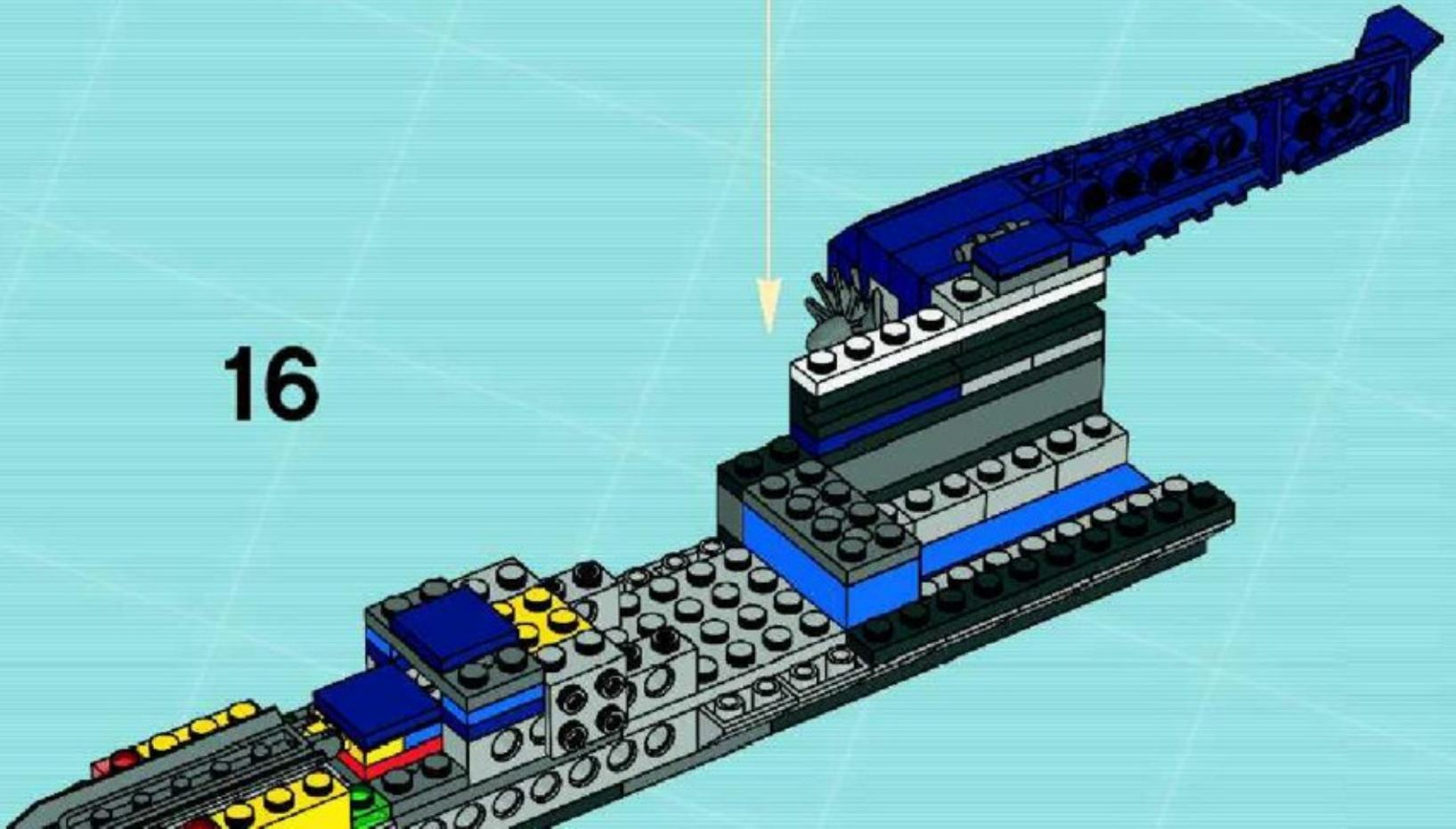

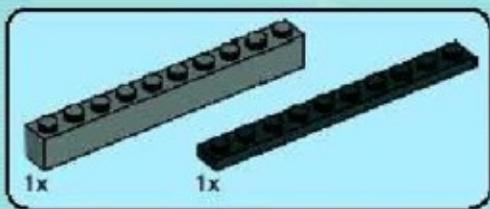

1

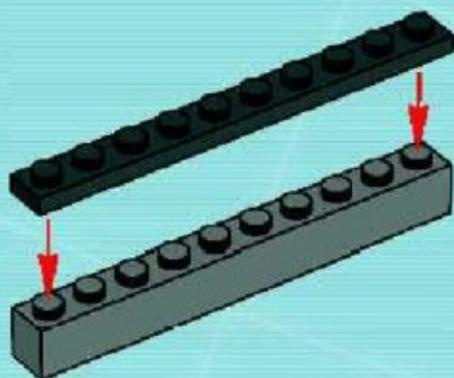

2

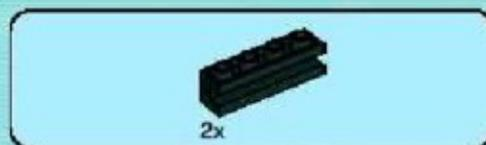
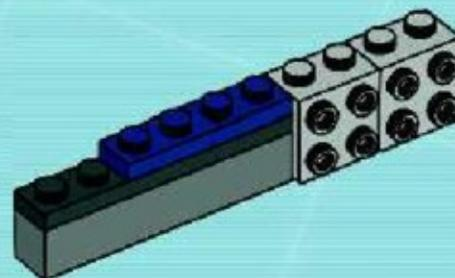

3

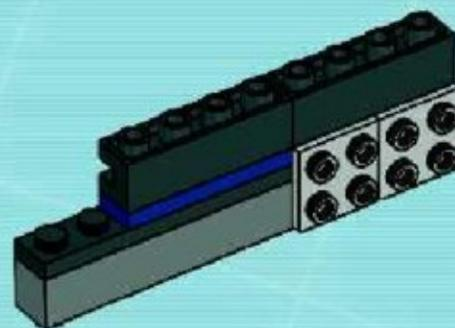

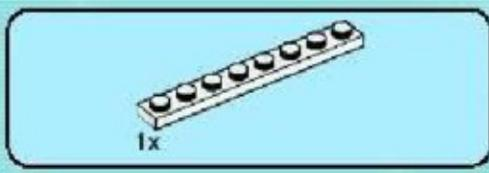

4

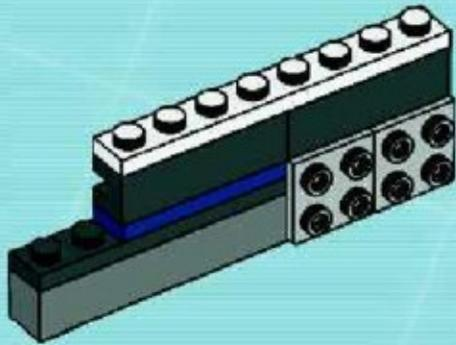

5

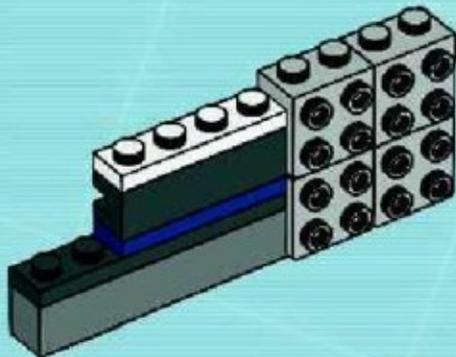

6

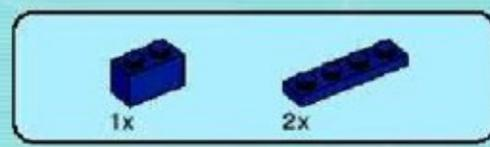
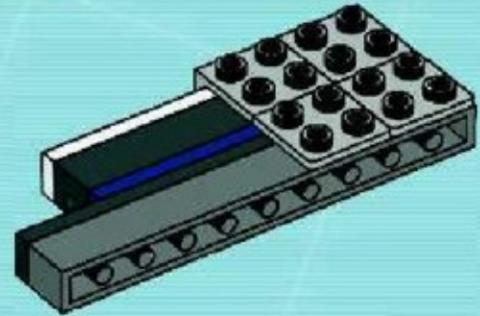

7

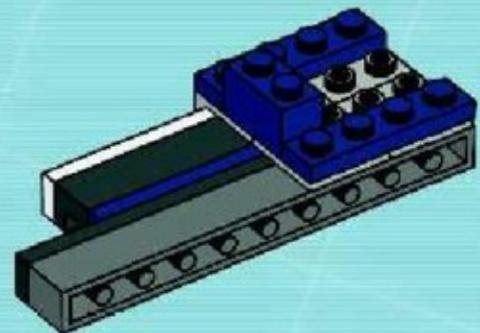

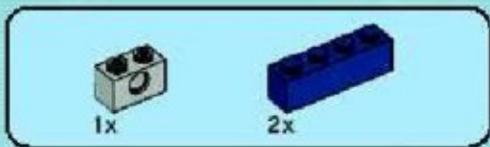

8

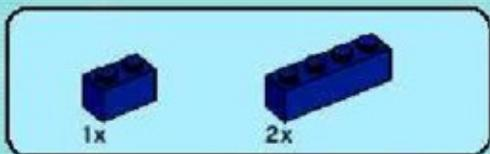
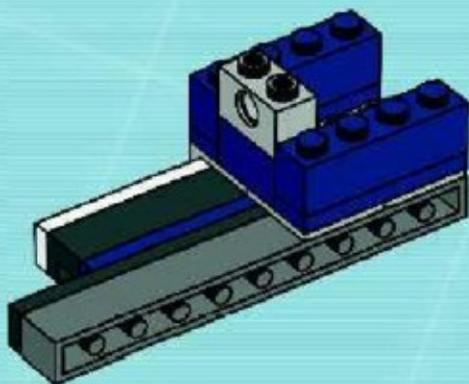

9

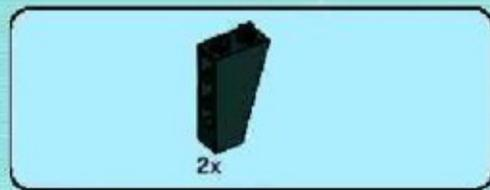
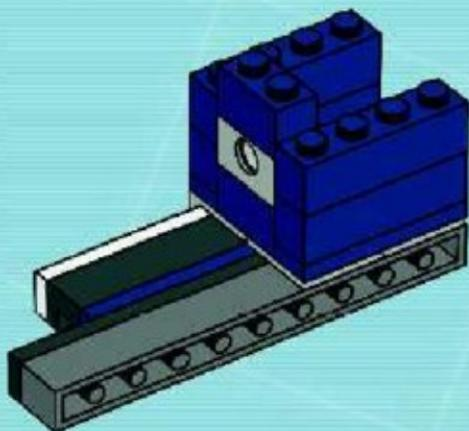

10

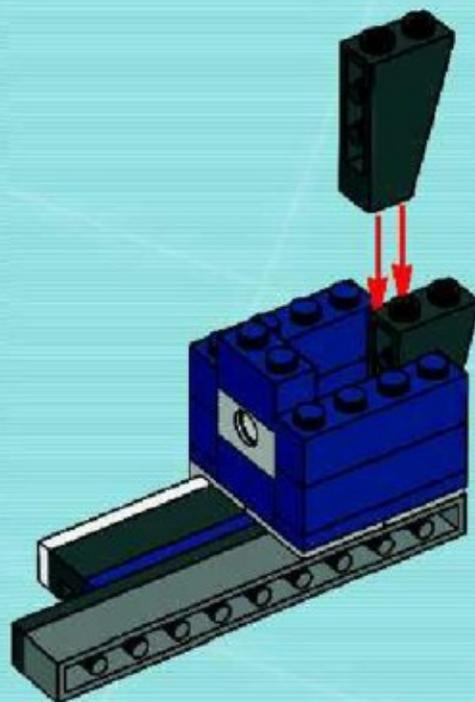

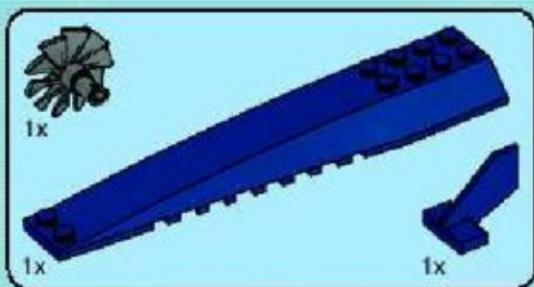

11

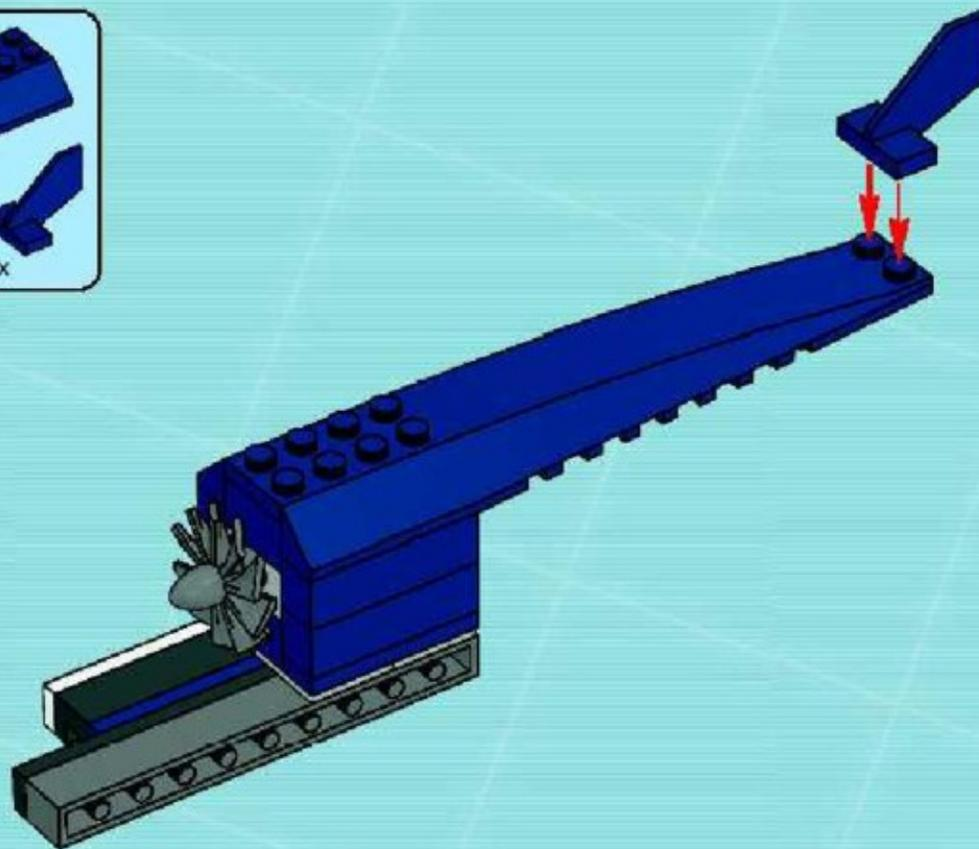

12

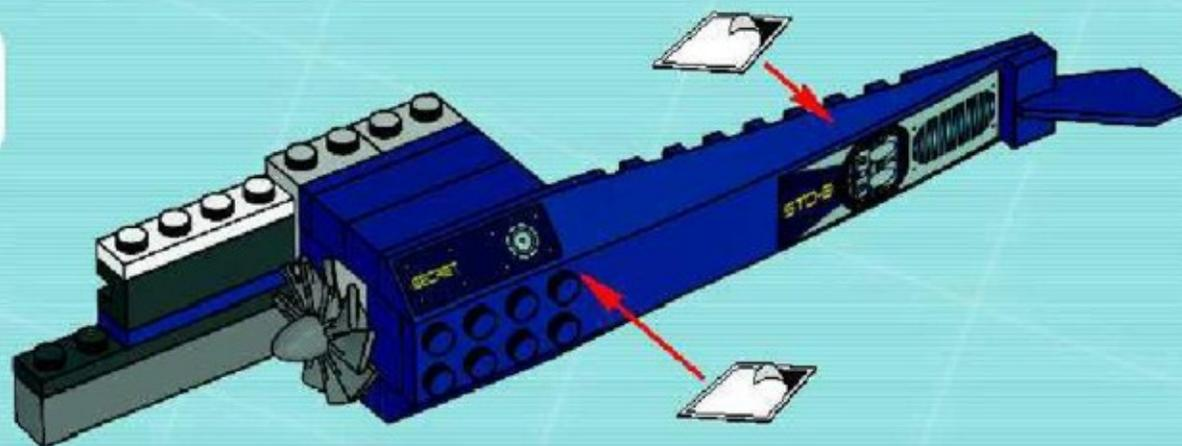

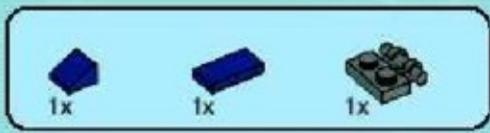

13

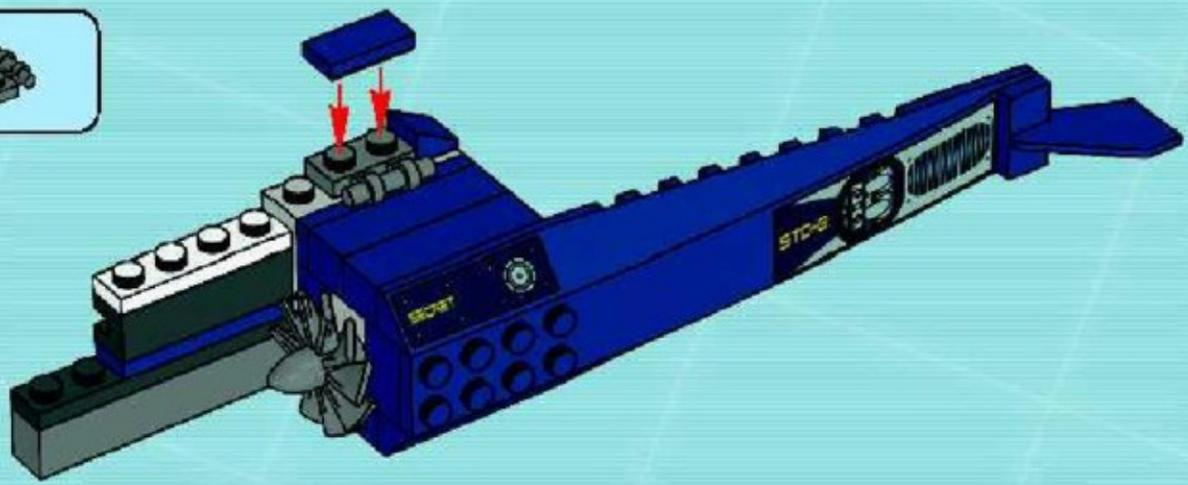

17

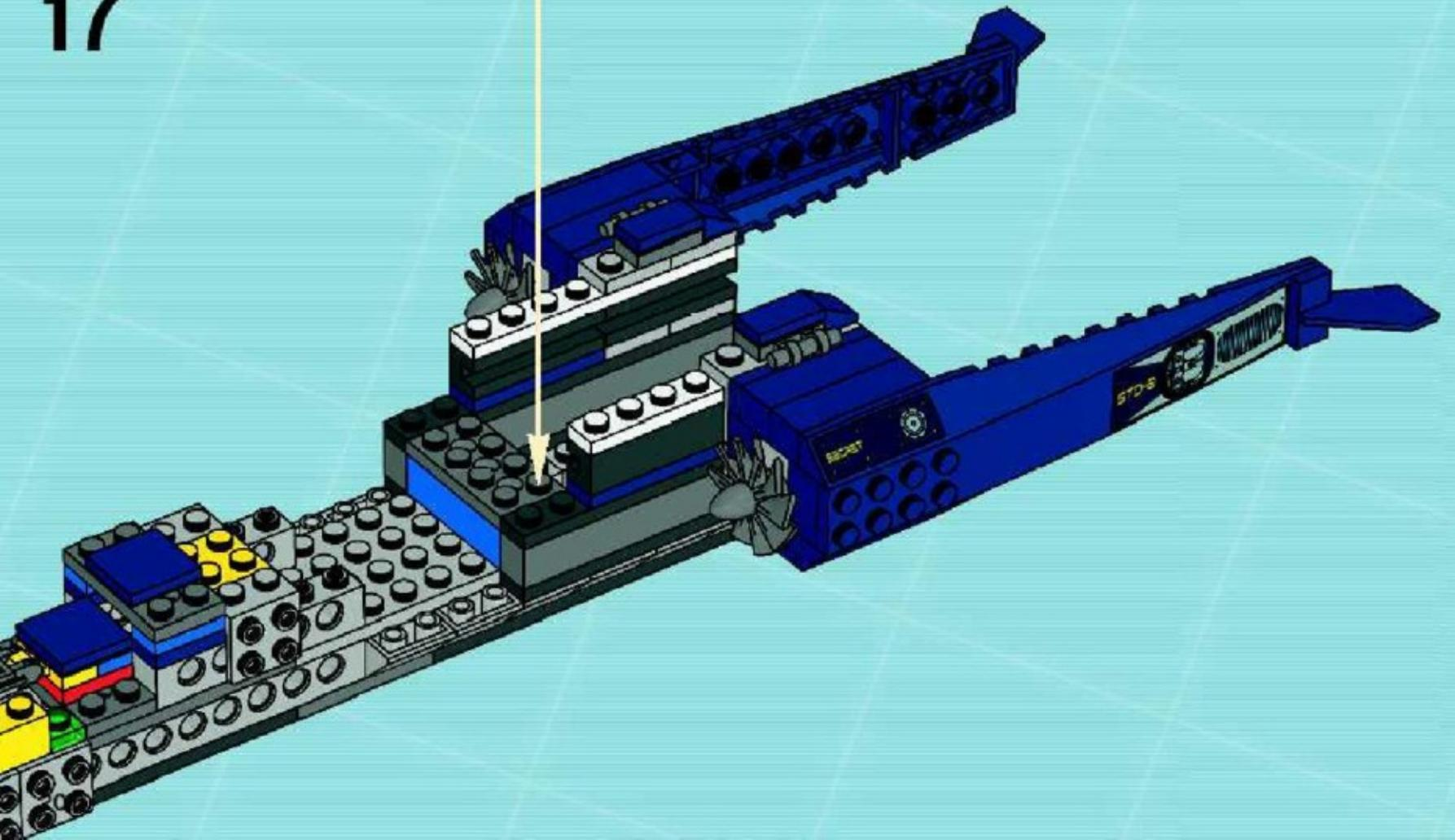



4



1x

18

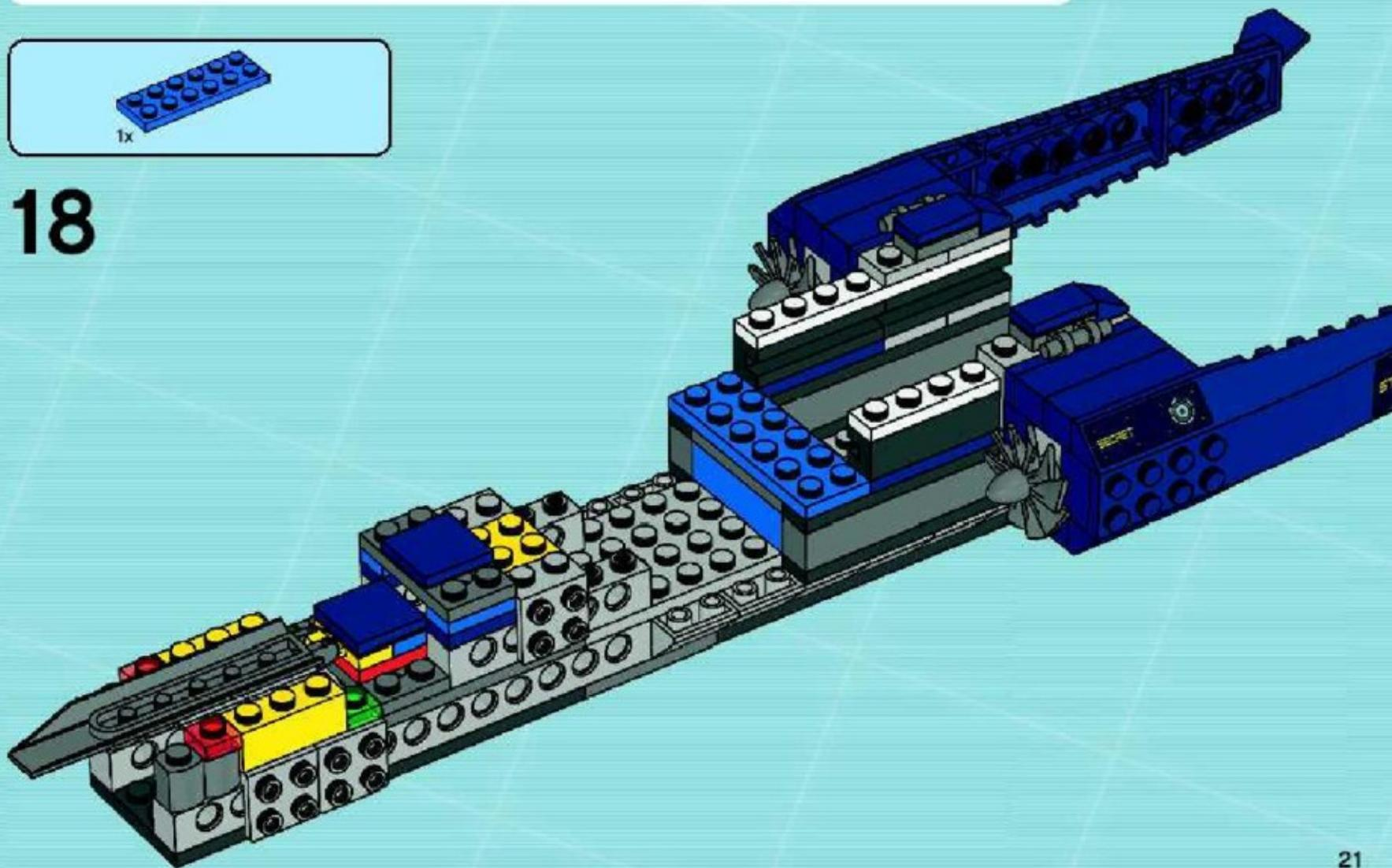



2x



1x

19

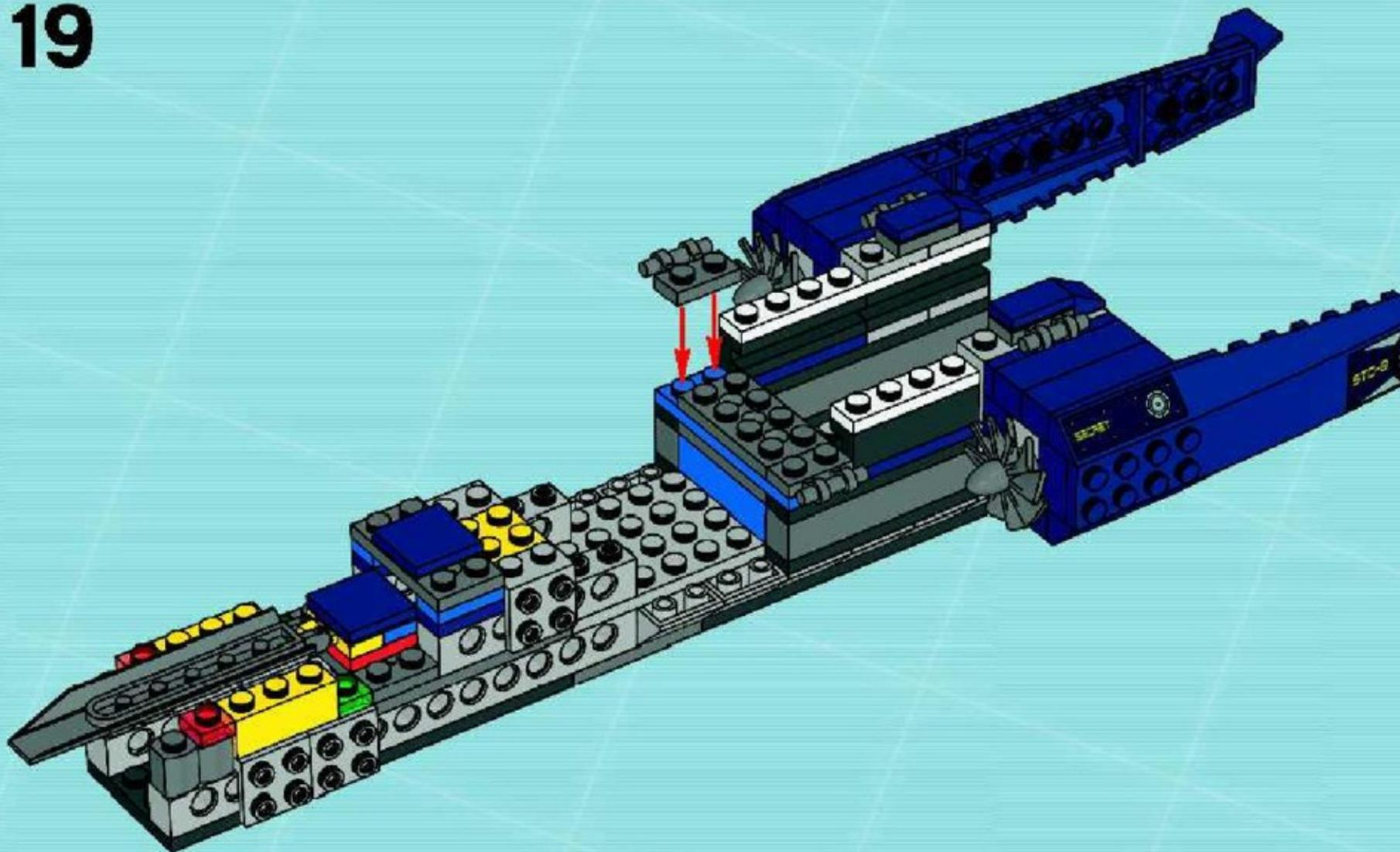

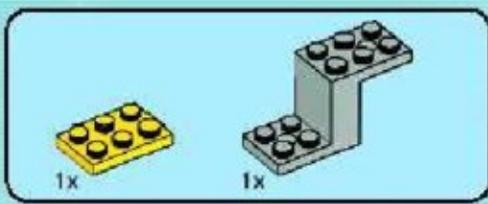

20

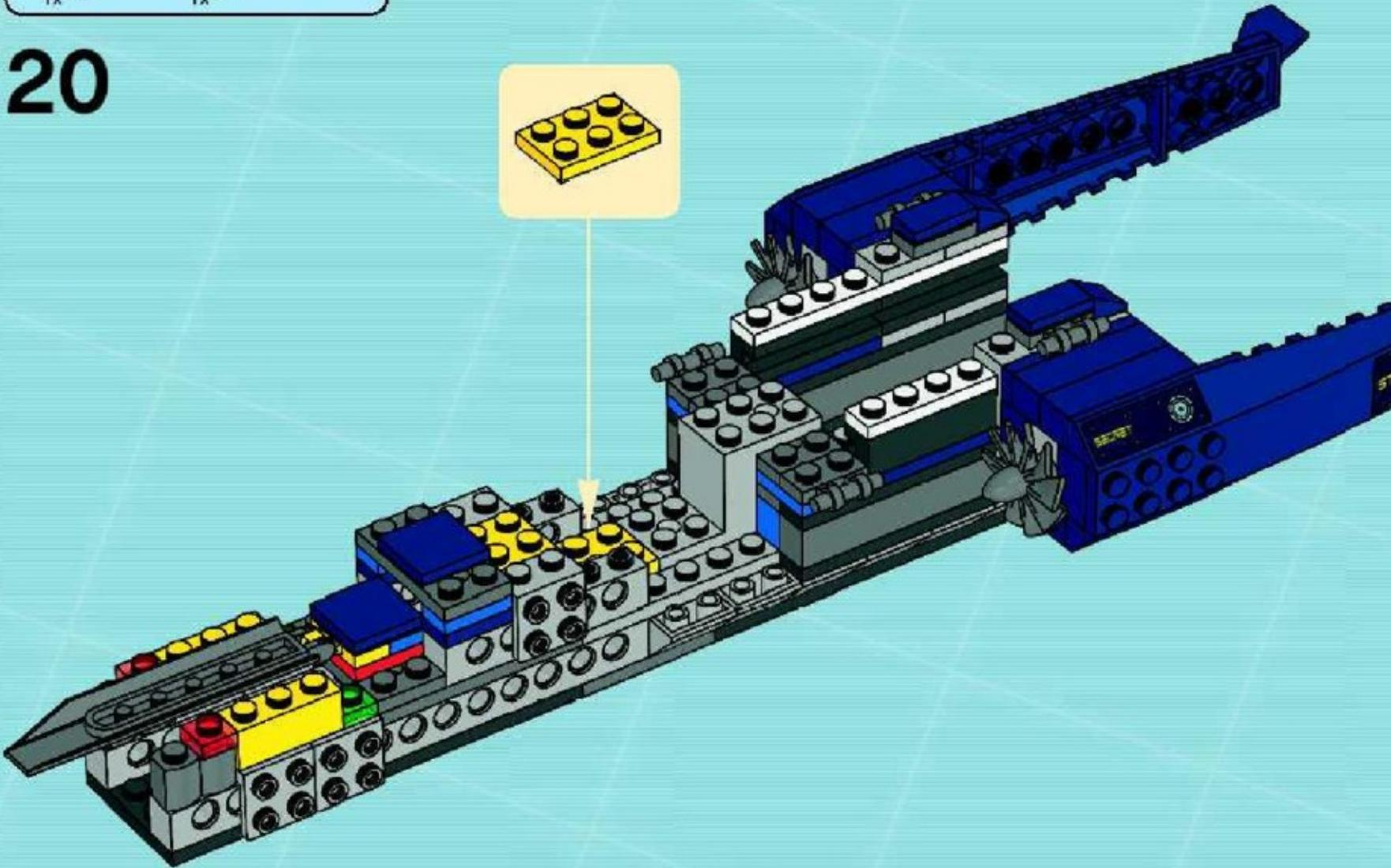



21

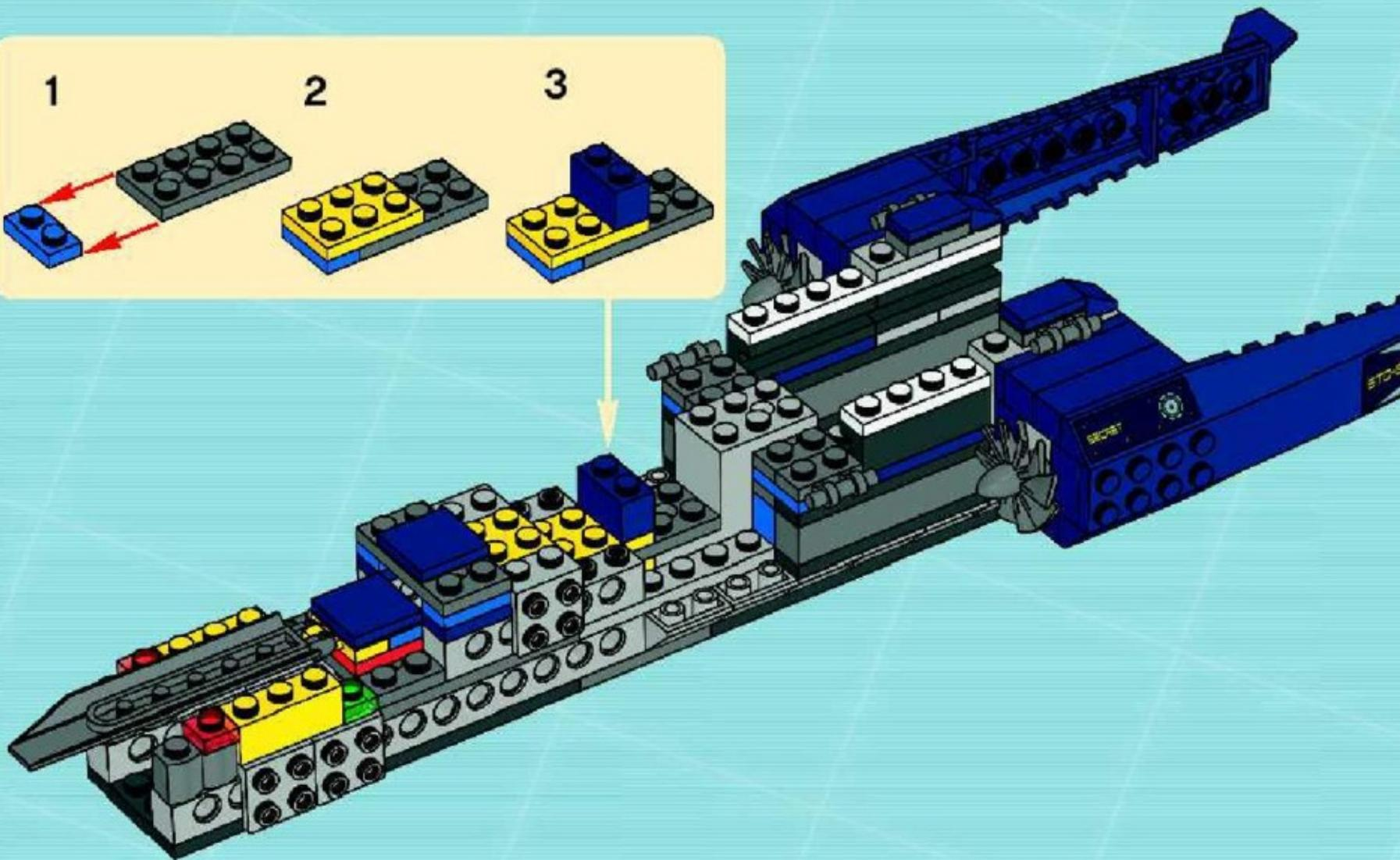
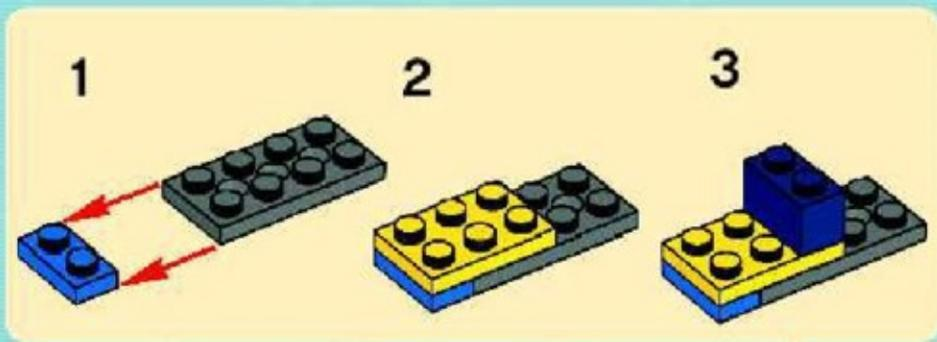

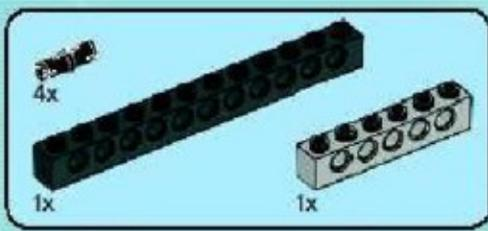

22

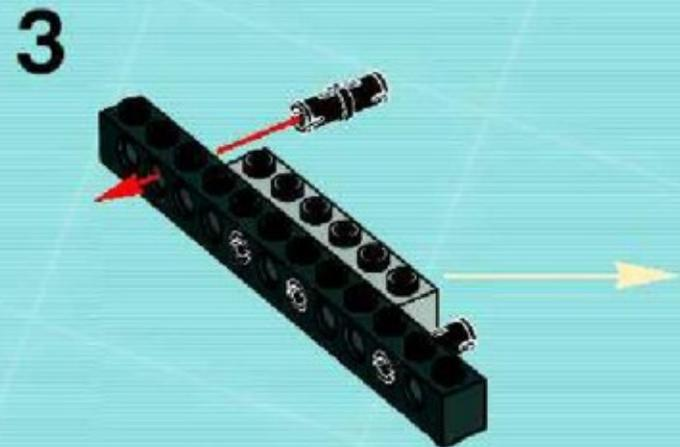
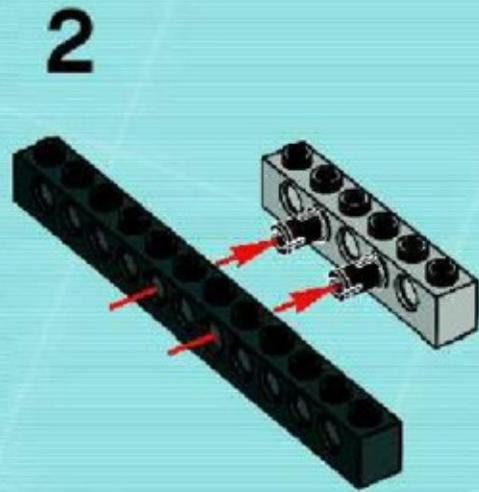
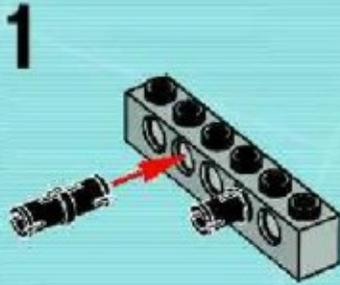

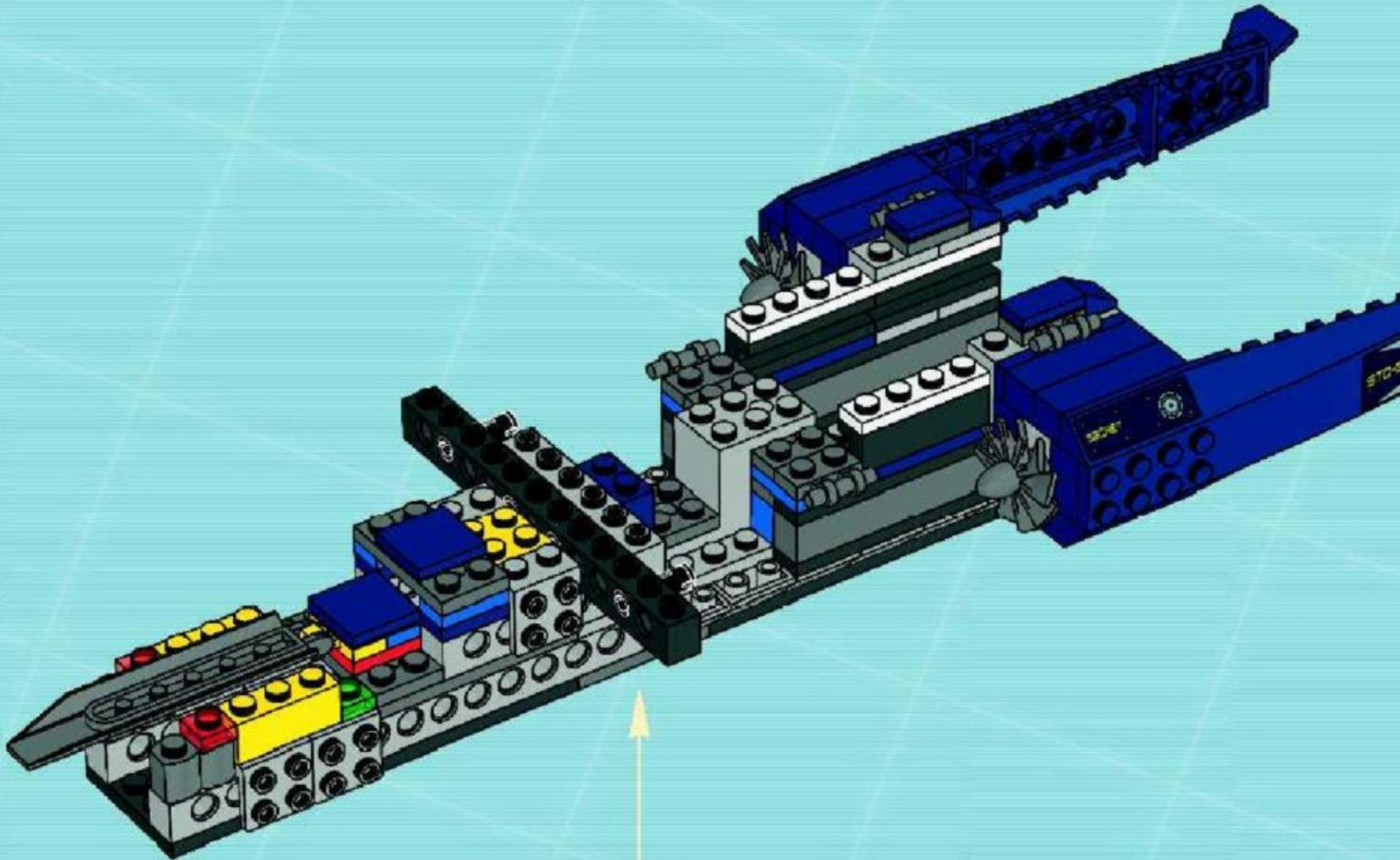



1x

24

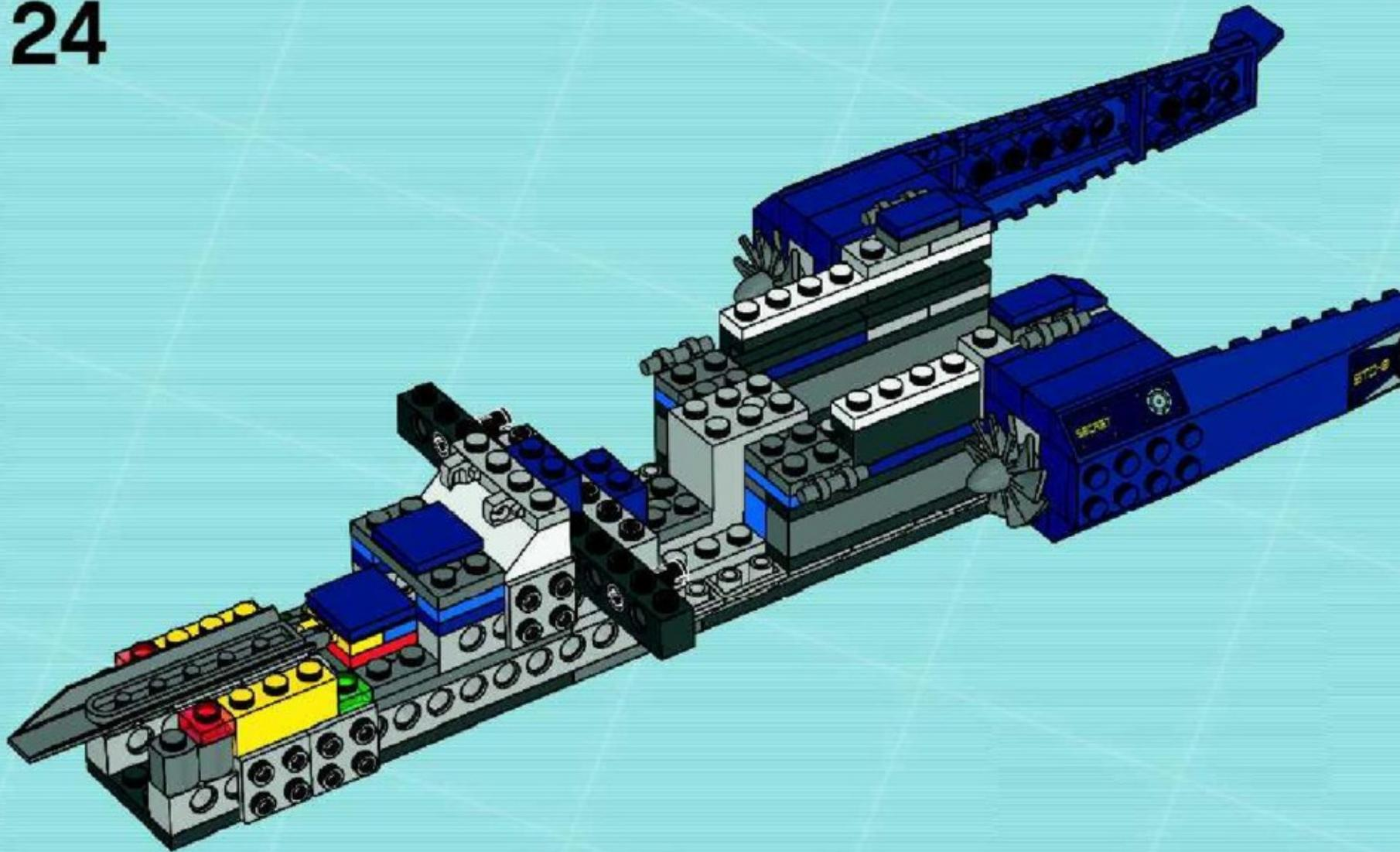



25

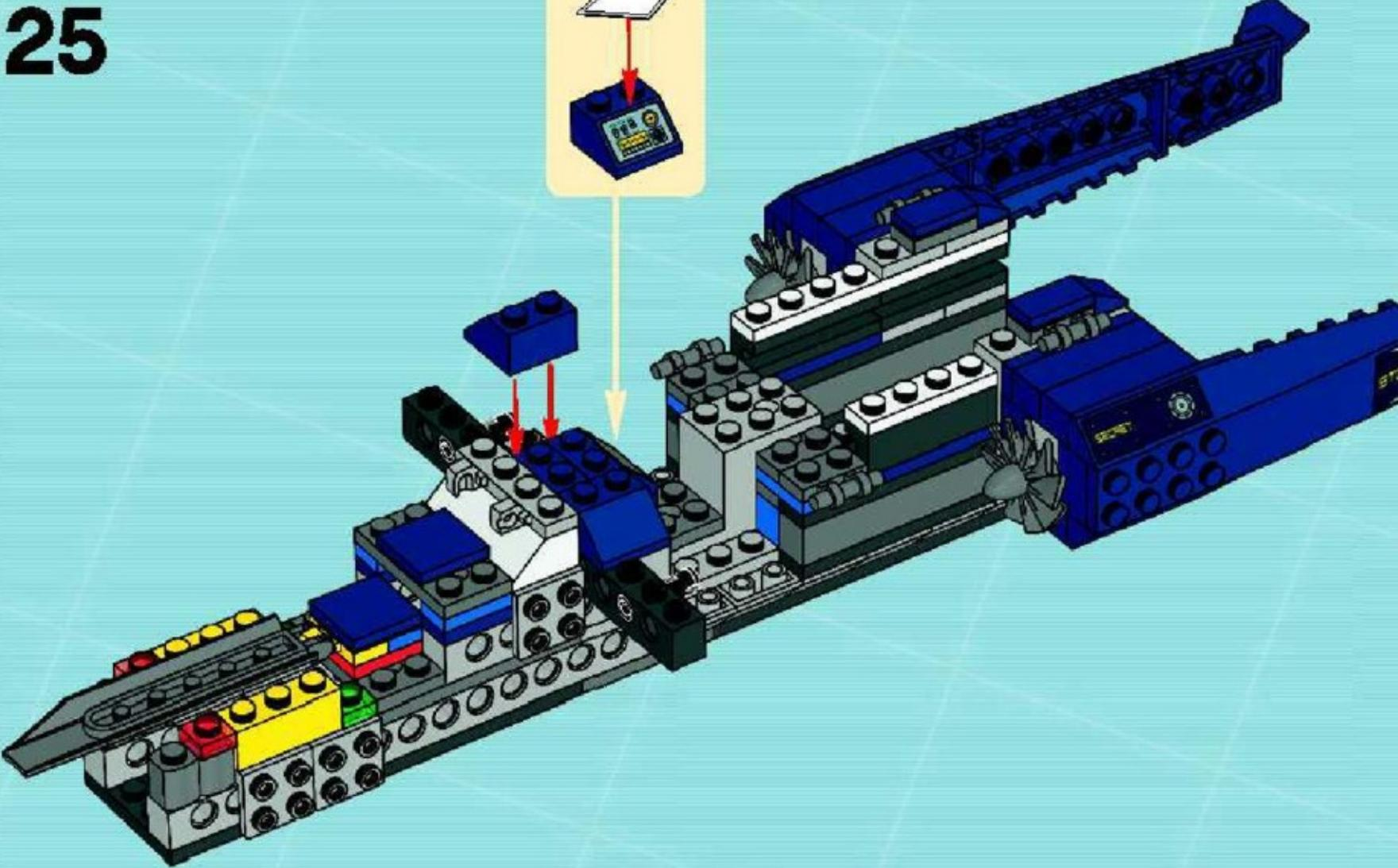
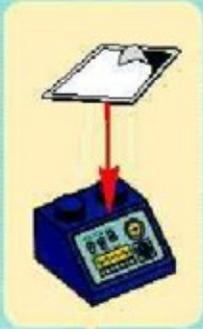



26

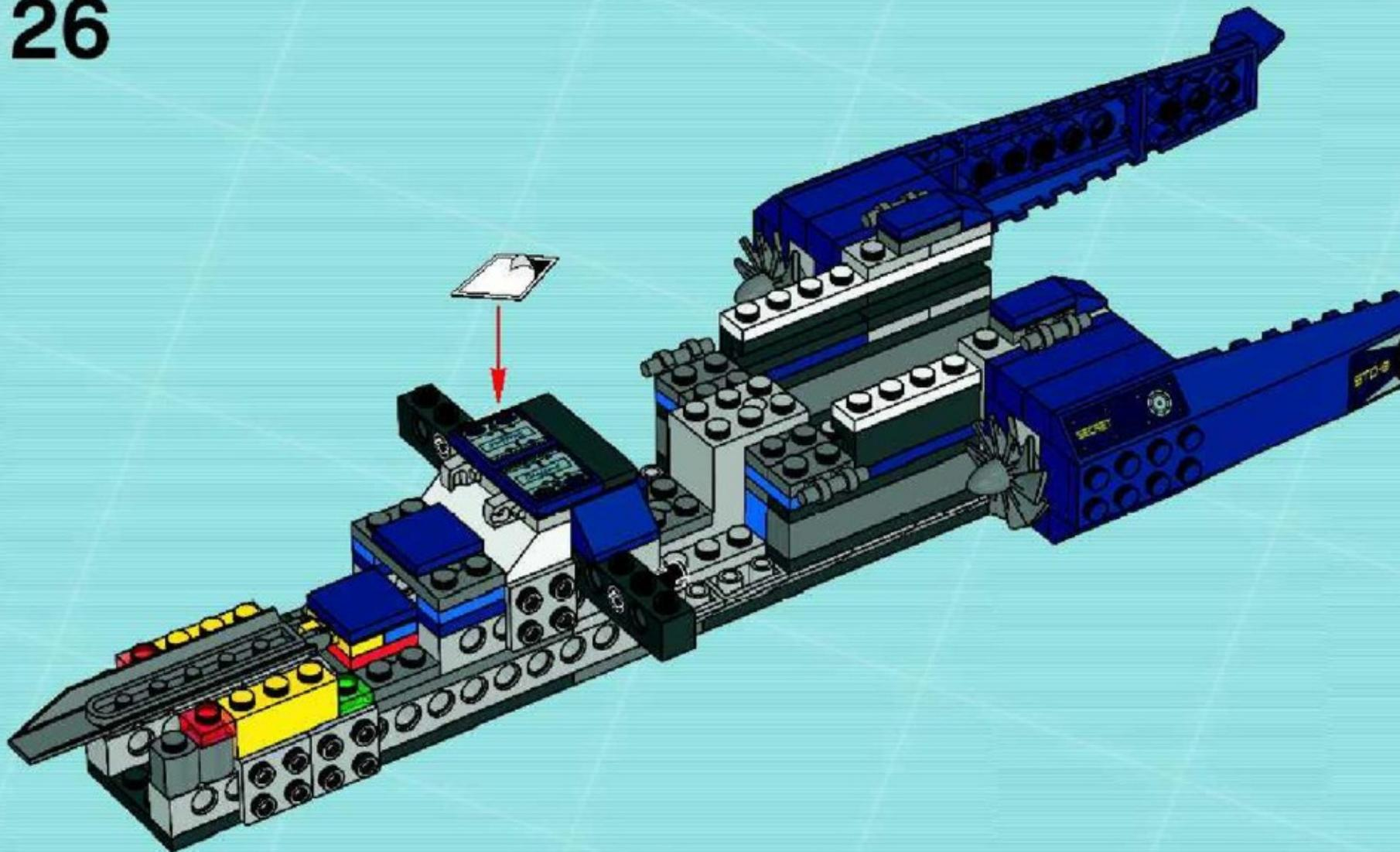

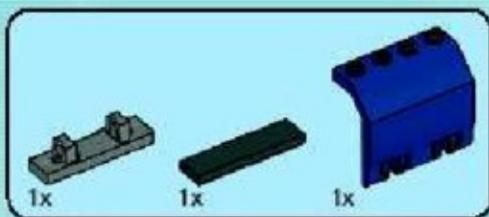

27

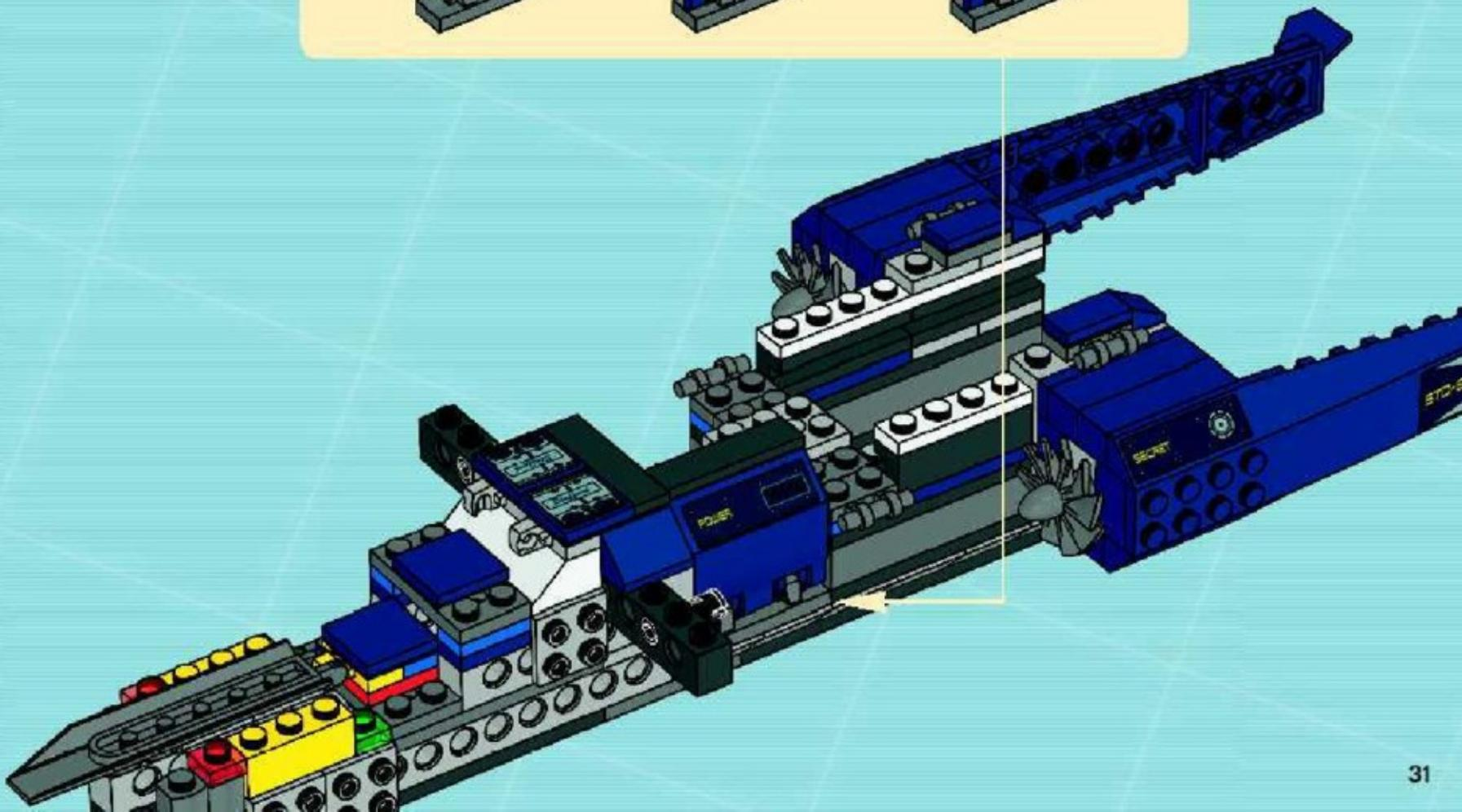
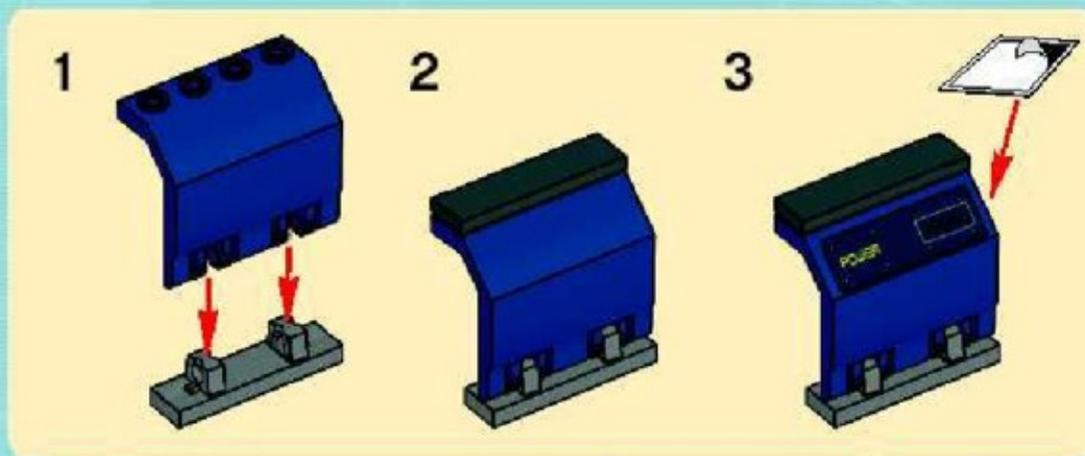

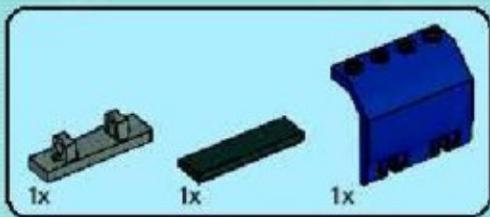

28

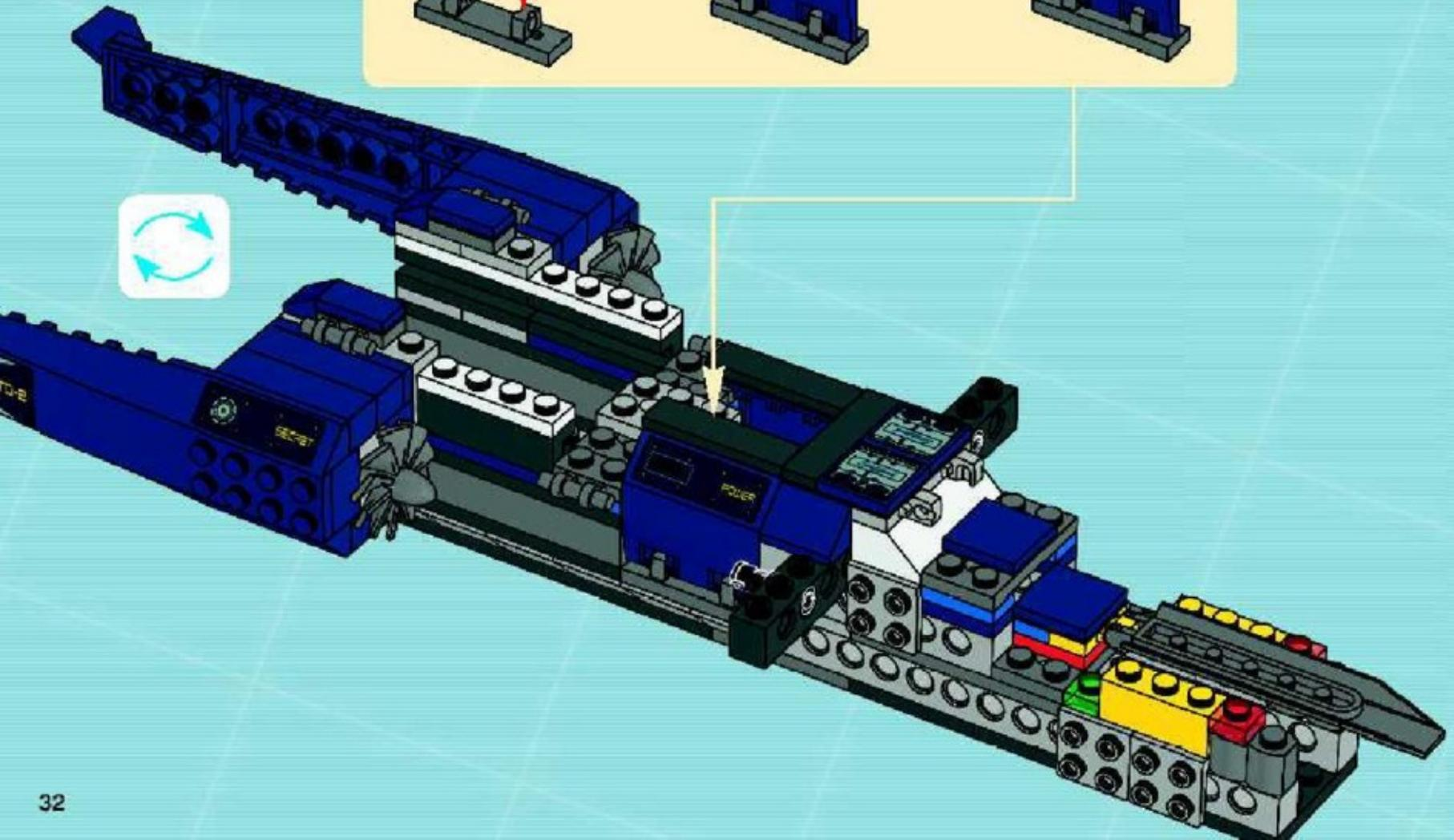
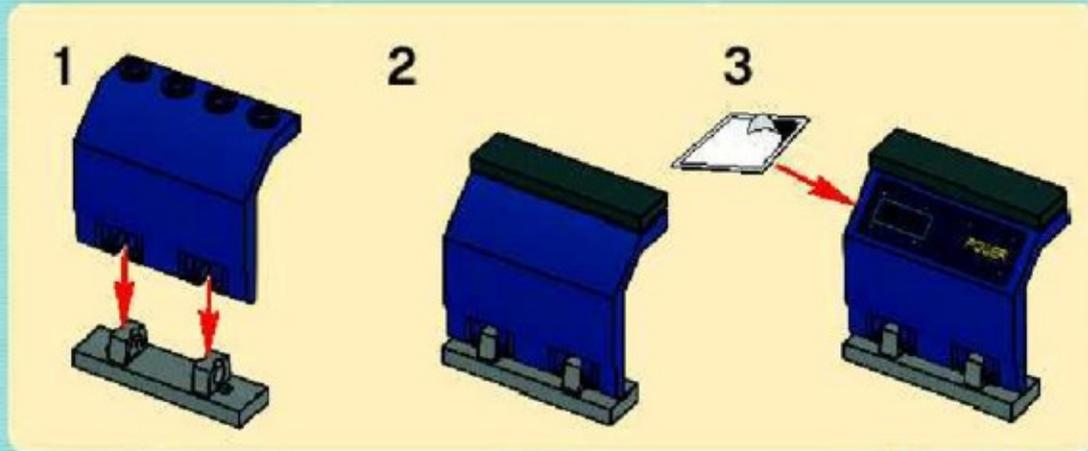



1x



3x

29

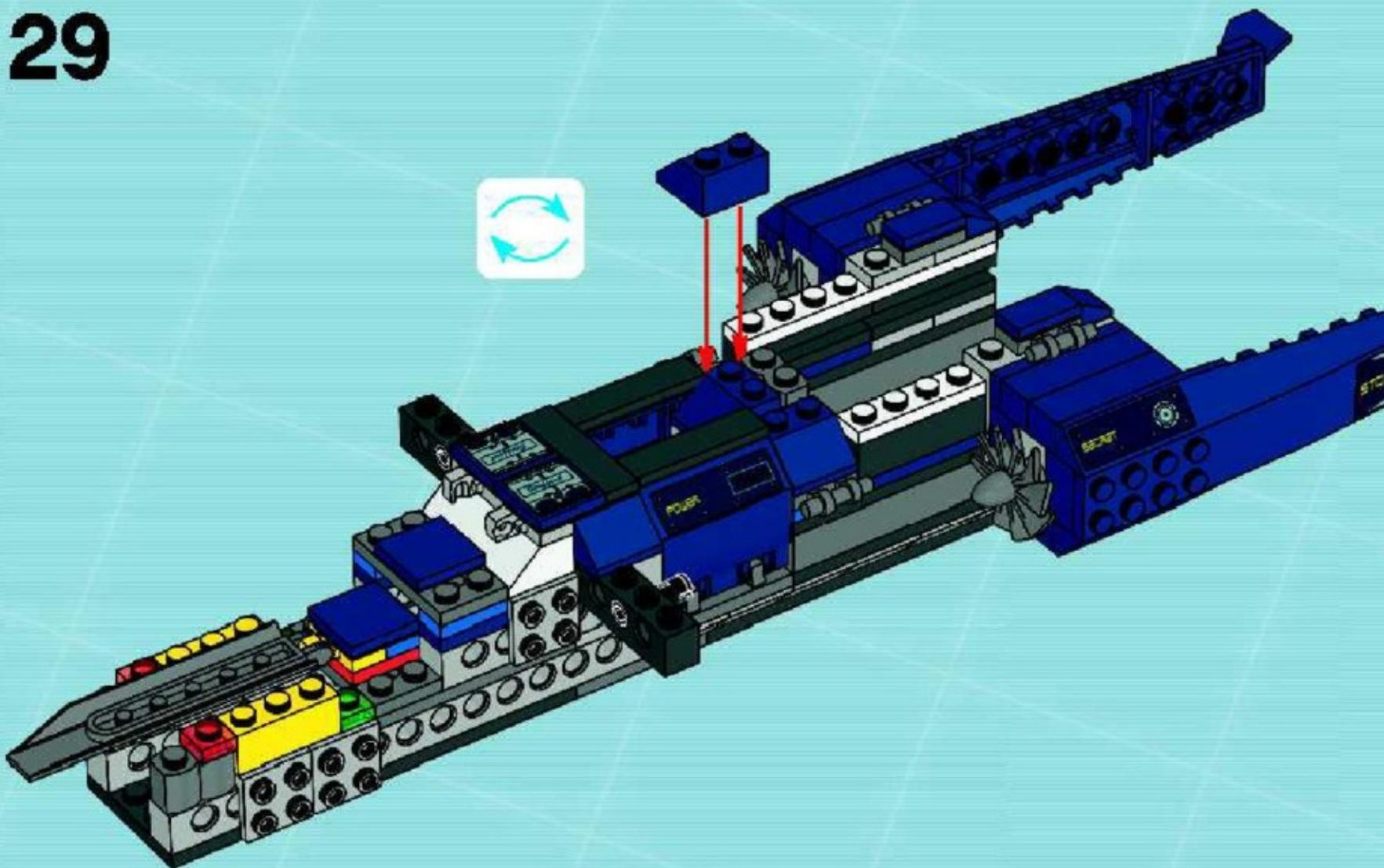



2x

30

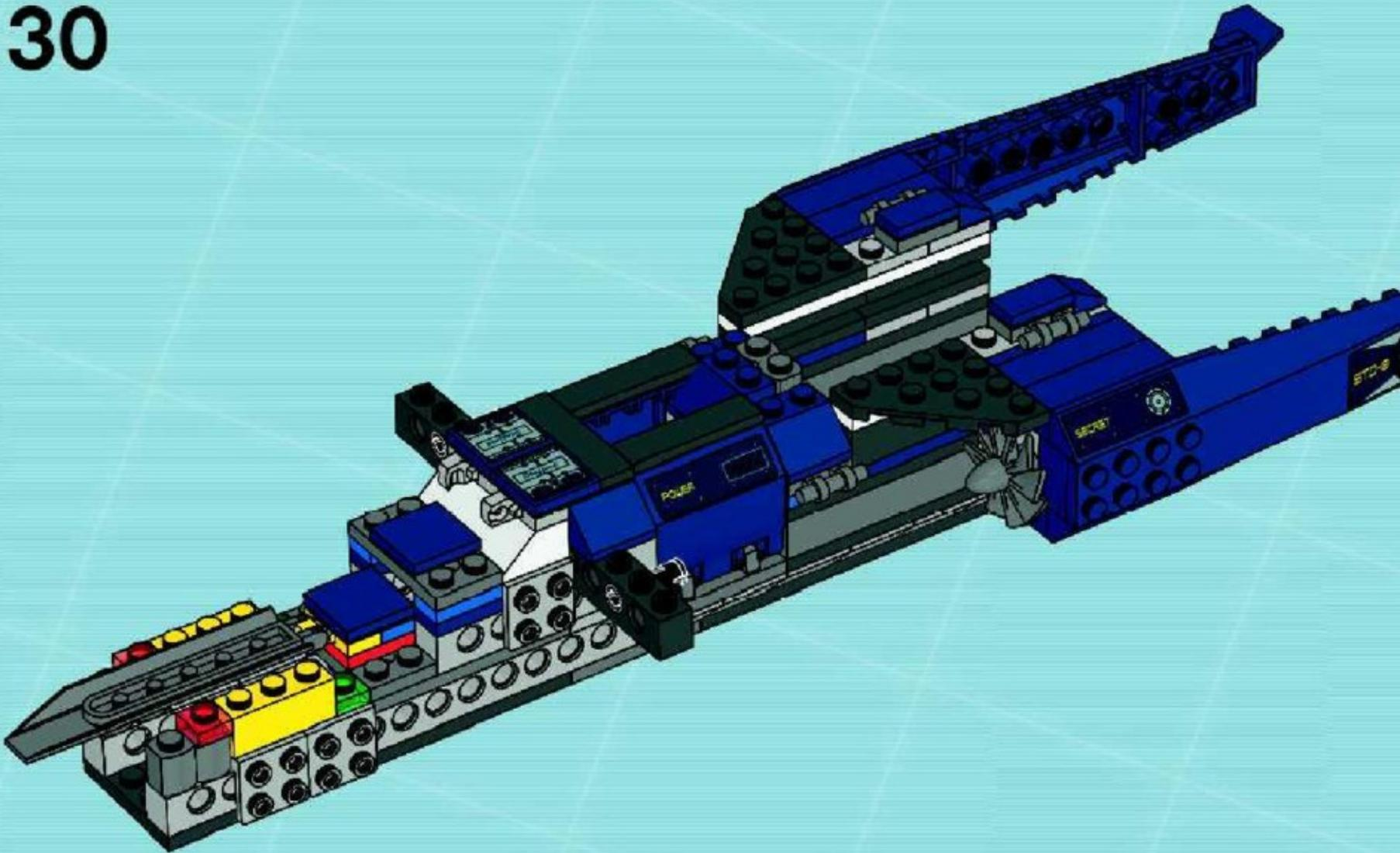



31

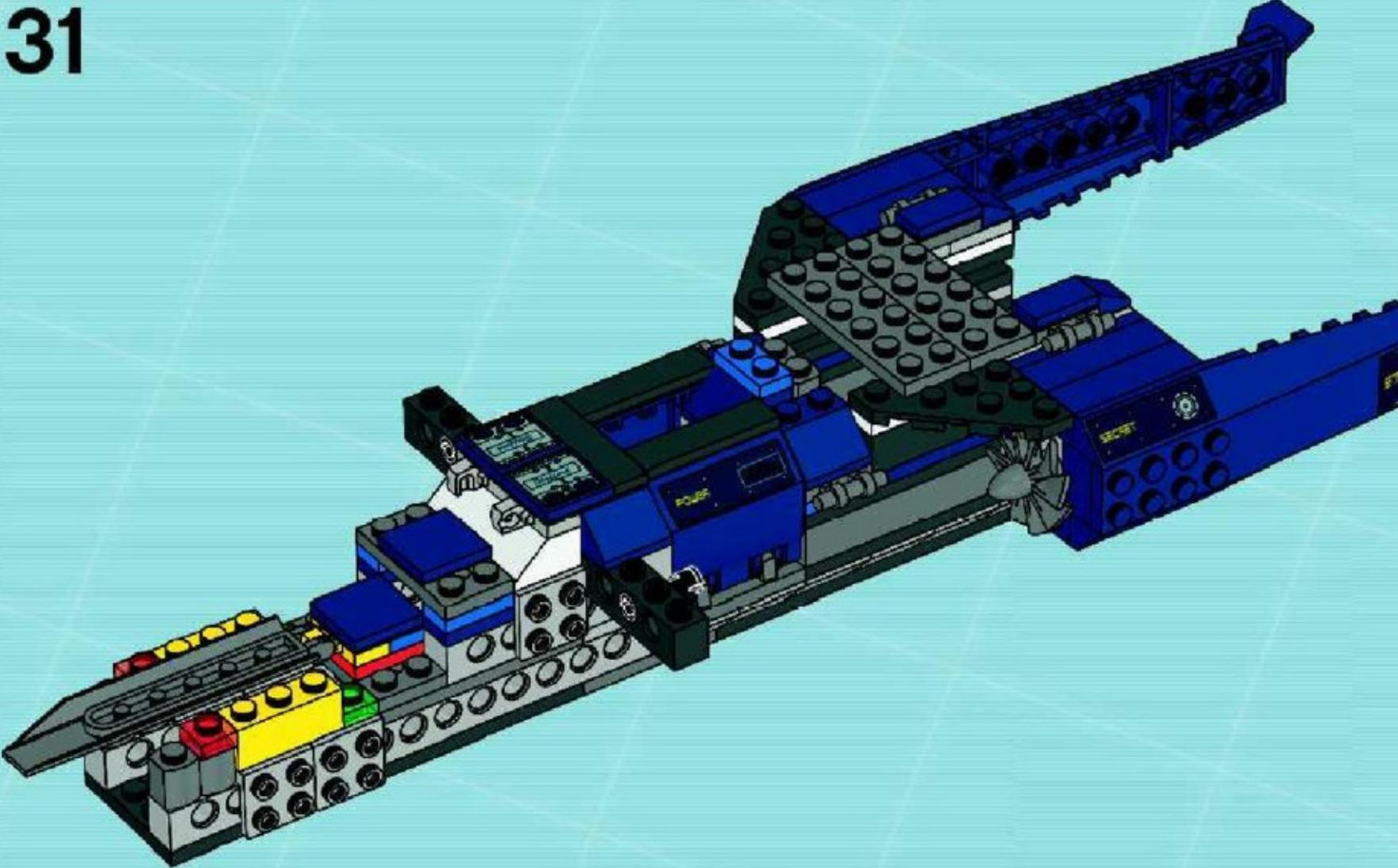



32

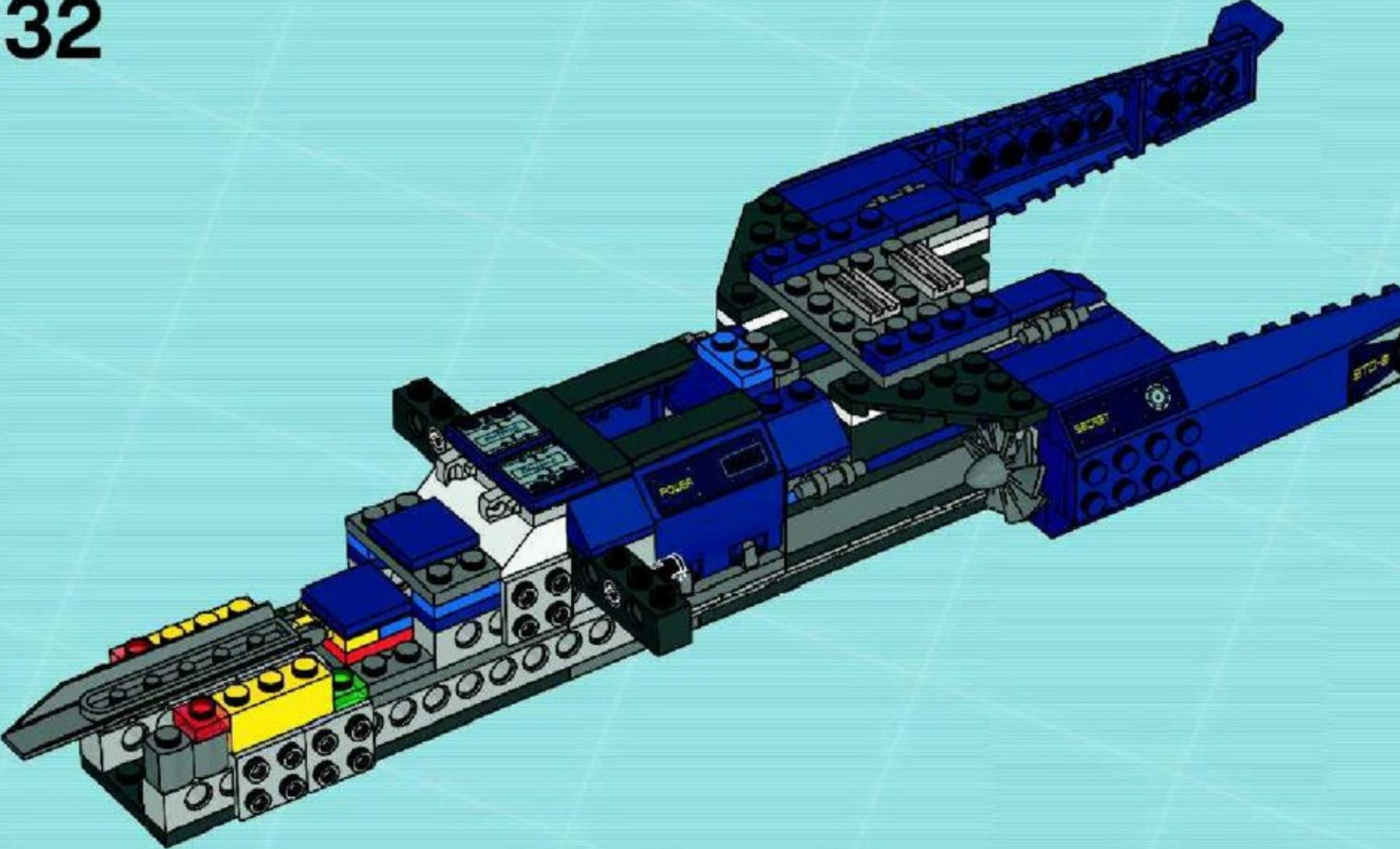



1x



1x

33

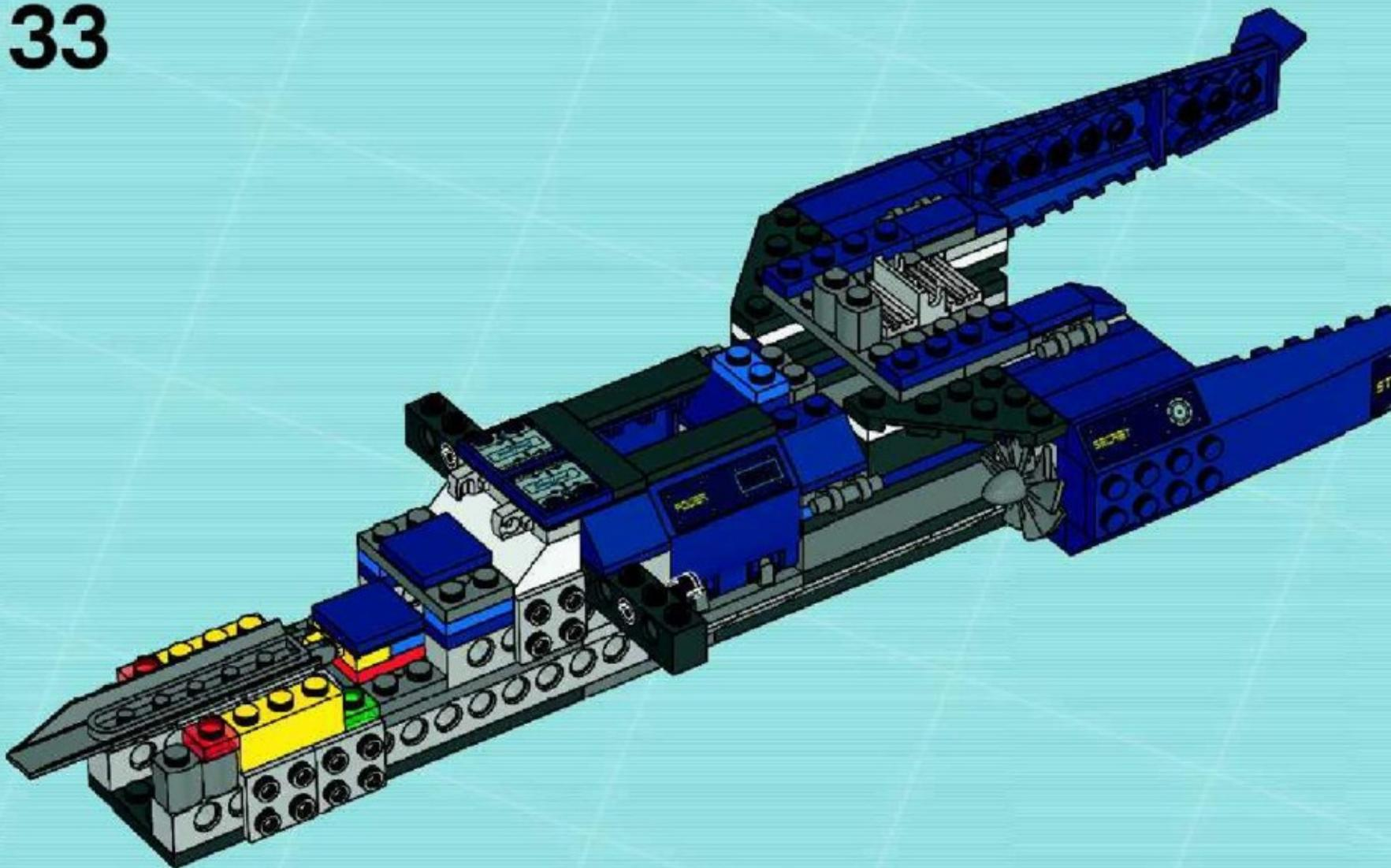

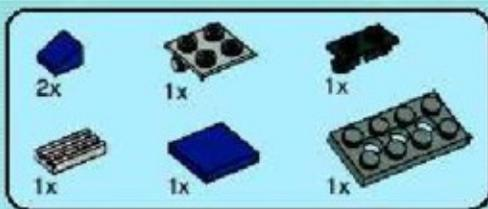

34

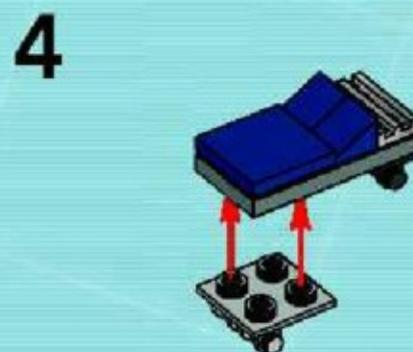
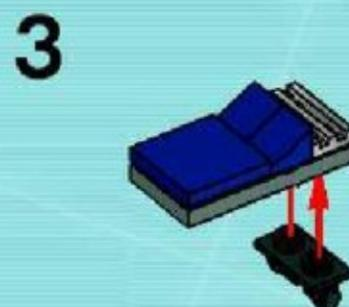
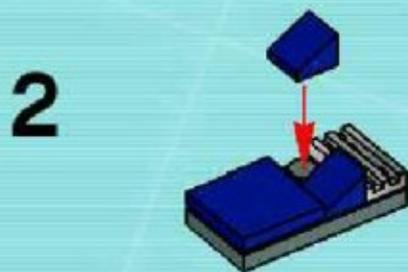
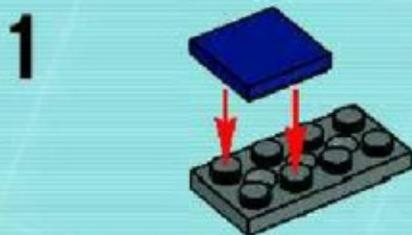

5

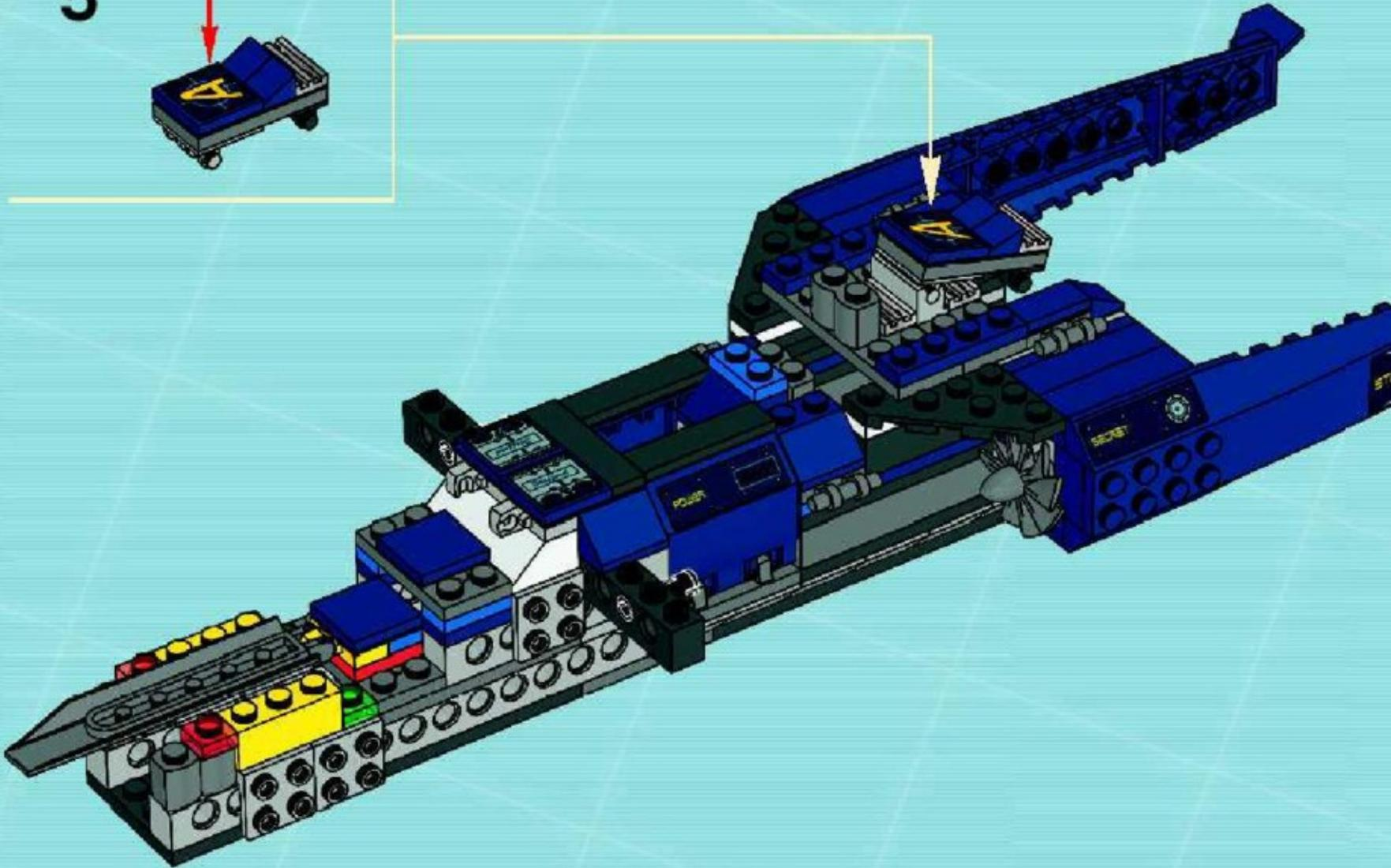
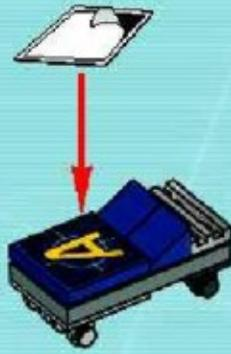



3x

35

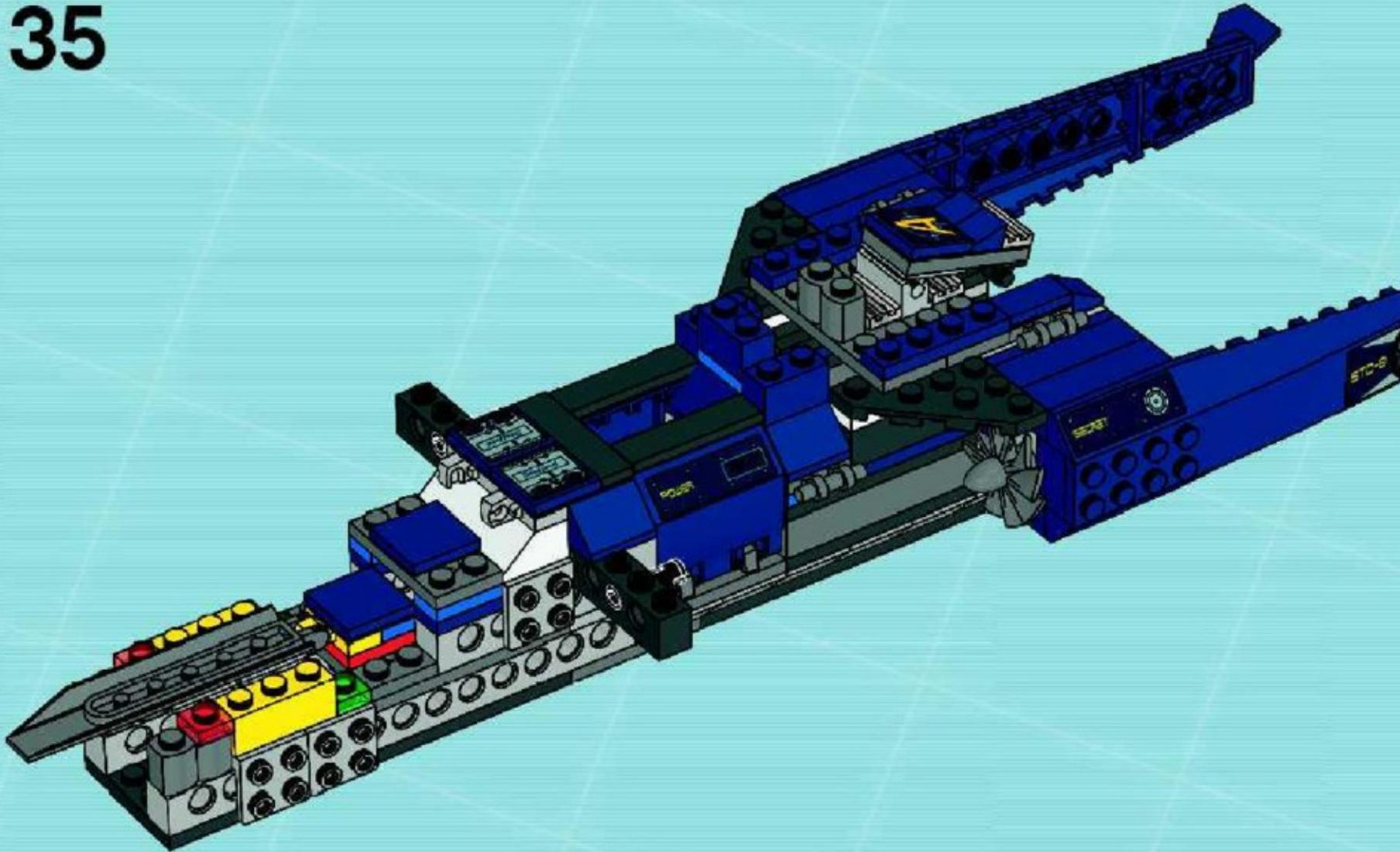

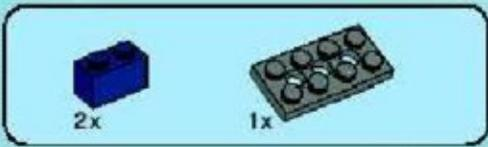

36

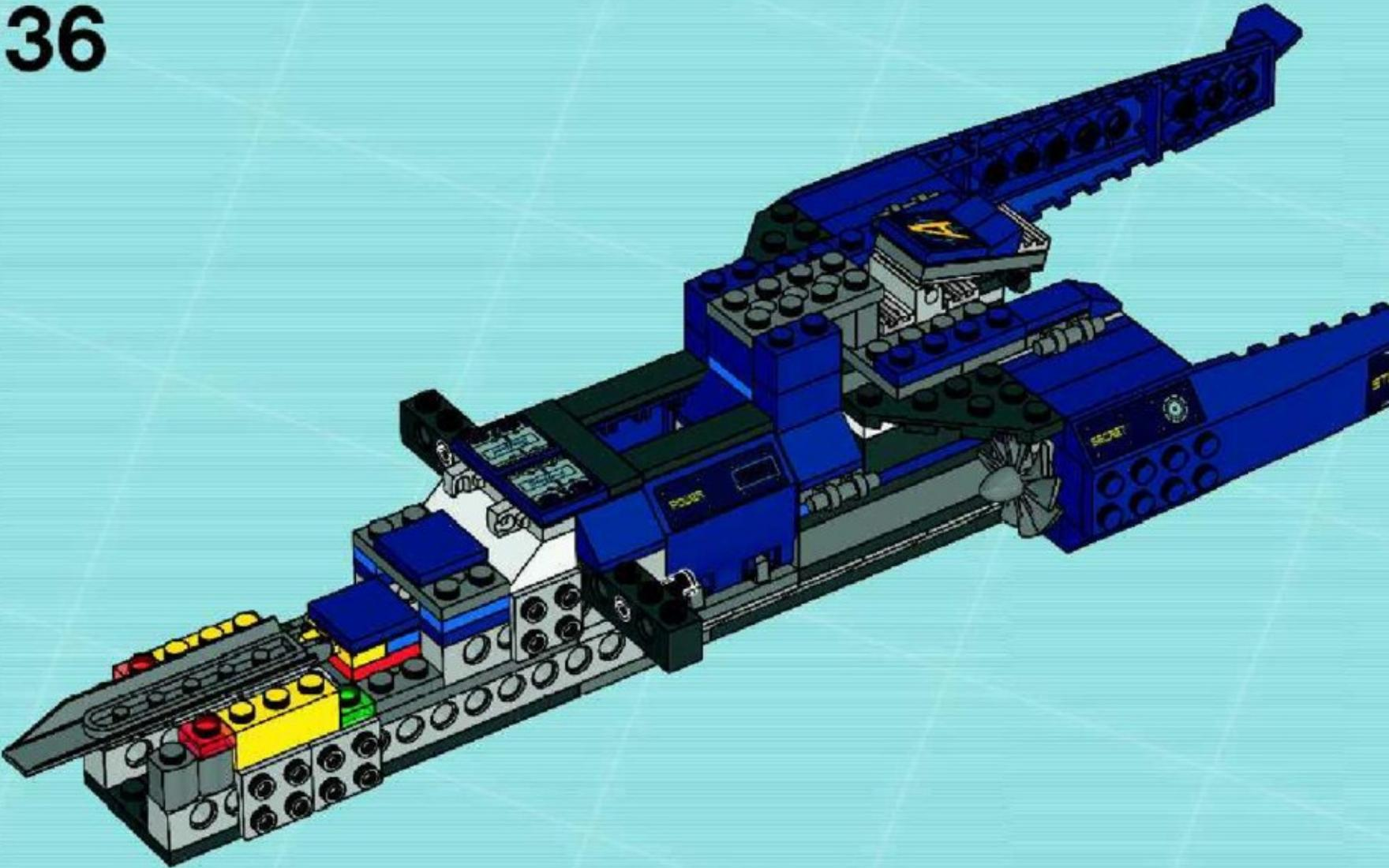



37

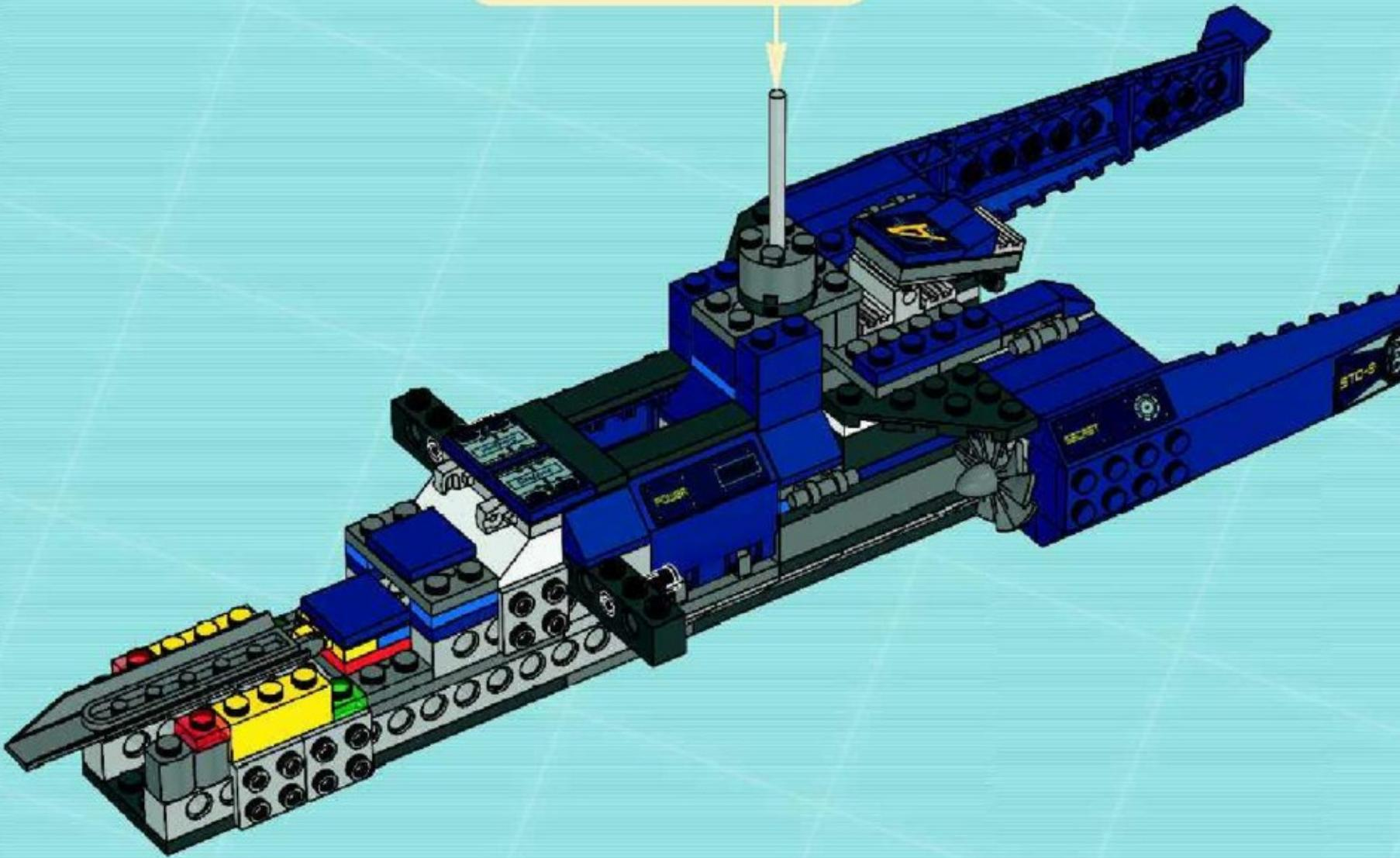
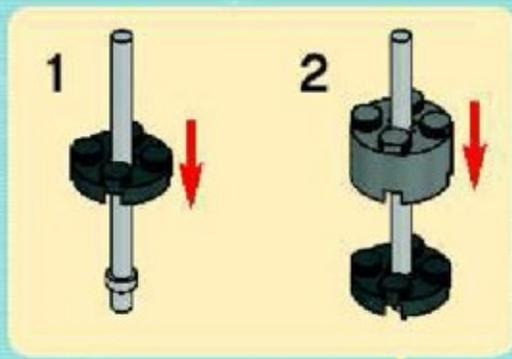



3x

38

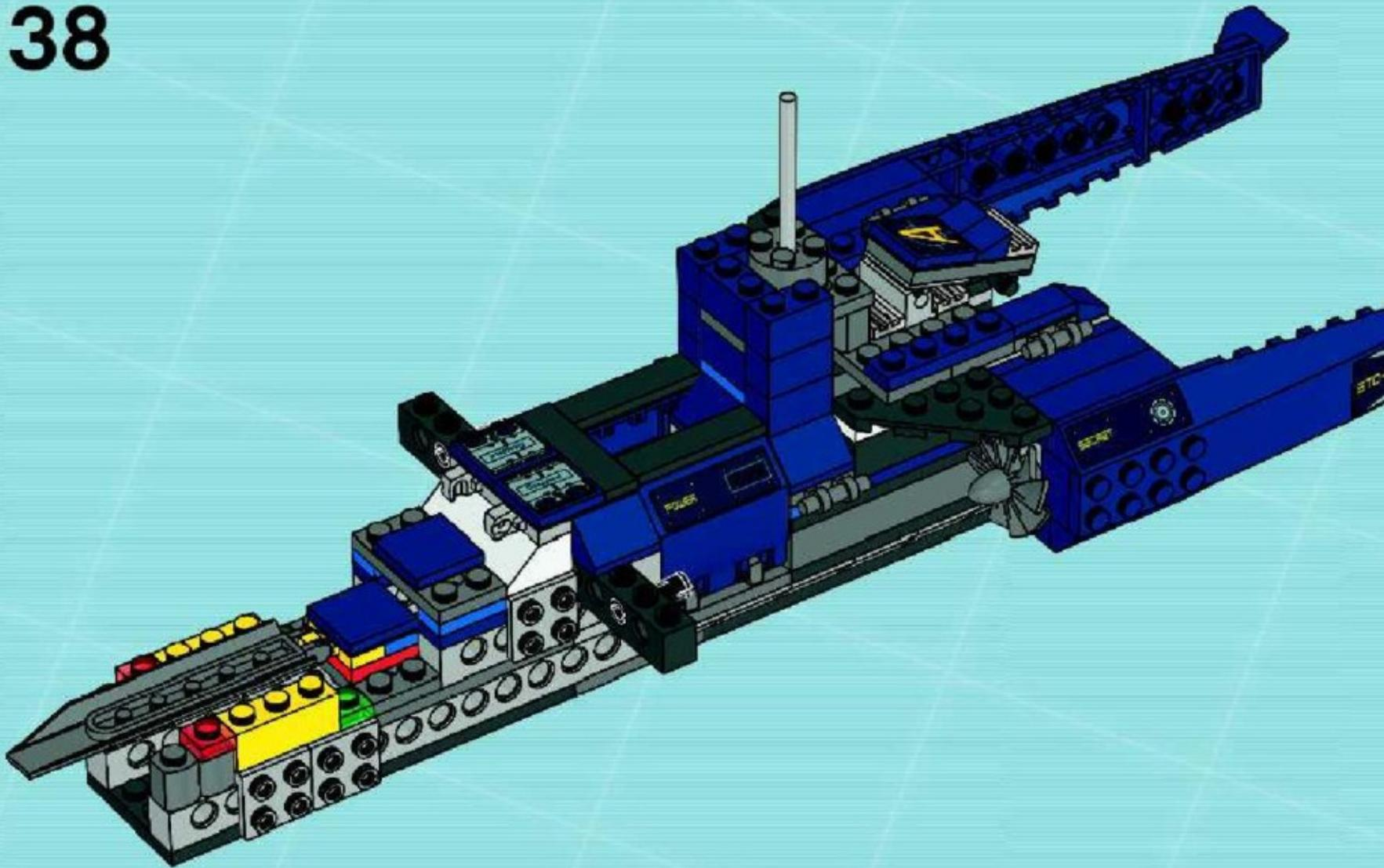



40

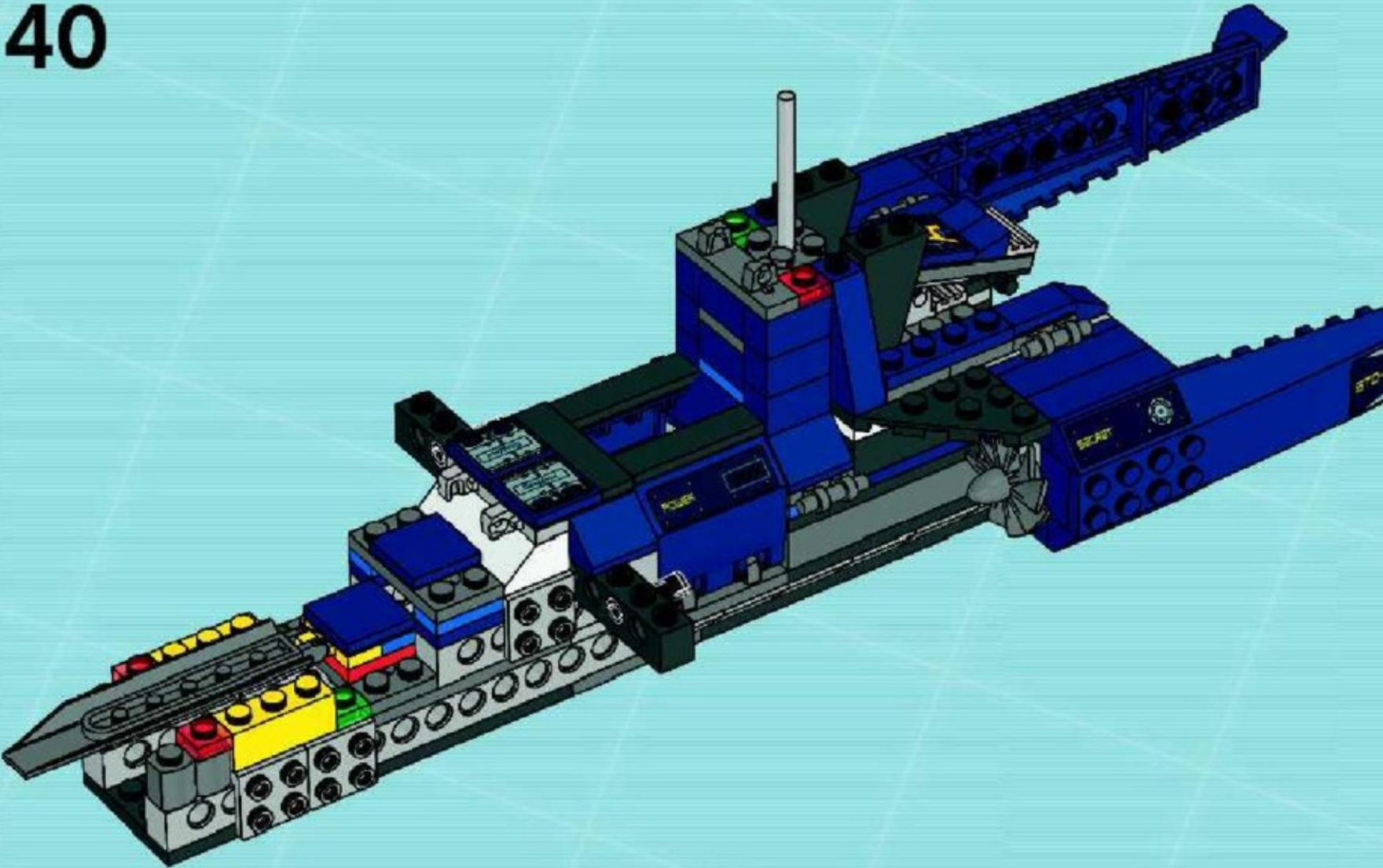



1x

41

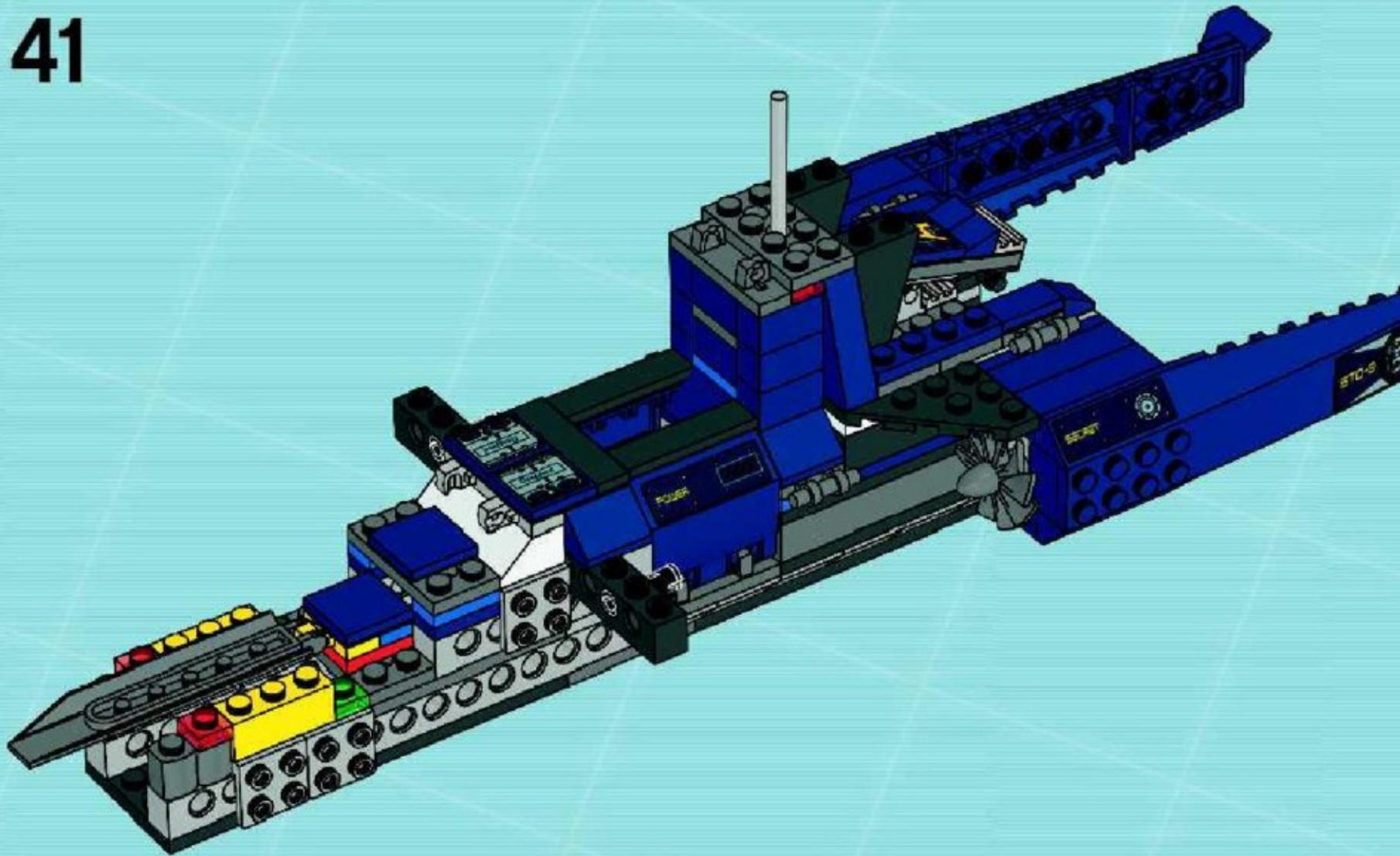



2x

42

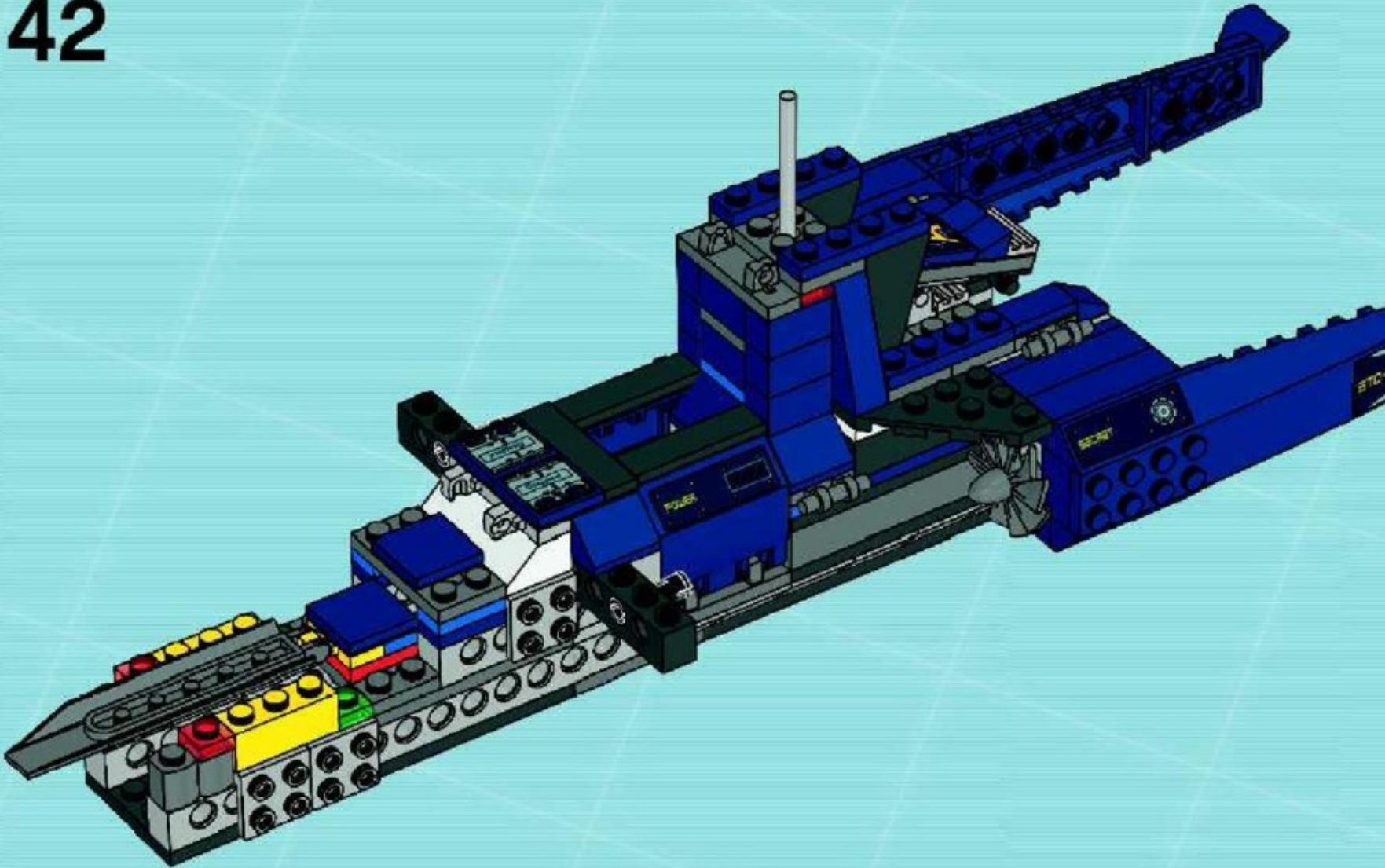



1x

43

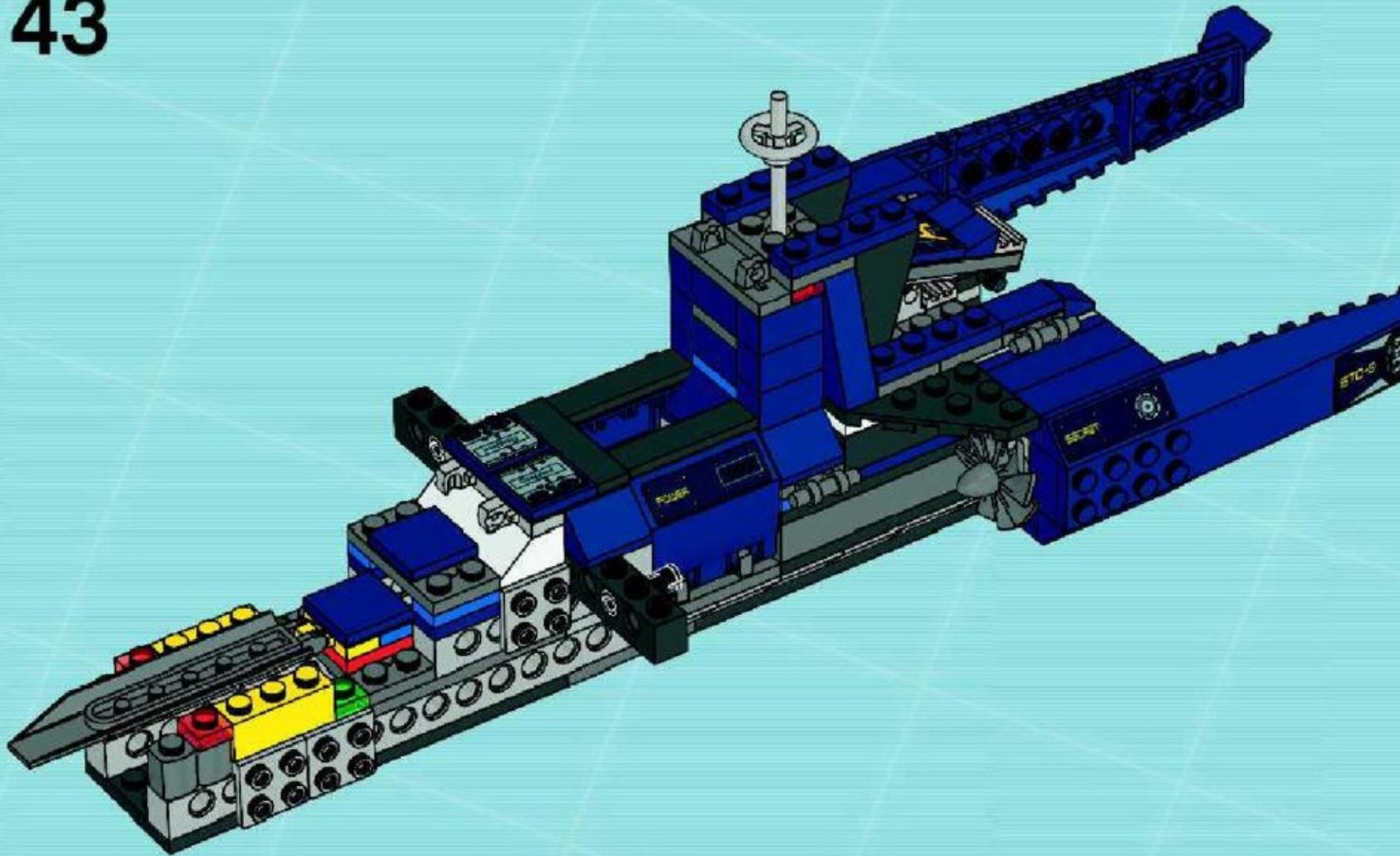



1x



1x

44

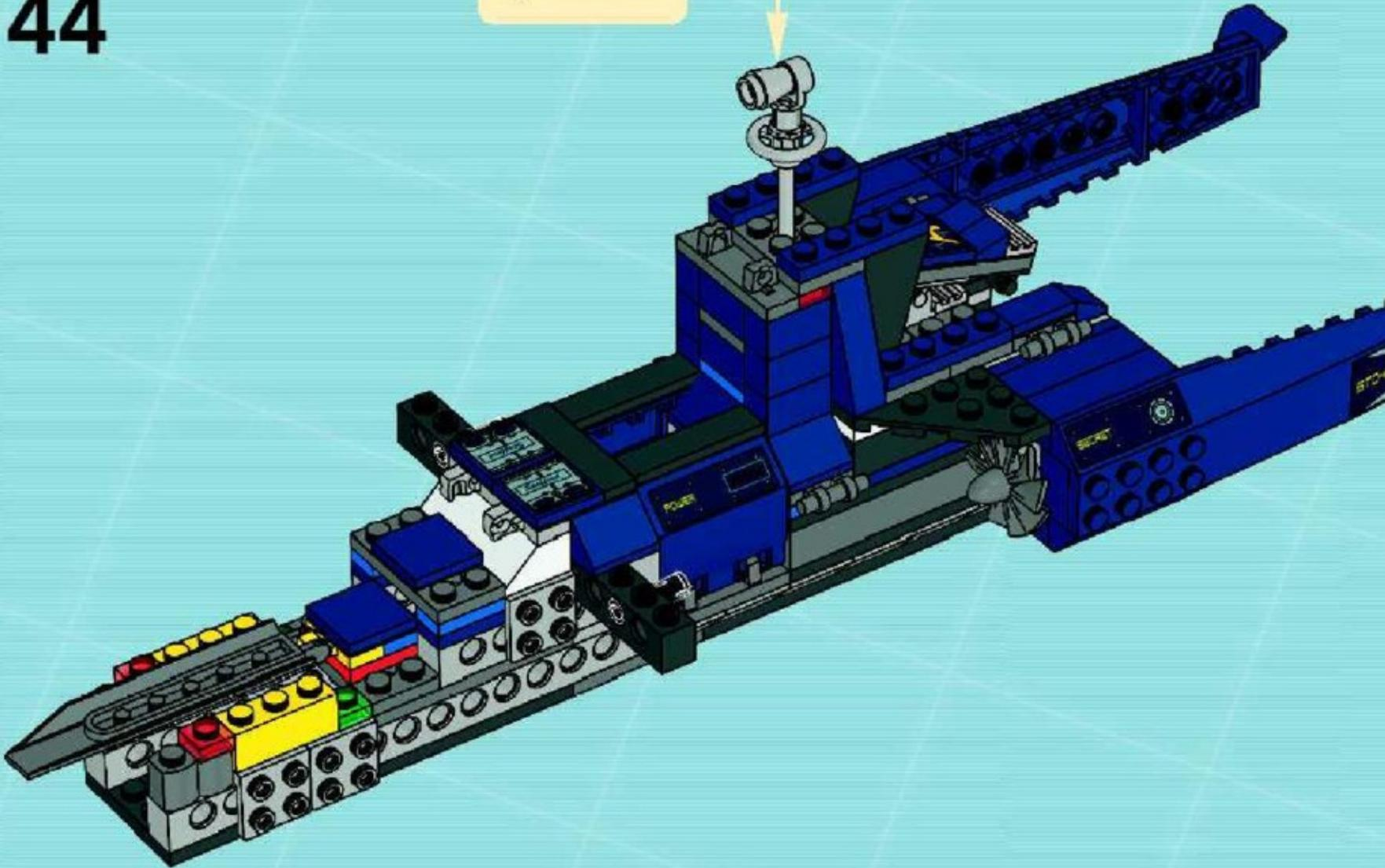
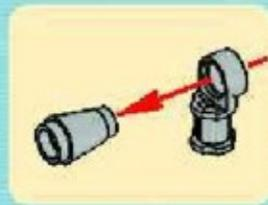

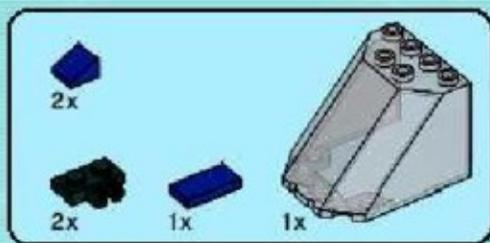

45

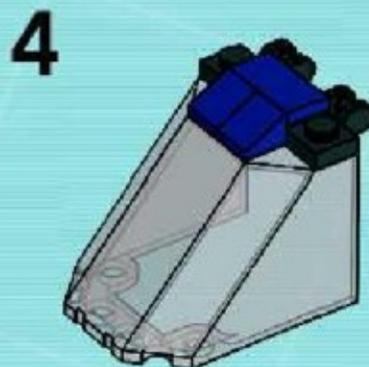
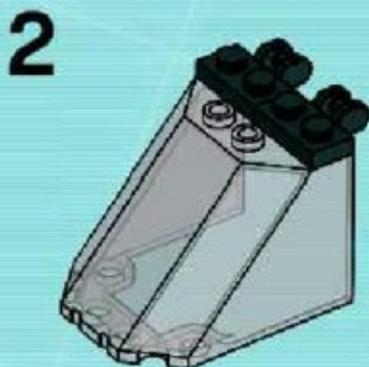
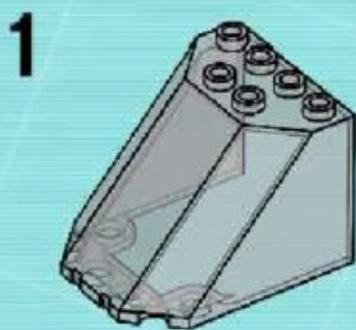

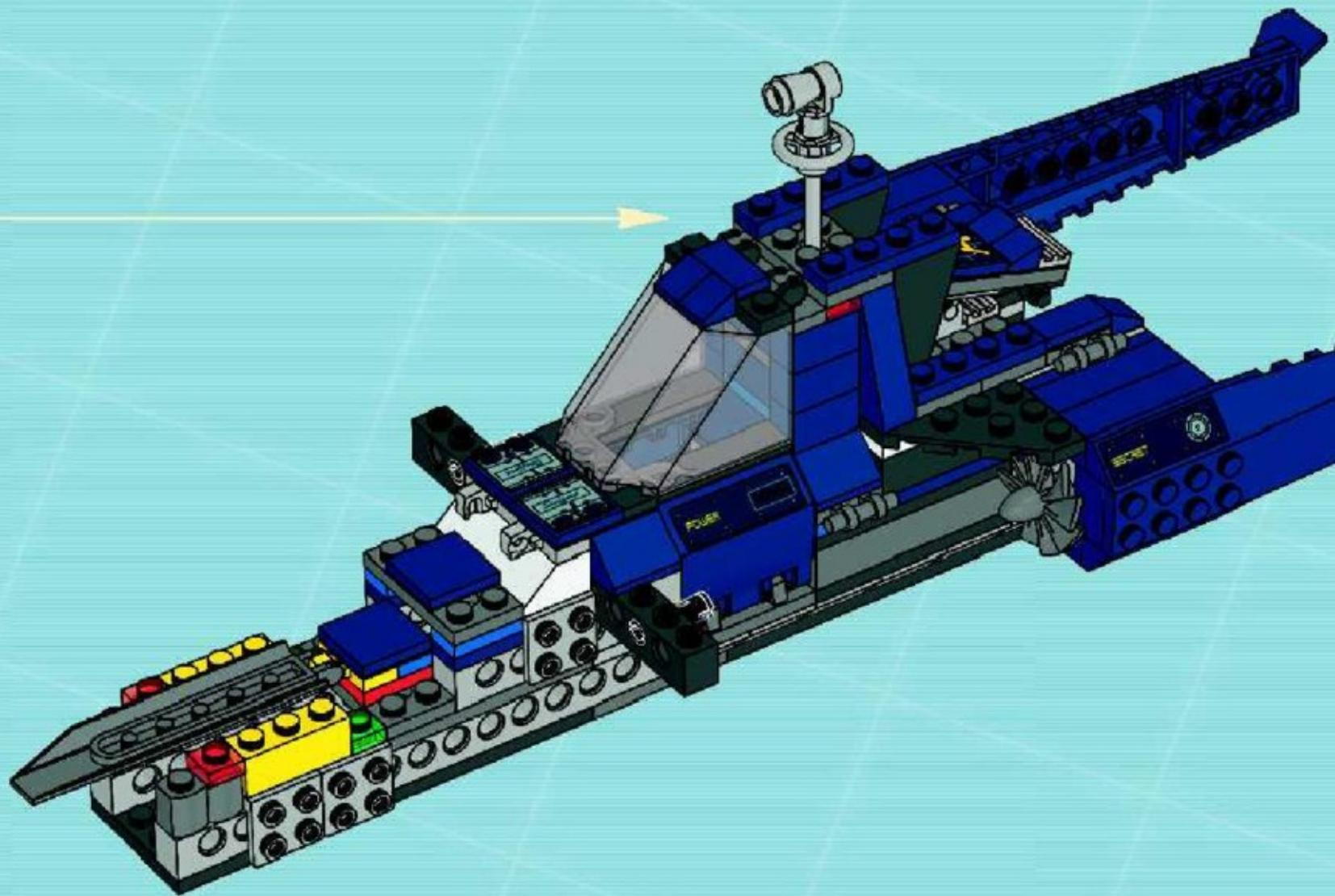



46

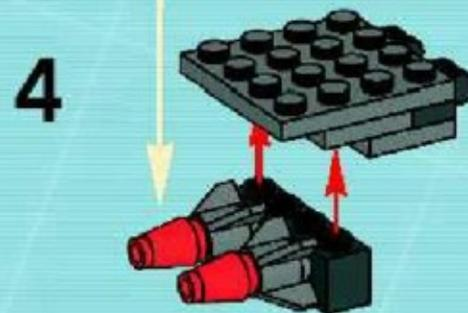
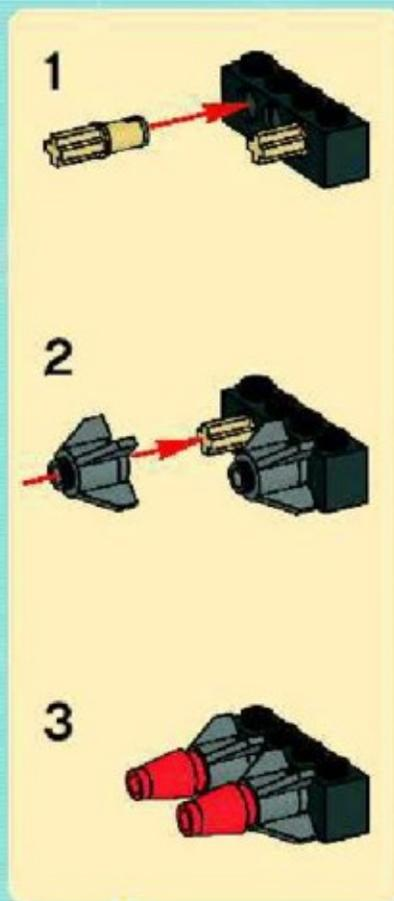
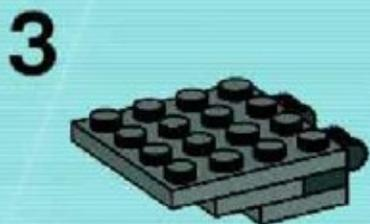
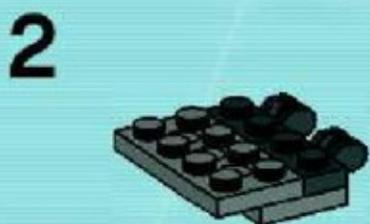

5

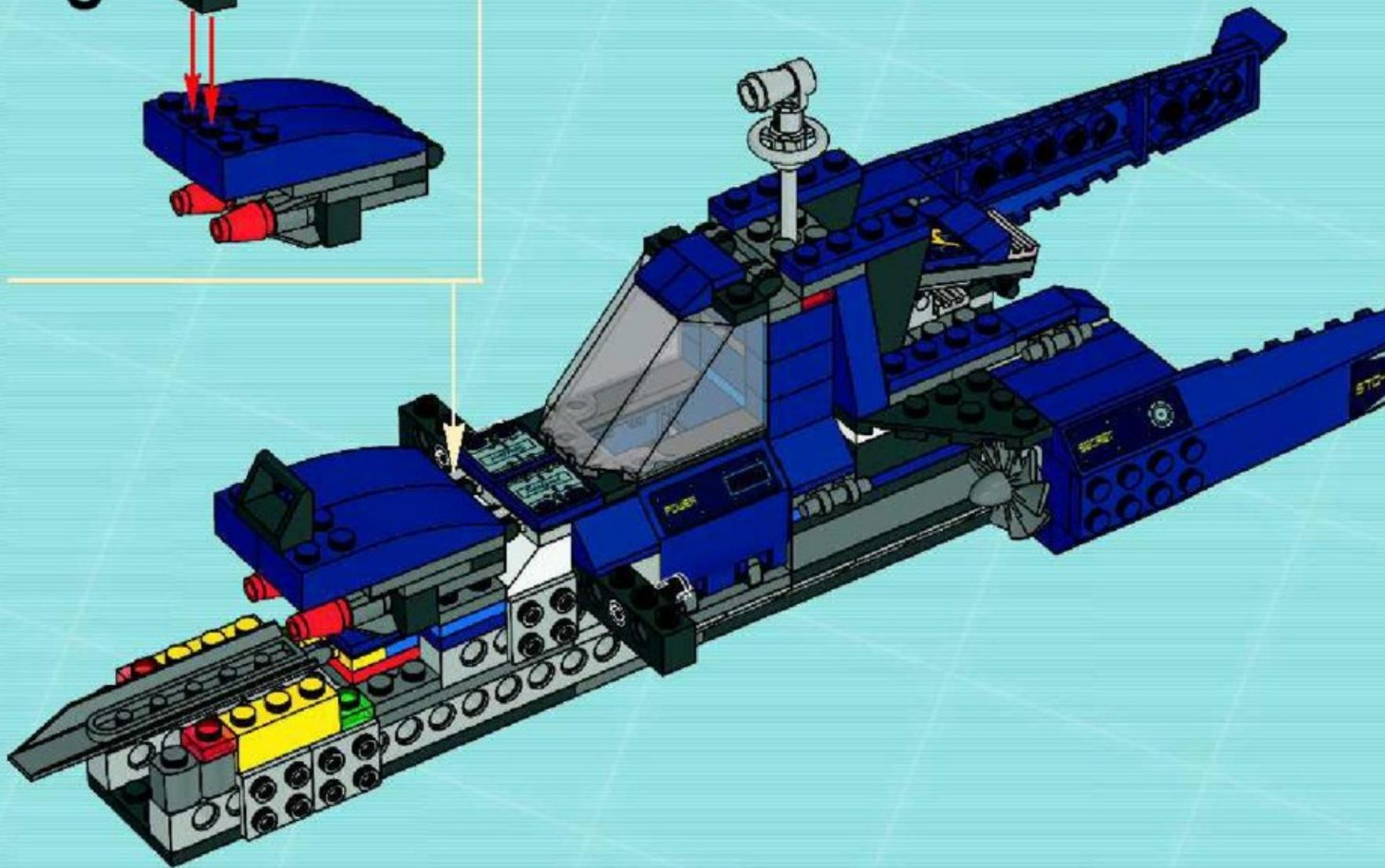
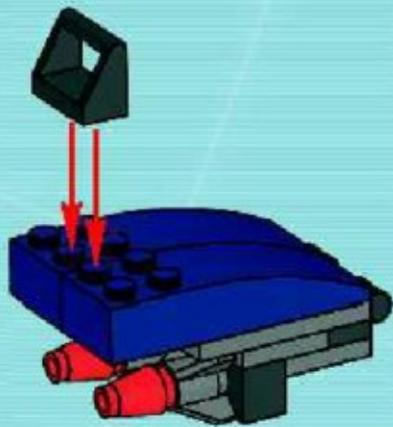

2x  2x 

47

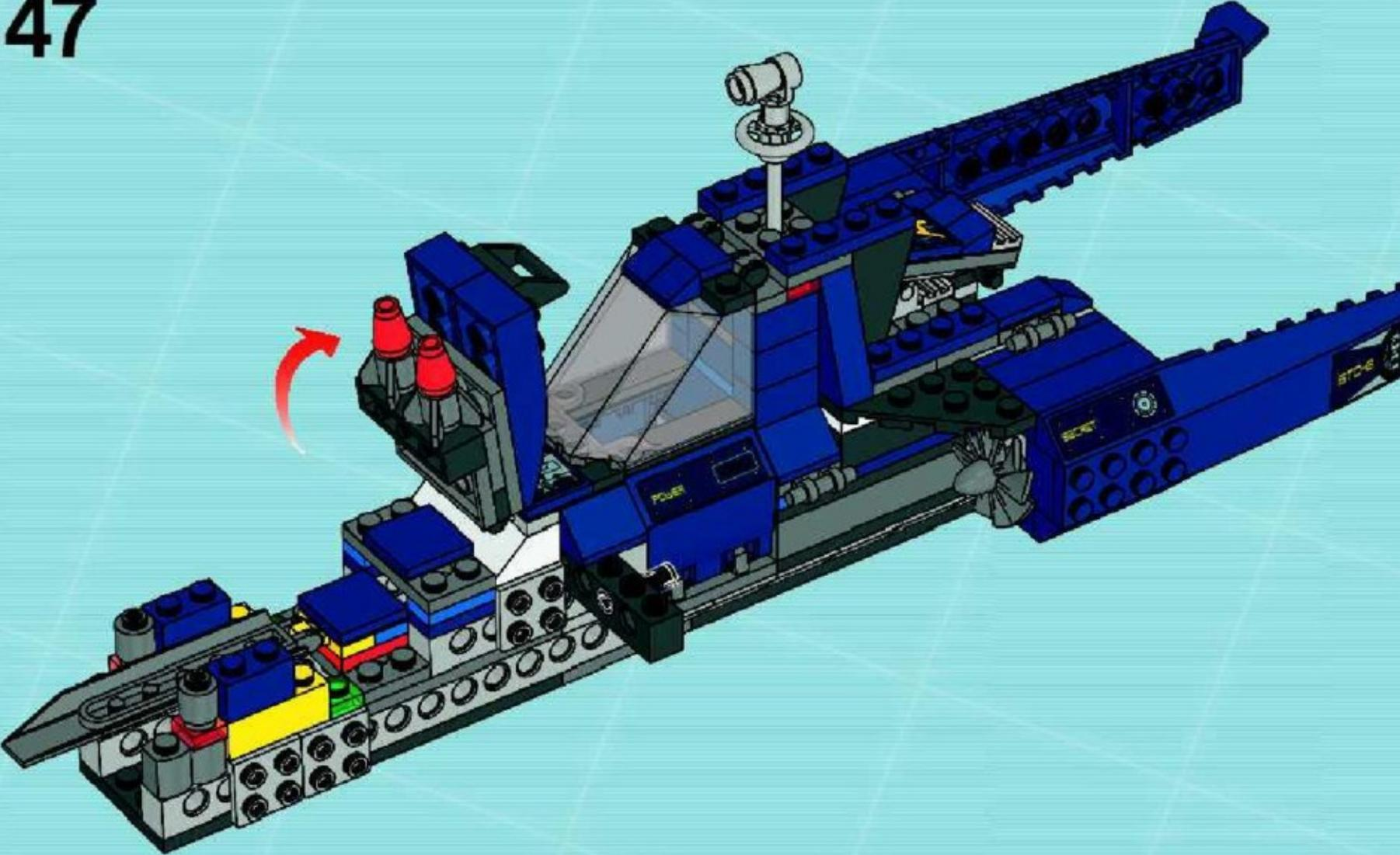

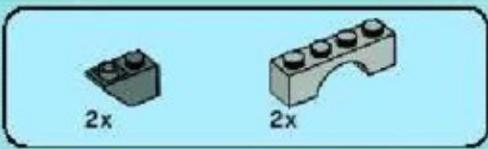

48

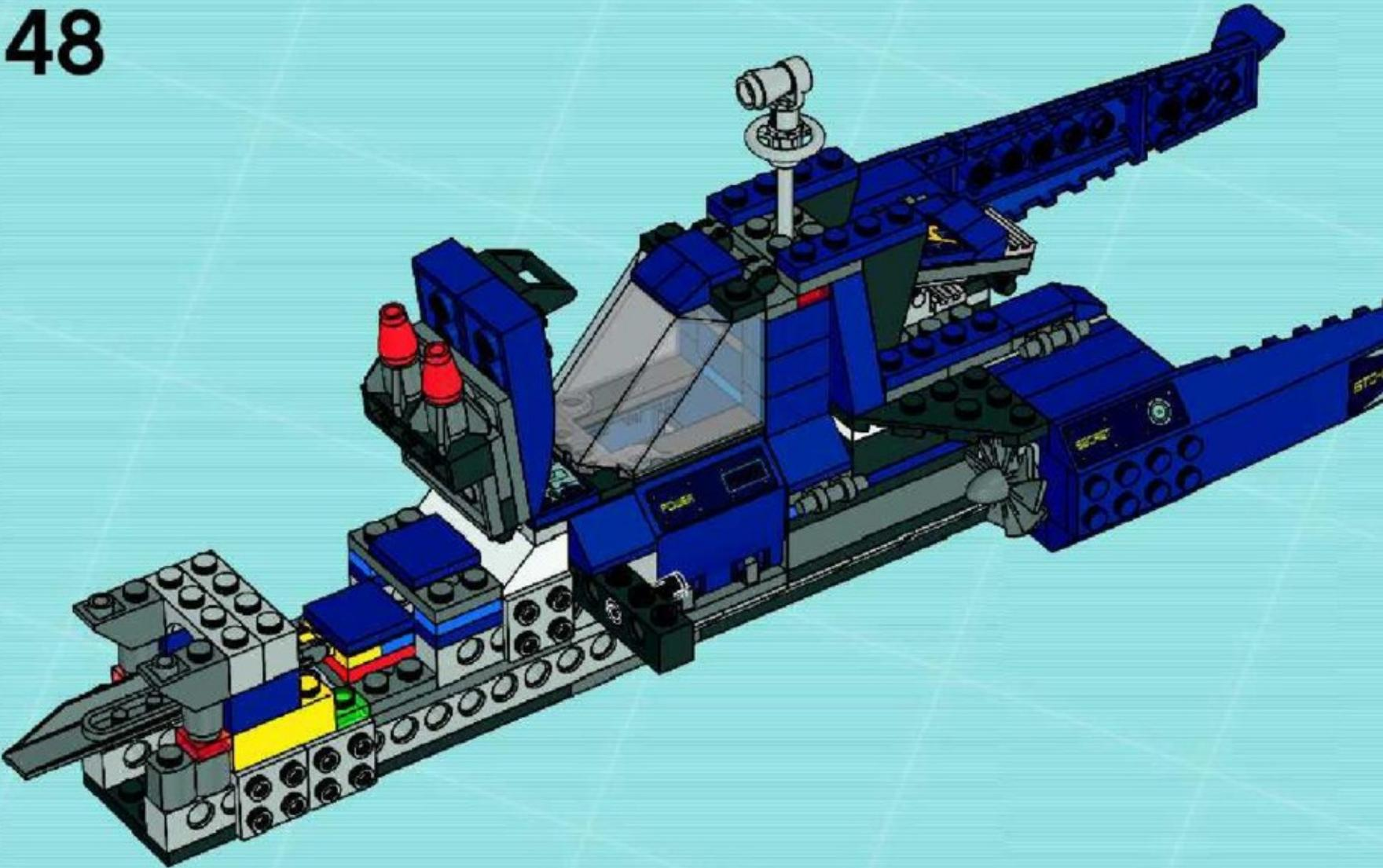

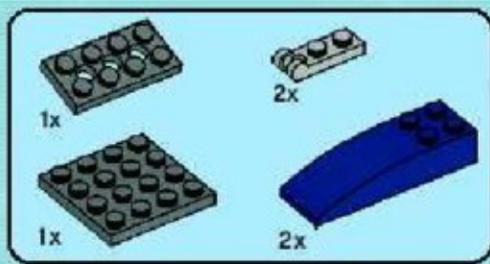

49

1

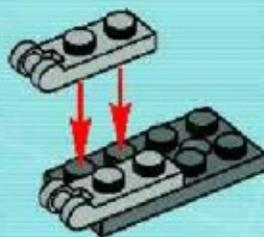

2

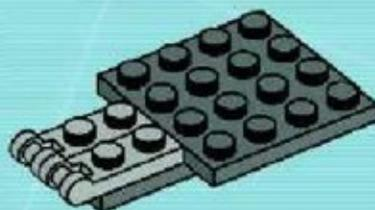

3

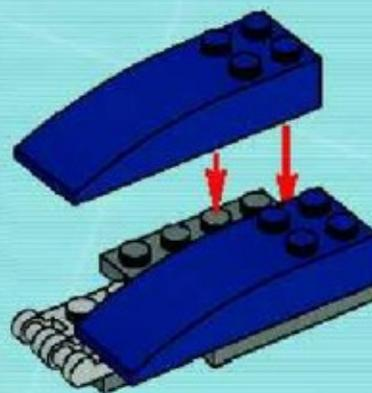

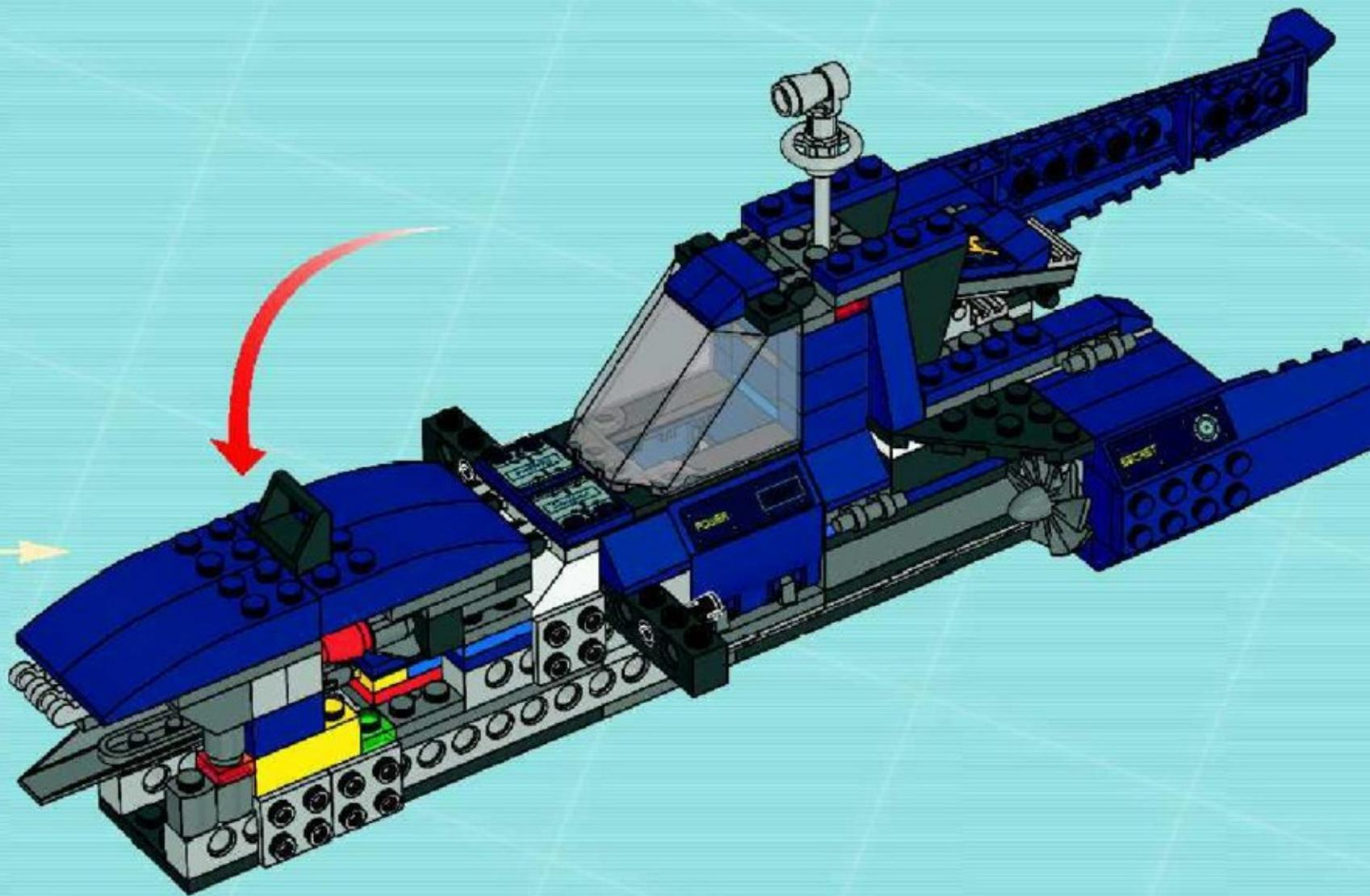

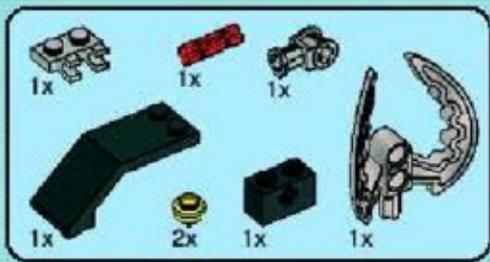

50

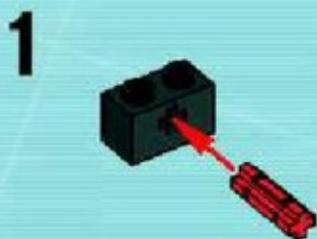

3

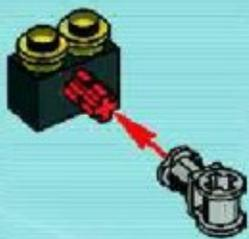

4

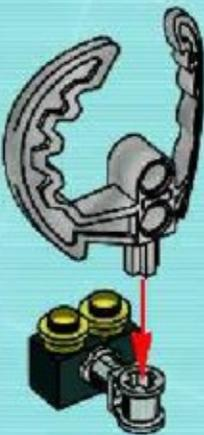

5



6



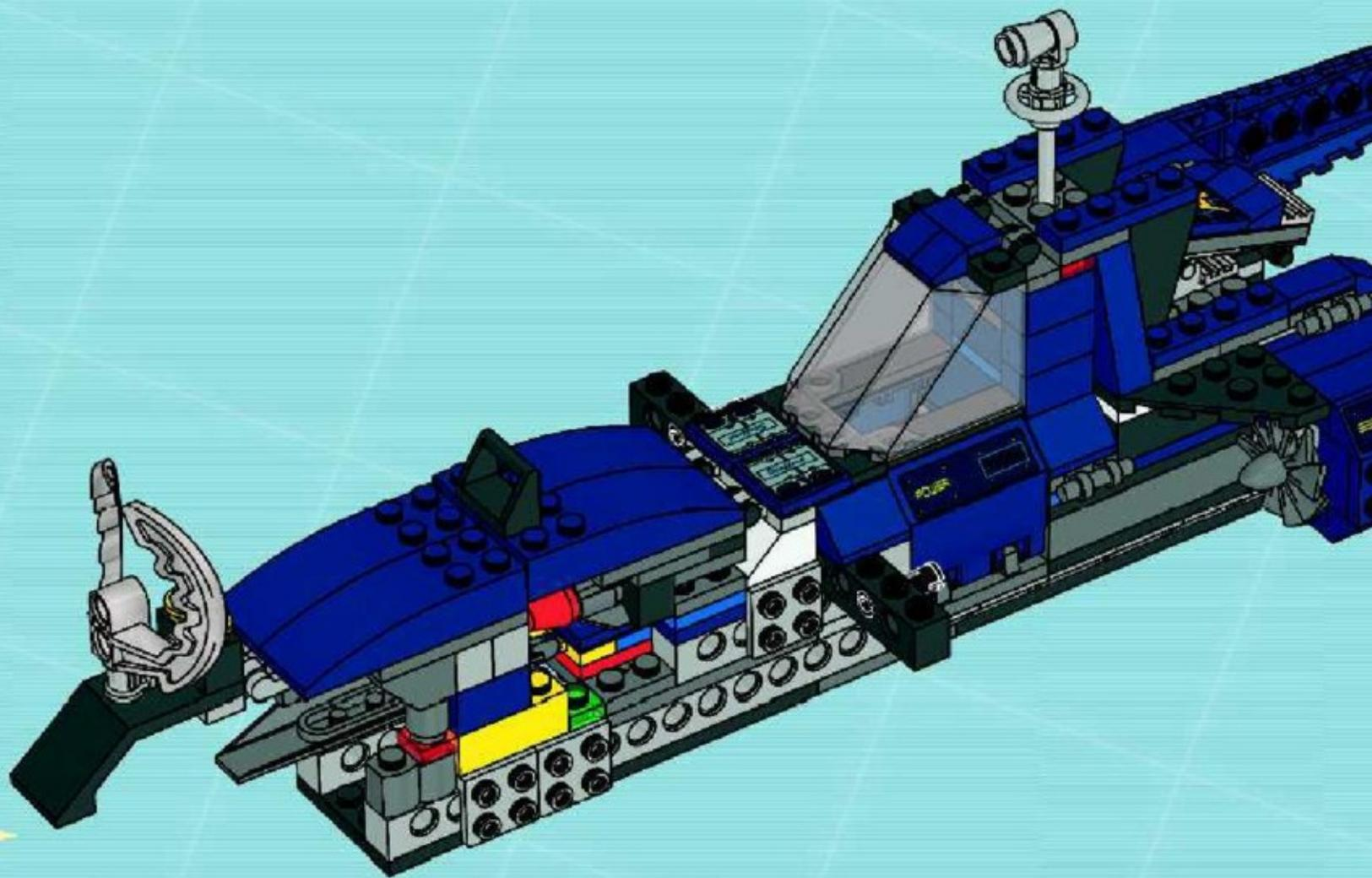

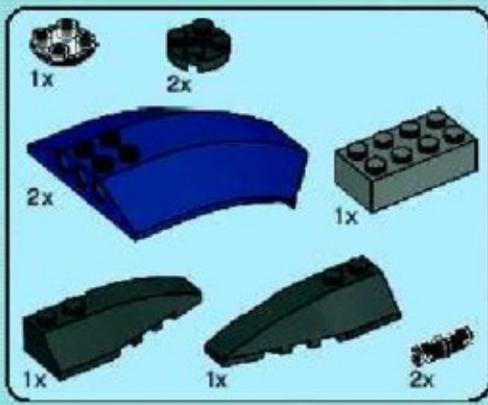

51

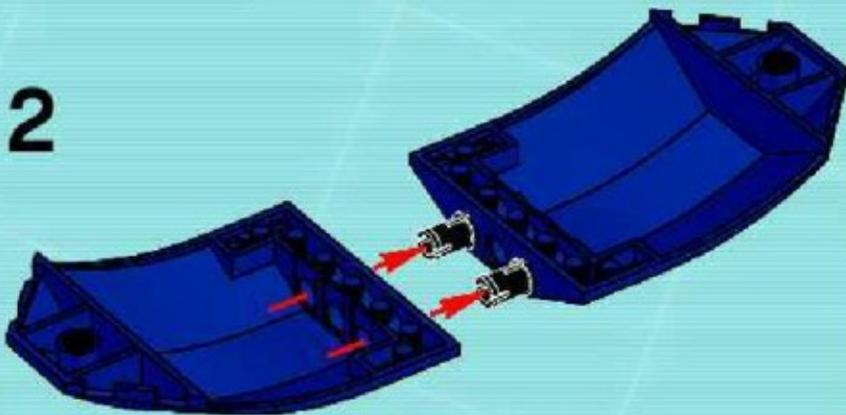
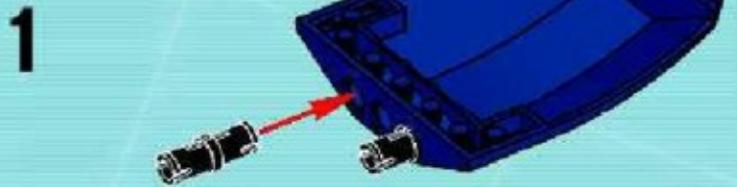

3

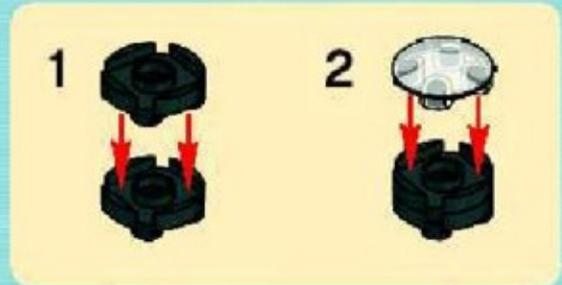
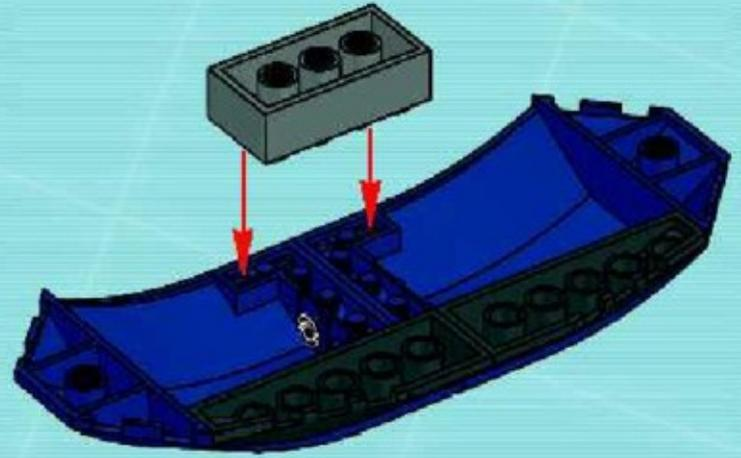

4

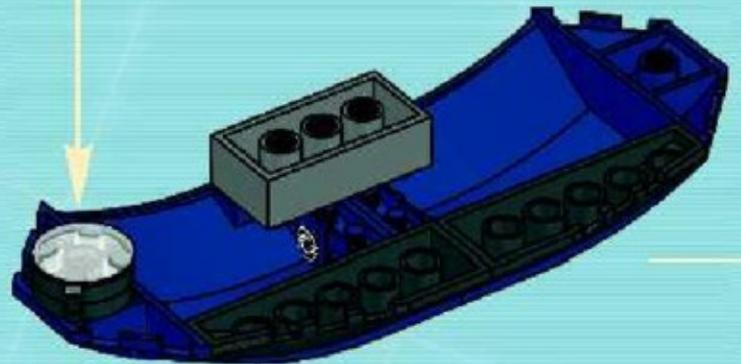

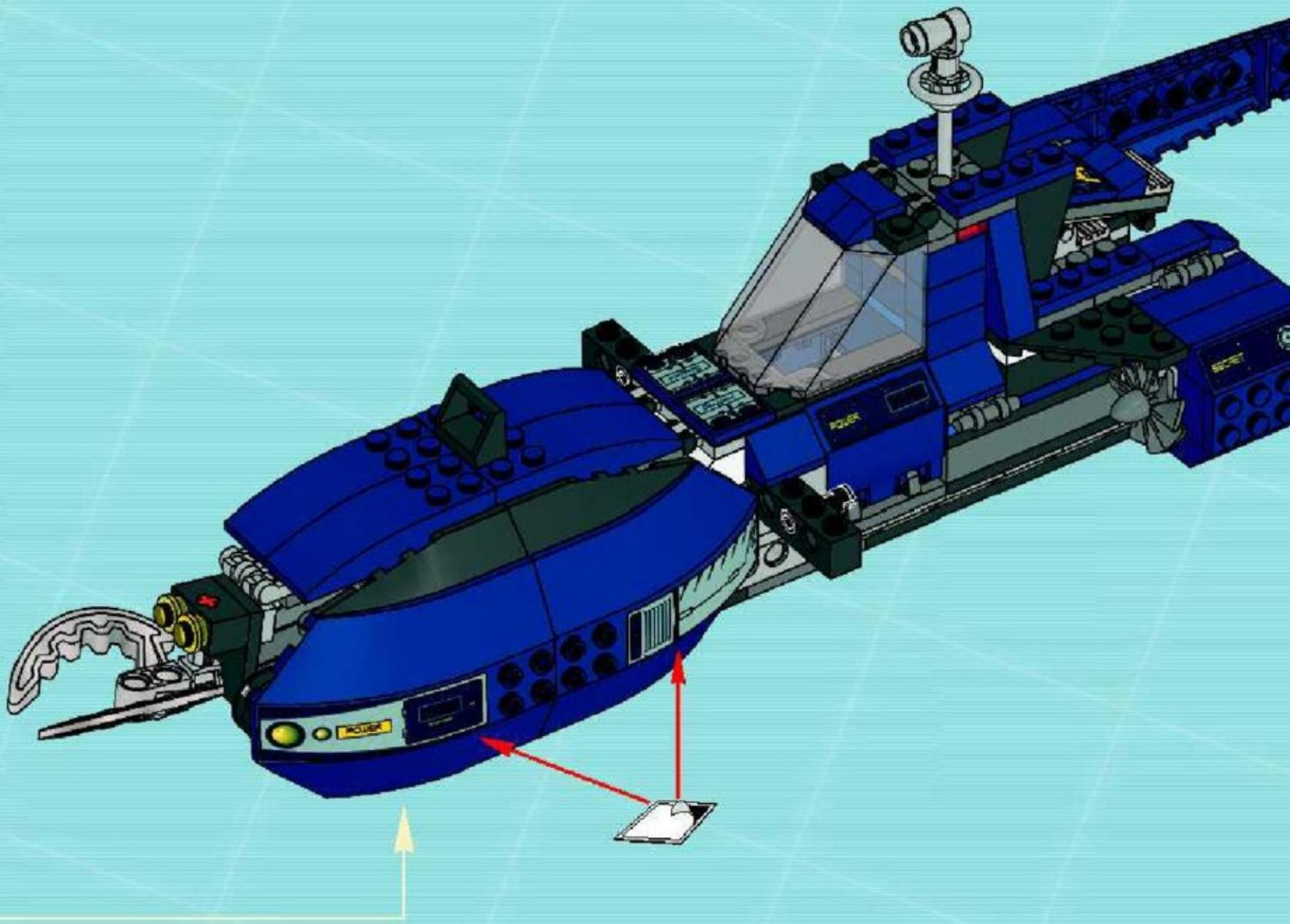

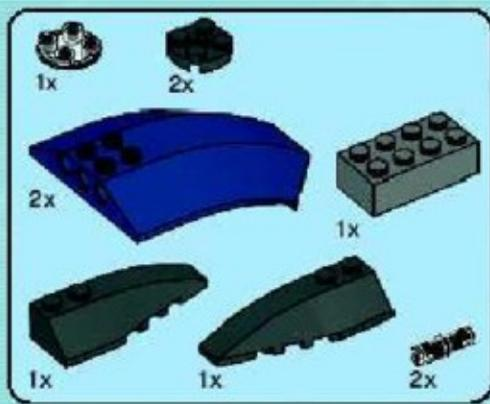

52

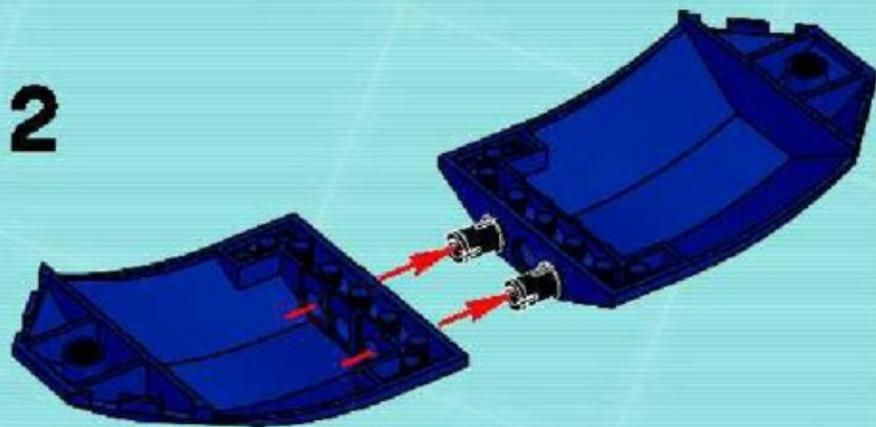
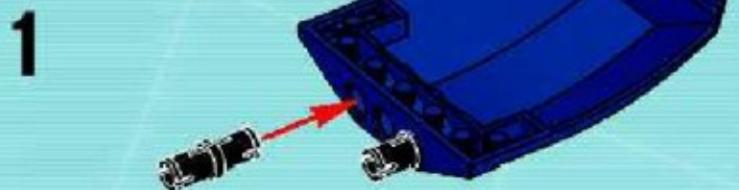

3

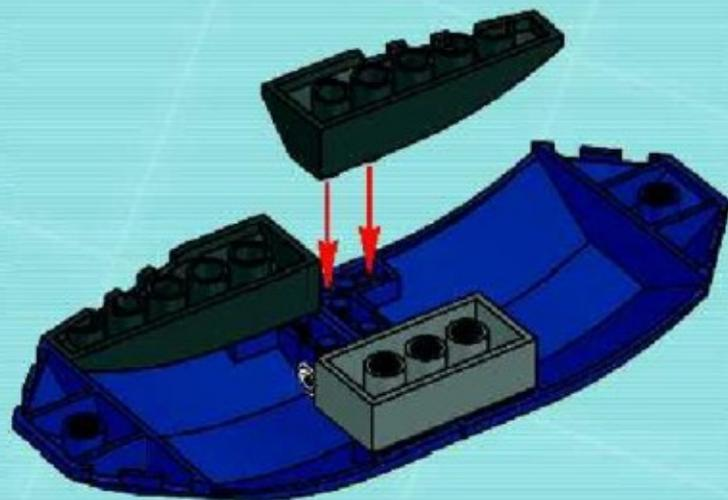

4

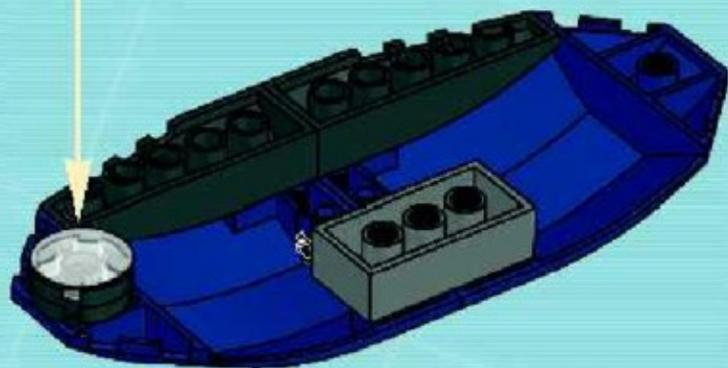

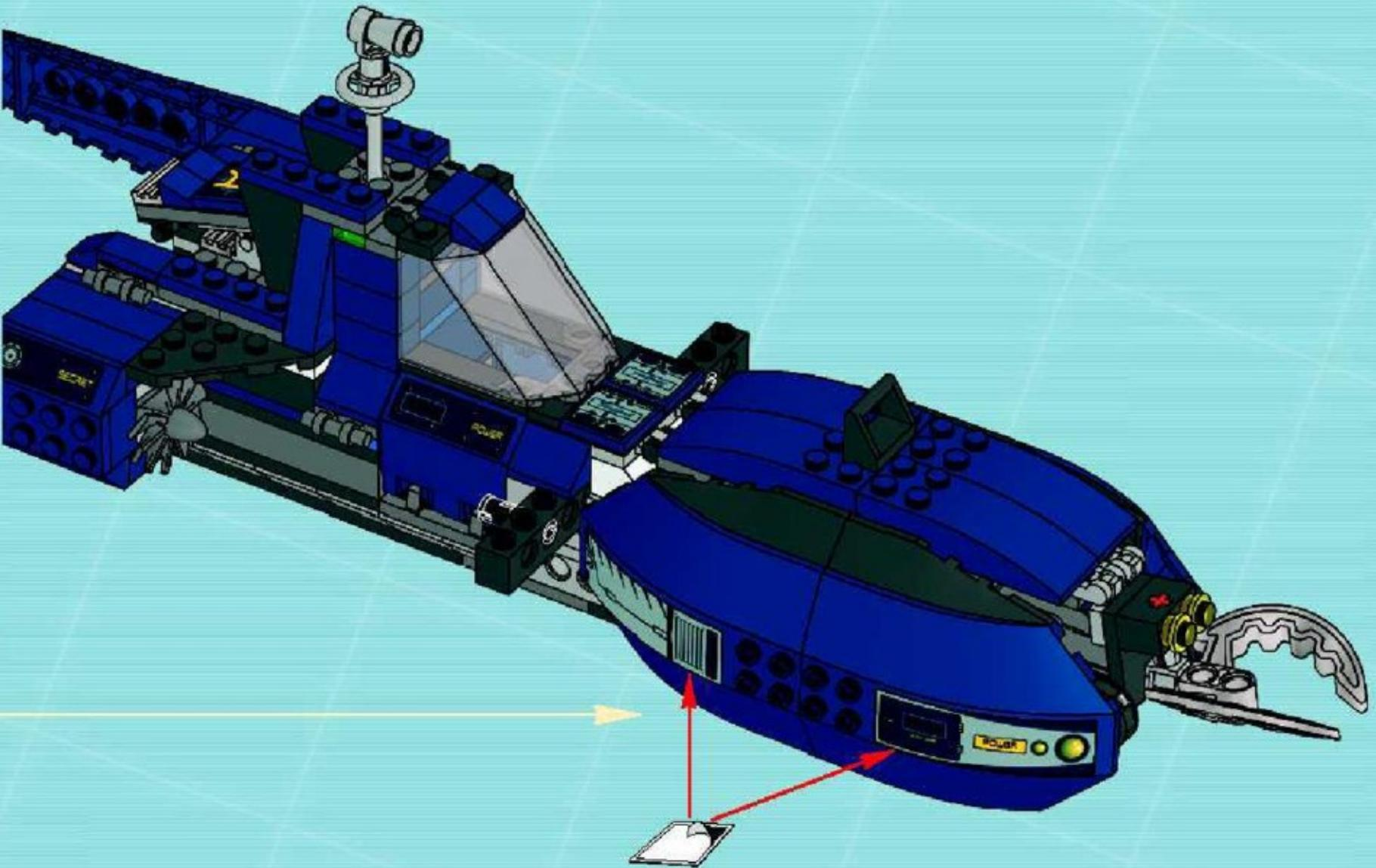

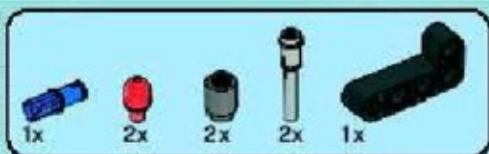

53

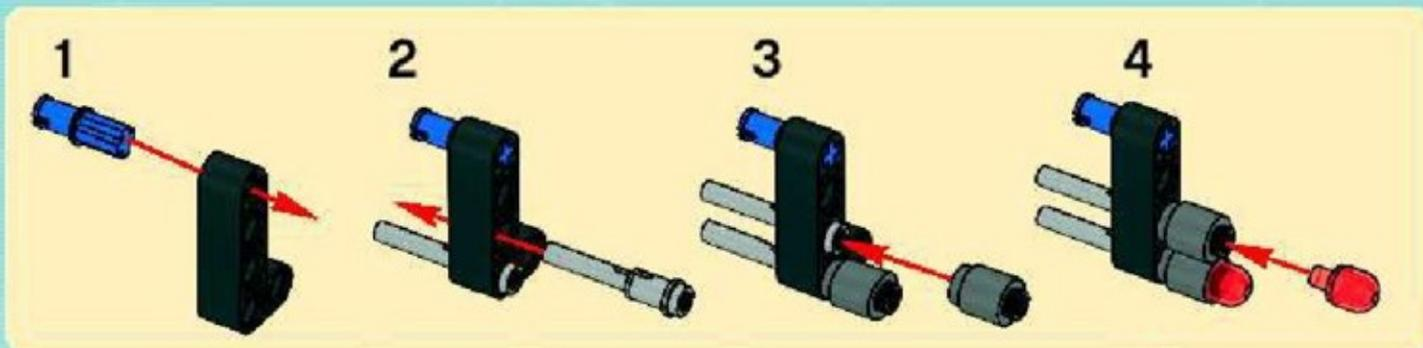

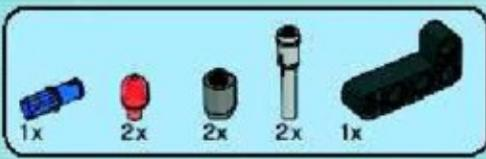

54

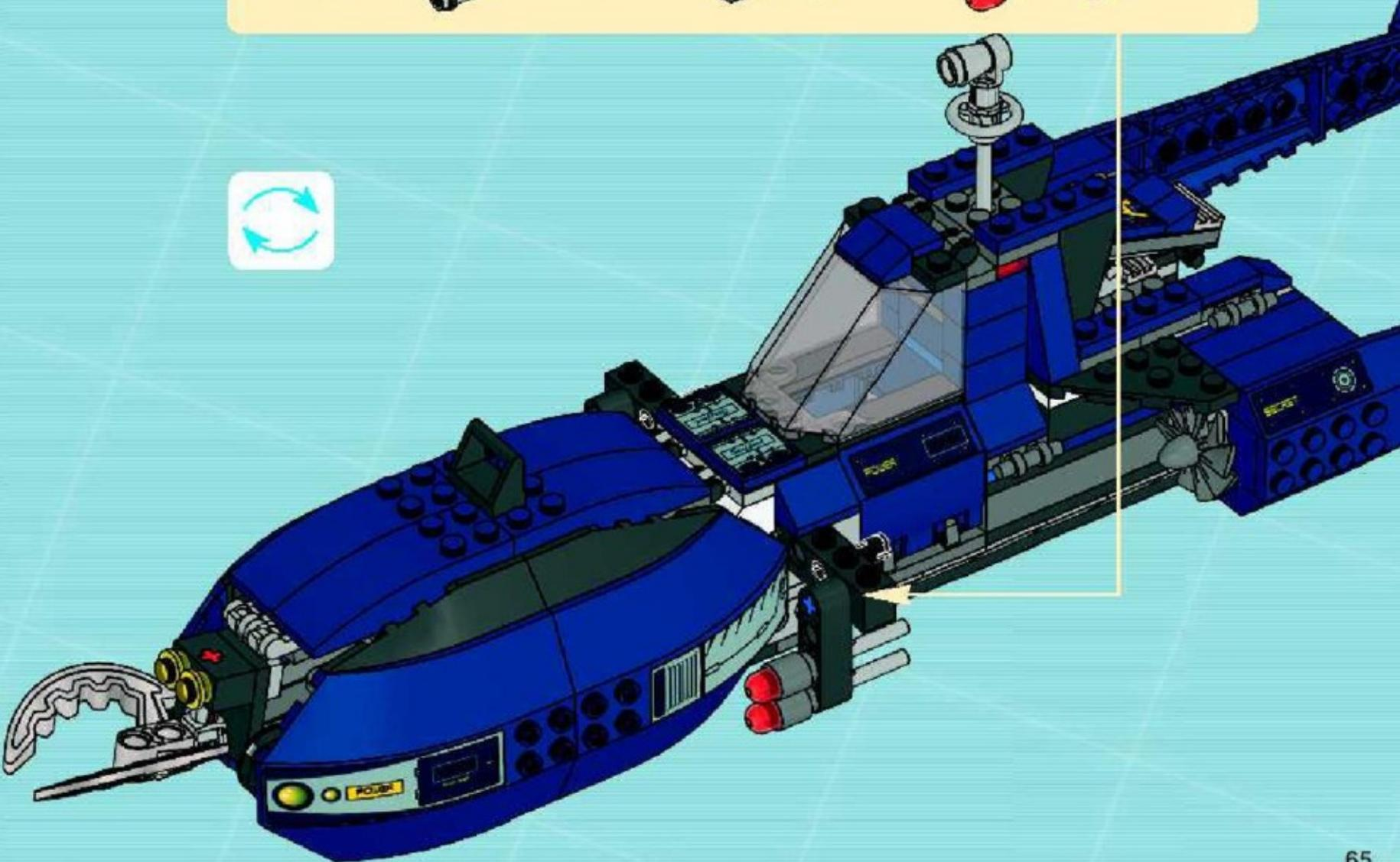
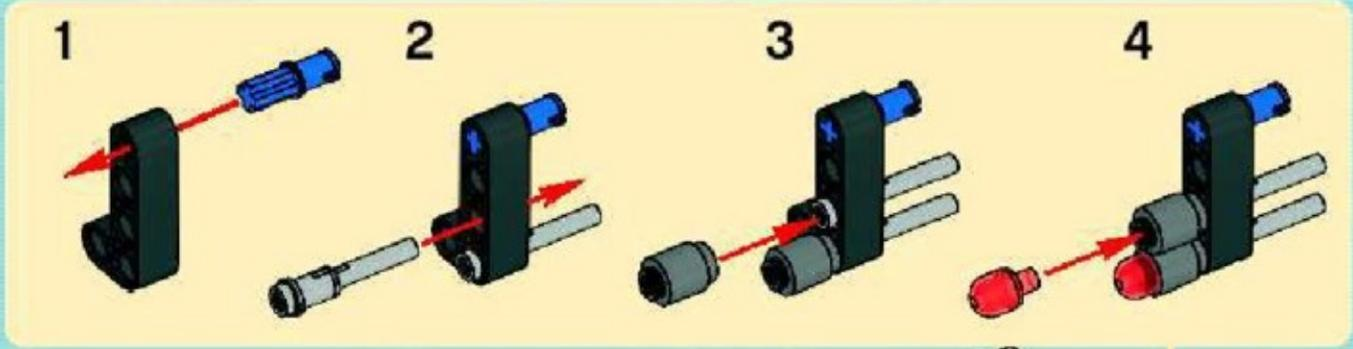

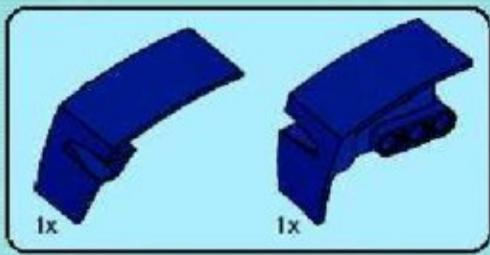

55

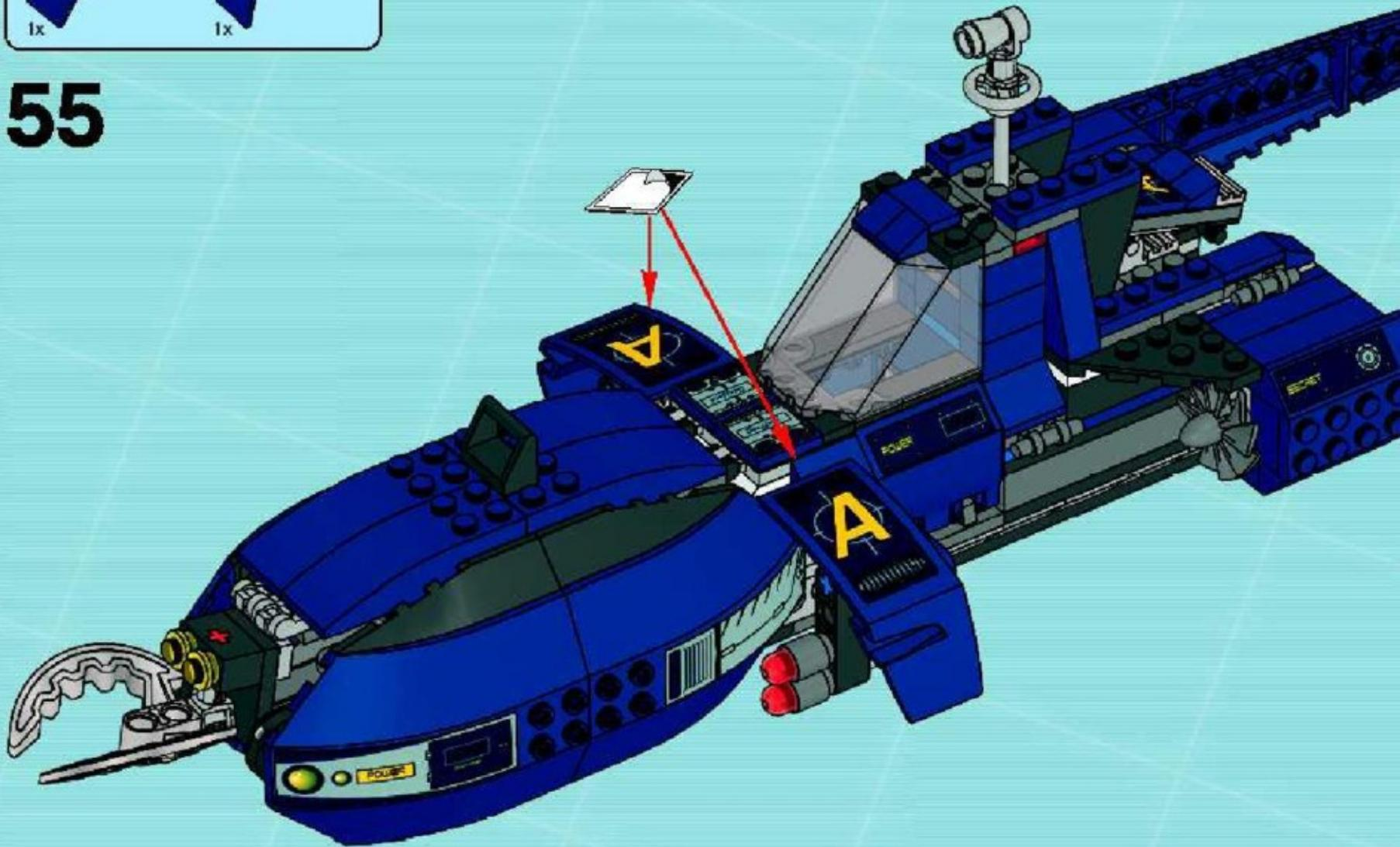



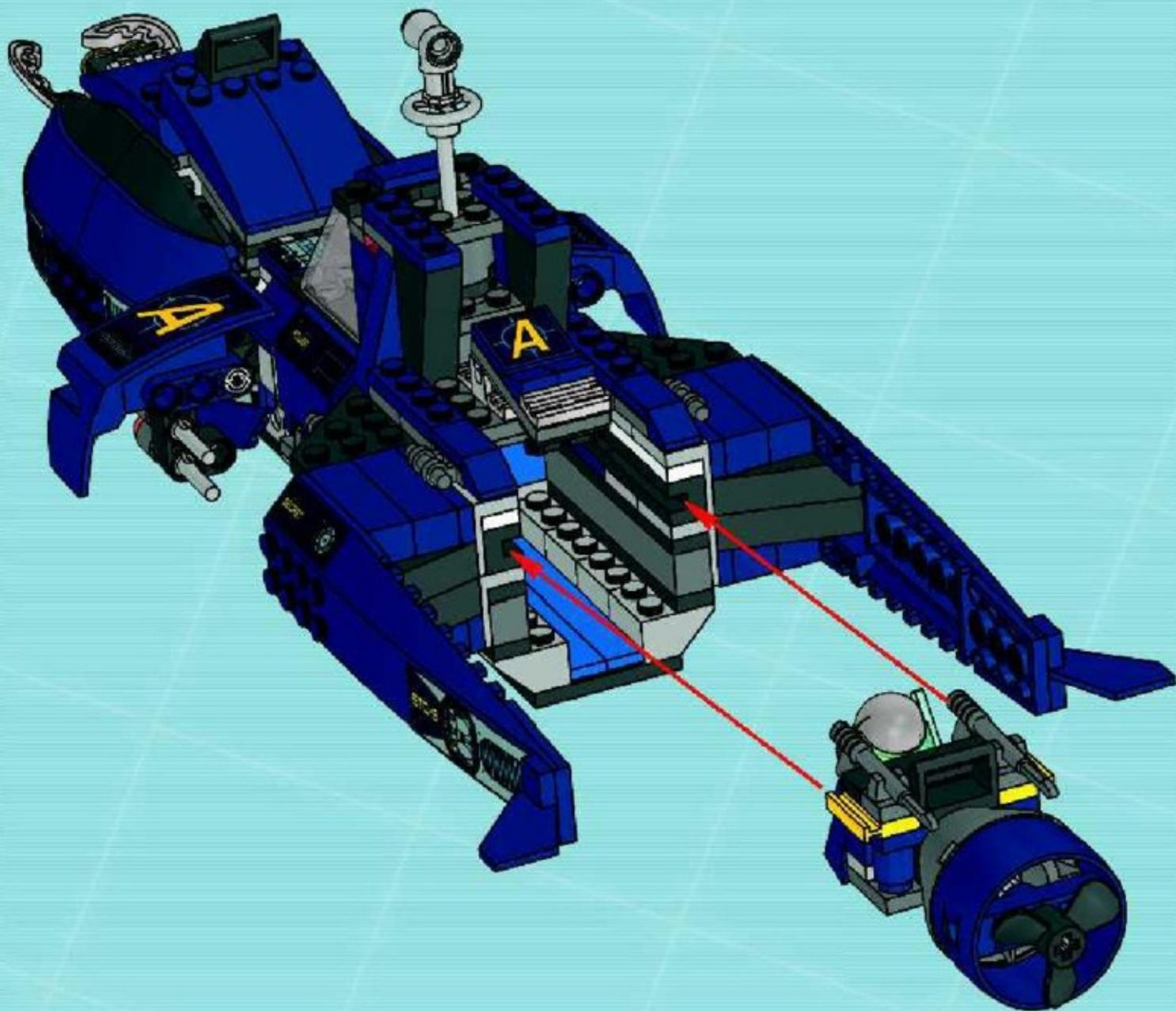



2x
348001



1x
303701



1x
4528214



1x
4527177



1x
4190164



1x
4500337



9x
4125254



8x
4157103



1x
4262601

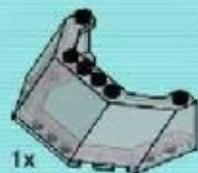

1x
4530473



1x
4533101



1x
4211163



1x
4211232



1x
4142865



1x
300721



2x
4529234



3x
302221



4x
4497943



7x
3000841



1x
4499885



4x
4539059



1x
4539097



2x
4539061



1x
300123



1x
614323



4x
4206482



2x
416223



7x
302323



1x
379523



2x
3005741



1x
4114306



2x
4186017



2x
3005744



1x
4278415



16x
4249891



9x
4264569



4x
4500610



2x
4533194



3x
4528488



5x
4205004



1x
4533192



2x
4528221



2x
4527738



13x
4502089



1x
4533193



6x
4504374



2x
4263367



6x
4153653



2x
4177741



2x
4527987



4x
4533196



1x
4529019



2x
4533191



4x
4239601



2x
362224



2x
300324



1x
4528200



1x
4528206



1x
4259916



1x
4185617



2x
4141630



2x
302124



1x
4534395



4x
4212454



2x
4114505

- 2x 4140801
- 1x 4185272
- 2x 611226
- 1x 389526
- 2x 300626
- 2x 300426
- 2x 4233487
- 2x 4144539
- 2x 235726
- 2x 243226
- 12x 4121715
- 2x 4227684
- 2x 4160025
- 1x 370526
- 1x 370626
- 1x 4216660
- 4x 243126
- 3x 306826
- 2x 4158848
- 1x 9339
- 1x 4535035
- 1x 4283047
- 1x 4283046
- 6x 244926
- 1x 4140303
- 2x 4526794
- 1x 393826
- 1x 379426
- 4x 4515340
- 3x 366626
- 4x 447726
- 5x 403226
- 1x 4124096
- 2x 302126
- 2x 303526
- 2x 302926
- 3x 604126
- 3x 4209085
- 2x 4160108
- 2x 4160130
- 2x 4121966
- 4x 265326
- 4x 4249857
- 2x 4223247
- 1x 4106921
- 4x 4120017
- 2x 654126
- 1x 370126
- 1x 368026
- 1x 486526
- 4x 4228063
- 1x 4215962
- 3x 4217436
- 2x 3005748
- 1x 4211865
- 8x 4520320
- 5x 4529241
- 2x 4211807
- 5x 4211615
- 1x 4211887
- 1x 4211553
- 1x 4211575
- 1x 4211439
- 1x 4226995
- 1x 4211701
- 2x 4511007

2x
4211479

1x
4244827

1x
4537900

2x
4515369

1x
4211840

1x
4211881

4x
4211505

2x
4211469

2x
4216248

14x
4211436

6x
4211718

1x
4258455

2x
4211361

1x
4211407

1x
4210115

14x
4277927

1x
4211564

2x
4211388

2x
4211440

3x
4211466

2x
4211392

2x
4211705

2x
4211435

2x
4129917

1x
4211051

3x
4210677

1x
4210642

1x
4519225

2x
4211085

2x
4211107

1x
4210963

1x
4249139

1x
4289258

1x
4222113

3x
4193107

2x
4518854

1x
4210814

2x
4210695

2x
4239896

2x
4211084

2x
4500608

4x
4211095

7x
4211069

6x
4210660

2x
4211056

13x
4227398

1x
4518308

2x
4212352

2x
4211096

1x
4211054

2x
4295253

6x
4211090

2x
4289542

2x
4211002

3x
4243831

2x
4256149

1x
4299625

1x
4535279

1x
4299347

14x
4278412

2x
4527061

1x
4535261

1x
4504949

1x
4528859

3x
4249040

Customer Service
Kundenservice
Service Consommateurs
Servicio Al Consumidor

www.lego.com/service or dial

00800 5346 5555
1-800-422-5346





8634*



AGENTS

NAME:

AGENT CHASE

STATUS:



8635*



8632*



8633*



8636*



8631*

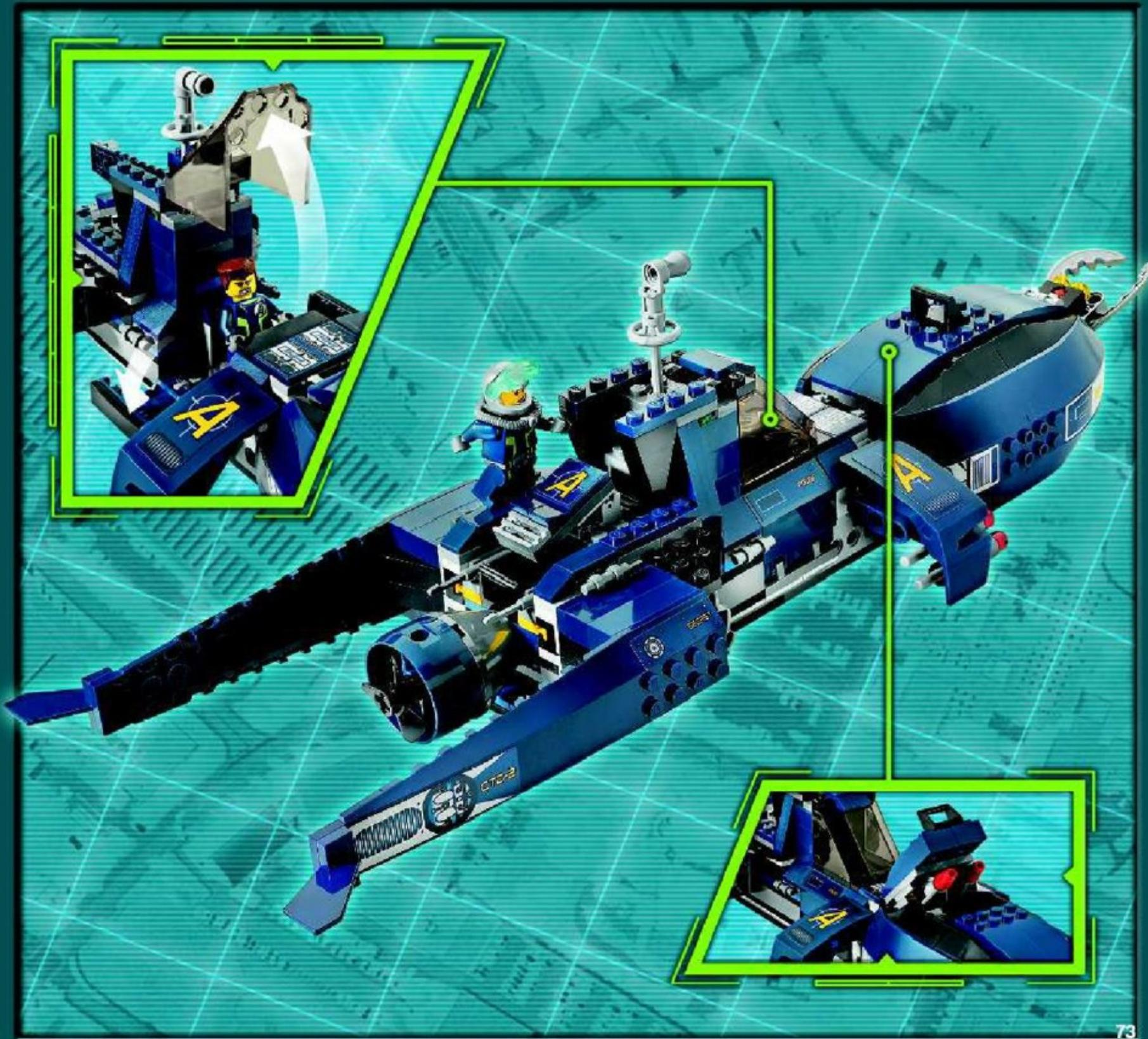

A promotional graphic for LEGO Technic. The background is a dark, teal, grid-like pattern with a bright green circular glow in the center. In the foreground, a large LEGO Technic car is shown in motion, kicking up a cloud of dust. The car is primarily white and blue, with a yellow 'A' logo on the front. A minifigure with black hair and a blue suit is driving. To the left, a LEGO Technic motorcycle is also in motion. In the upper half, four minifigures are shown in various poses. One is holding a large grey gun, another is holding a red gem, and another is holding a yellow tool. A fourth minifigure is in the background, holding a red gem. The text 'CHOOSE YOUR MISSION' is written in a stylized, bold, black font with a white outline across the middle of the image.

CHOOSE YOUR MISSION

www.acnielsen.aim.dk/LEGO



WIN LEGO® PRODUCTS

No purchase necessary.
Open to residents of all countries where
not prohibited.
Go to www, for official rules and details.

WIN LEGO® PRODUCTEN

Kopen niet nodig.
Open voor alle leeftijden, en in alle landen
waar geen verbod geldt.
Ga naar www, voor officiële regels en details.

GEWINNE LEGO® PRODUKTE

Die Teilnahme am Gewinnspiel führt zu
keinerlei Kaufverpflichtungen.
Sie können in allen nicht ausgeschlossenen
Ländern teilnehmen.
Die offiziellen Regeln und nähere Informationen
finden Sie unter www.

GAGNE DES PRODUITS LEGO®

Aucun achat n'est nécessaire.
Ouvert à tous les âges et aux résidents de
tous les pays, sauf en cas d'interdiction.
Rendez-vous sur www, pour obtenir plus
de détails et le règlement officiel.

レゴ®製品を「当てよう」

購入は不要です
禁止されていない限り、あらゆる
年代およびあらゆる国の居住者の
方々にご利用いただけます。
公認規則および詳細につきましては、
wwwをご覧ください

