

2.0

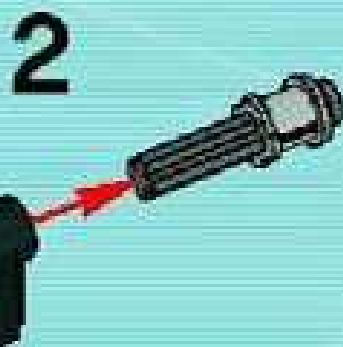

3



4

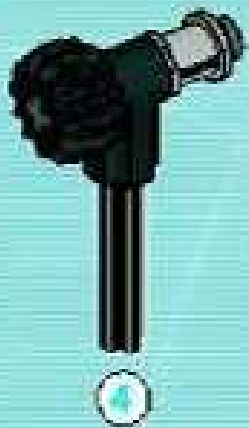

5



6

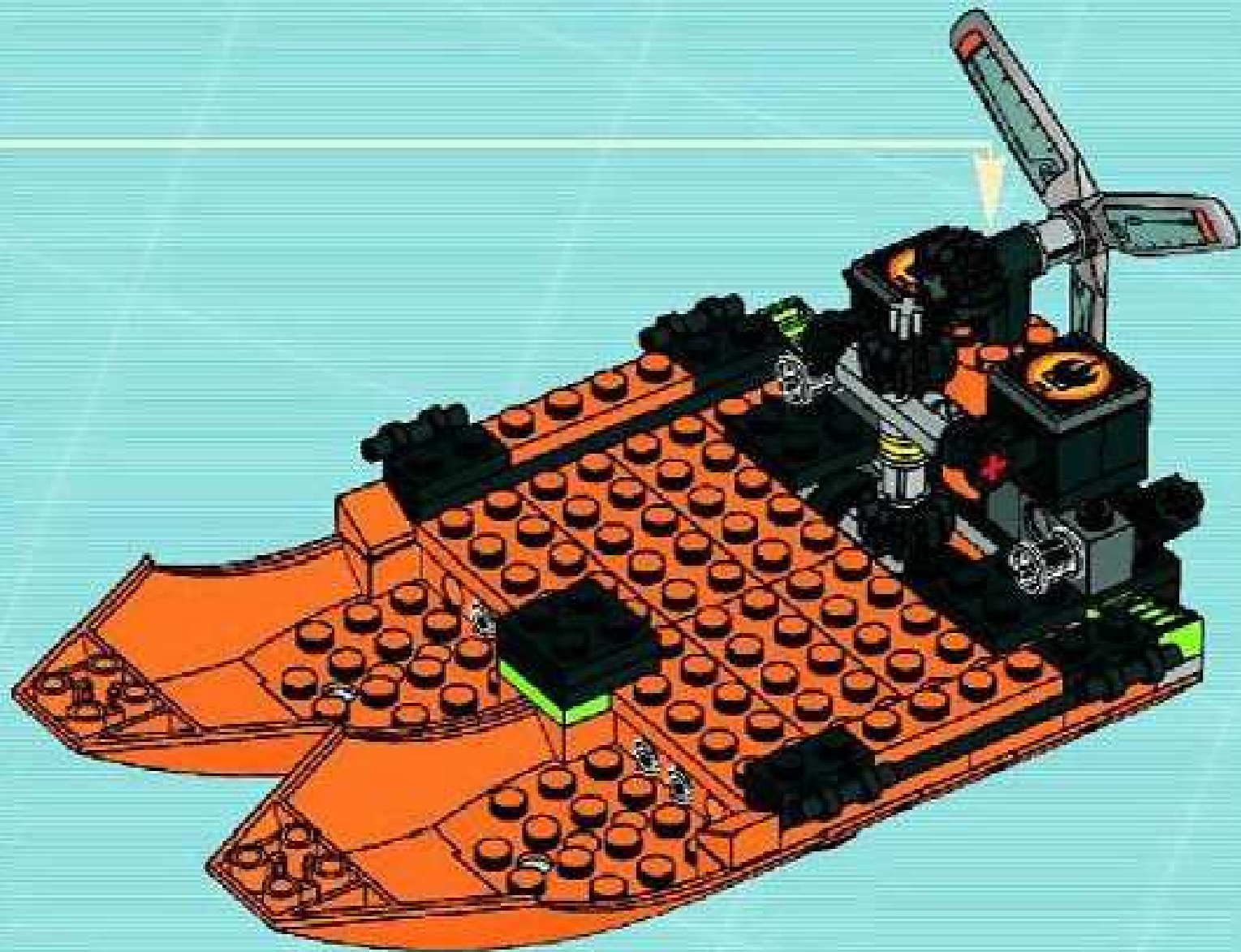
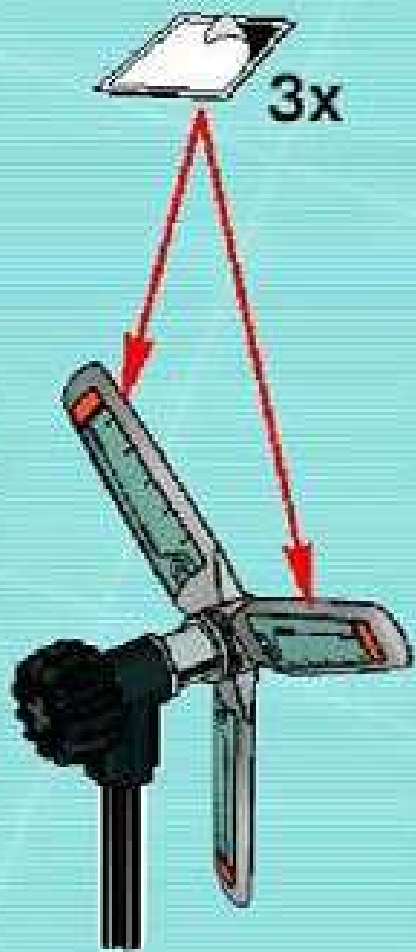



21

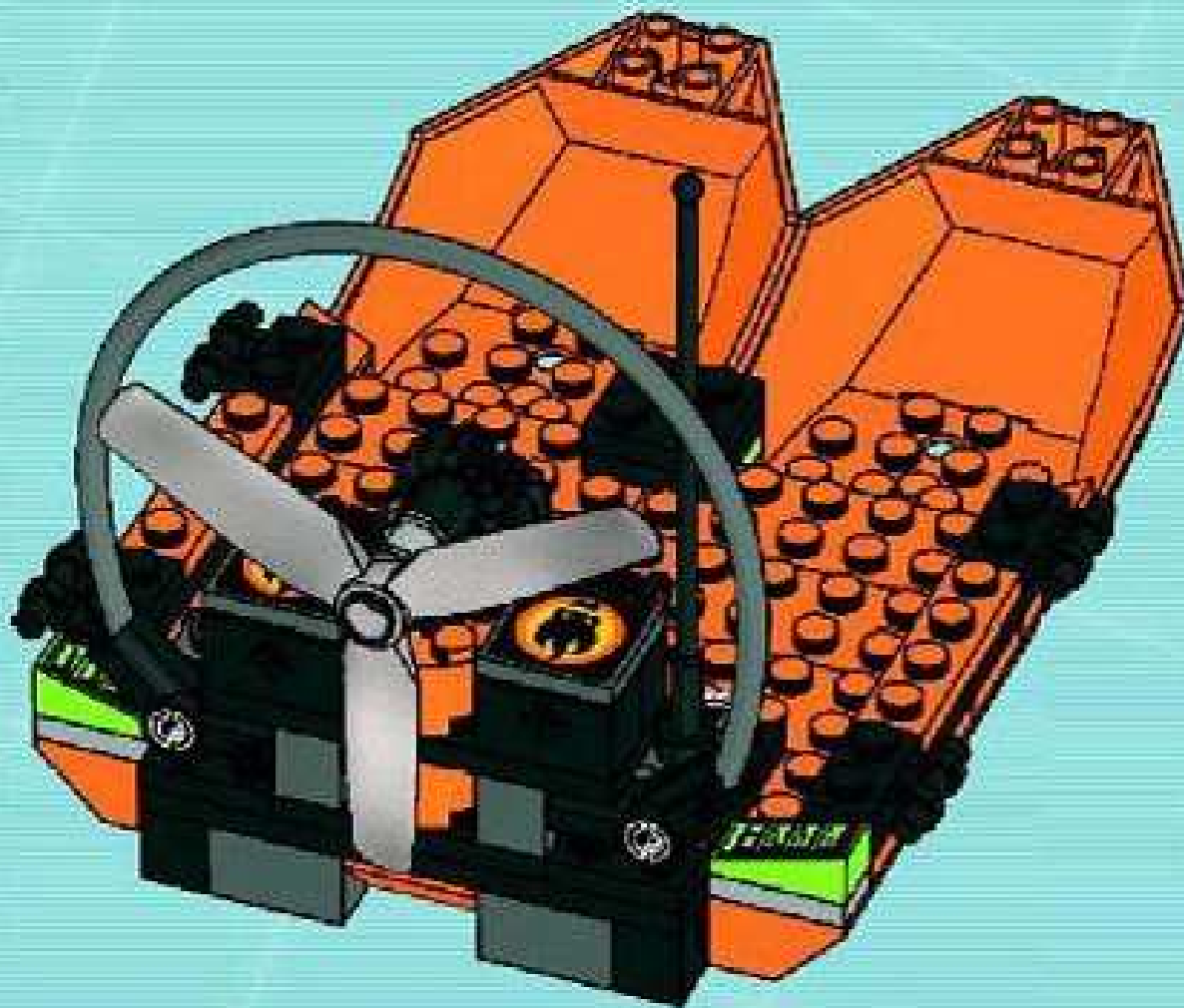



2x



4x

22

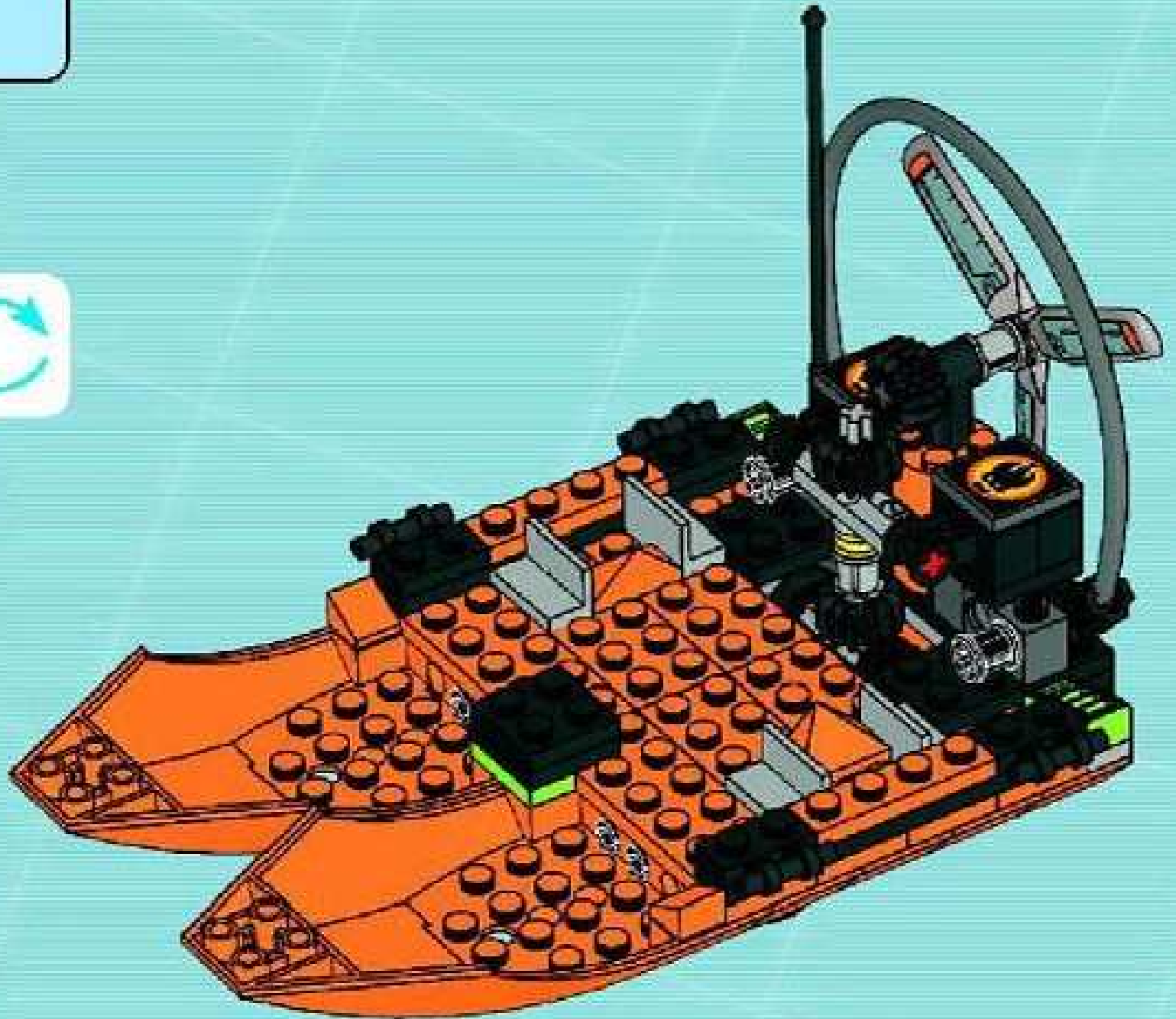



# 23

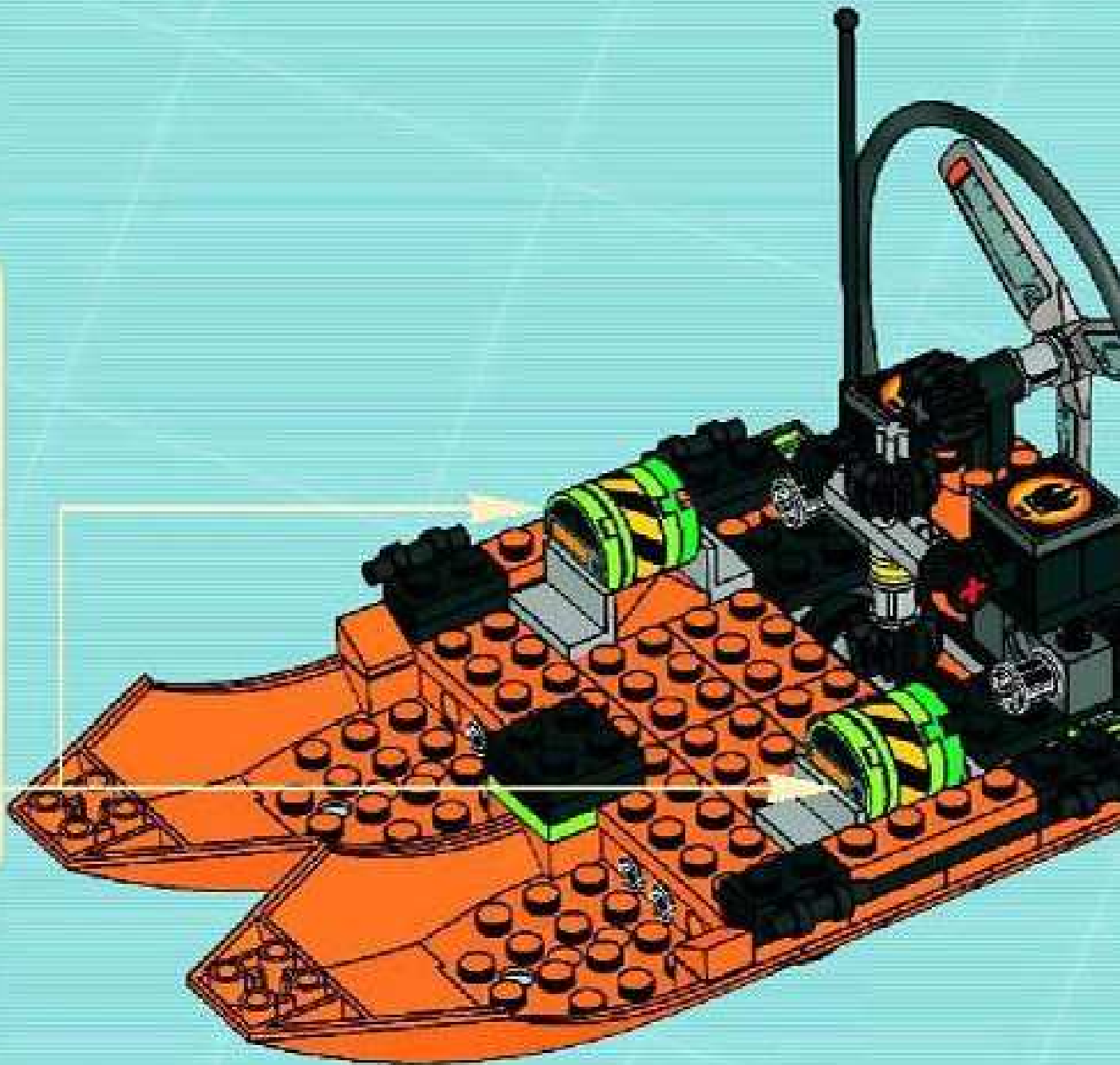
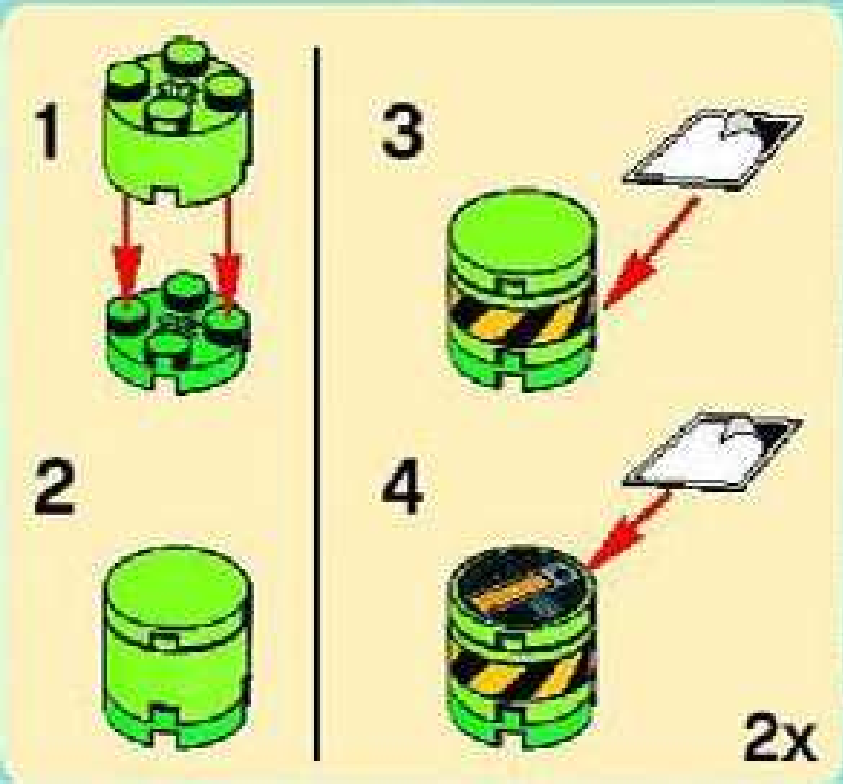

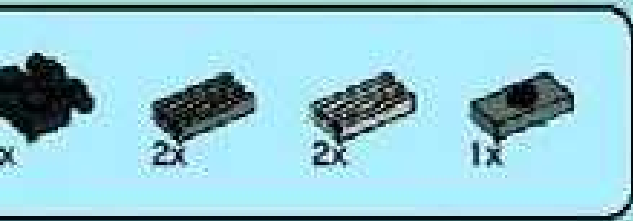

24

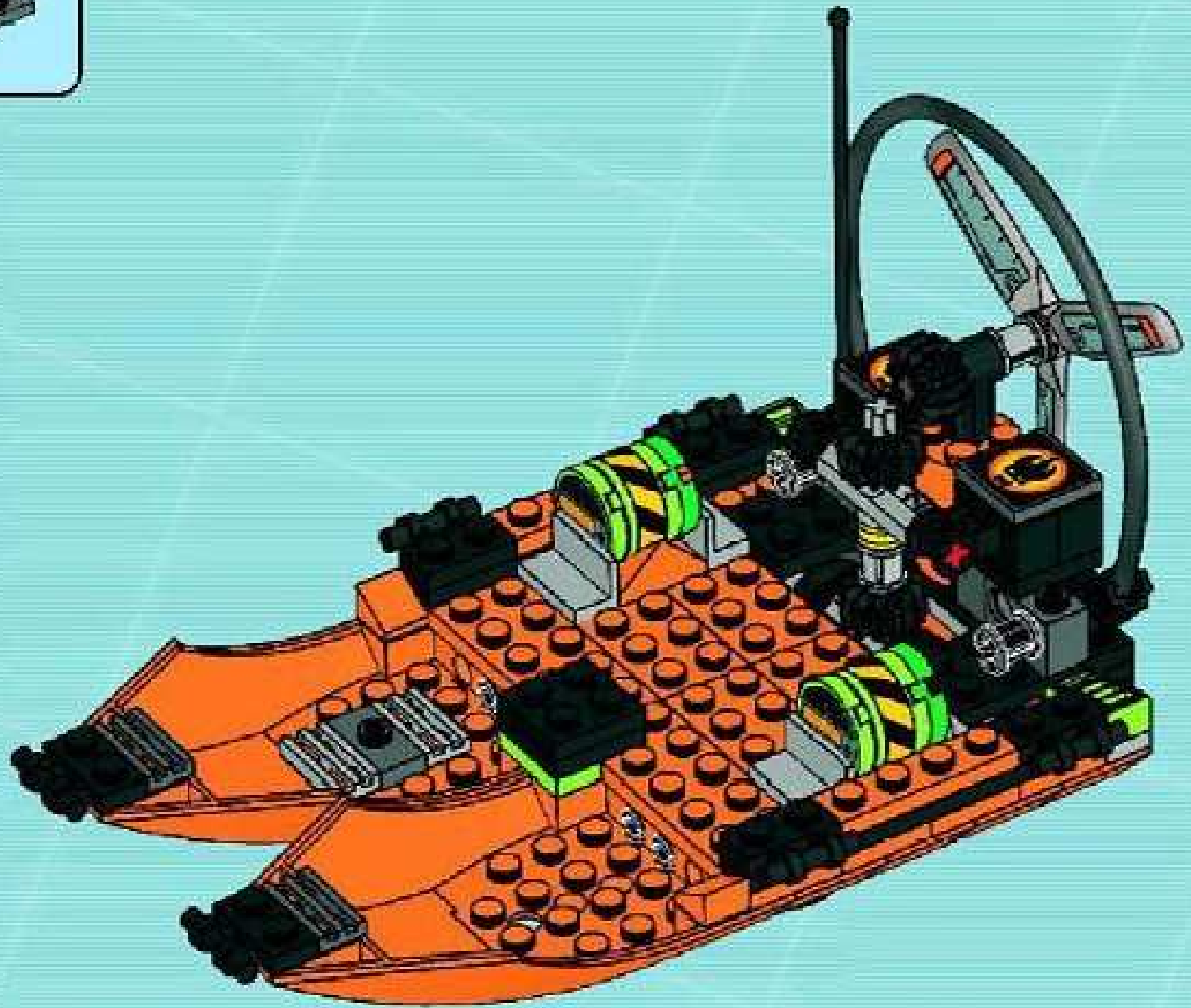



2x



2x

# 25

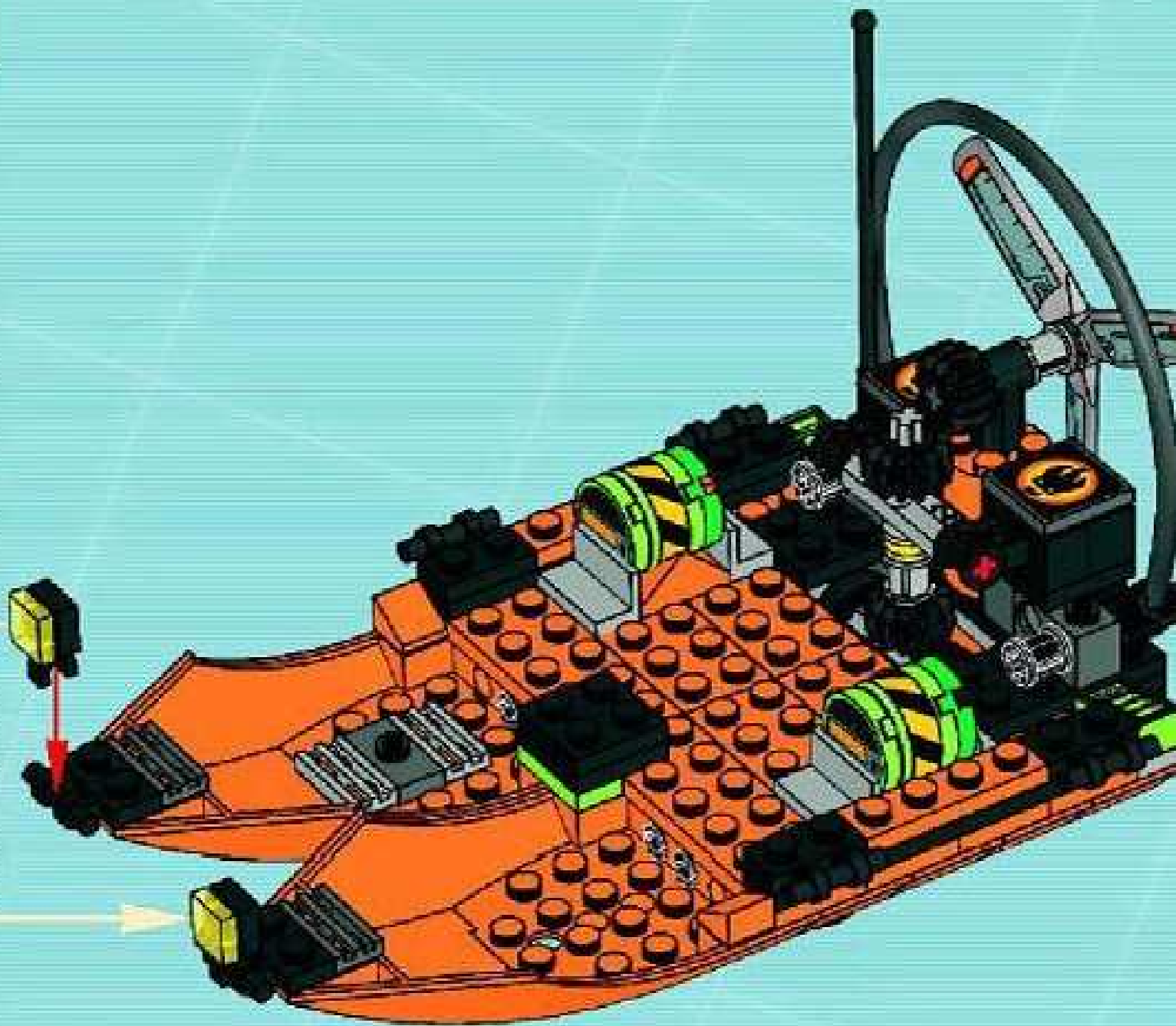
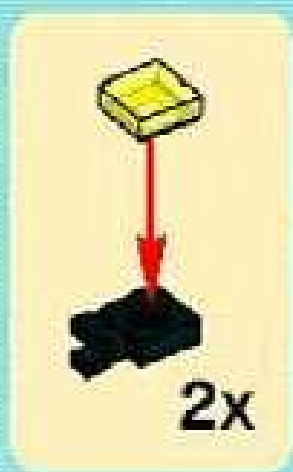



- 1x
- 1x
- 1x
- 1x
- 1x

26

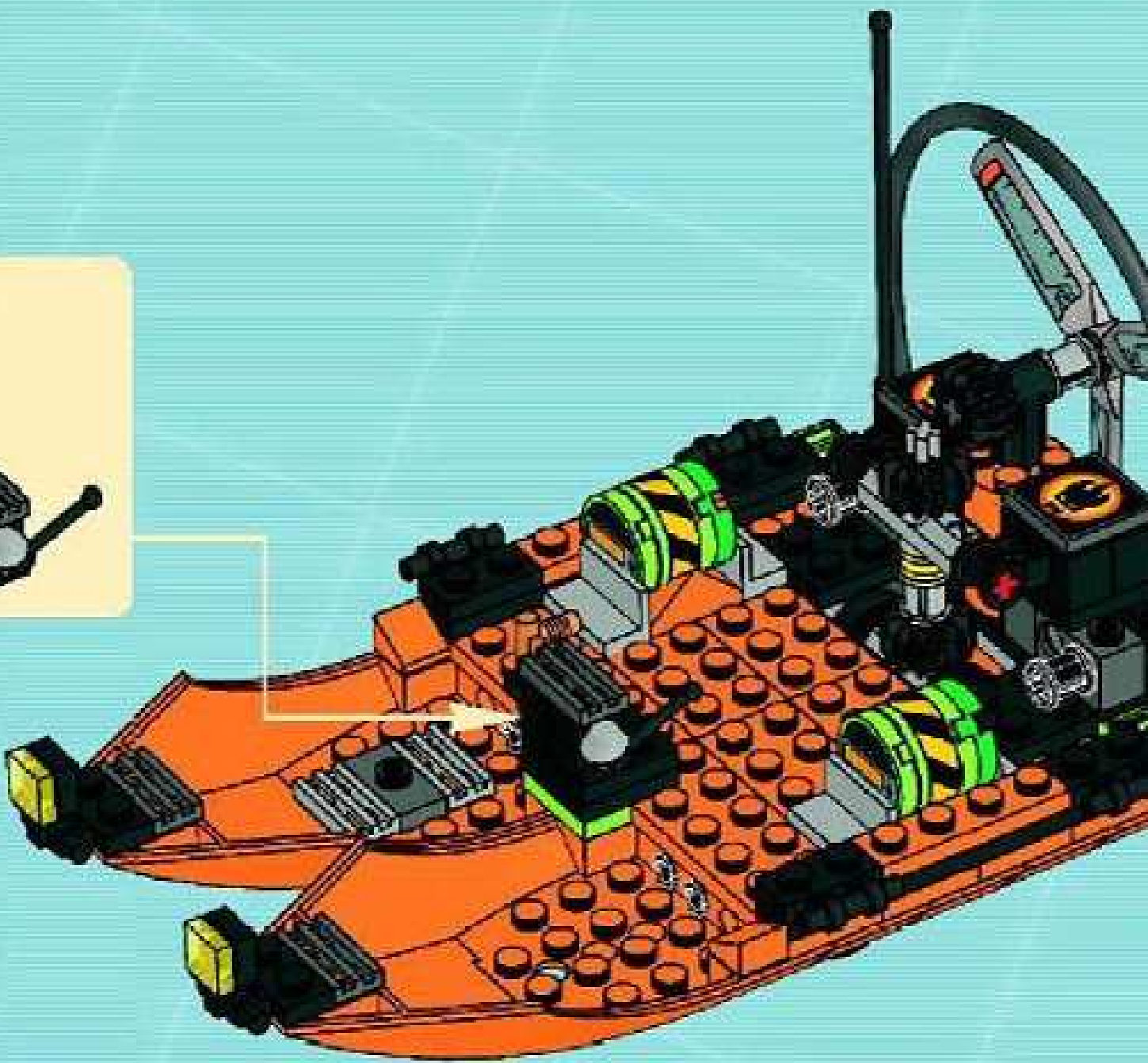
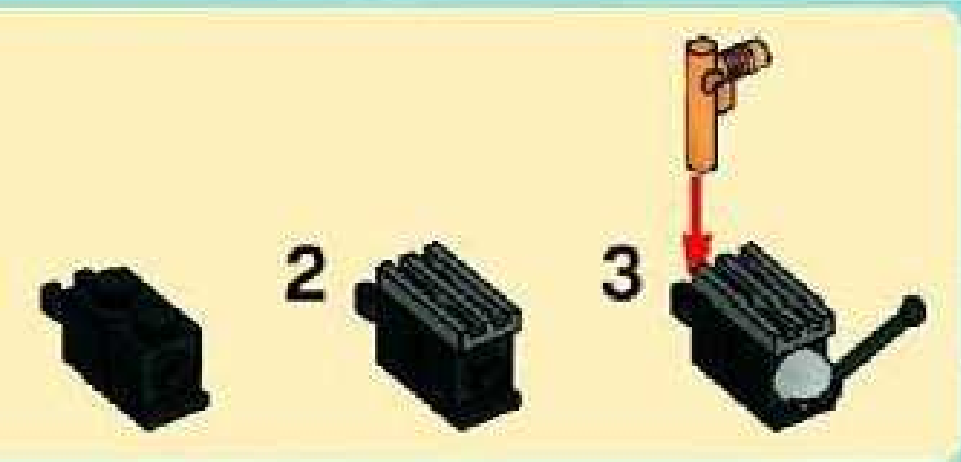



27

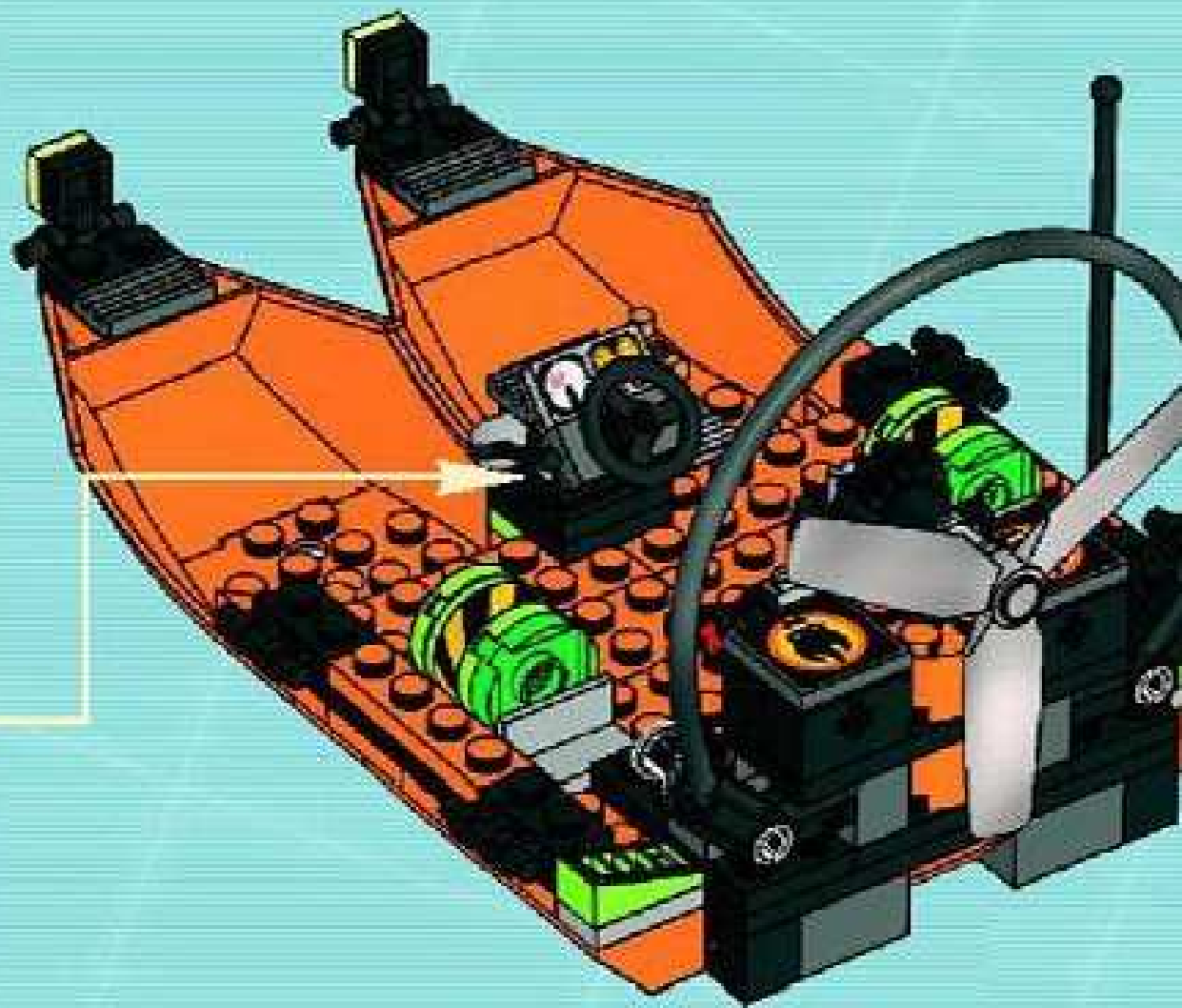
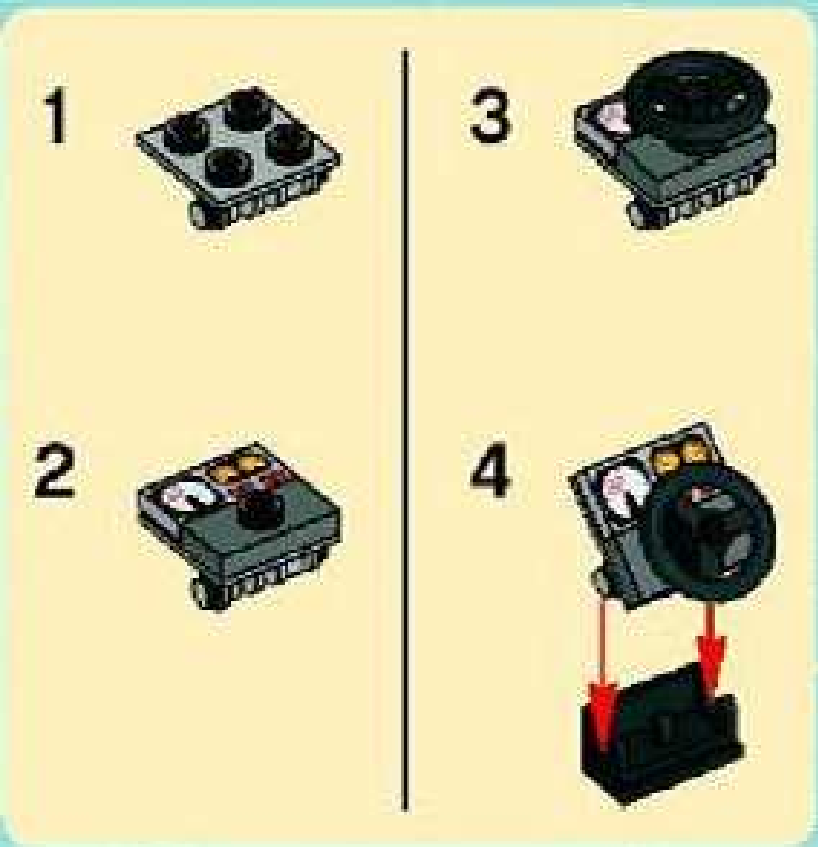

28

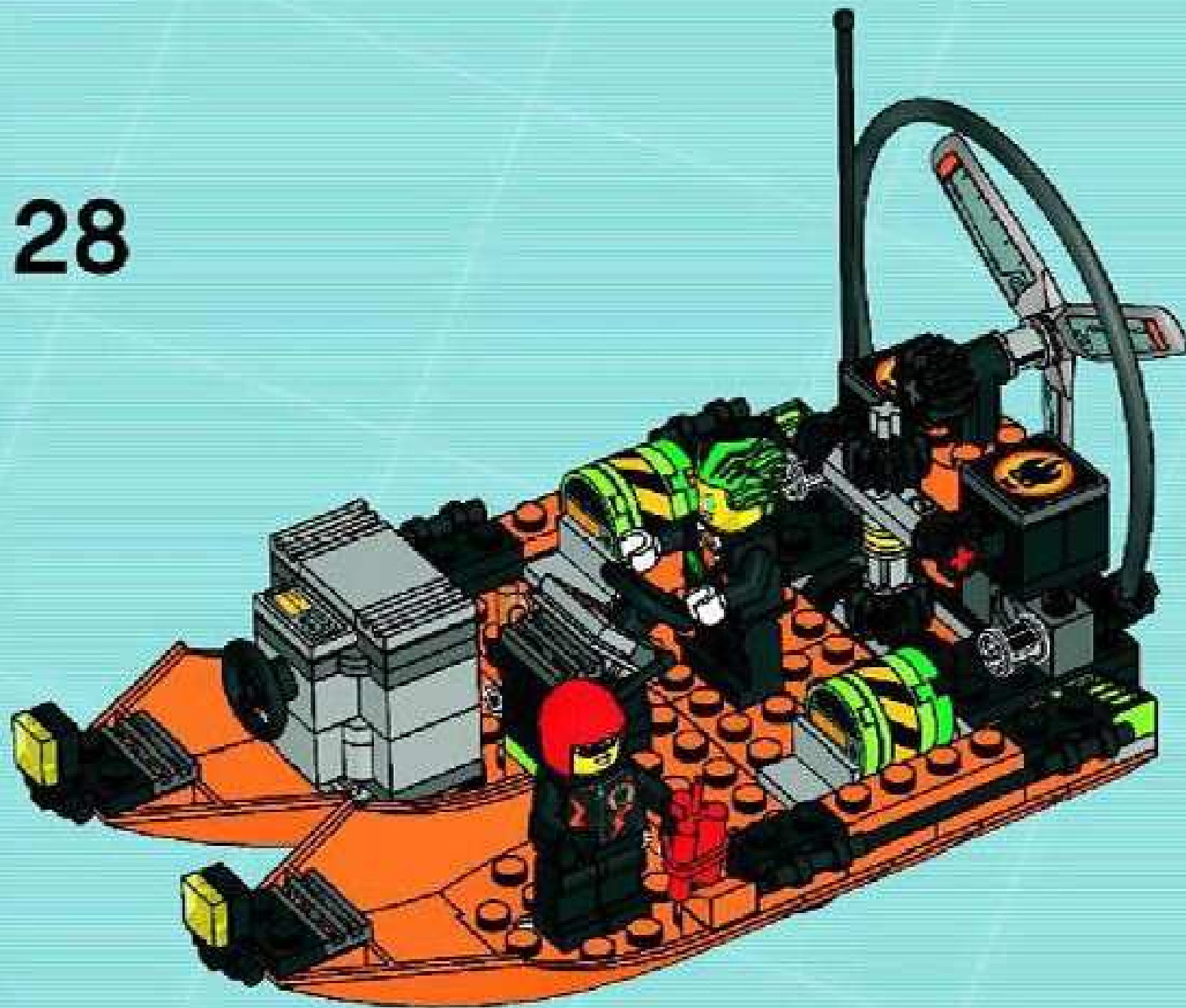



1x  
4529755

2x  
4142865

1x  
4210130

3x  
4239601

4x  
4233487

2x  
4517925

3x  
370225

2x  
4141089

1x  
4533780

2x  
4179828

1x  
4551221

1x  
4533771

6x  
4140588

2x  
496643

2x  
4540238

2x  
4529234

1x  
4162138

1x  
4551222

2x  
4107765

3x  
346028

3x  
4295280

2x  
4110782

2x  
302921

1x  
4226624

1x  
4528205

10x  
4121715

2x  
302228

1x  
4551249

2x  
4125278

1x  
4551223

2x  
4252437

2x  
3003944

2x  
370525

3x  
302028

2x  
403228

6x  
4121741

4x  
4206482

1x  
4526221

2x  
4140801

4x  
4177431

1x  
3200126

2x  
4527943

2x  
4504371

1x  
4143005

1x  
4527738

2x  
4121810

2x  
9339

1x  
393726

2x  
4541957

9x  
4118829

5x  
4278275

1x  
4107085

1x  
4552464

2x  
4153944

1x  
4164037

1x  
407026

1x  
4552507

0385



1x  
4211388



1x  
4211414



1x  
4211359



2x  
4211046



1x  
4211133



1x  
4180464

0320



2x  
4211564



1x  
4221776



1x  
4211881



2x  
4210797



2x  
4211065

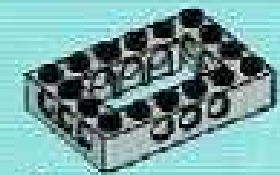

1x  
4211716

850



1x  
4211815



1x  
4211413



4x  
4211350



1x  
4211086



1x  
4549549



1x  
2561026

567



1x  
4211839



1x  
4211461



2x  
4211517



2x  
4211055



3x  
4211631

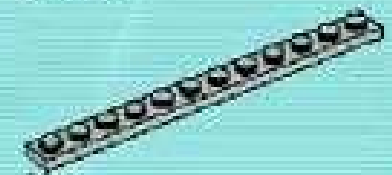

1x  
4514840

222



1x  
4512360



1x  
4211450



2x  
4211535



1x  
4261908

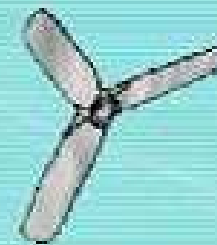

1x  
4527986

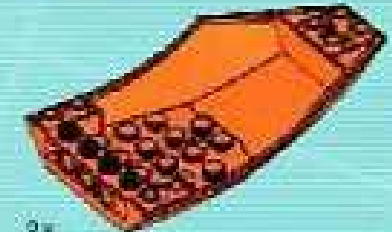

2x  
4551539

Customer Service

customerservice

Service Consommateurs

servicio Al Consumidor

[www.lego.com/service](http://www.lego.com/service) or dial



00 5346 5555 :



0-422-5346 :



1x  
4211440



1x  
4271344



4x  
4211515



1x  
4210719



1x  
4518400



4x  
4210762



3x  
4211119



1x  
4537552



1x  
4552549



# AGENTS 2.0

8970

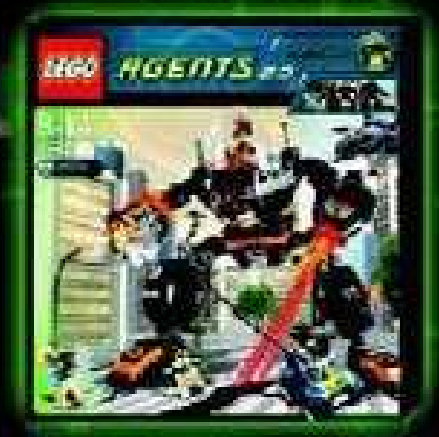

8971

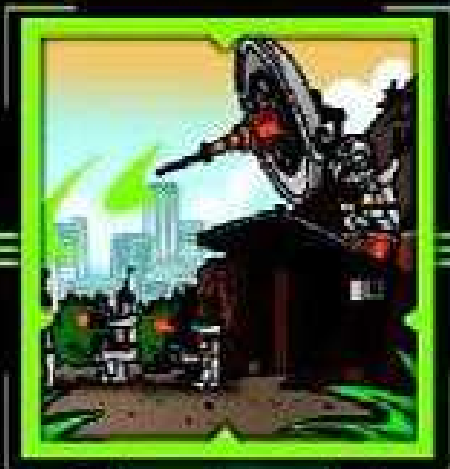

**FREE! GRATIS! GRATUIT!**

**LEGO club**  
MAGAZINE™

**www.LEGOclub.com**



**00800 5346 5555\*** 

 **1-866-534-6258 • 1-877-518-5346**

US & Canada only

Canada seulement

\*Some restrictions may apply. \*\*Market and price list subject to change without notice. \*\*\*In addition, the price of the magazine is included in the price of the magazine. \*\*\*\*The price of the magazine is included in the price of the magazine. \*\*\*\*\*The price of the magazine is included in the price of the magazine. \*\*\*\*\*The price of the magazine is included in the price of the magazine.



**VISIT THE WORLD'S  
BIGGEST LEGO® SHOP!**

**www.LEGOshop.com**

**YES! I want to join the LEGO® Club FREE! OUI! Je veux m'abonner au Club LEGO® GRATUITEMENT! Ja! Ich möchte Mitglied im kostenlosen LEGO® Club werden. Ja! Ik wil graag GRATIS lid worden van de LEGO® Club. Ja! Jeg ønsker å melde meg inn i LEGO® Club gratis! Ja! Jeg vill gå med i LEGO® Club GRATIS!**

- Pressen  
 - Forretningsforretning  
 - Familie  
 - Bedrift

- Kvinne  
 - Mann

- Barn  
 - Ungdom  
 - Voksen

- Adresse  
 - Postnummer  
 - Land

- Postkoden  
 - Postby

- Land  
 - Postnummer

I agree that my personal data will be used for the purposes of the LEGO Group. I agree that my personal data will be used for the purposes of the LEGO Group. I agree that my personal data will be used for the purposes of the LEGO Group.

- Yes  
 - No

I agree that my personal data will be used for the purposes of the LEGO Group.

The English language version of the magazine can only be mailed to addresses in the US, Canada, the UK, and Republic of Ireland. Club membership is valid for two years and includes free copies of the LEGO Club magazine. In the US and Canada, please allow up to 8 weeks for delivery of your first magazine. In the UK and Republic of Ireland, please allow up to 14 weeks for delivery of your first magazine. By signing this form you consent to use your child's data for LEGO mailings. The data will only be used for LEGO mailings and will not be sold, rented or otherwise disclosed to any company outside the LEGO Company except for disclosure to companies agents to help us provide services requested by the child. This coupon is valid for one free membership per person, group or organization. Photocopied coupons are accepted. La version française du magazine peut uniquement au Canada. L'abonnement est valide pour 2 ans et inclut des exemplaires gratuits du Magazine LEGO. Aux E-U et au Canada, allow 8 semaines pour la livraison initiale. En remplissant ce formulaire, vous consentez à utiliser les informations de votre enfant pour des envois postaux de LEGO. L'information sera utilisée uniquement pour des envois postaux par LEGO et ne sera en aucun cas vendue, louée, cédée ou divulguée à d'autres que la compagnie LEGO, à l'exception des compagnies affiliées qui nous procurent des services auxquels l'enfant en a fait la demande. Des deuxlinguistique LEGO Club Magazine kann nur an Adressen in den USA, Kanada, Großbritannien und der Schweiz verschickt werden. Die kostenlose Mitgliedschaft beinhaltet die Zusendung des LEGO Club Magazins und endet nach zwei Jahren. Mit der Anmeldung geben Sie seine Verpflichtungen ein. In den USA und Kanada, bitte erlauben Sie bis zu 8 Wochen für die Lieferung des ersten Magazins. In Großbritannien und der Republik Irland, bitte erlauben Sie bis zu 14 Wochen für die Lieferung des ersten Magazins. Durch das Unterschreiben dieses Formulars erklären Sie, dass Sie Ihre Daten der LEGO Gruppe zur Verfügung stellen. Die Daten werden ausschließlich für den Versand von LEGO-Magazinen verwendet. Dieses Gutschein ist nur für eine kostenlose Mitgliedschaft pro Person, Gruppe oder Organisation gültig. Fotokopierte Gutscheine sind akzeptiert. Den engelspråkige versjonen av tidsskriftet kan kun bli adressert i USA, Canada, Storbritannia og Republikken Irland. Medlemskapet er gyldig i to år og inkluderer gratis eksemplarer av LEGO Club Magazine. Ved å undertegne dette skjemaet, gir du ditt barns personlige data til bruk for LEGO-posting. Dataene vil kun brukes til å sende LEGO-tidsskrift og vil ikke bli solgt, utleide eller på annen måte gjøres tilgjengelig for selskaper utenfor LEGO-gruppen. Dette skjemaet gjelder for ett gratis medlemskap per person, gruppe eller organisasjon. Den svenske versionen av tidsskriftet kan endast bli adresserat i USA, Kanada, Storbritannien och Sverige. Medlemskapet är giltigt i 2 år och inkluderar gratis exemplar av LEGO Club Magazine. Vid å underskriva detta skemaet, gir du ditt barns personlige data til bruk for LEGO-posting. Dataene vil kun brukes til å sende LEGO-tidsskrift og vil ikke bli solgt, utleide eller på annen måte gjøres tilgjengelig for selskaper utenfor LEGO-gruppen. Dette skjemaet gjelder for ett gratis medlemskap per person, gruppe eller organisasjon.

Mail to: / Poster ic:  
    
 BGG9

Mail to:  
    
 B109U

Per Post to:  
    
 B109C

Stuur op naar:  
    
 B109N

Send till:  
    
 B109O

Skicka till:  
    
 B109S

Post  
 En  
 33  
 Stou  
 United  
 Post  
 B-36243 H  
 Post  
 3504 A  
 LEGO® C  
 Po  
 1314 V  
 LEGO® Clu  
 202



### WIN LEGO® PRODUCTS

Take a survey and you might WIN a cool LEGO product!  
PURCHASE NECESSARY  
Open to all residents where not prohibited  
Go to [www.nielsen.com/LEGO](http://www.nielsen.com/LEGO) to fill out a survey for a chance to win a cool LEGO product.

### WIN LEGO® PRODUCTEN

Neem een enquêteformulier in en maak kans op een cool LEGO® product!  
Aankoop is niet nodig  
Open voor iedereen waar geen enquêteverbod geldt mag deelnemen.  
Ga naar [www.nielsen.com/LEGO](http://www.nielsen.com/LEGO), vul een enquêteformulier in en maak kans op een LEGO product.

### GEWINNE LEGO® PRODUKTE

Nimm an der Umfrage teil und GEWINNE ein tolles LEGO® Produkt!  
Einkauf ist nicht erforderlich  
Nimm an der Umfrage teil und GEWINNE ein tolles LEGO® Produkt!  
Einkauf ist nicht erforderlich  
Nimm an der Umfrage teil und GEWINNE ein tolles LEGO® Produkt!  
Einkauf ist nicht erforderlich

### GAGNE DES PRODUITS LEGO®

Prenez part d'un questionnaire et tu pourrais GAGNER un produit LEGO® cool!  
Achat obligatoire  
Ouvert à tous les résidents des pays autorisés.  
Allez sur [www.nielsen.com/LEGO](http://www.nielsen.com/LEGO) pour répondre à un questionnaire et avoir une chance de gagner un produit LEGO.

### レゴ®製品を「当てよう」

アンケートに記入して、カッコいいレゴ®製品を当てよう！  
購入の必要はありません。  
禁止されていない国で、すべての郵便局にご利用いただけます。  
[www.nielsen.com/LEGO](http://www.nielsen.com/LEGO)にアクセスして、アンケートに入ってください。当選者にはレゴ®製品を差し上げます。



**LEGO**

# AGENTS 2.0

MISSION

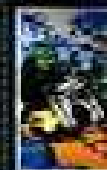

368



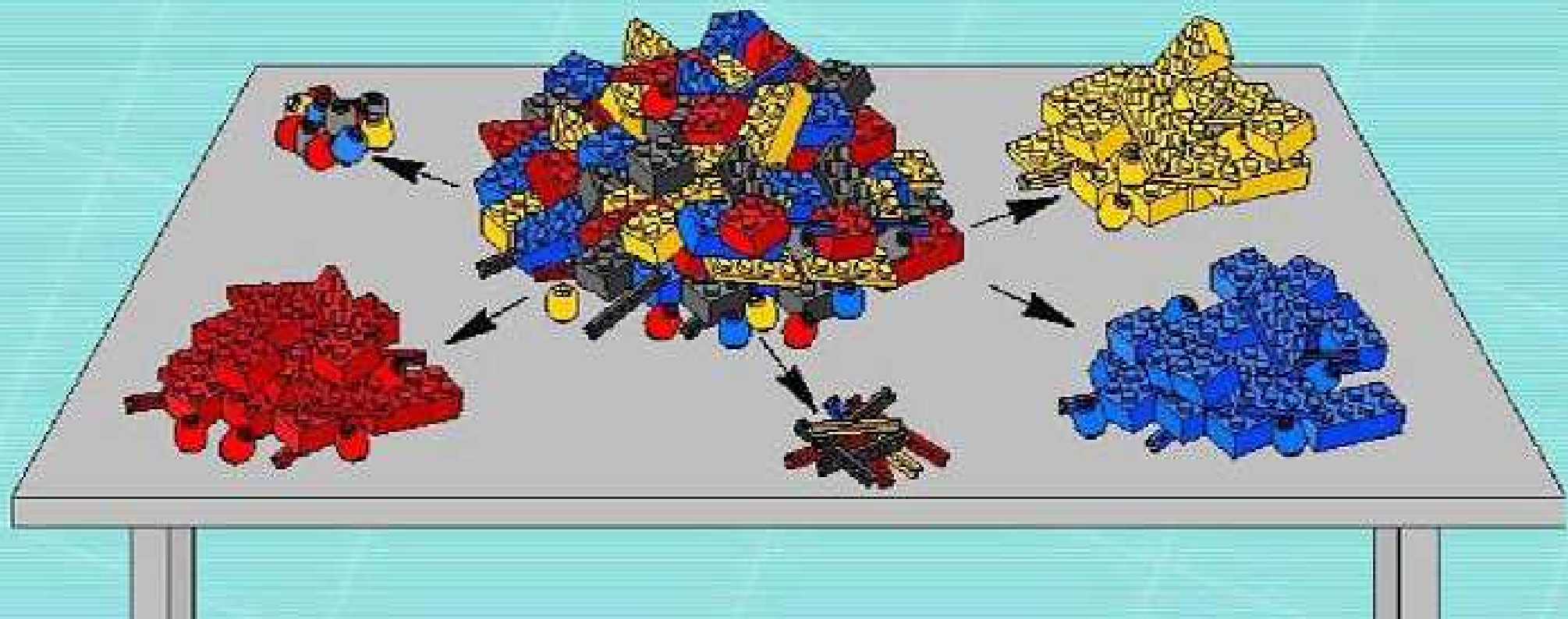
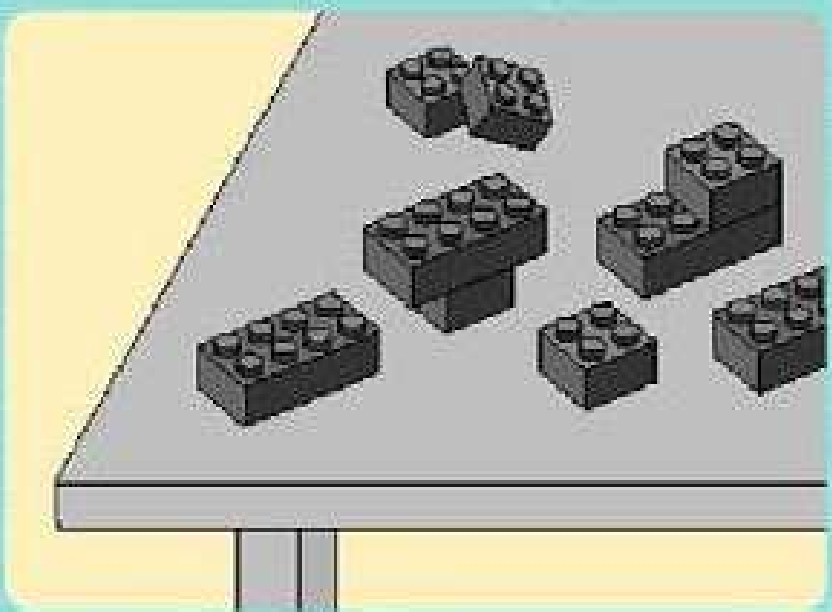

3

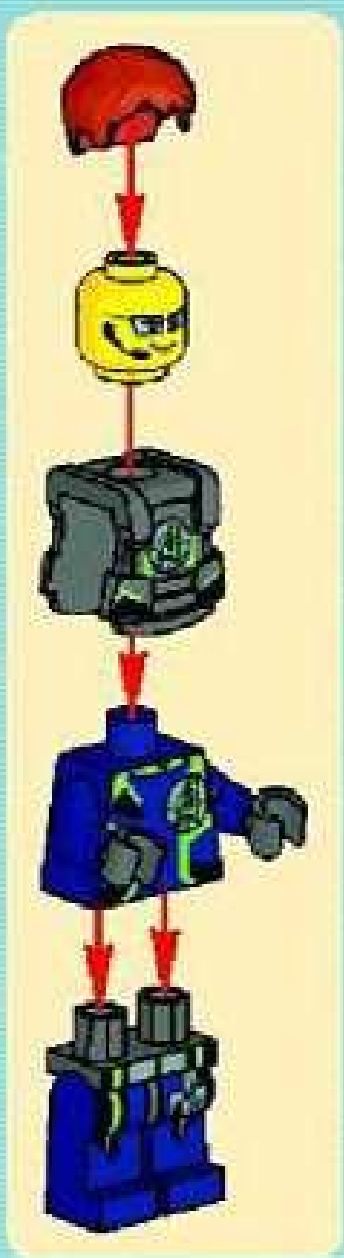



1x

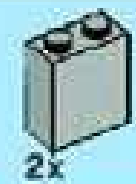

2x

2

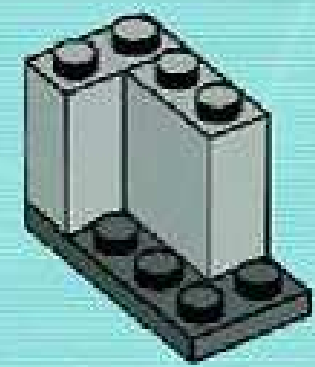

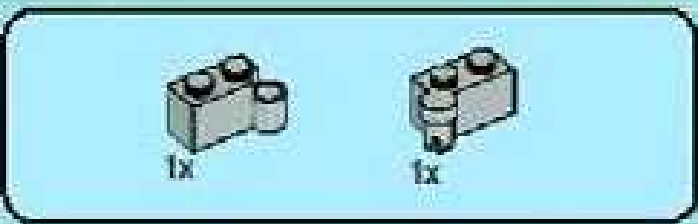

3

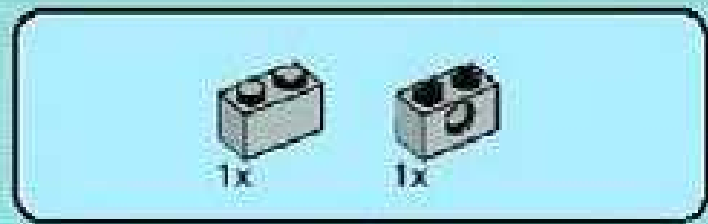

4

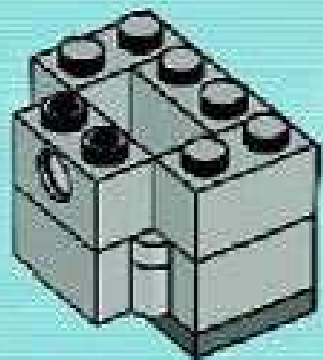
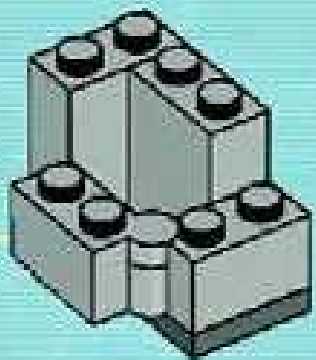
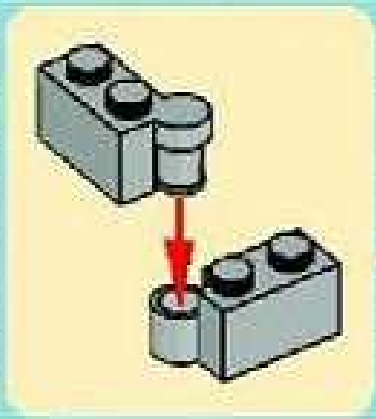

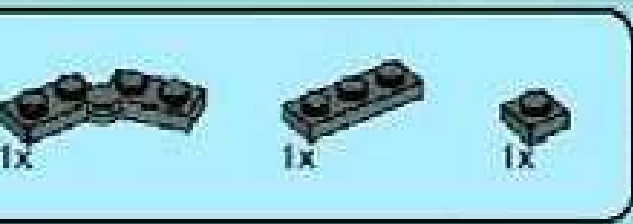

5

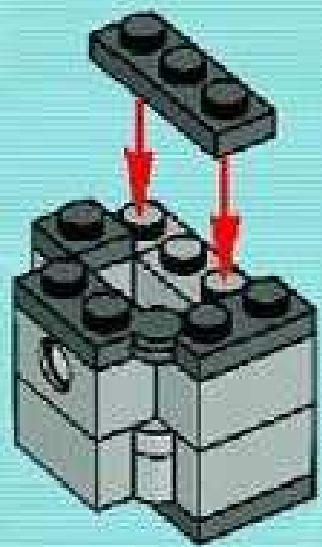

6

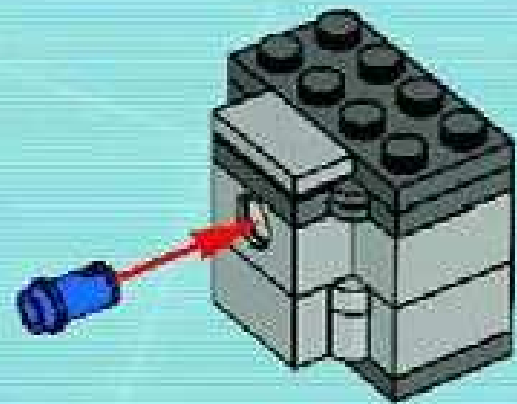



7

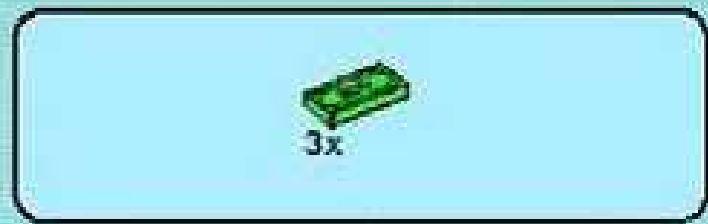
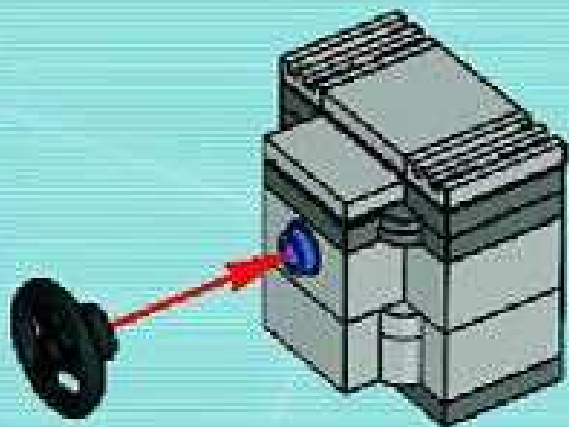

8

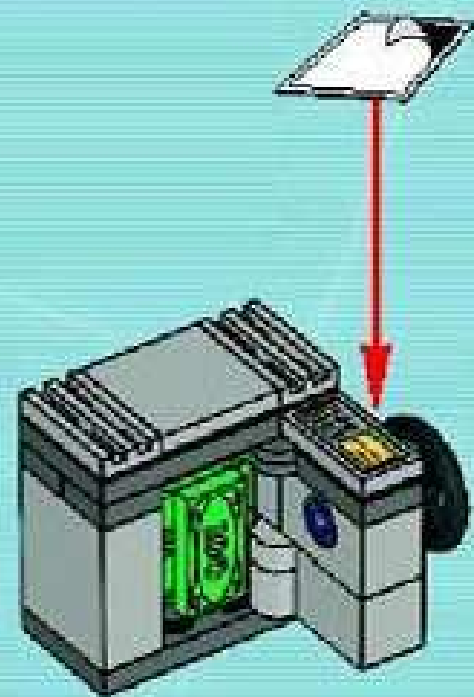



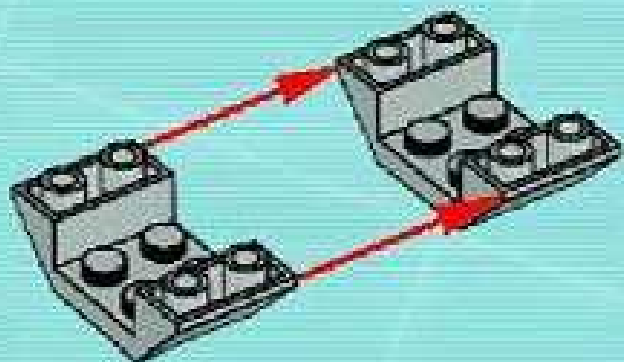
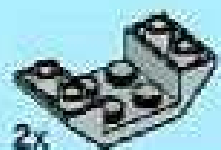

2

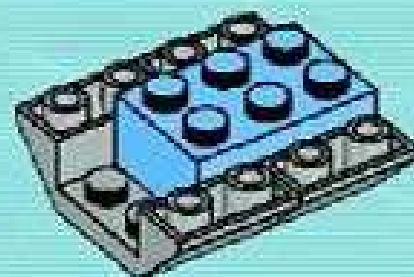



1x

3

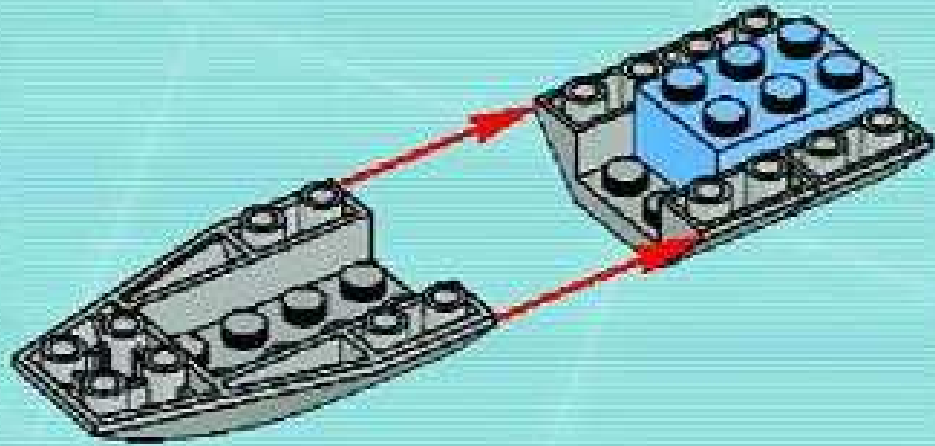

2x

4

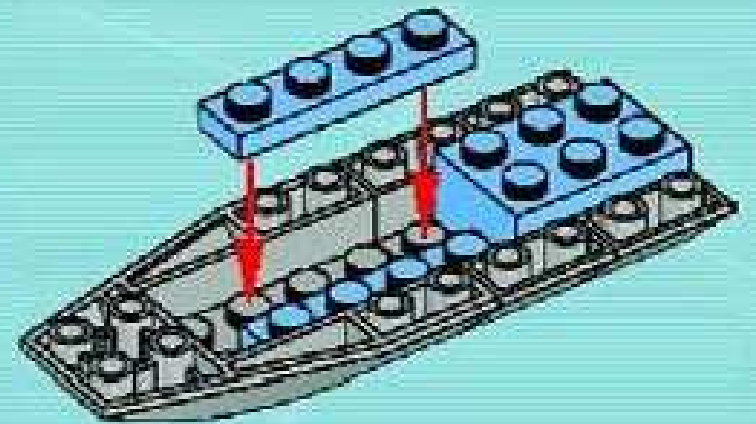

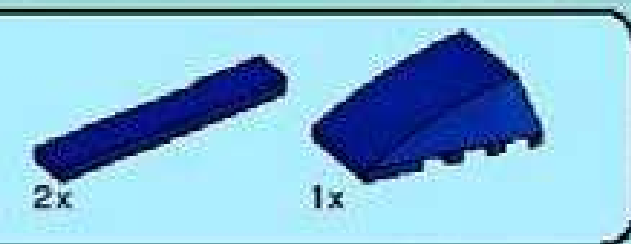

5

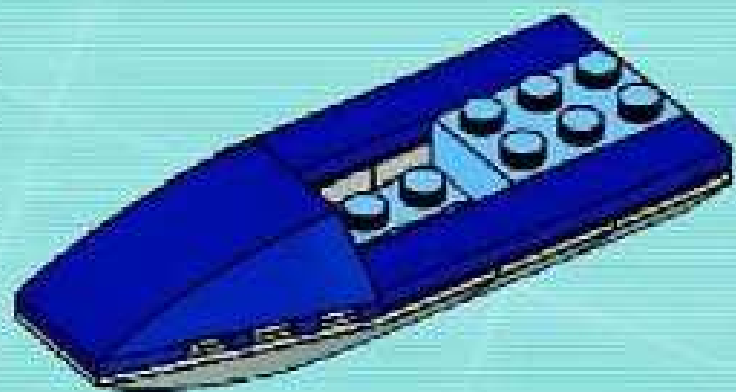

6

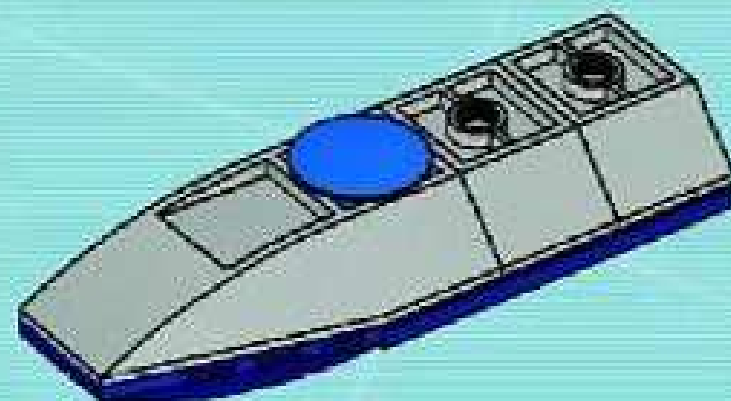



2x

7

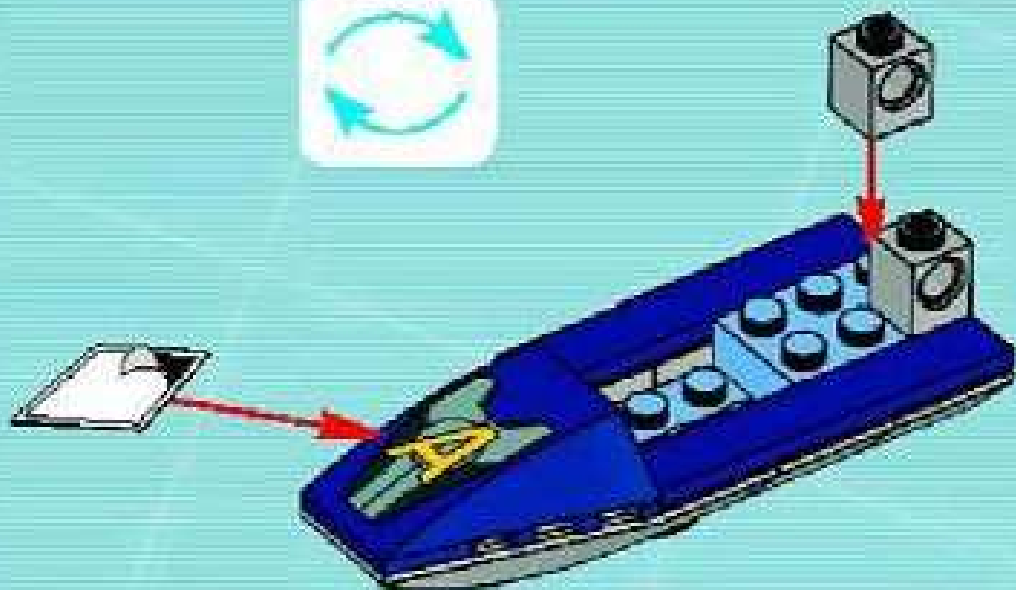

1x

8

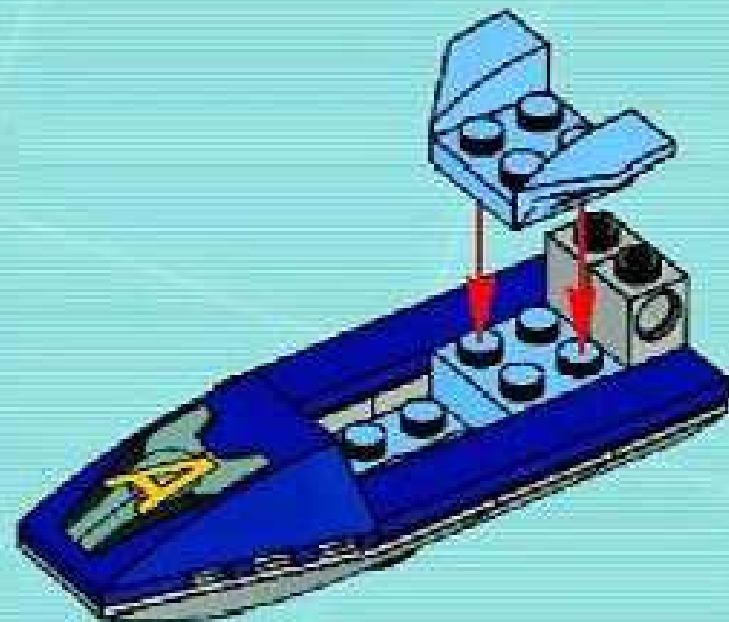



2x



2x



2x

# 10

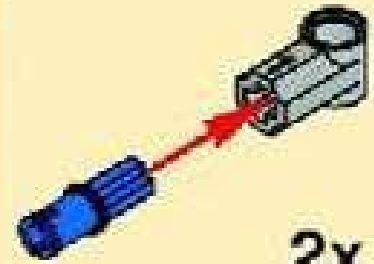

2x



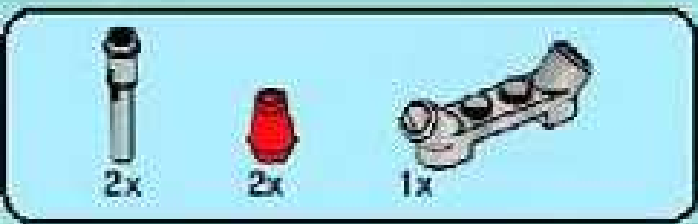

11

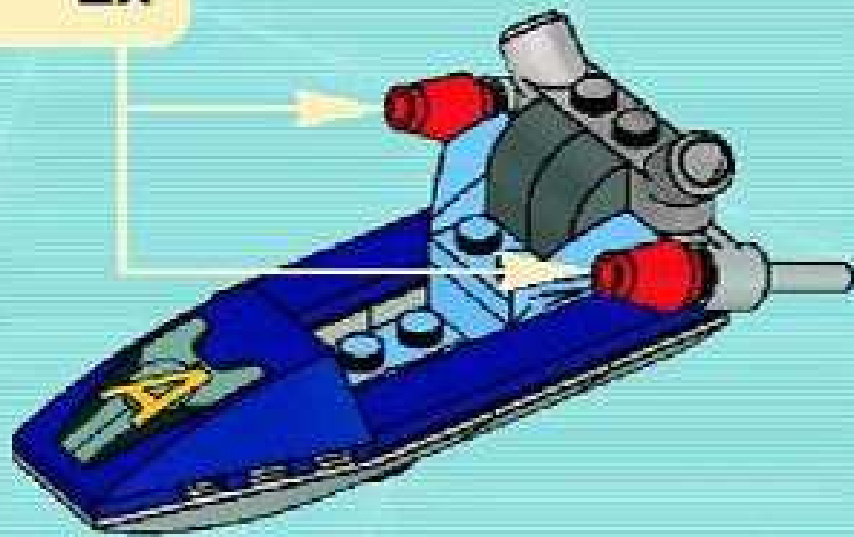

12

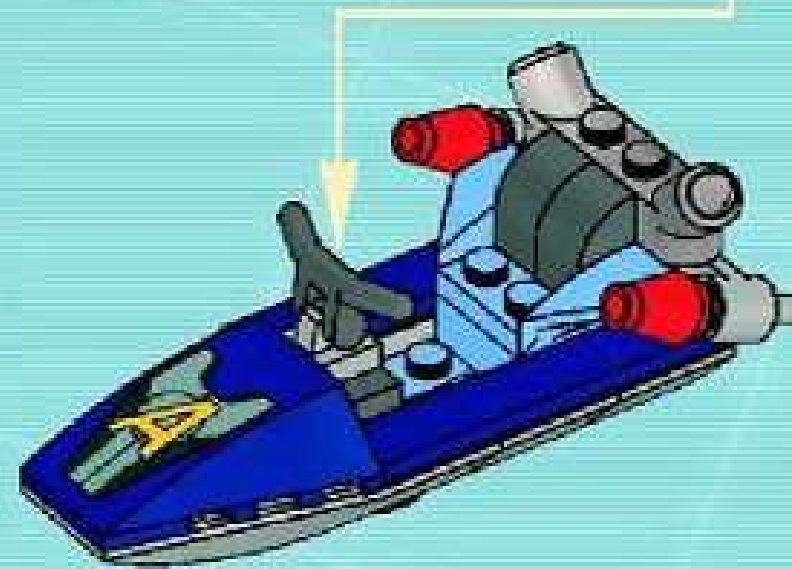
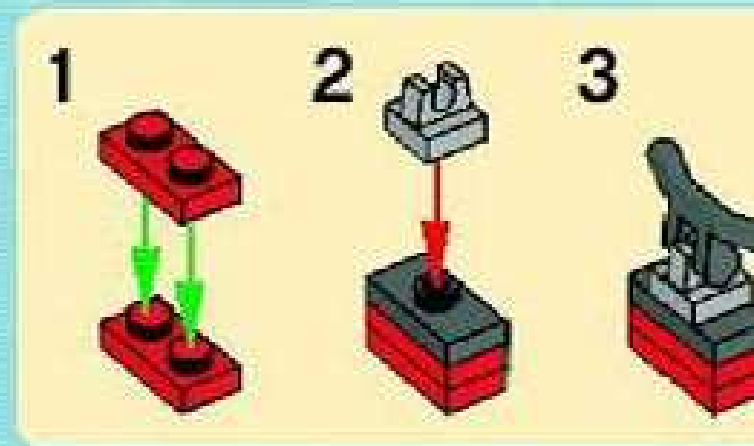



13



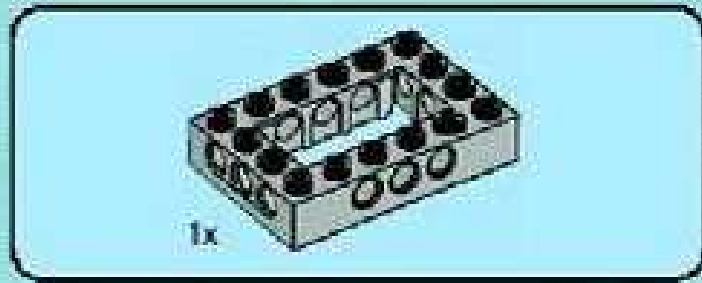

**1**

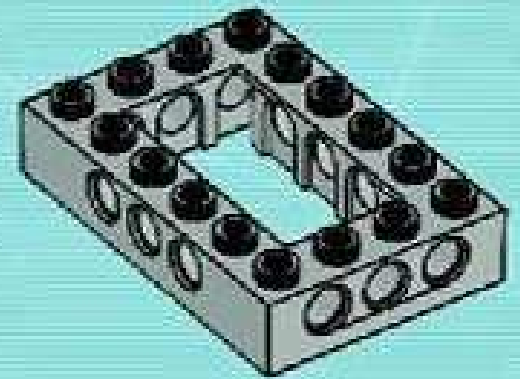

**2**

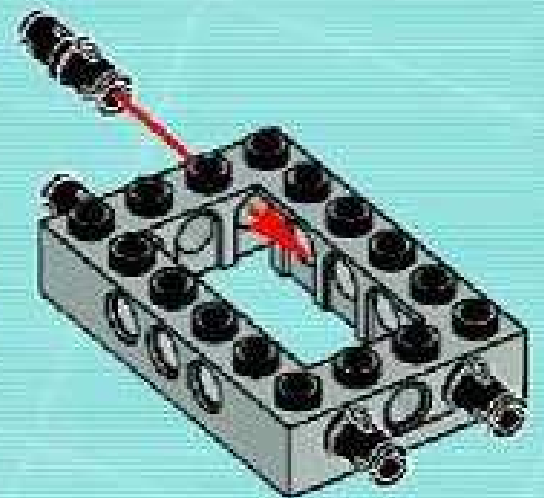



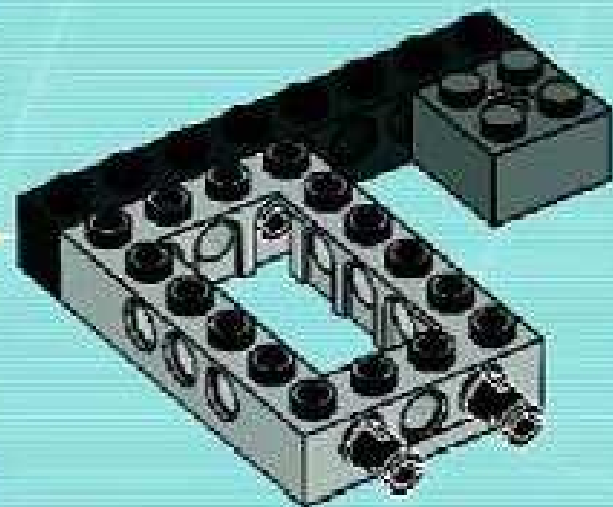
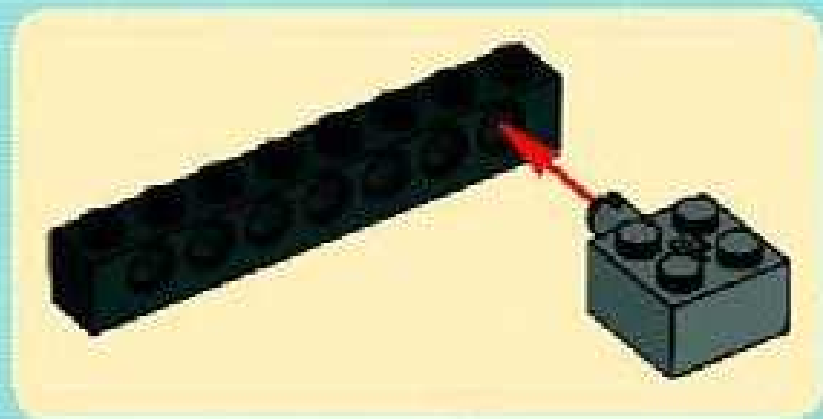
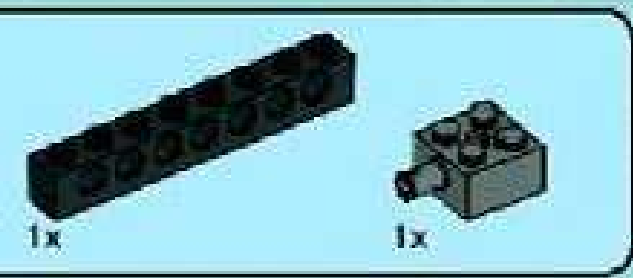

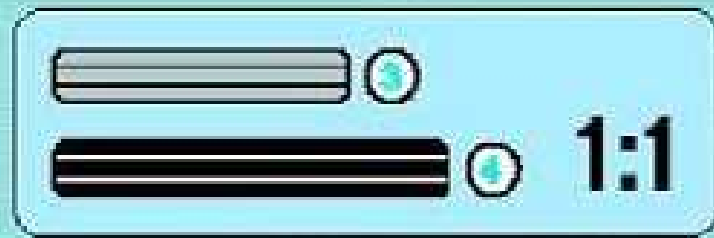

4

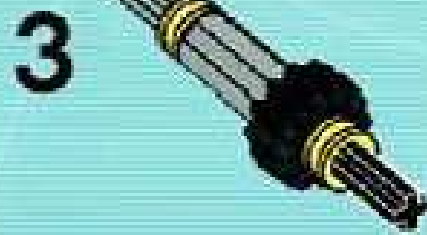
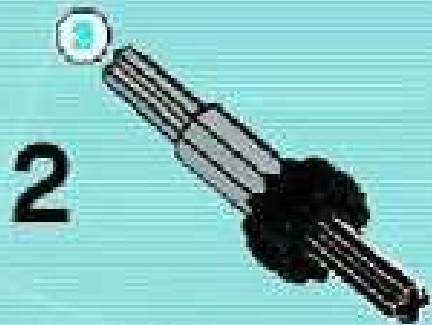
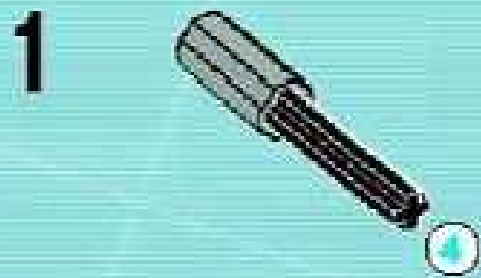

5

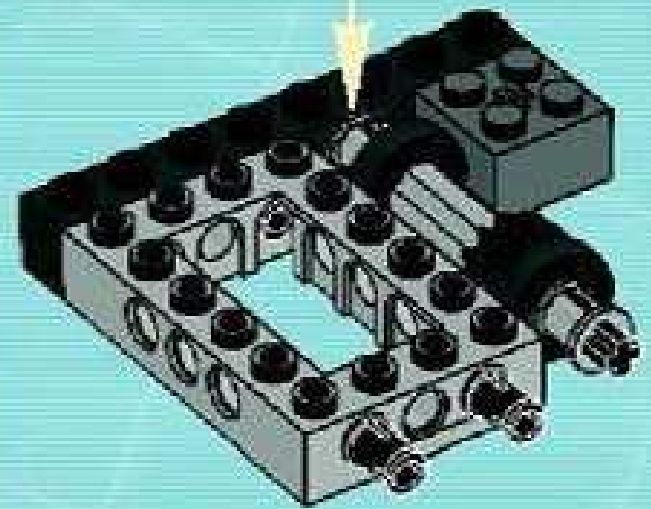
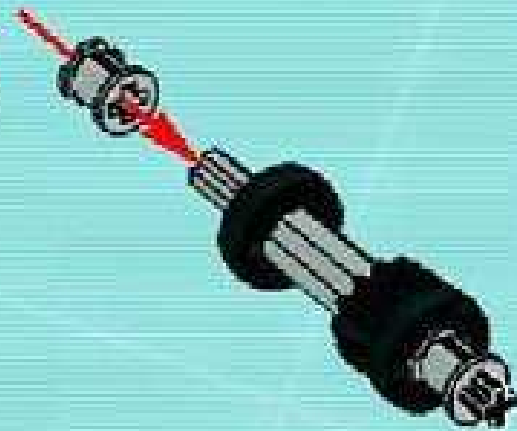

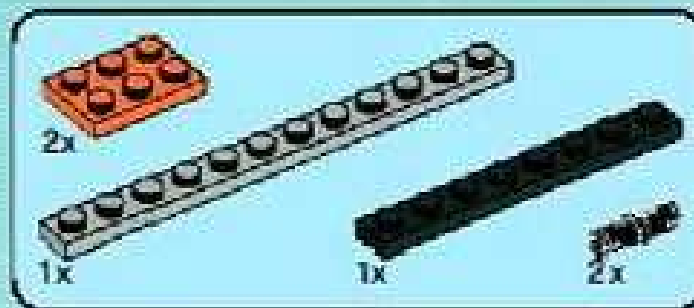
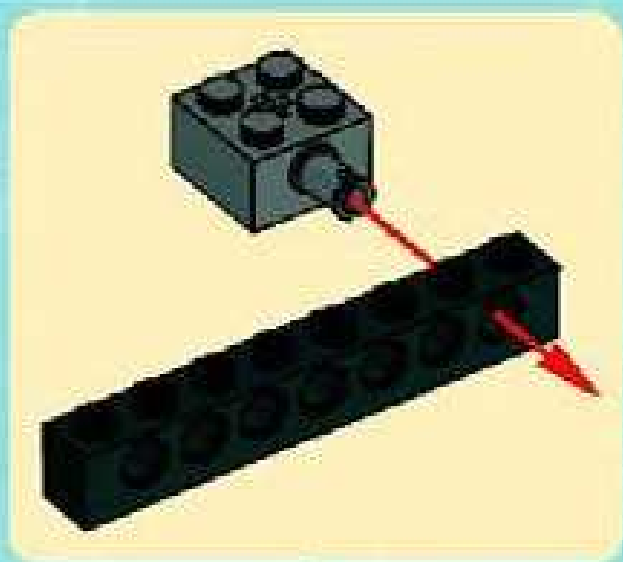
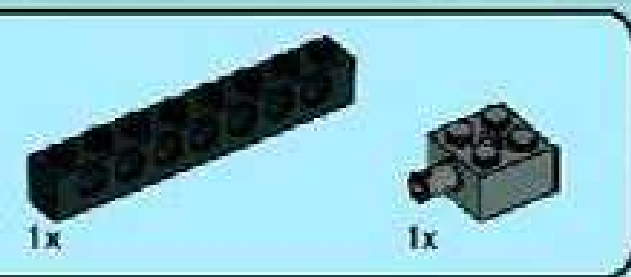

6

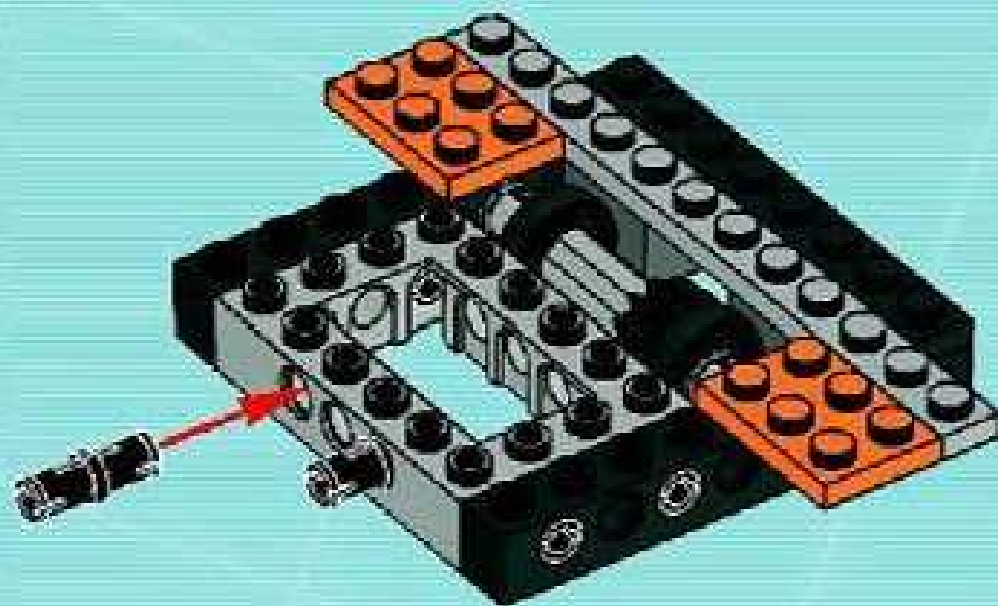



4x

7

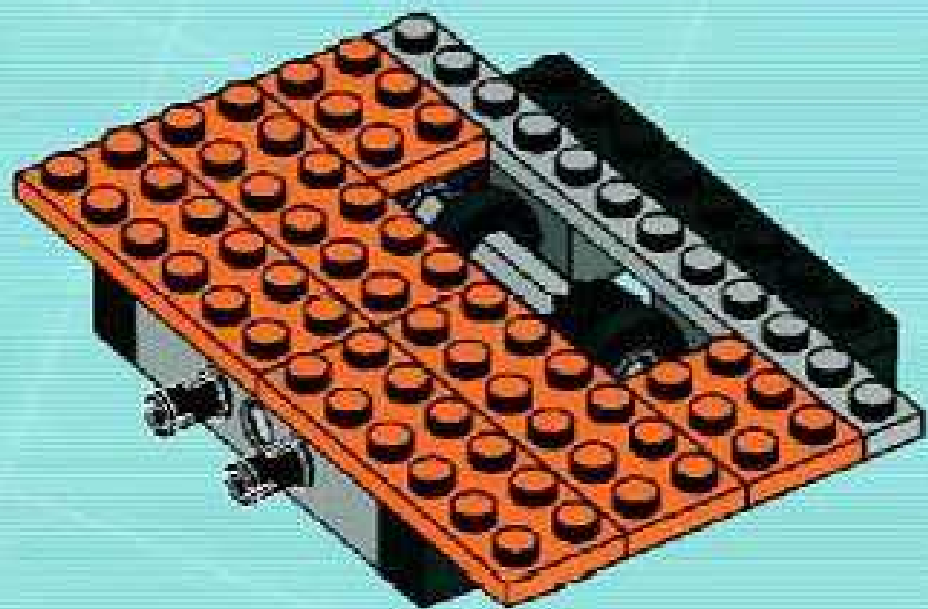

9x

8

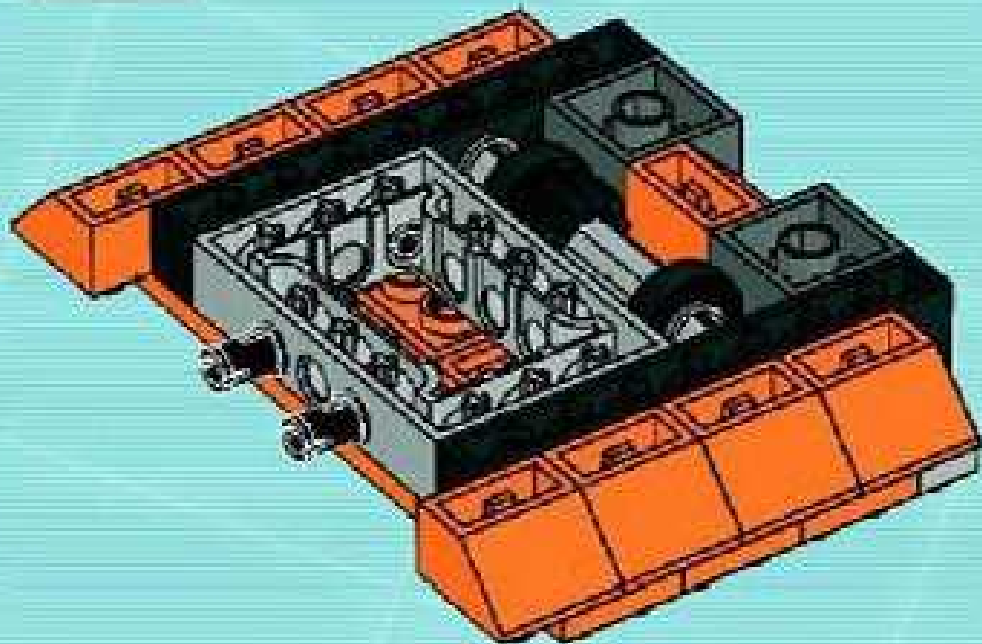



3x



2x



1x



4x

# 10

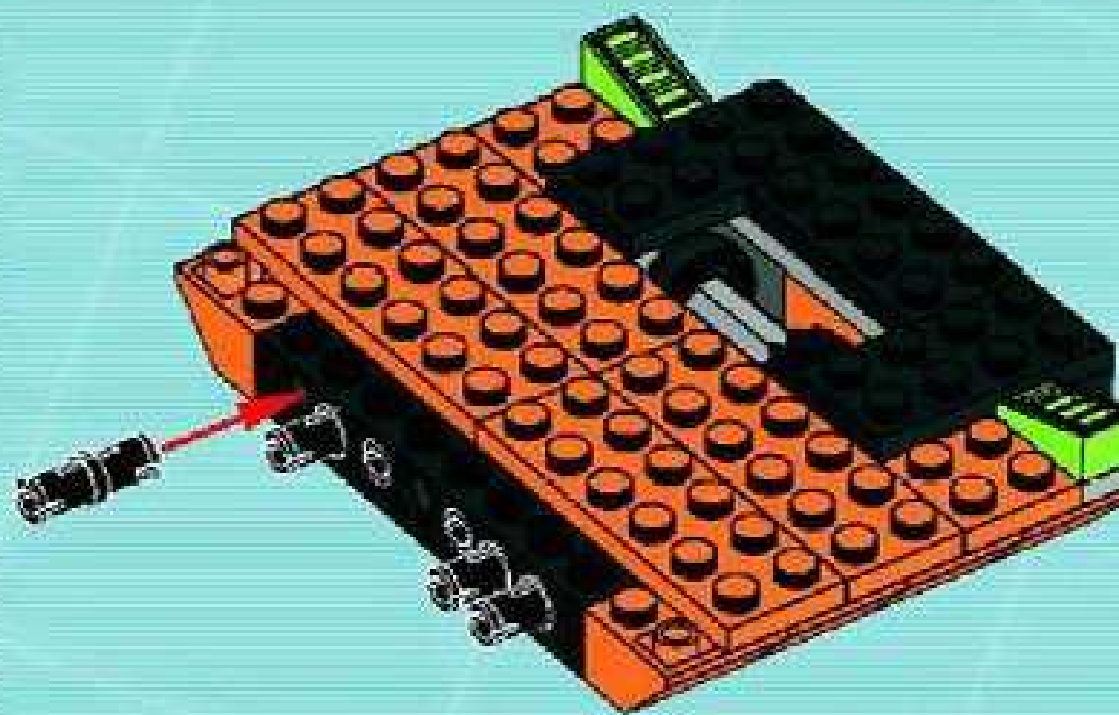
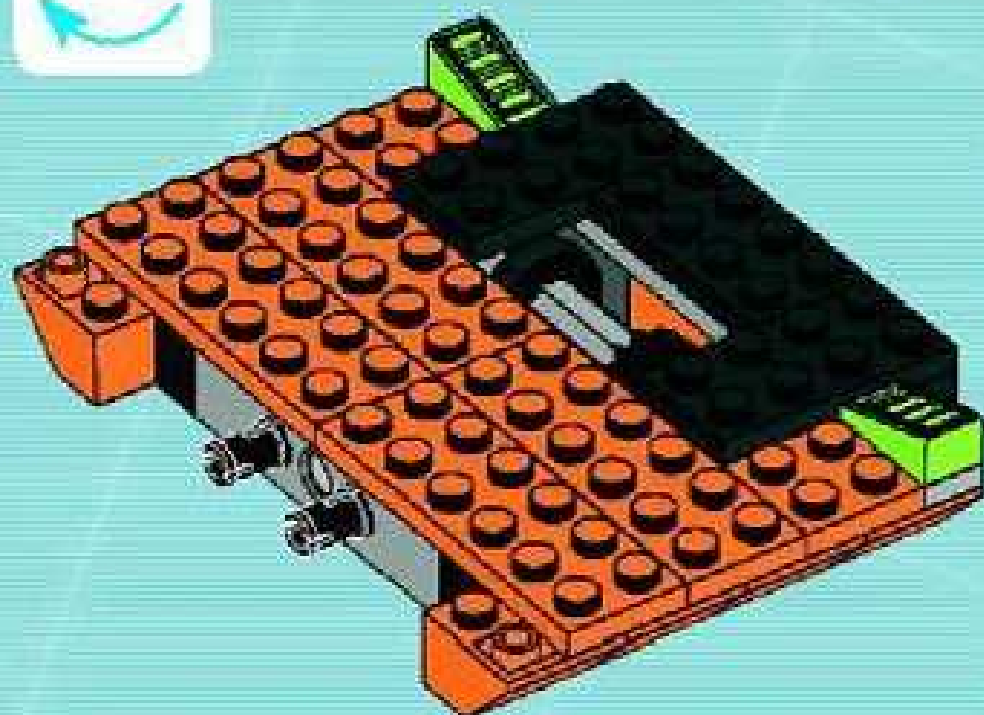

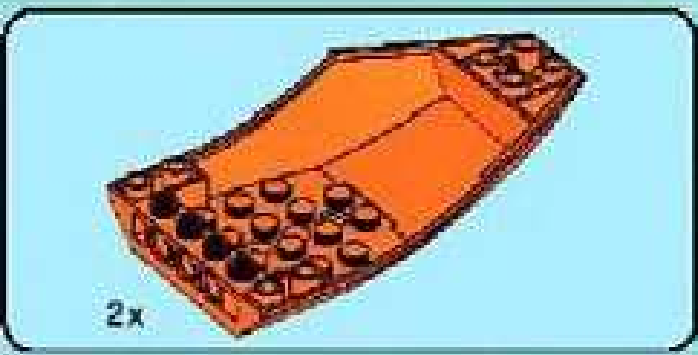

11

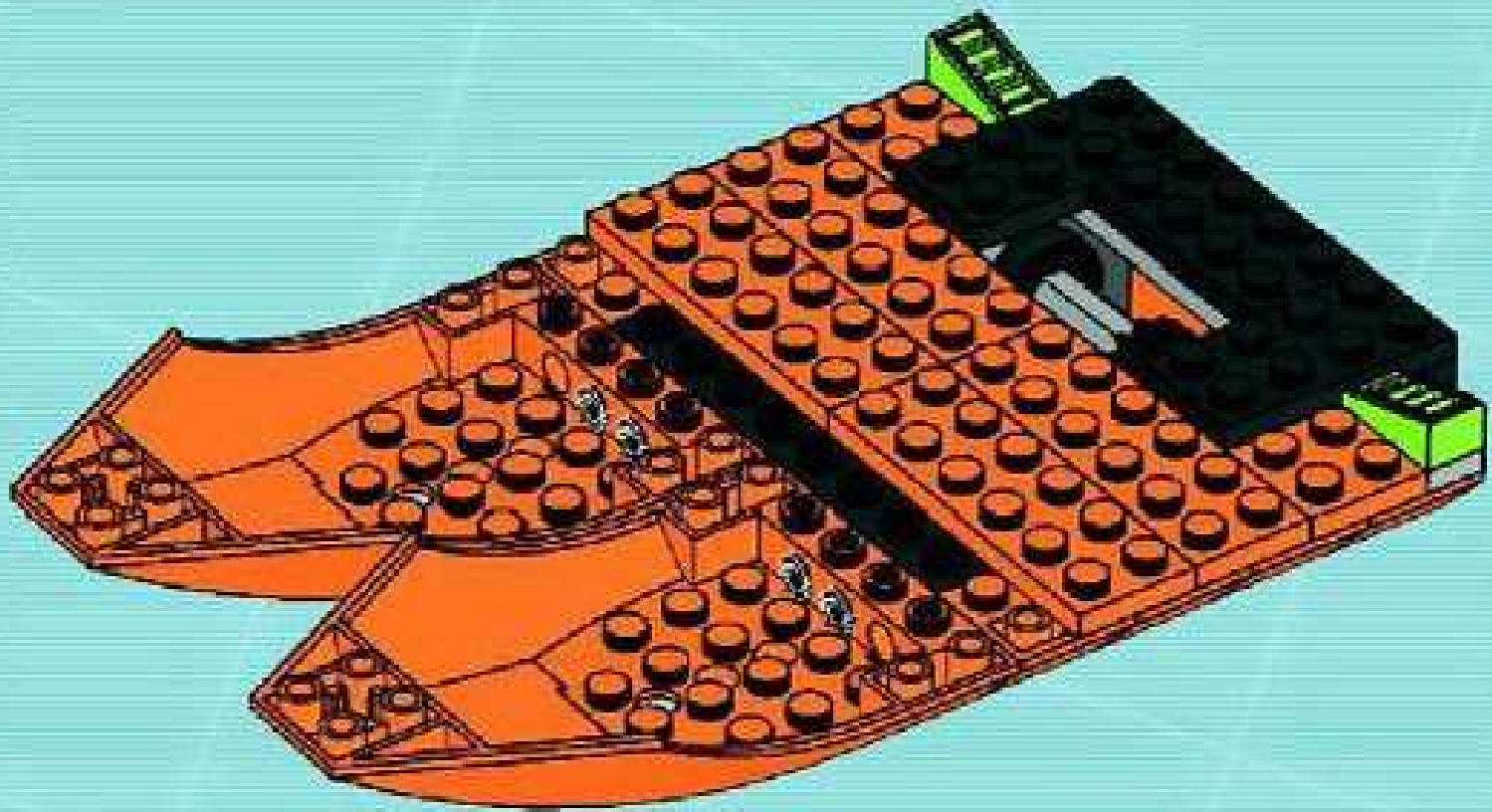

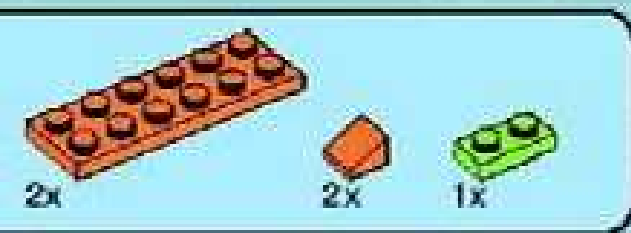

2

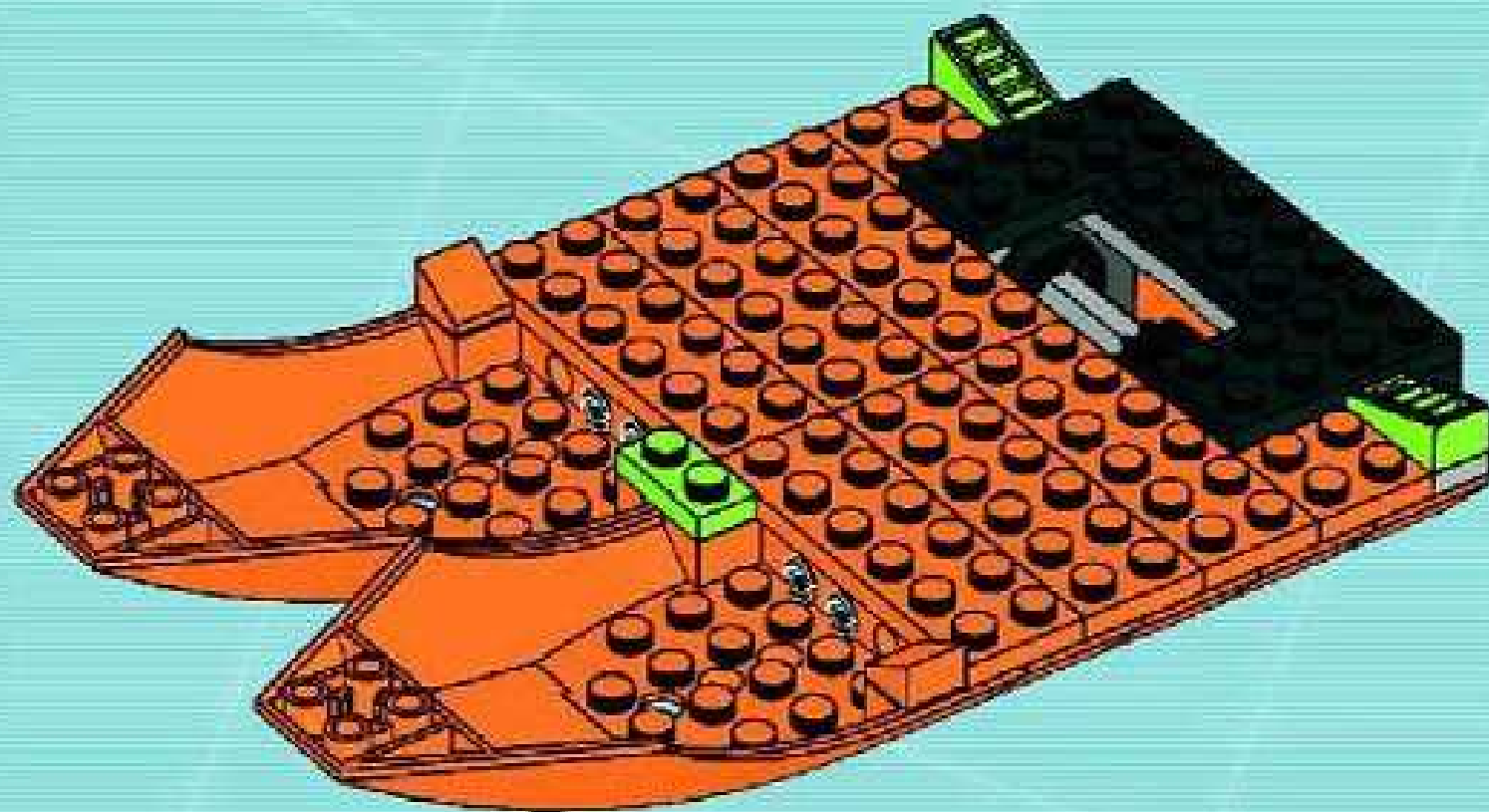



2x

13

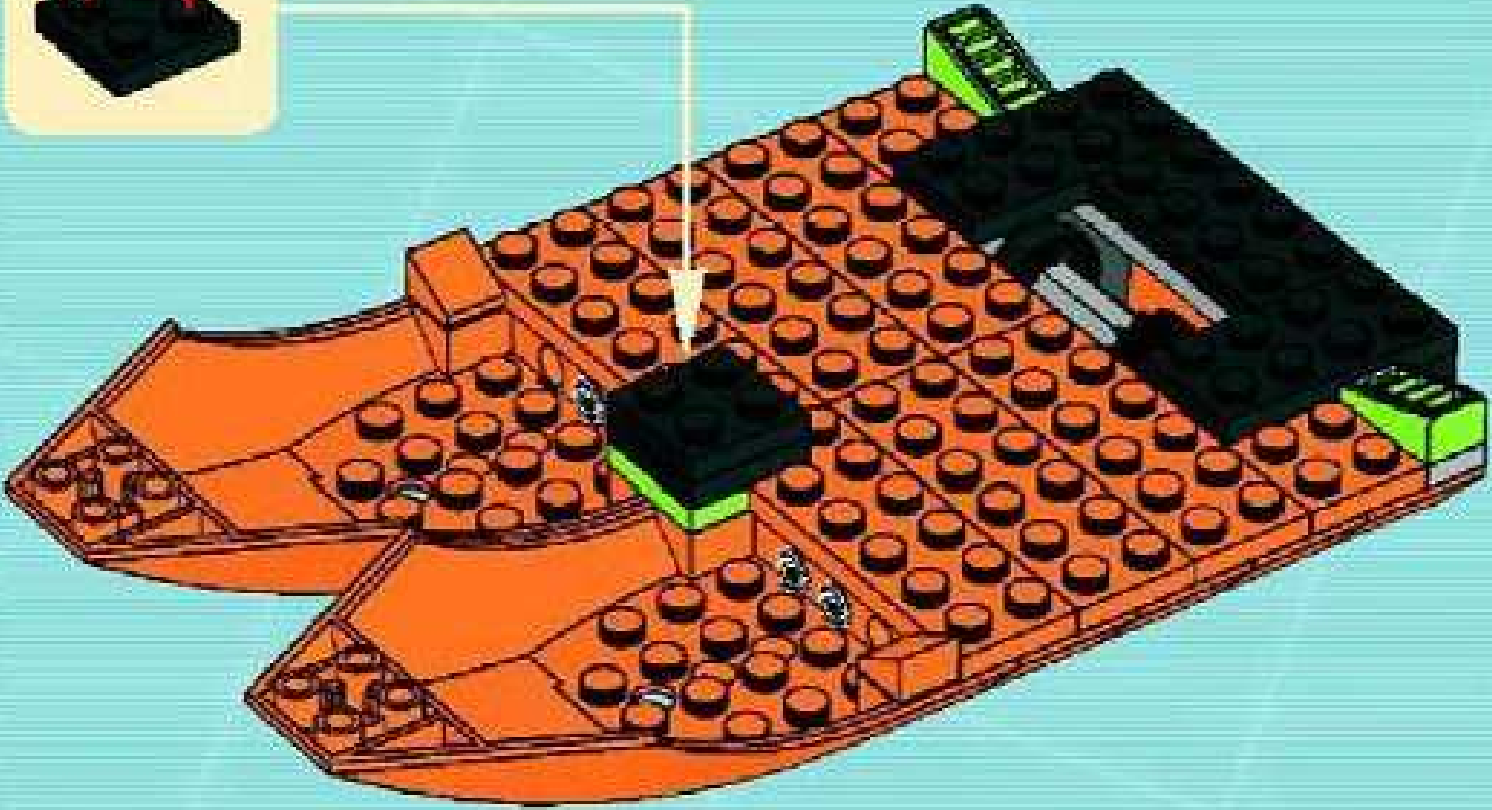





4

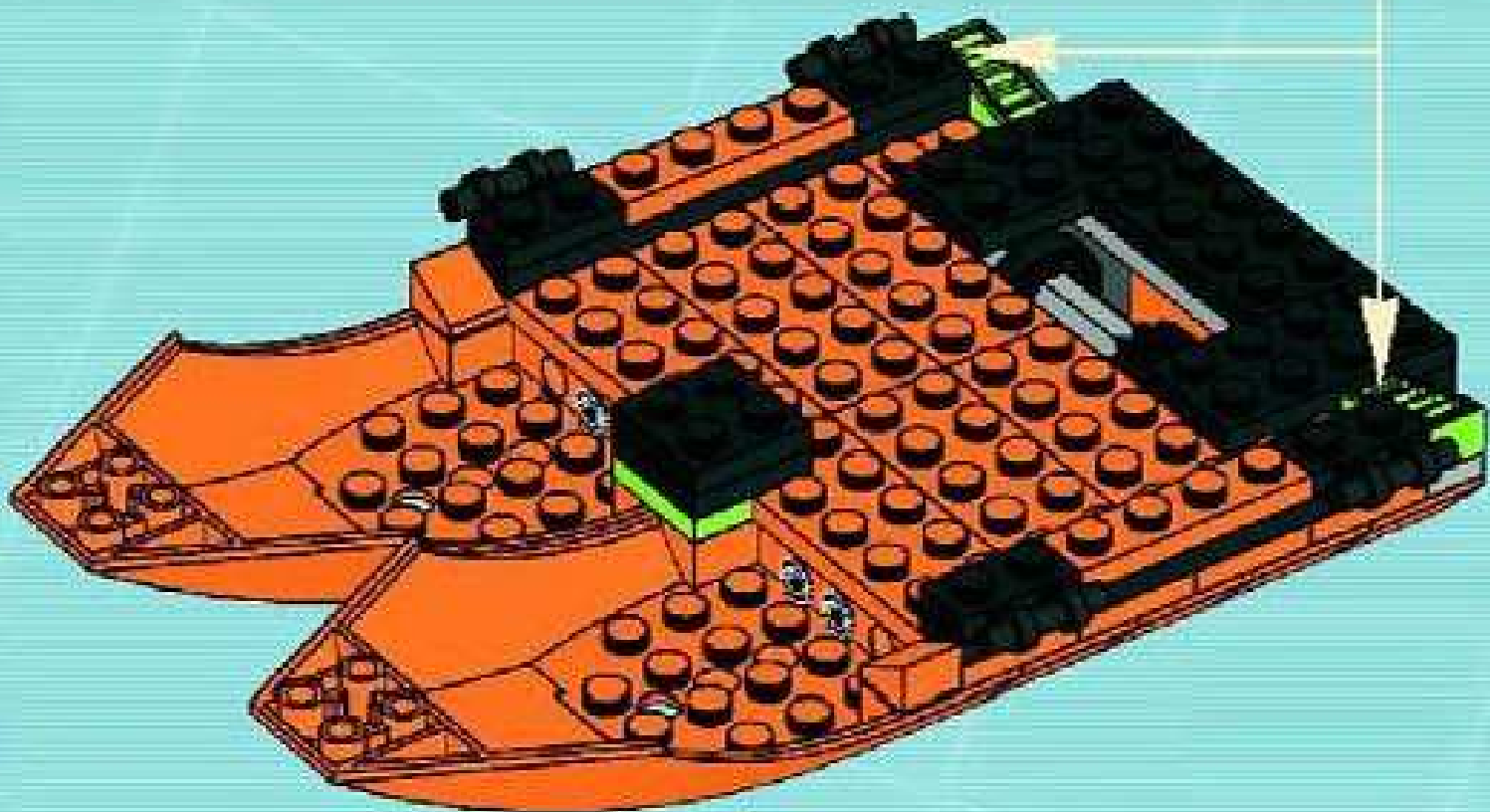
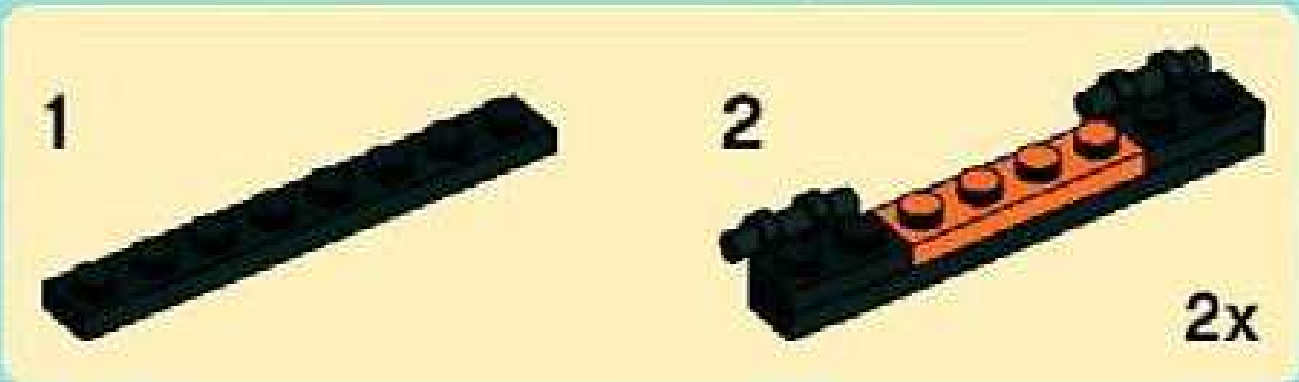



4x

15

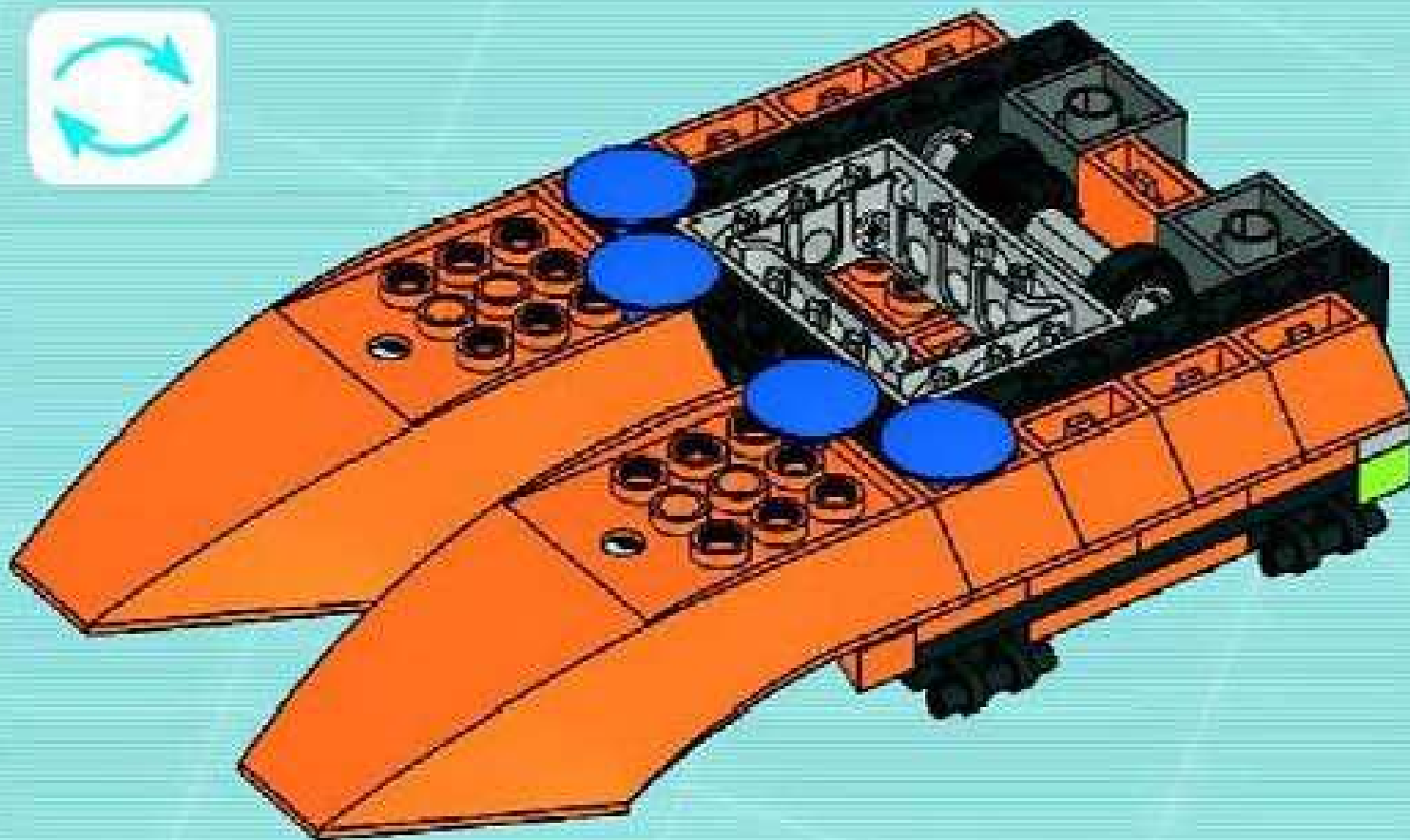

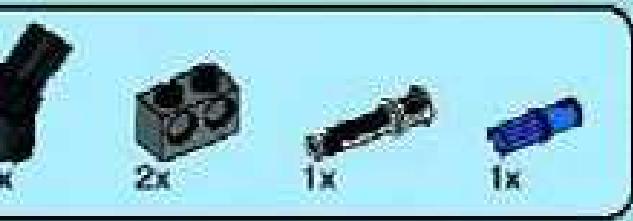

6

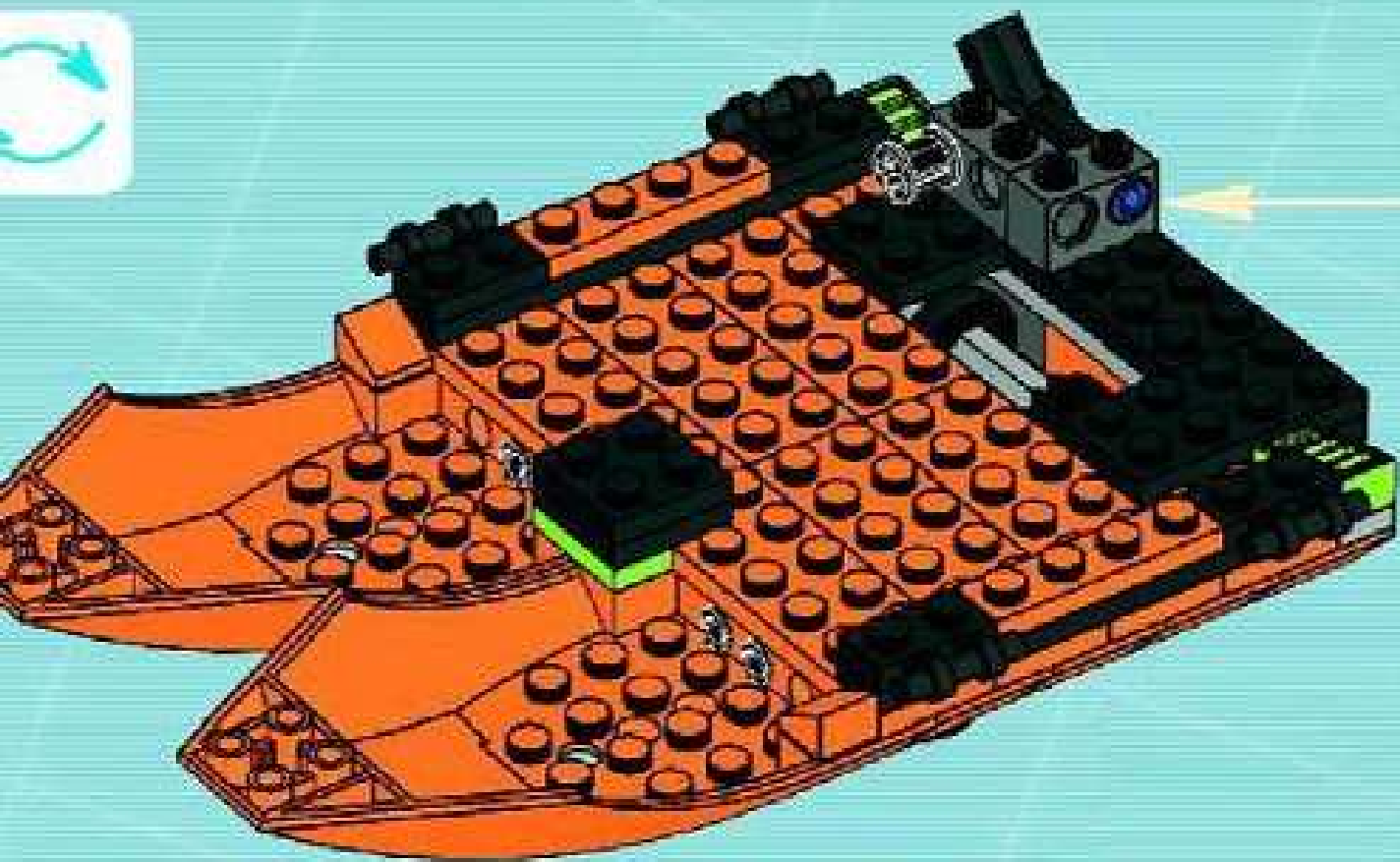
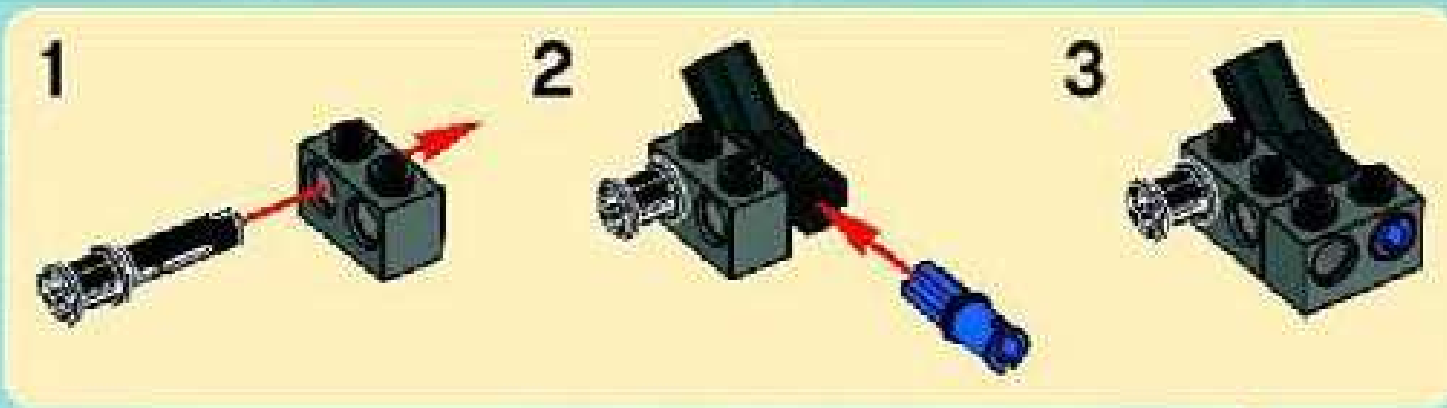



17

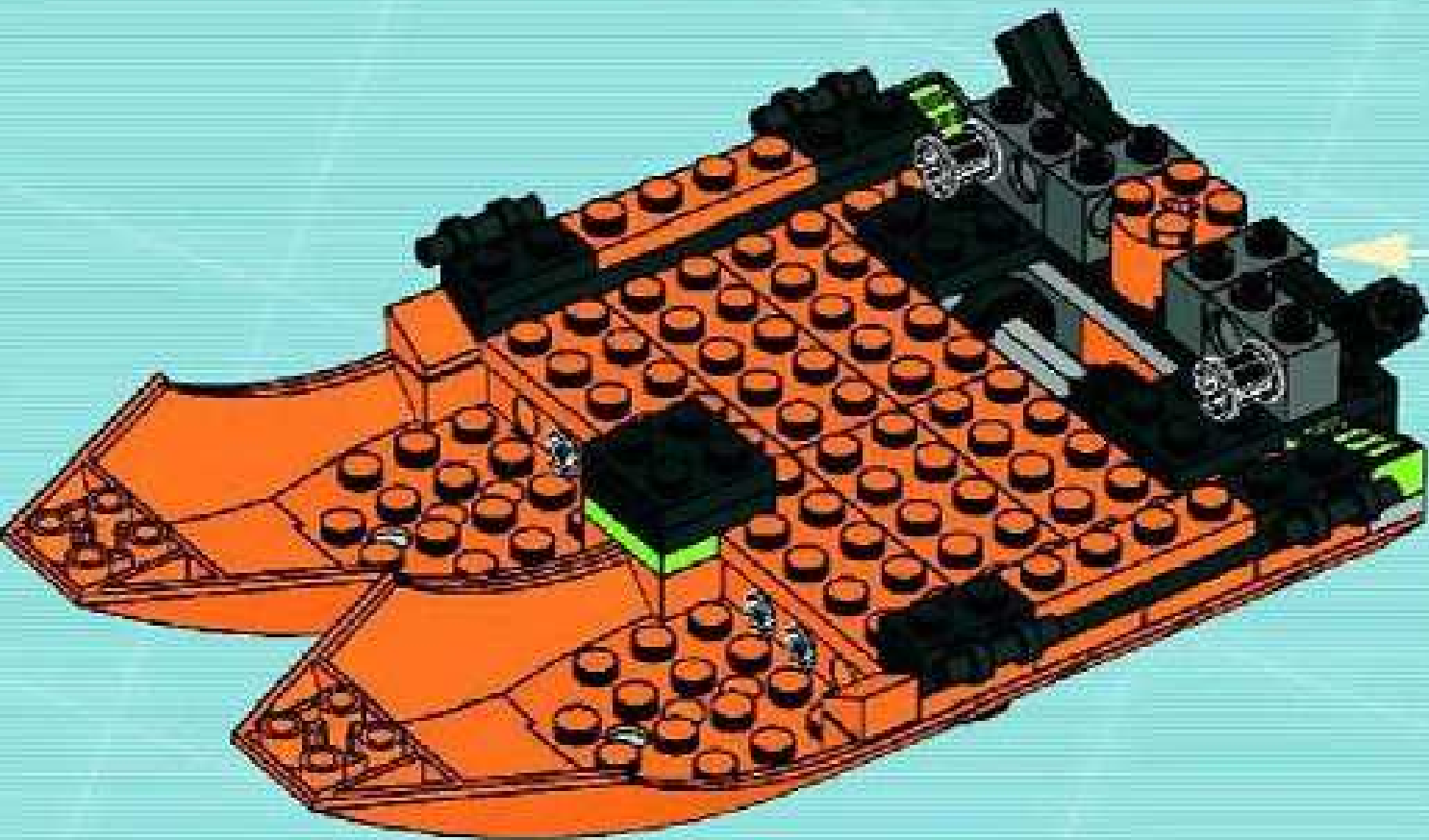
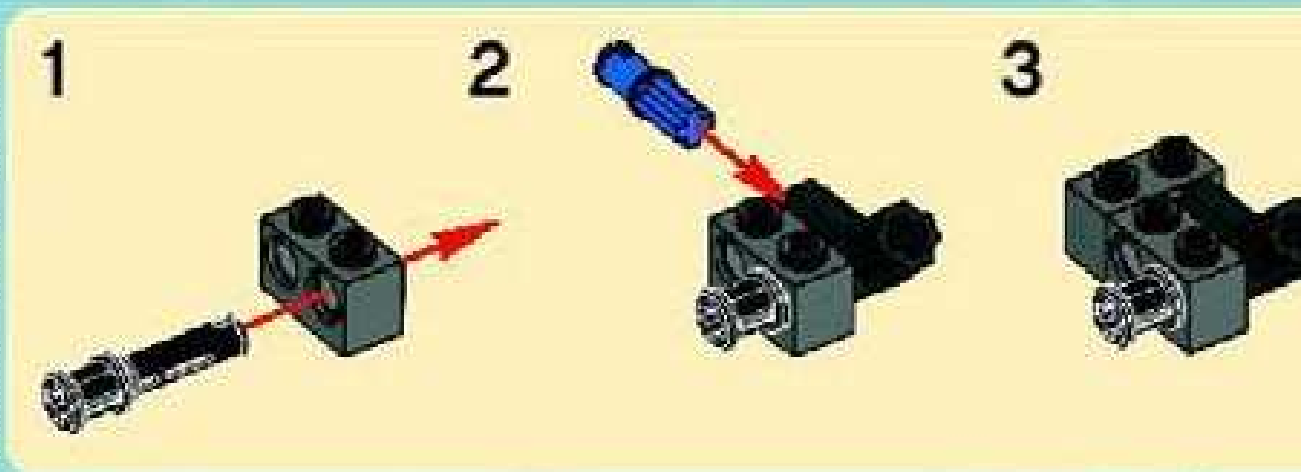



1x



1x

8

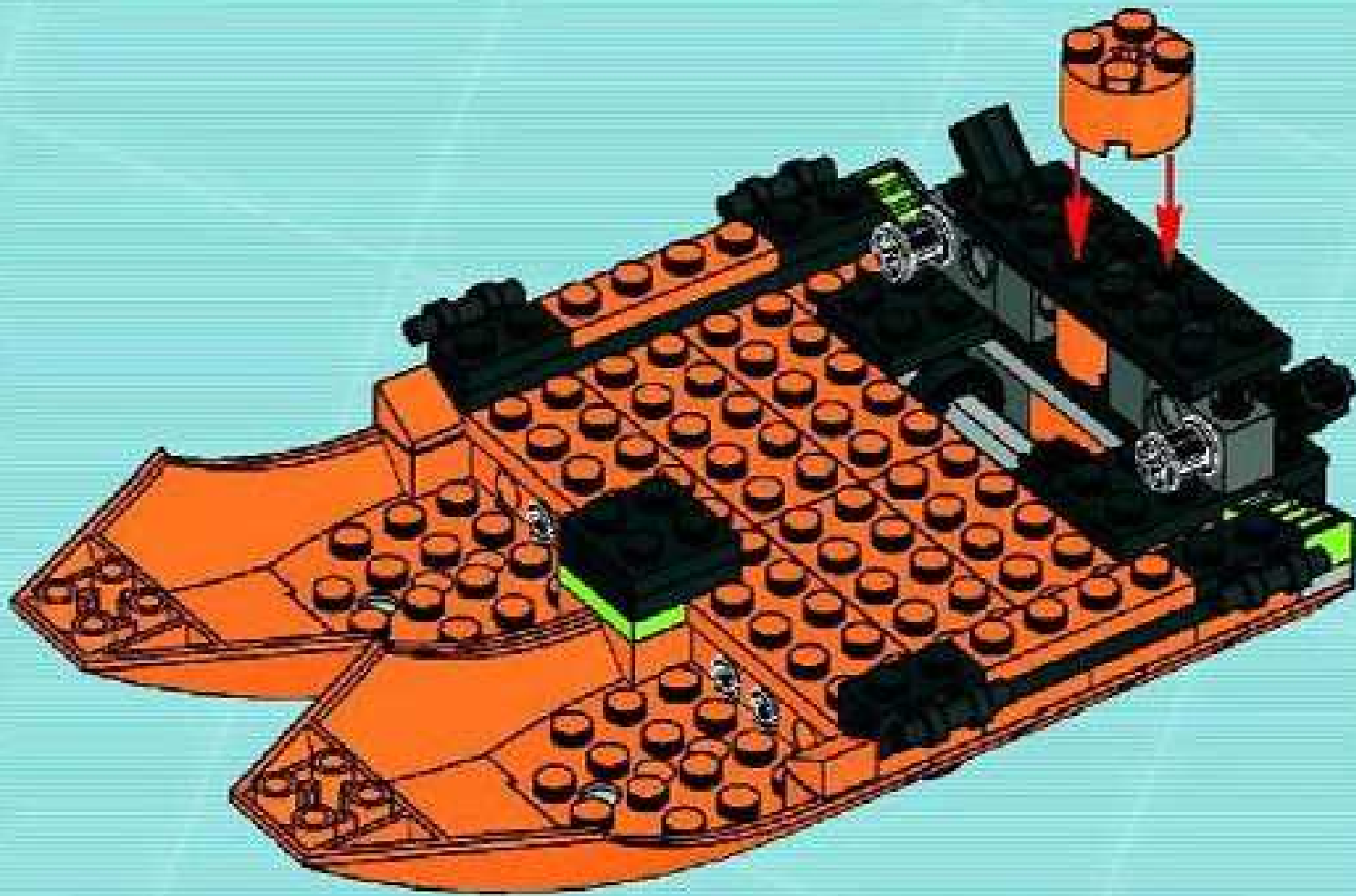

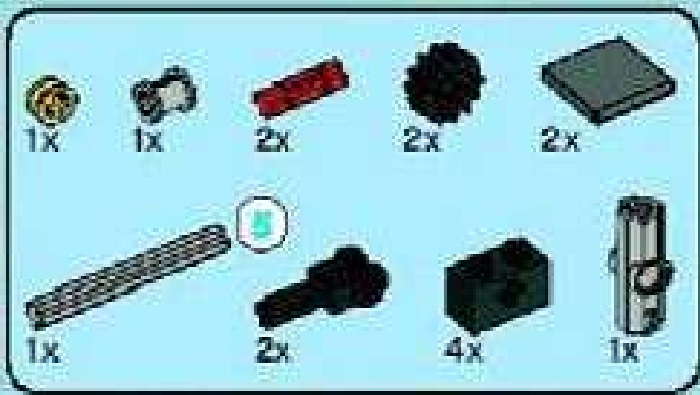

19

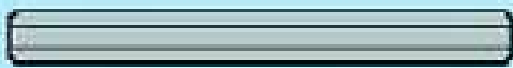

1:1

1

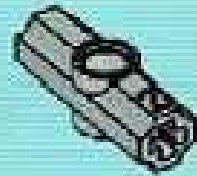

2

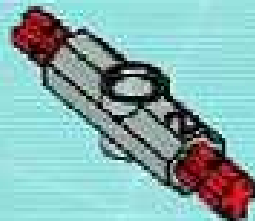

3



4

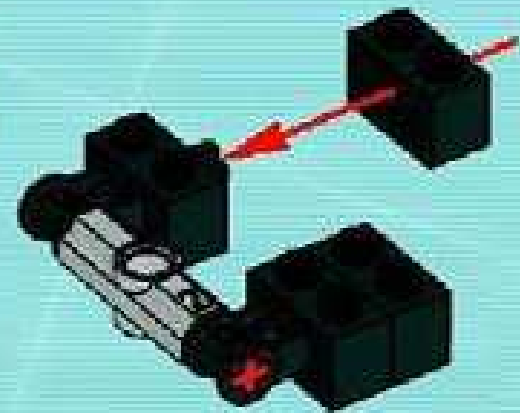

5

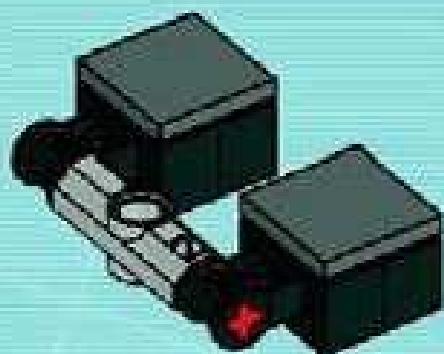

6

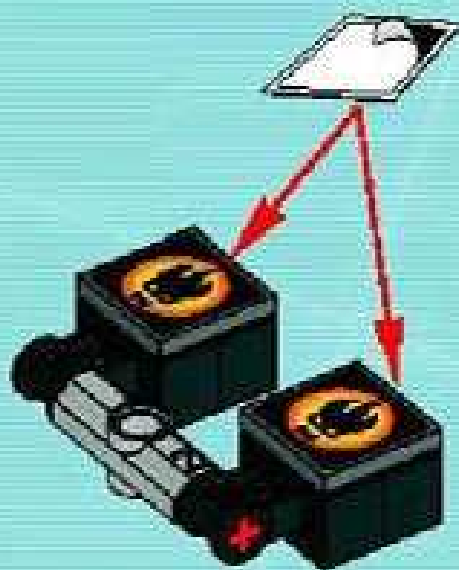

1



2



3



7

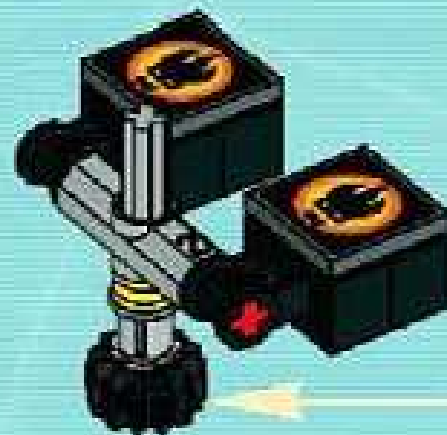

8

