

LEGO

PRINCE OF
PERSIA
THE SANDS OF TIME



7572



**LIGHT UP
BRICK**



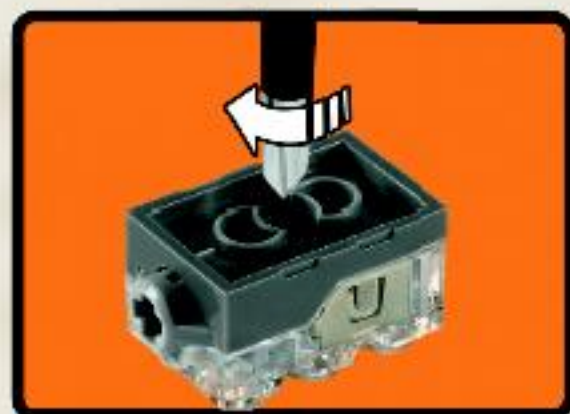
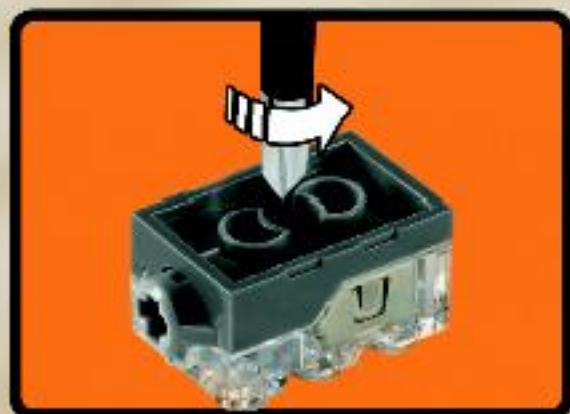
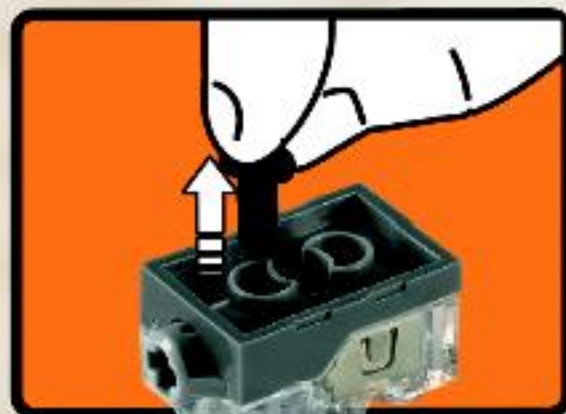

GB

Important information about batteries

Never use different types of batteries together or a combination of old and new batteries. Always remove the batteries if the product is not to be used for a long time or if the batteries have run down. Never use damaged batteries. Only use batteries of the type recommended, or a corresponding type. Insert the batteries so that the poles are correctly positioned. Rechargeable batteries must be recharged using the correct battery charger under the supervision of an adult. You cannot recharge batteries while they are still in the product, and you must never try to do so. Never attempt to recharge non-rechargeable batteries. Never short-circuit the battery holder.

DE

Wichtige Information zu Batterien

Benutzen Sie niemals unterschiedliche Arten von Batterien oder alte und neue gleichzeitig. Nehmen Sie stets alle Batterien heraus, wenn sich das Produkt längere Zeit nicht genutzt wird oder wenn die Batterien leer sind. Verwenden Sie niemals beschädigte Batterien. Verwenden Sie ausschließlich empfohlene bzw. geeignete Batterien. Achten Sie beim Einsetzen der Batterien auf die richtige Polung. Wiederaufladbare Batterien sollten mit einem geeigneten Ladegerät aufgeladen werden – unter der Aufsicht eines Erwachsenen. Batterien können und sollten niemals aufgeladen werden, während sie sich im Produkt befinden. Versuchen Sie unter keinen Umständen, „tote“ Batterien wiederzuladen. Schließen Sie das Batteriefach niemals kurz.

FR

Informations importantes concernant les piles

Ne jamais utiliser un mélange de différents types de piles, ou de piles neuves et de piles anciennes ou déjà utilisées. Toujours retirer les piles si le produit n'est pas utilisé durant une période prolongée ou si les piles sont vides. Ne jamais utiliser de piles endommagées. Utiliser uniquement des piles du type recommandé ou d'un type équivalent. En insérant les piles, respecter scrupuleusement le sens d'orientation des pôles (+/-). Les piles rechargeables doivent être rechargées en utilisant un chargeur de piles adapté et sous la surveillance d'un adulte. Il est impossible de recharger les piles quand elles sont installées dans le produit. Ne jamais tenter de le faire. Ne jamais essayer de recharger des piles non-rechargeables. Ne jamais court-circuiter le compartiment des piles.

IT

Importanti informazioni sulle batterie

Non usare mai contemporaneamente batterie di tipi diversi o batterie nuove e usate insieme. Rimuovere sempre le batterie qualora il prodotto non venga utilizzato per periodi prolungati, oppure se le batterie sono esauste. Non utilizzare mai batterie danneggiate. Usare esclusivamente batterie del tipo raccomandato o un equivalente. Inserire le batterie avendo cura che la loro polarità sia corretta. Le batterie ricaricabili vanno ricaricate in un caricabatterie di tipo idoneo e con la supervisione di un adulto. Non è possibile e non bisogna mai tentare di ricaricare le batterie mentre queste sono inserite nel prodotto. Non tentare mai di ricaricare le batterie non ricaricabili. Non cortocircuolare mai il perno/batteria.

NL

Belangrijke informatie over batterijen

Gebruik nooit verschillende soorten of nieuwe en oude batterijen tegelijkertijd. Verwijder de batterijen altijd als je het product lange tijd niet wilt gebruiken of als de batterijen leeg zijn. Nooit beschadigde batterijen gebruiken. Uitsluitend batterijen van het aanbevolen of overeenkomstige type gebruiken. Leg de batterijen met de polen in de juiste richting. Oplaadbare batterijen moeten in een voor dit doel bestemde oplader en onder toezicht van een volwassene opnieuw worden opgeladen. Oplaadbare batterijen kunnen niet in het product worden opgeladen en je mag dit ook niet proberen te doen. Probeer nooit niet-oplaadbare batterijen op te laden. Nooit de batterijhouder kortsluiten.

ES

Importante información sobre las baterías

No mezclar nunca diferentes tipos de baterías, ni utilizar baterías antiguas y nuevas a la vez. Sacar siempre las baterías, si el producto no se utiliza por un largo período de tiempo o si las baterías están agotadas. No utilizar nunca baterías dañadas. Utilizar solo el tipo de baterías recomendado o una correspondiente. Colocar las baterías de manera que los polos estén en su posición correcta. Las baterías recargables deben cargarse con un cargador adecuado bajo la supervisión de un adulto. Las baterías no pueden, ni deben recargarse mientras permanezcan en el producto. No intentar nunca recargar baterías no recargables. Asegurarse que no se produzcan un cortocircuito en el porta-baterías.

DA

Vigtig information om batterier

Brug aldrig forskellige typer batterier sammen, eller nye og gamle batterier samtidig. Tag altid batterierne ud, hvis du ikke skal bruge produktet i længere tid, eller hvis batterierne er brugt op. Anvend aldrig beskadigede batterier. Der må kun anvendes batterier af samme eller tilsvarende type som anbefales. Batterierne skal vendes rigtigt når de i sættes. Genopladelige batterier skal oplades i en dertil beregnet oplader under opsyn af en voksen. Genopladelige batterier kan og må ikke forsøges oplades i produktet. Forsøg aldrig at genoplade ikke-genopladelige batterier. Kortslut aldrig batterifakten med kontaktflader.

FI

Tärkeää tietoa paristoista

Älä koskaan käytä erilyyppisiä paristoja yhdessä. Älä myöskään käytä vanhoja litteitä tai vanhoja otokkeita uusia paristoja. Poista paristot tuotteenosta aina, kun se on pitkäaikaista aikaa idettyttävissä, tai kun paristot ovat tyhjäkappaleet. Älä koskaan käytä viallisia paristoja. Käytä vain tuotteen valmistaja/ja tai valmistusyrityksellä paristoja. Aseta paristot oikea, otokke vastakkain otokkeiden suuntaan. Ladattavat paristot on ladattava oikealla tavalla erillisessä laturissa. Älä koskaan yritä ladata paristoja, jotka ei ole tarkoitettu ladattaviksi. Älä koskaan yritä ladata erillisiä paristoja kontaktin vastassa.

1

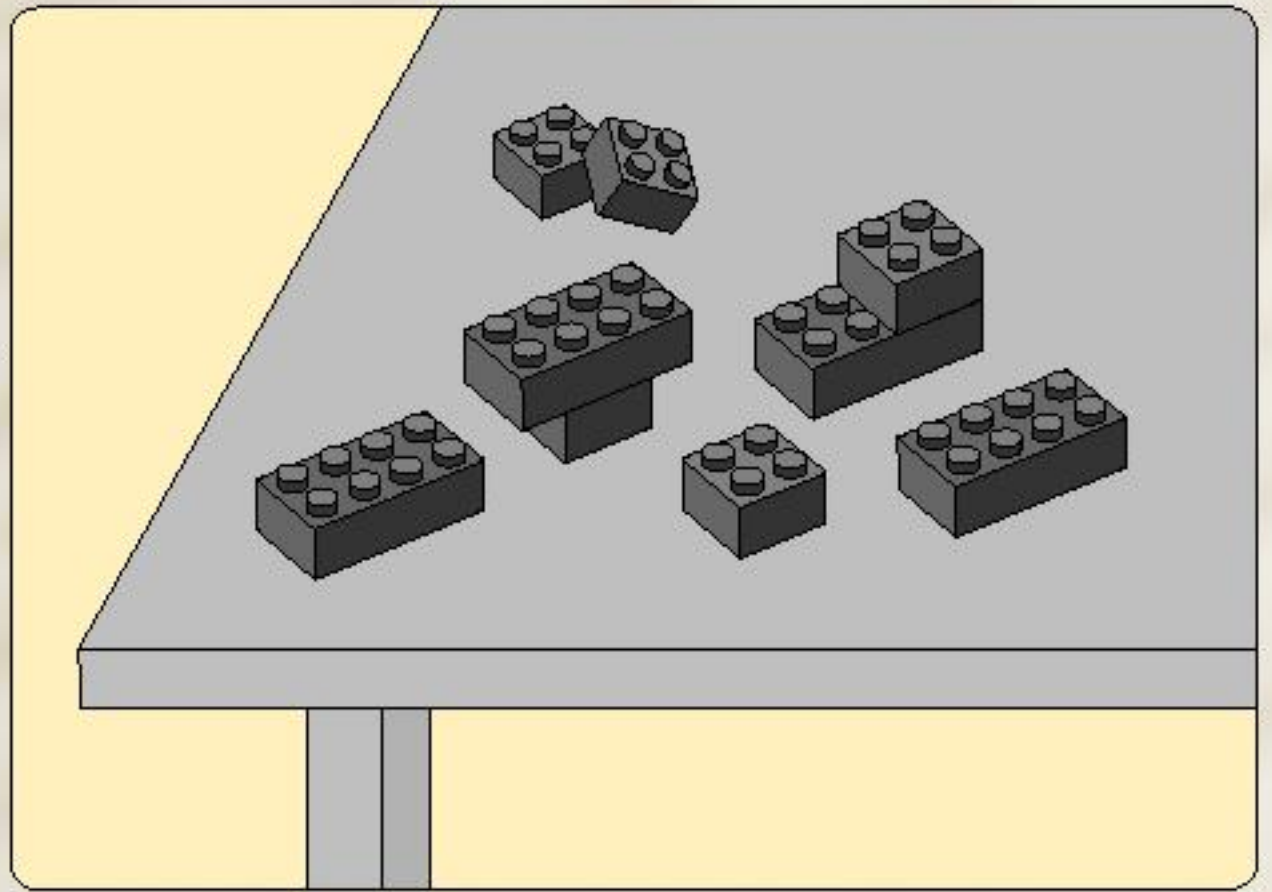
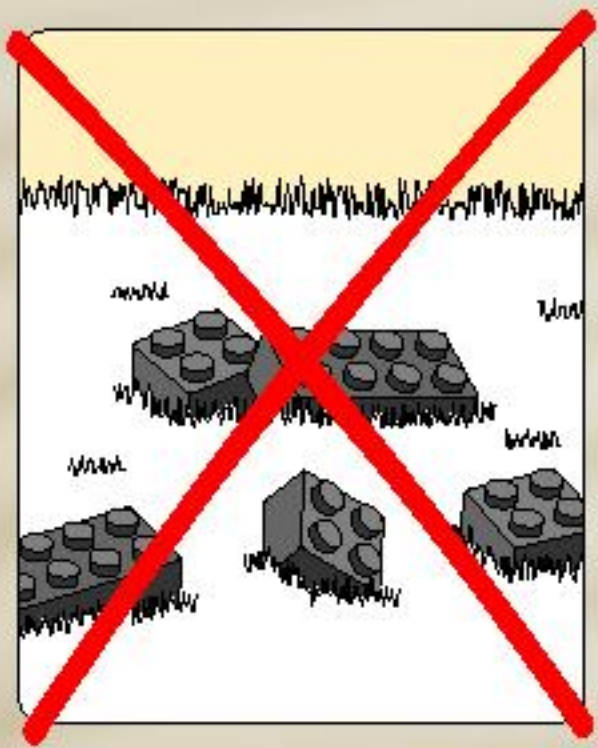

2



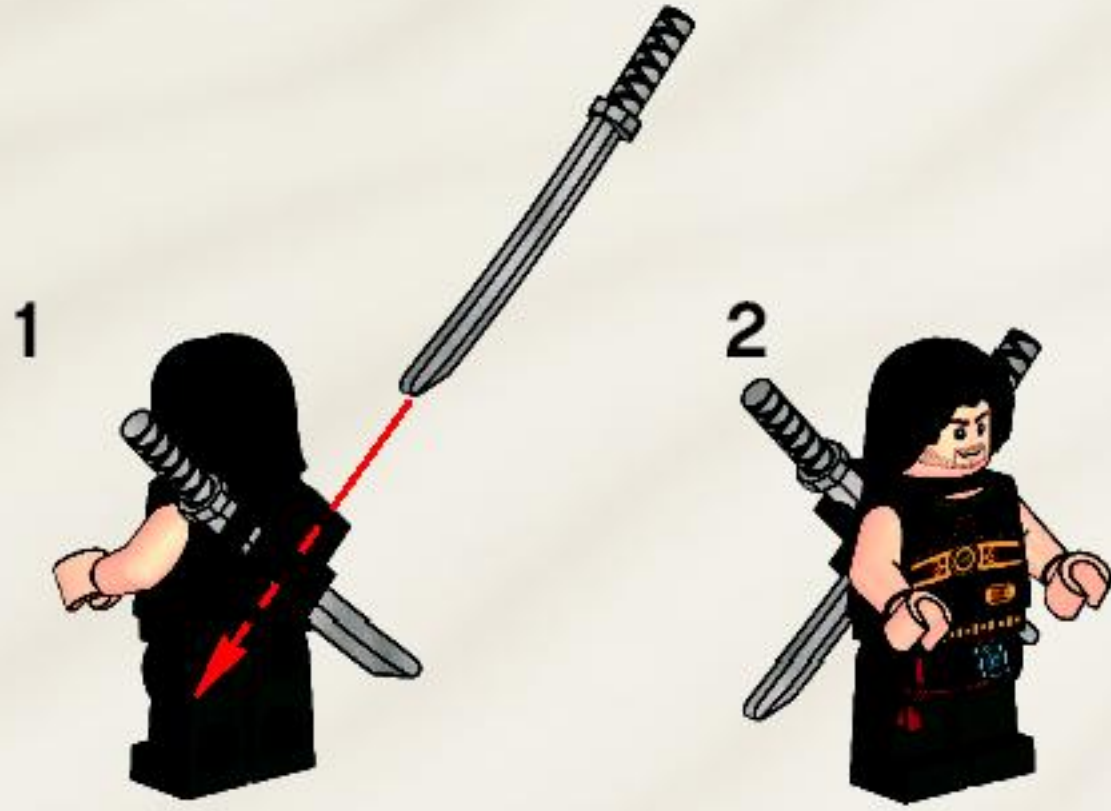
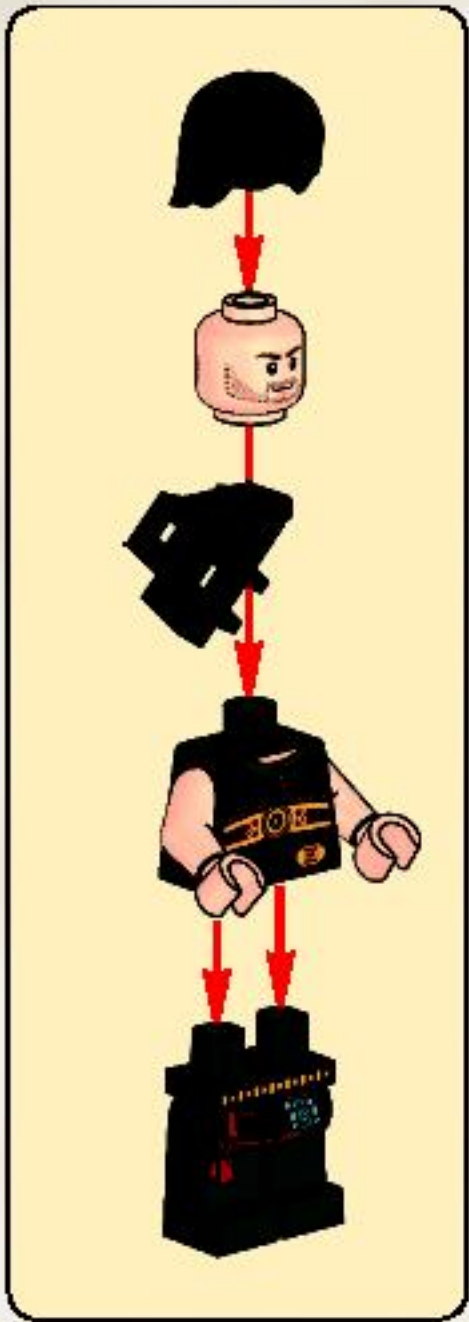
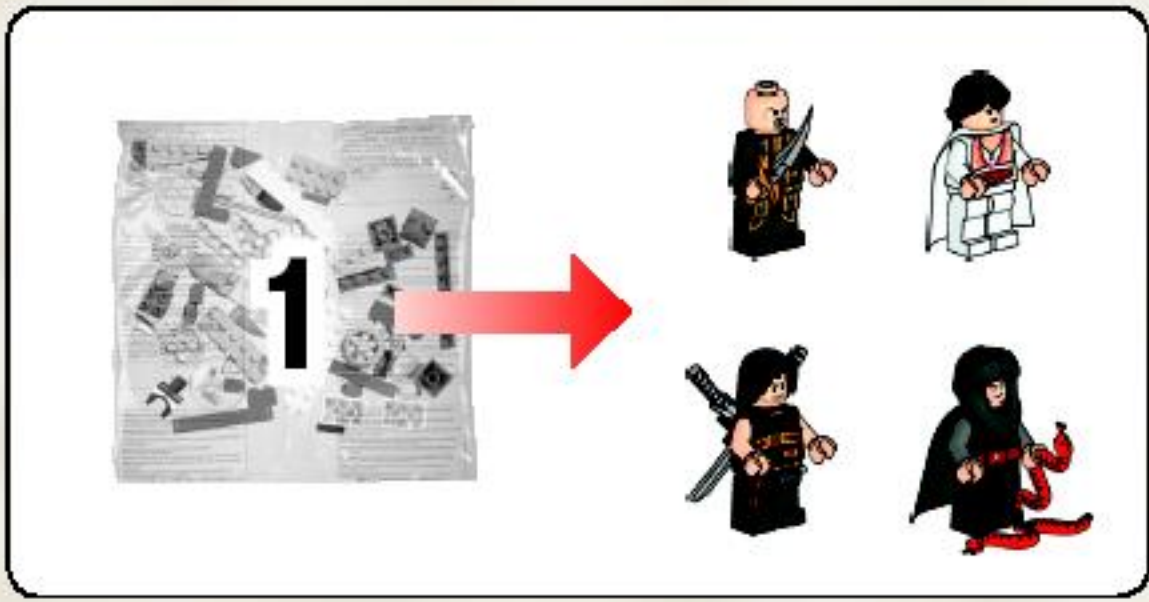

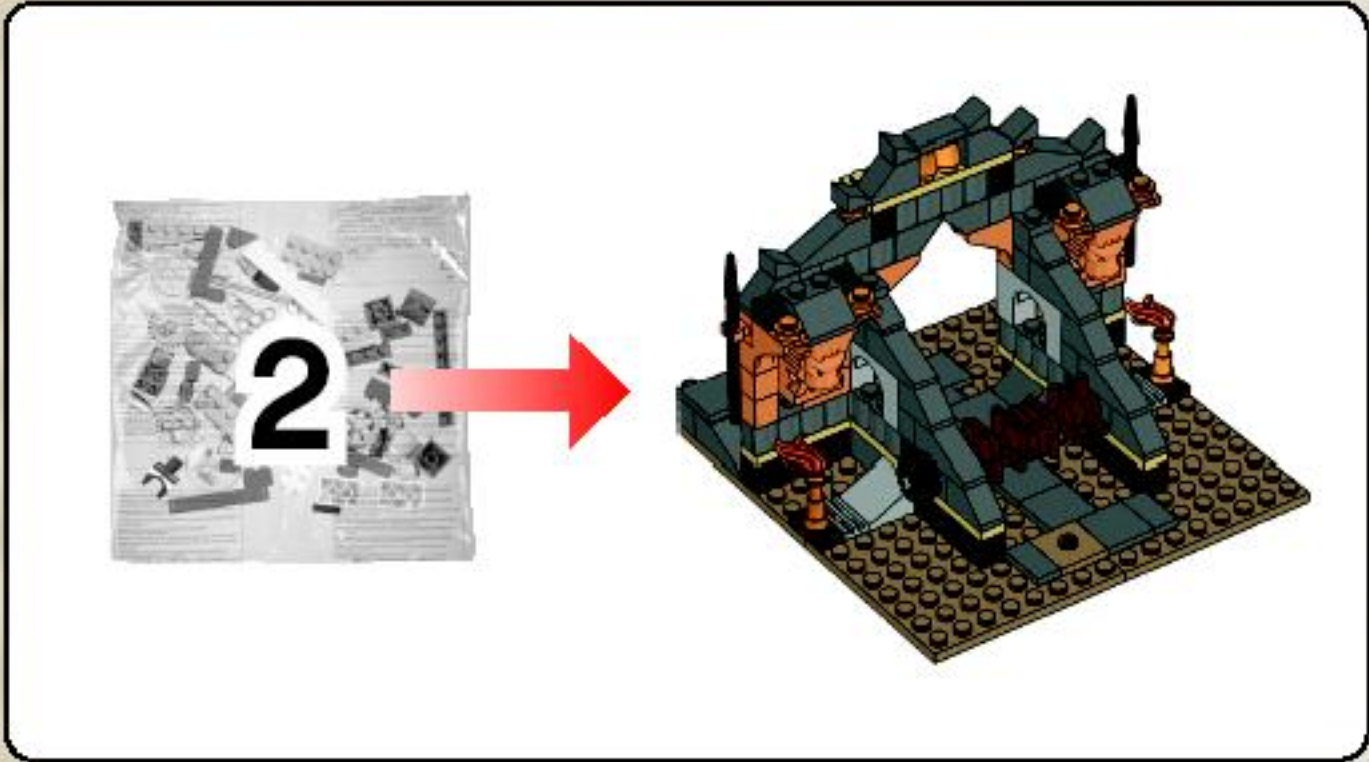

1

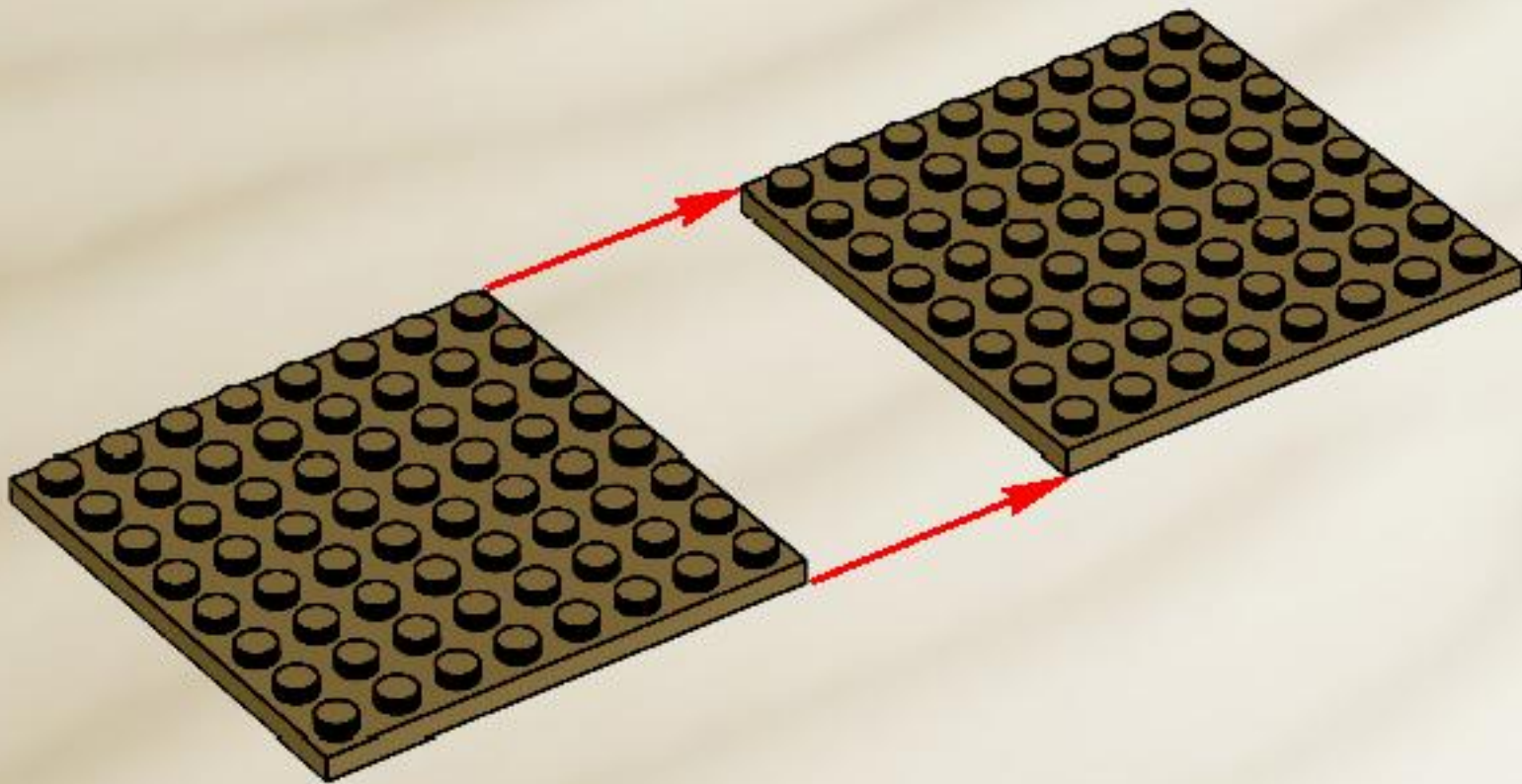

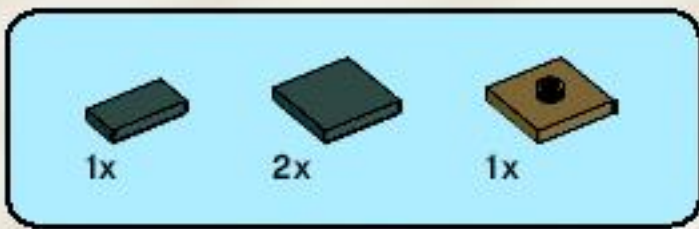

2

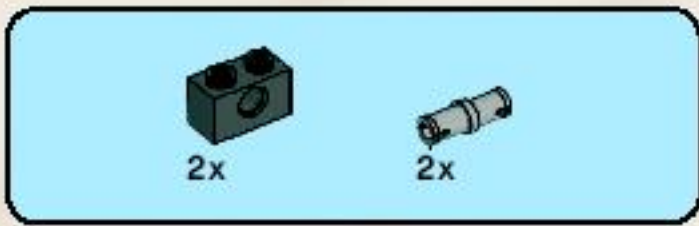
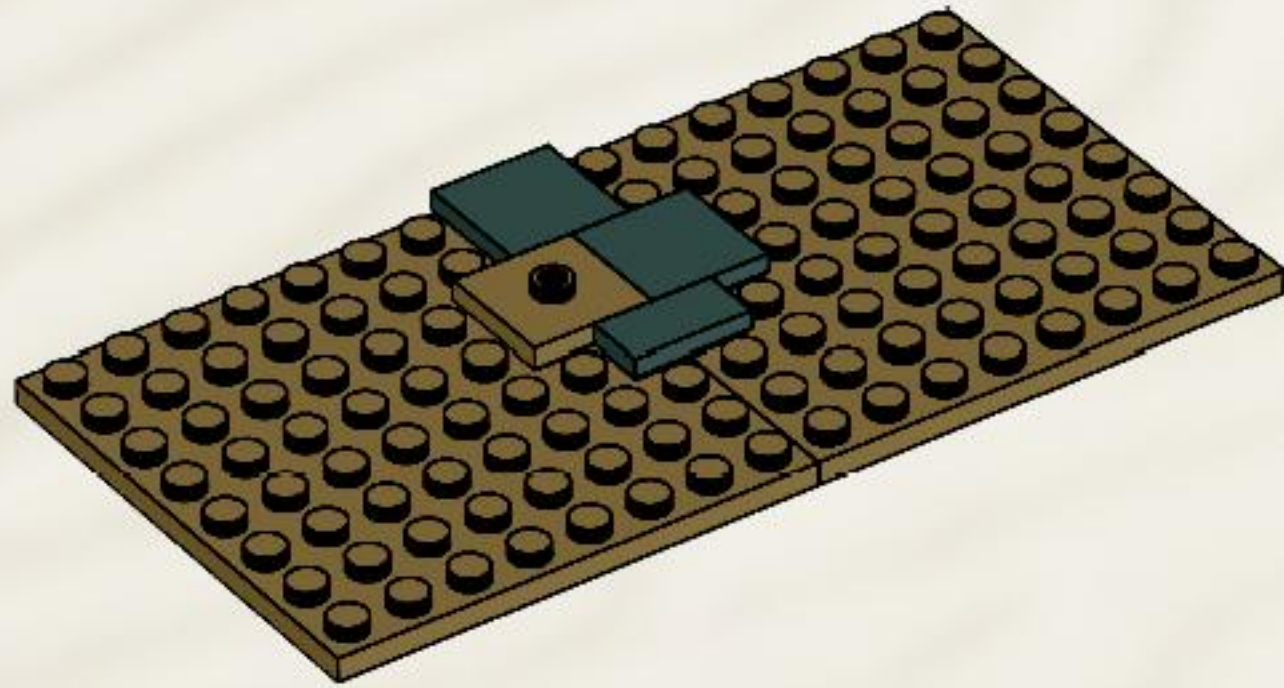

3

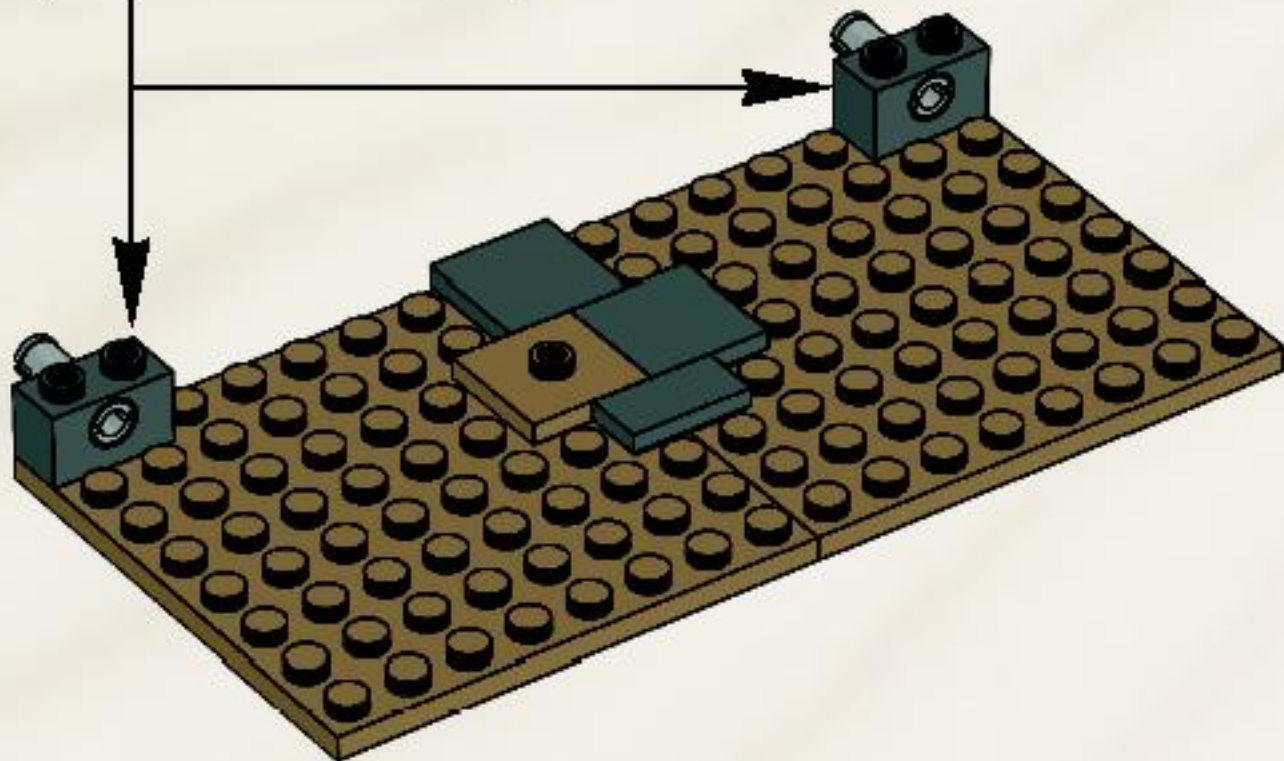
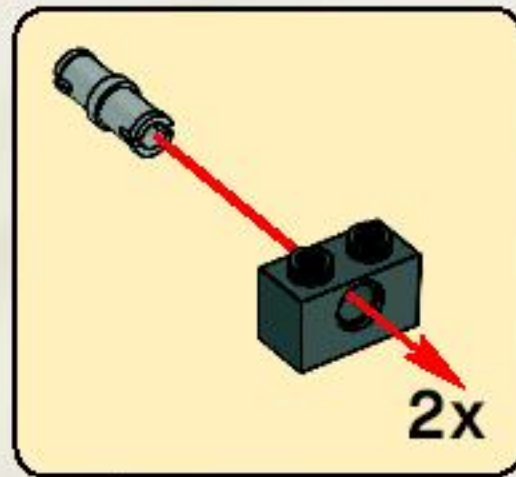

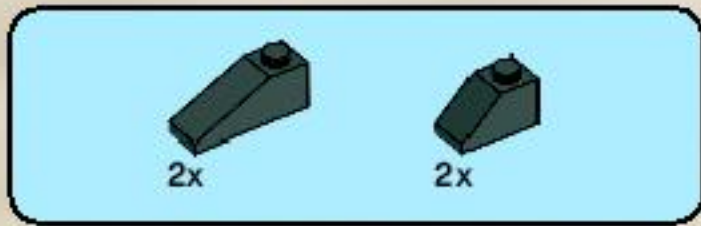

4

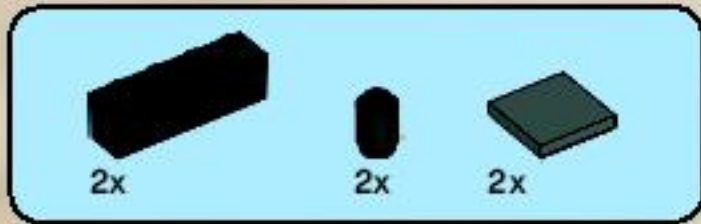
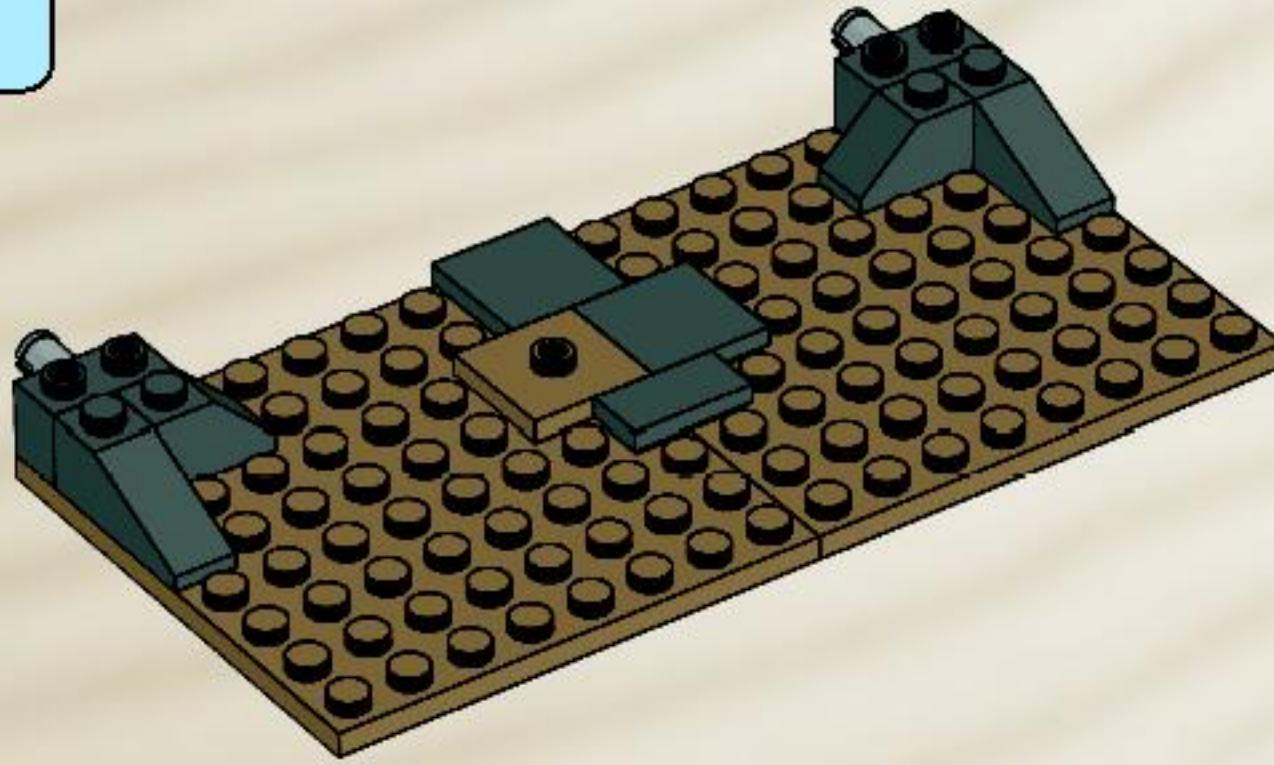

5

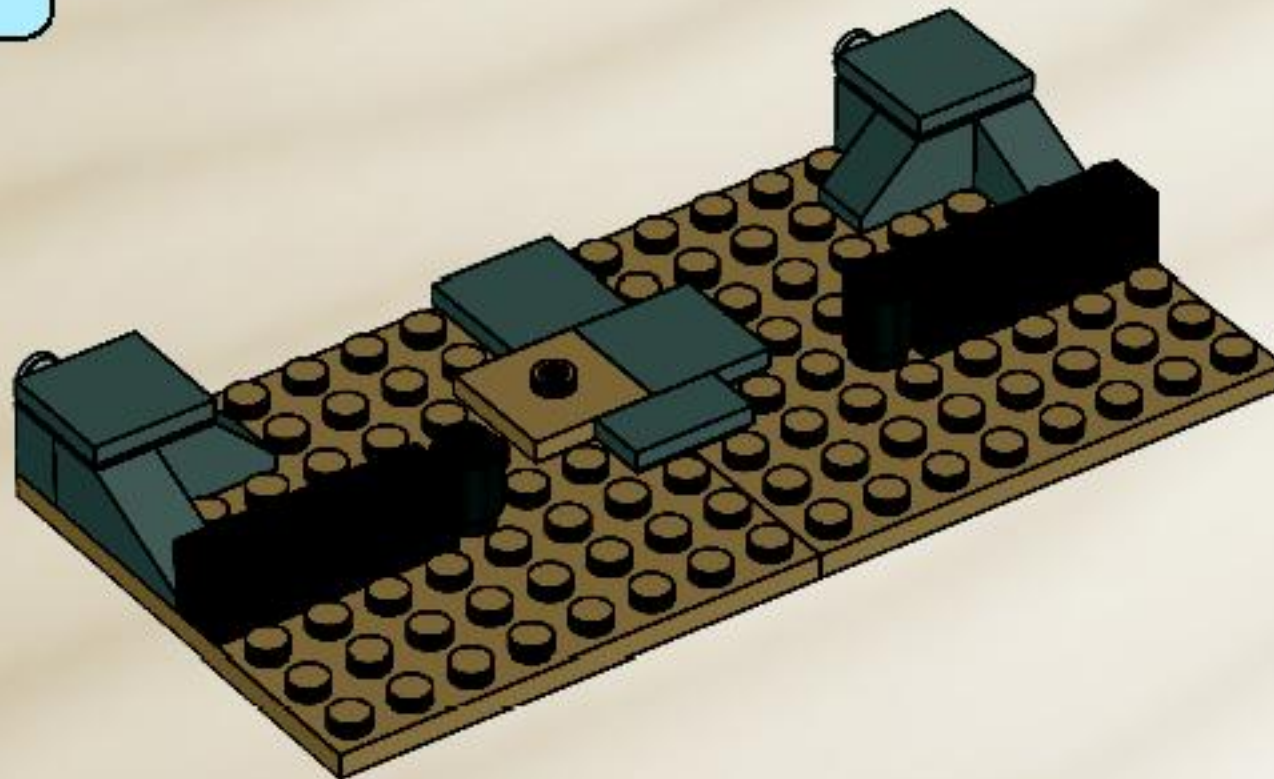

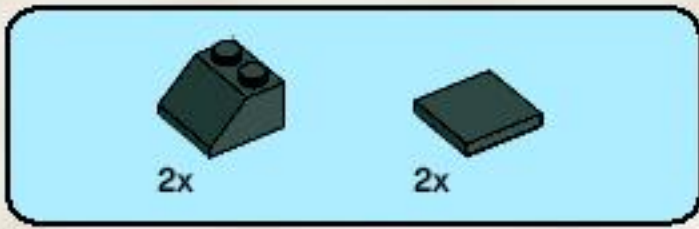

6

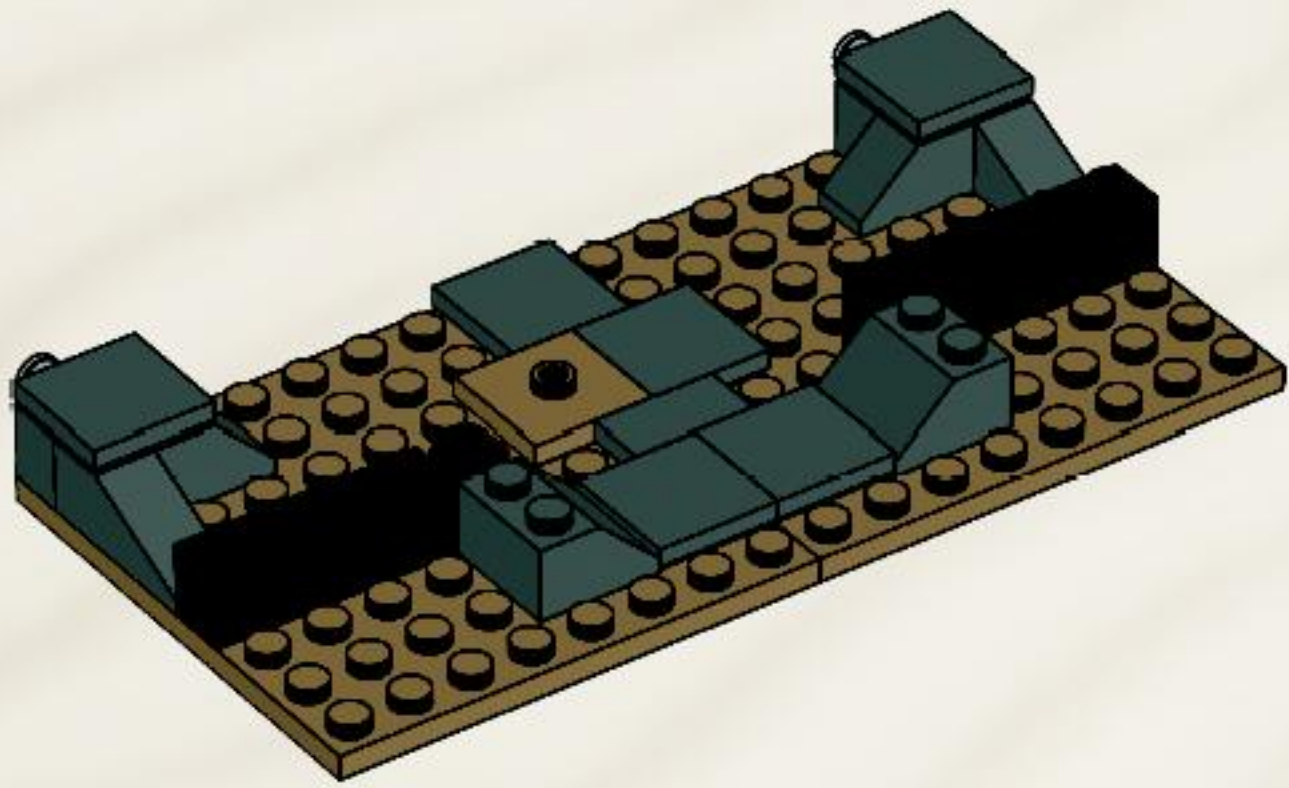

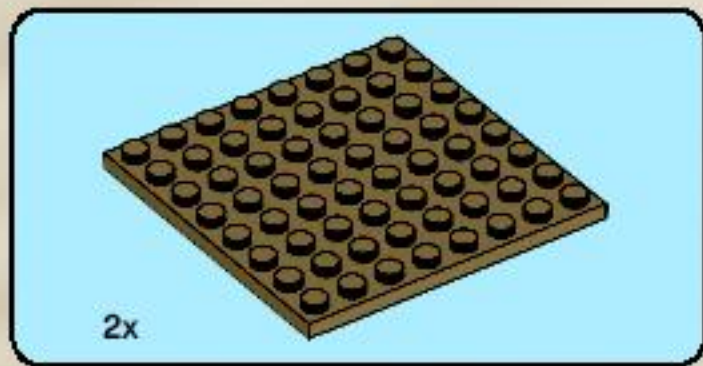

7

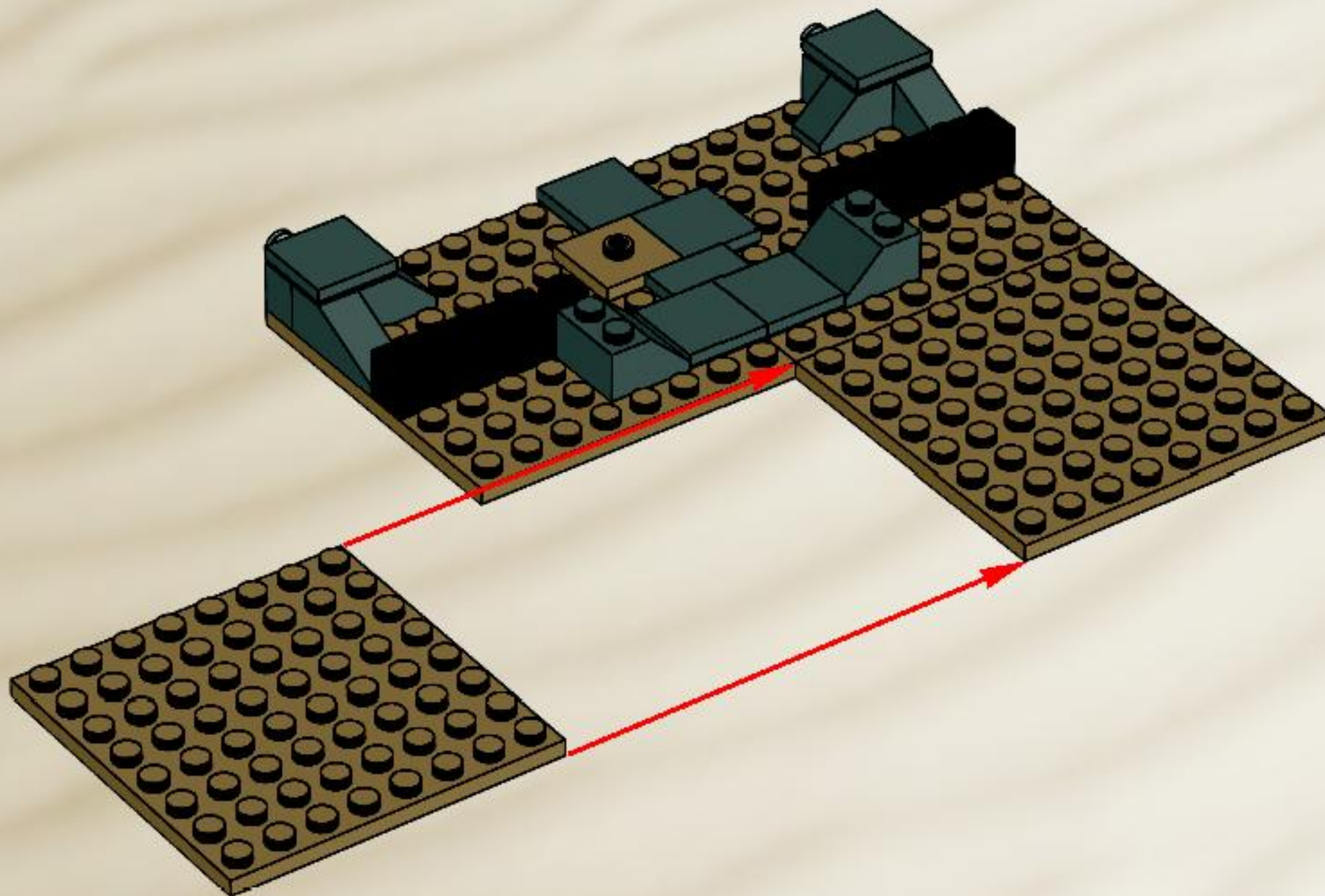

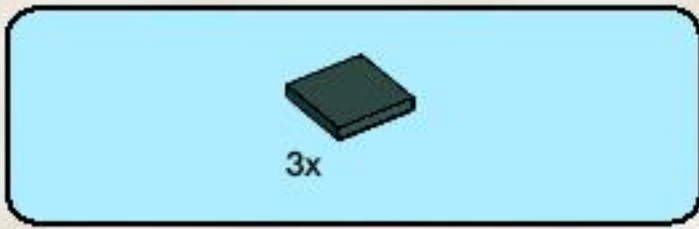

8

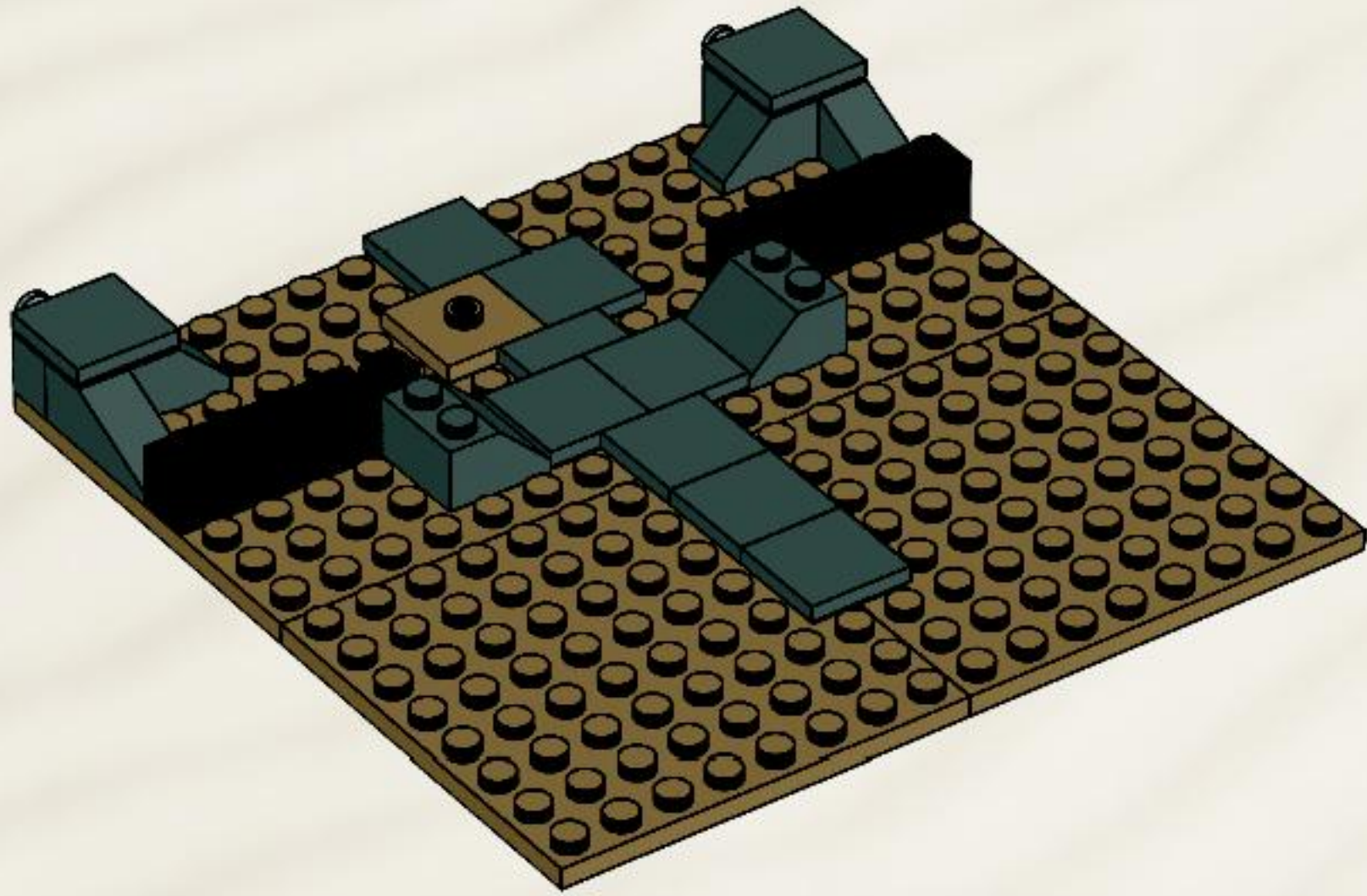

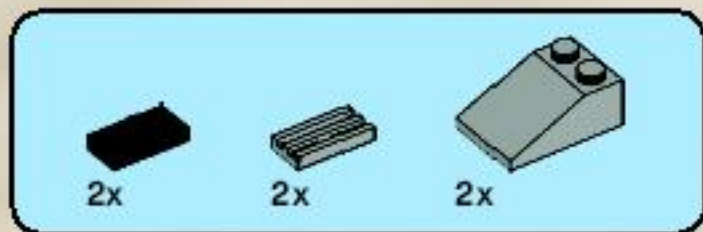

9

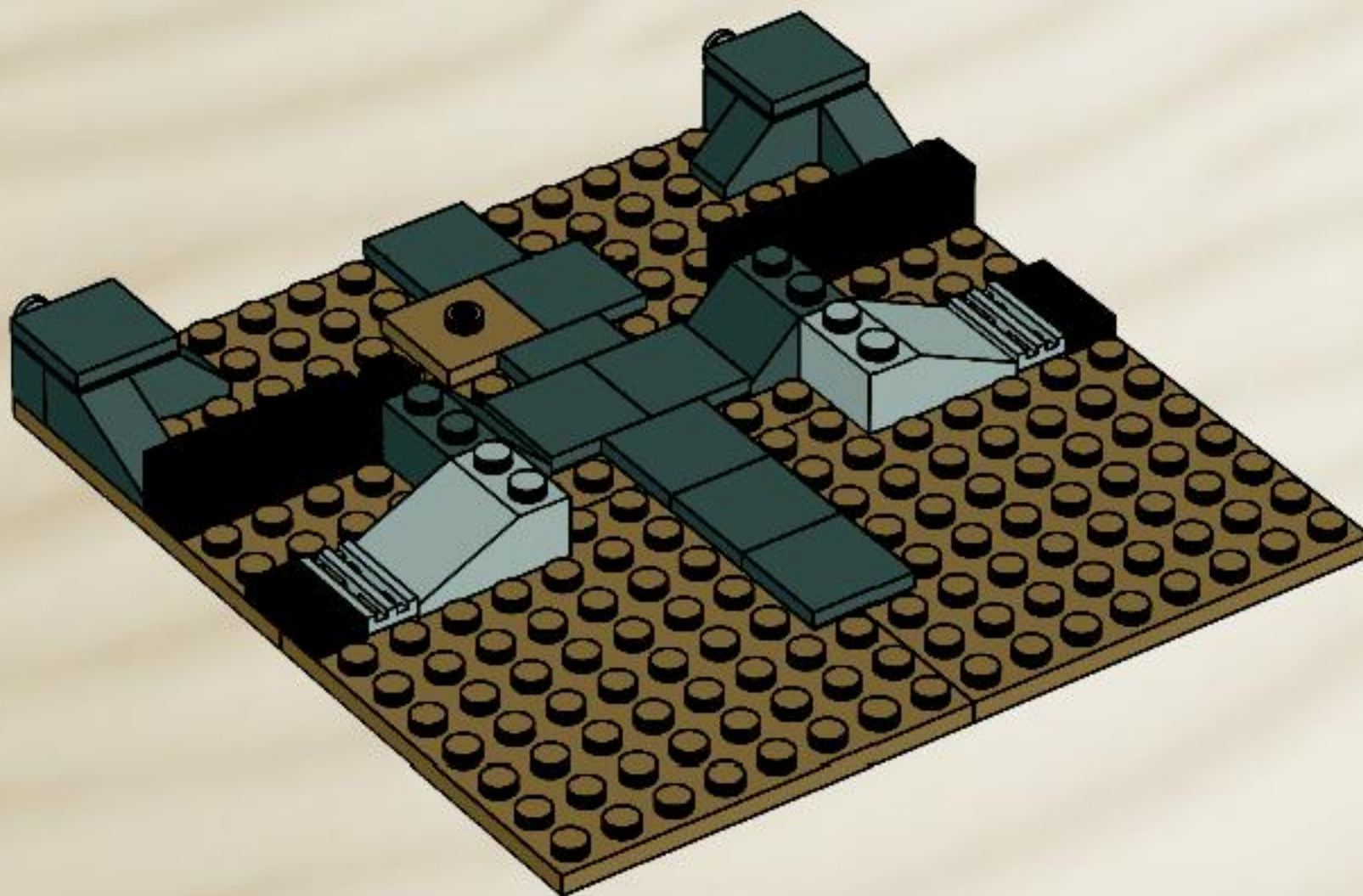

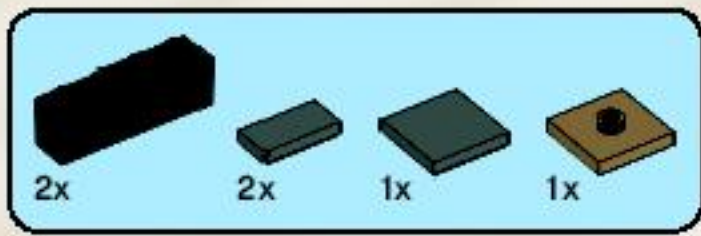

10

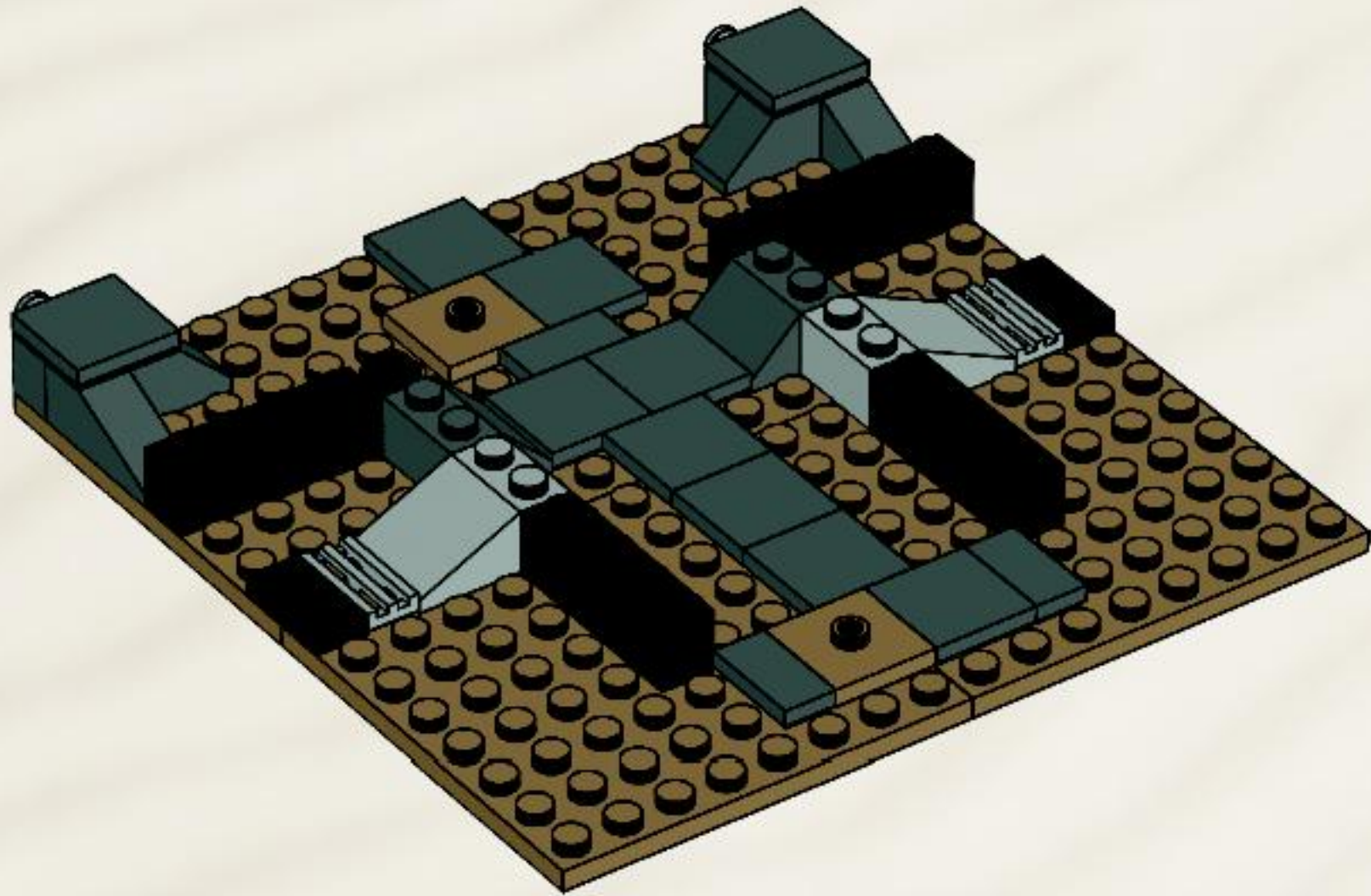

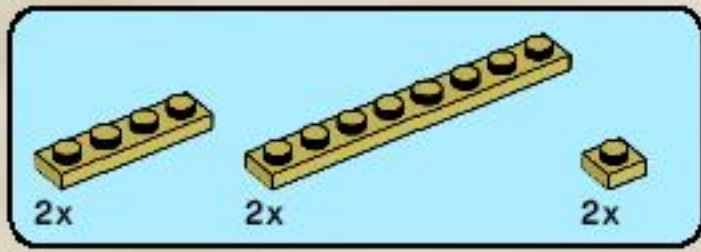

11

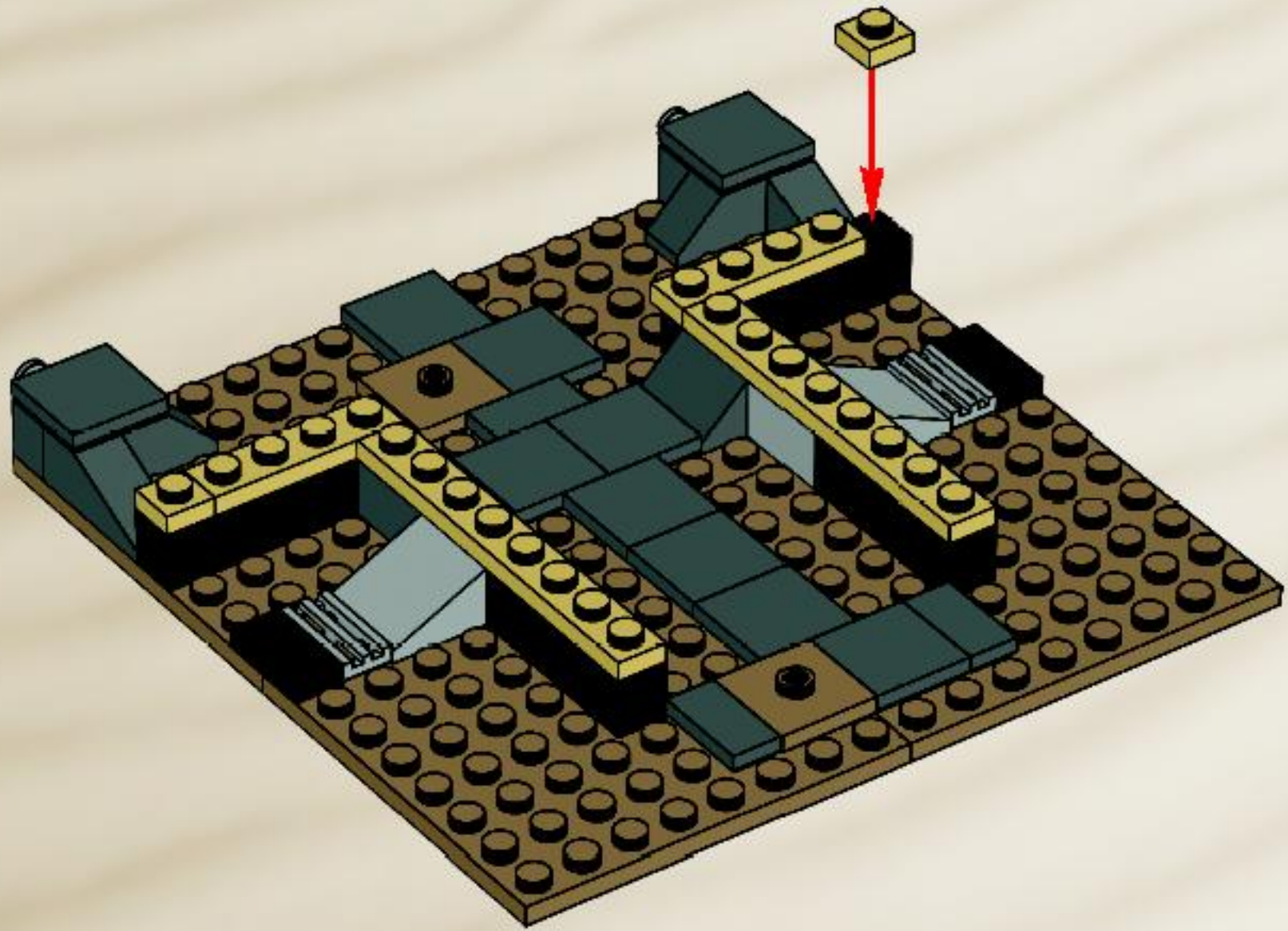

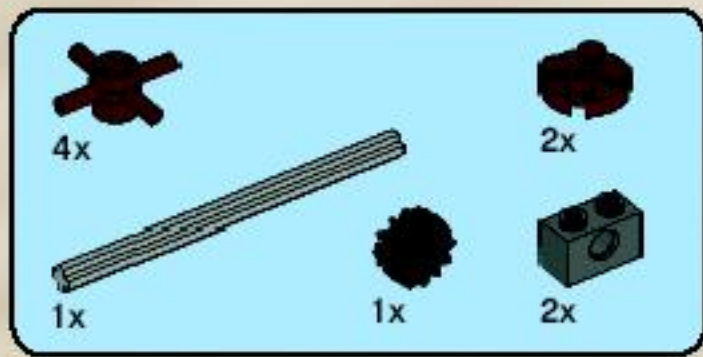

13

1



2

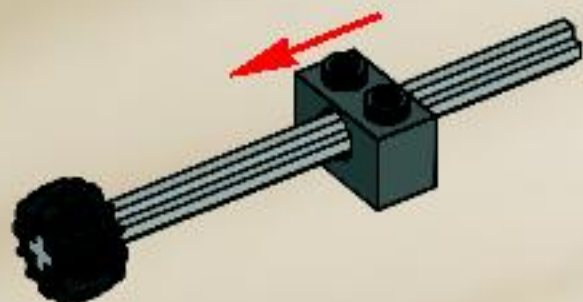

3

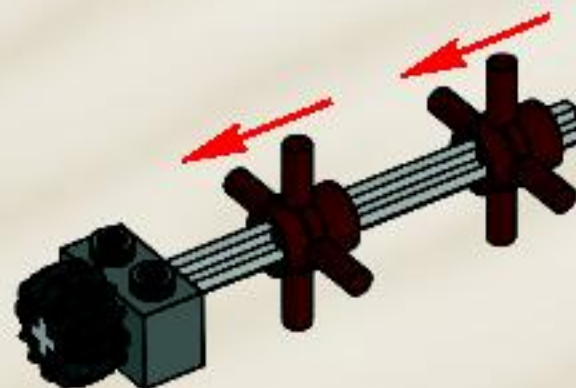

4

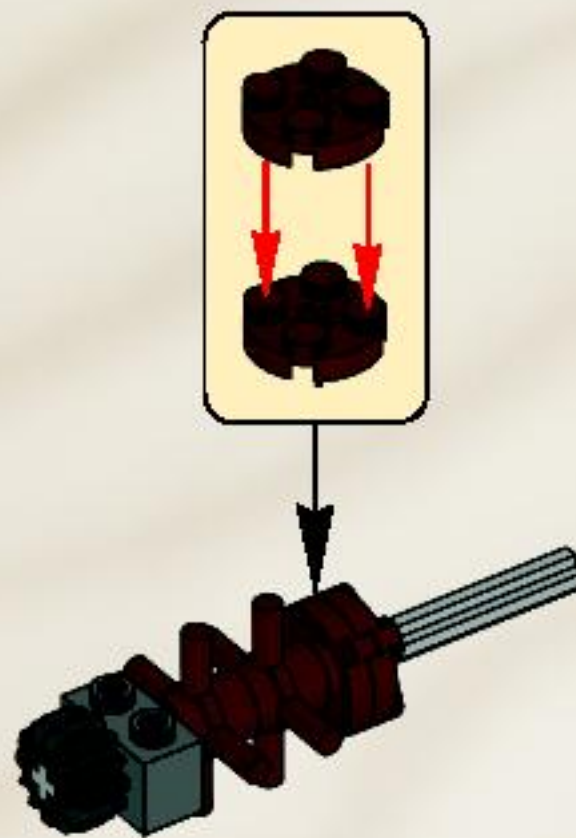

5

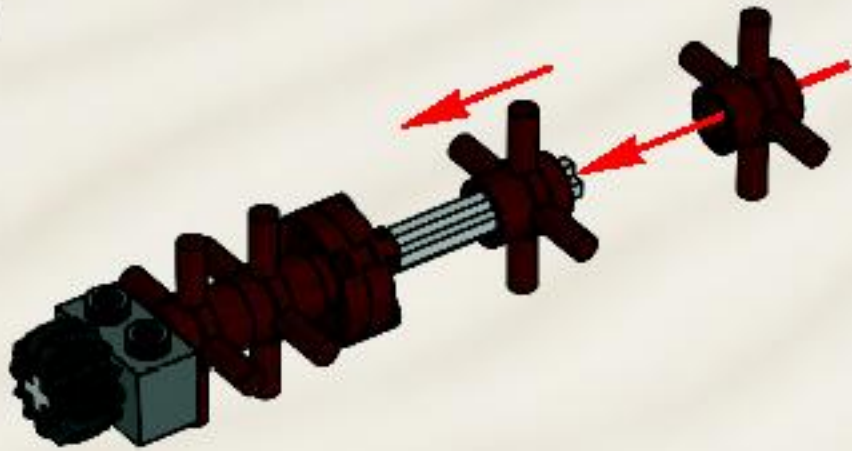

6

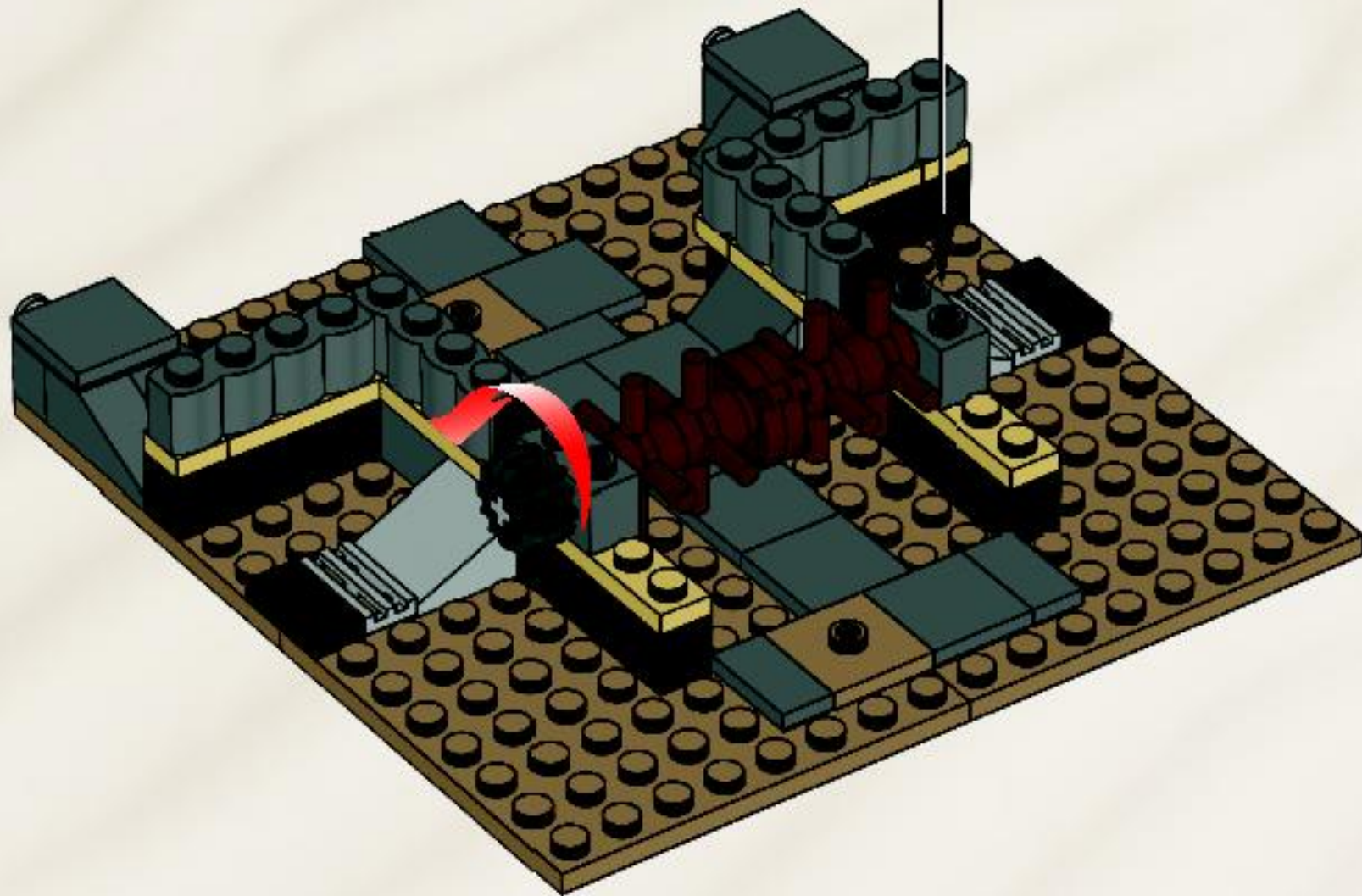
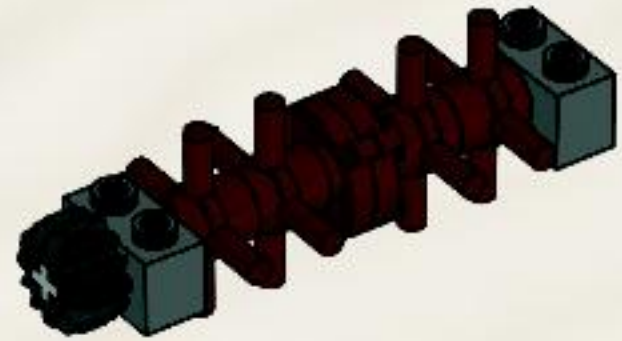

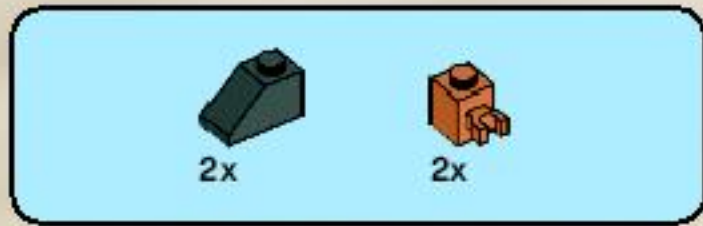

14

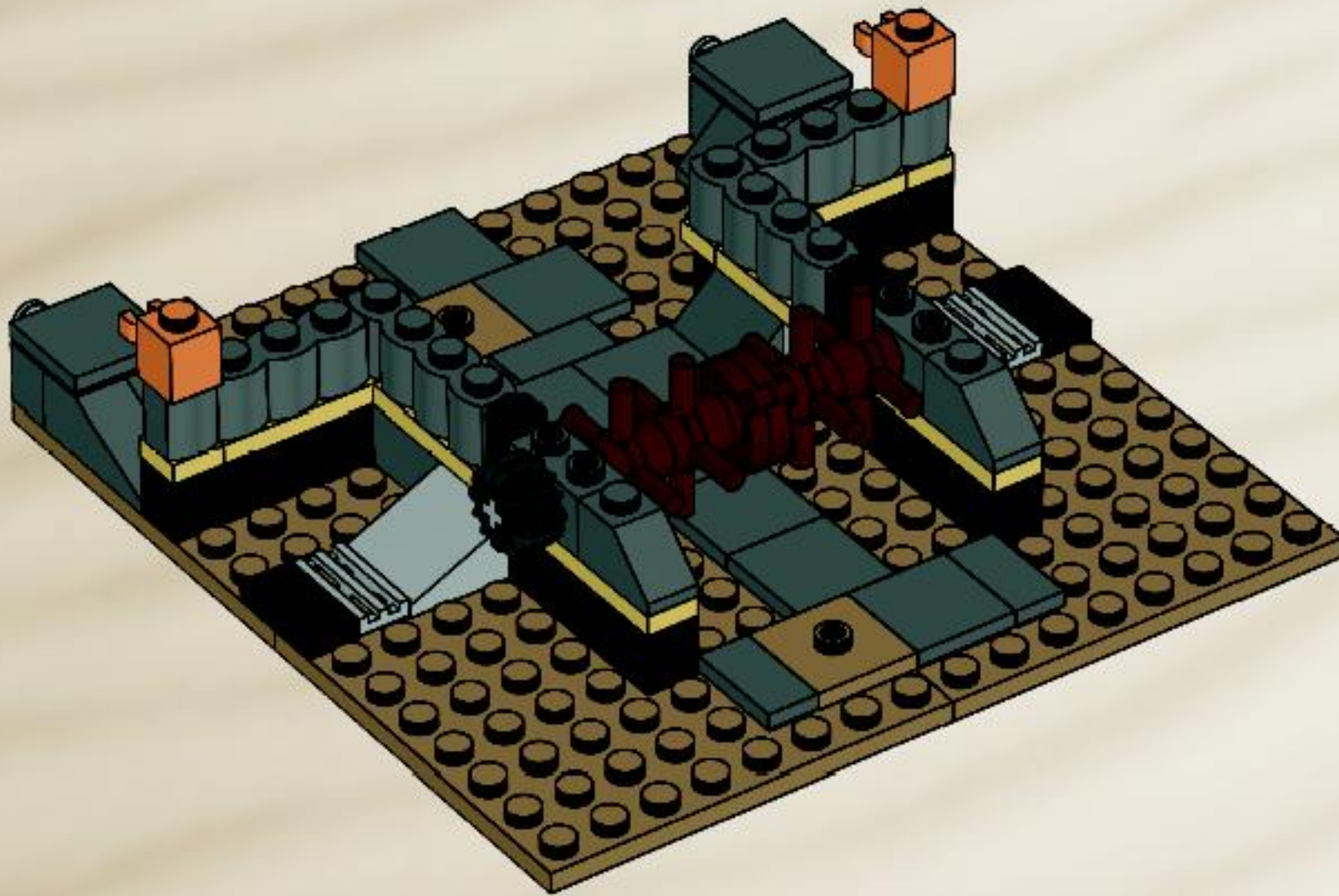

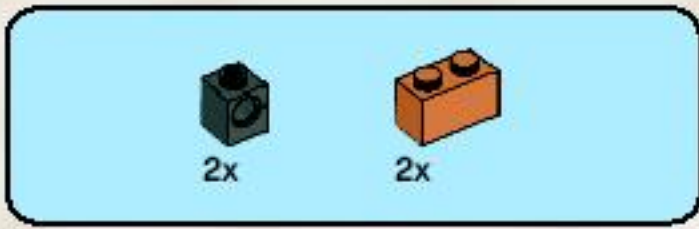

15

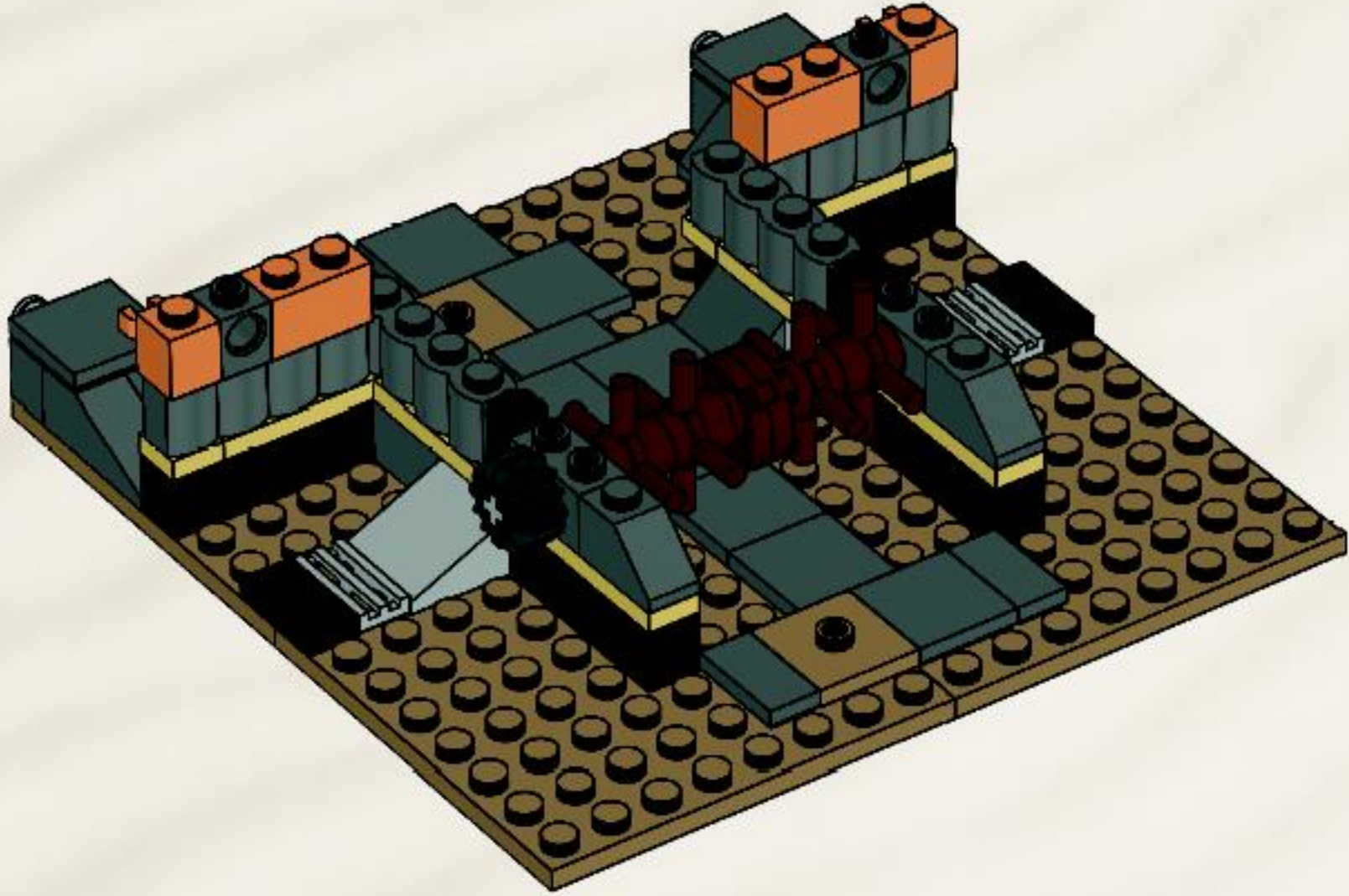

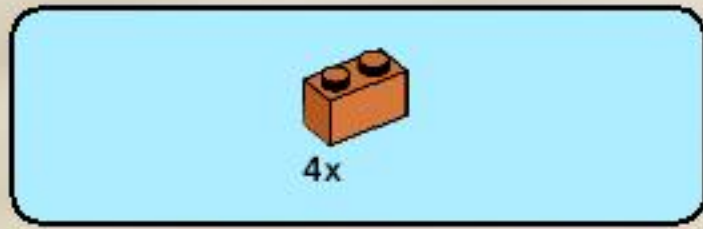

16

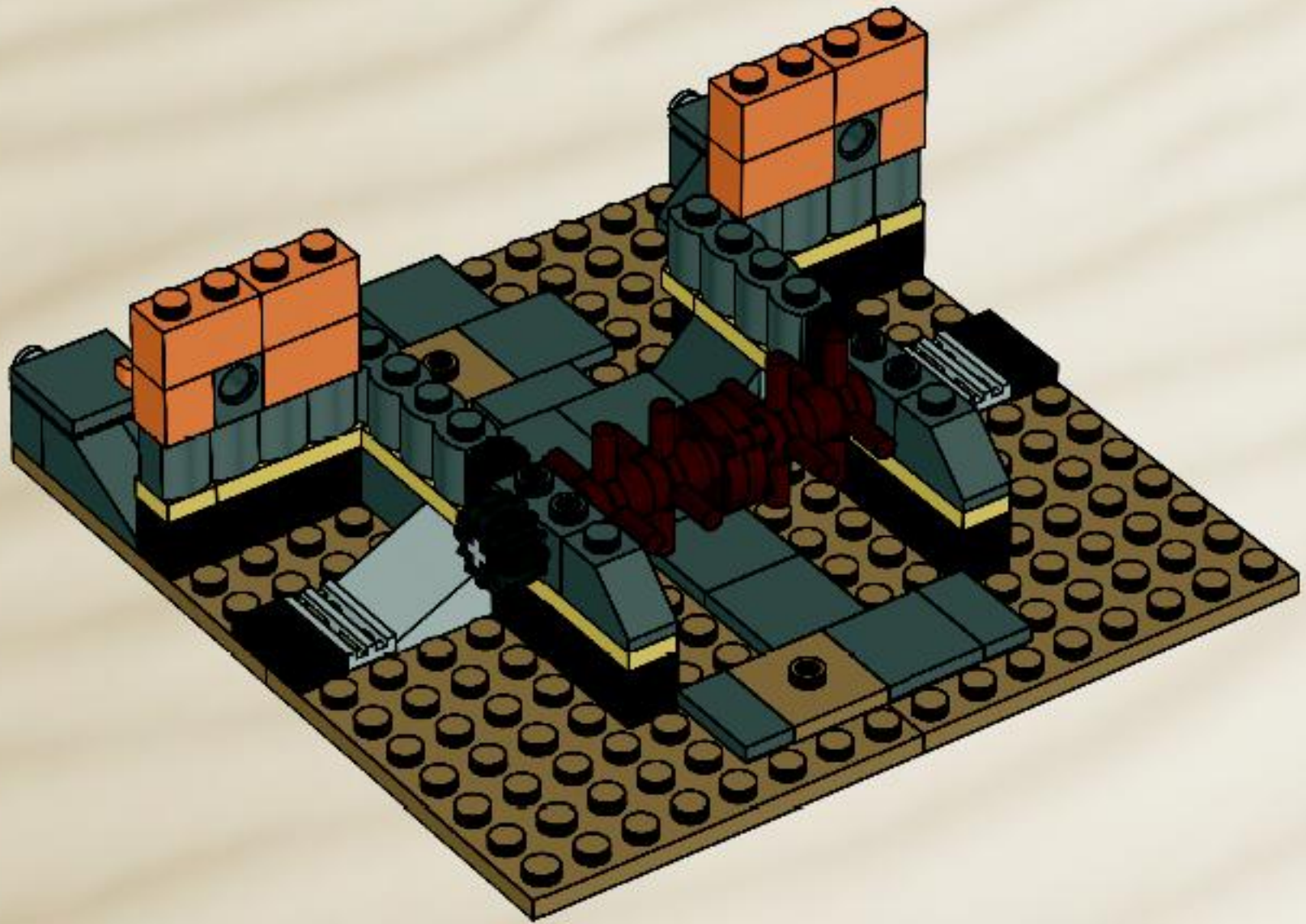

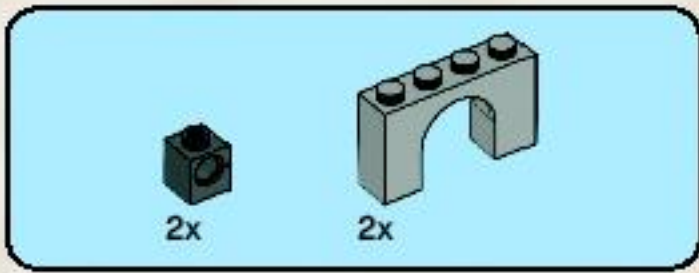

17

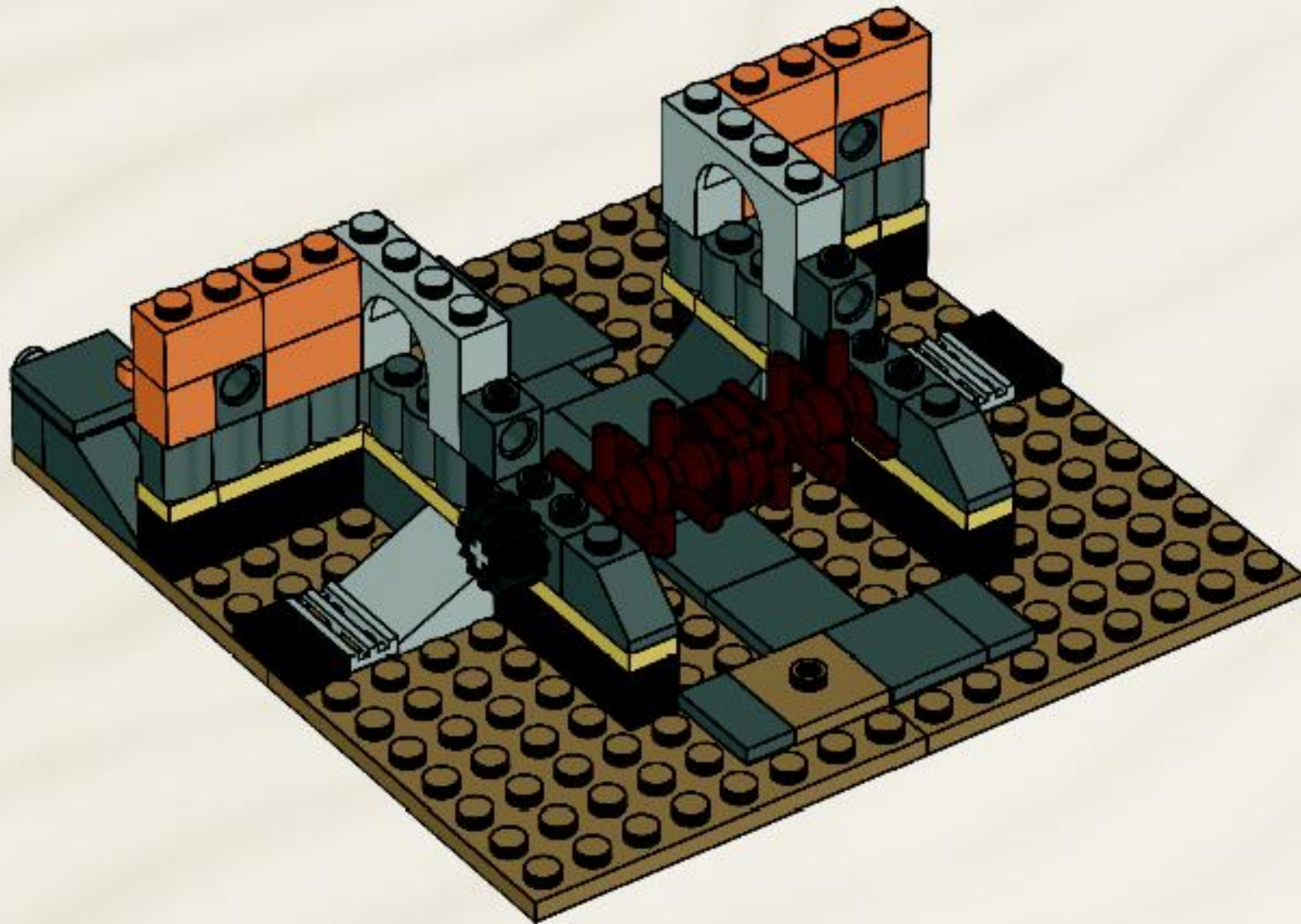

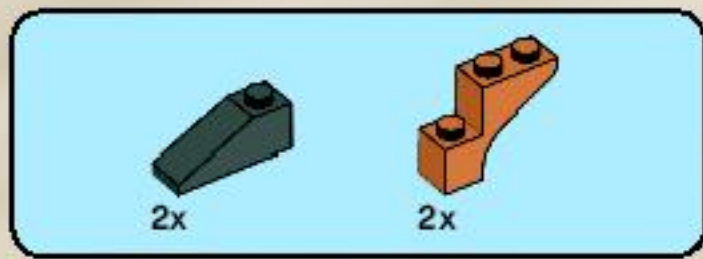

18

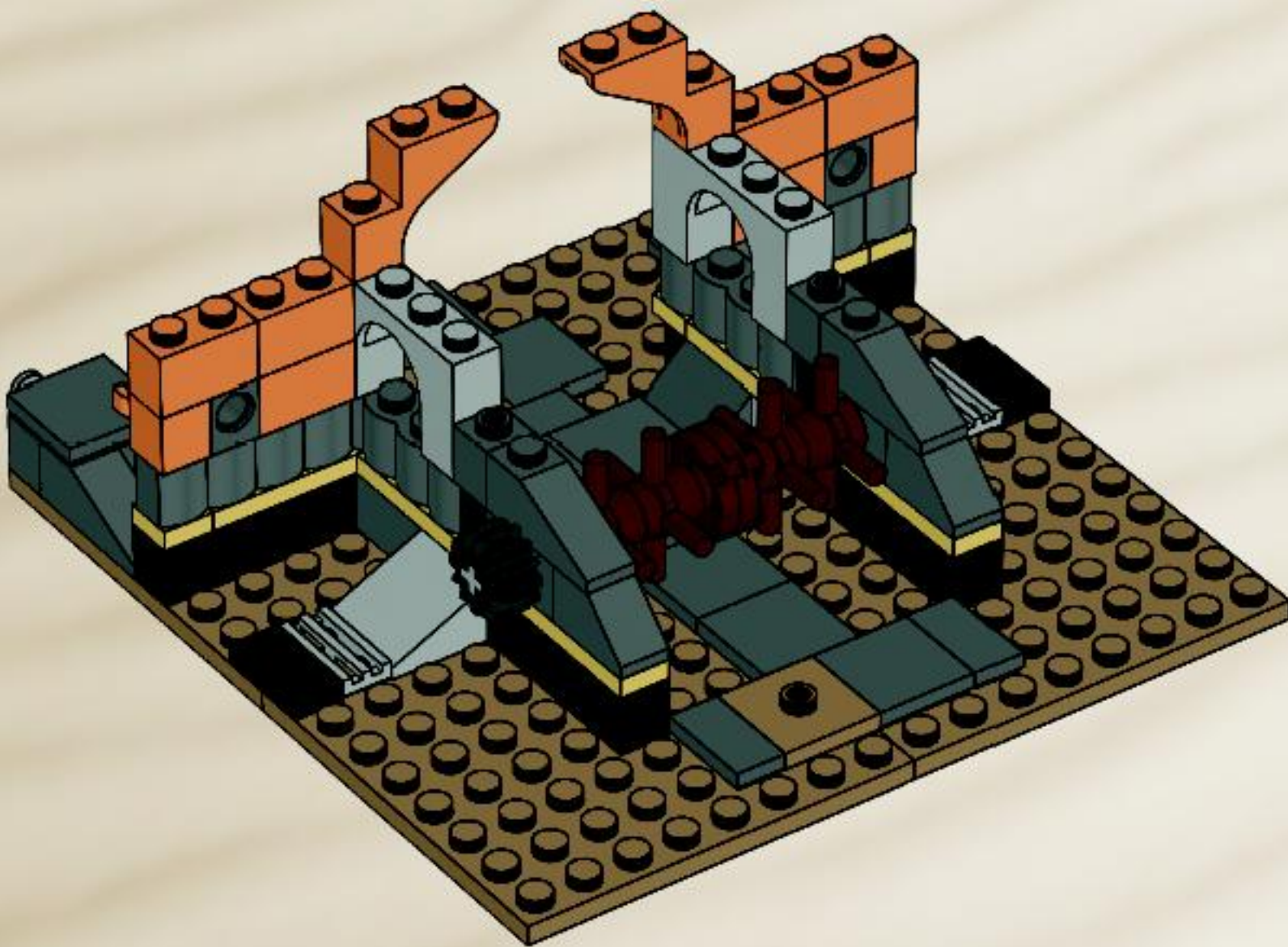

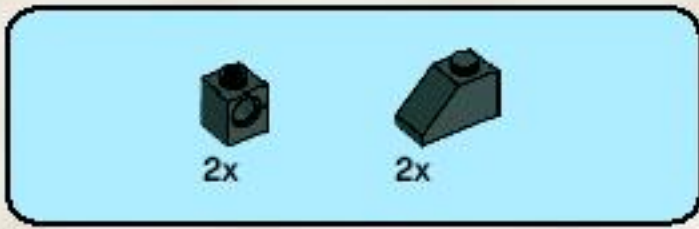

19

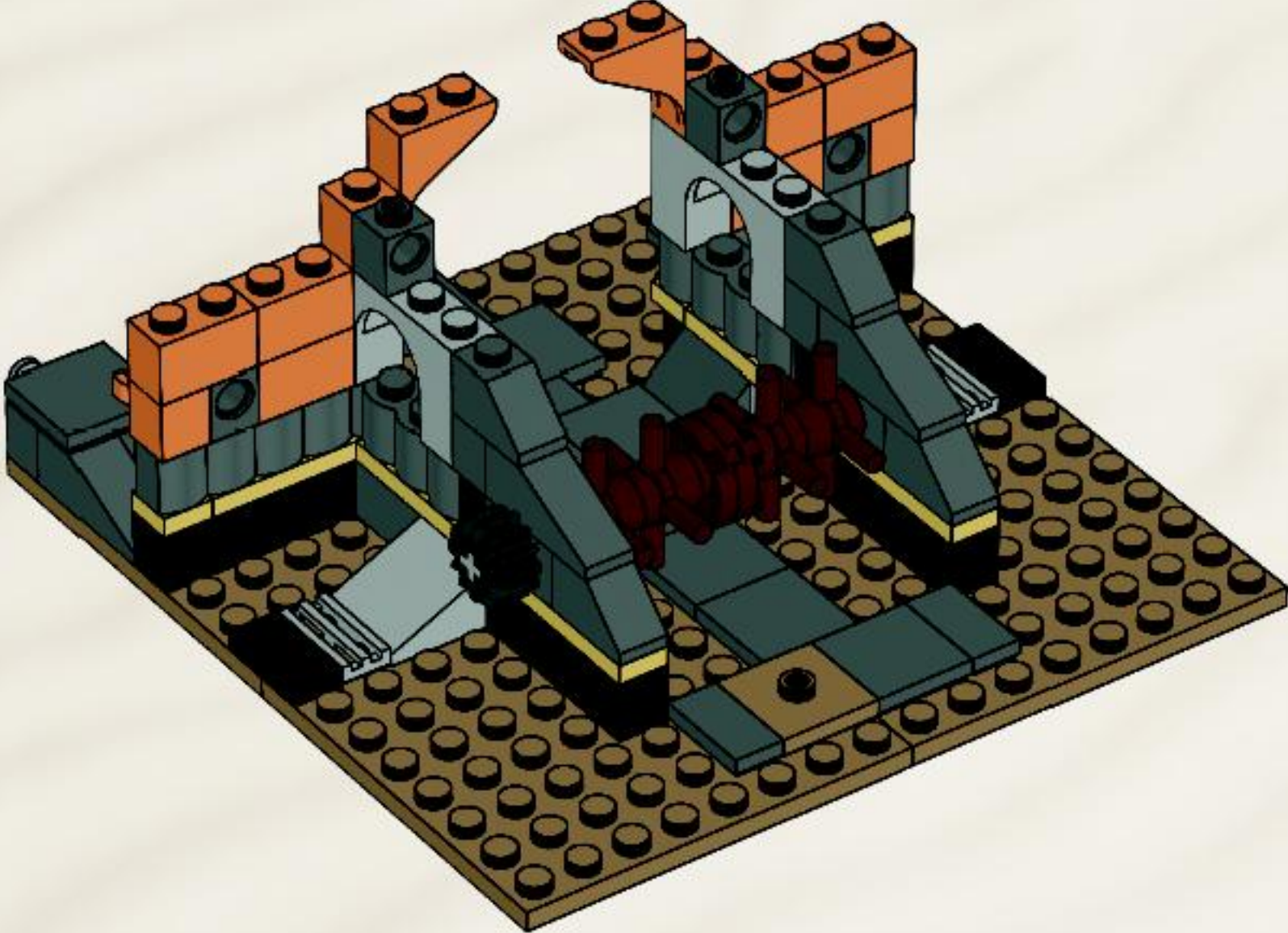

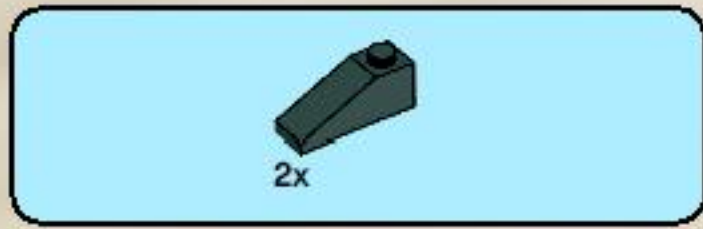

20

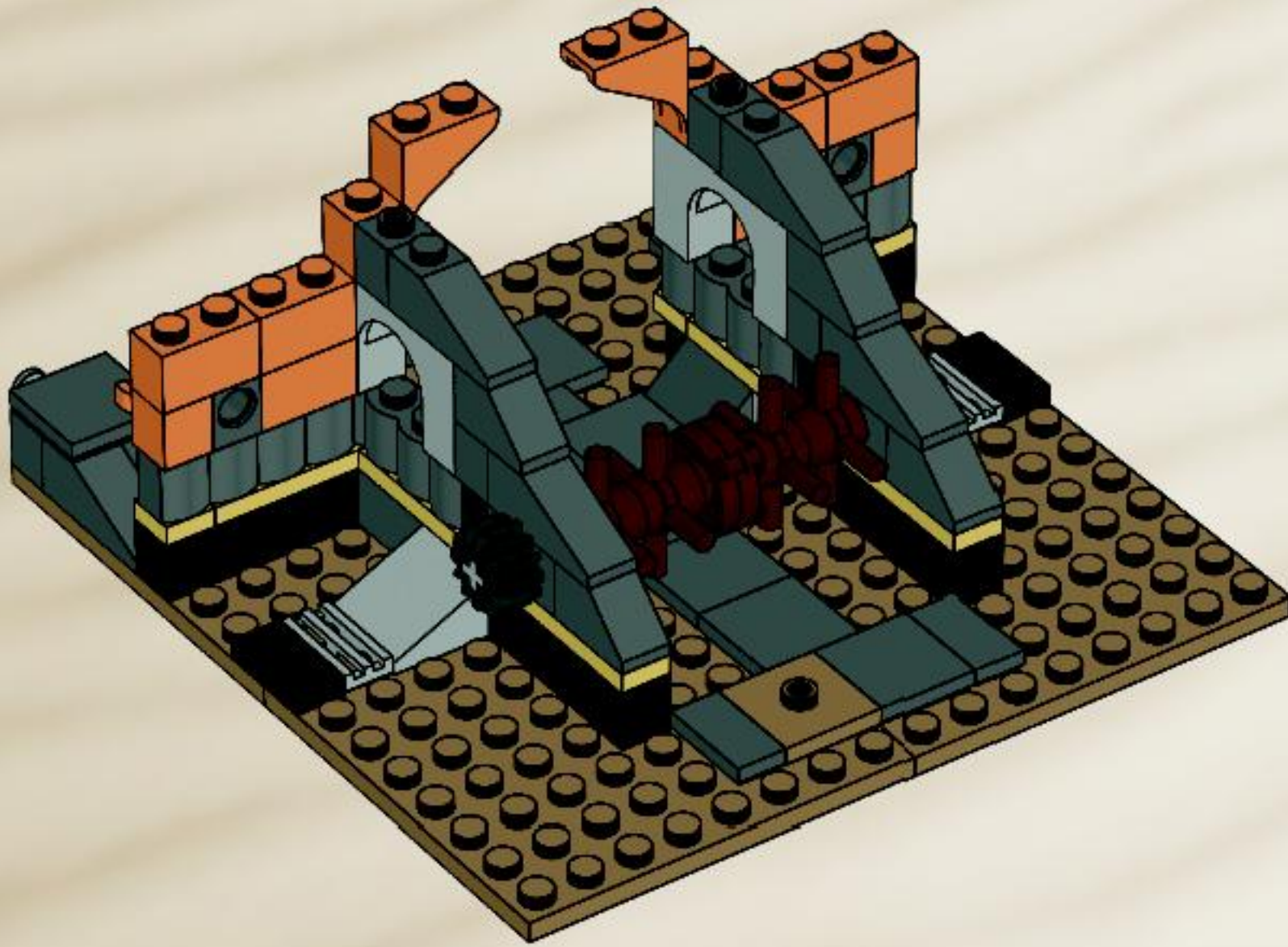



21

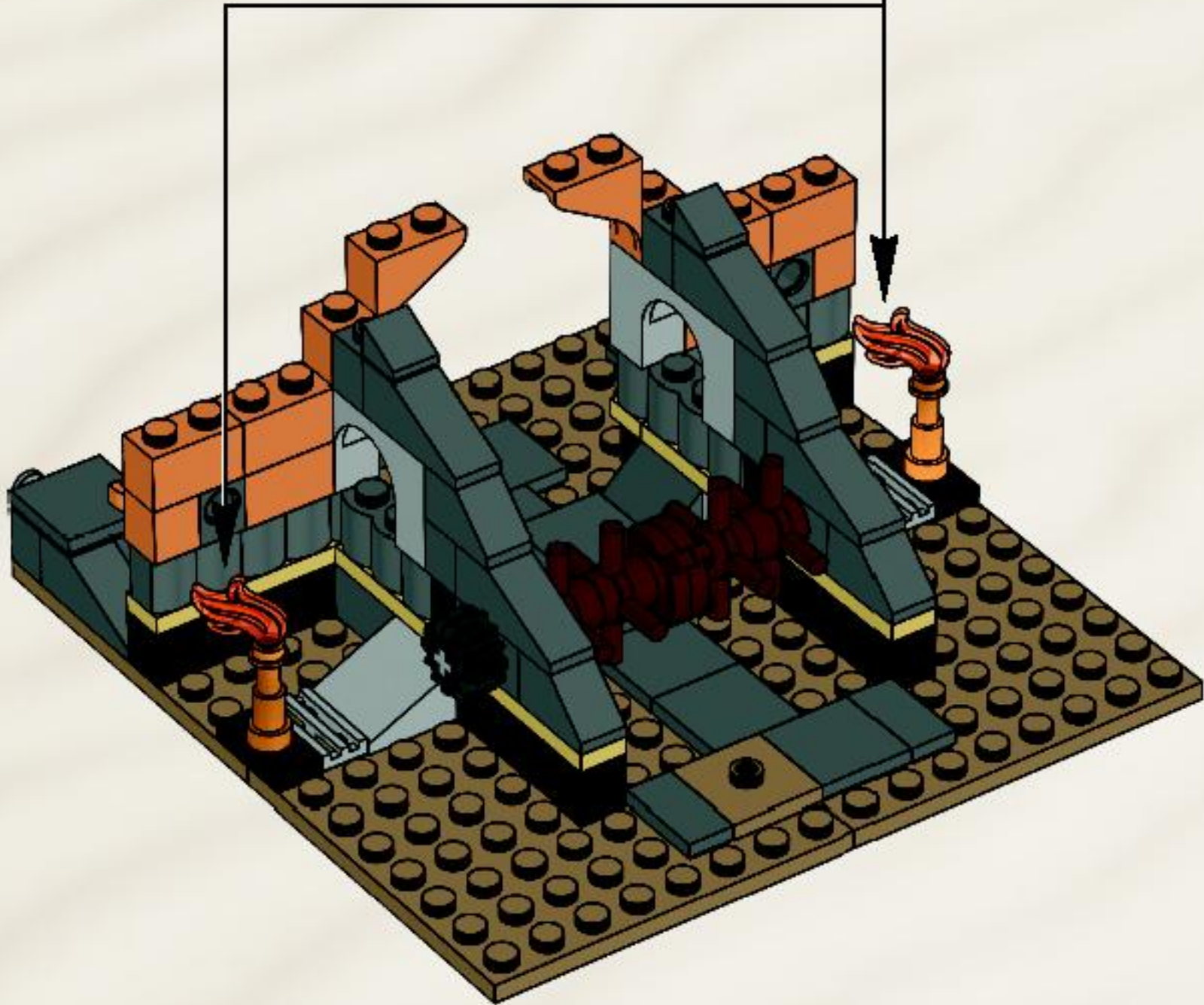

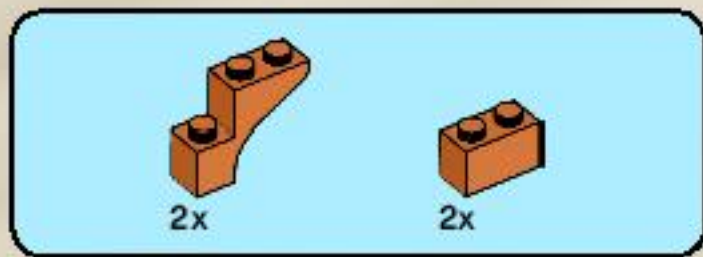

22

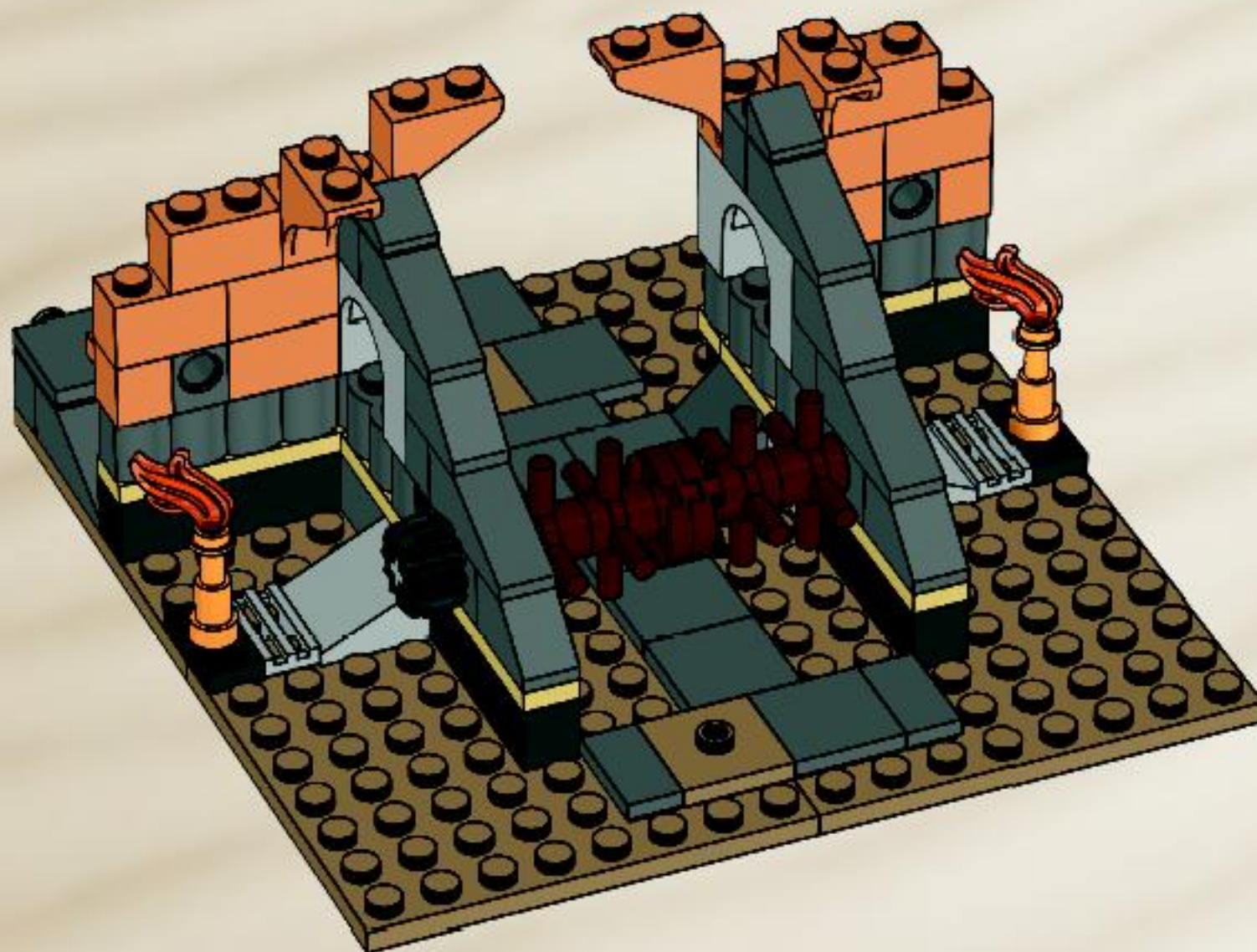

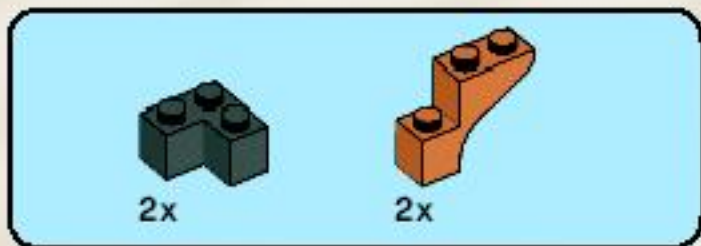

23

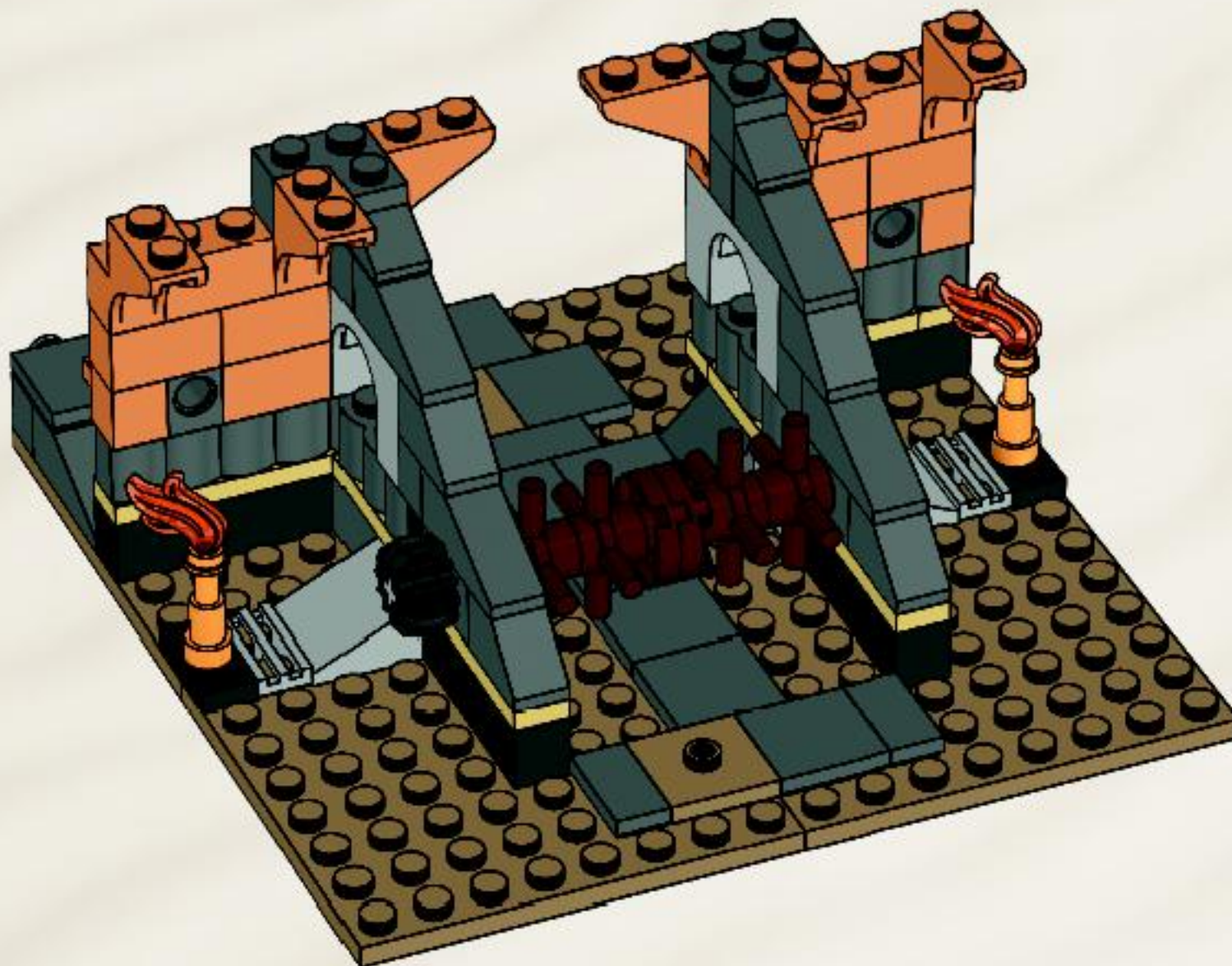

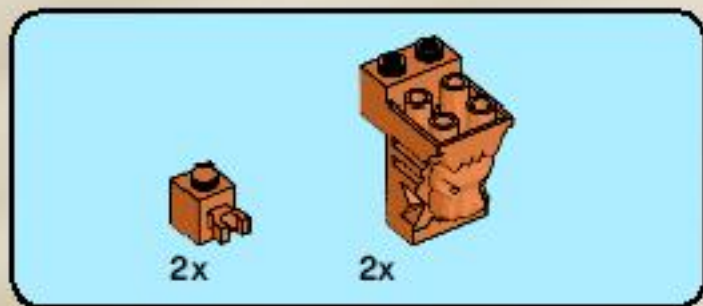

24

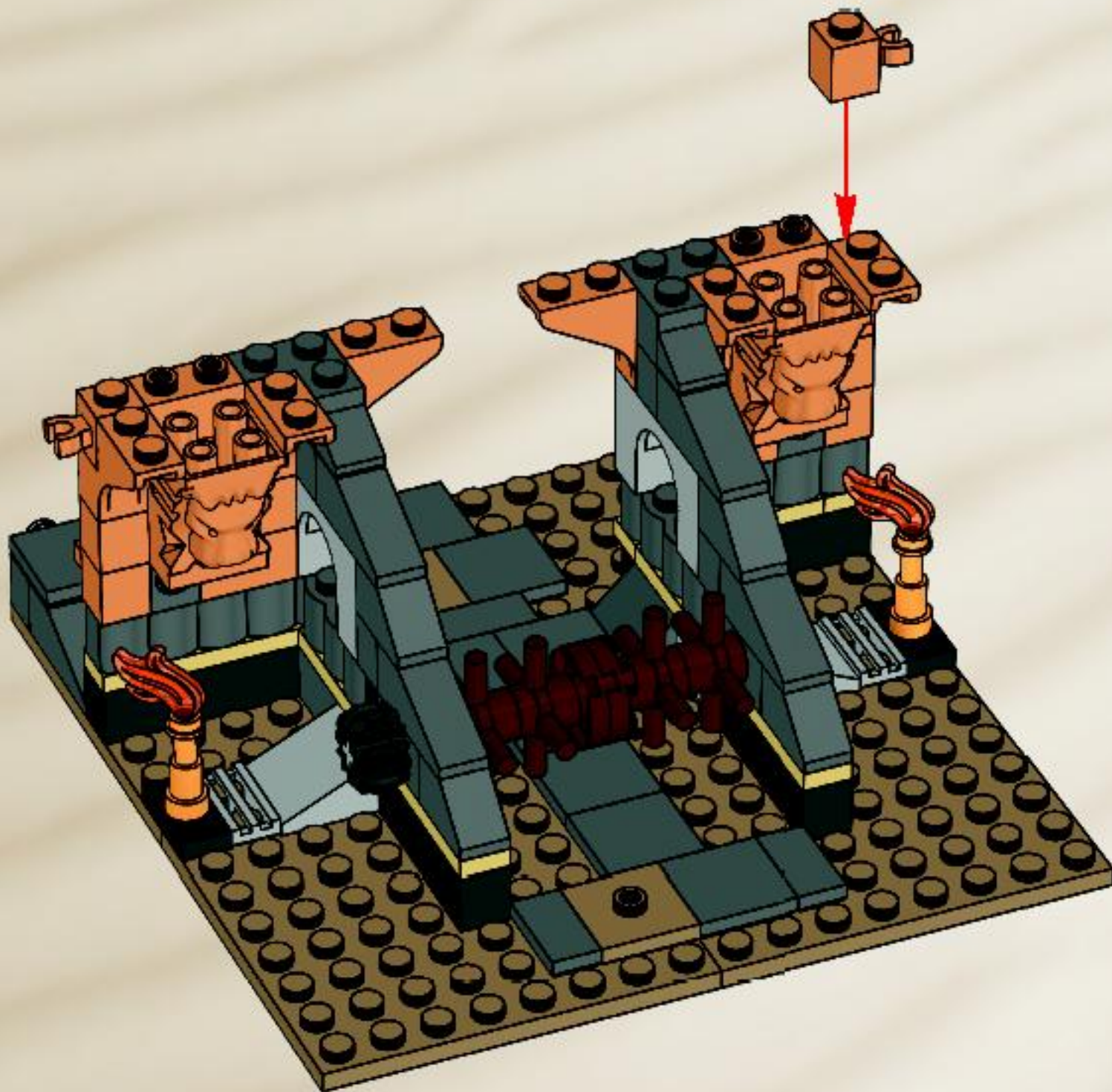

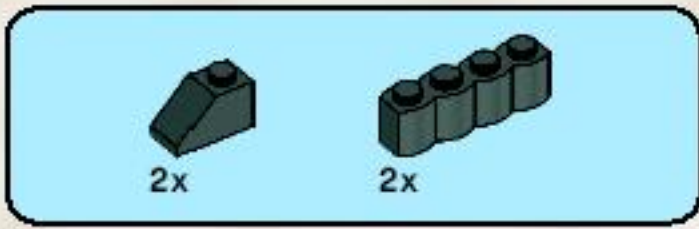

25

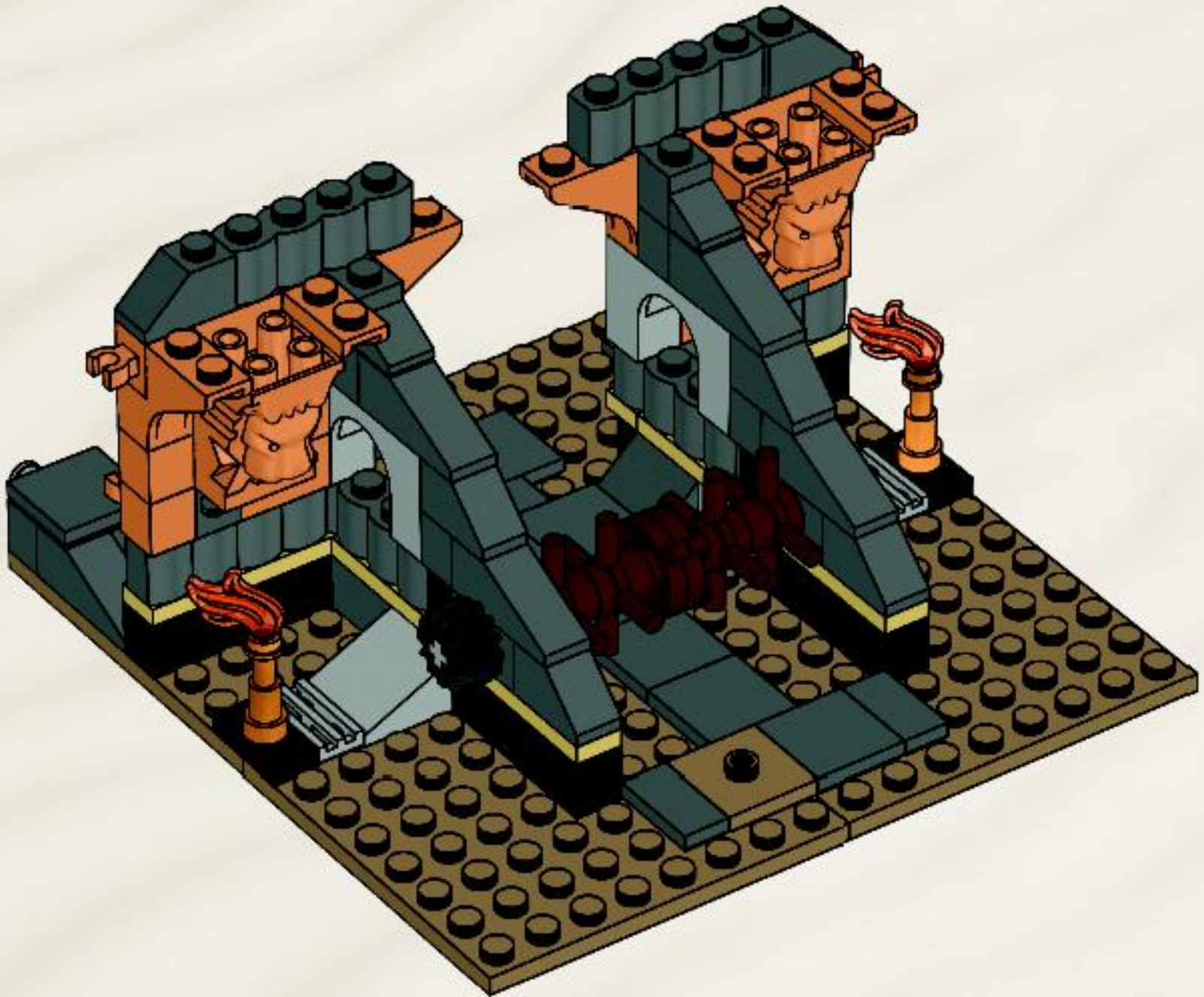

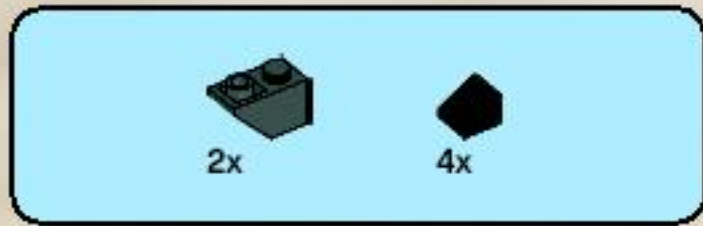

26

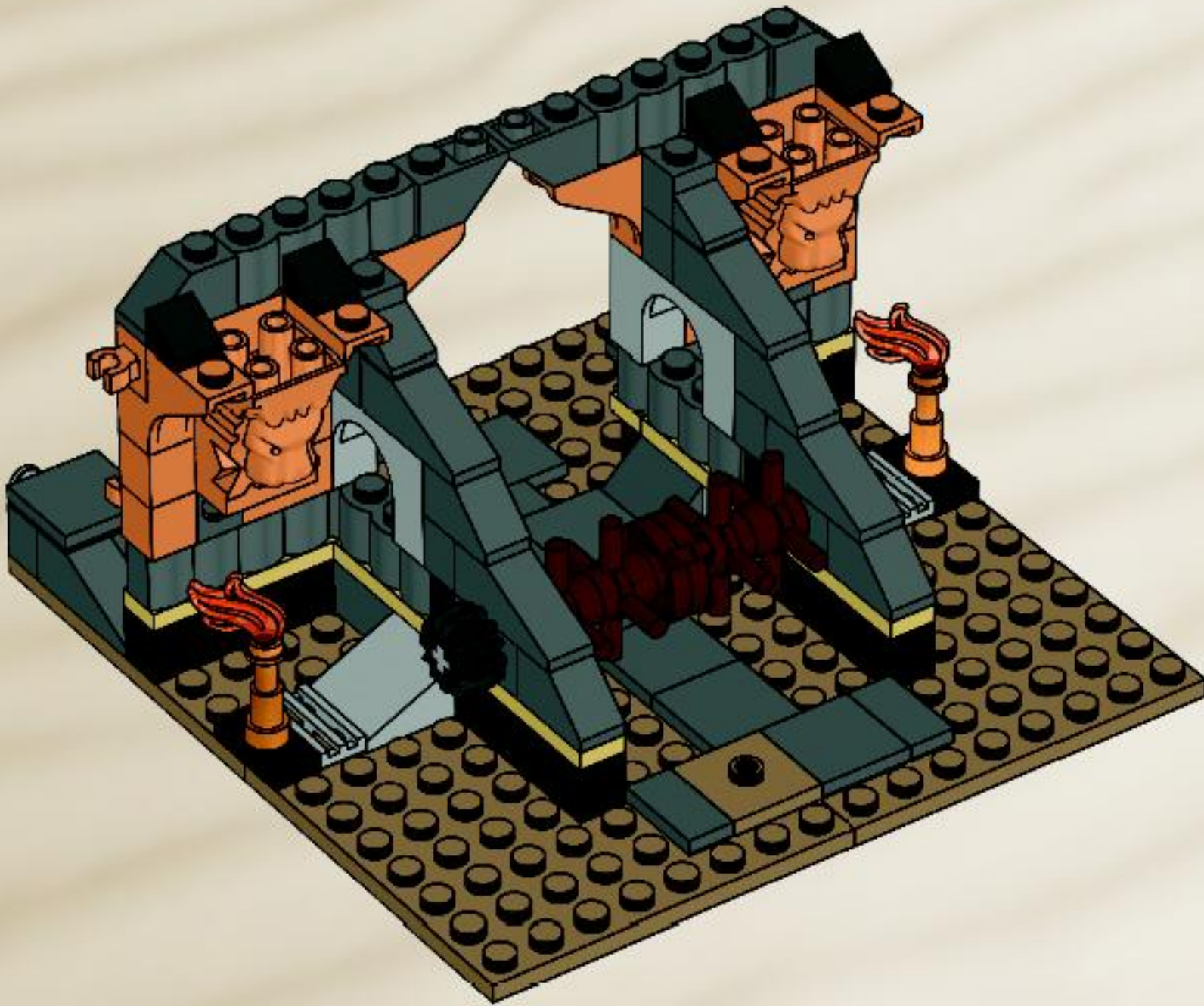

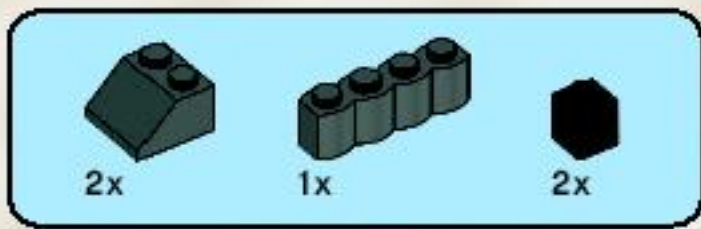

27

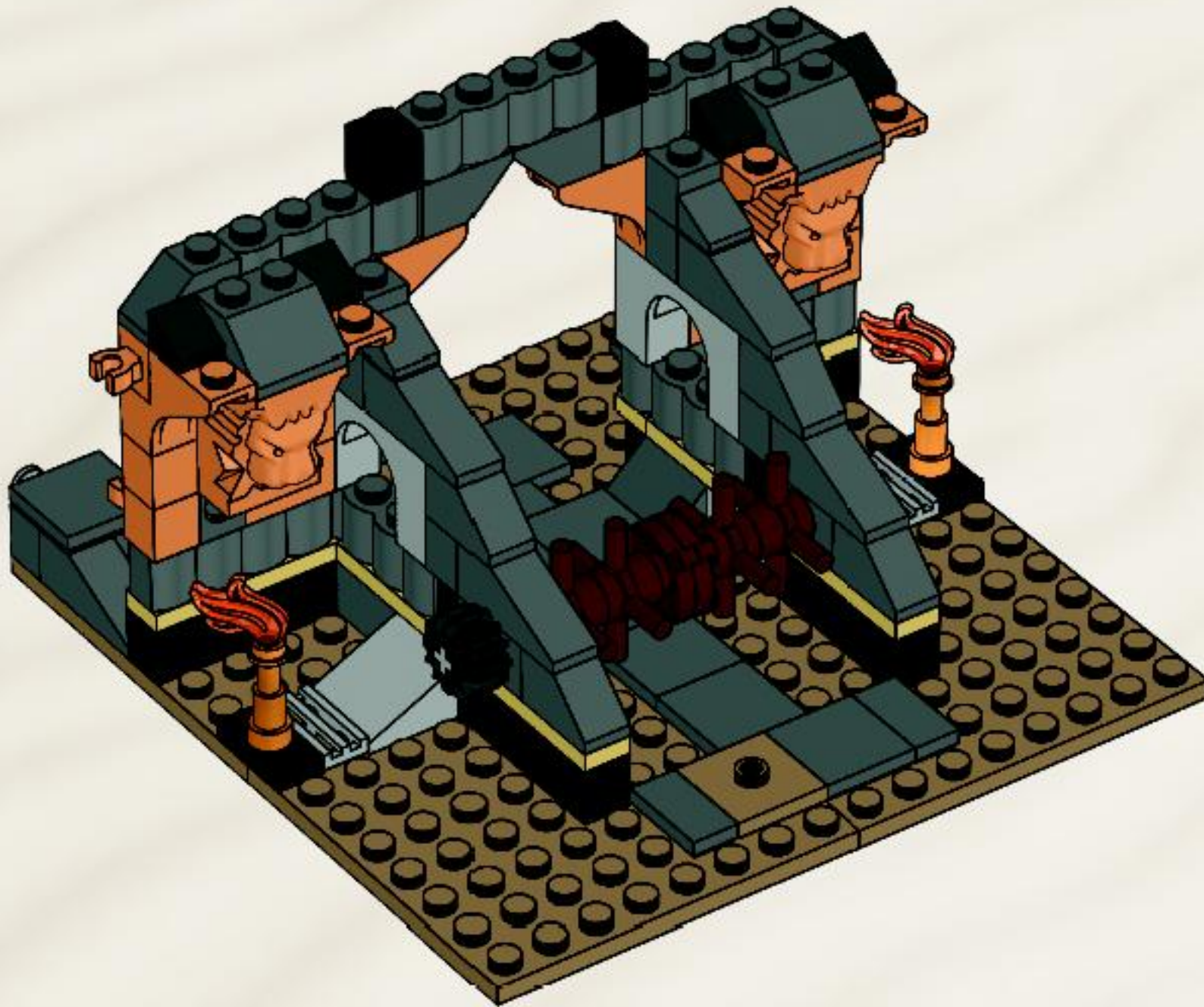

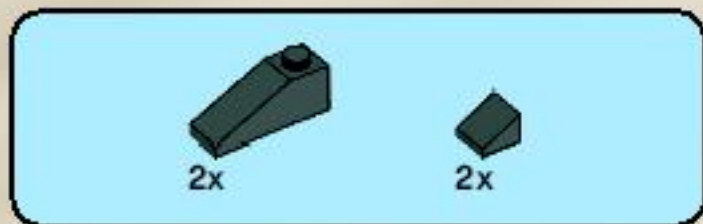

28

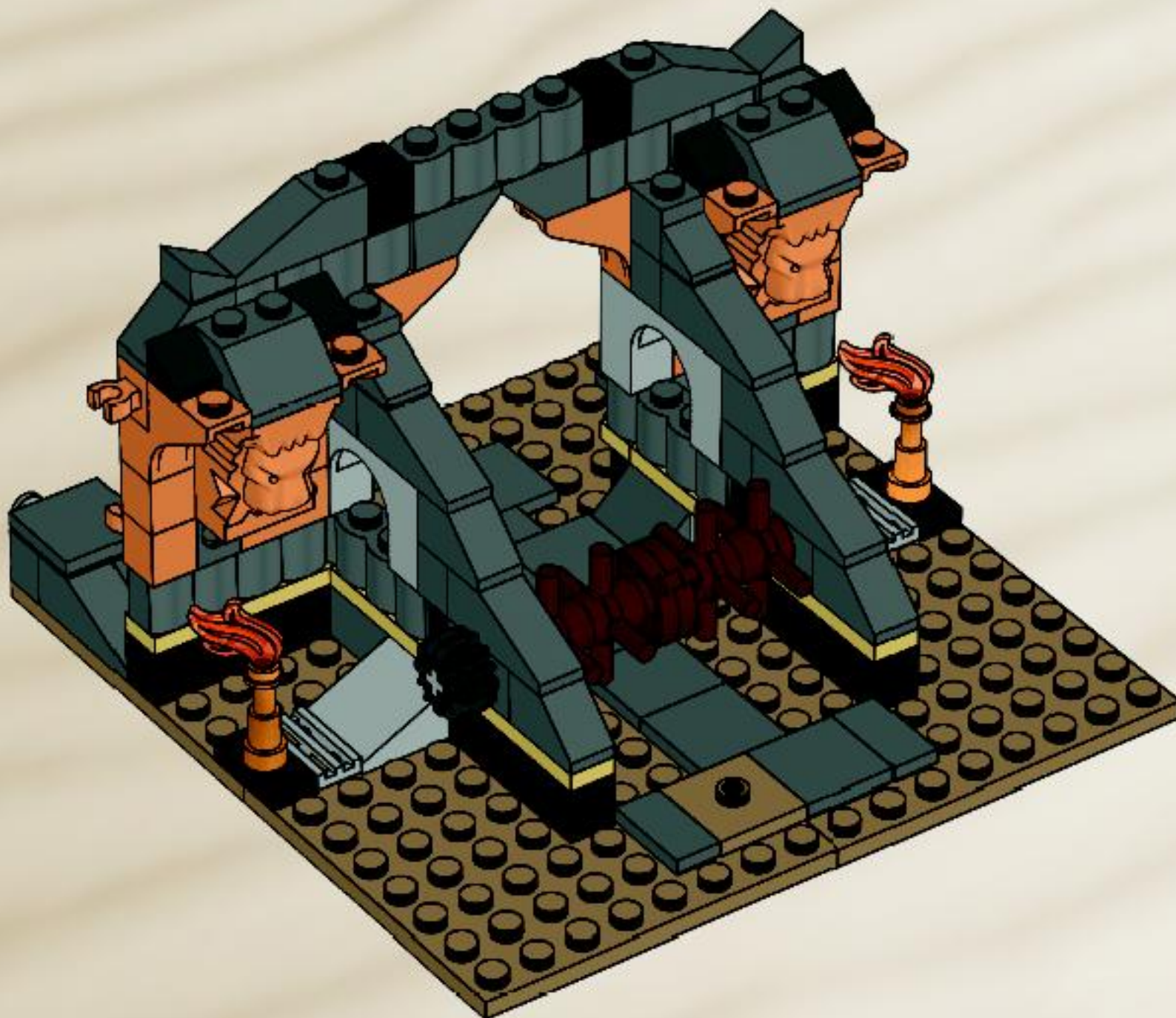



6x

29

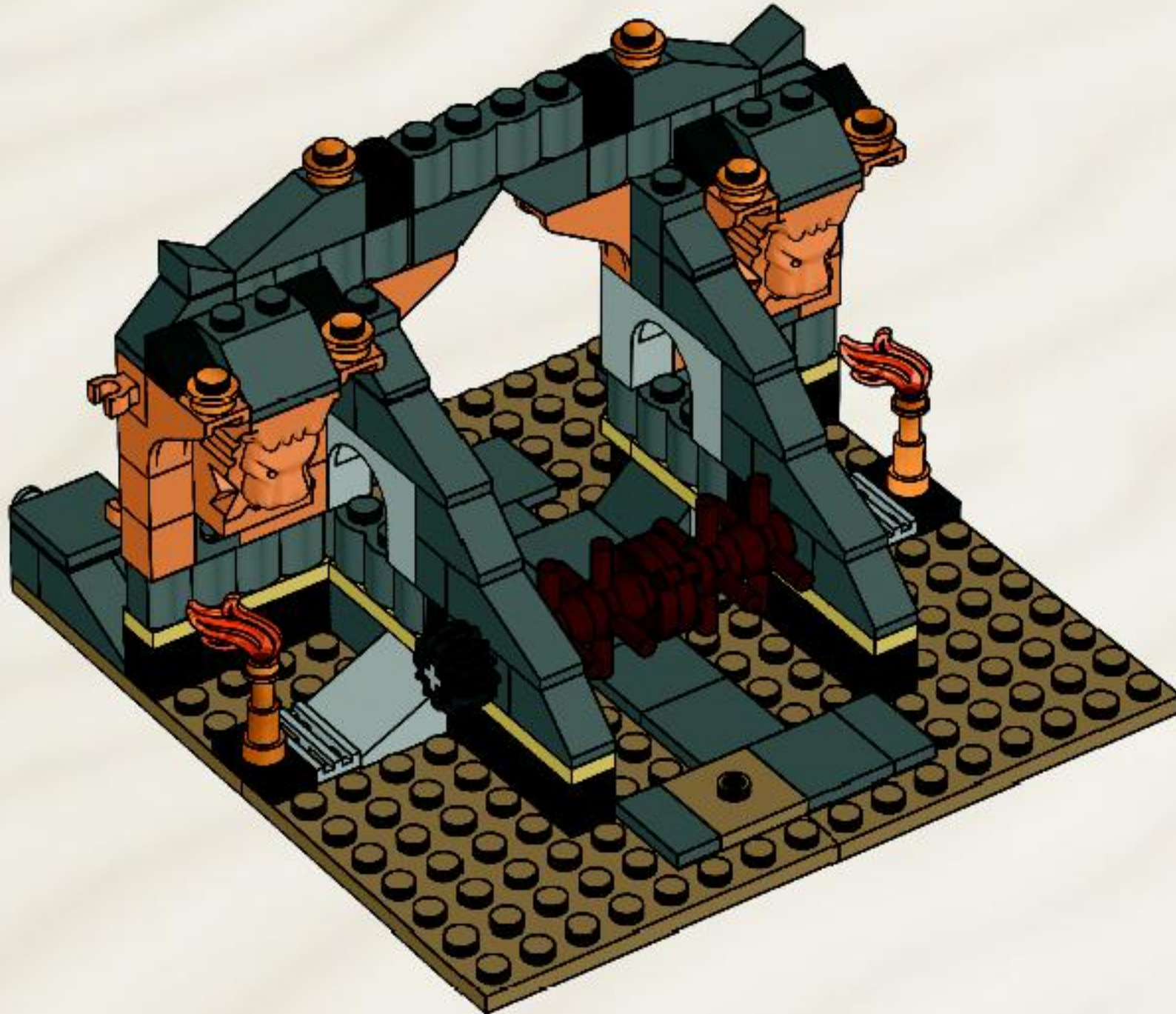

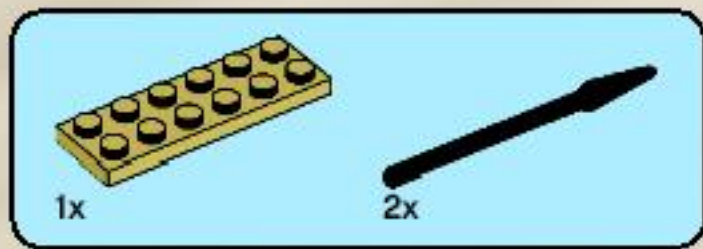

30



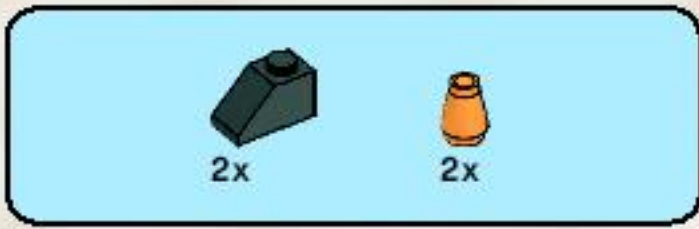

31

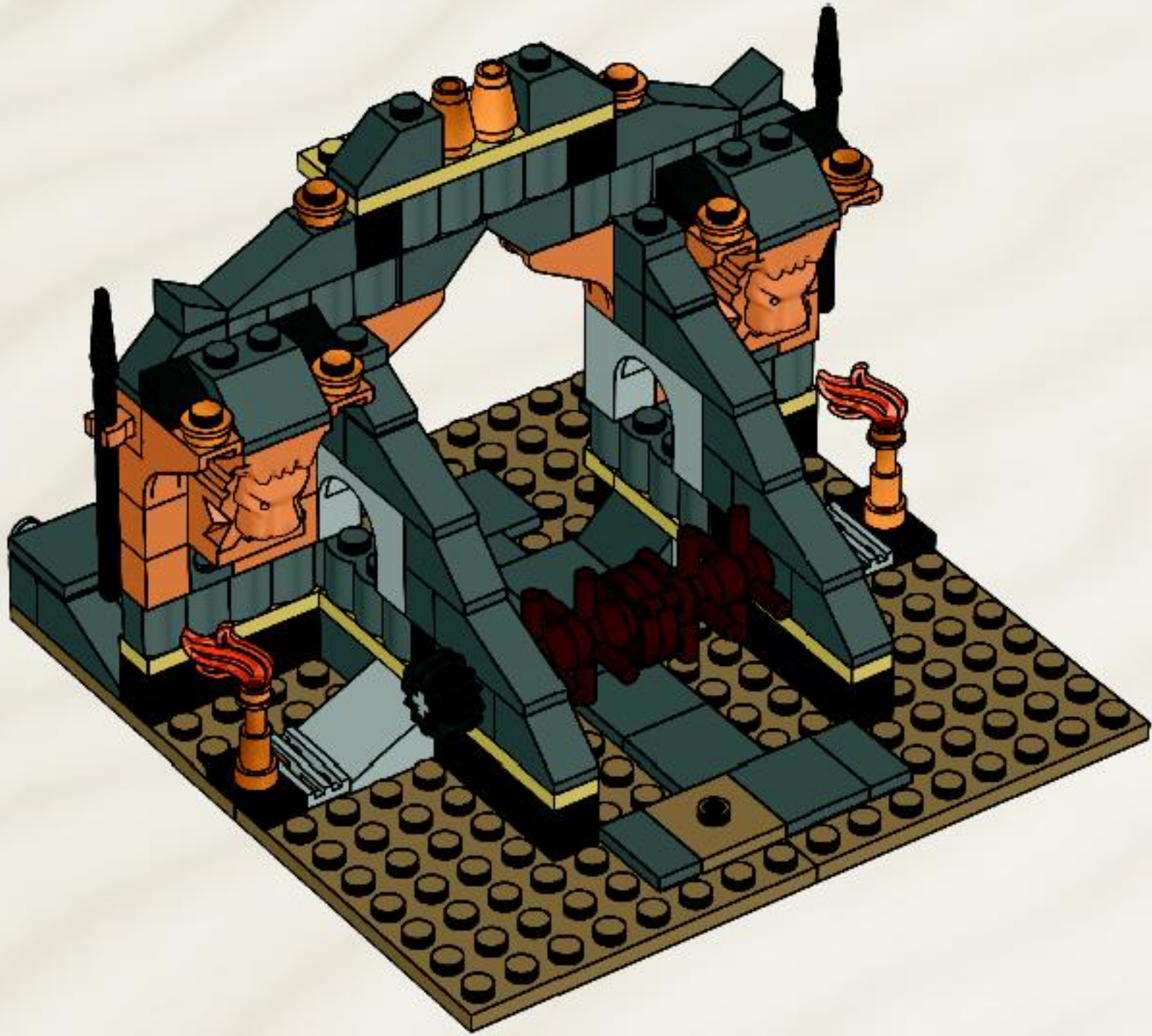

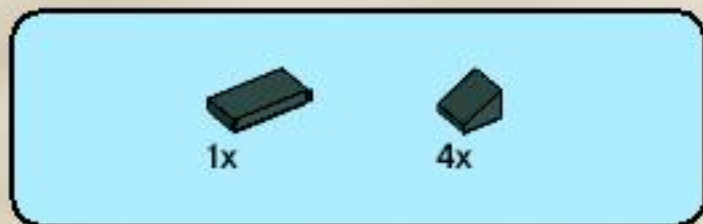

32



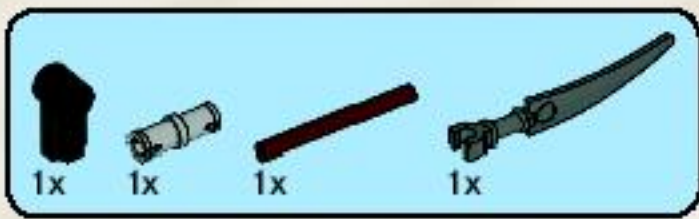

33

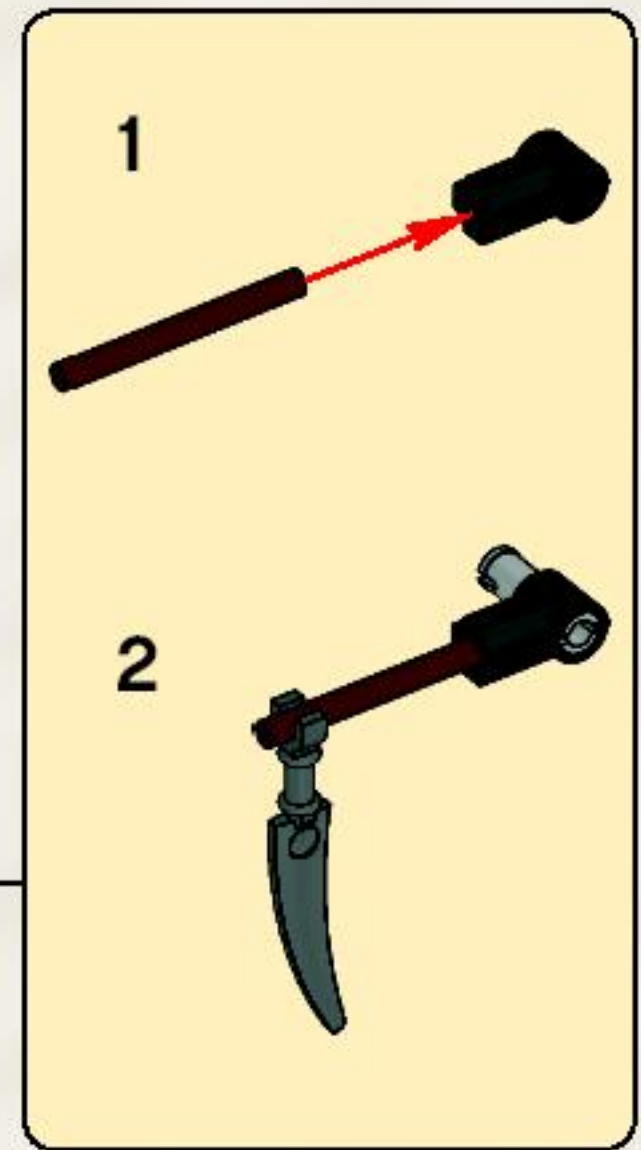



3

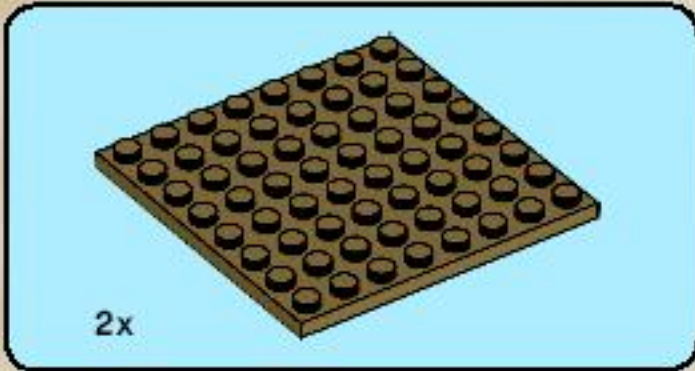
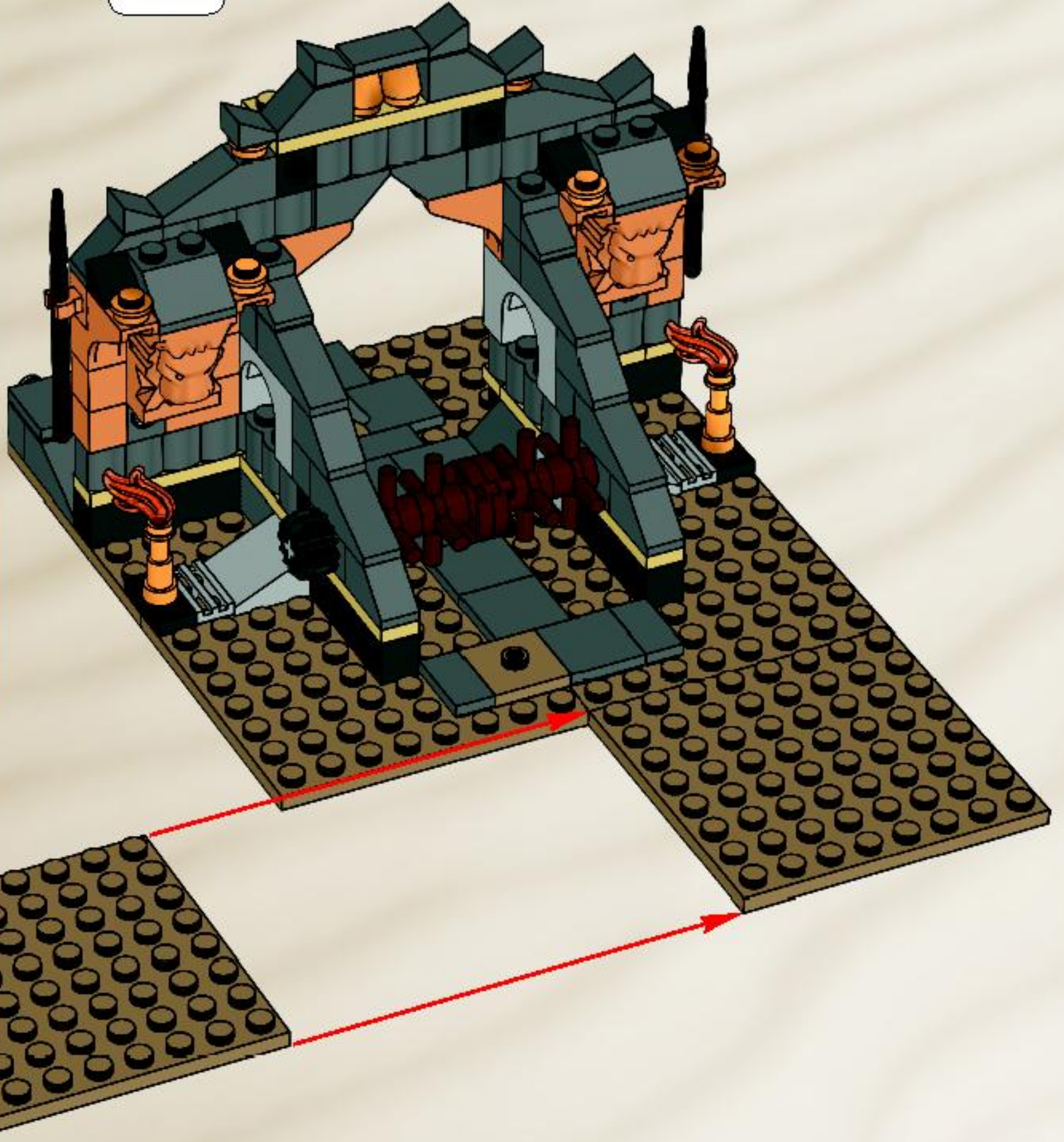

2x

34

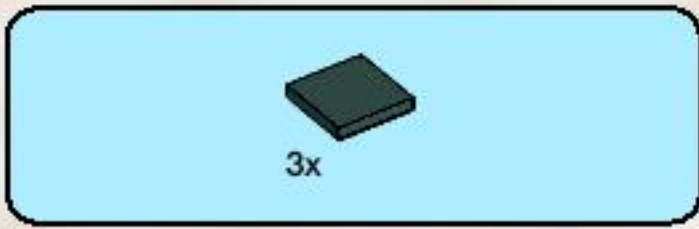

35



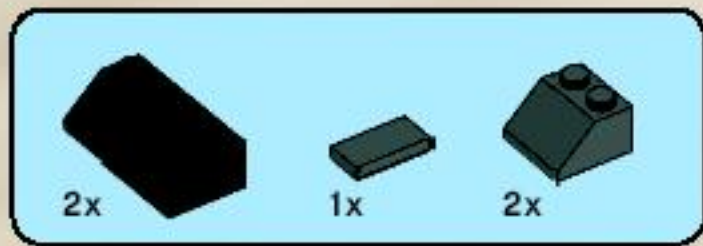

36

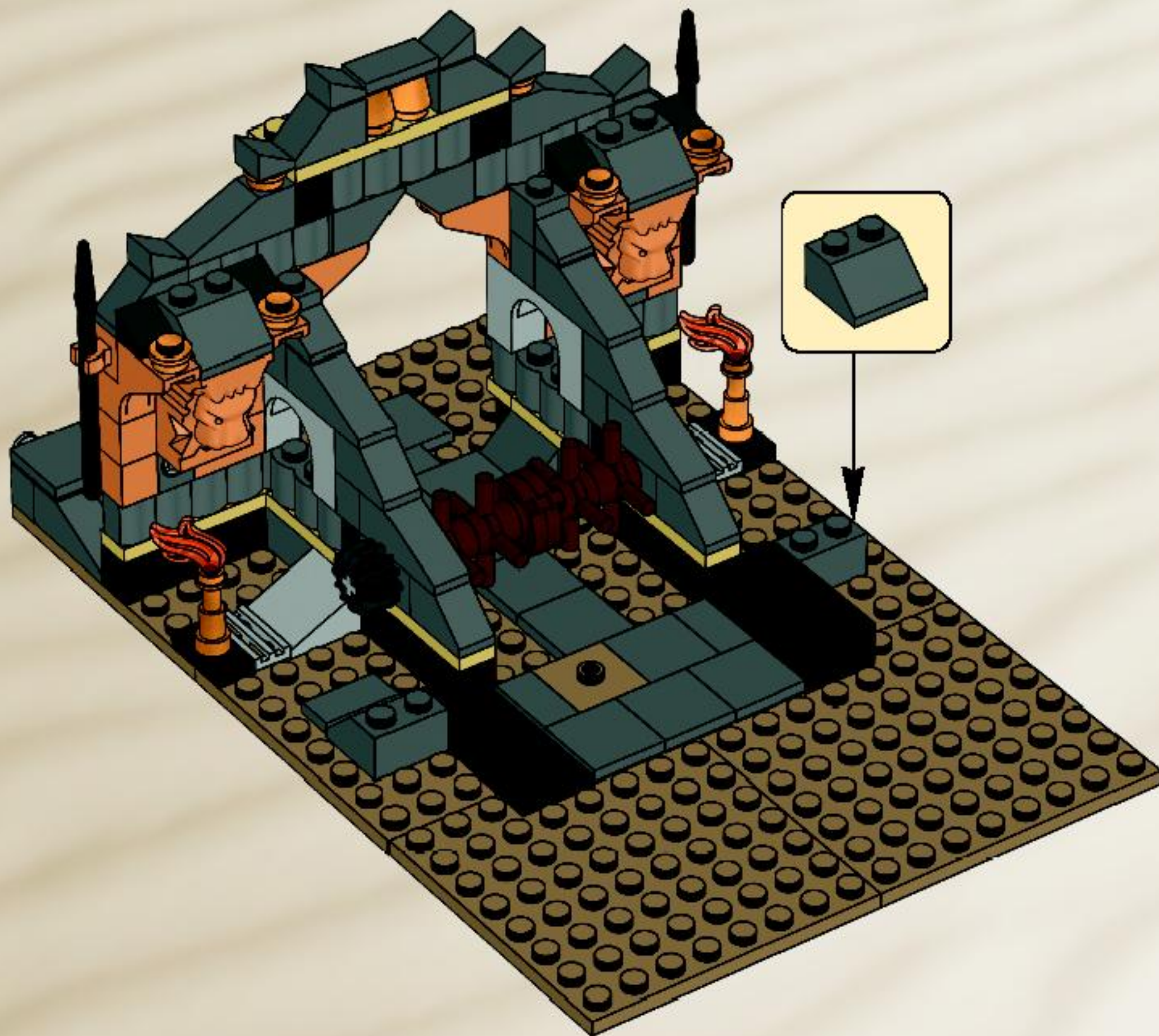

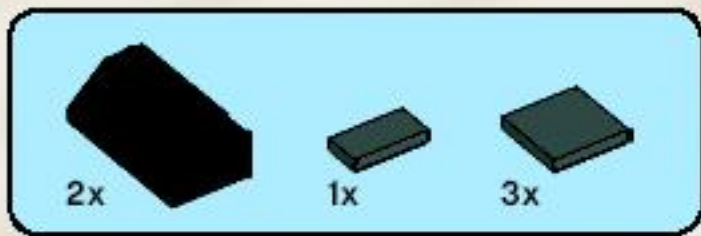

37



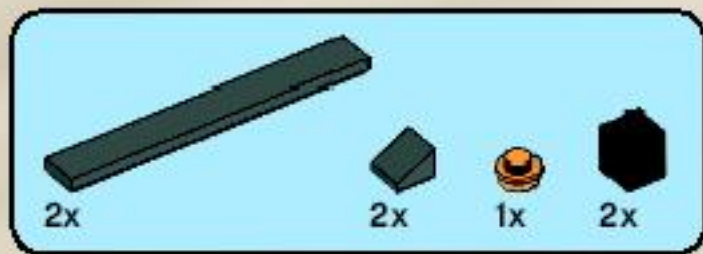

38

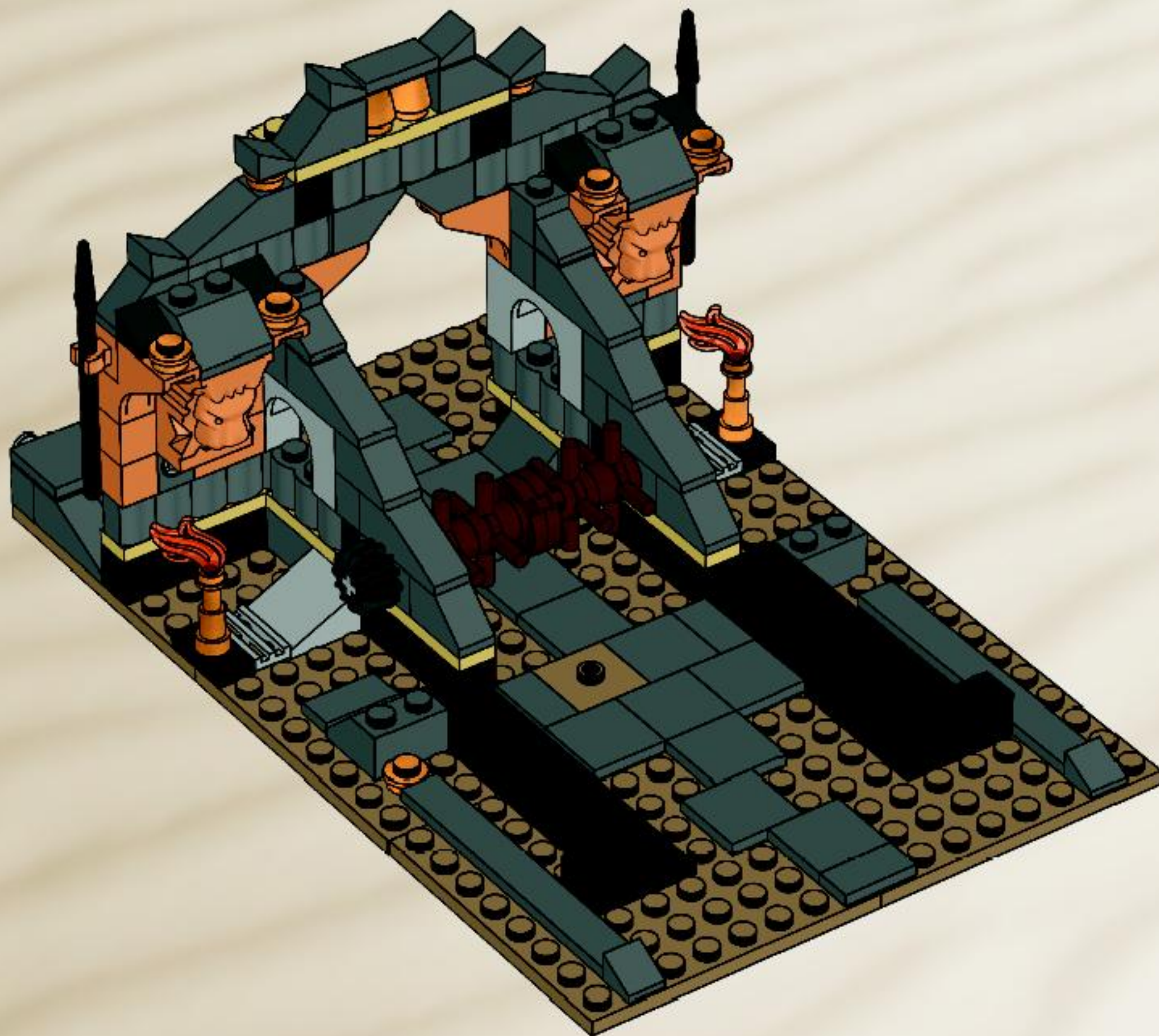

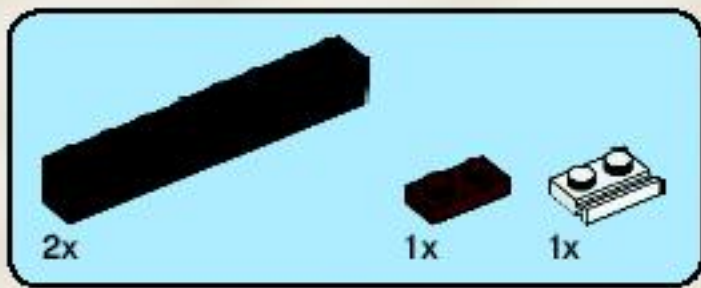

39

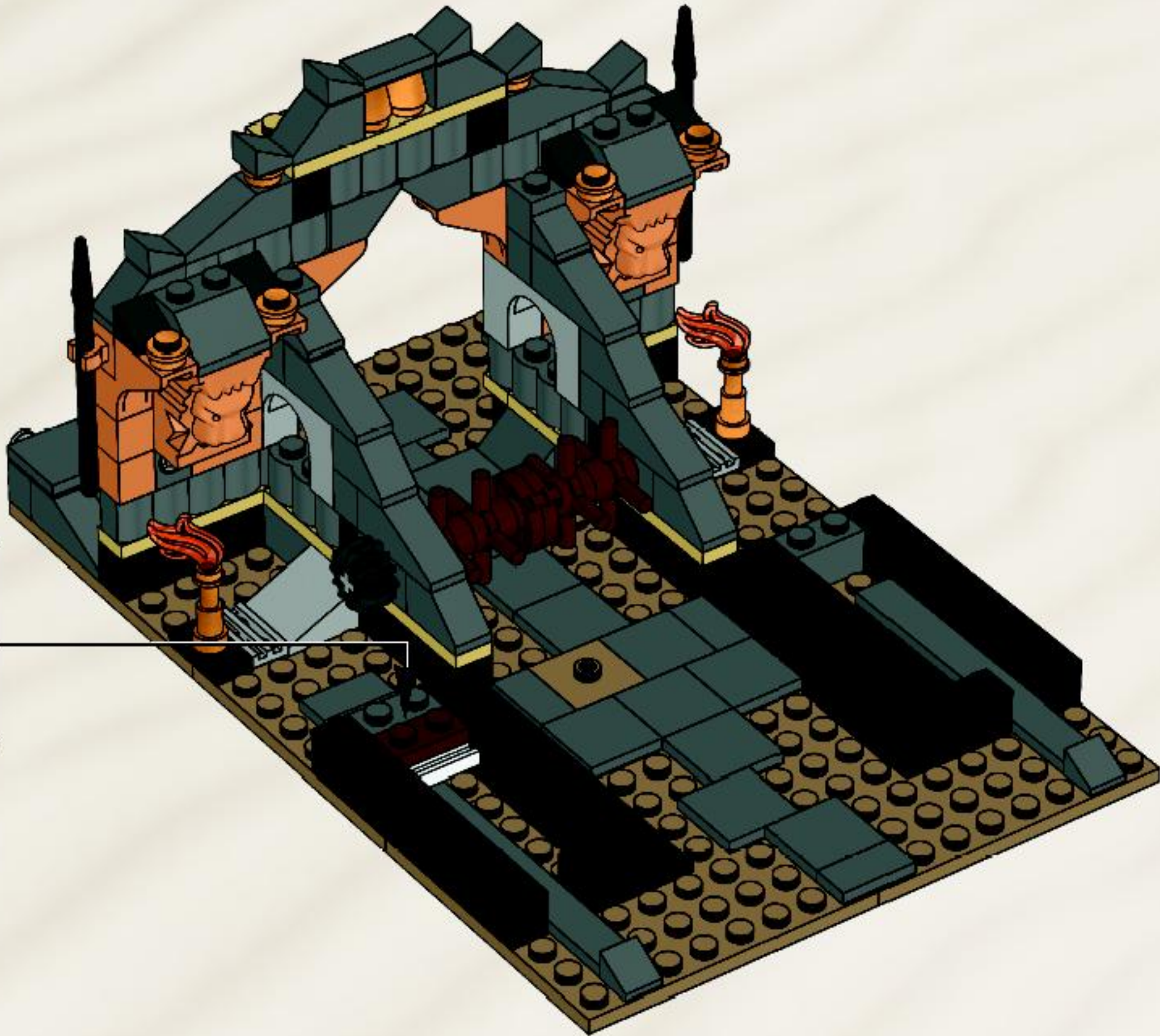

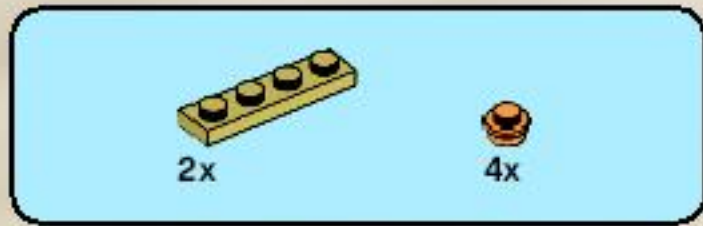

40

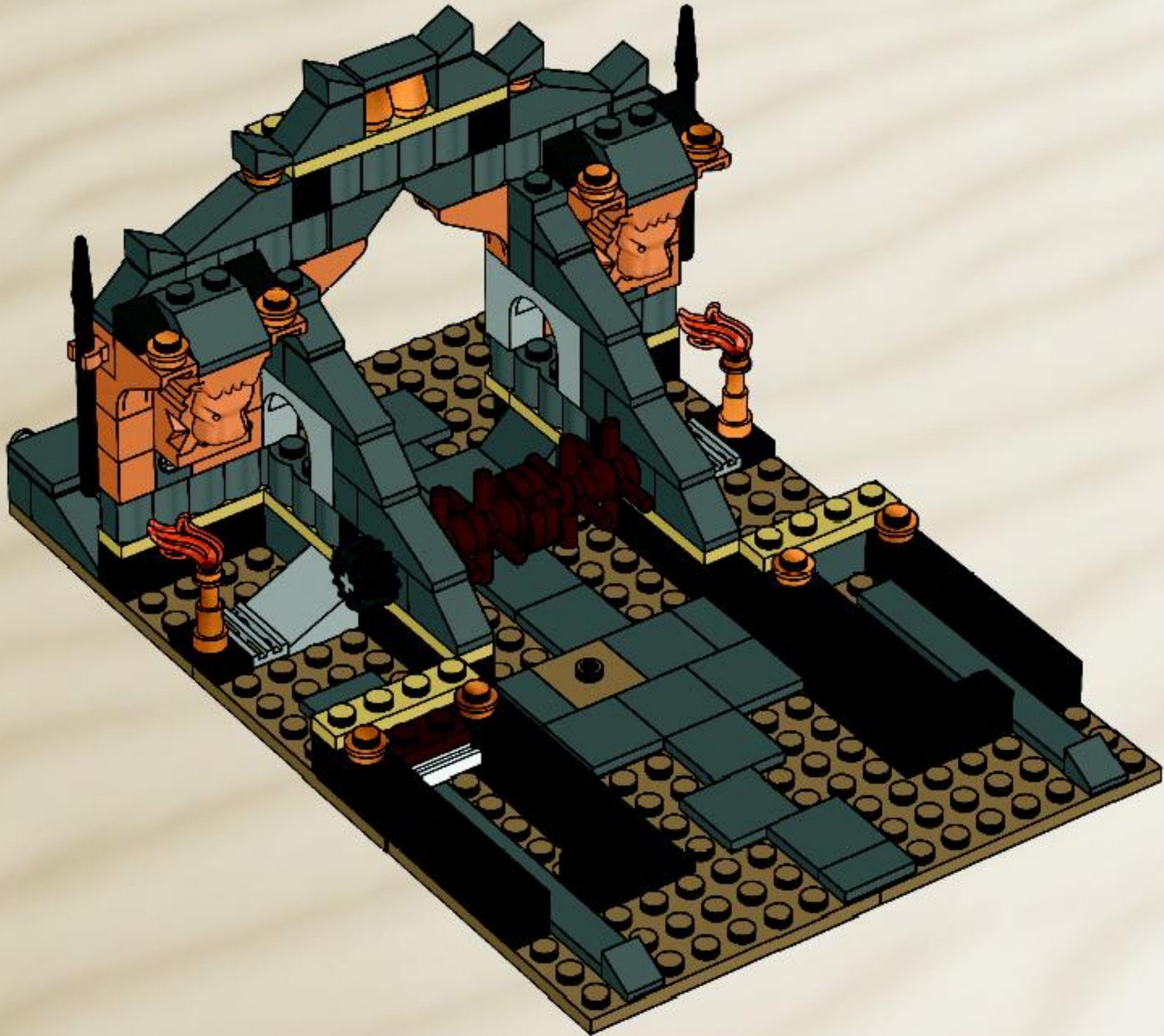

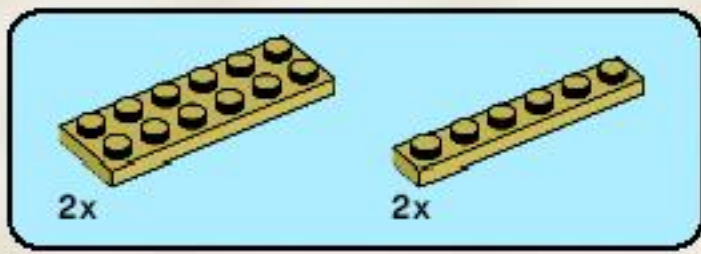

41

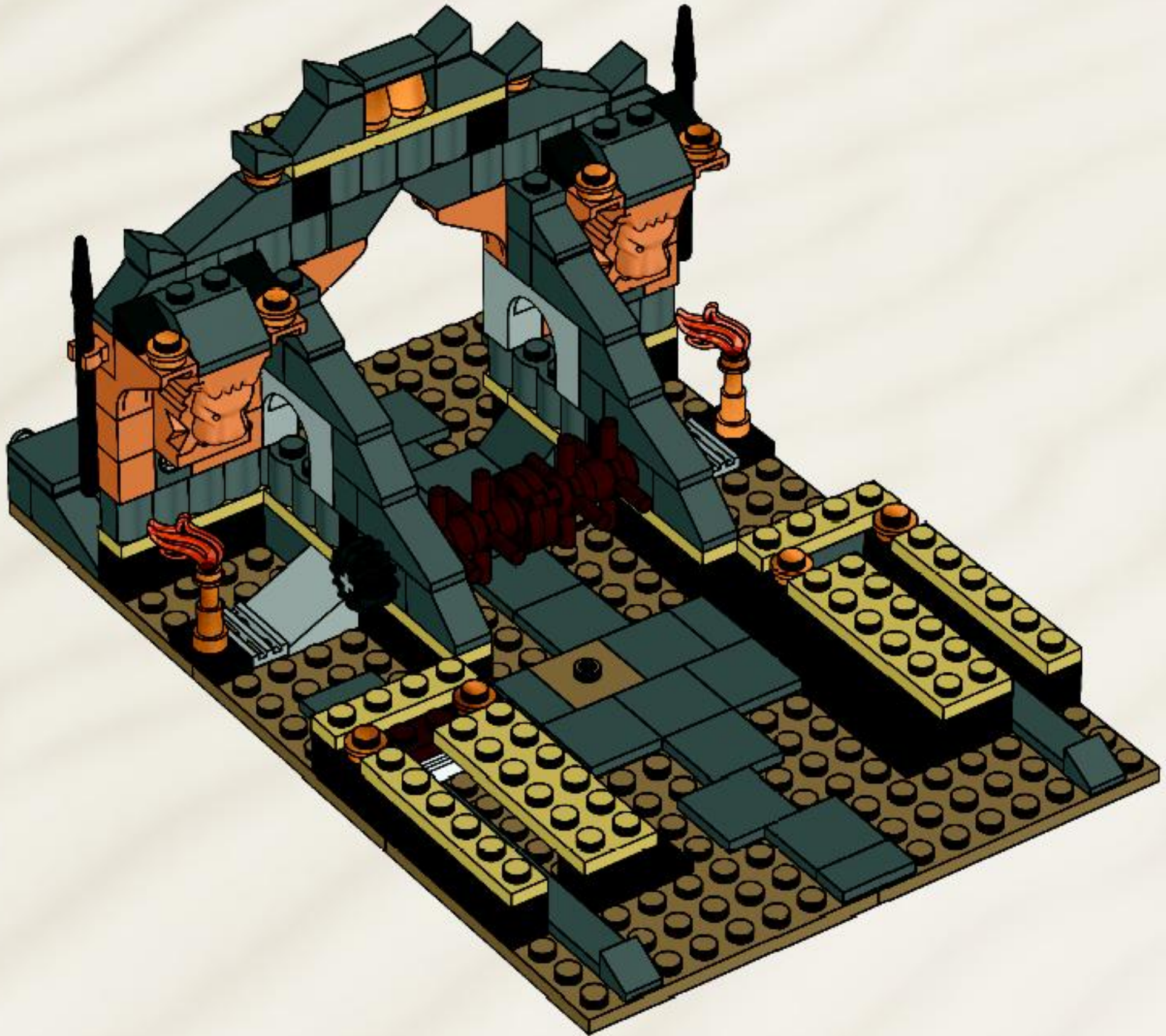

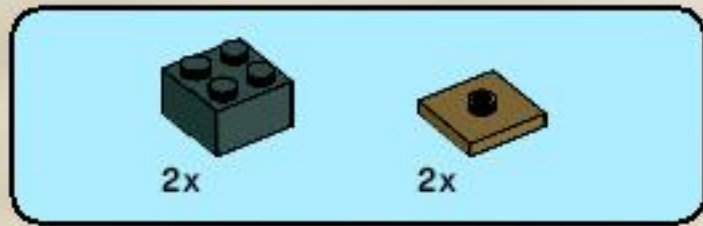

42

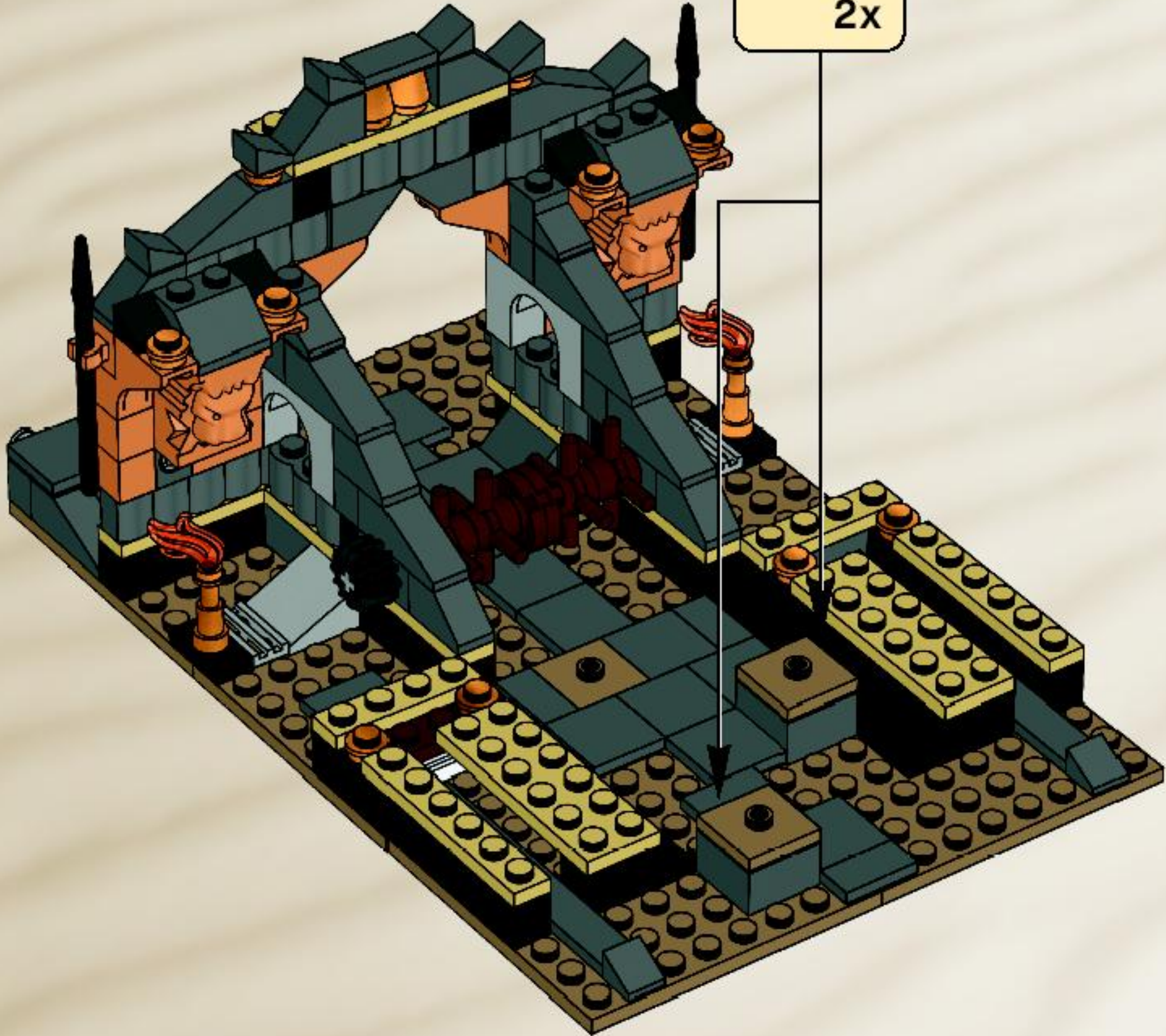
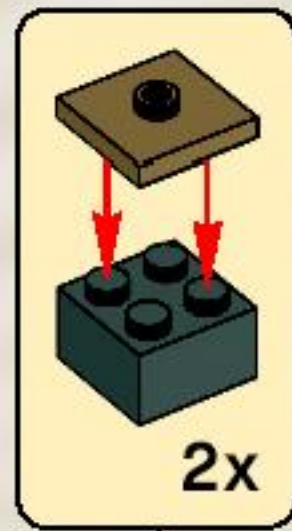

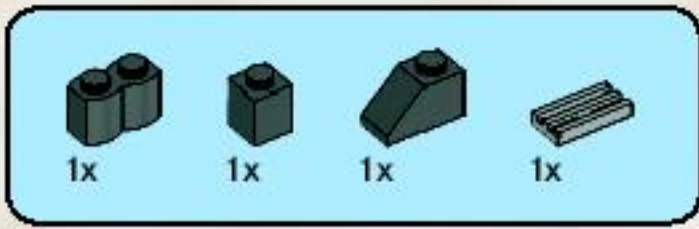

43

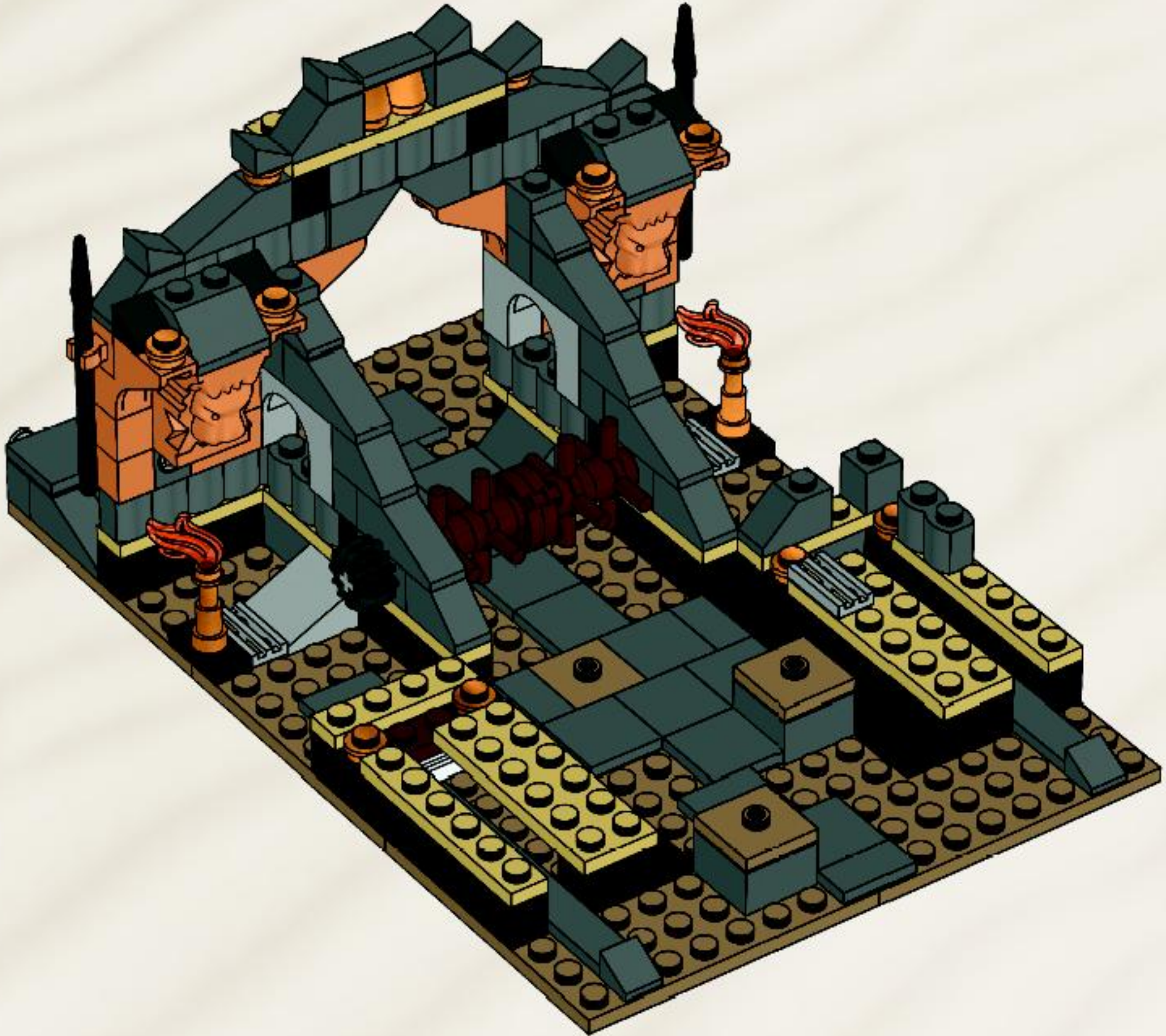

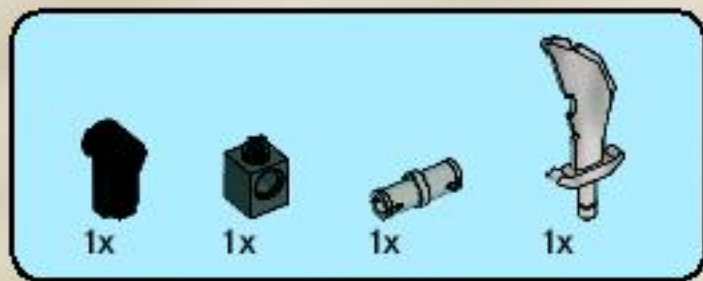

44

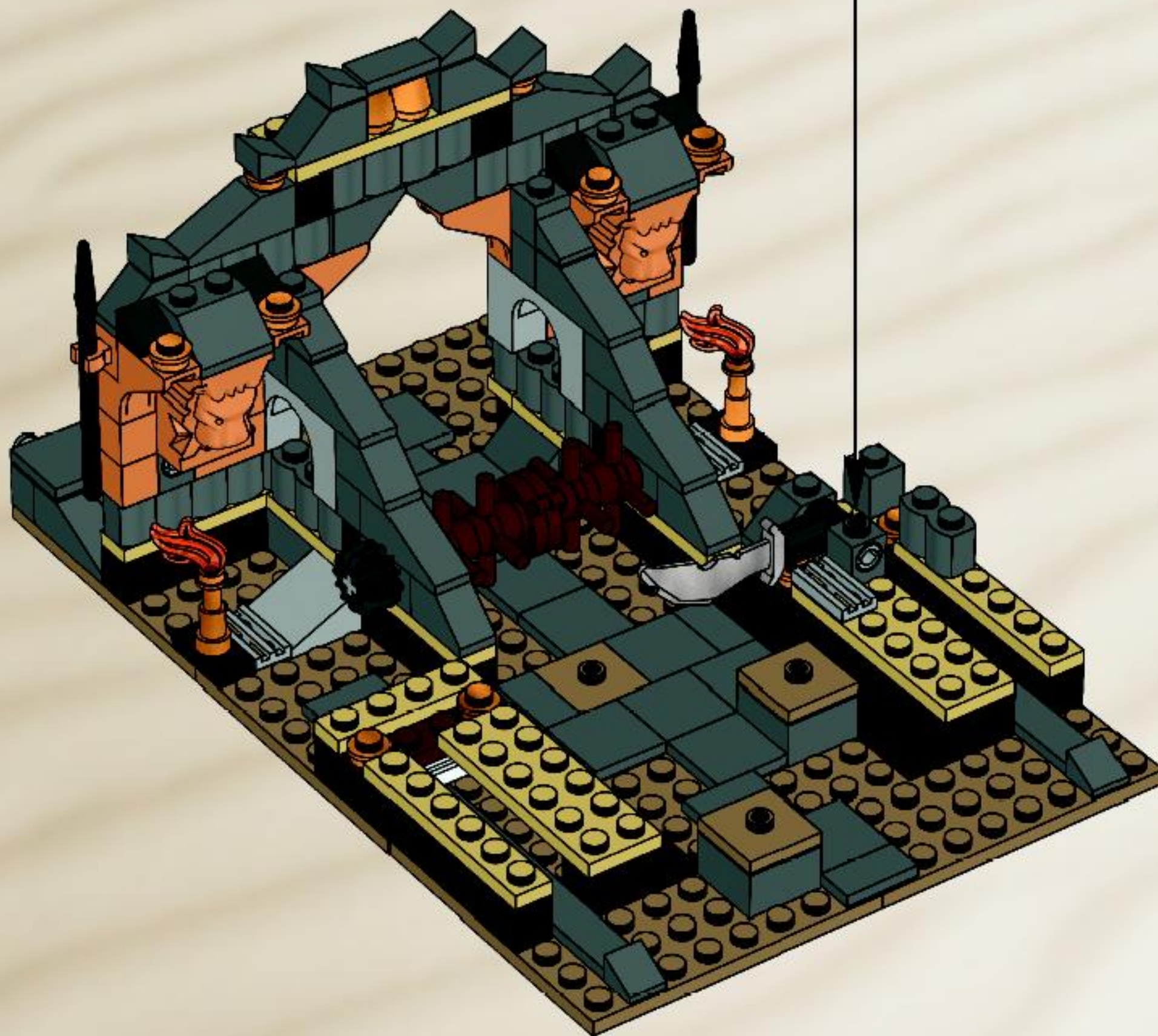
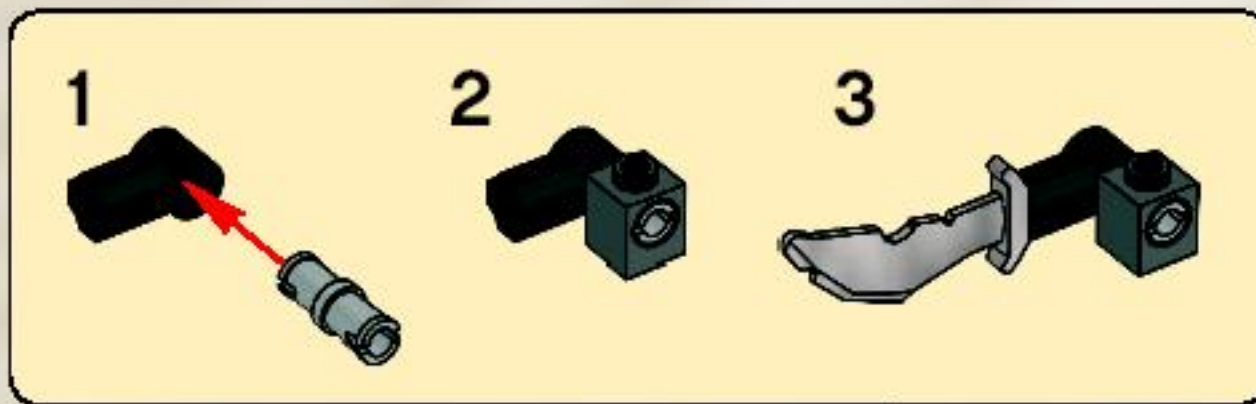

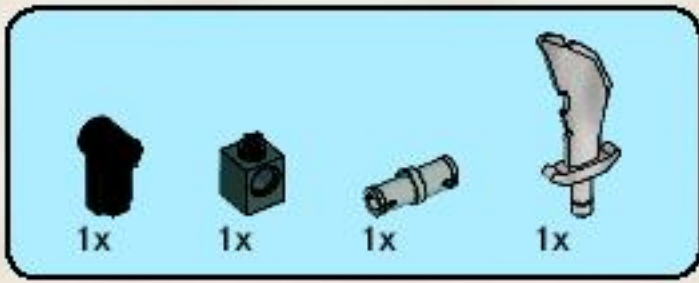

45

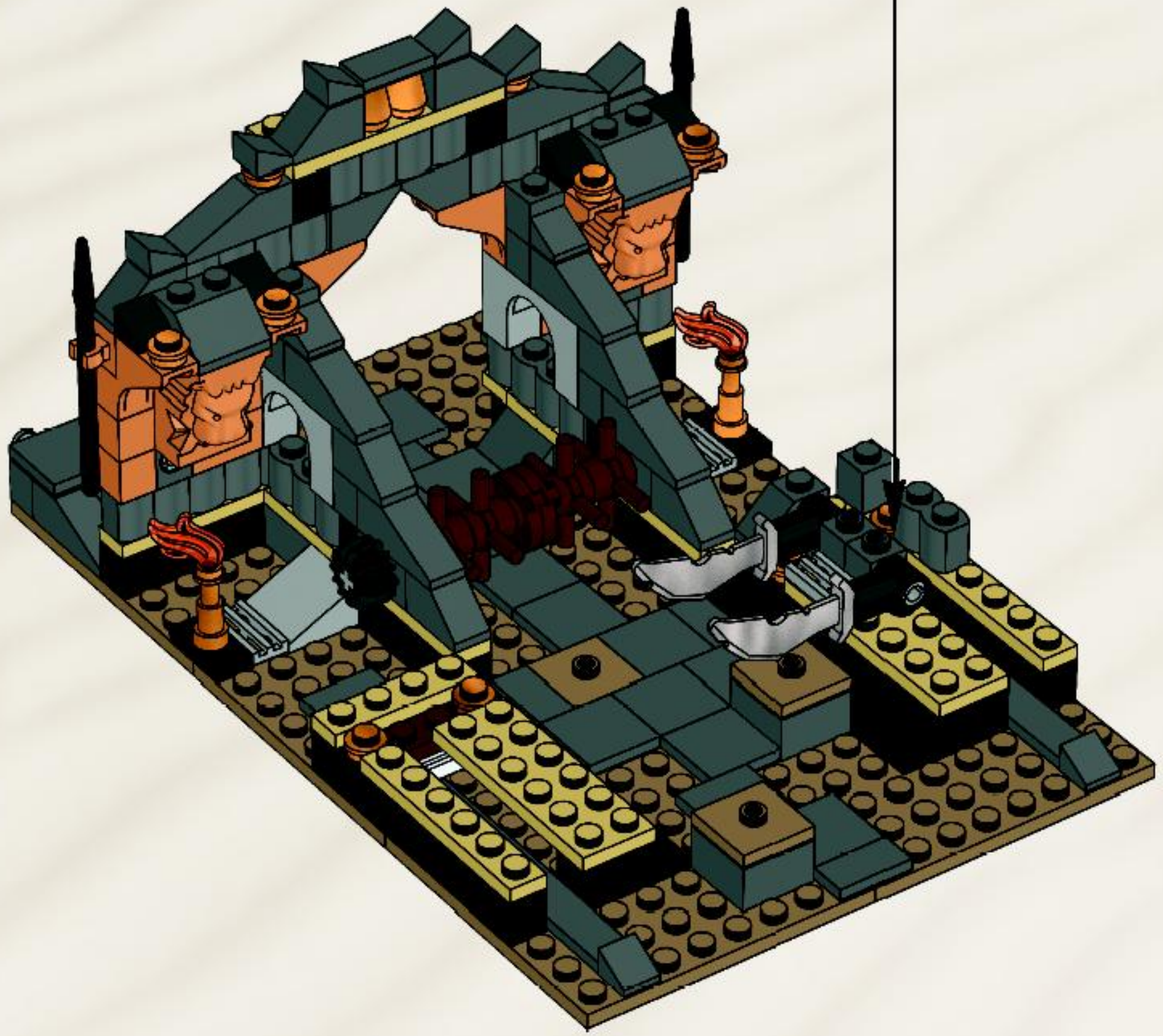
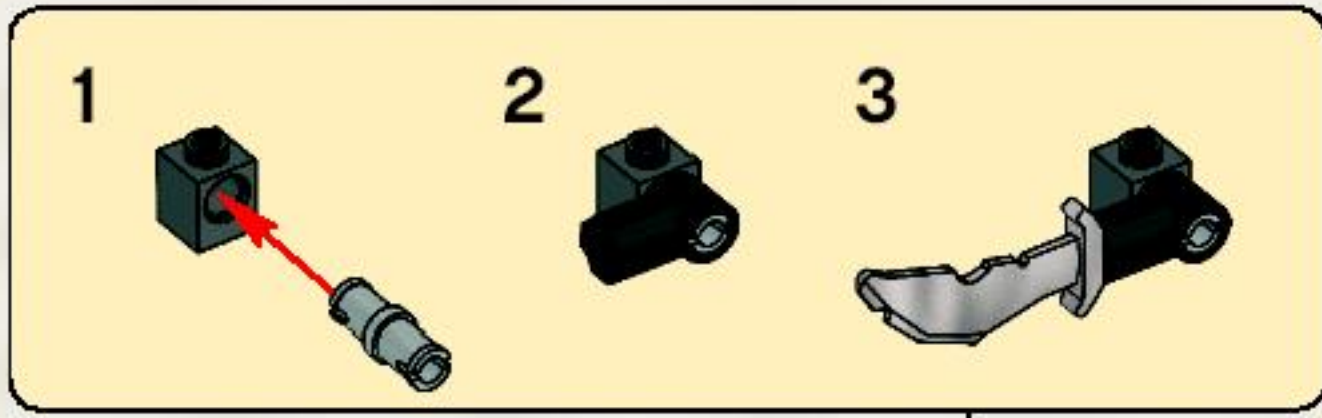

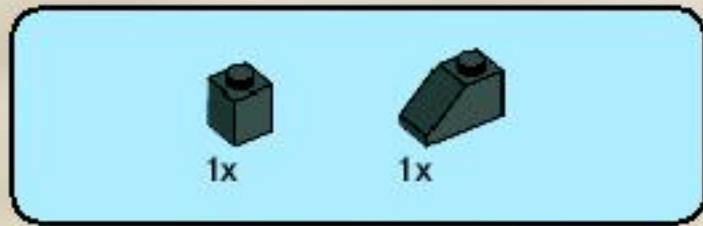

46

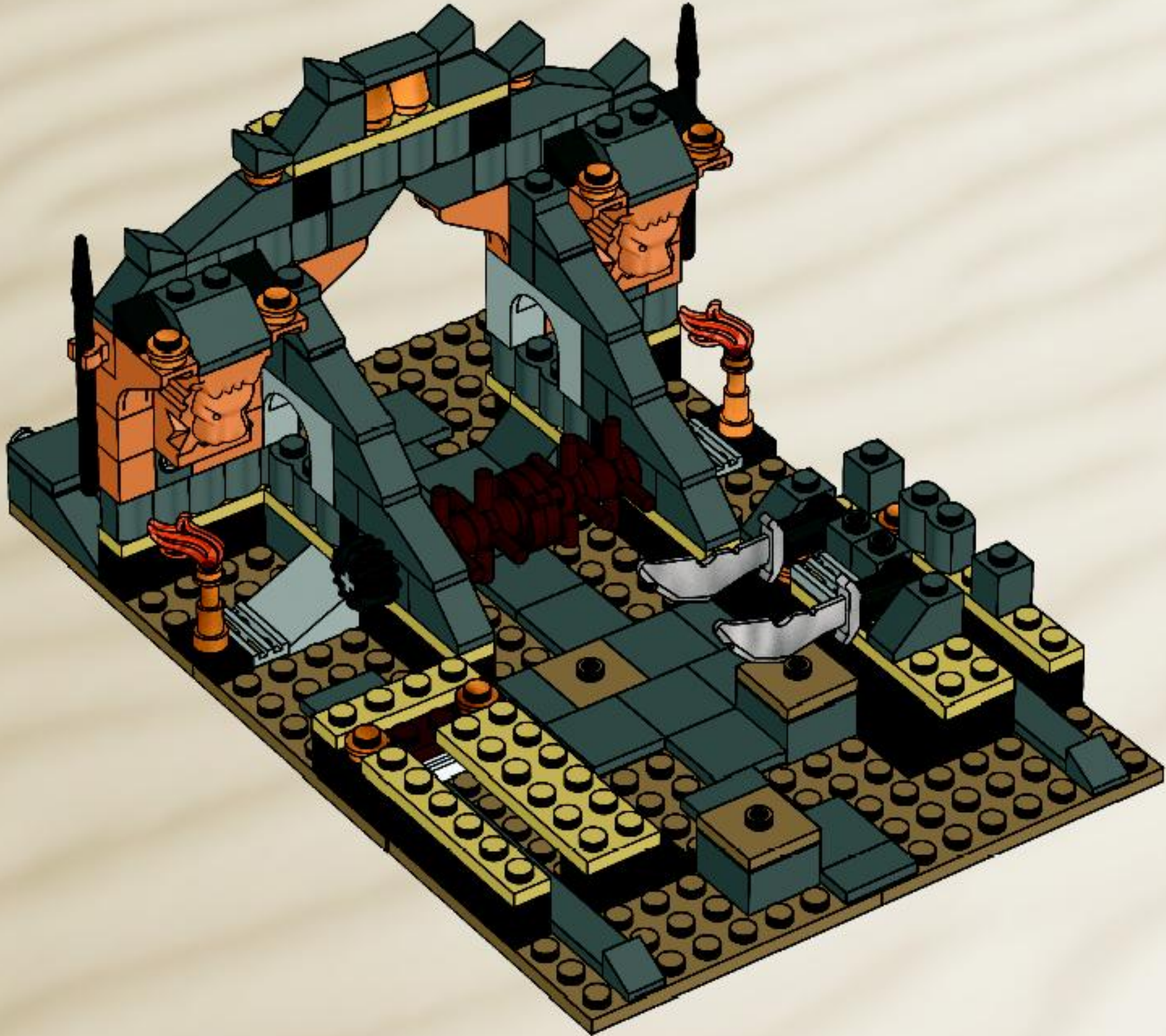

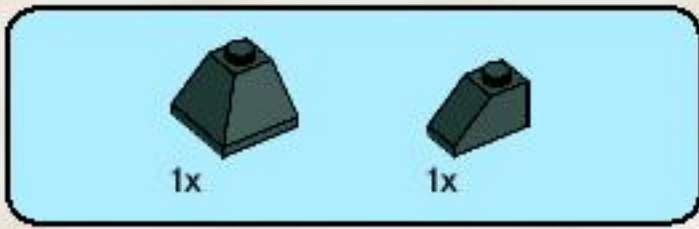

47

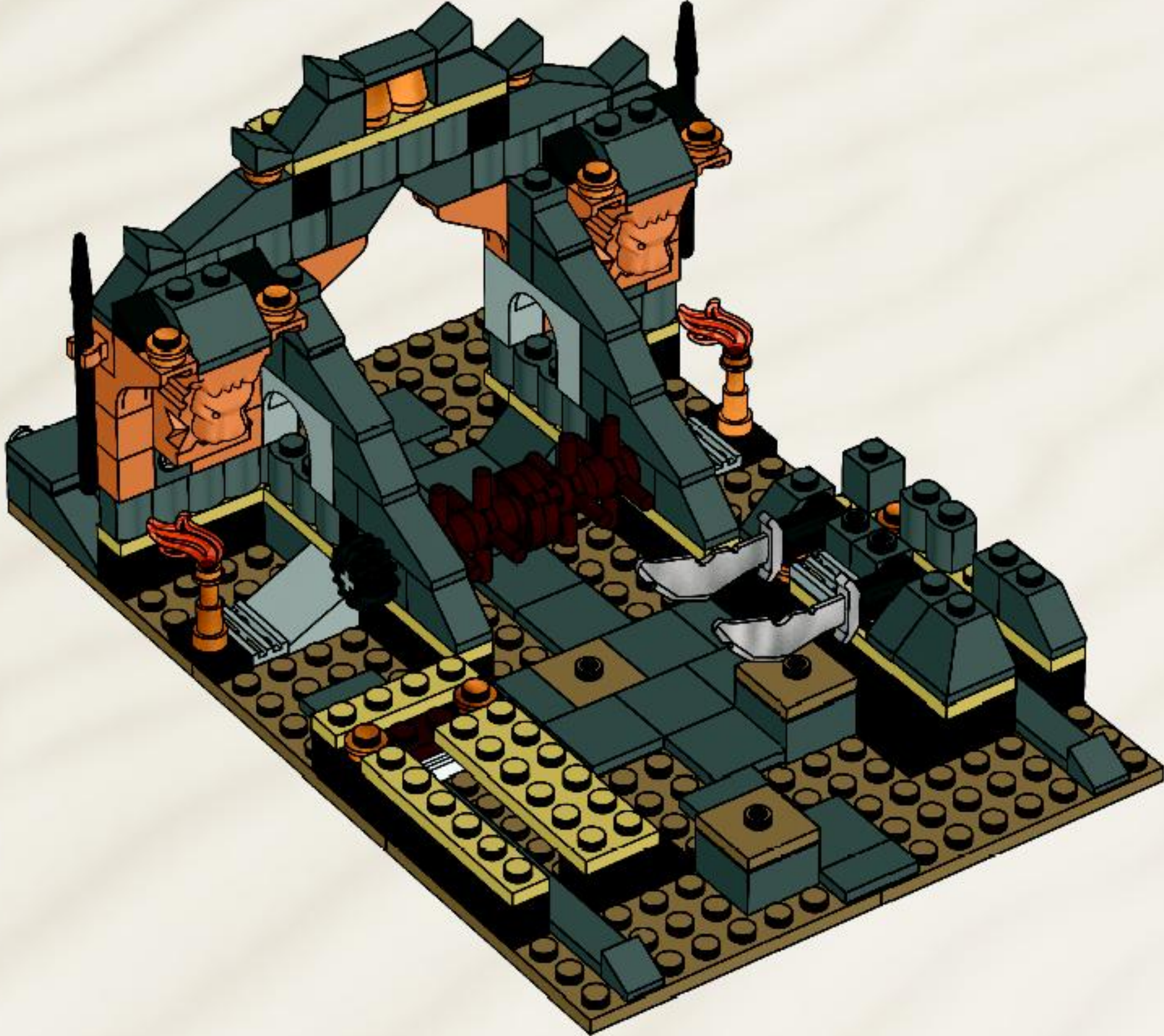

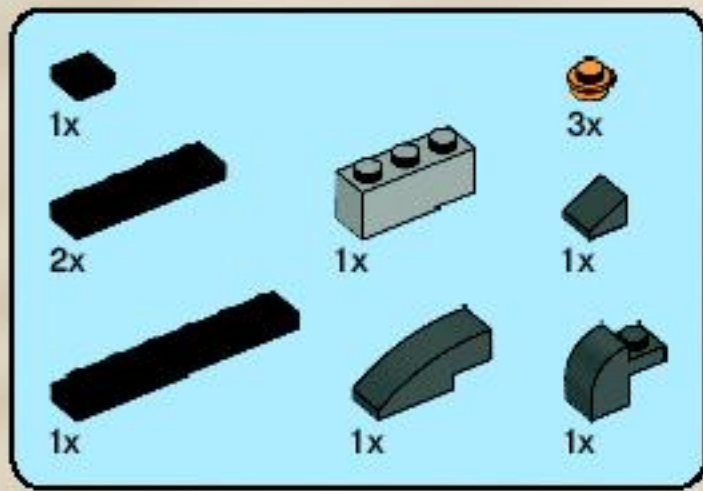

48

1



2

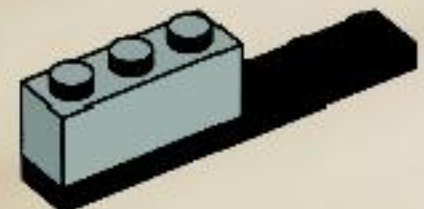

3



4



5

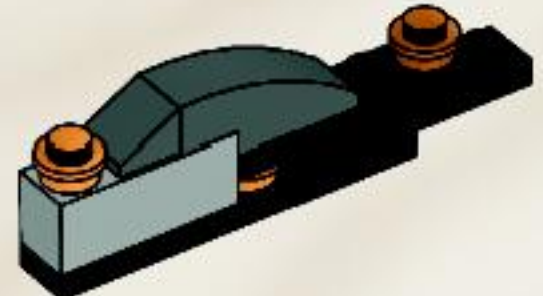

6

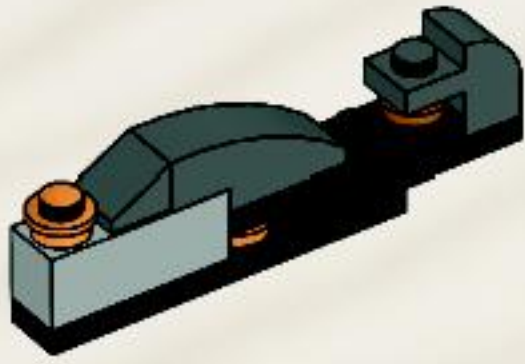

7

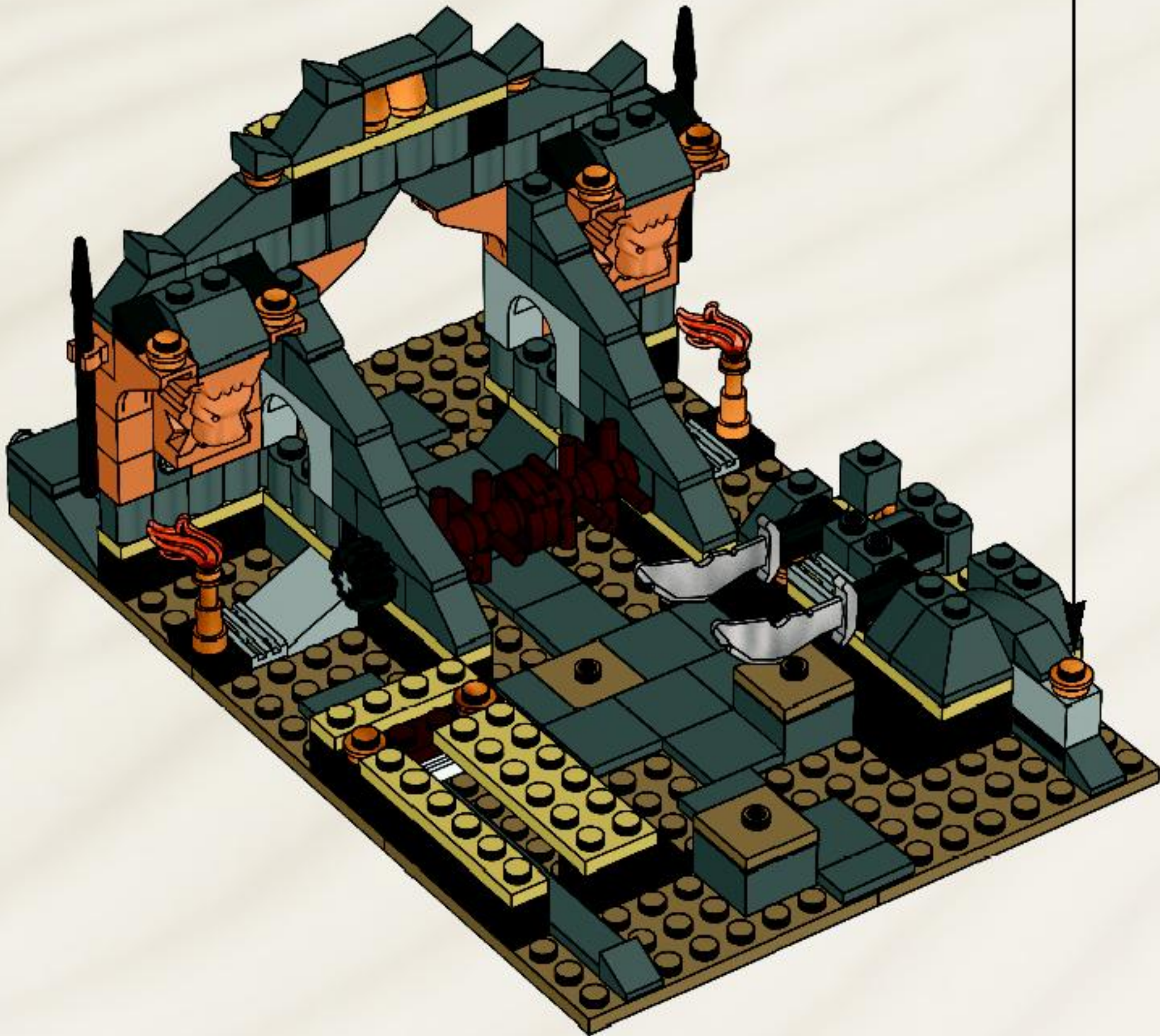
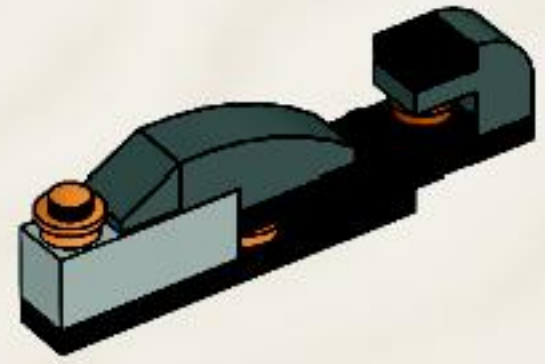

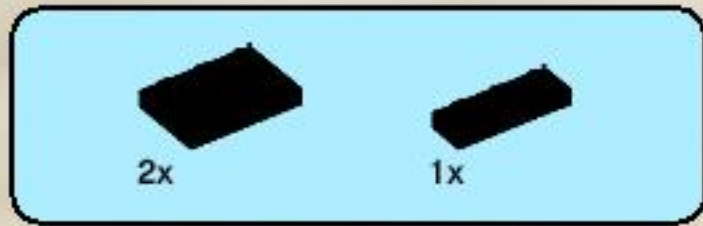

49

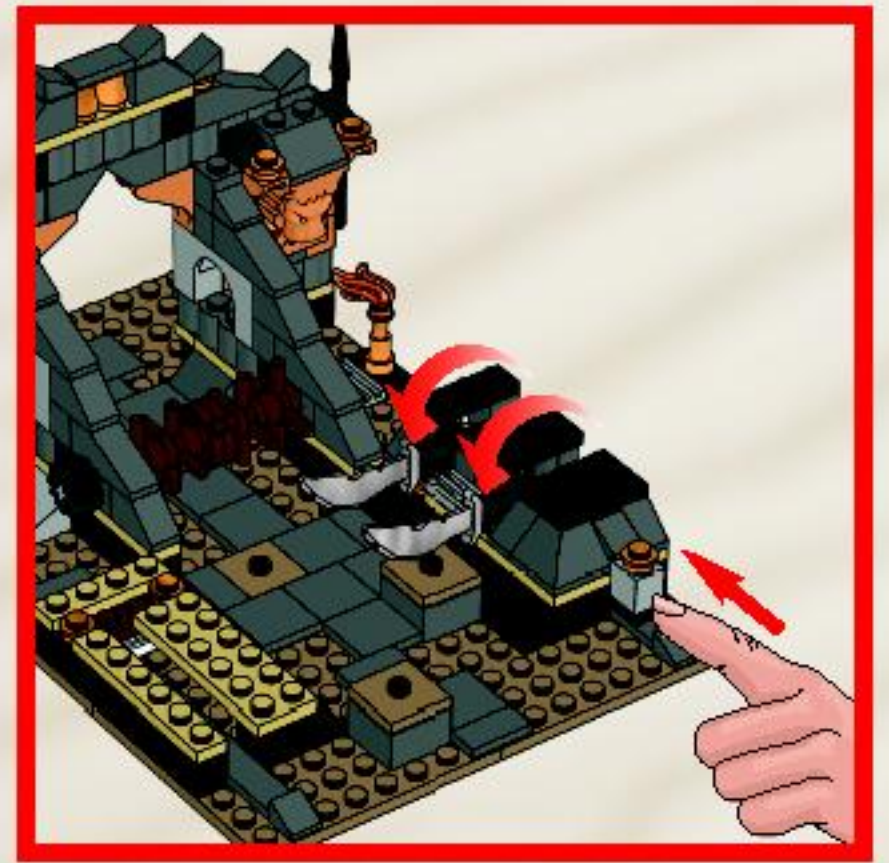
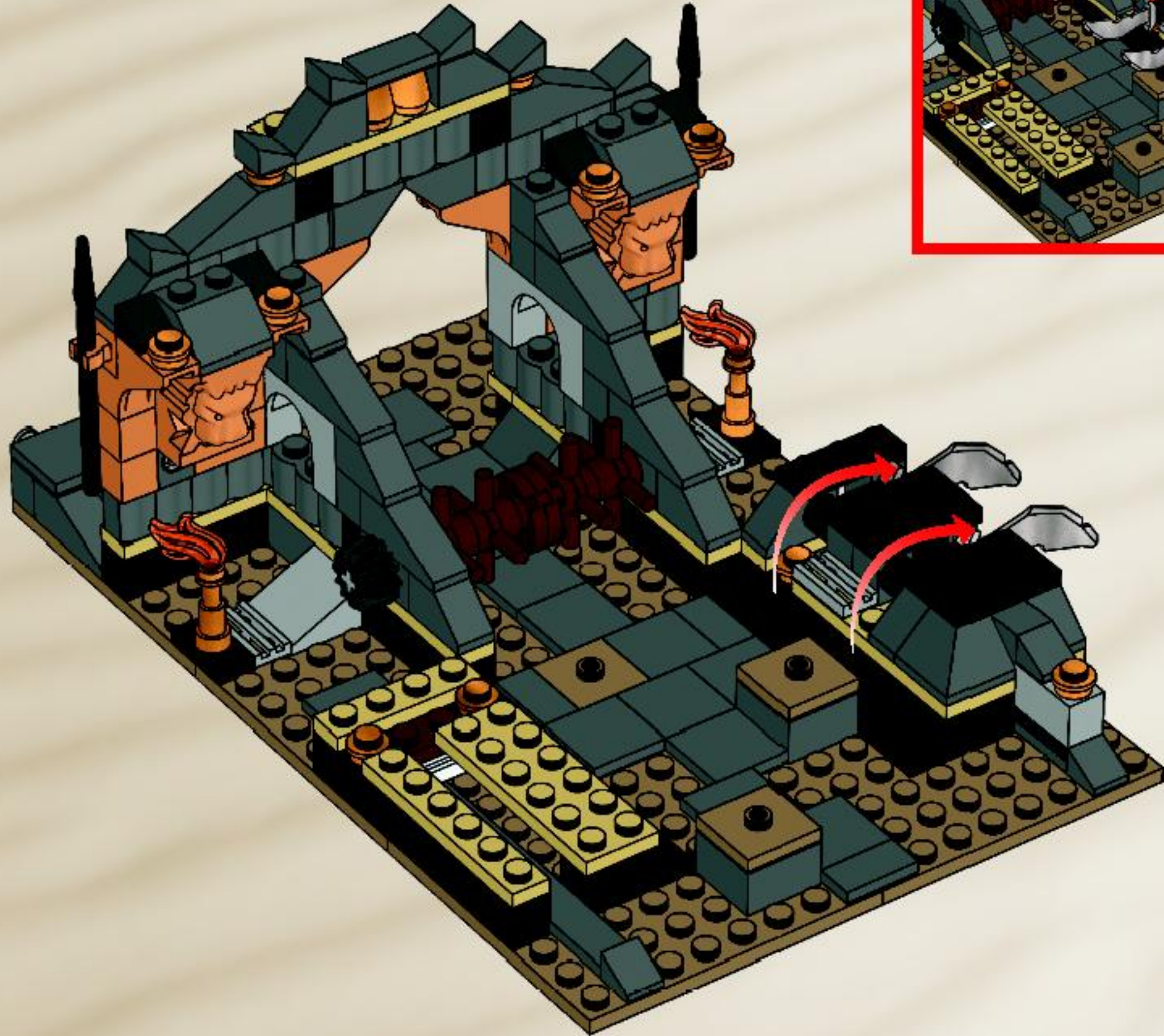

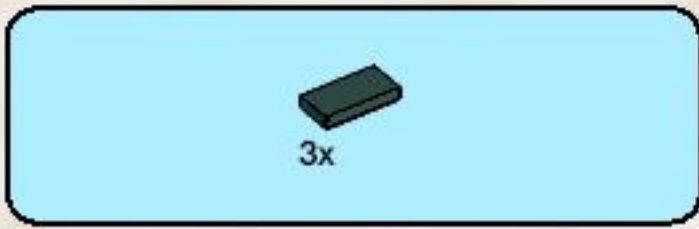

50

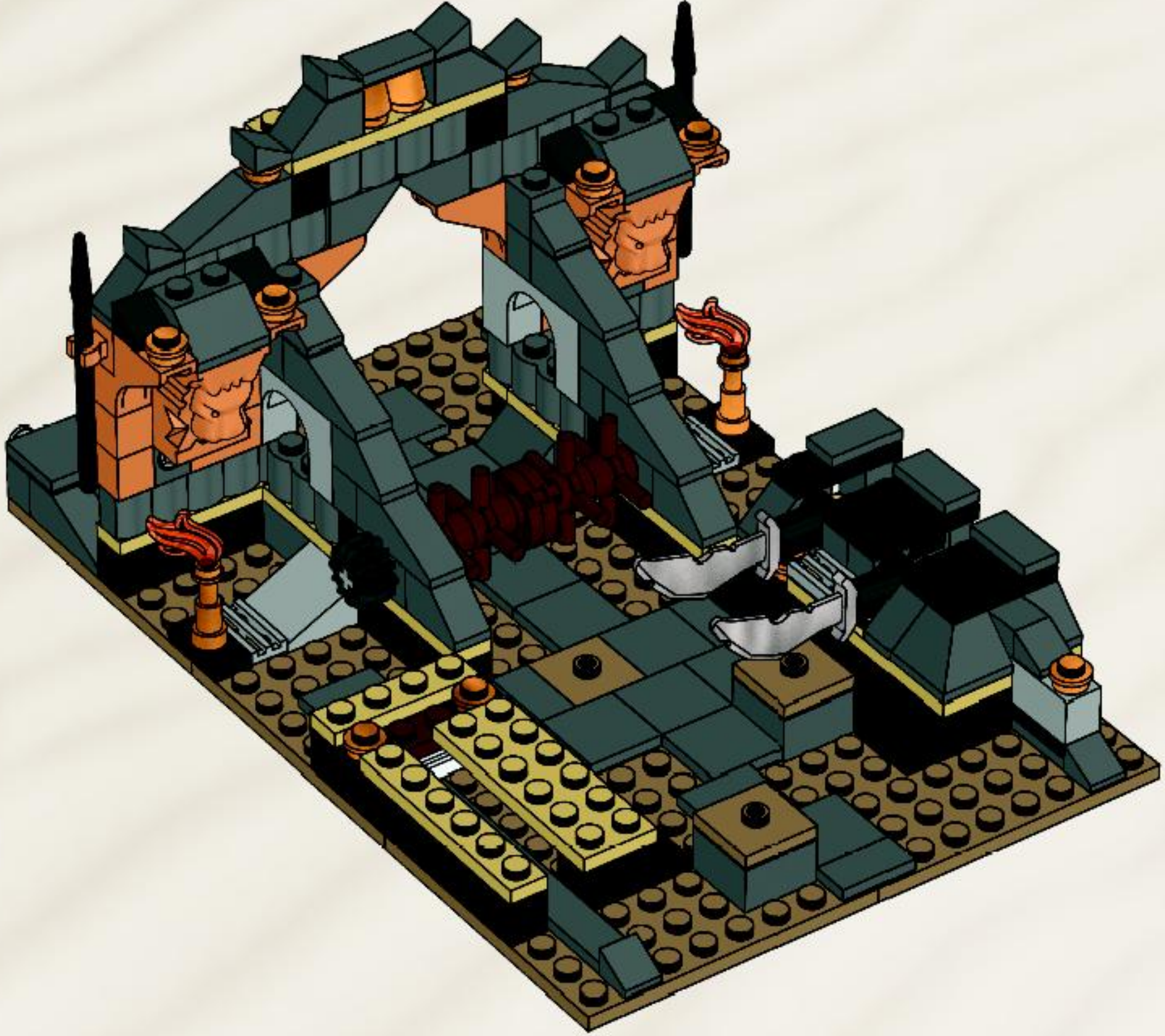

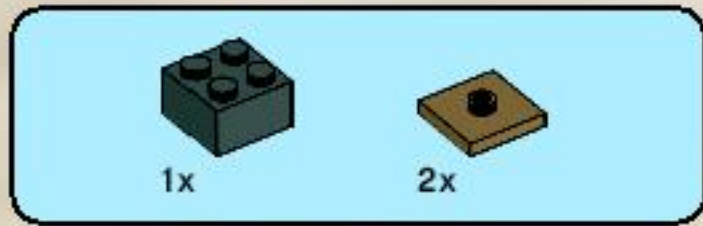

51

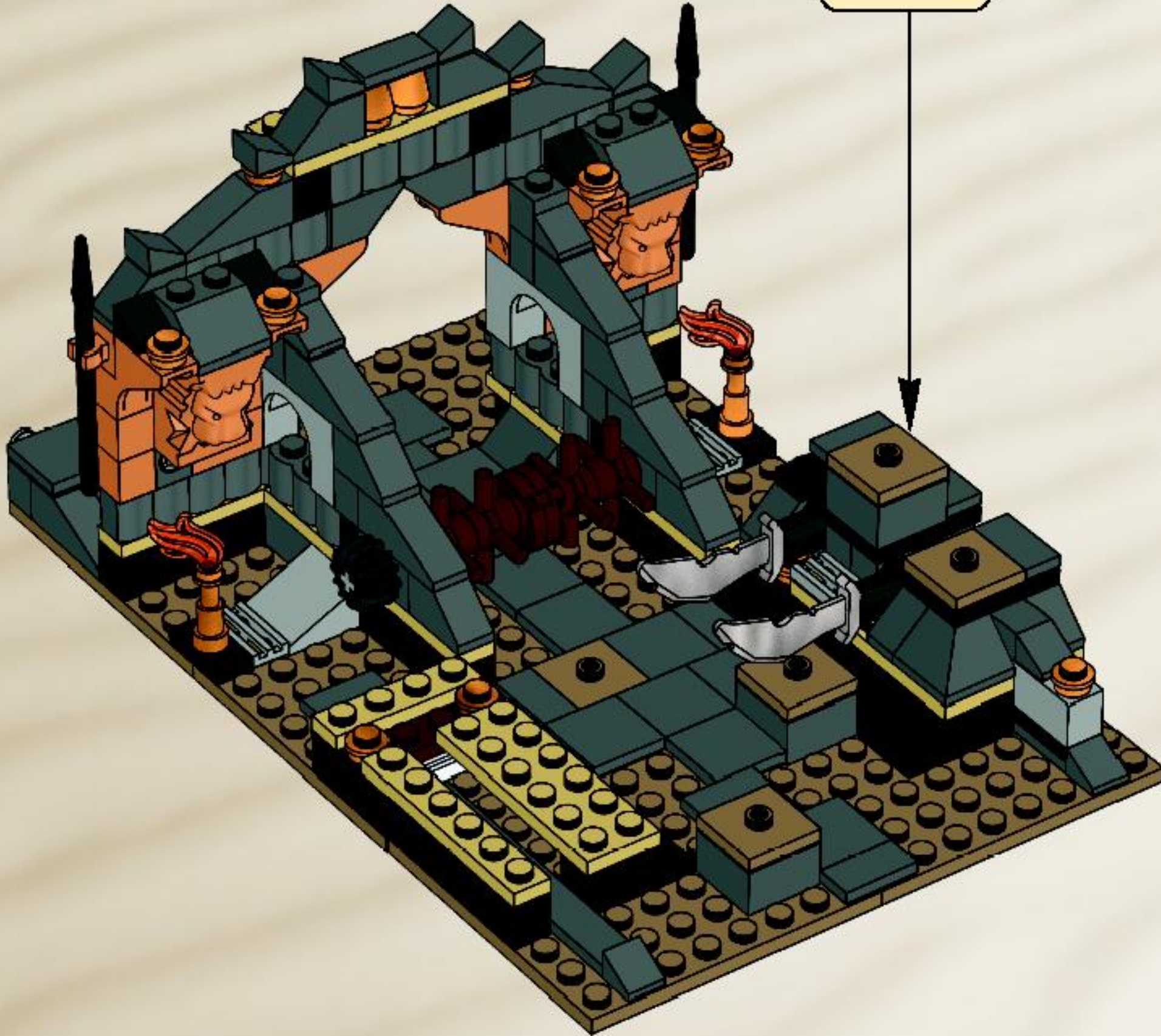
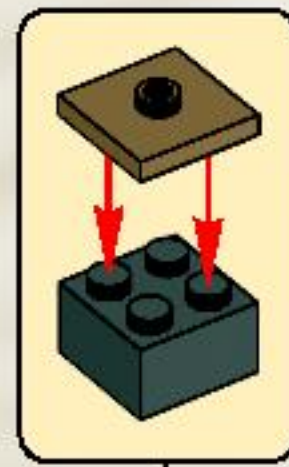

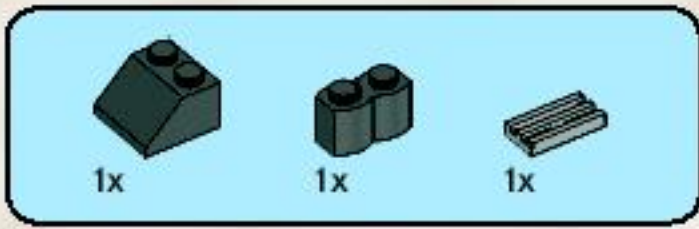

52

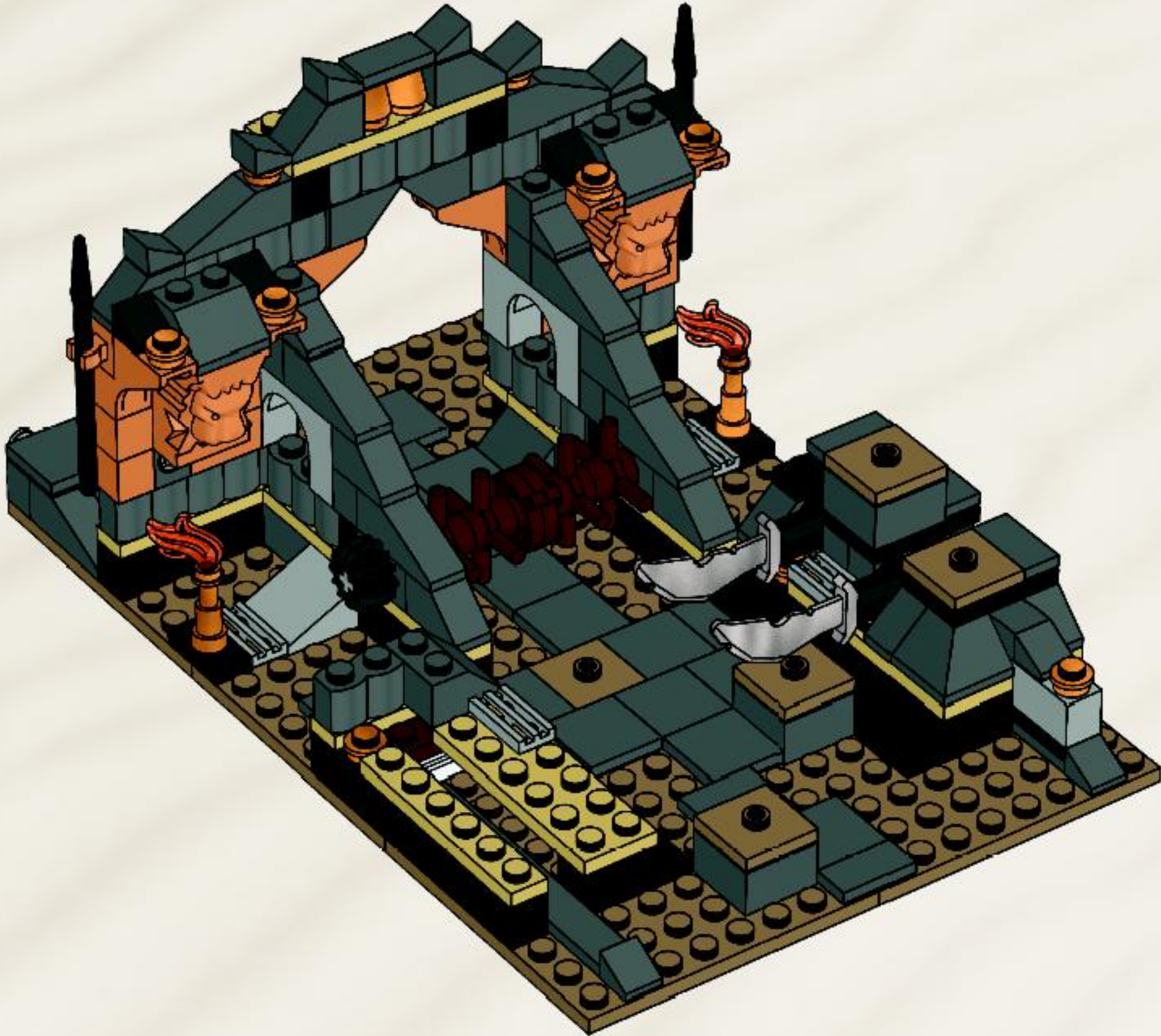

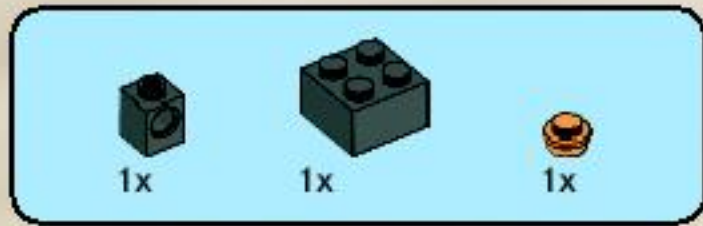

53



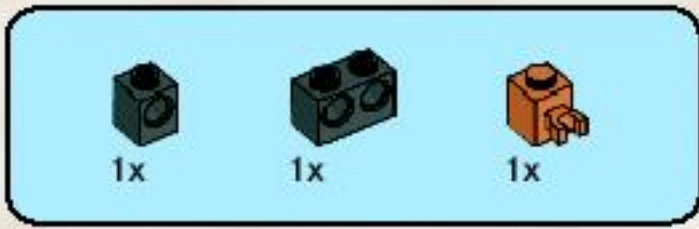

54



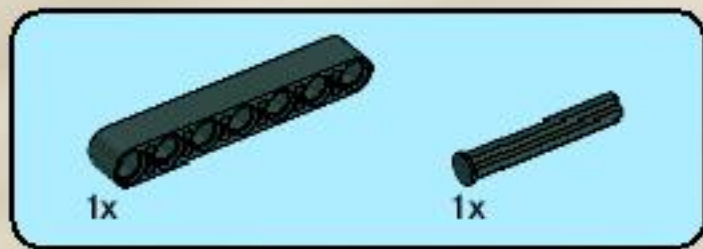

55



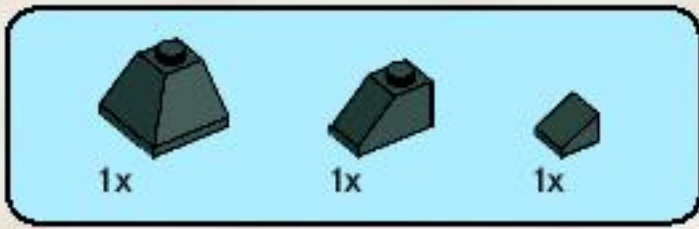

56



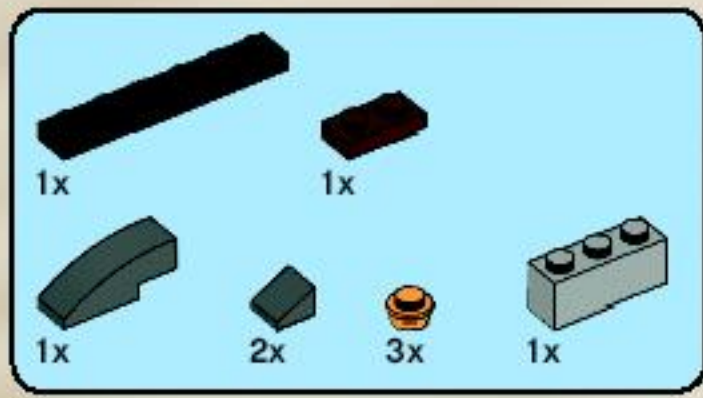

57

1



2

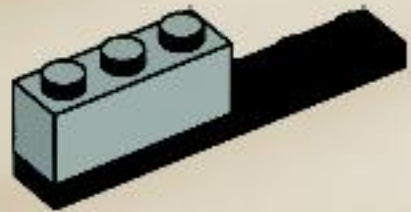

3

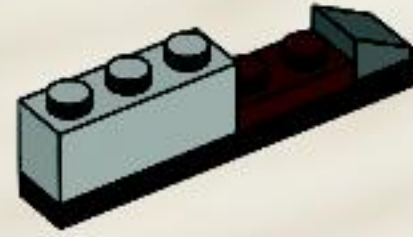

4



5



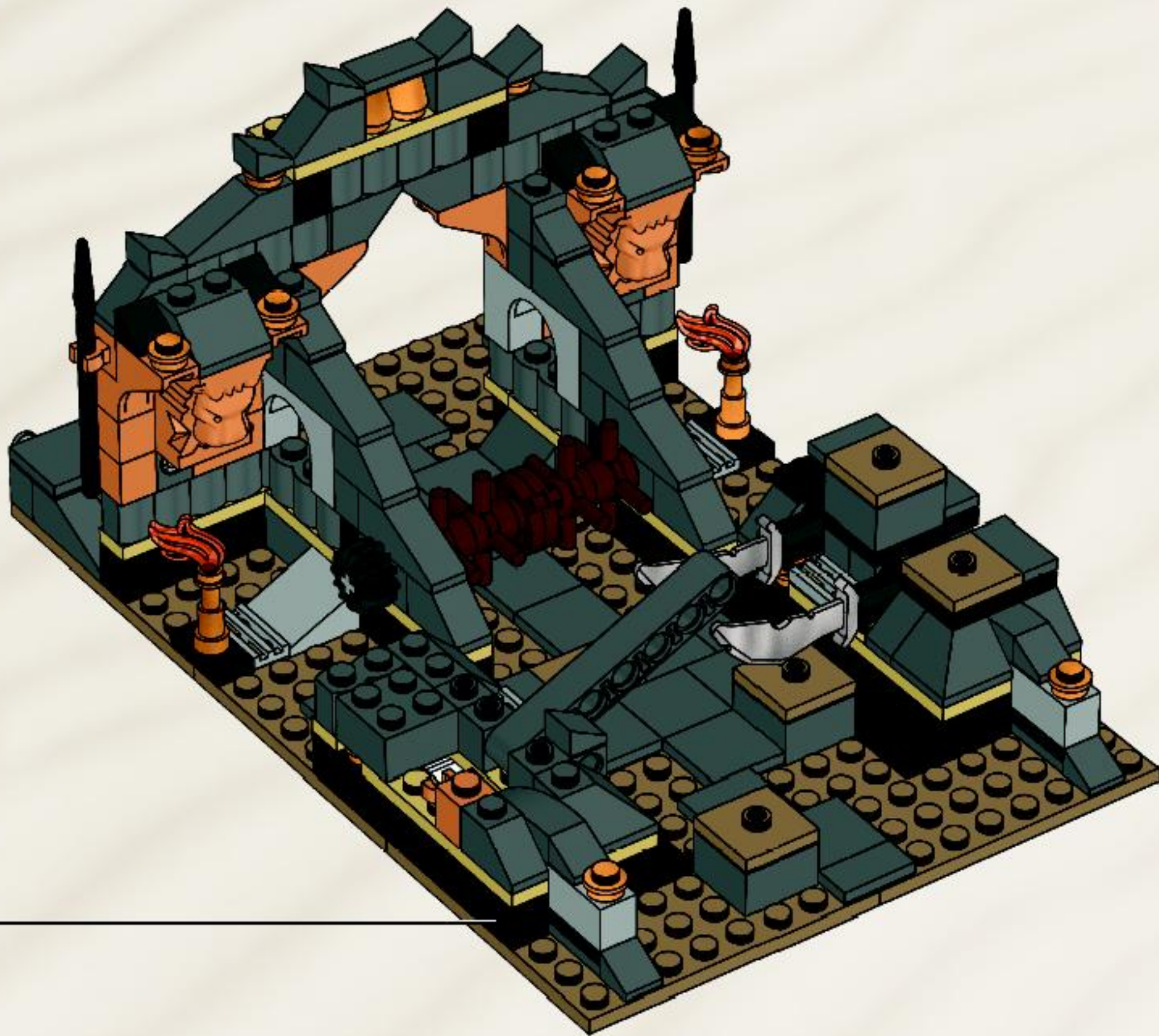

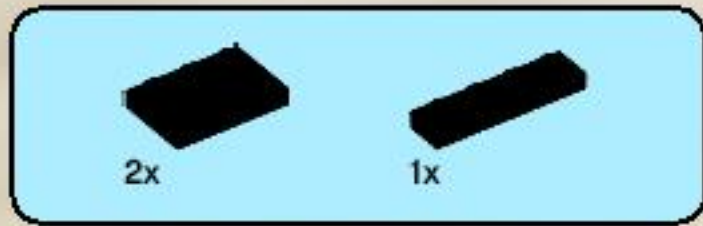

58



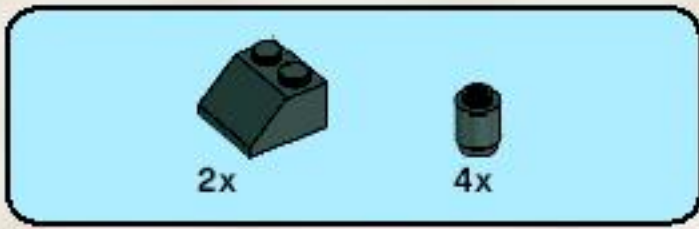

59





60

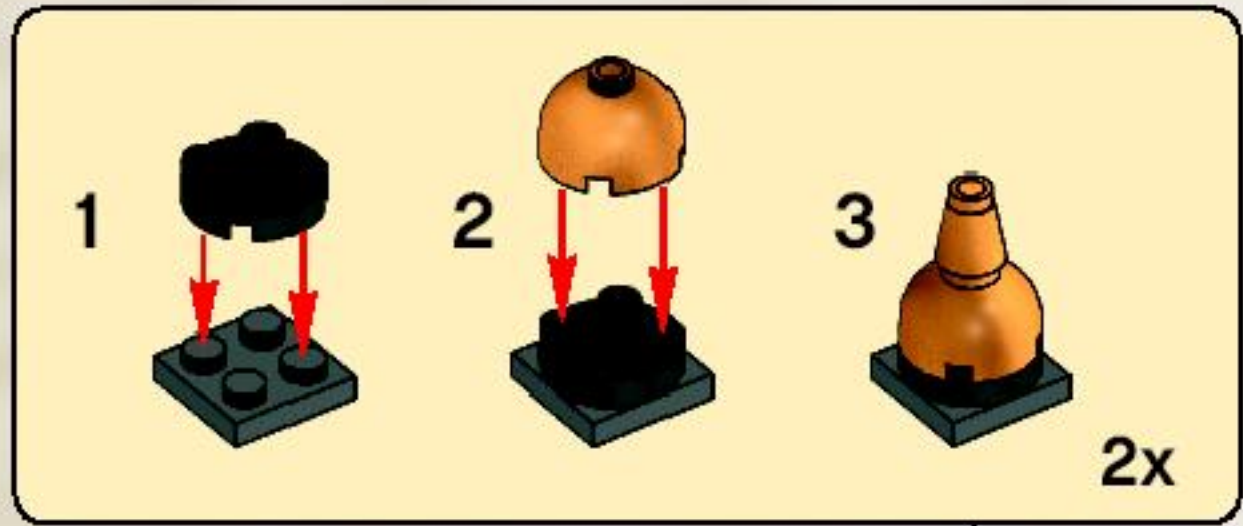

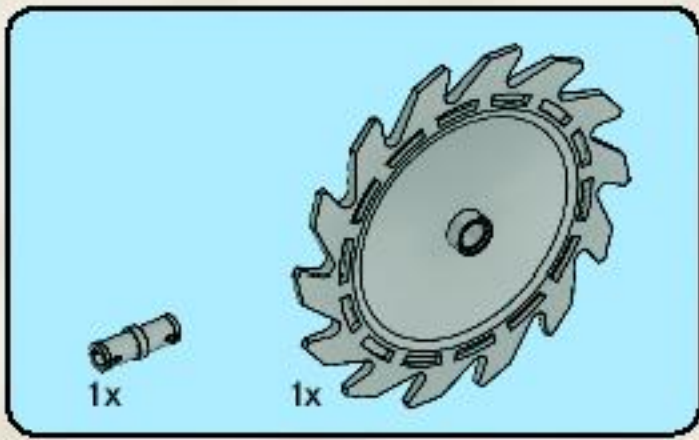

61

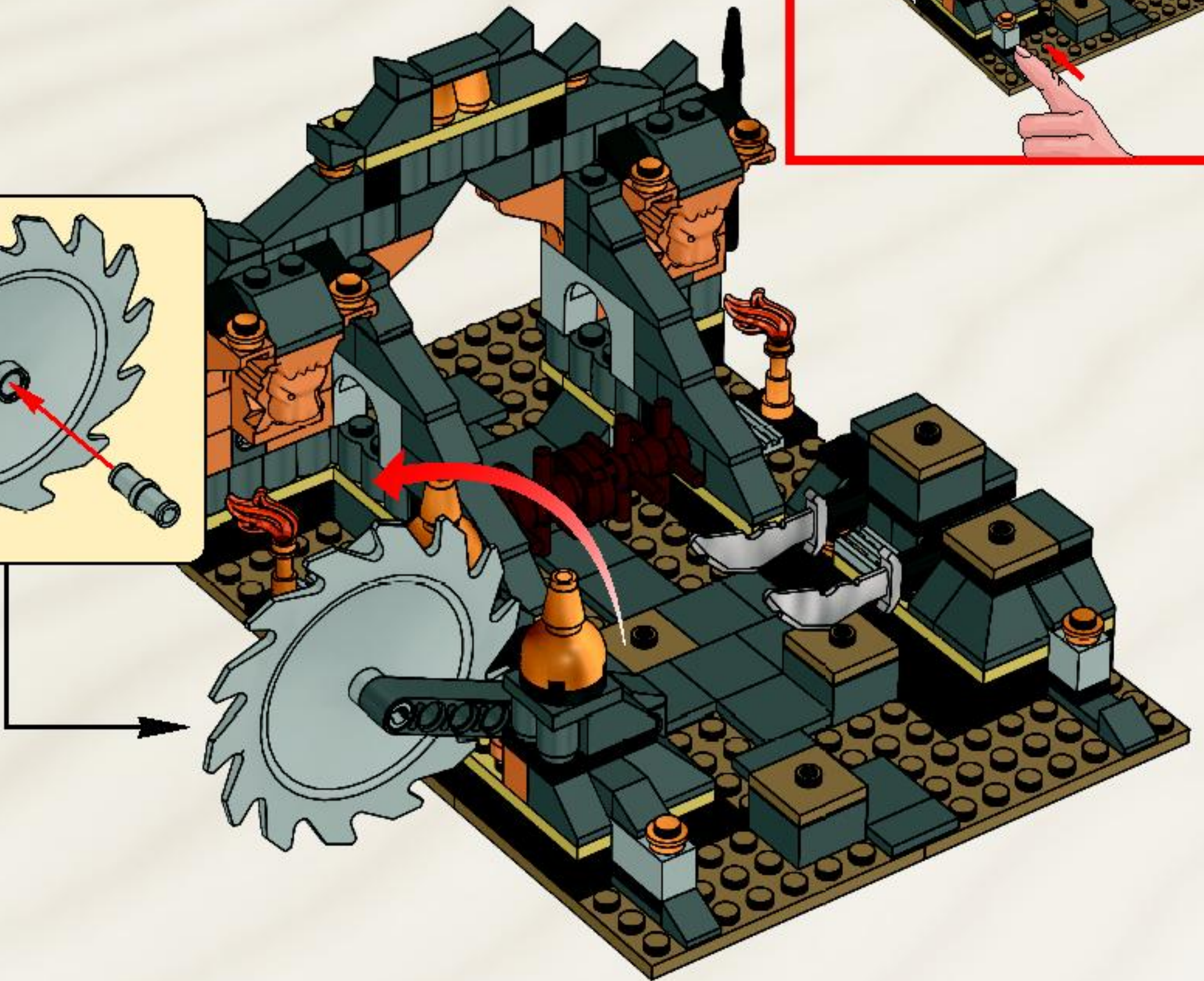
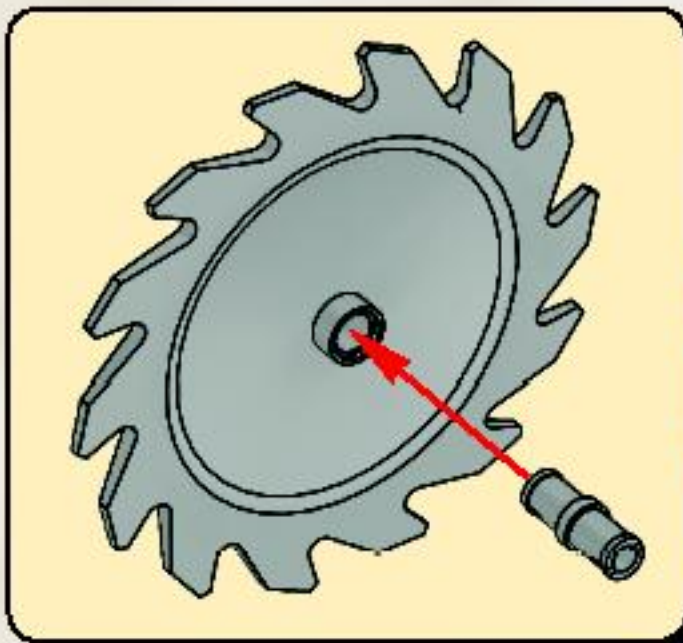
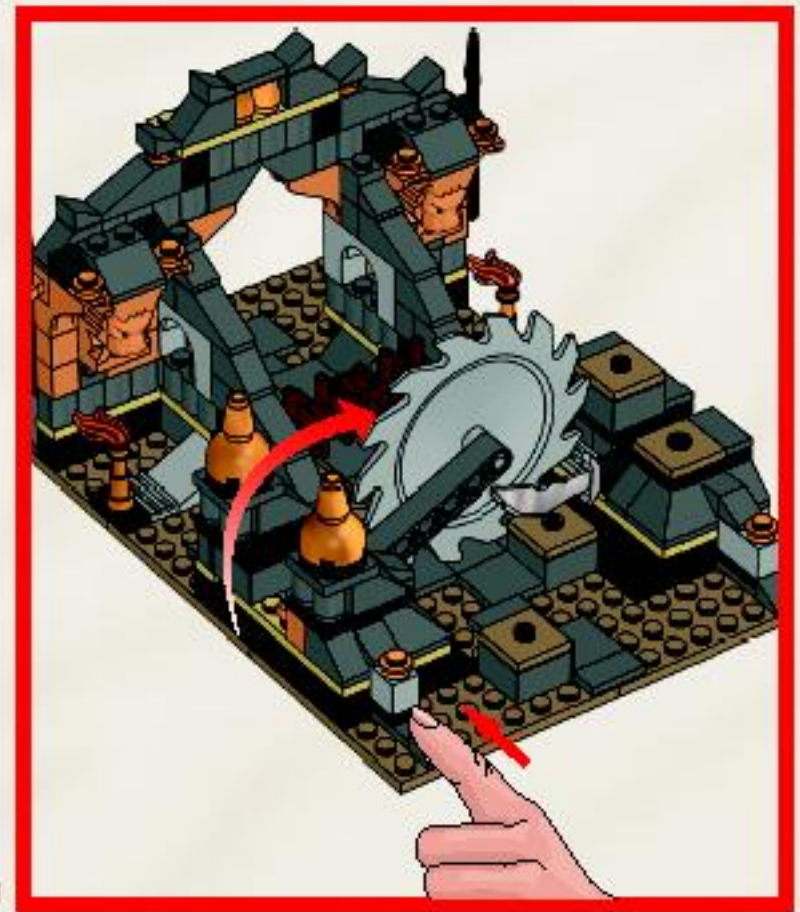

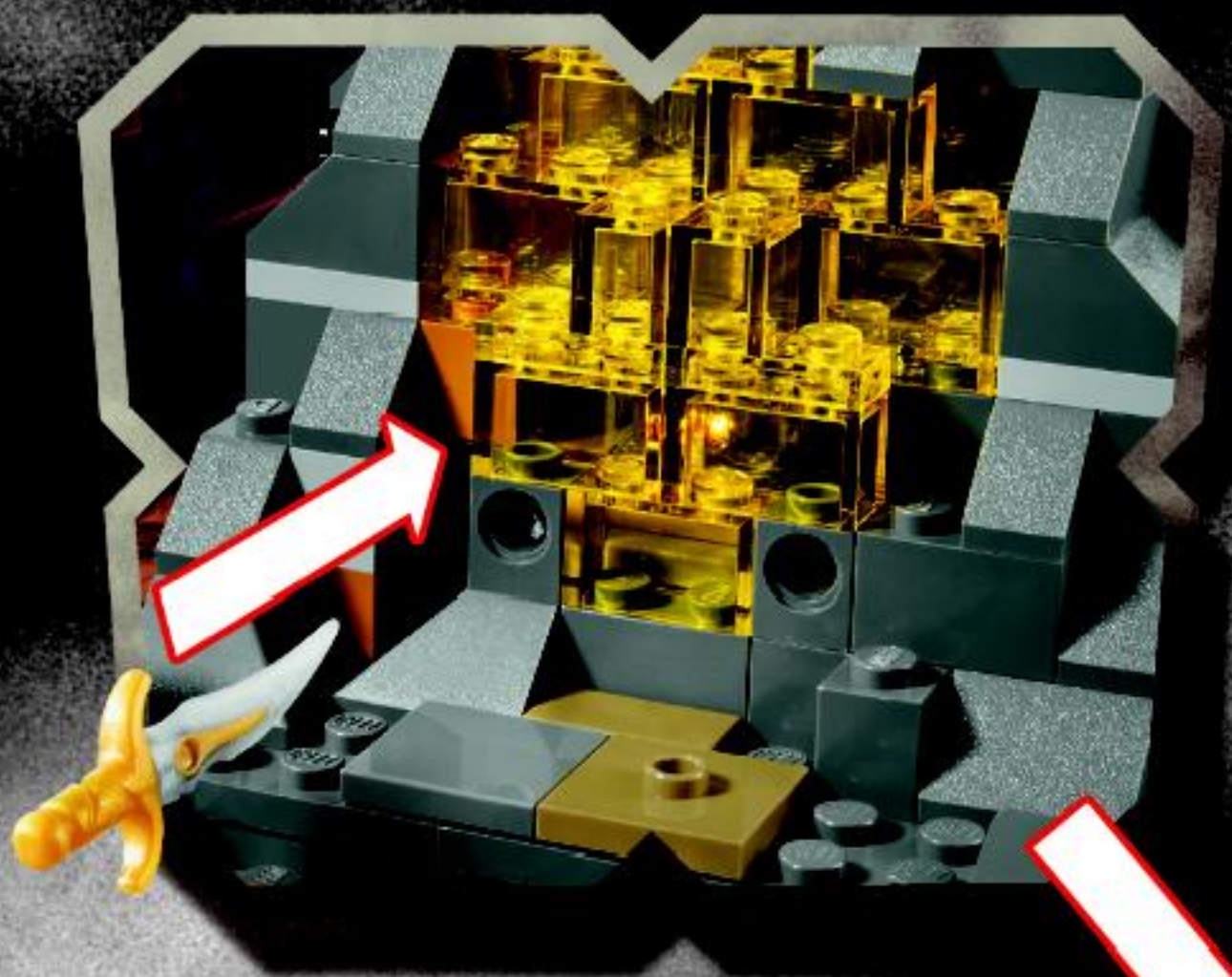





1x
4526177



2x
4249563



1x
9327



1x
4568969



1x
82359

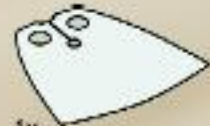

1x
4549636



2x
4159739



2x
4205105



6x
4159553



8x
4113917



2x
4121921



1x
4118790



4x
4113233



2x
4124067



4x
4113993



2x
4114324



2x
4526771



2x
4114052



4x
301026



1x
300926



2x
300826



9x
4558954



5x
306226



4x
4504382



4x
303726



1x
307026



1x
362326

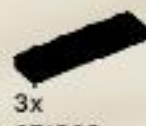

3x
371026



4x
302126

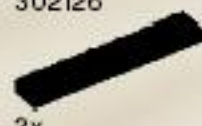

2x
366626



2x
4550017



3x
379426



2x
403226



1x
4580096



1x
4580099



1x
4580108



1x
4568949



1x
4124171



3x
4107085



1x
4177431



1x
612647



2x
4540865



2x
4518474



2x
4569471



5x
4496699



10x
4570111



9x
4578032



2x
4211150



2x
4211159



1x
4262974



4x
4252456



4x
4211389



2x
4211428



2x
4211440



2x
4211421



2x
4225119



2x
4211397



2x
4560183



4x
4211350



1x
4211376



1x
4521897



6x
4211807



1x
4535768



2x
4210690



7x
4211098

9x
4211088

6x
4211075

6x
4211060

10x
4211109

3x
4211104

9x
4211105

4x
4211085

3x
4211100

2x
4211099

2x
4211095

7x
4268139

4x
4211090

12x
4210639

4x
4211111

1x
4210762

32x
4504378

3x
4211096

40x
4211135

6x
4210646

13x
4211054

8x
4211045

1x
4210797

2x
4246896

4x
4210719

9x
4211052

2x
4211094

20x
4211055

3x
4211043

3x
4211065

1x
4243831

2x
4211008

1x
4211061

1x
4210794

2x
4513326

3x
4210844

1x
4509194

1x
4495931

1x
4560177

4x
4529247

2x
4569316

18x
4523159

2x
4538126

1x
4568950

1x
4529672

1x
4580101

1x
4580118

1x
4581313

1x
4568934

1x
4521781

3x
4549898

1x
4568952

15x
4569382

5x
4569385

6x
4568955

2x
4570156

13x
306544

1x
3006844

4x
4194746

1x
4568737

1x
4568730

1x
4568731

1x
4568735



Customer Service
Kundenservice
Service Consommateurs
Servicio Al Consumidor

www.lego.com/service or dial

: 00800 5346 5555

: 1-800-422-5346







7573





Disney **PRINCE OF PERSIA**
THE SANDS OF TIME



FREE! GRATIS! GRATUIT!



club
MAGAZINE™

www.LEGOclub.com



00800 5346 5555*        

  1-866-534-6258 • 1-877-518-5346

US & Canada only

Canada seulement



VISIT THE WORLD'S
BIGGEST LEGO® SHOP!

www.LEGOshop.com

* Freephone. Mobile charges may apply. * Numéro sans frais. Les frais peuvent s'appliquer avec les téléphones cellulaires. * Gebührelos. Kosten für Anrufe aus Mobilfunknetzen können abweichen. * Gratís telefonnummer van vaste lijn. * Telemobil gratuit. Numéros pour les appels par réseaux mobiles. * Det är gratis, när du ringer från en fasttelefon. * Det är gratis, när du ringer från en fasttelefon.



WIN!

Go to www.nielsen.com/LEGO to fill out a survey for a chance to win a cool LEGO® Product.

No purchase necessary.

Open to all residents where not prohibited.



www.nielsen.com/LEGO

GEWINNE! WIN!

Nimm an der Umfrage auf www.nielsen.com/LEGO teil und hab die Chance ein cooles LEGO® Produkt zu gewinnen!

Die Teilnahme am Gewinnspiel führt zu keinerlei Kaufverpflichtungen. Teilnahme in allen nicht ausgeschlossenen Ländern möglich.

Ga naar www.nielsen.com/LEGO, vul een enquêteformulier in en maak kans op een cool LEGO® product.

Geen aankoopverplichting. Iedereen mag deelnemen, uitgezonderd ingezetenden van landen waar een enquêteverbod geldt.

GAGNE! 当てよう!

Visite www.nielsen.com/LEGO pour répondre à un questionnaire et avoir une chance de gagner un produit LEGO® très cool!

Aucune obligation d'achat. Ouvert à tous les résidents des pays autorisés.

www.nielsen.com/LEGOにアクセスして、アンケートにご記入ください。当選者にはレゴ製品を差し上げます。

お買い上げの必要はありません。禁止されていない限り、すべての皆様にご案内いたします。



PRINCE OF
PERSIA
THE SANDS OF TIME



7572



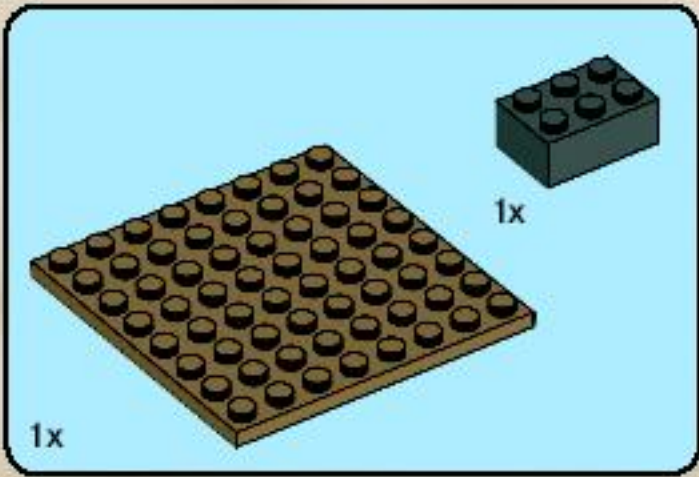
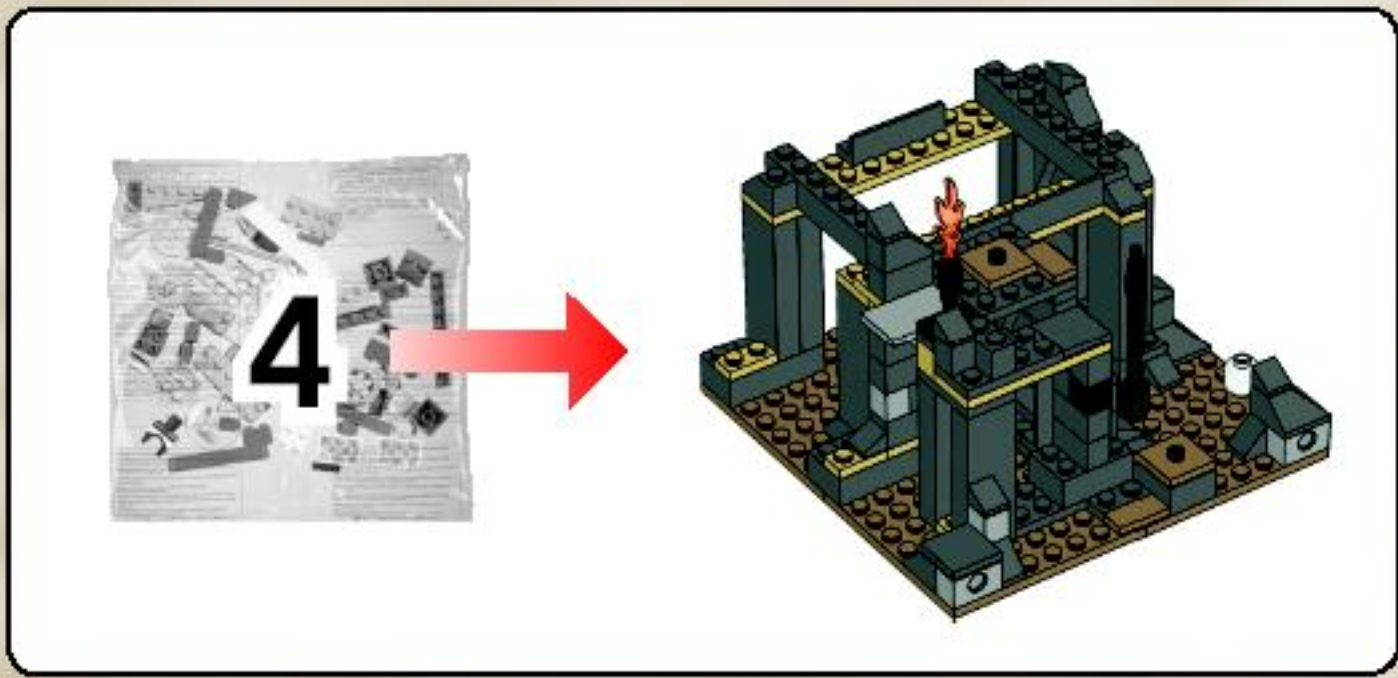

1

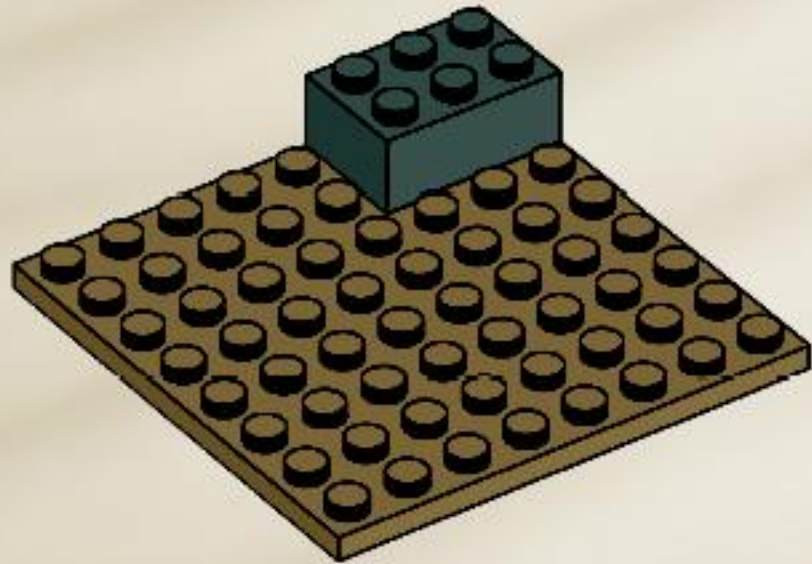

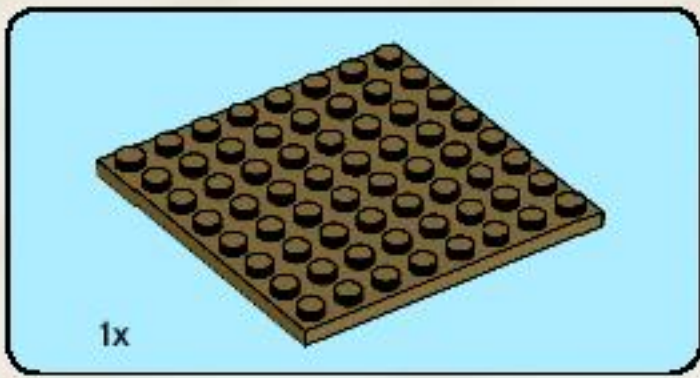

2

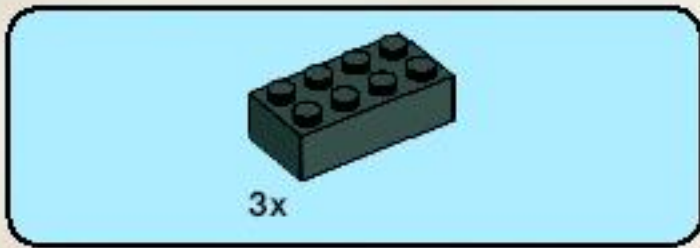
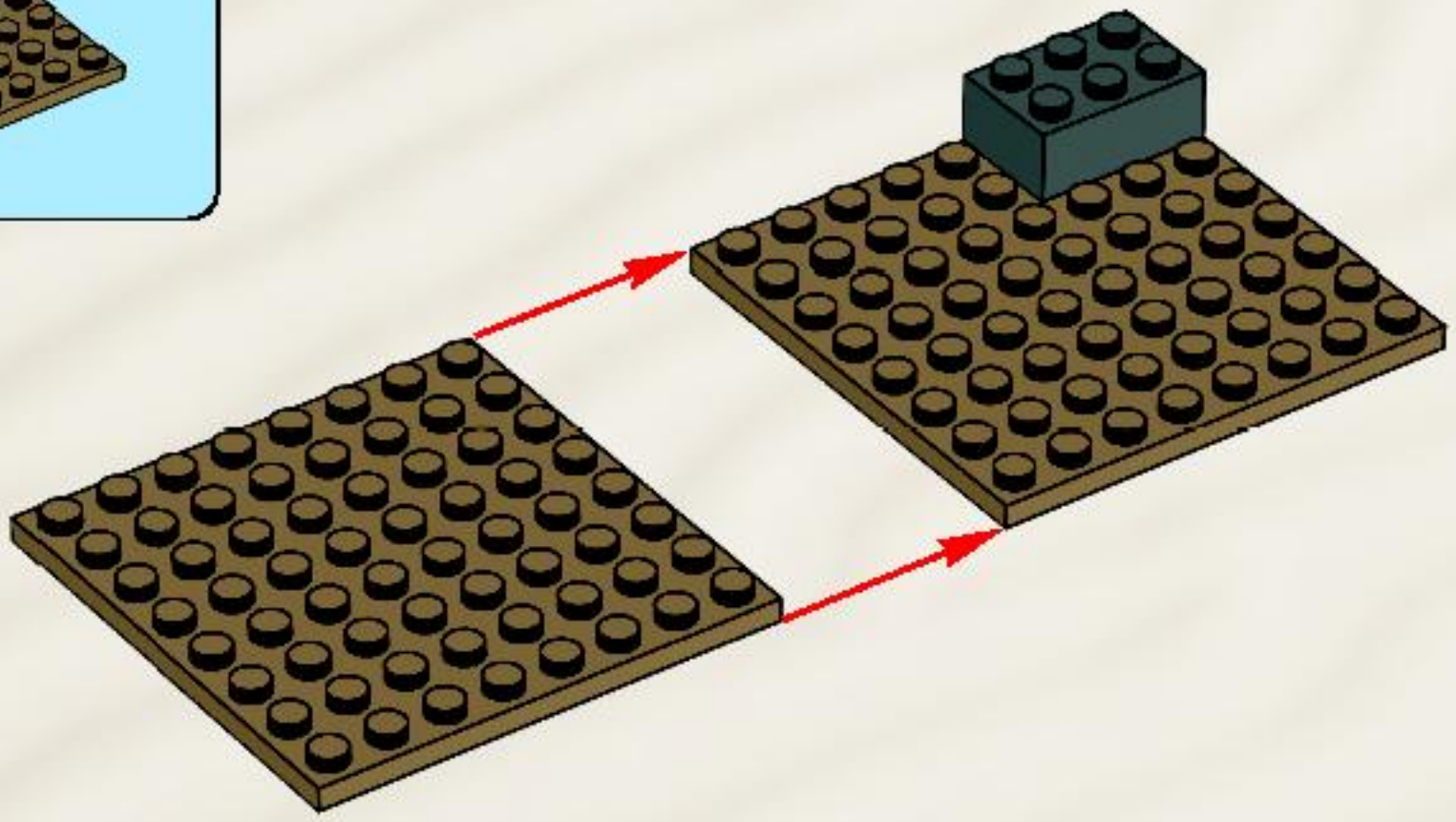

3

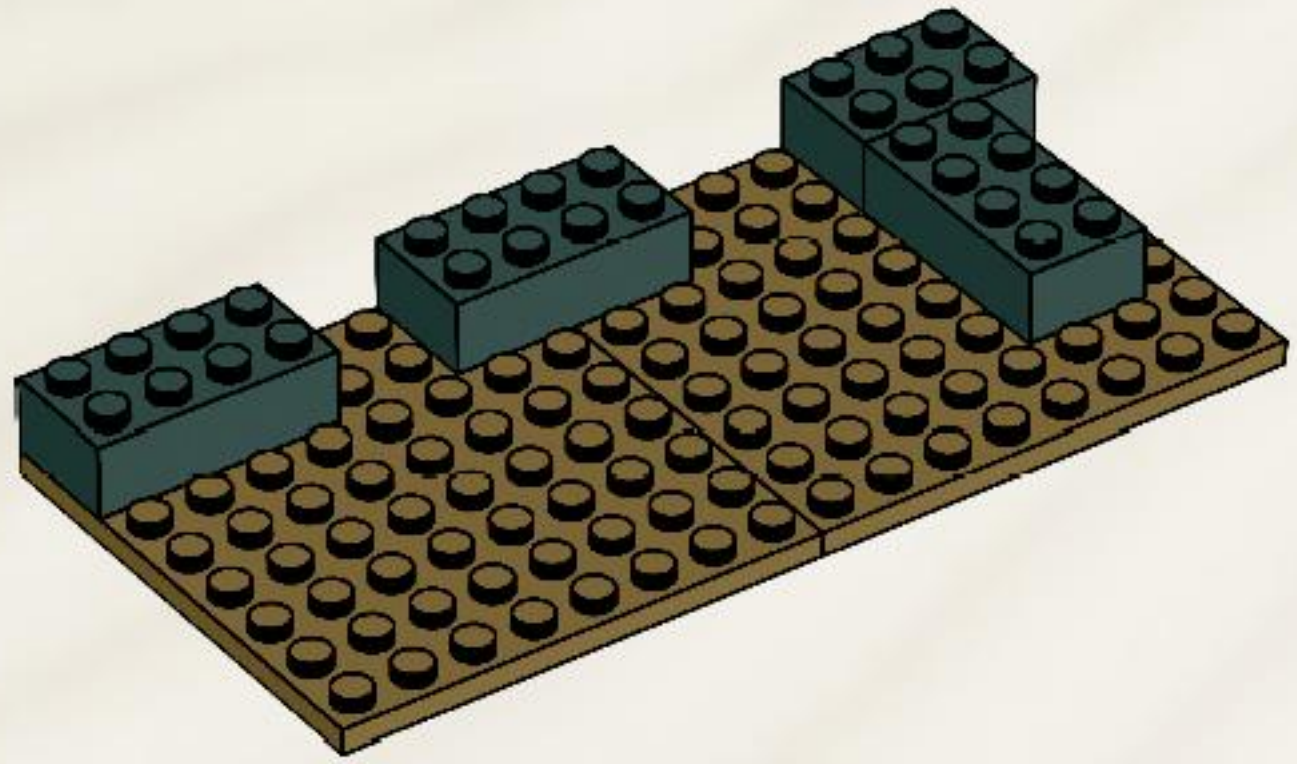

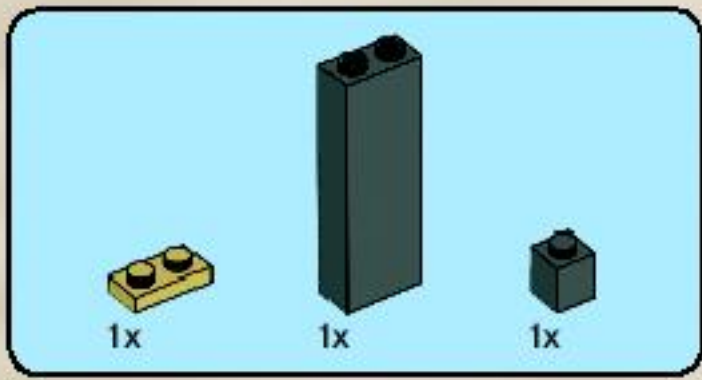

4

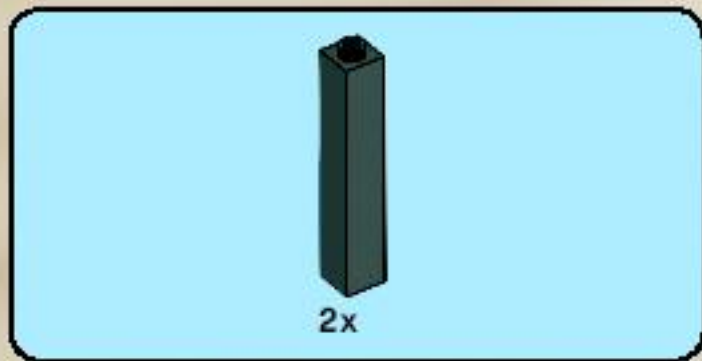
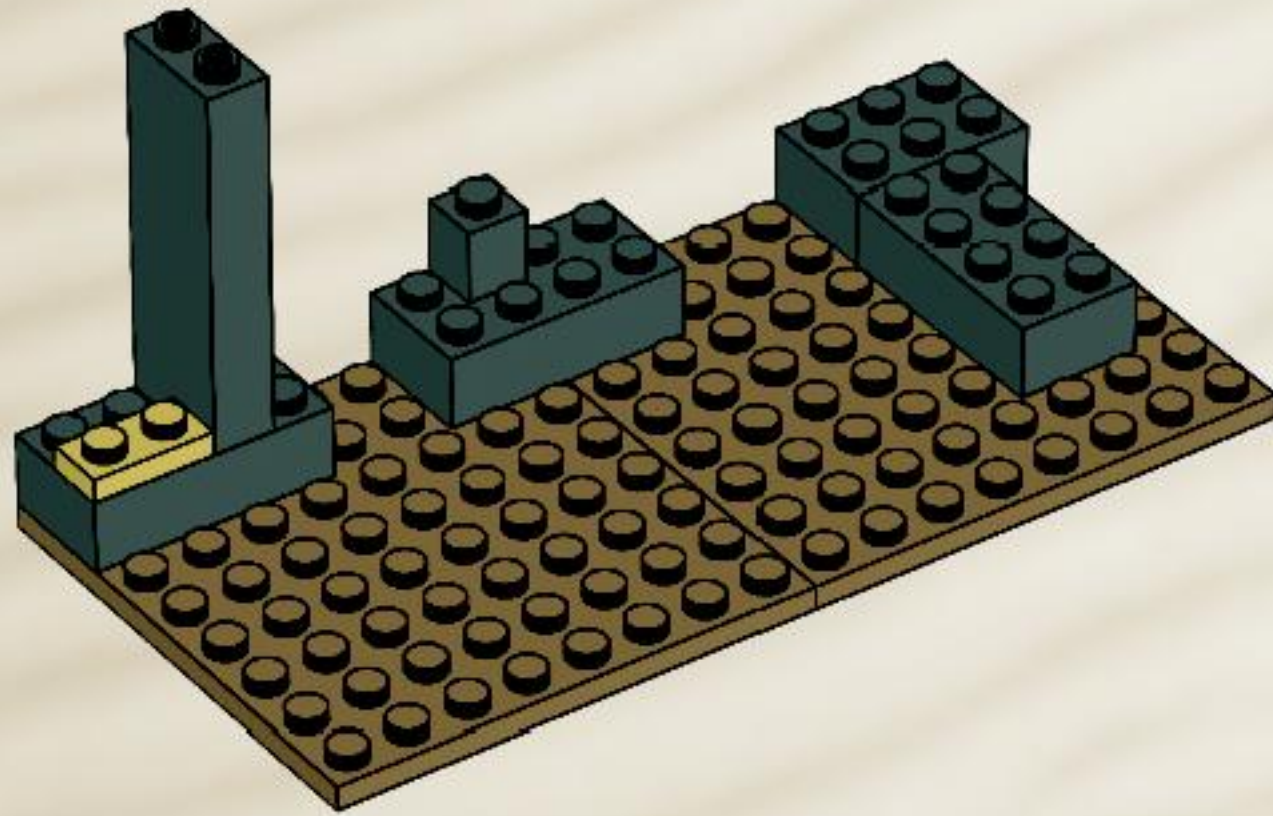

5

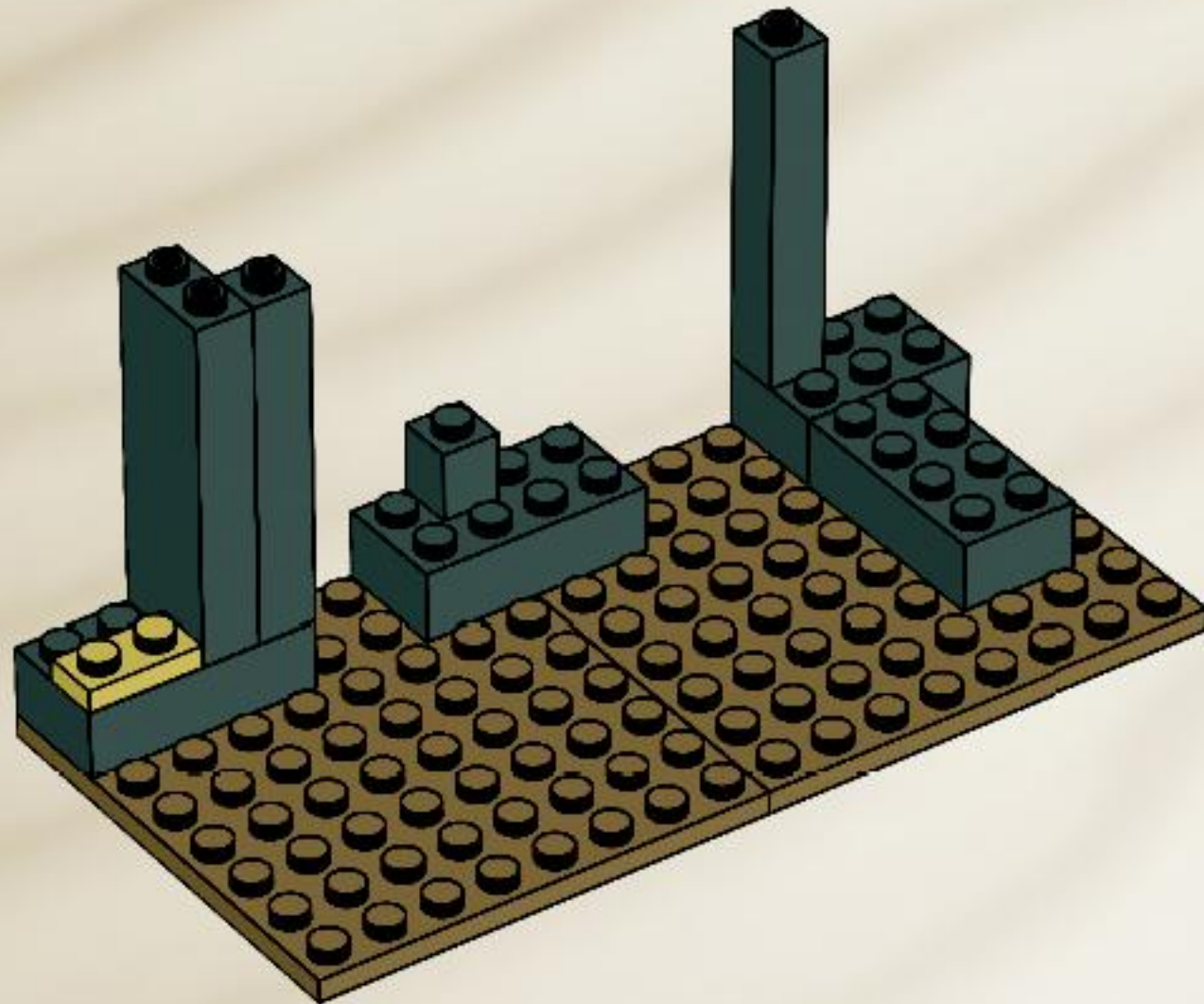

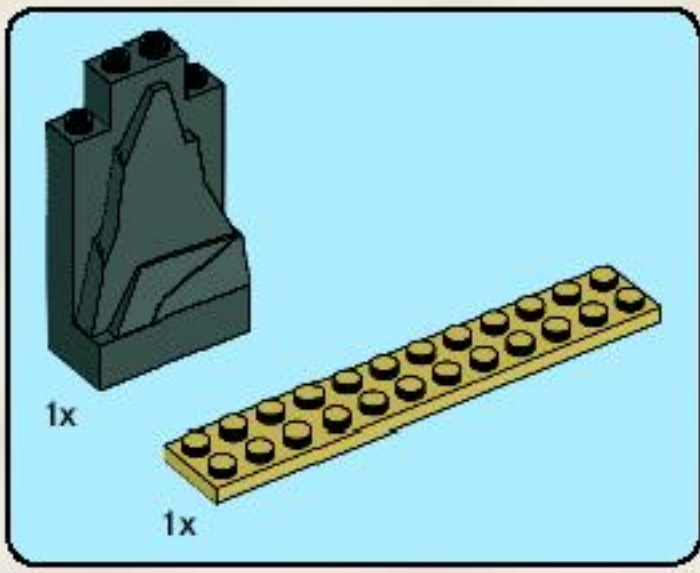

6

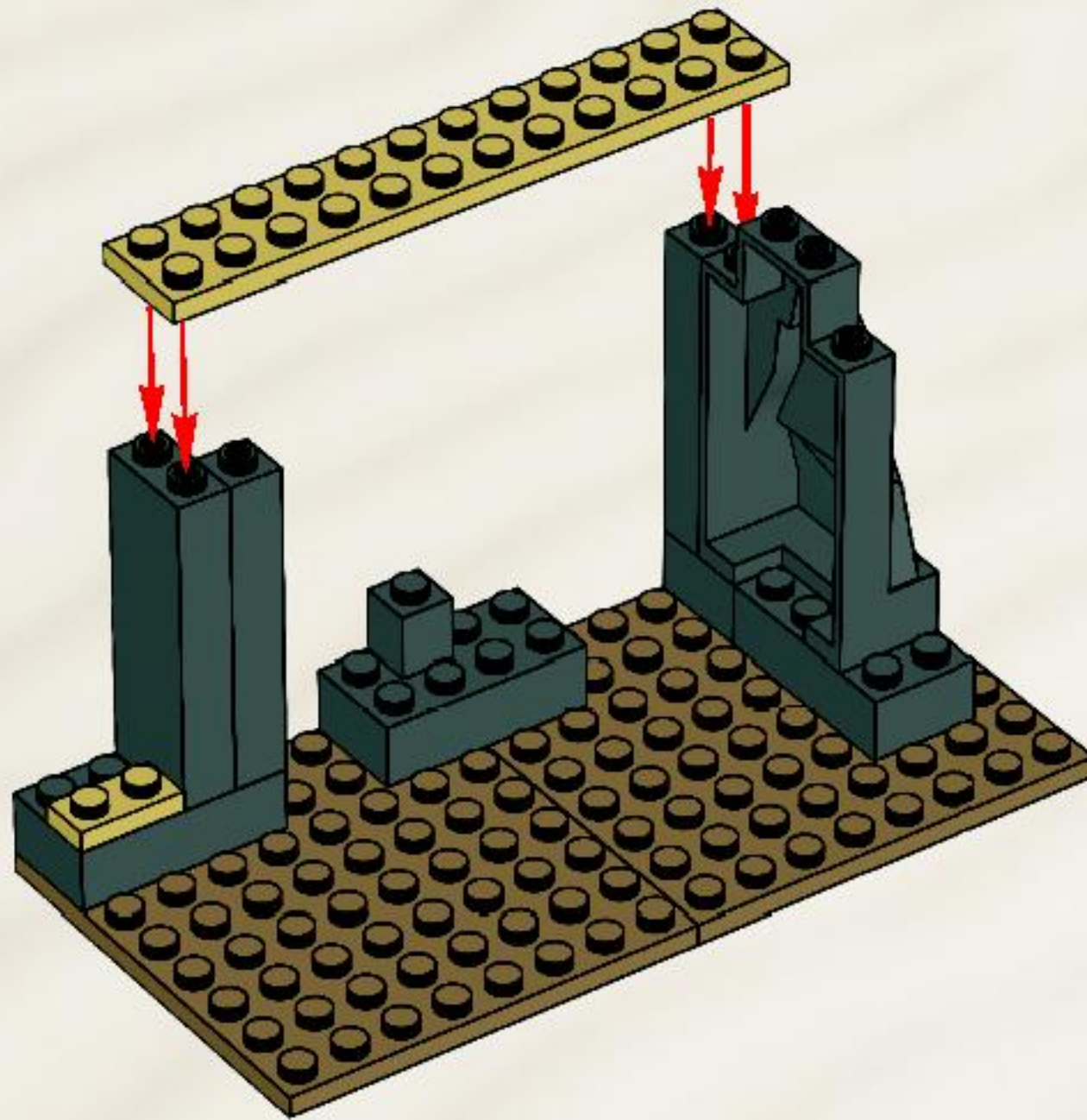

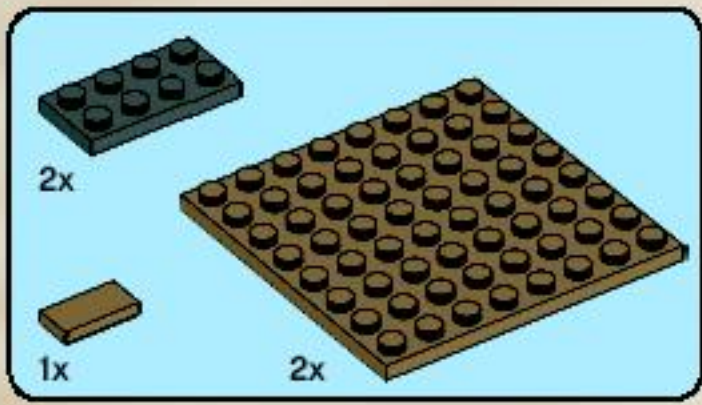

7

1

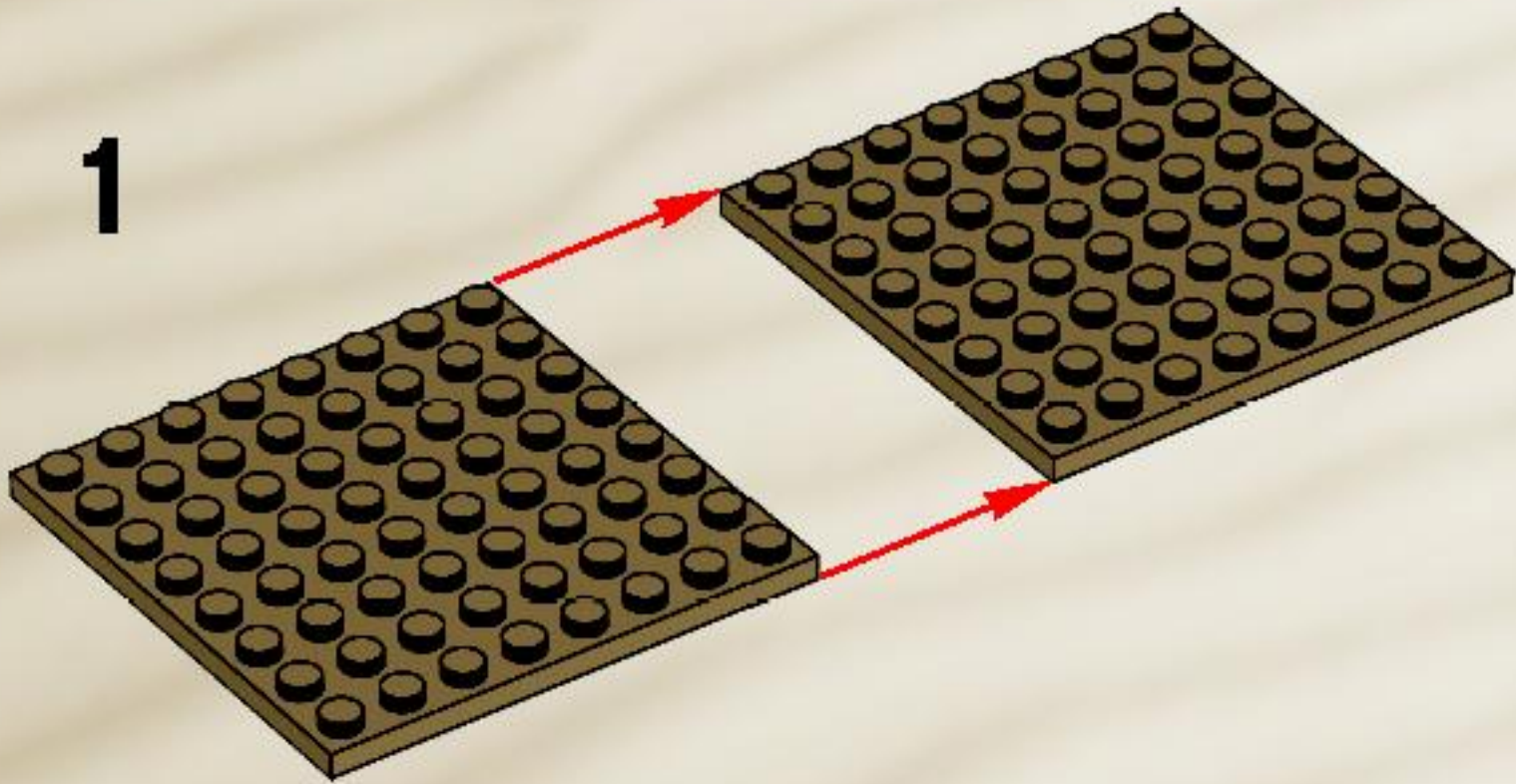

2

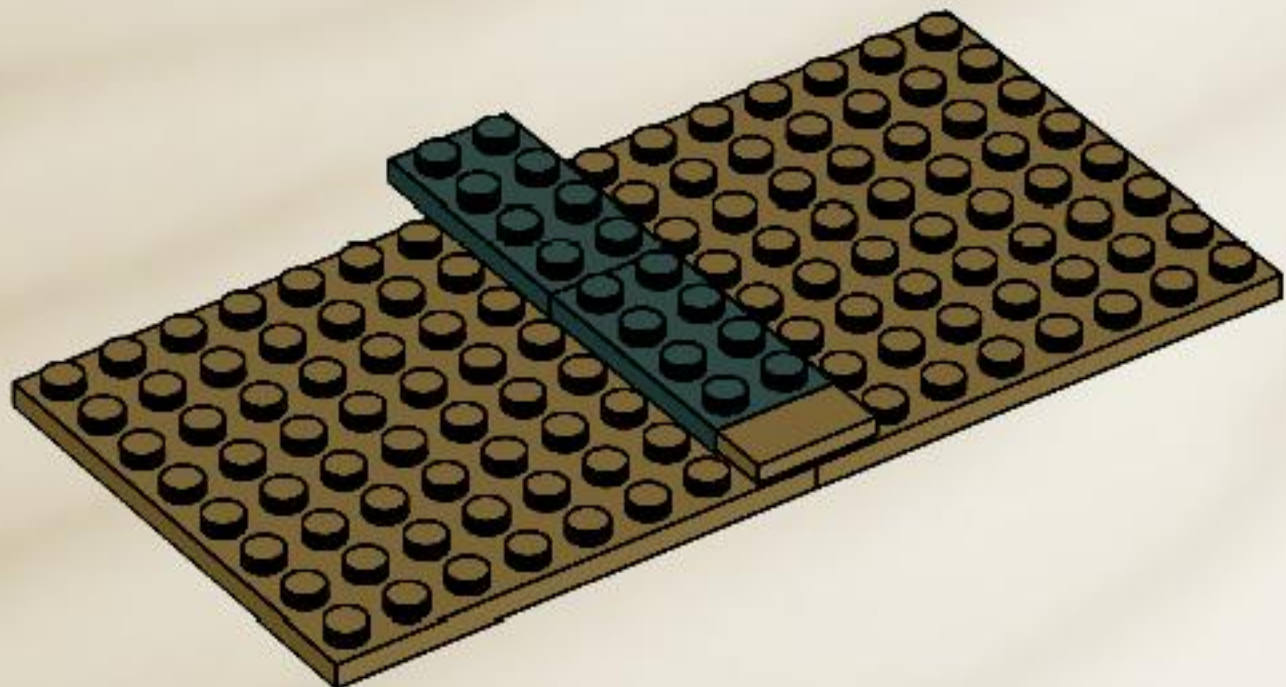

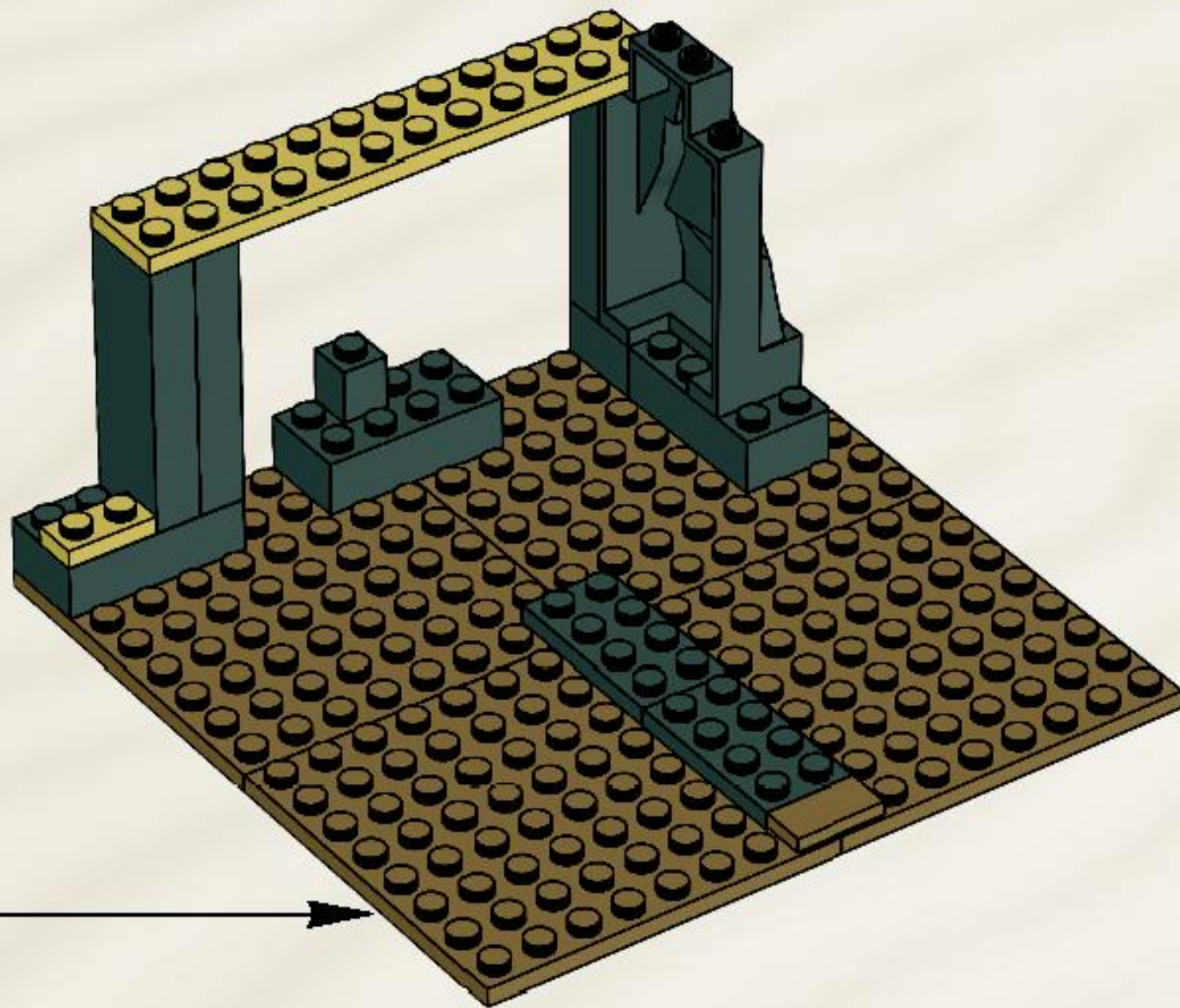

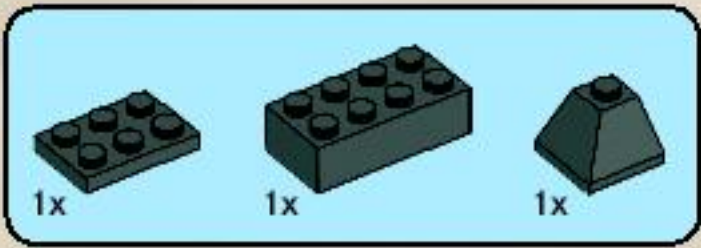

8

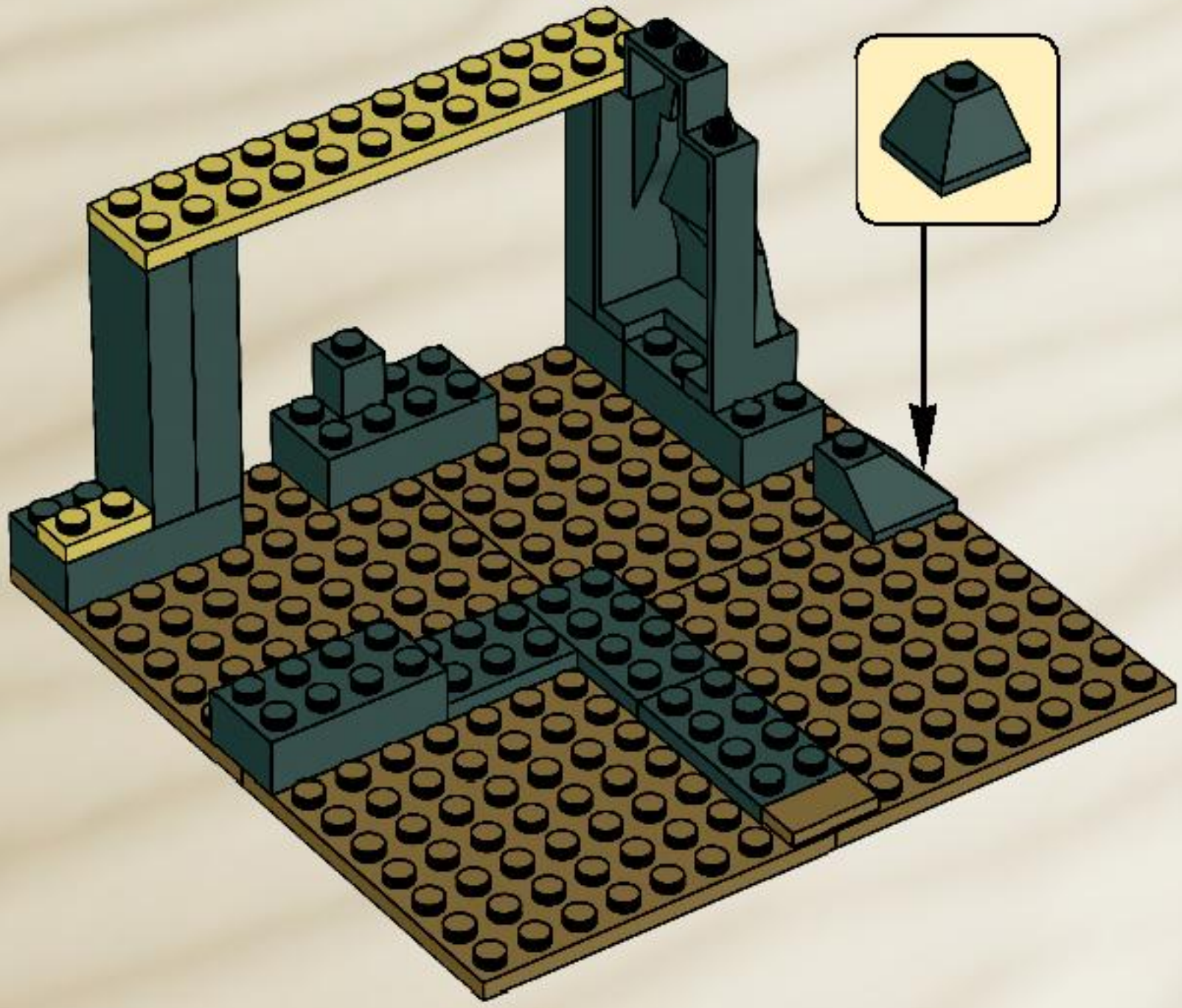

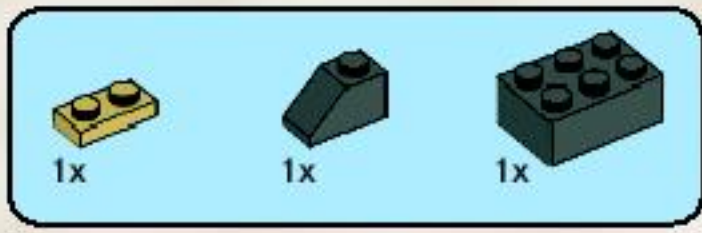

9

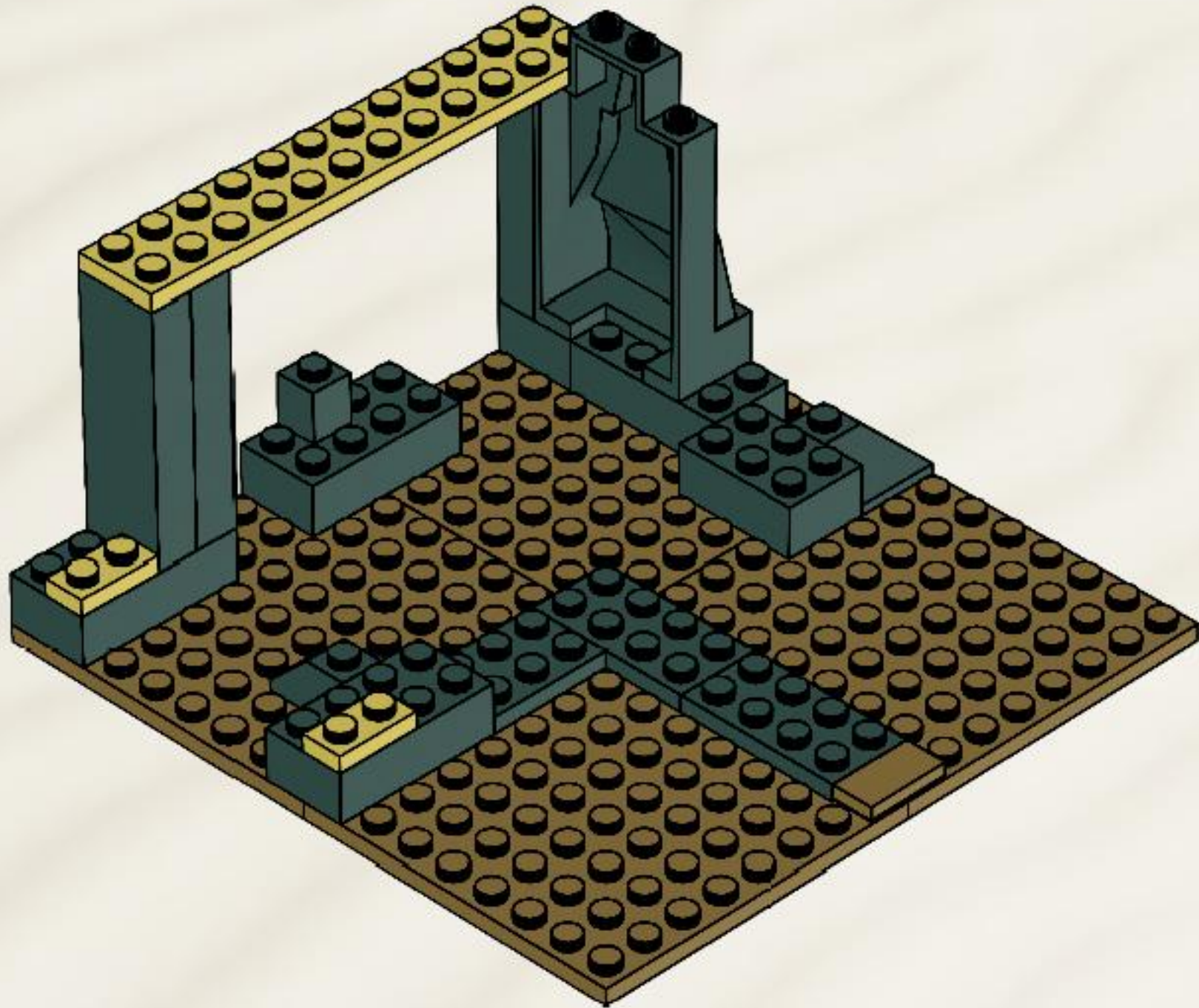

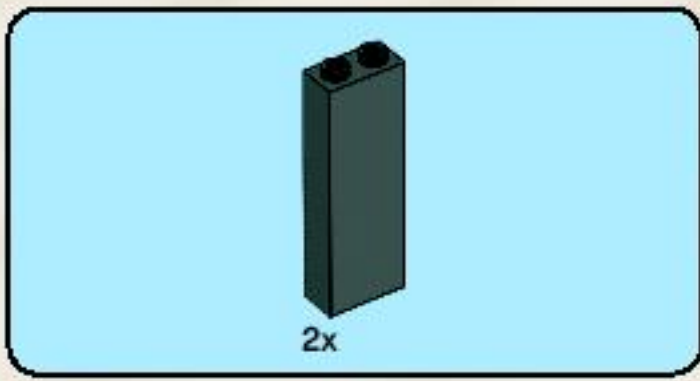

11

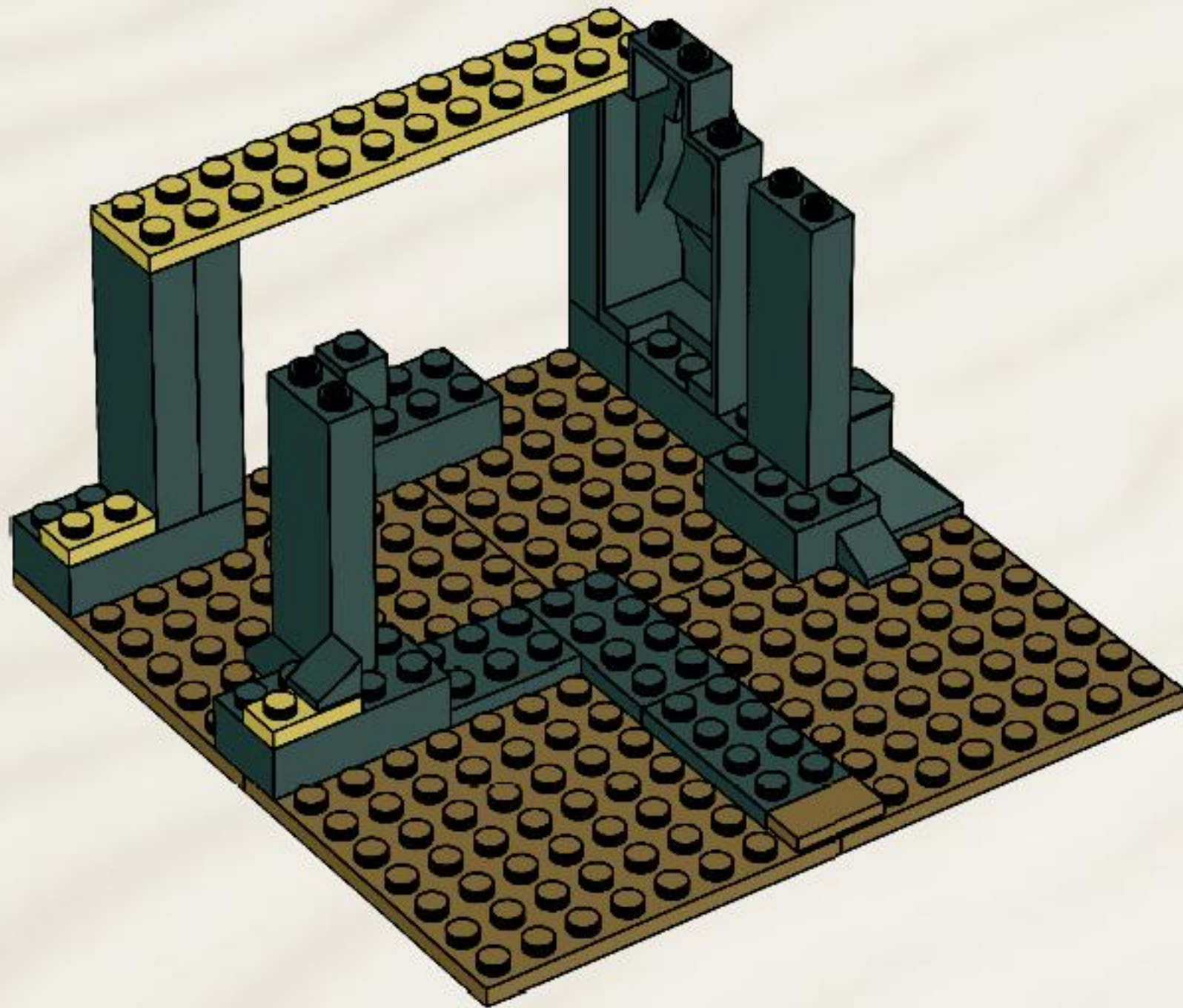

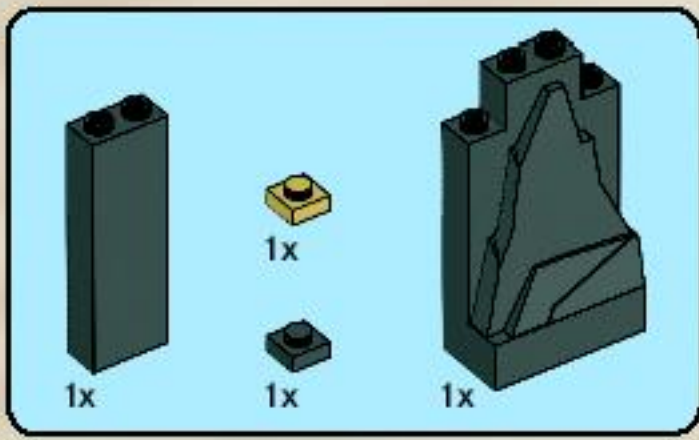

12

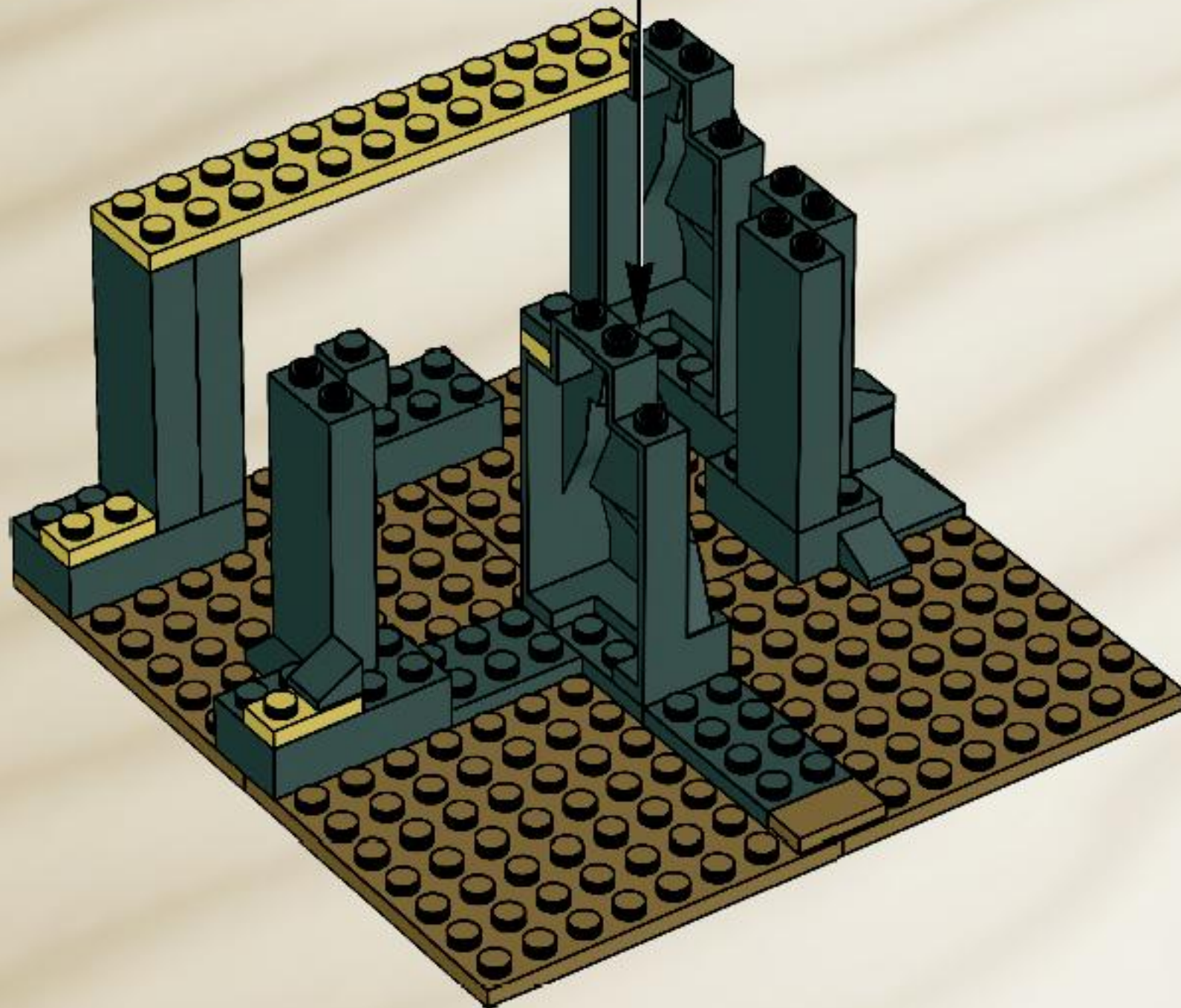
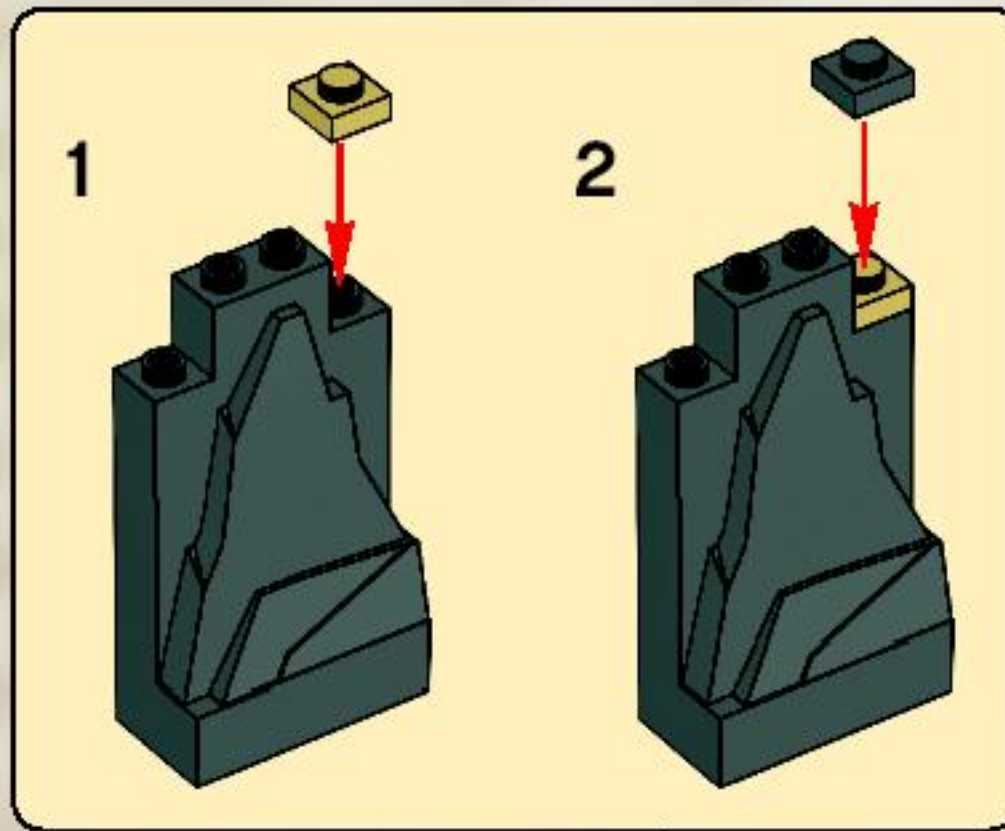

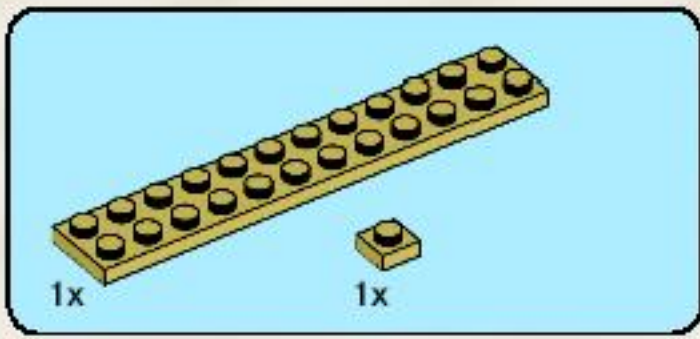

13

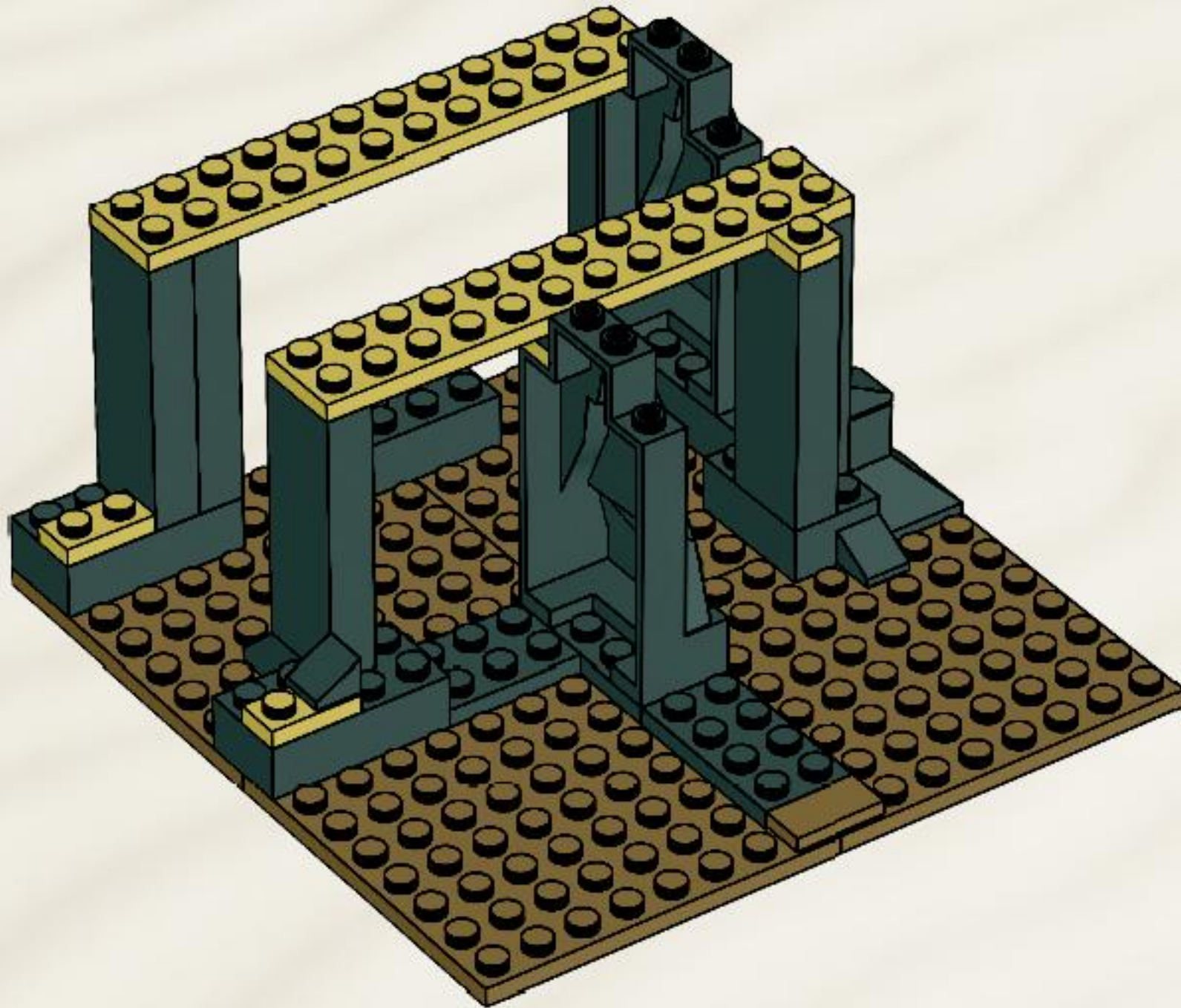

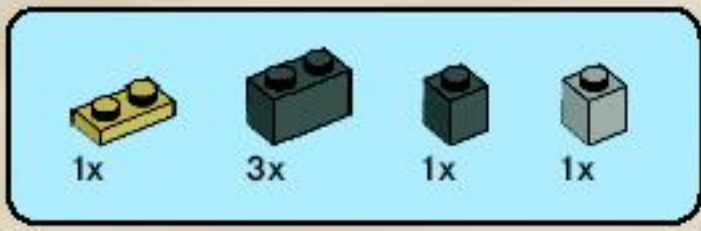

14

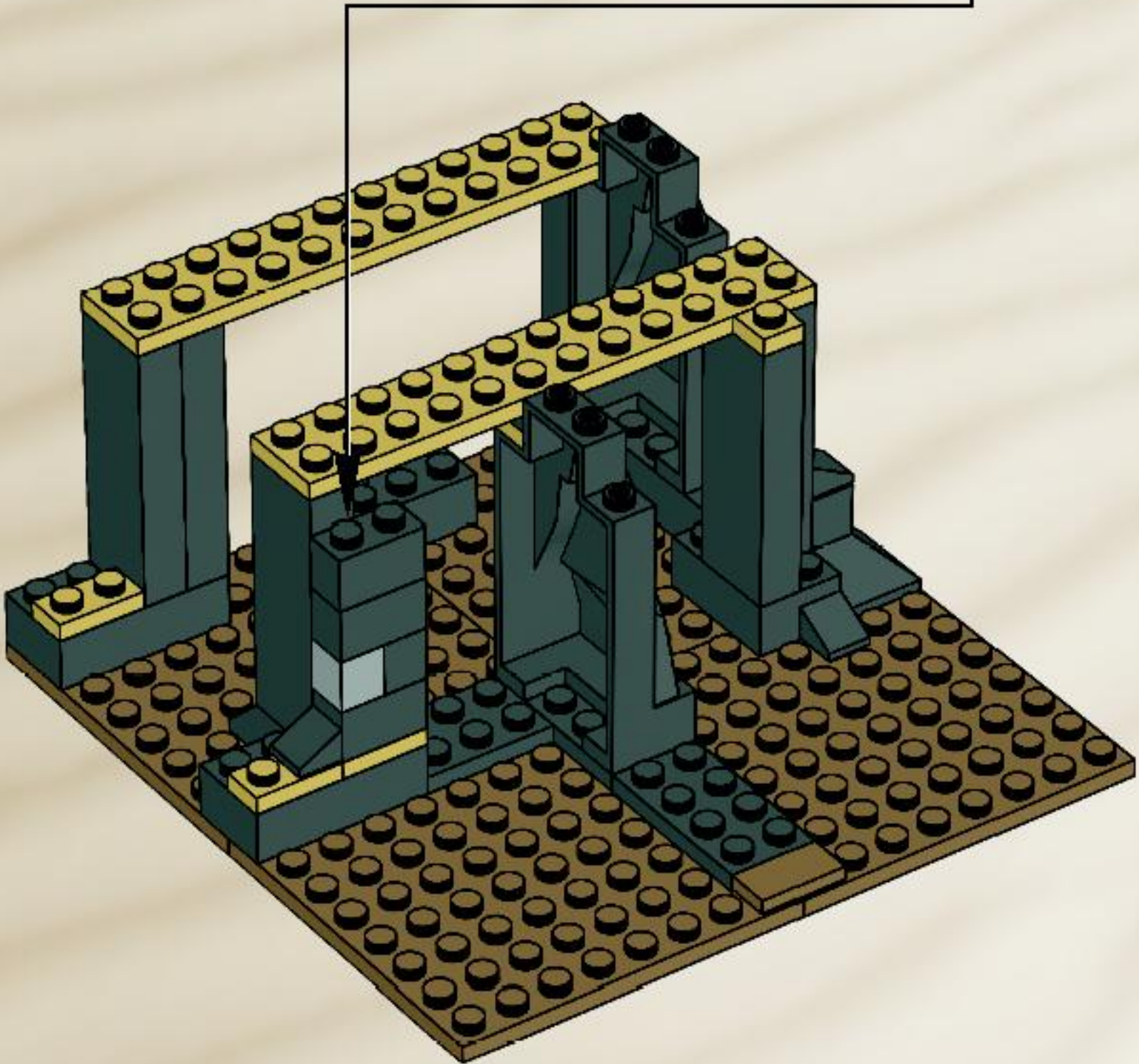
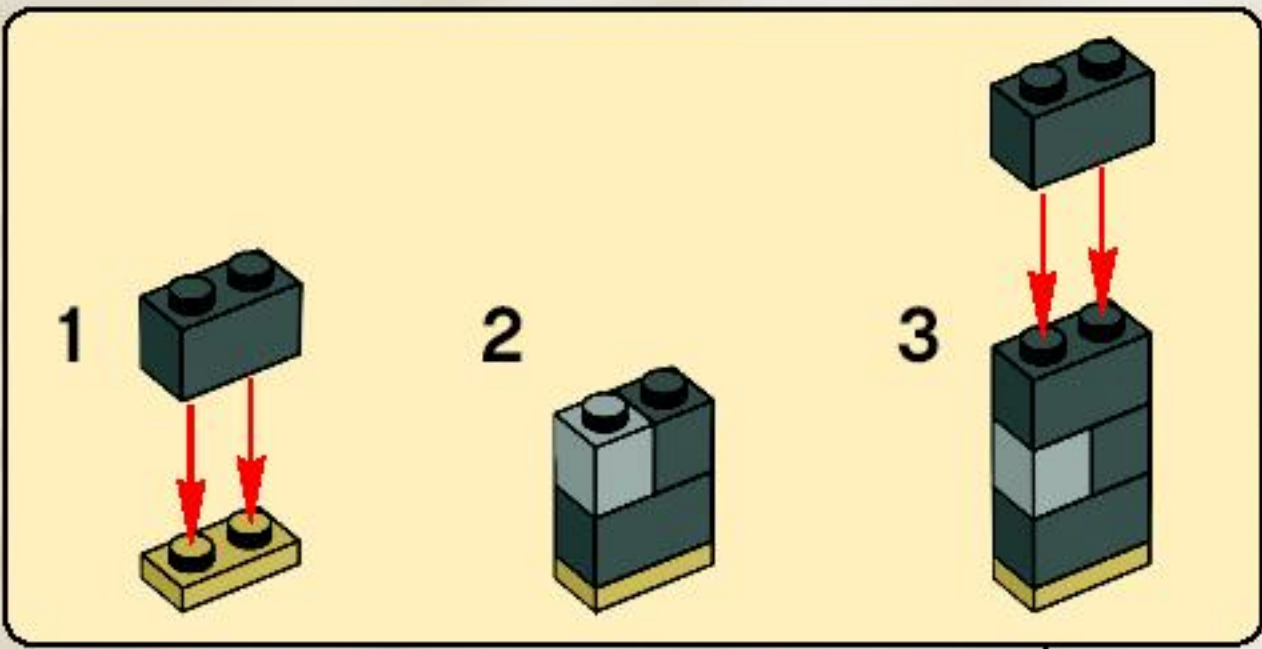

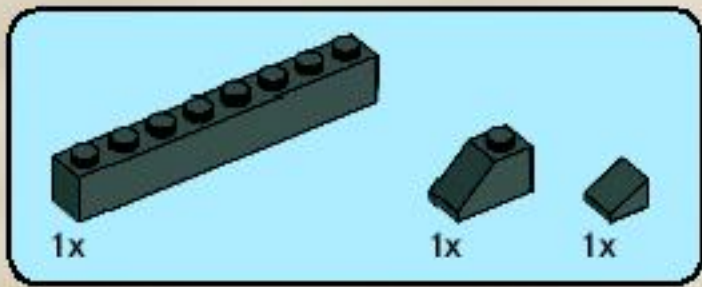

16

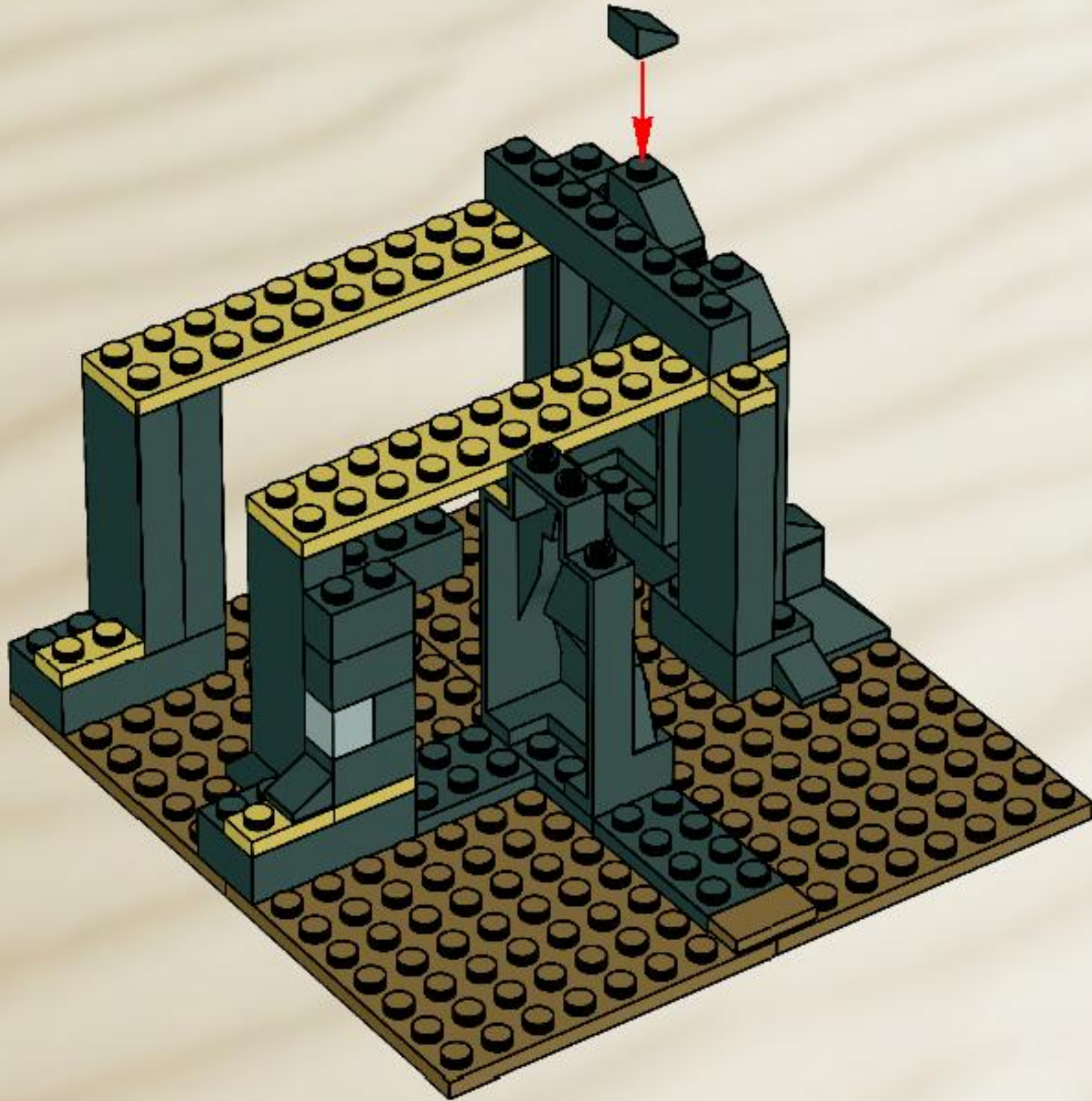

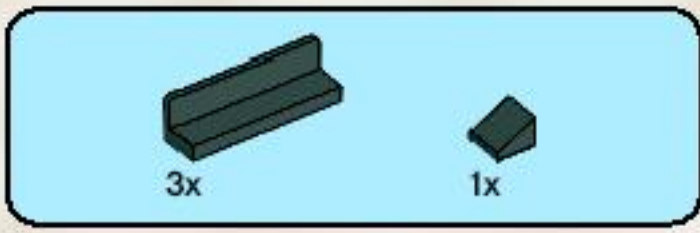

17

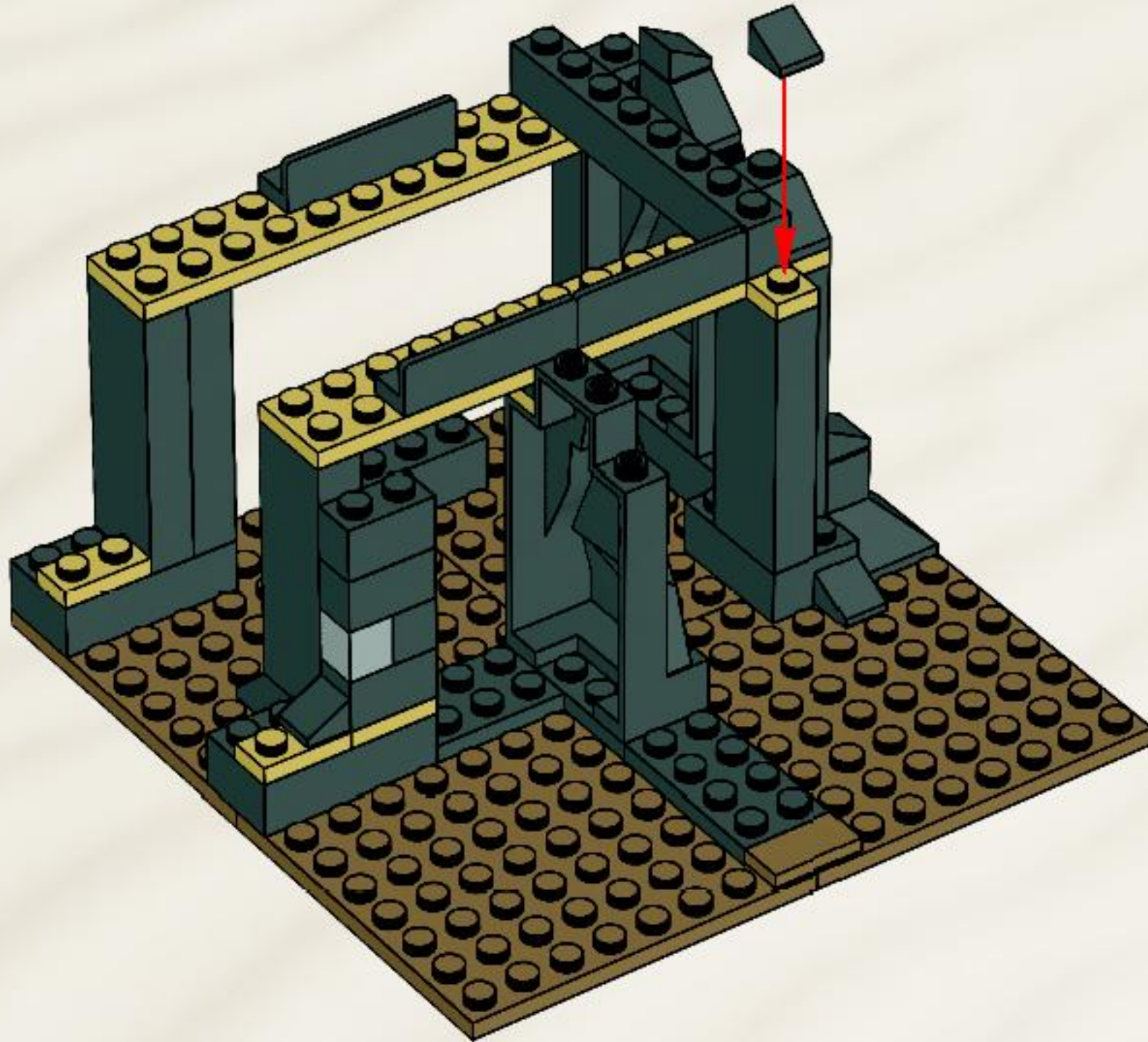

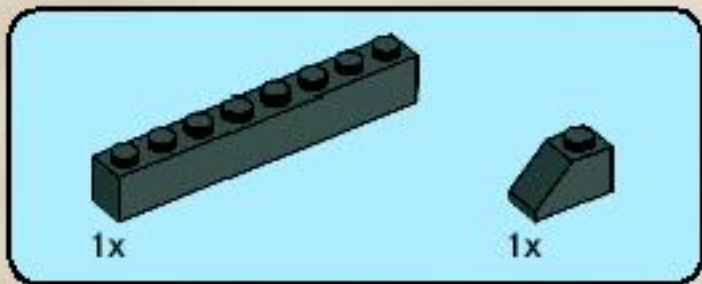

18

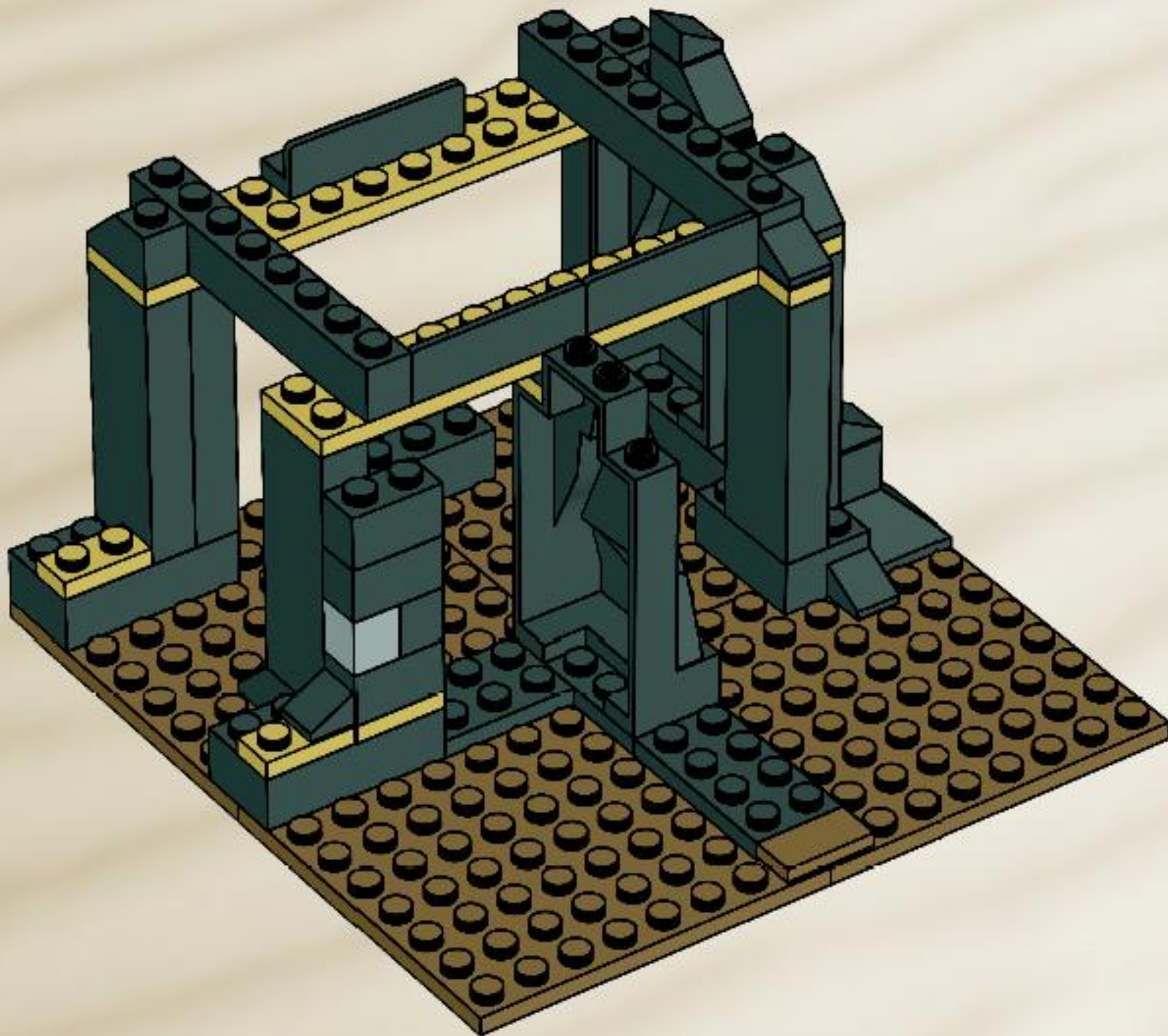

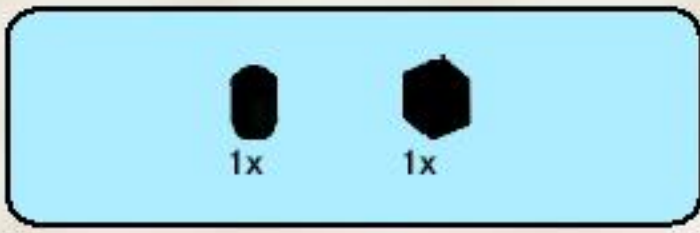

19

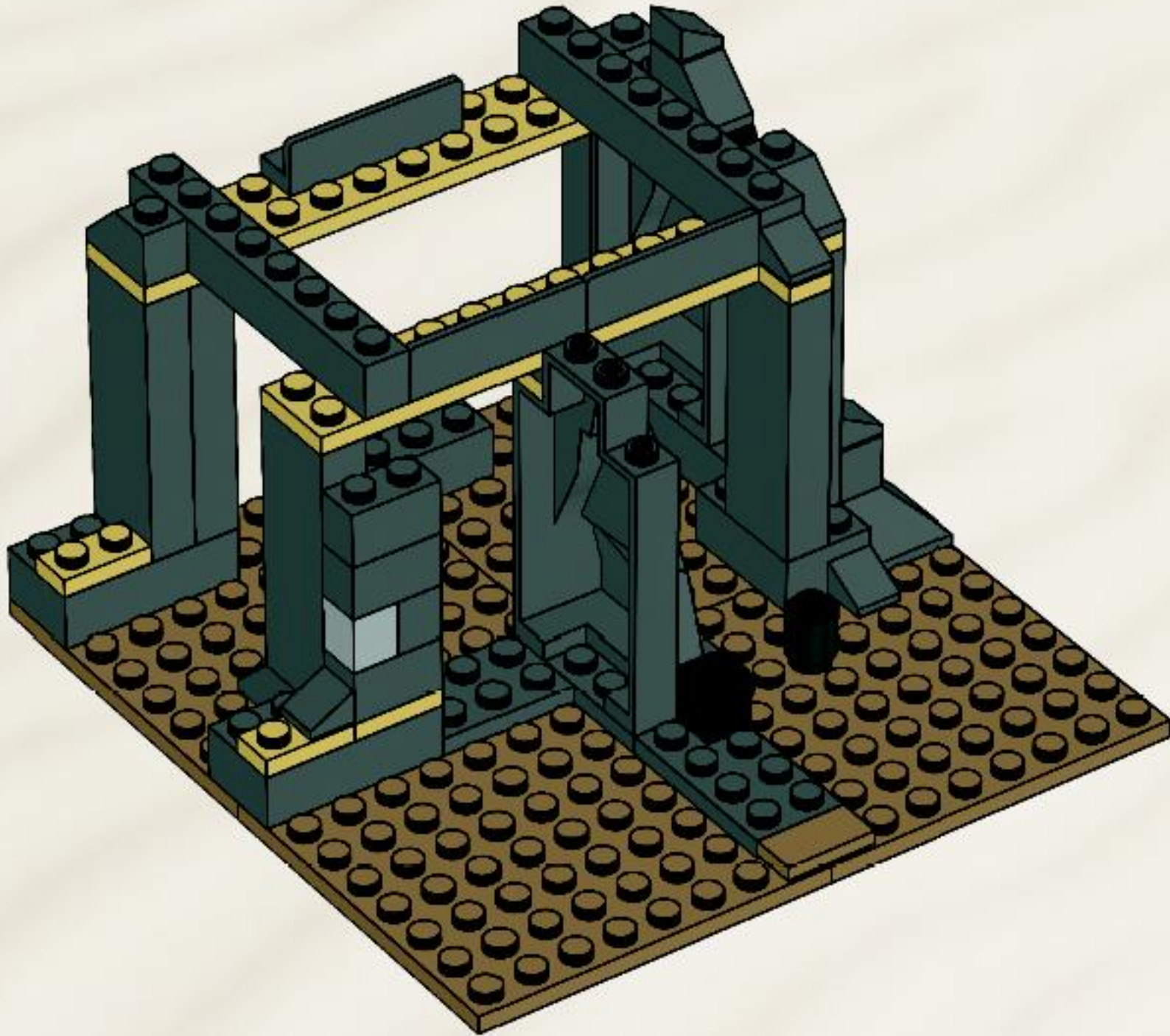

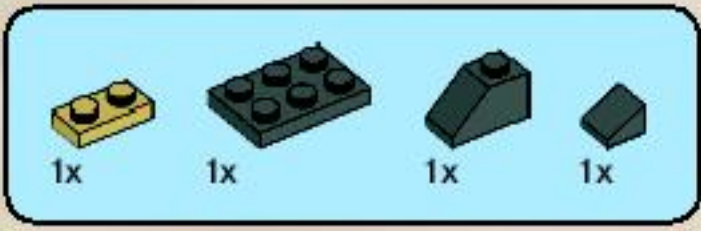

20

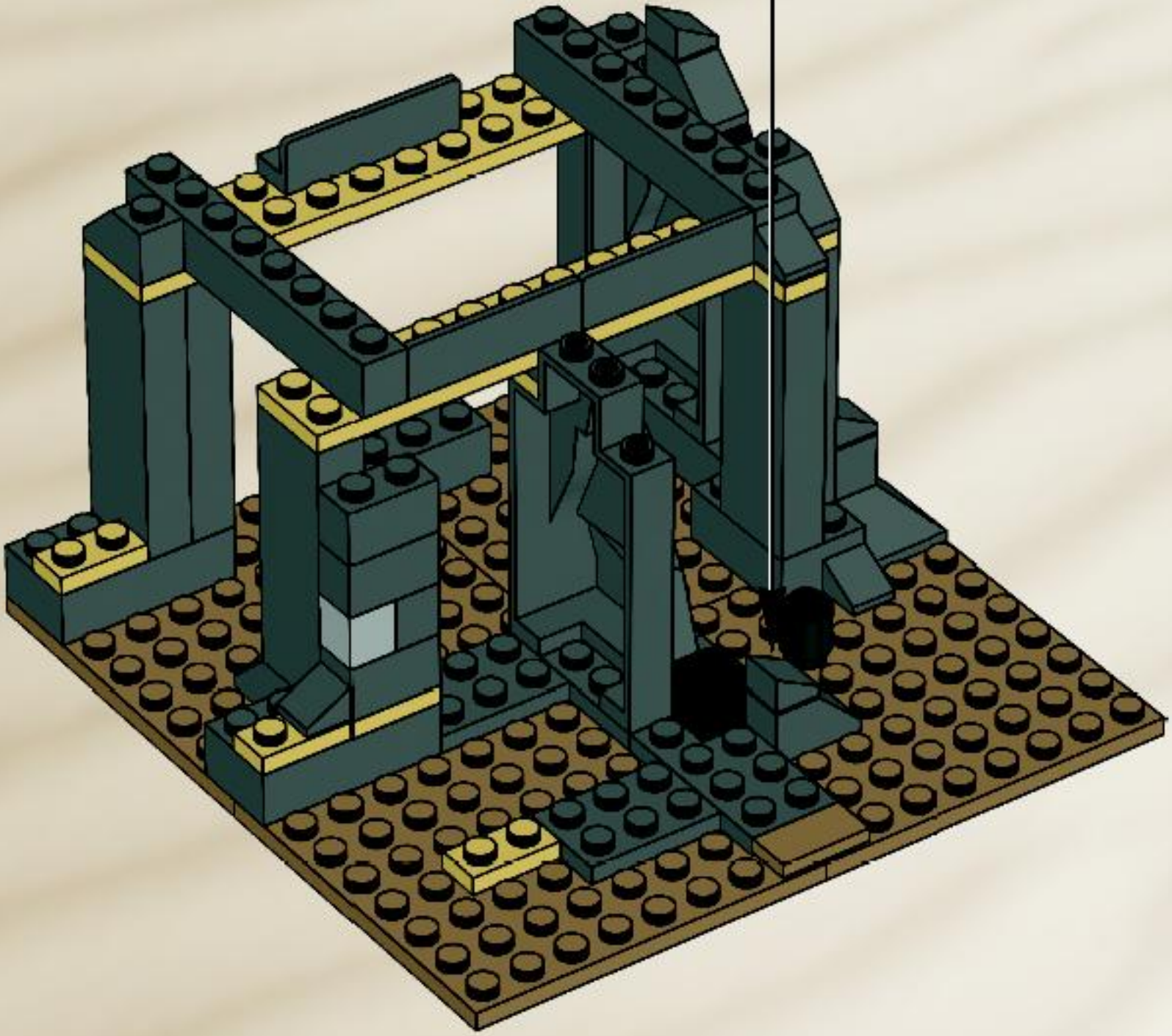
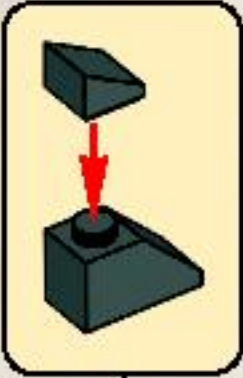

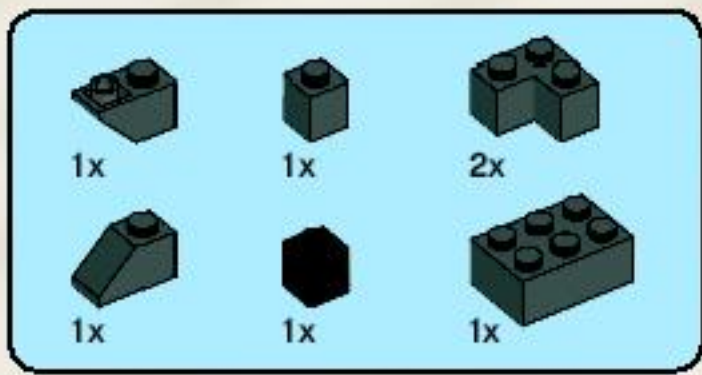

21

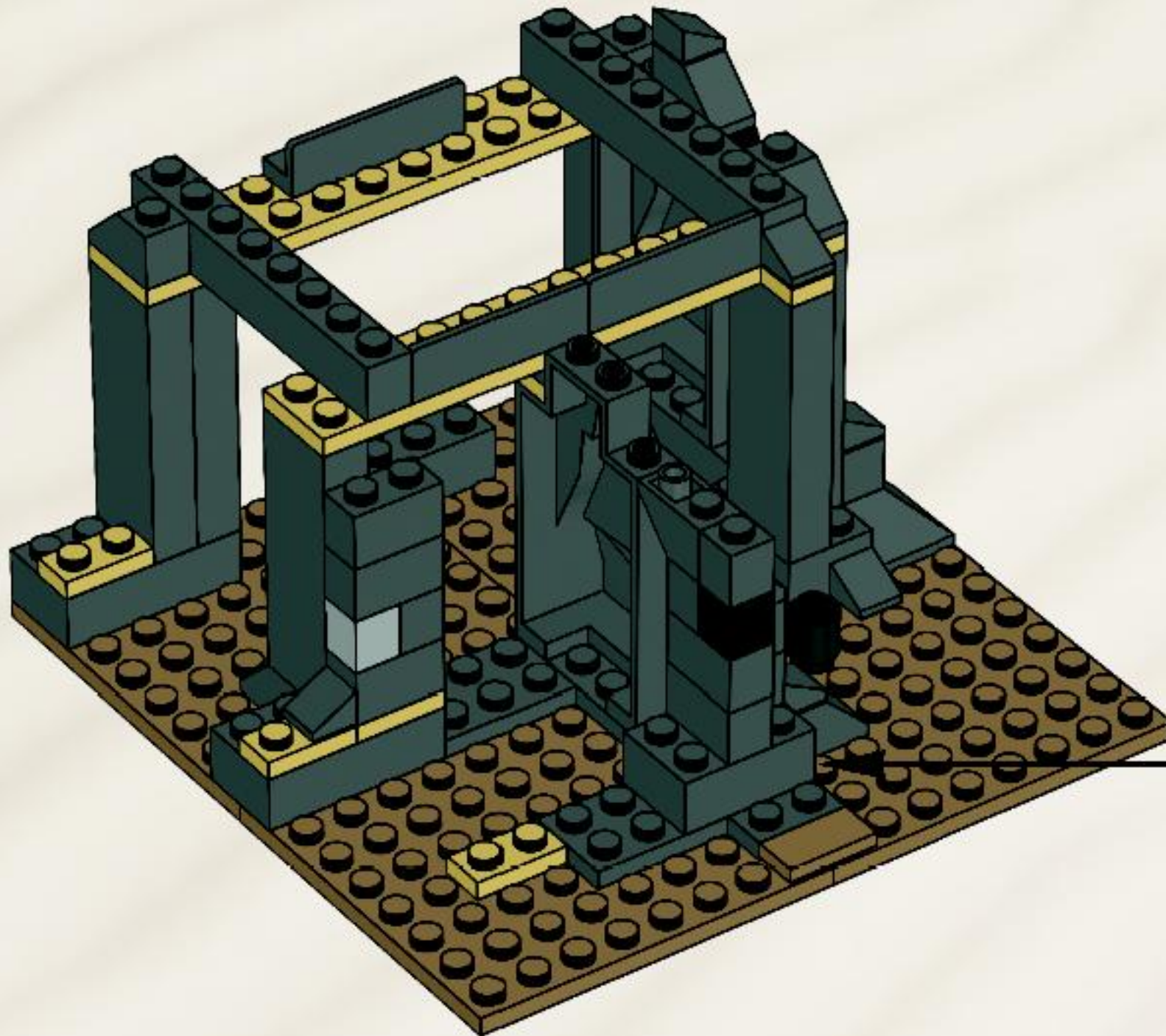
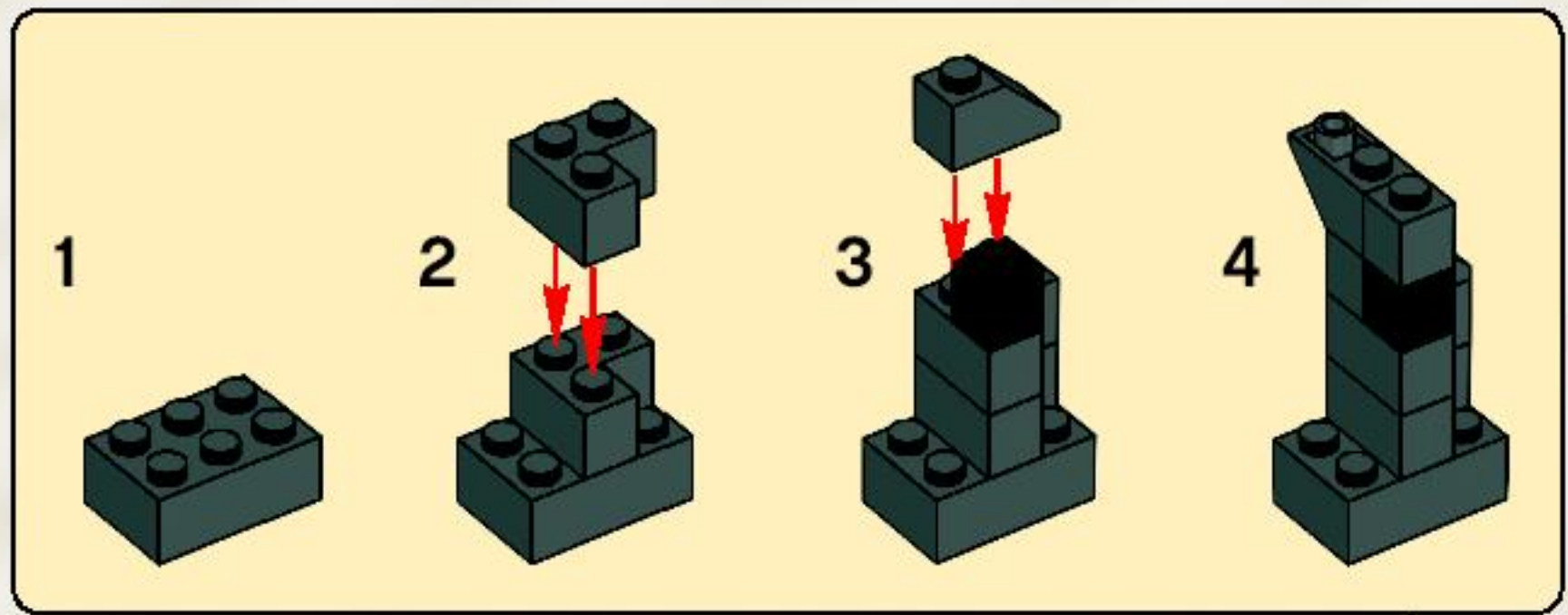

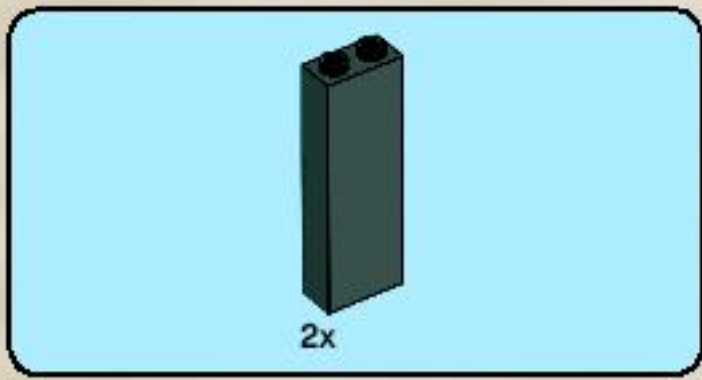

22

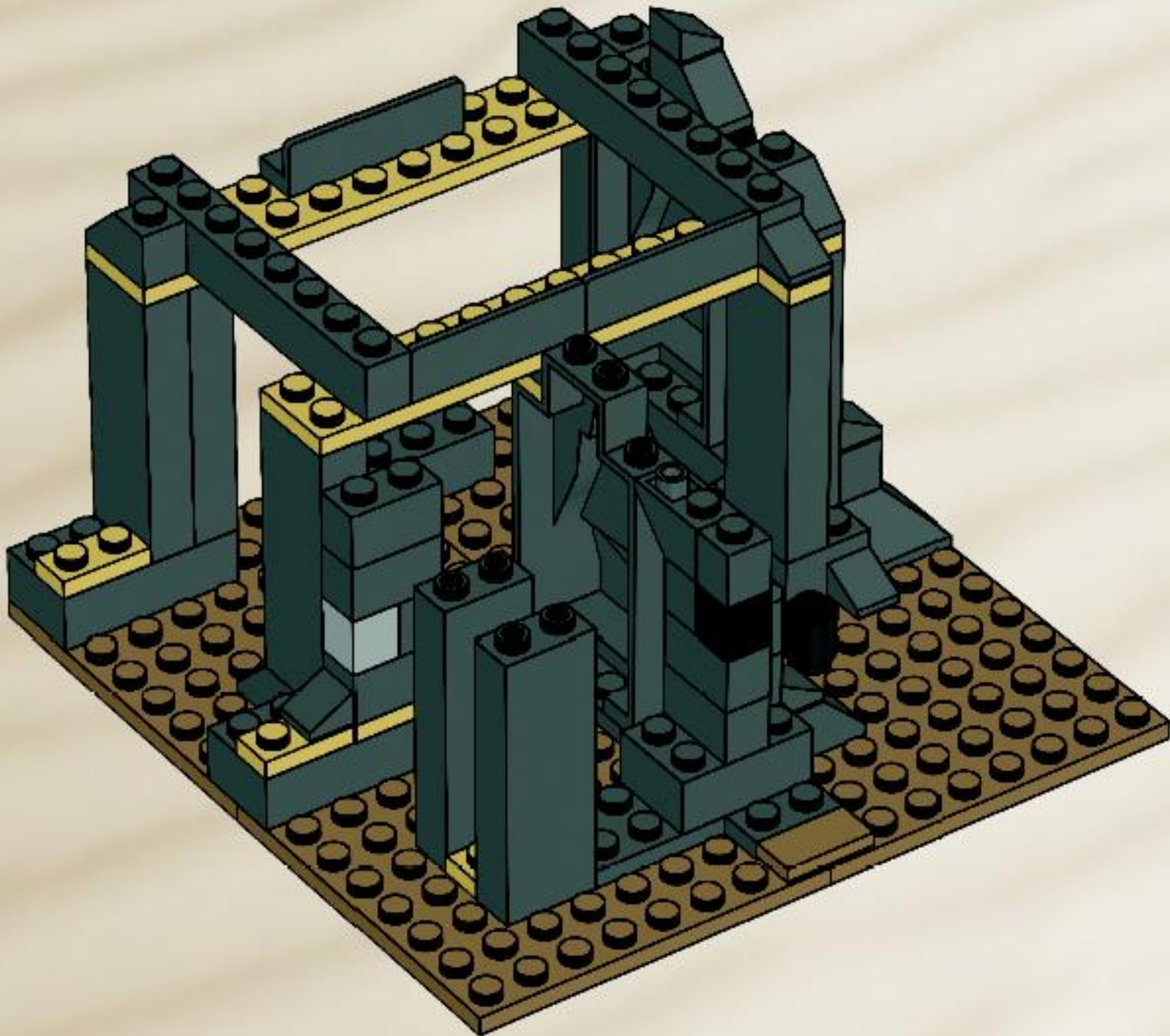

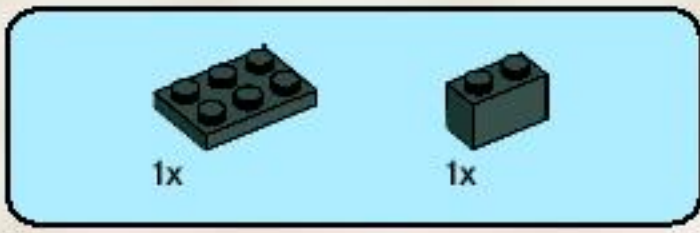

23

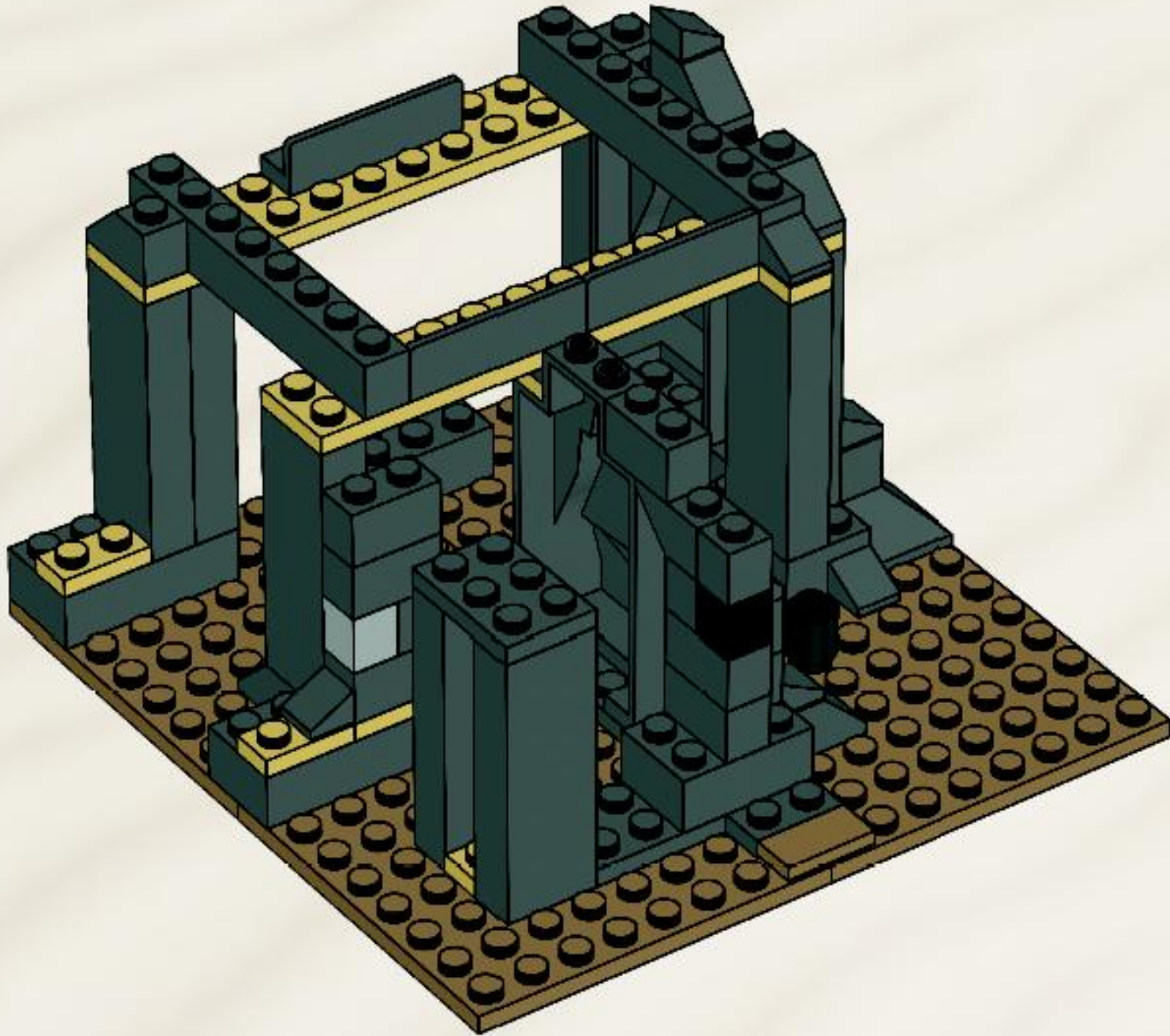

2x 1x

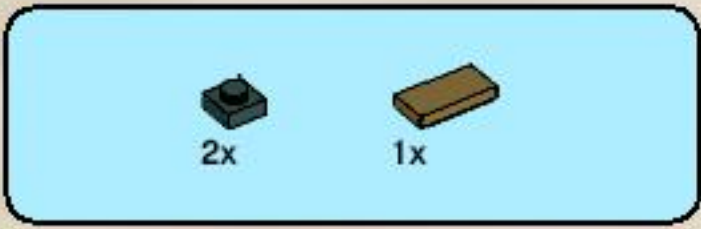



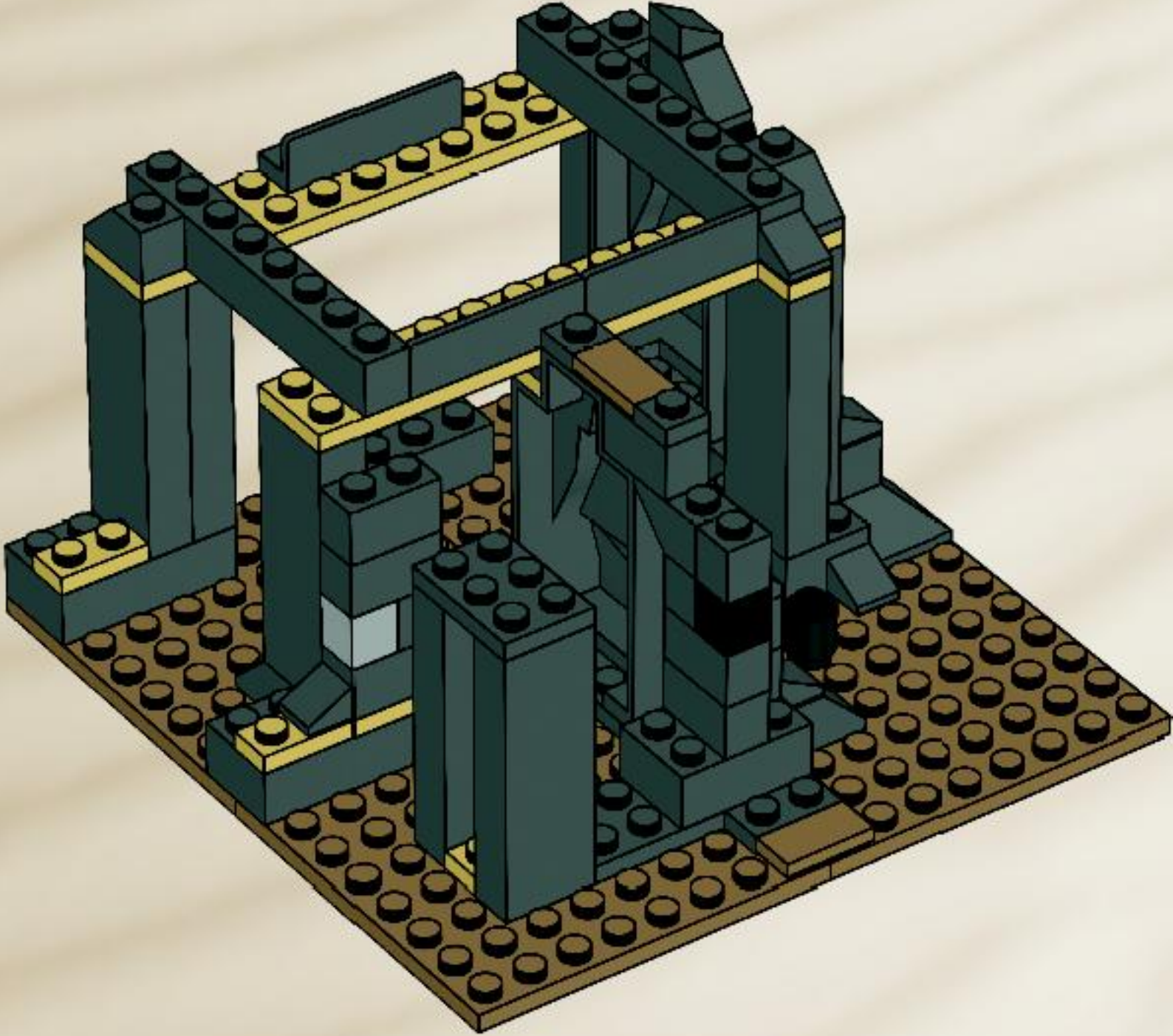

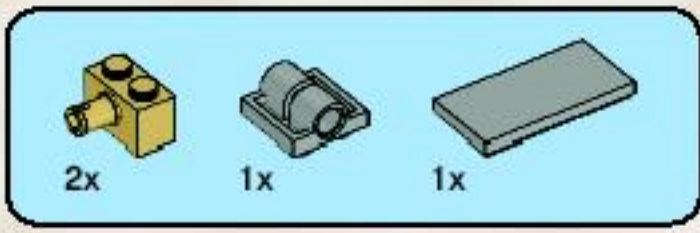
24



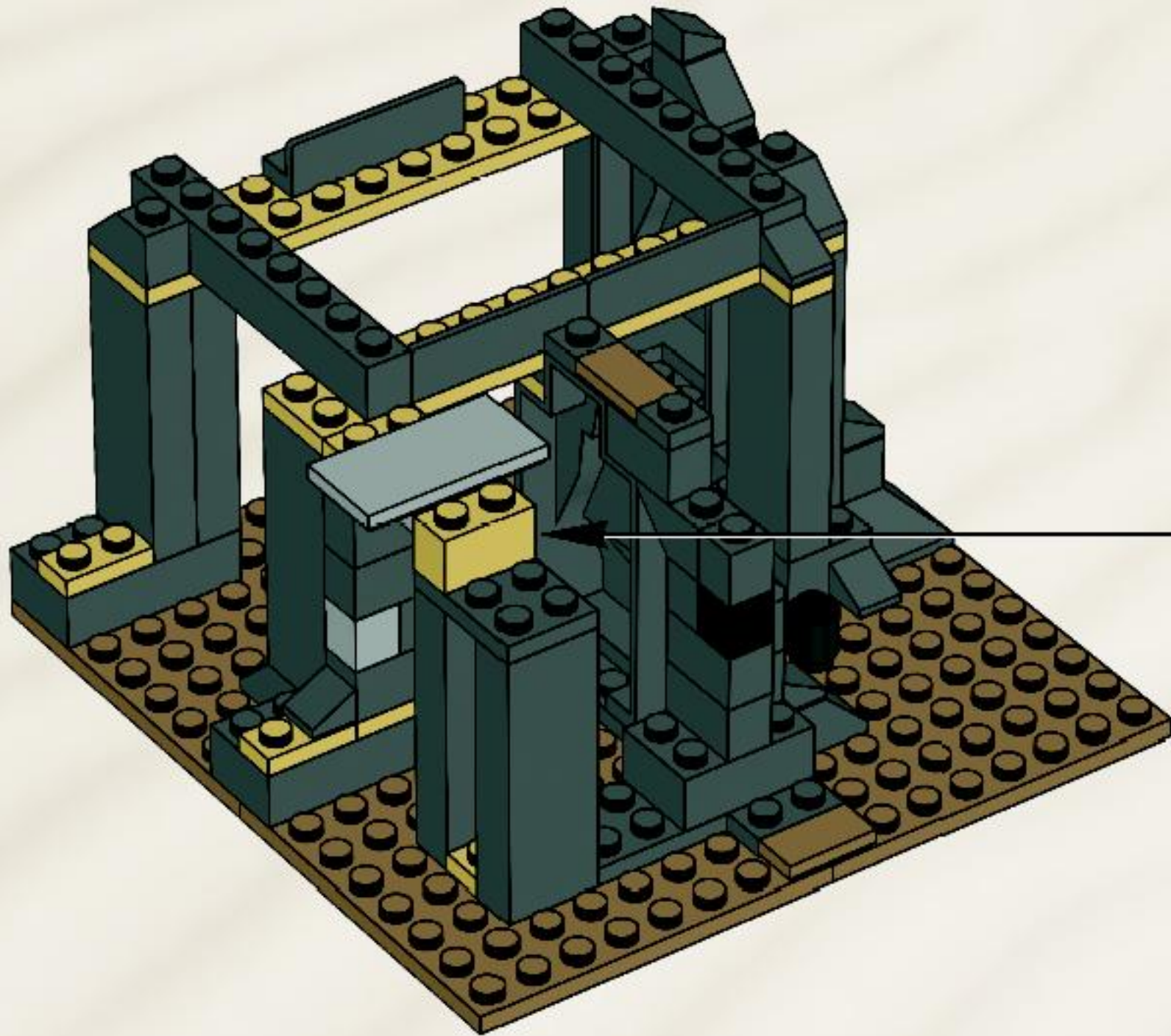
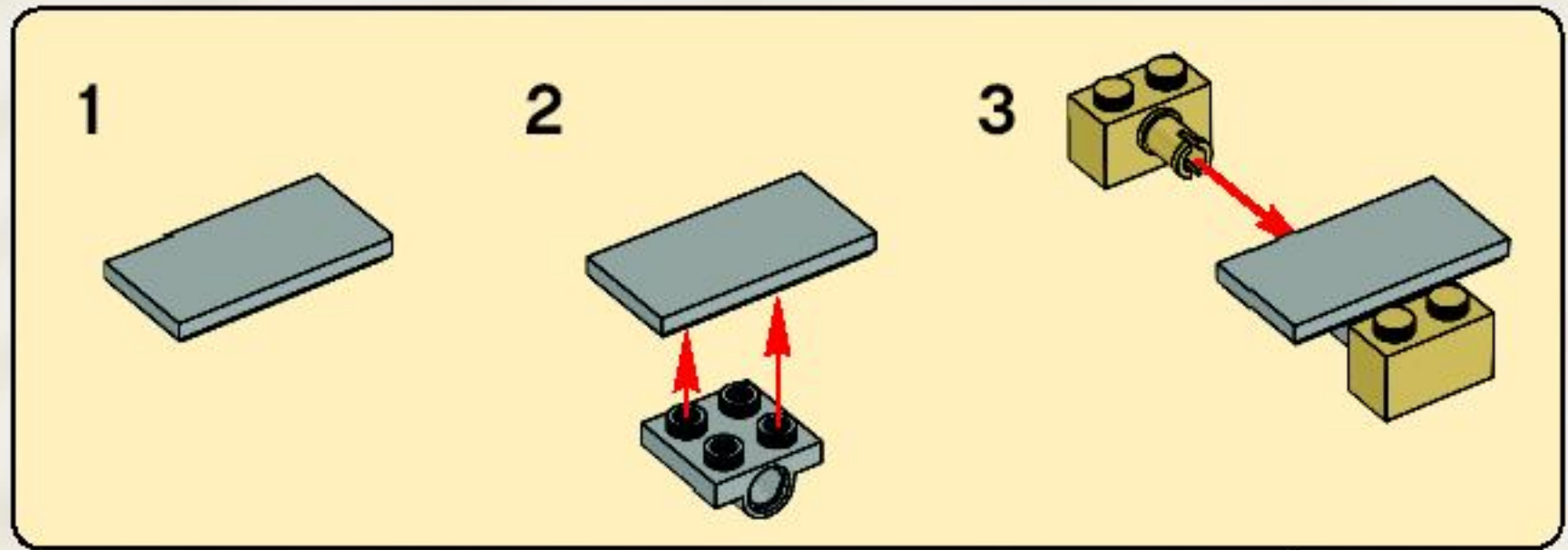

25



1x  1x  2x 

26

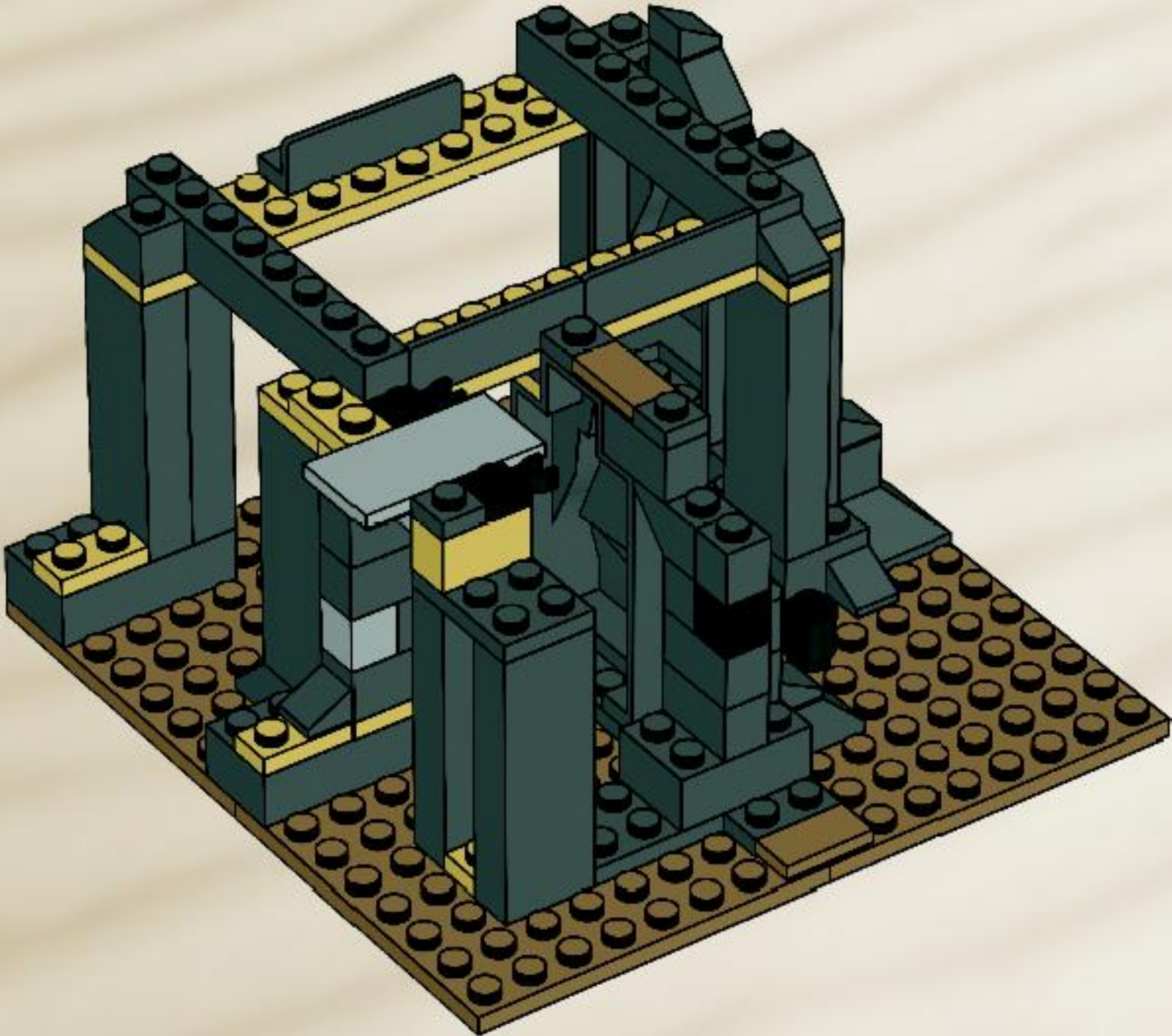

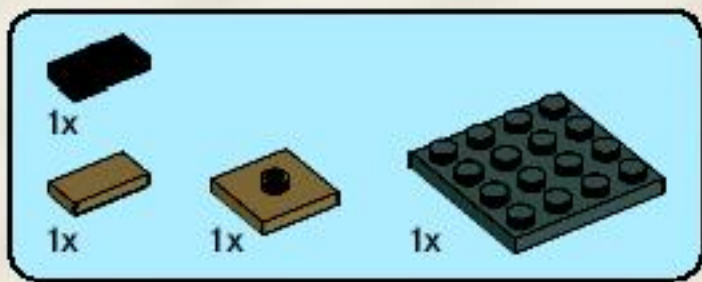

27

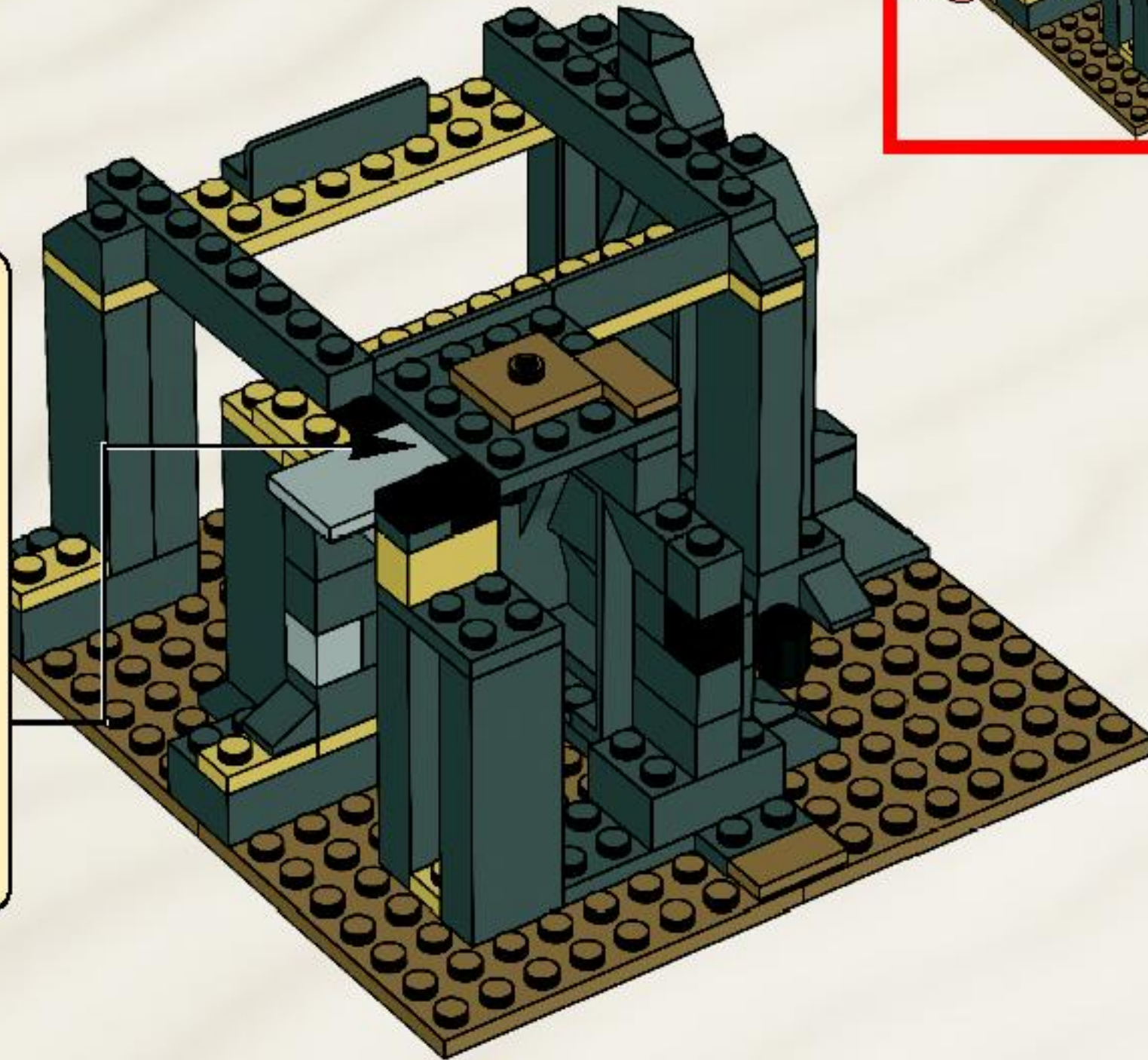
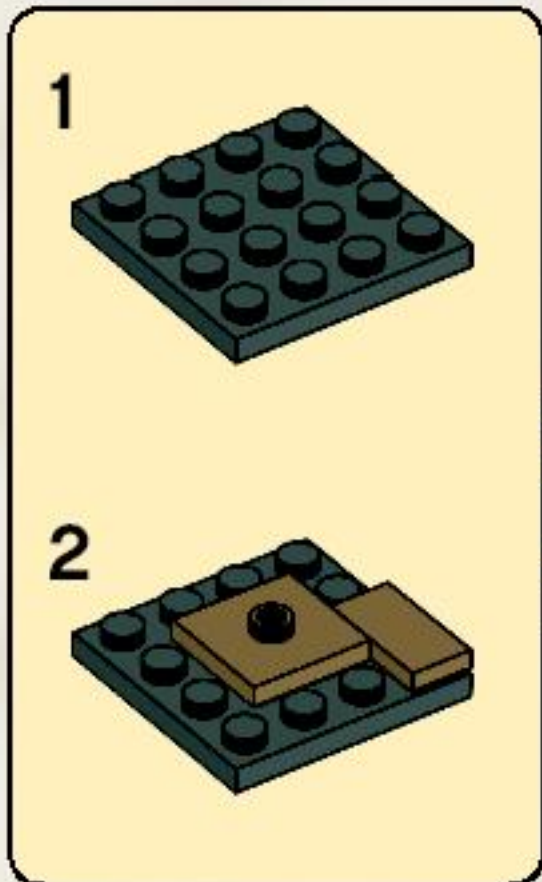
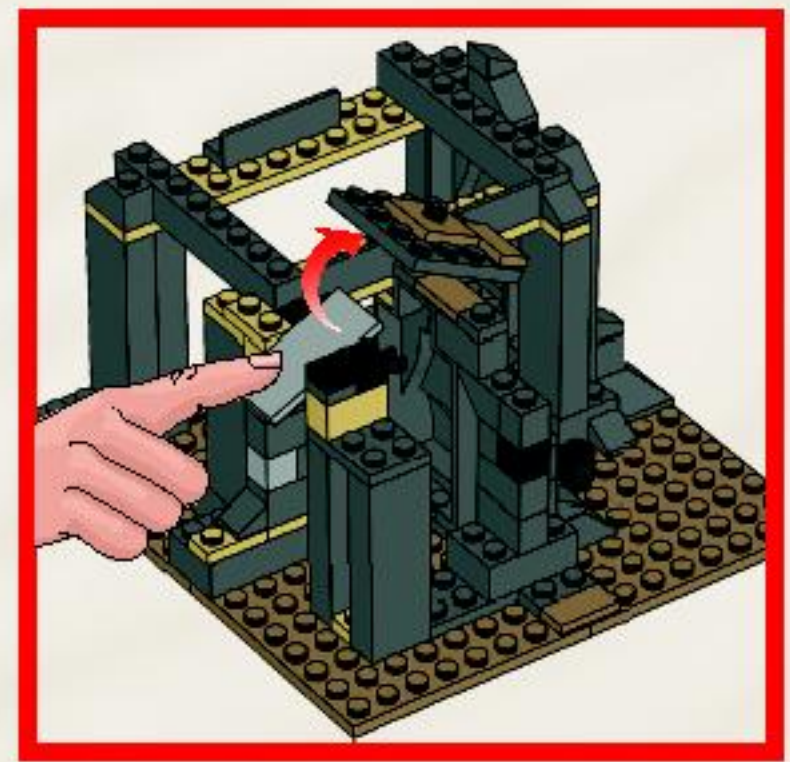

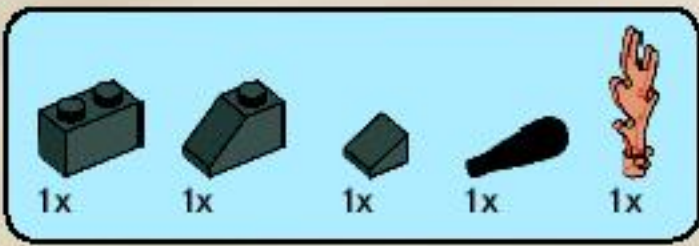

28

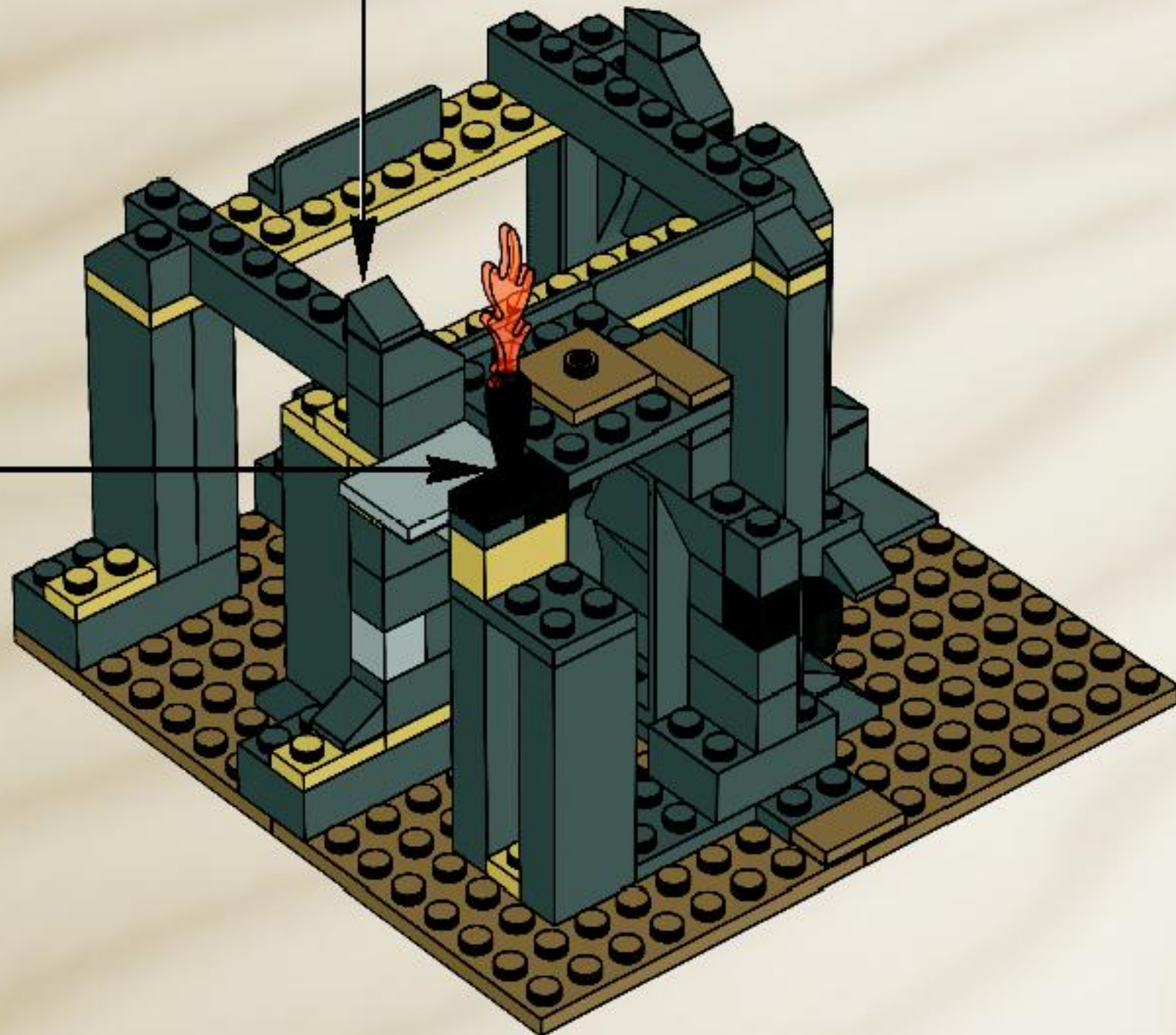
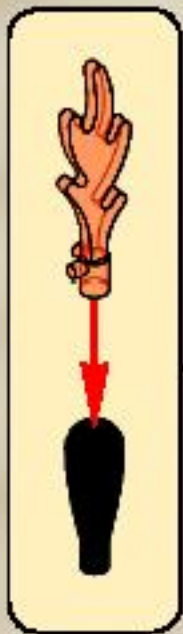
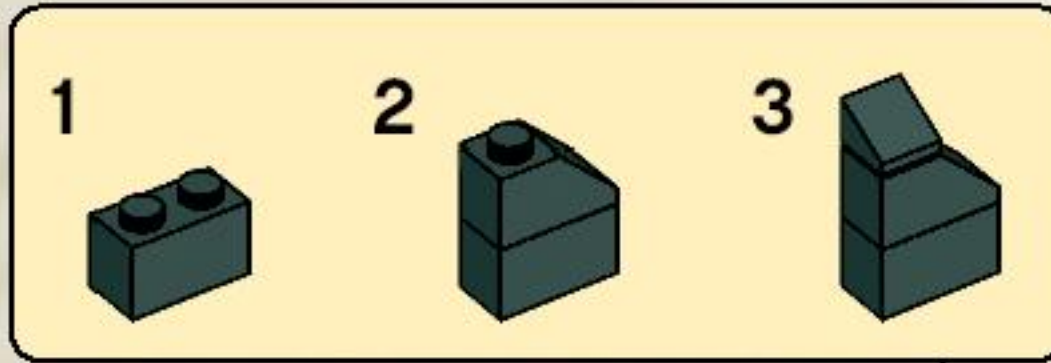

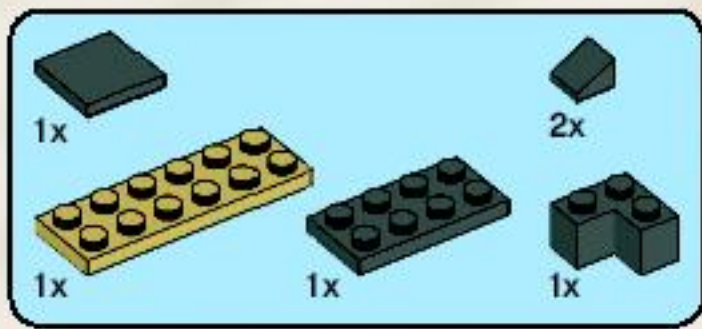

29

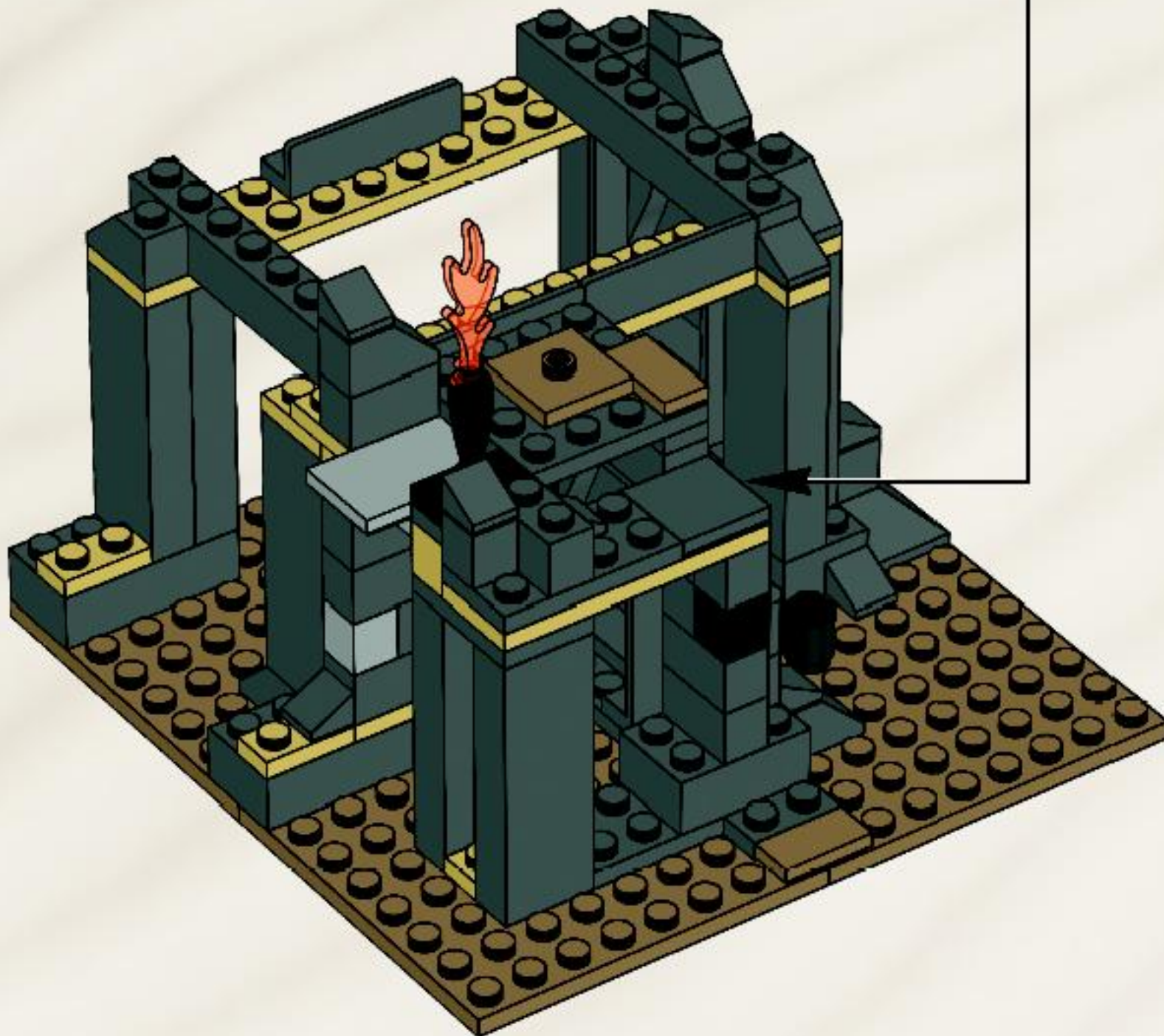
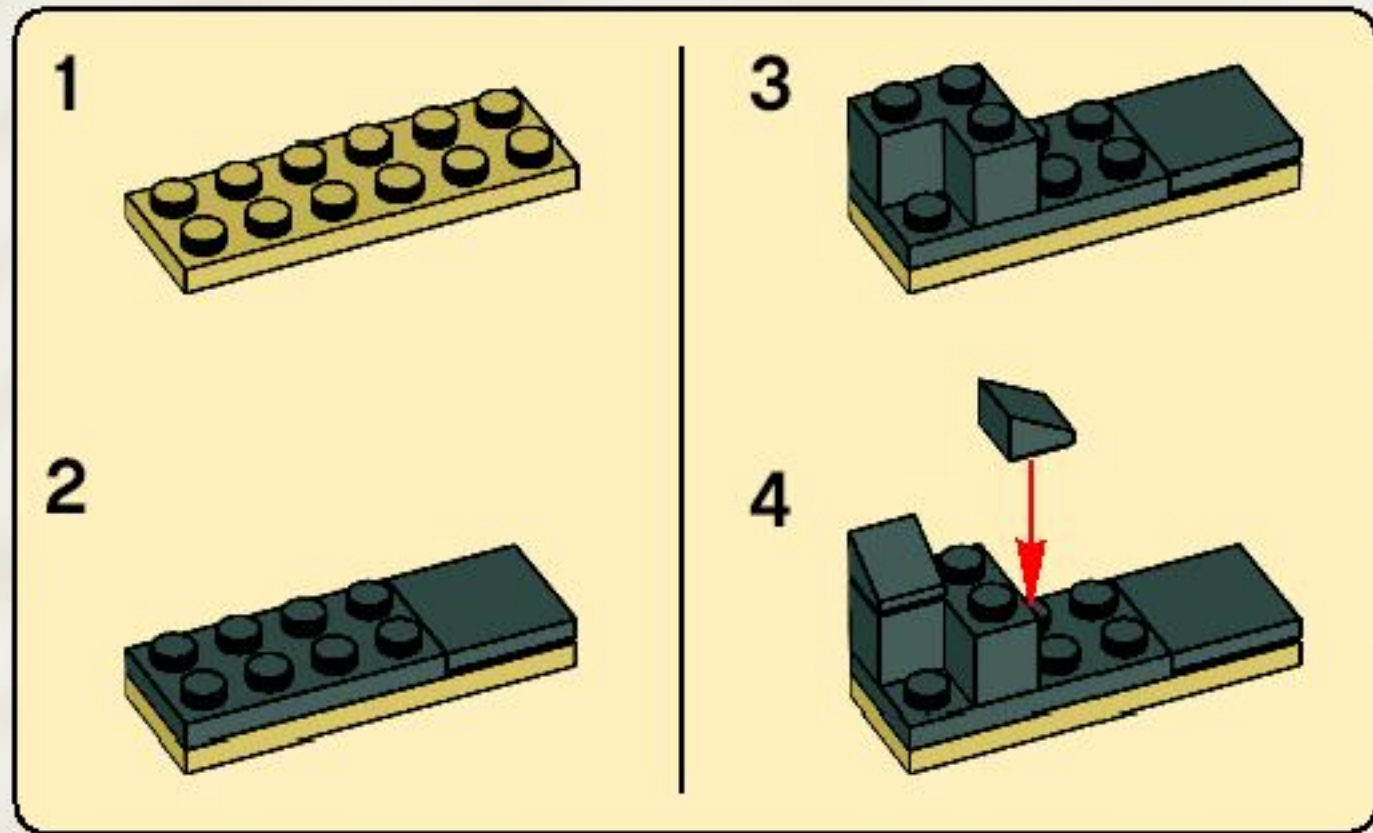

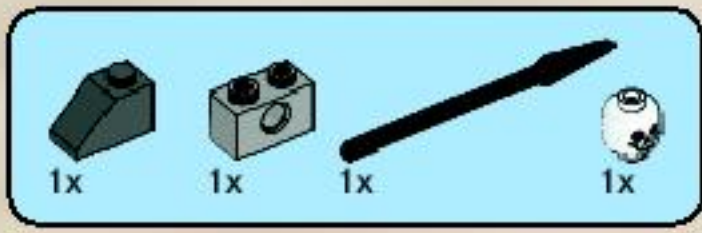

30

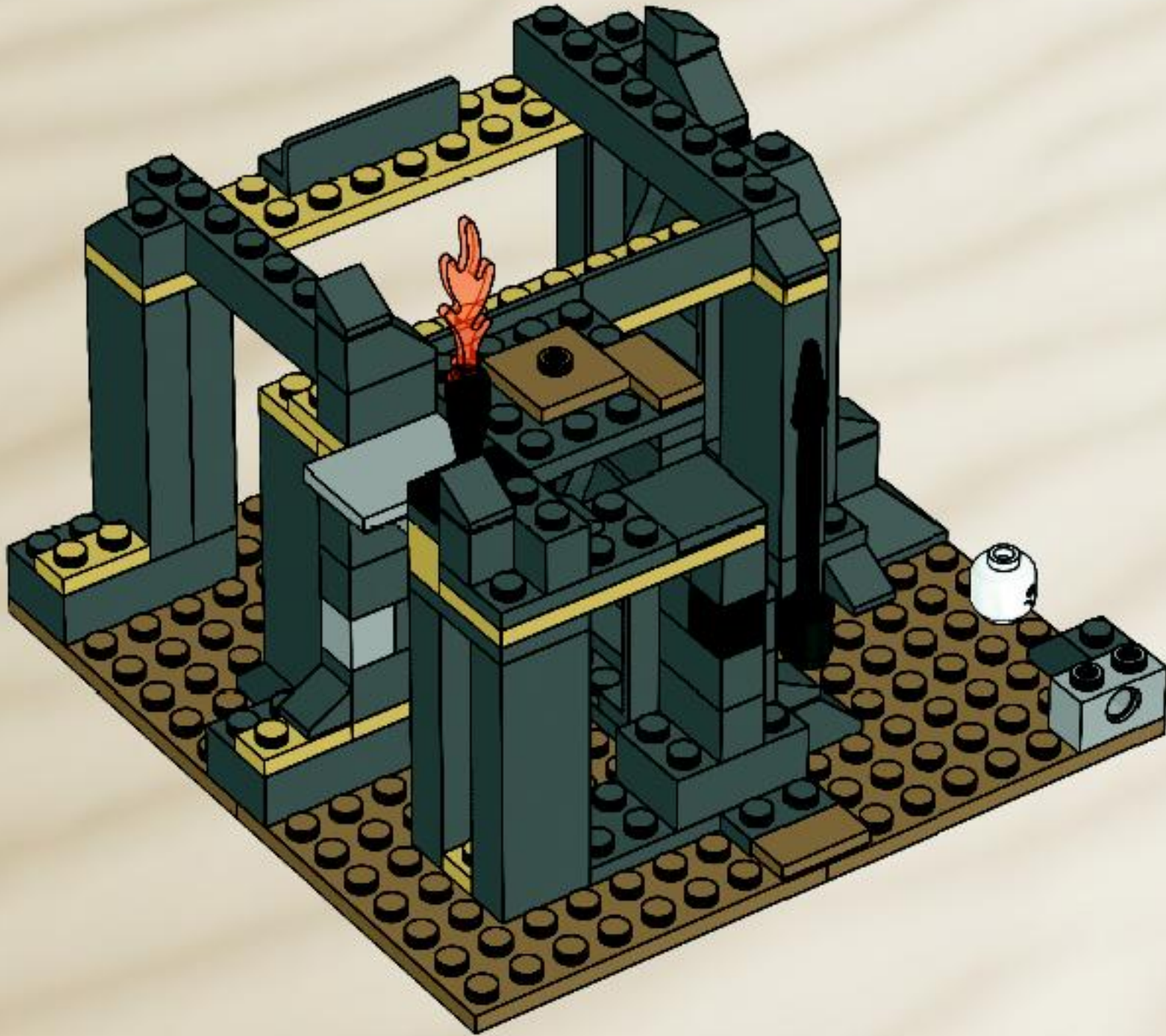

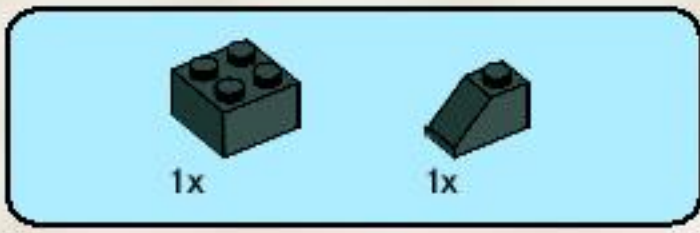

31

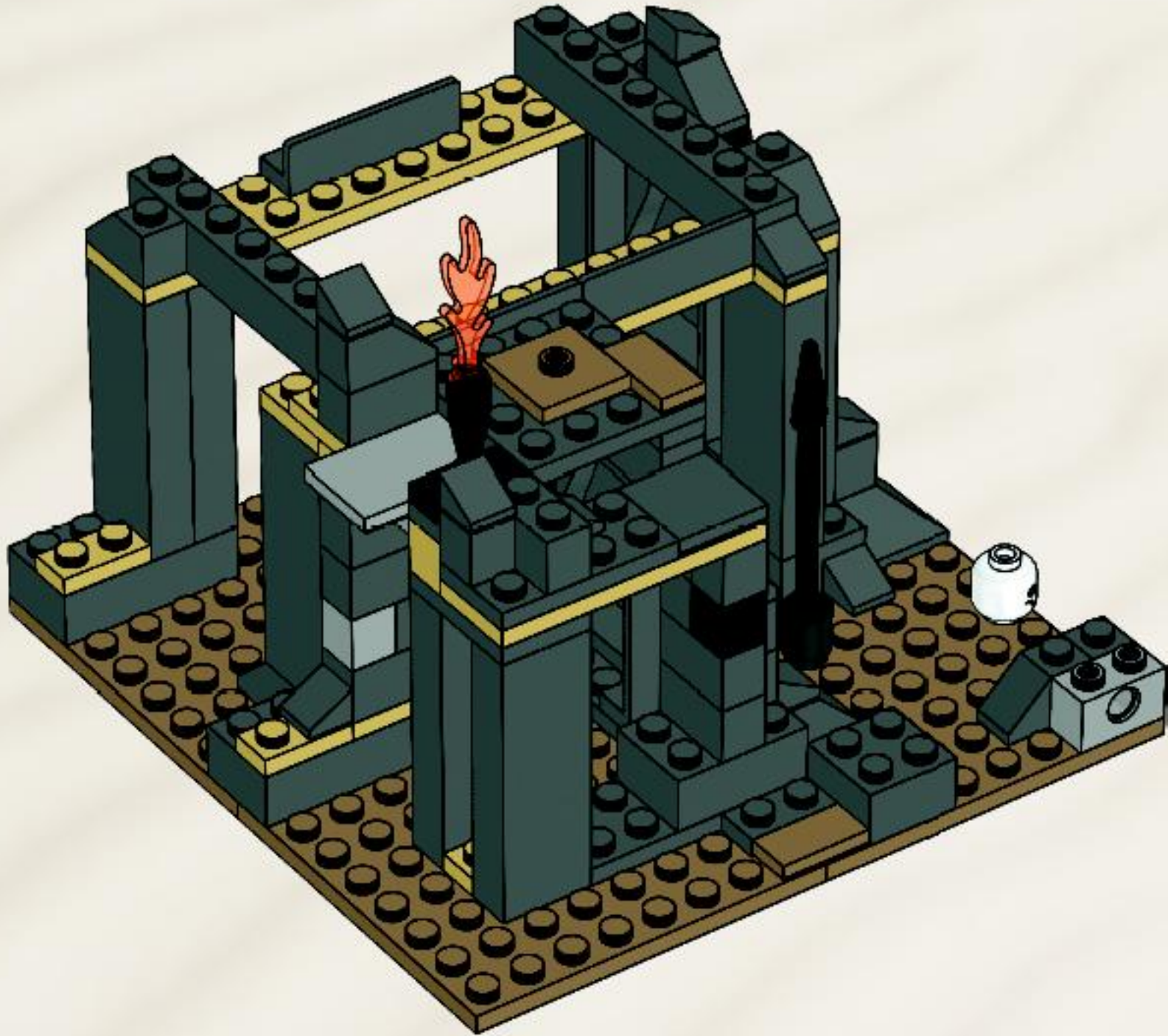



32

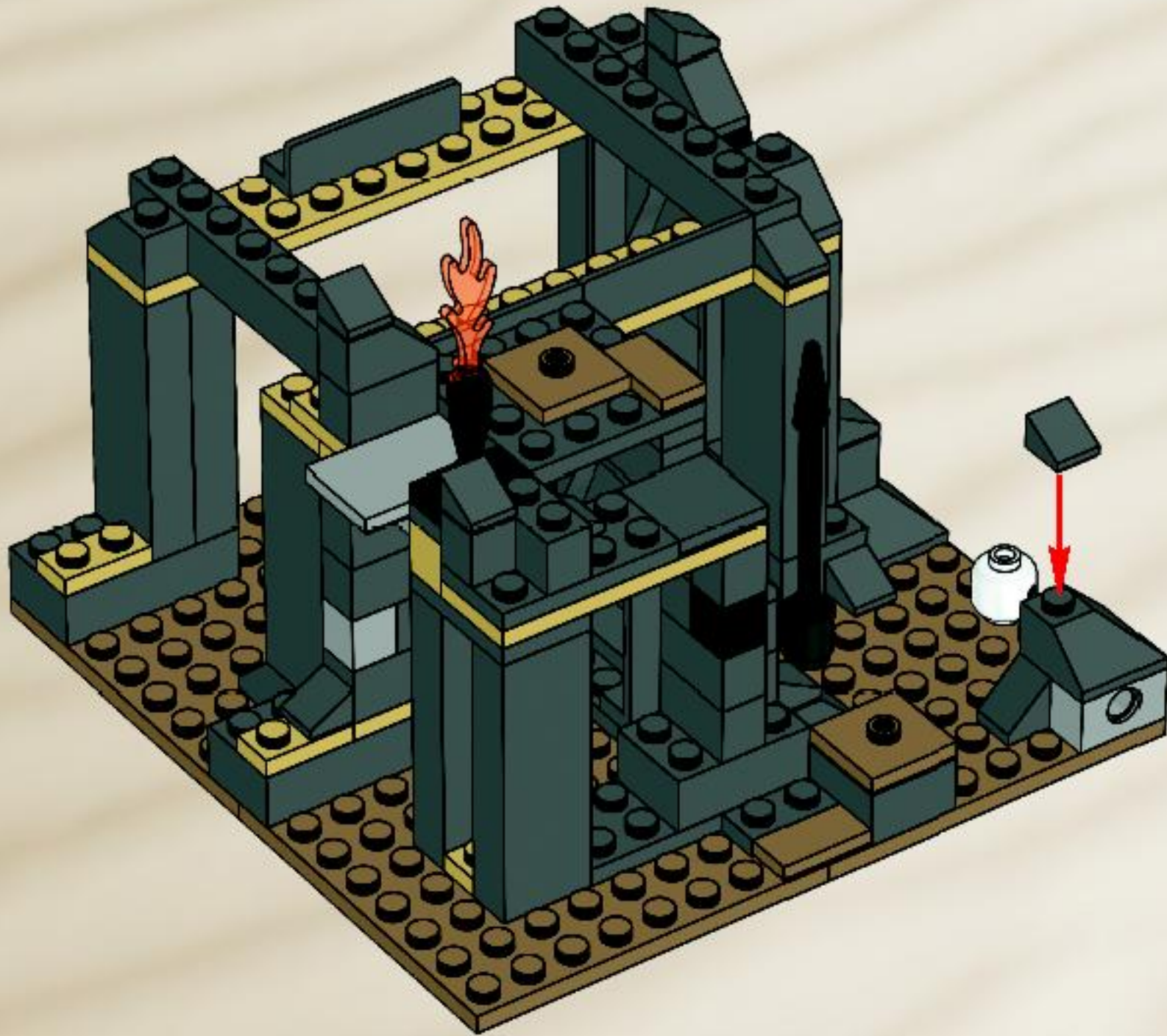

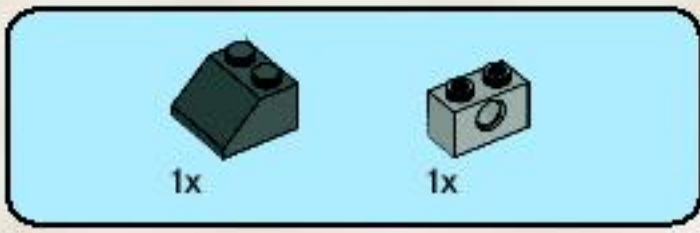

33

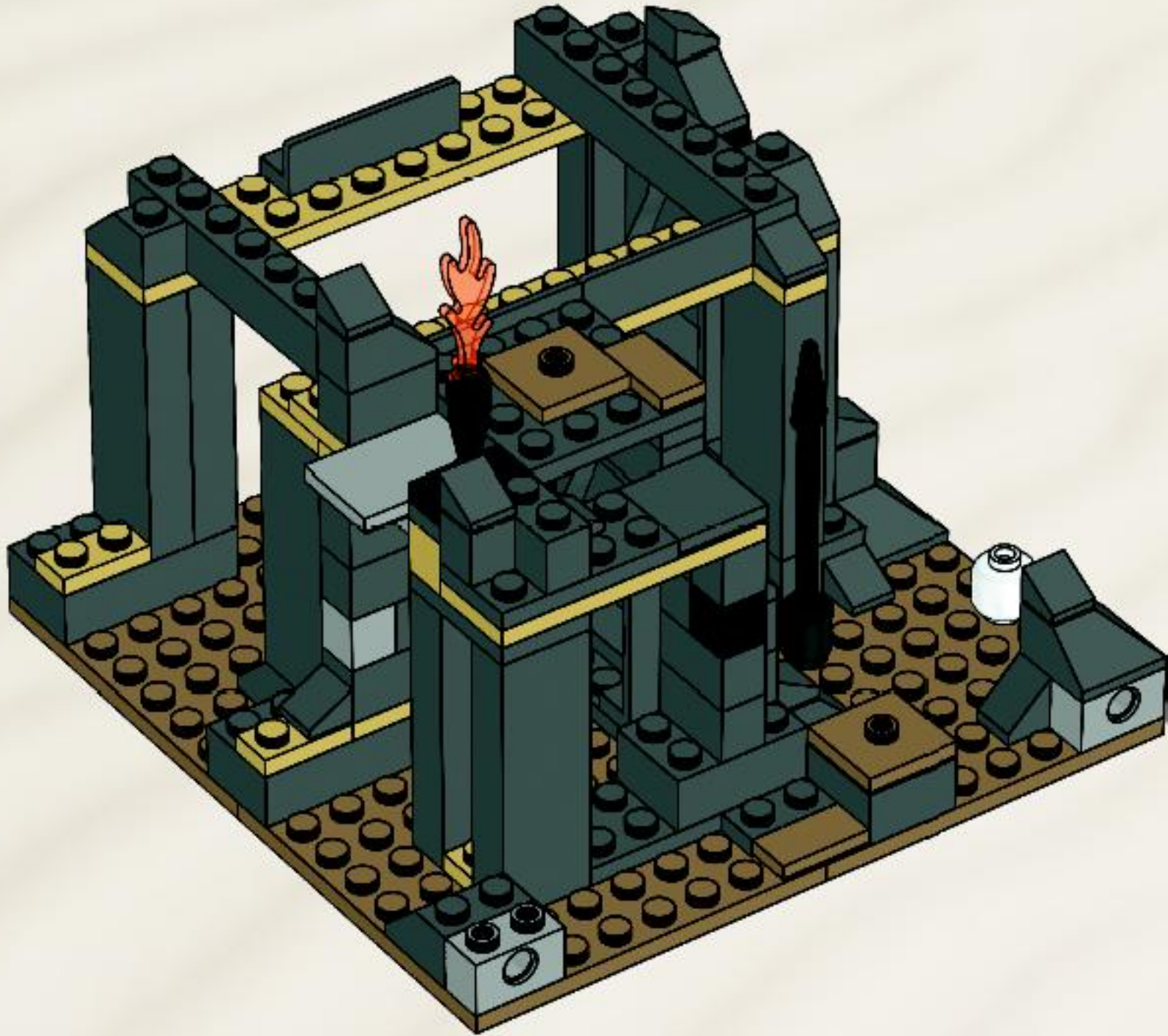

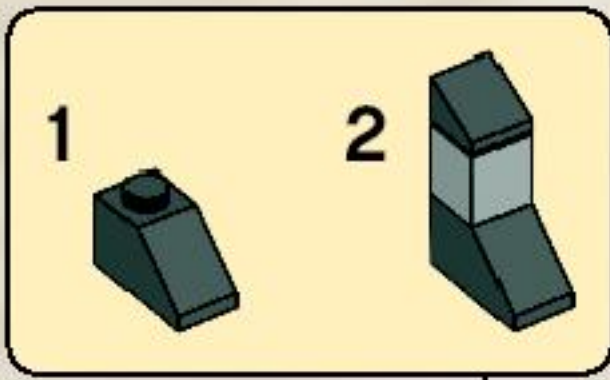
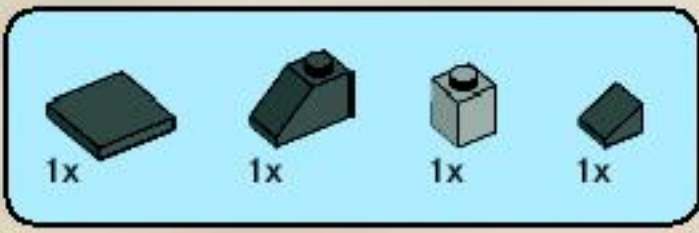

34

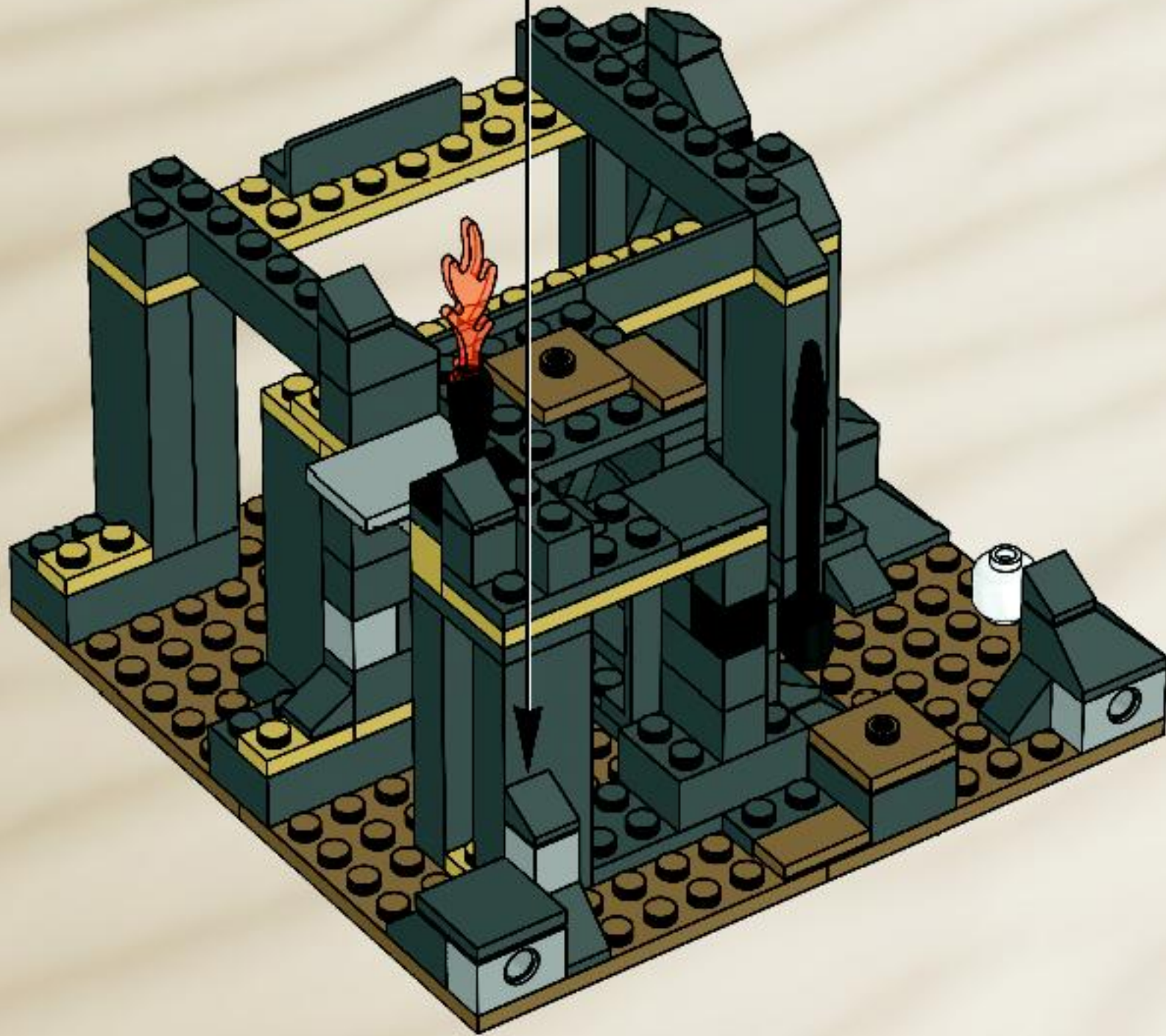

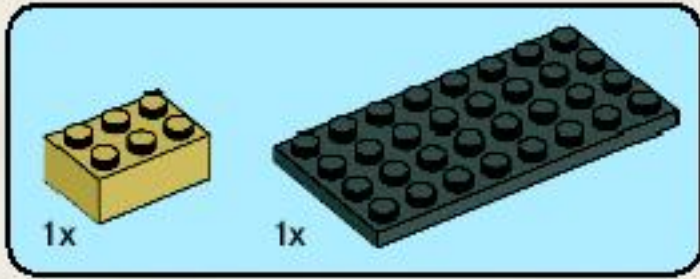
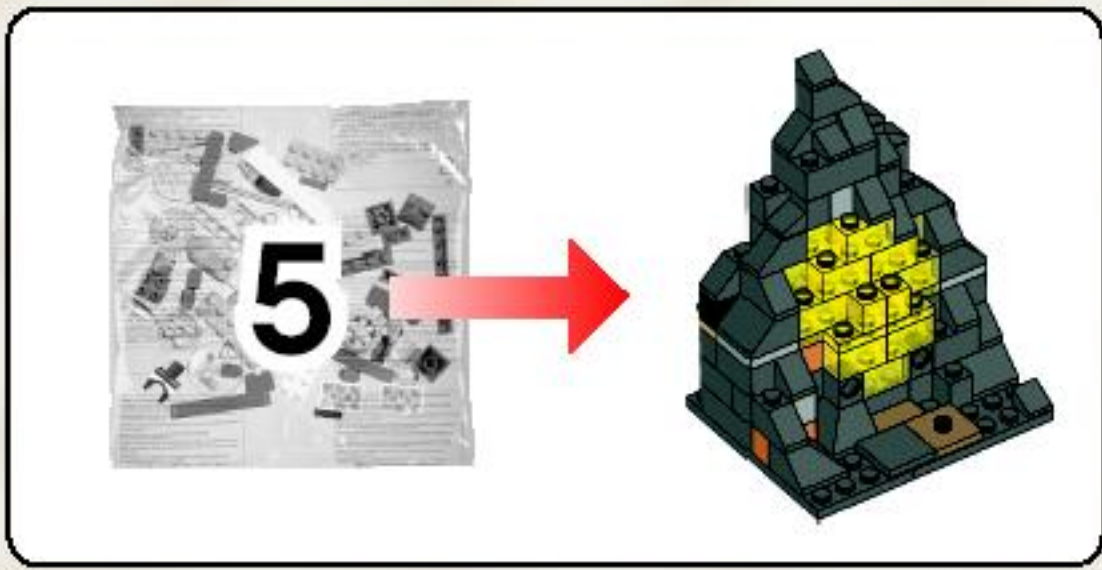

1

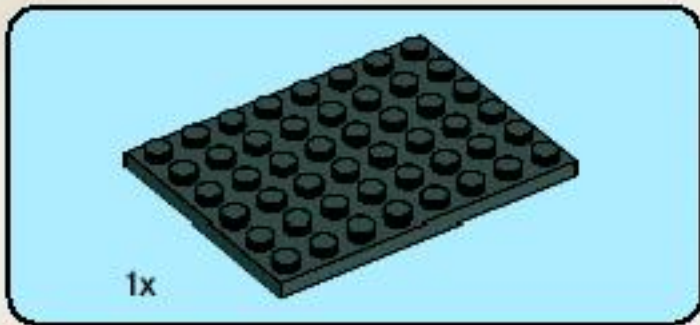
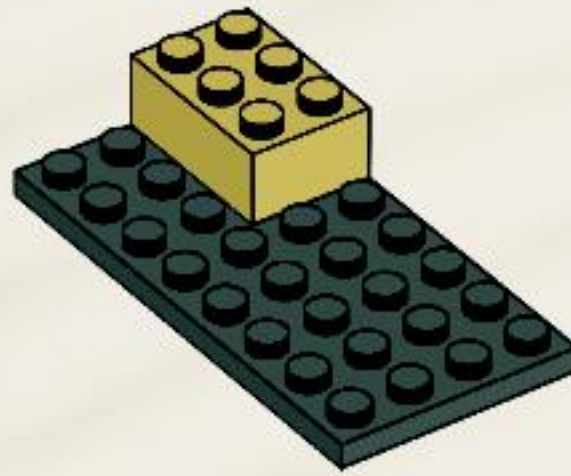

2

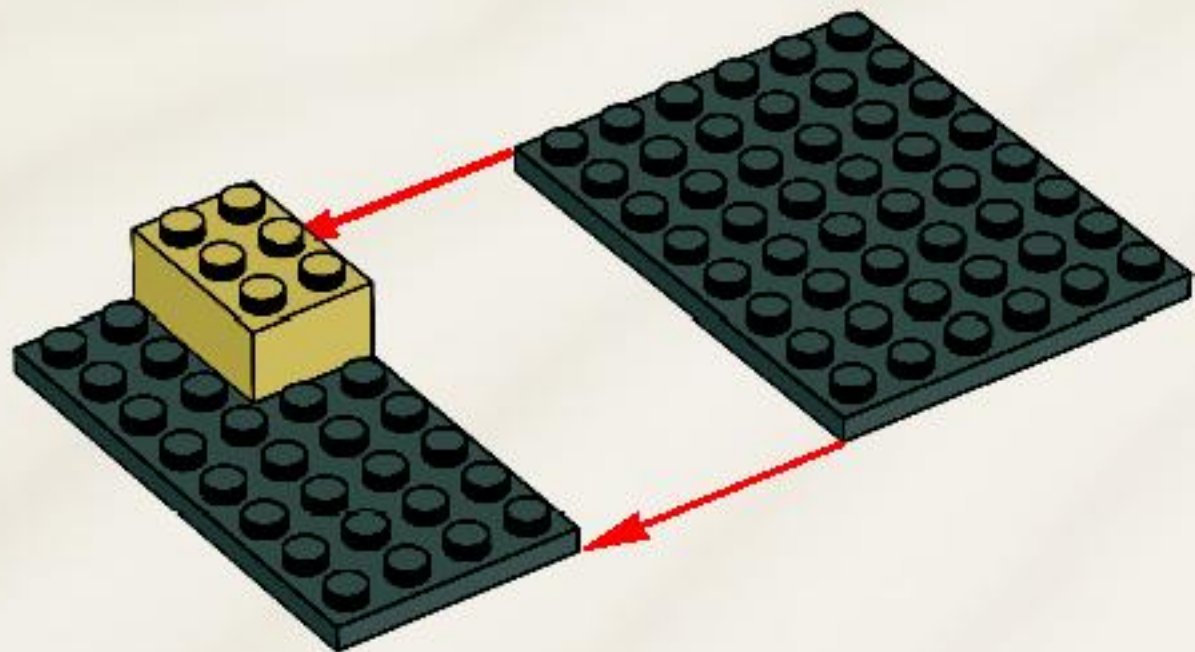

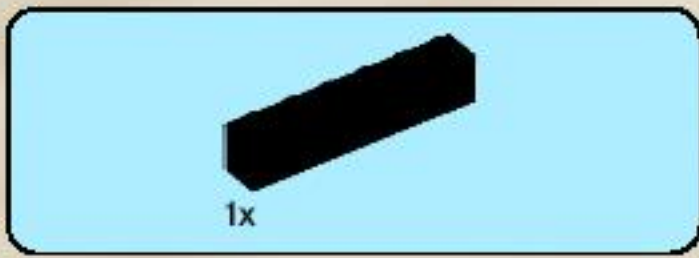

3

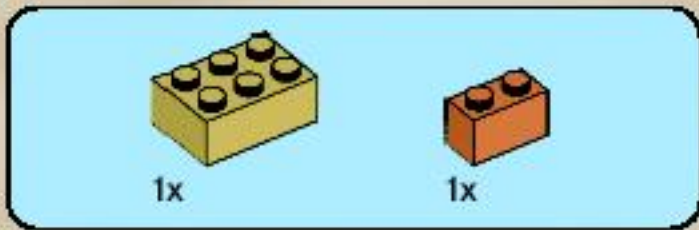
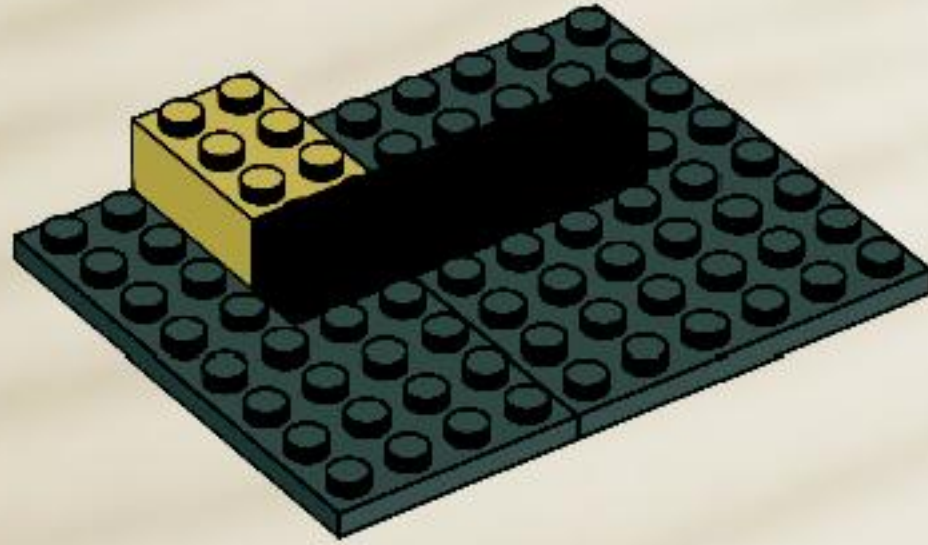

4

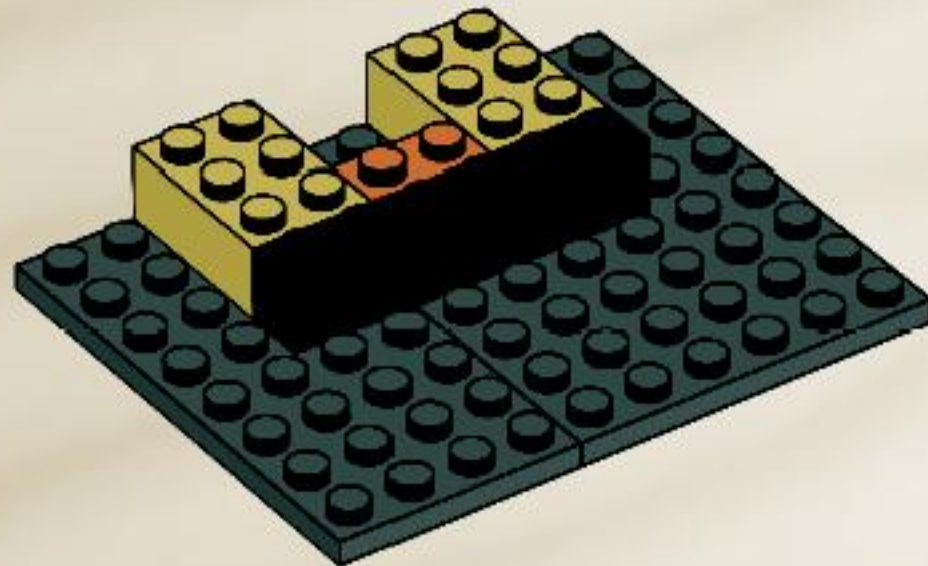

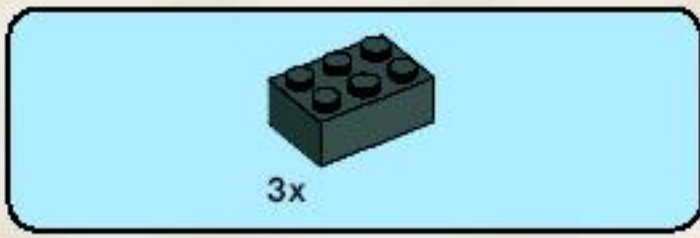

5

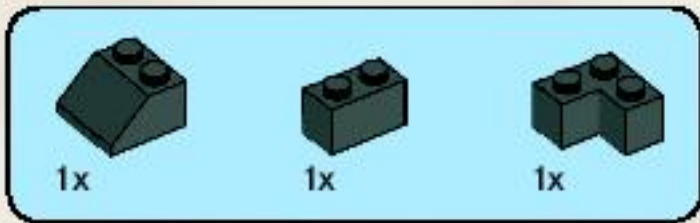
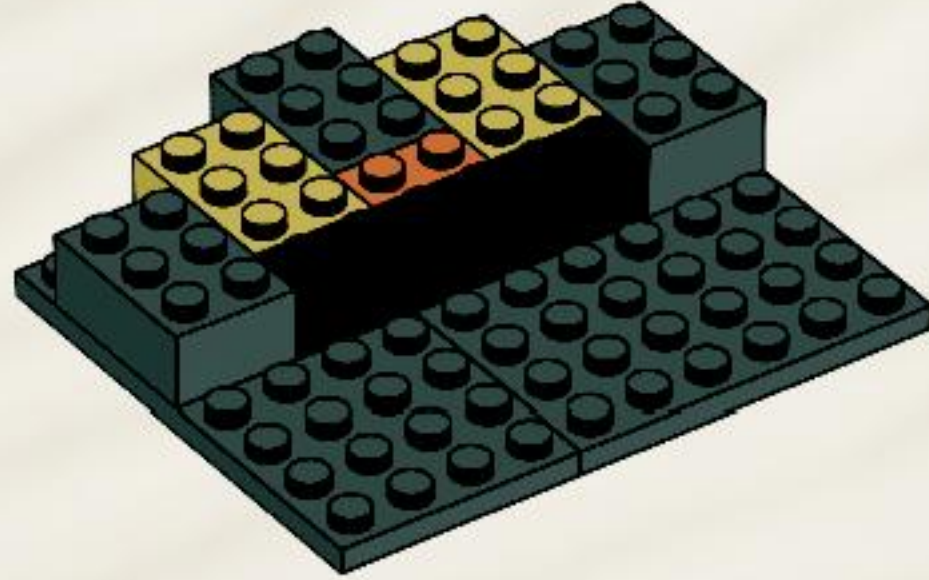

6

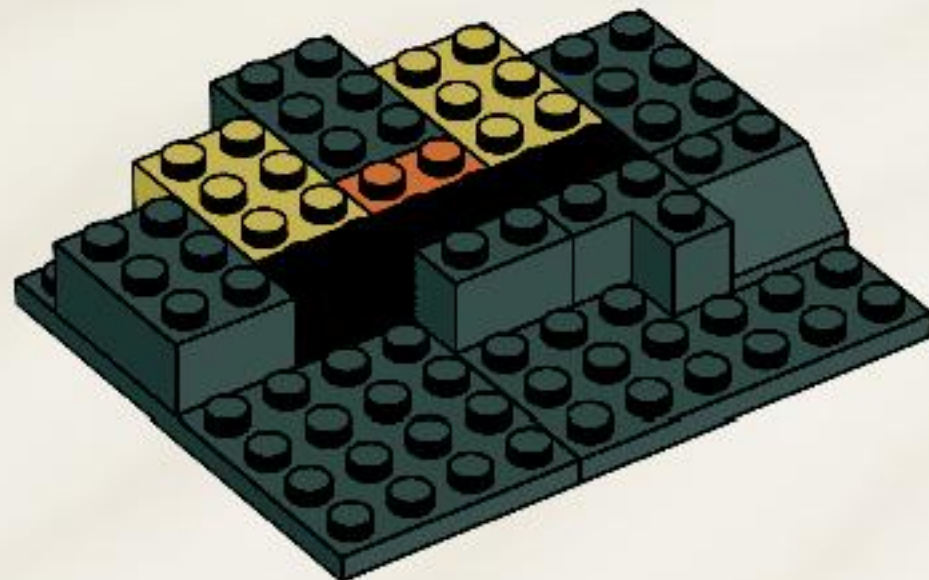



7

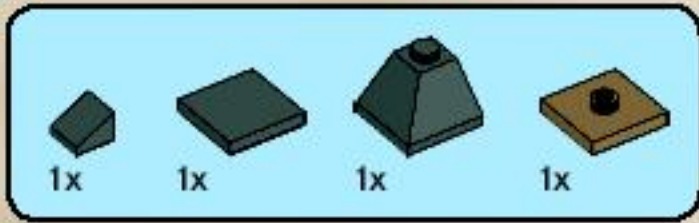
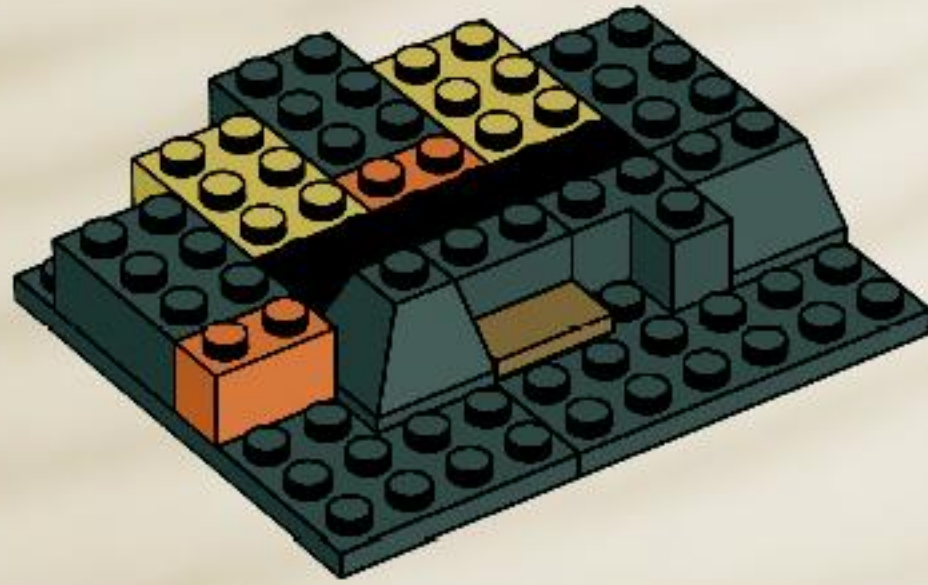

8

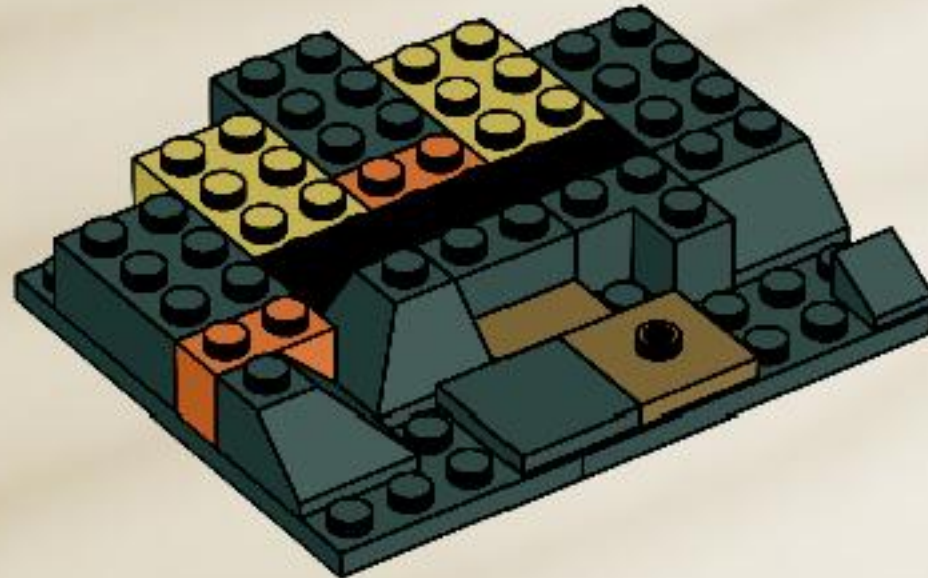

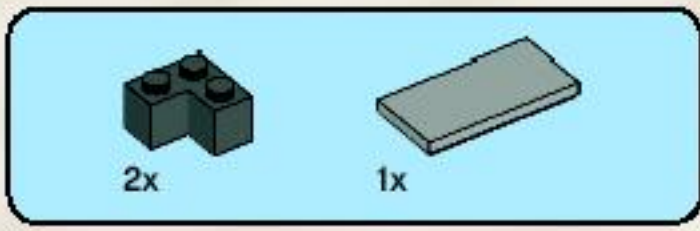

9

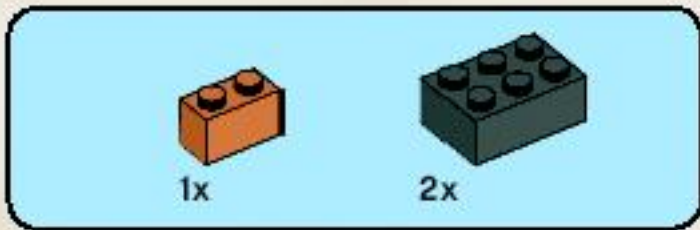
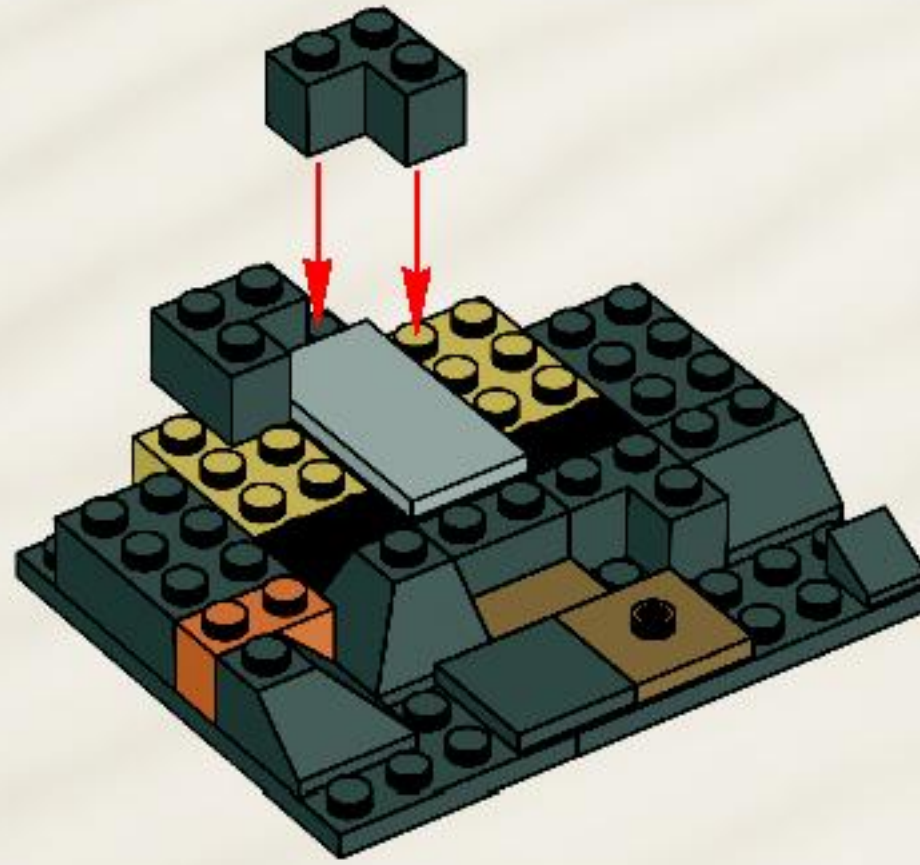

10

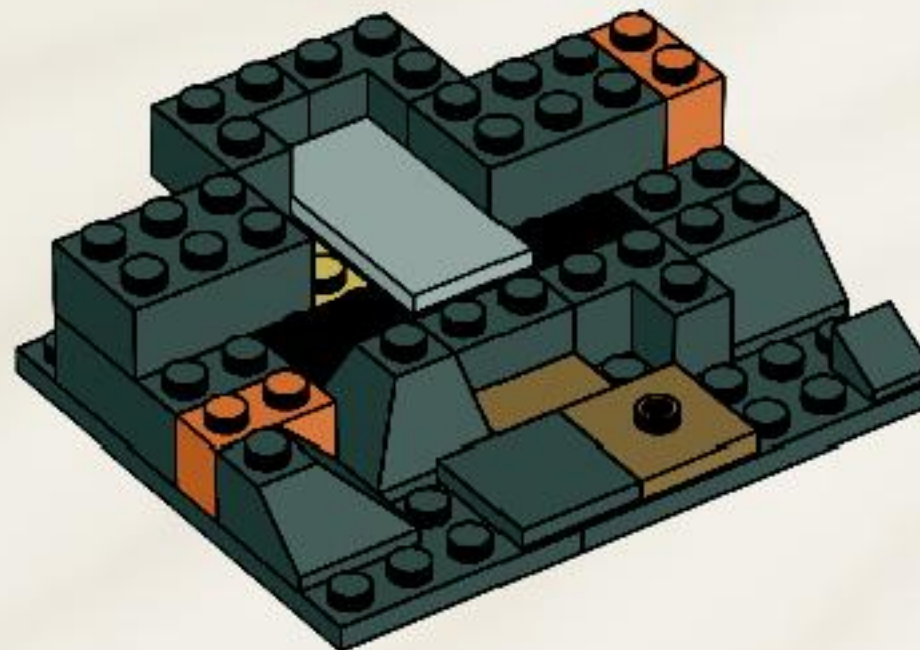

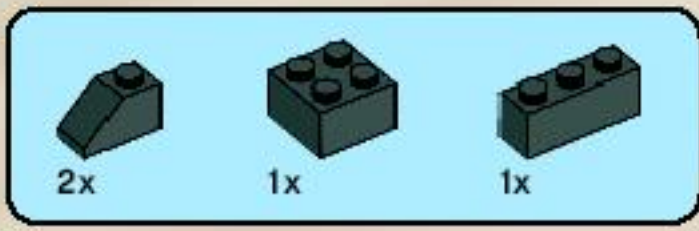

11

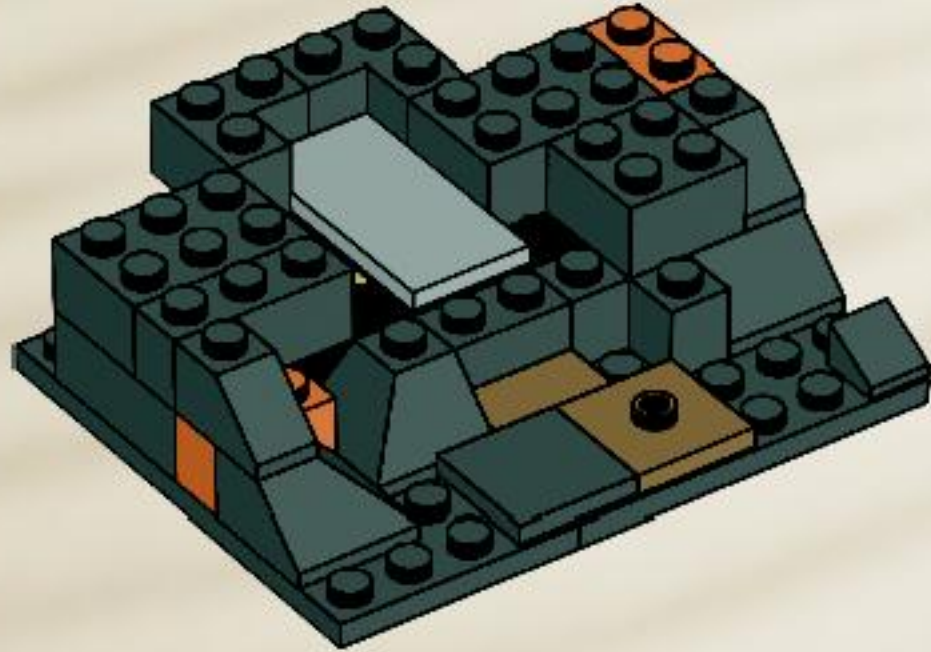

12

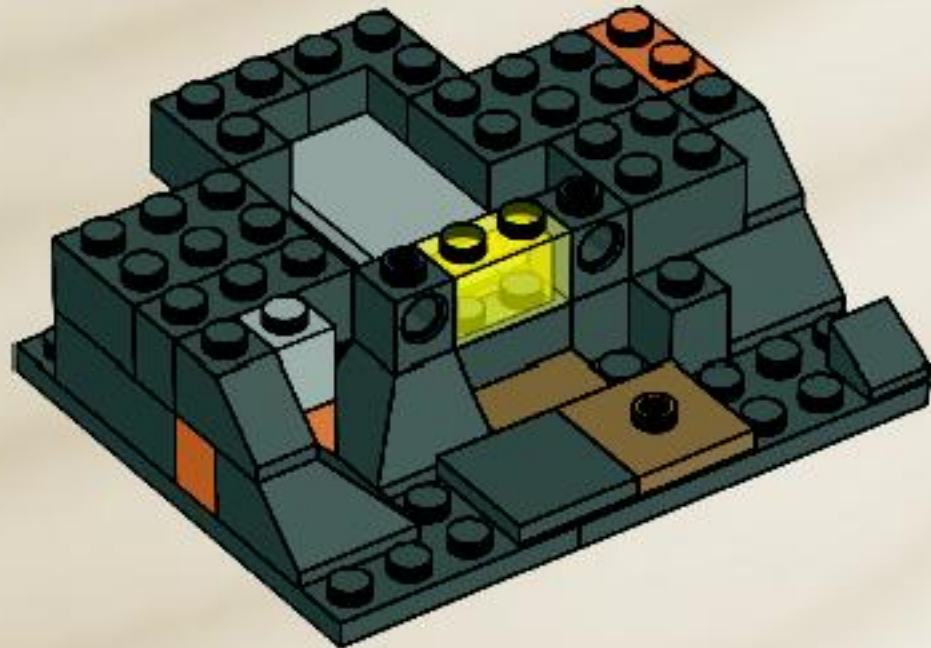

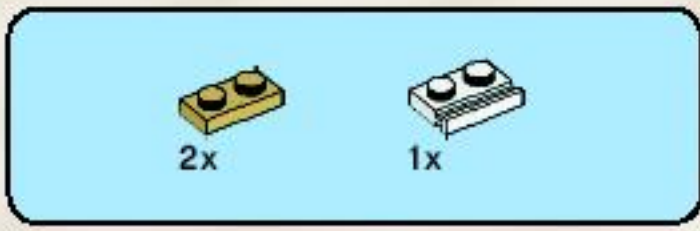

13

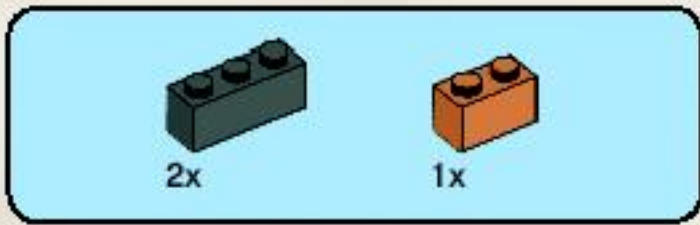
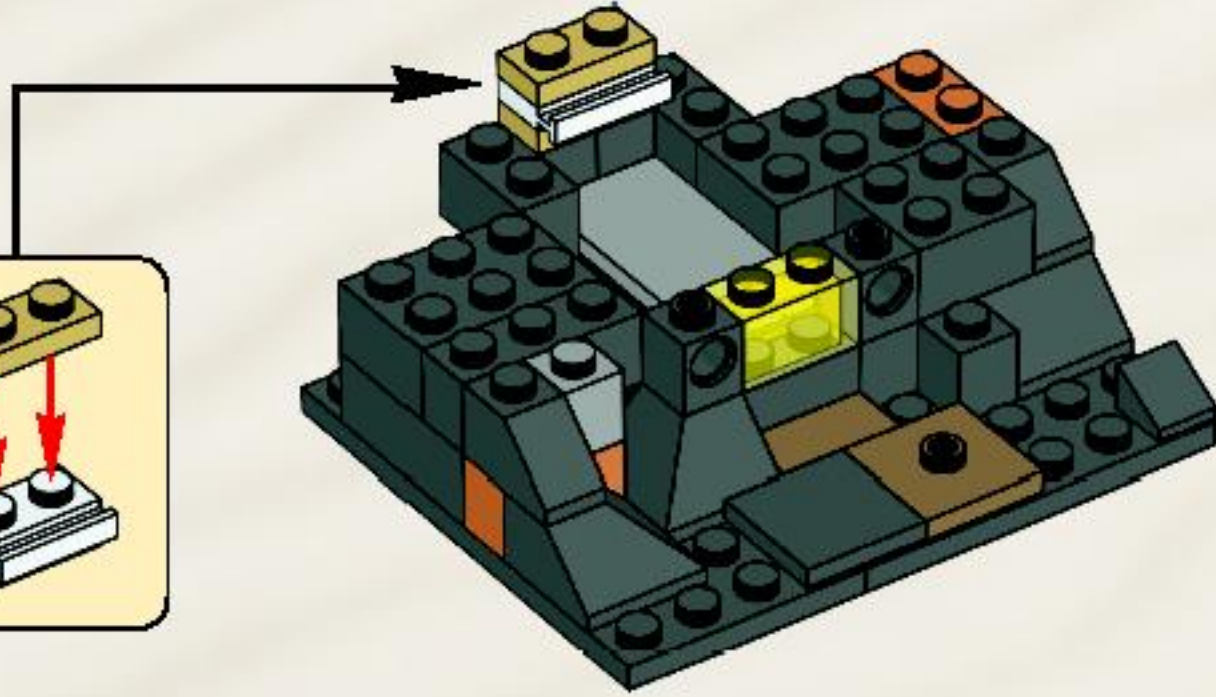
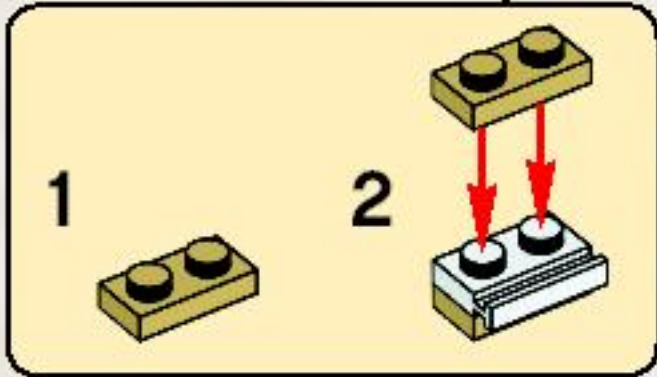

14

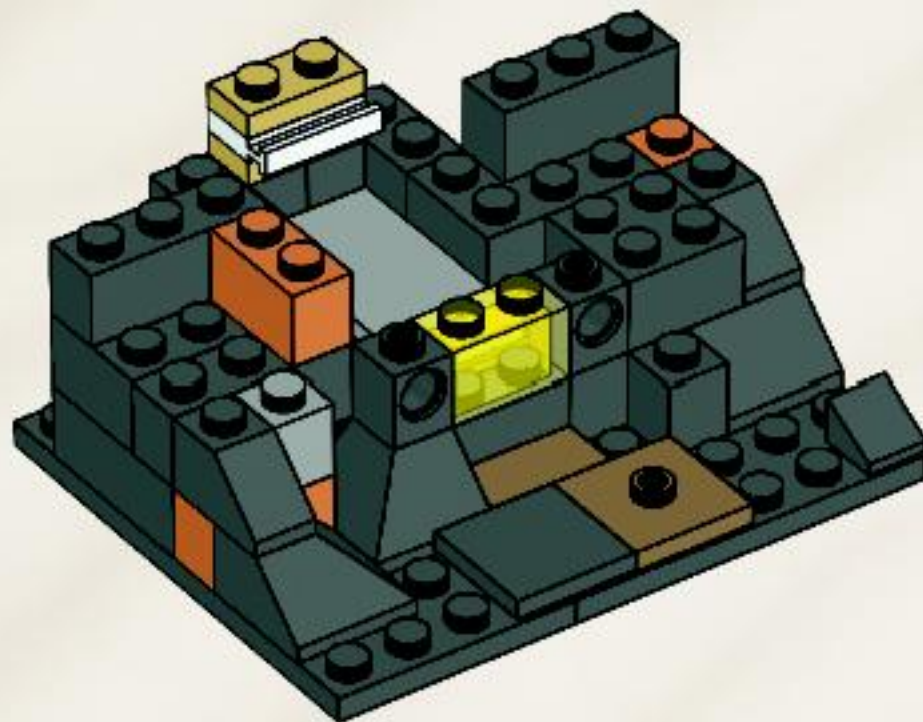

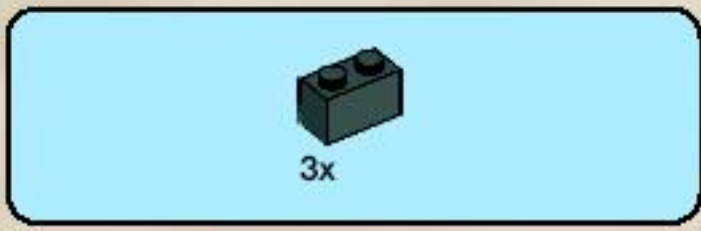

15

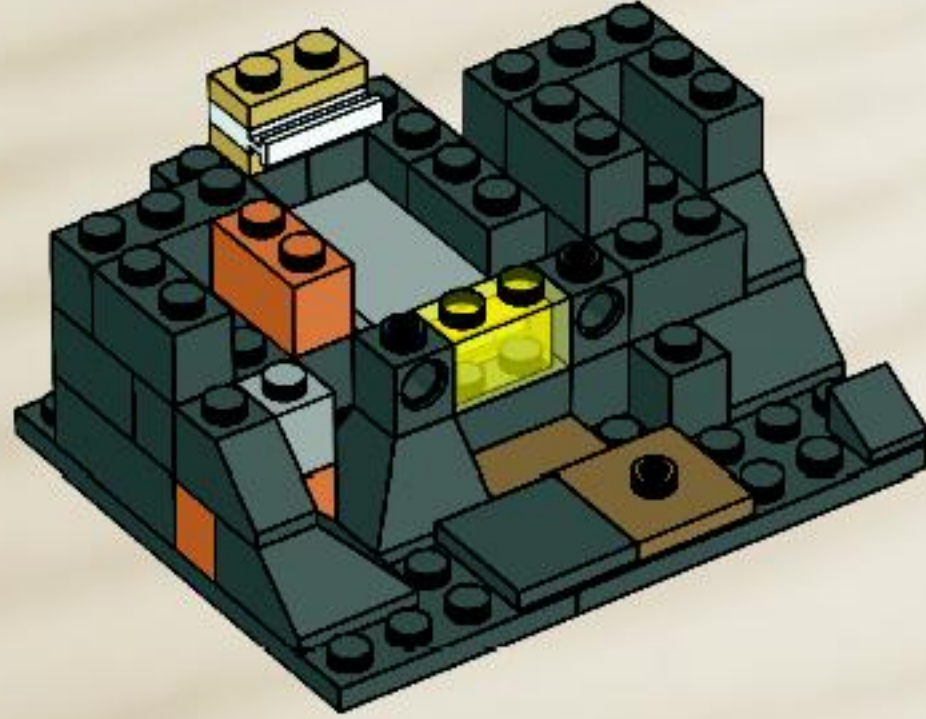

16

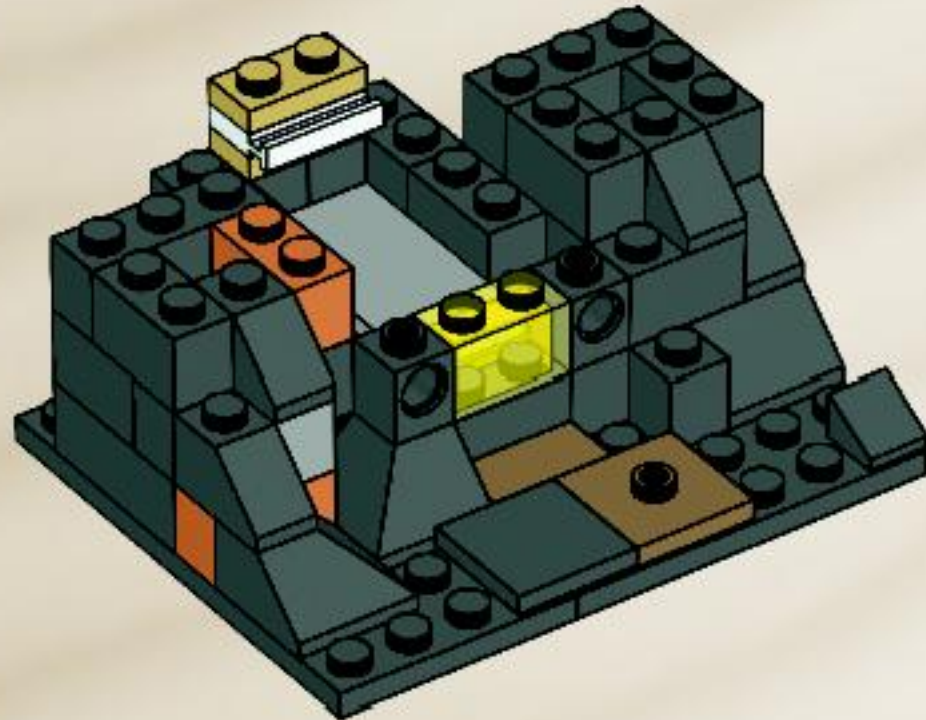

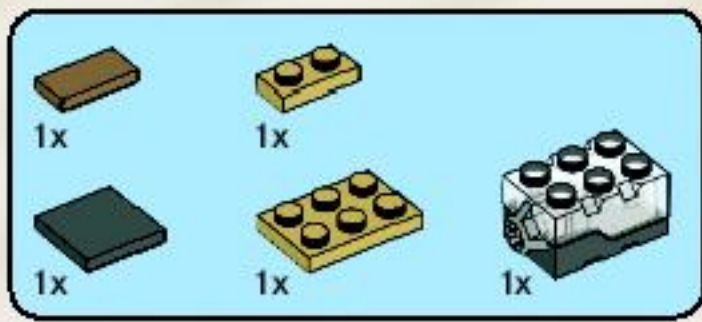

17

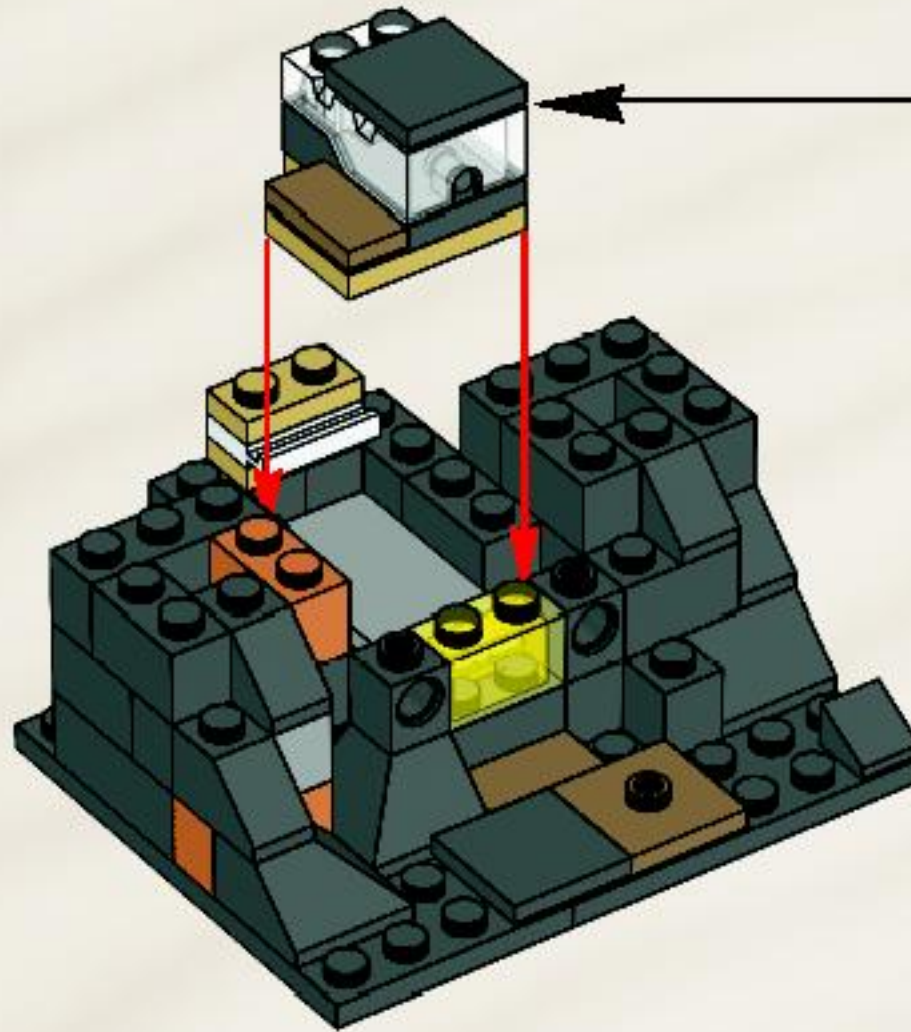
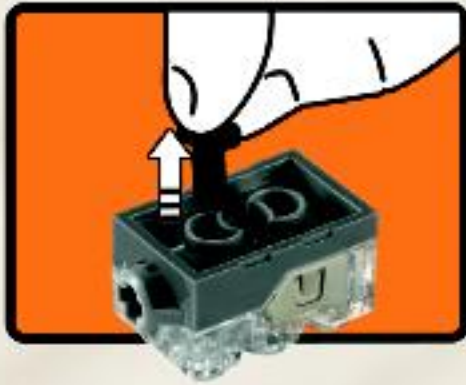
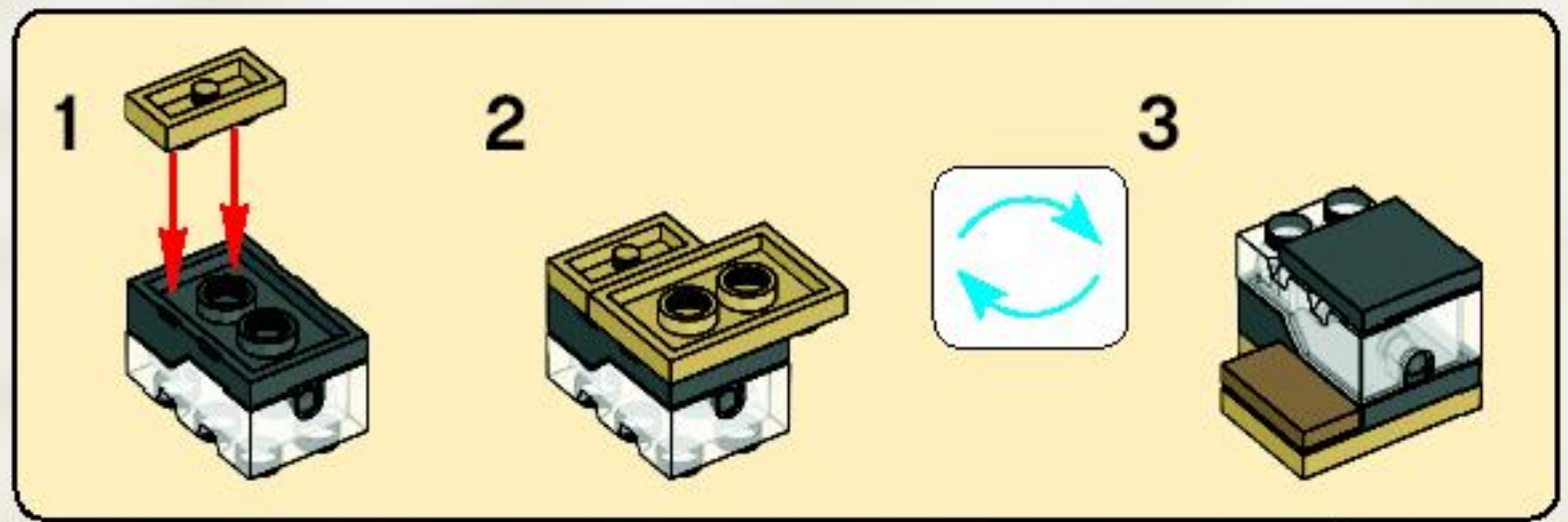



2x

18

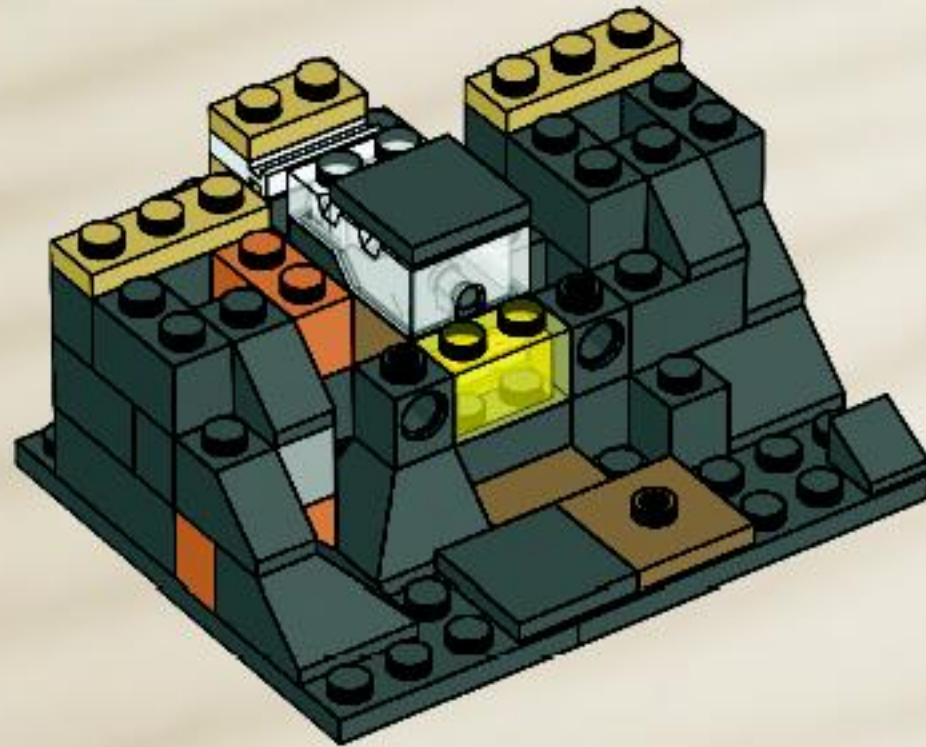

2x



2x

19

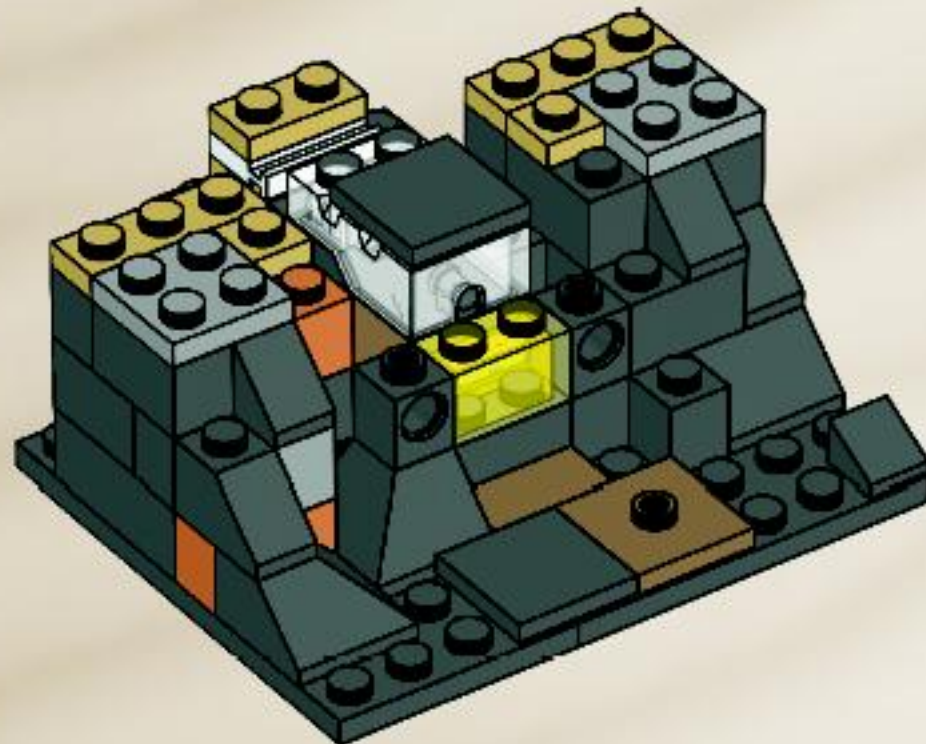

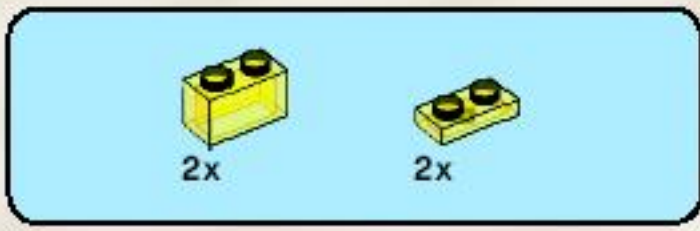

20

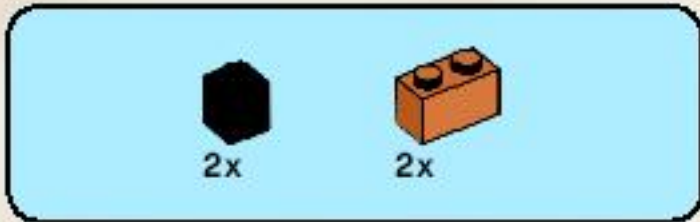
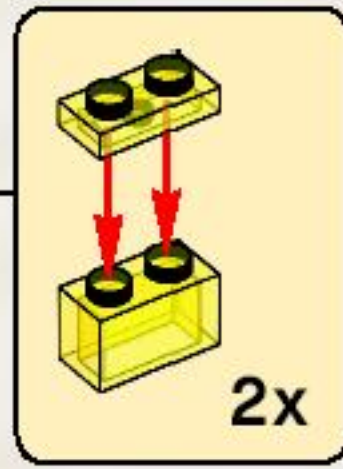
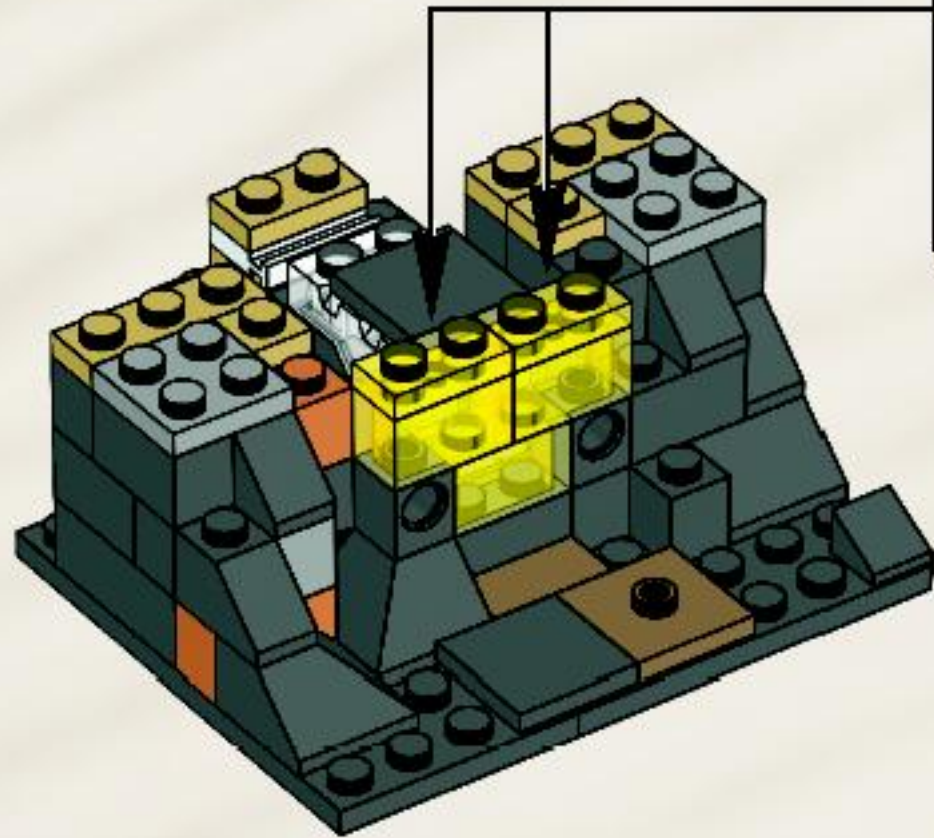

21

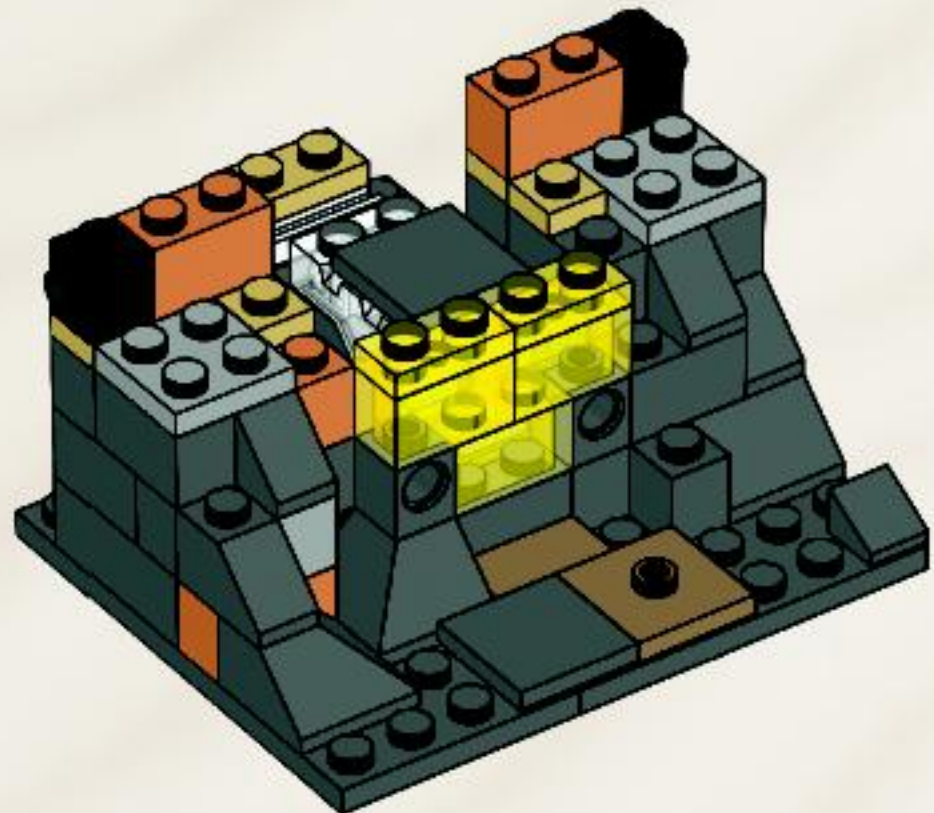

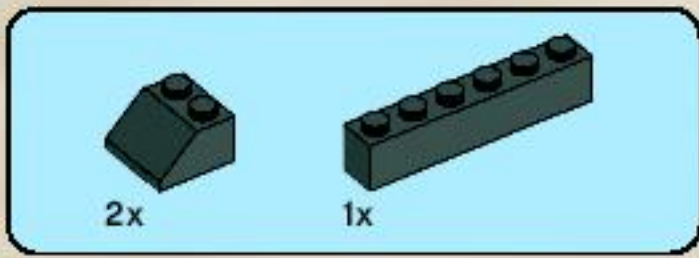

22

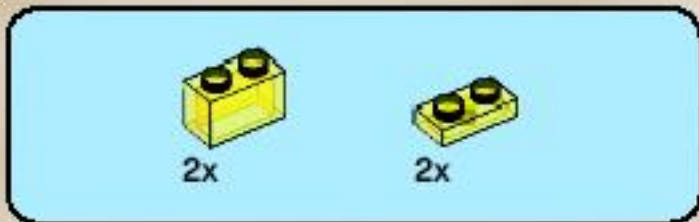
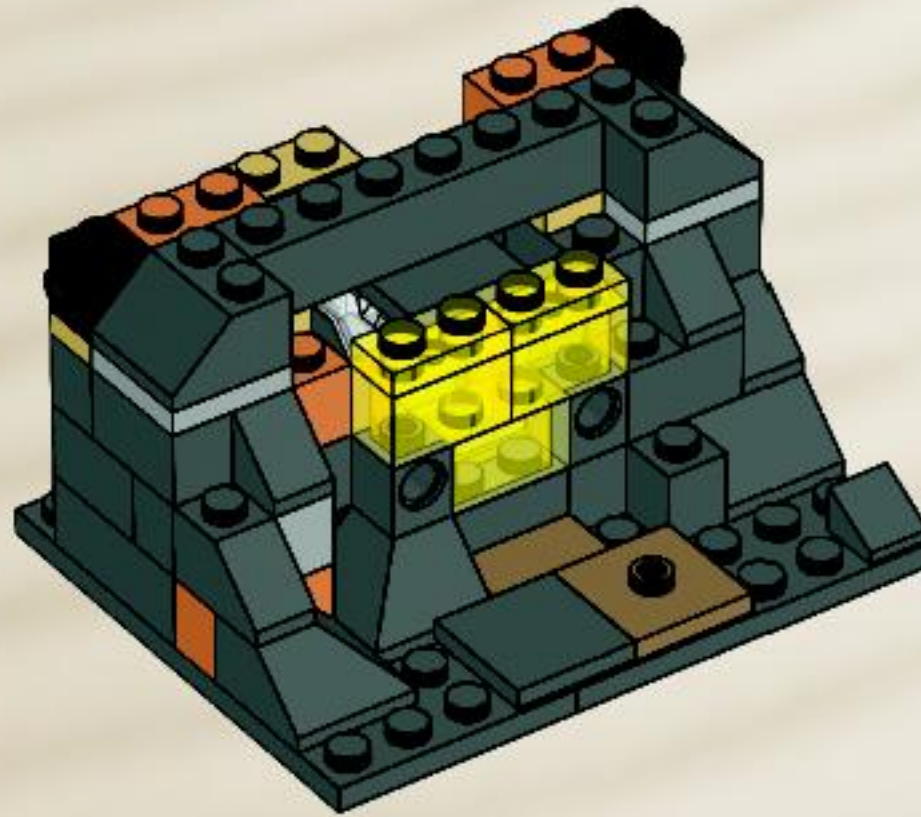

23

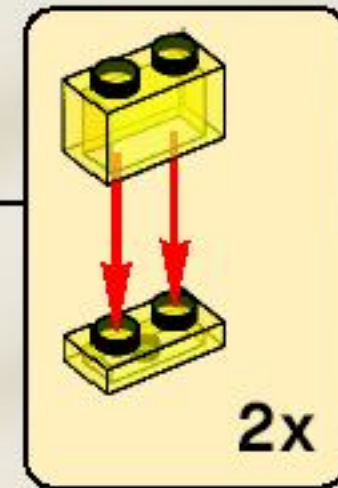
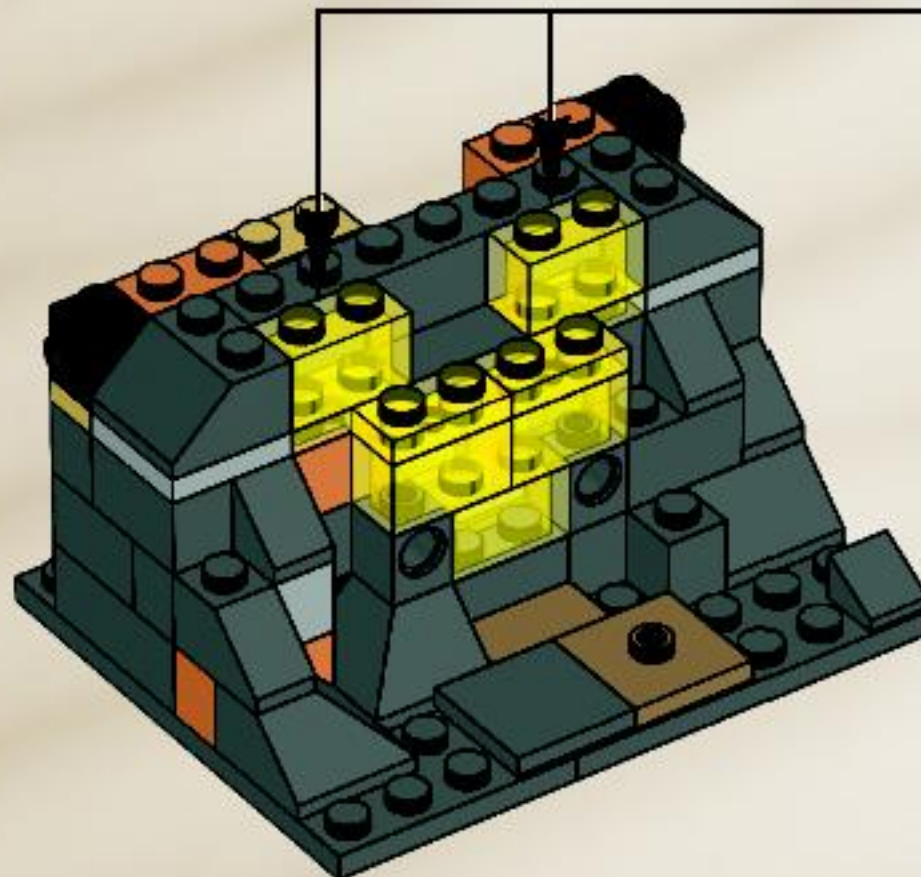

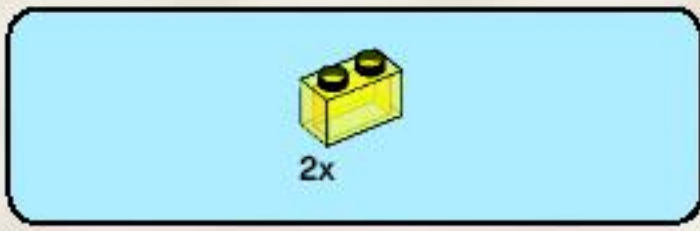

24

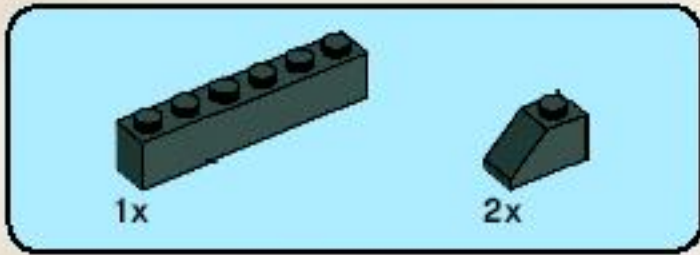
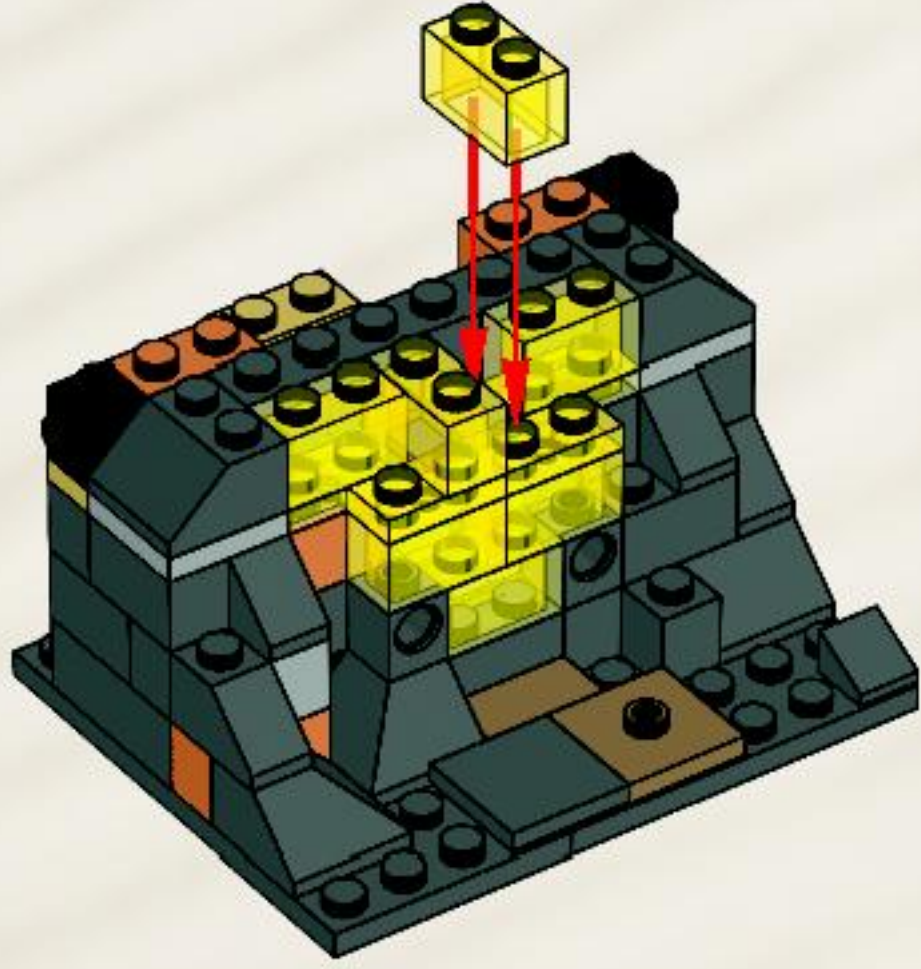

25

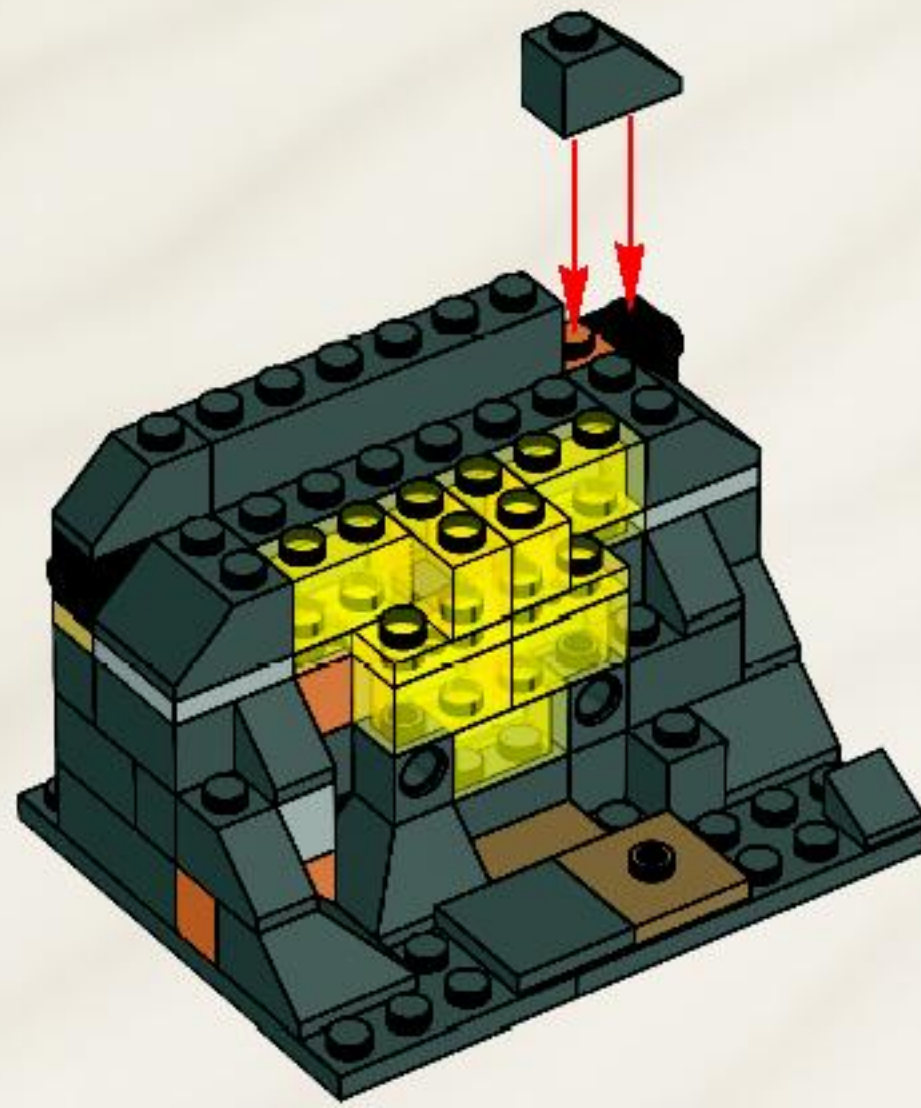



2x

26

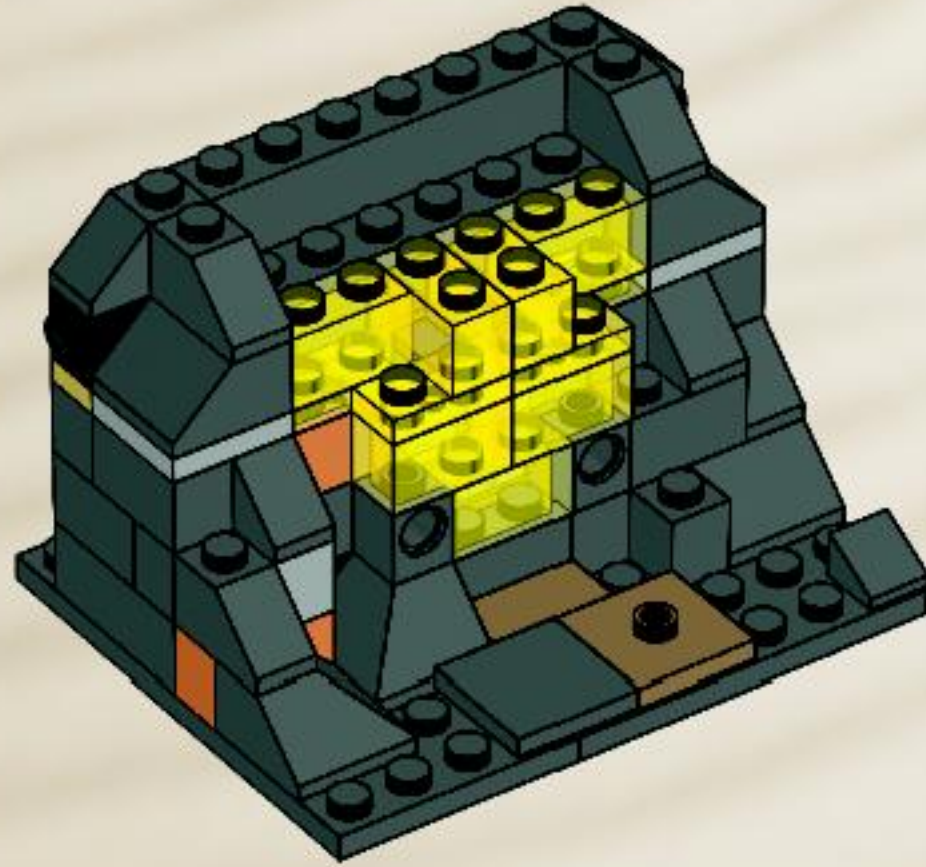

2x



1x

27

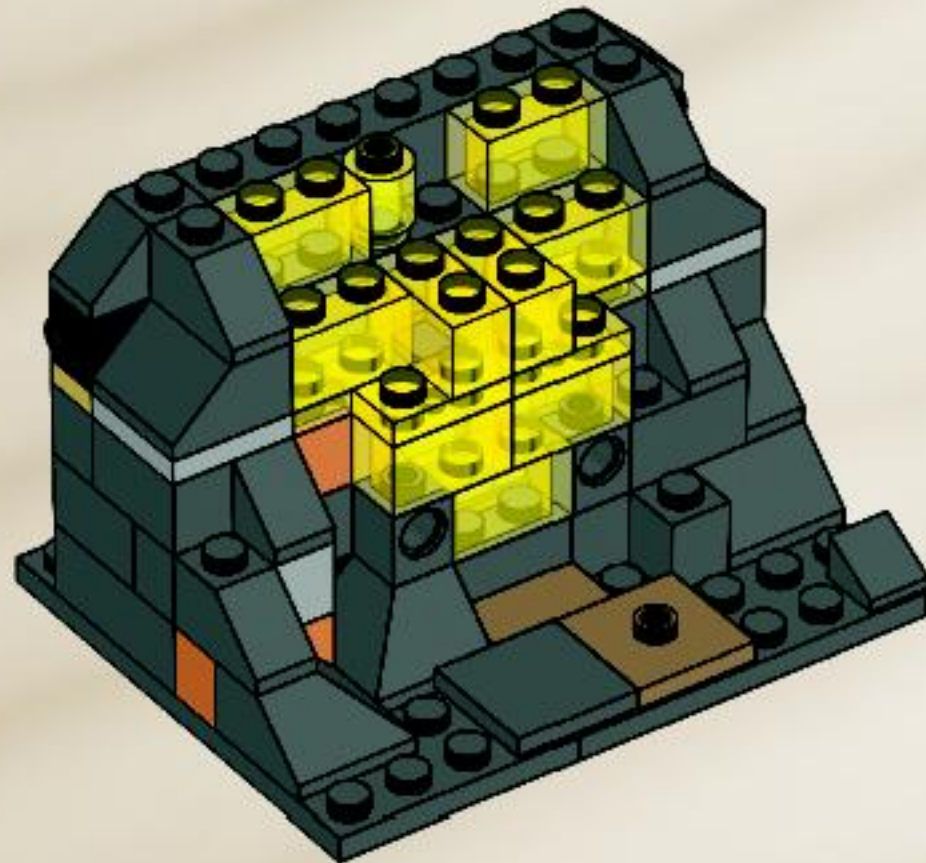

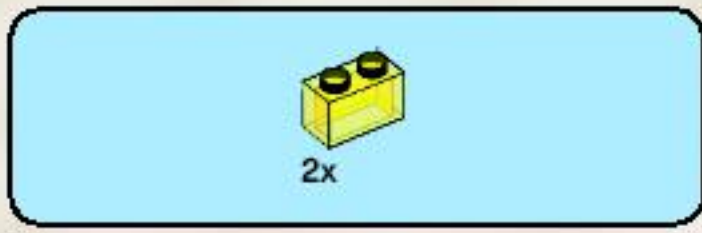

28

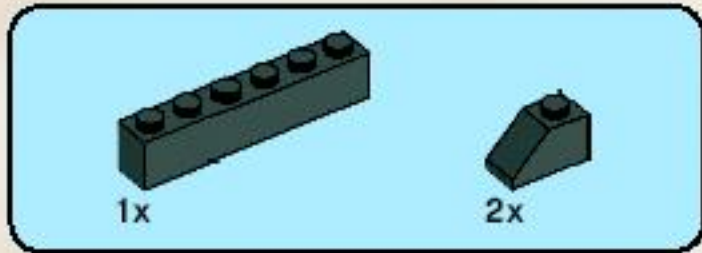
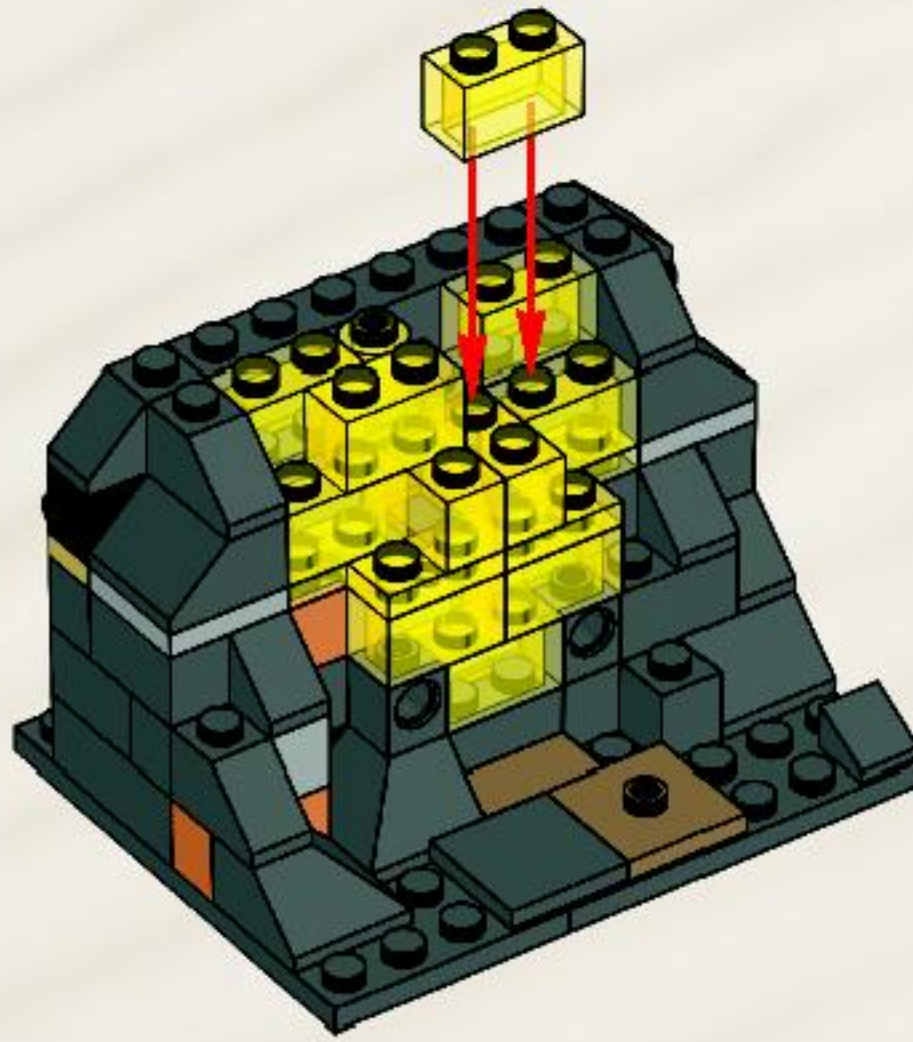

29

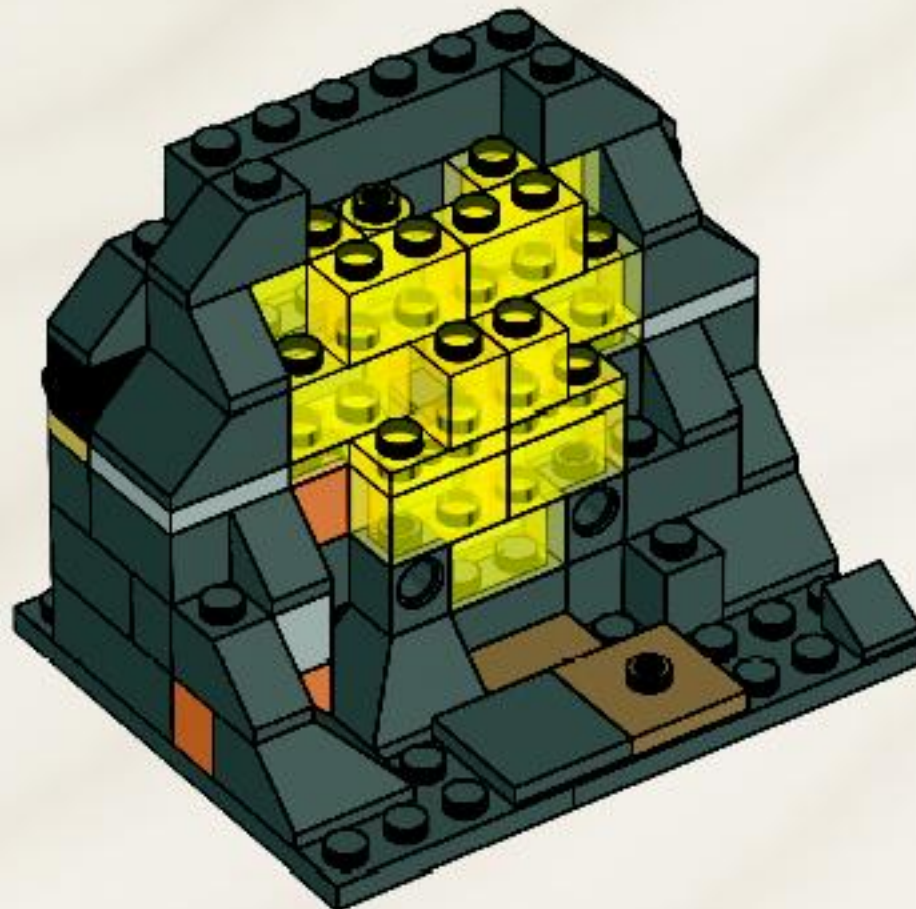

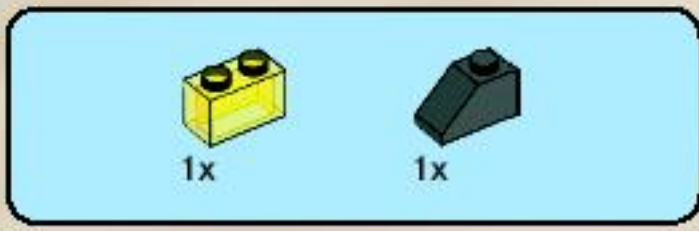

30

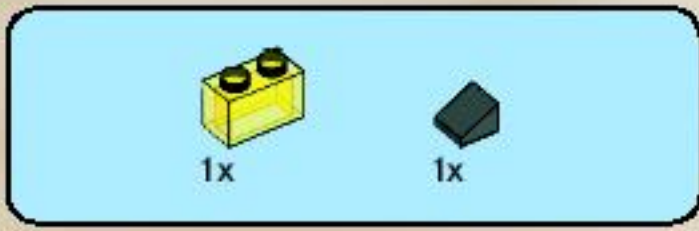
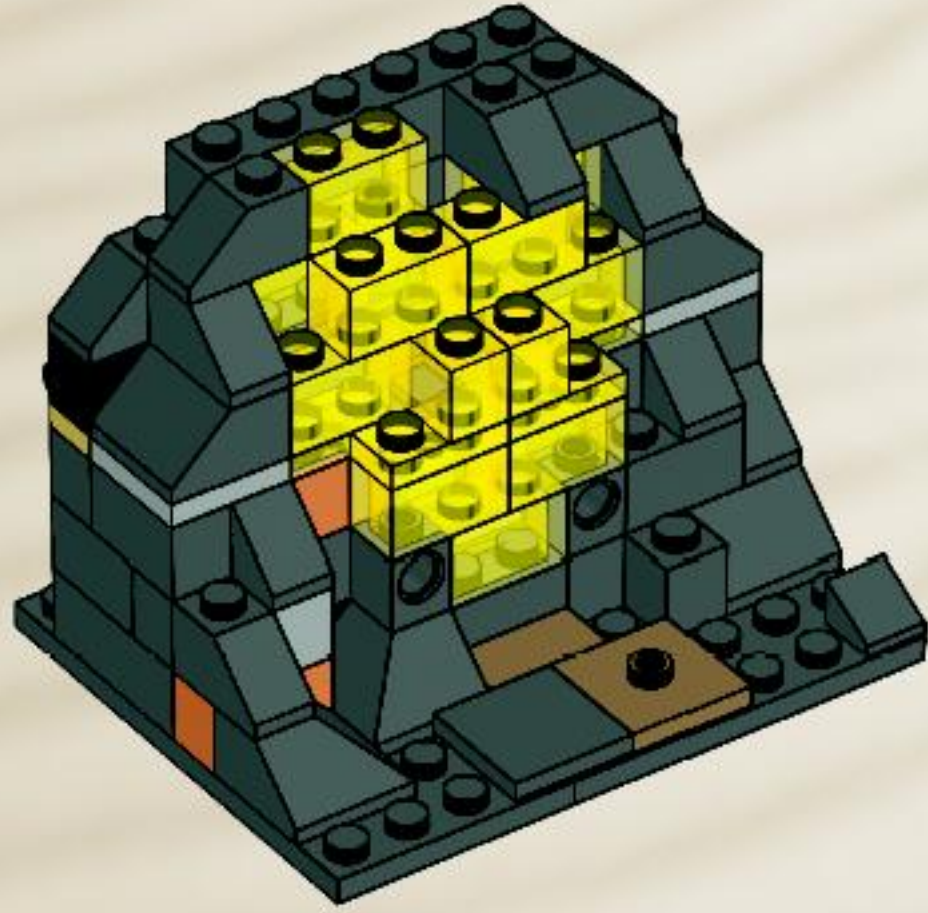

31

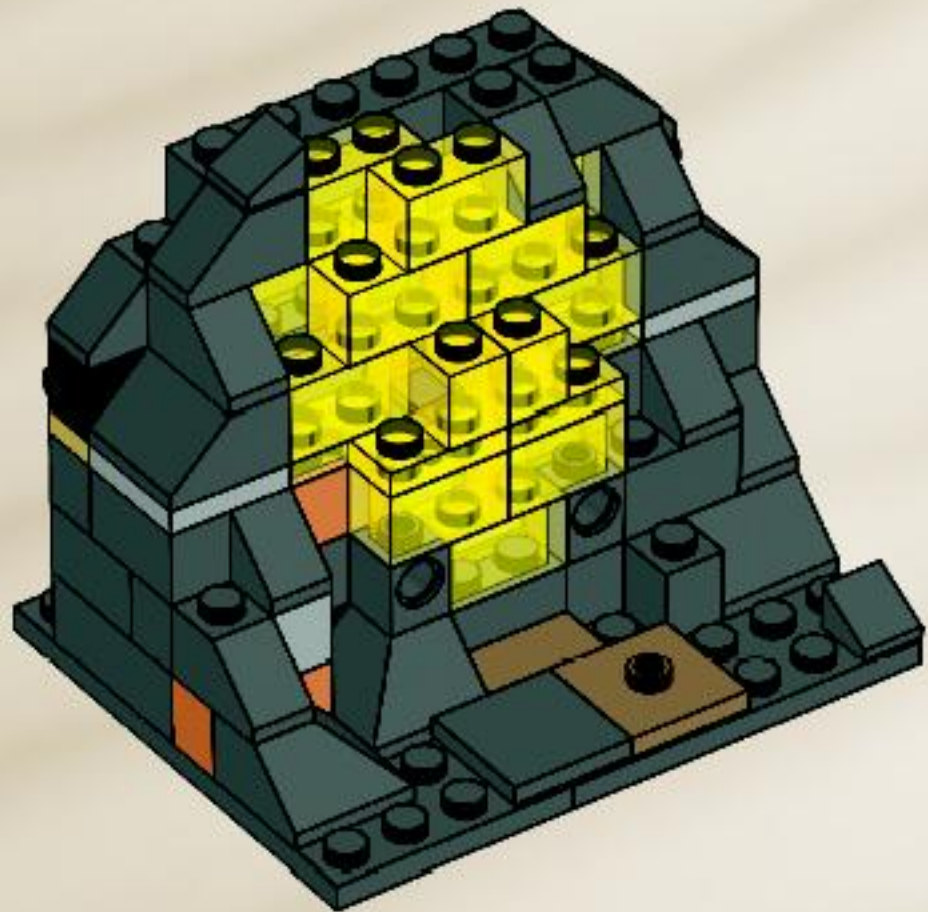

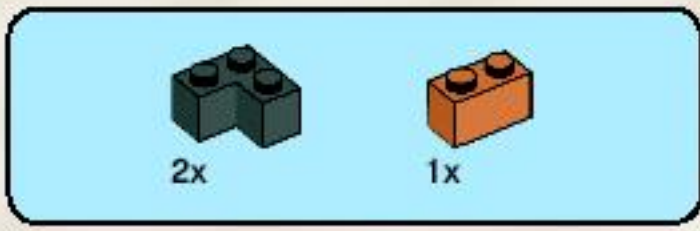

32

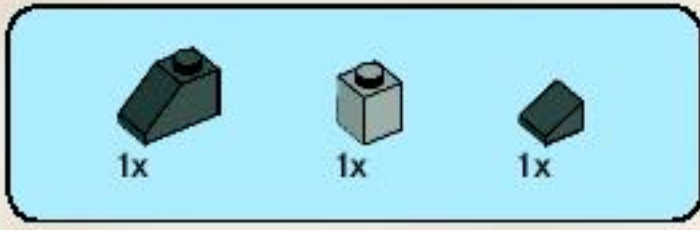
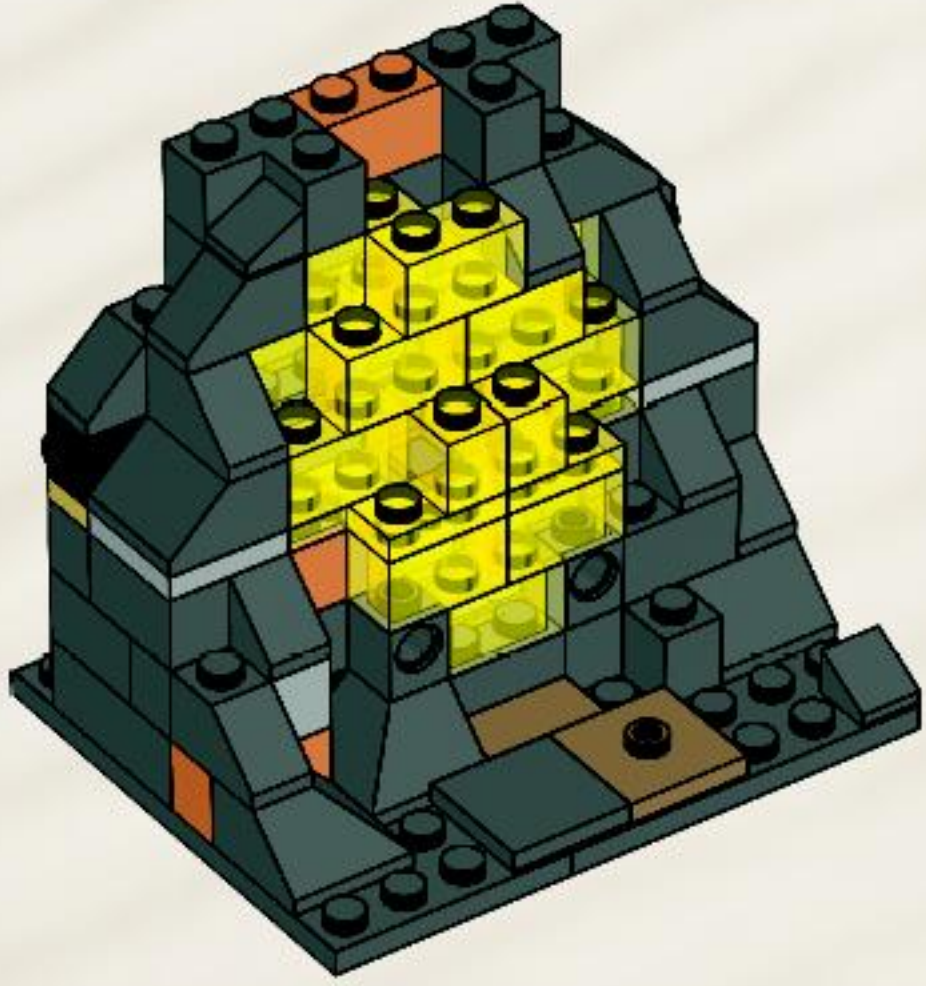

33

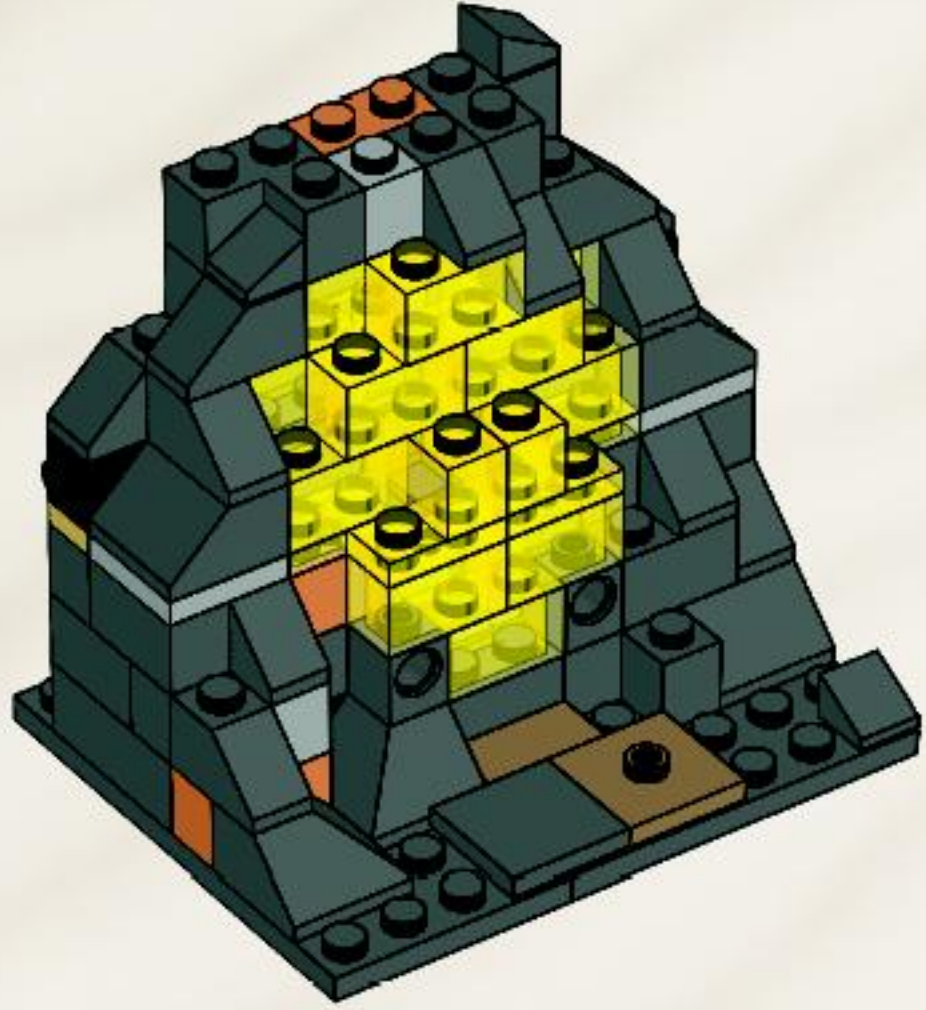



1x



2x

34

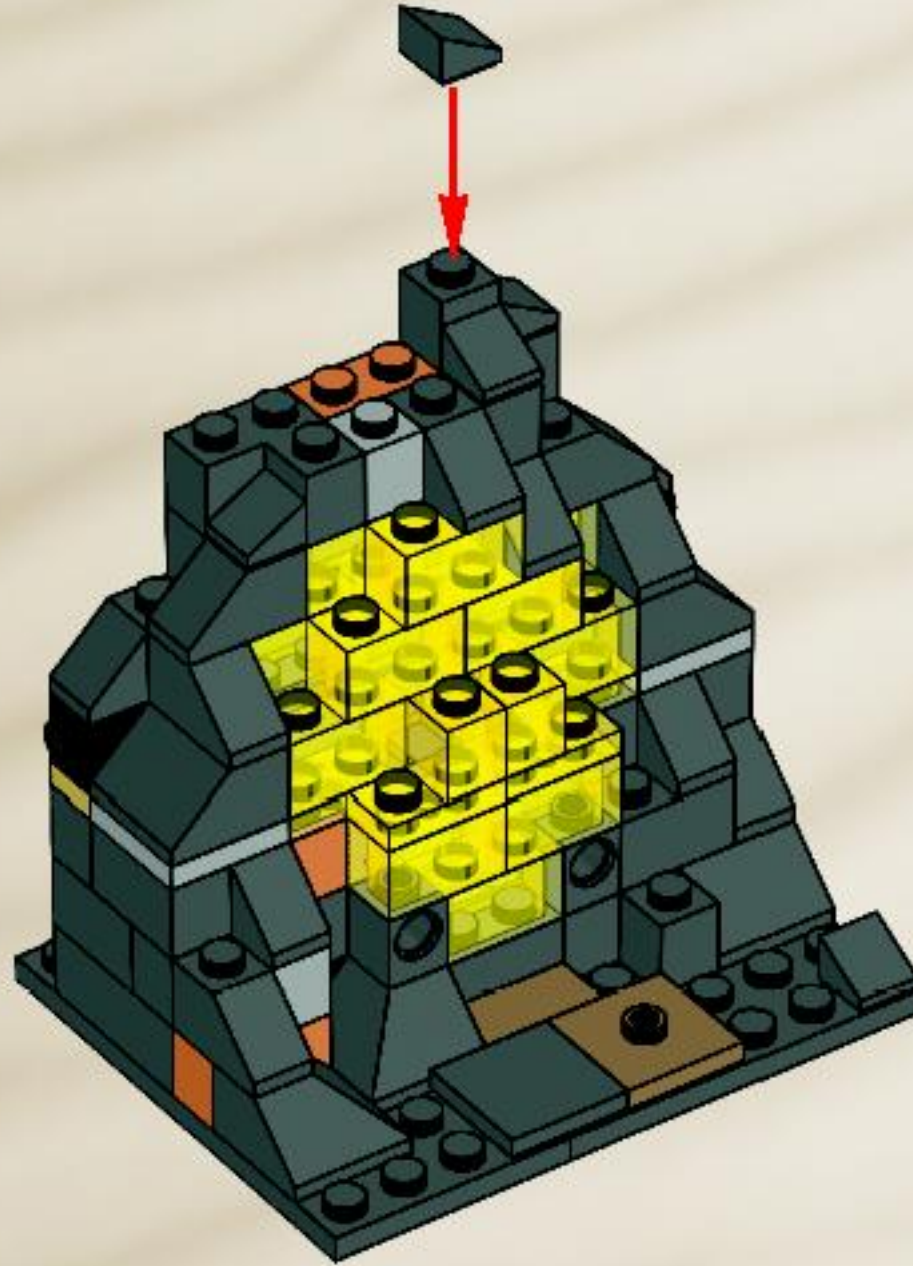

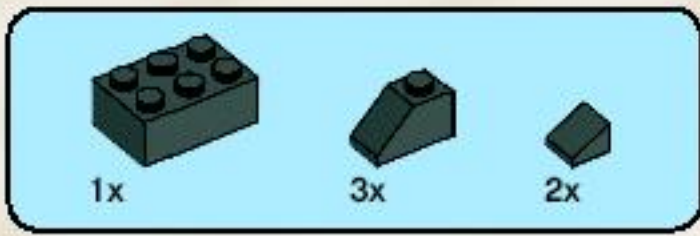

35

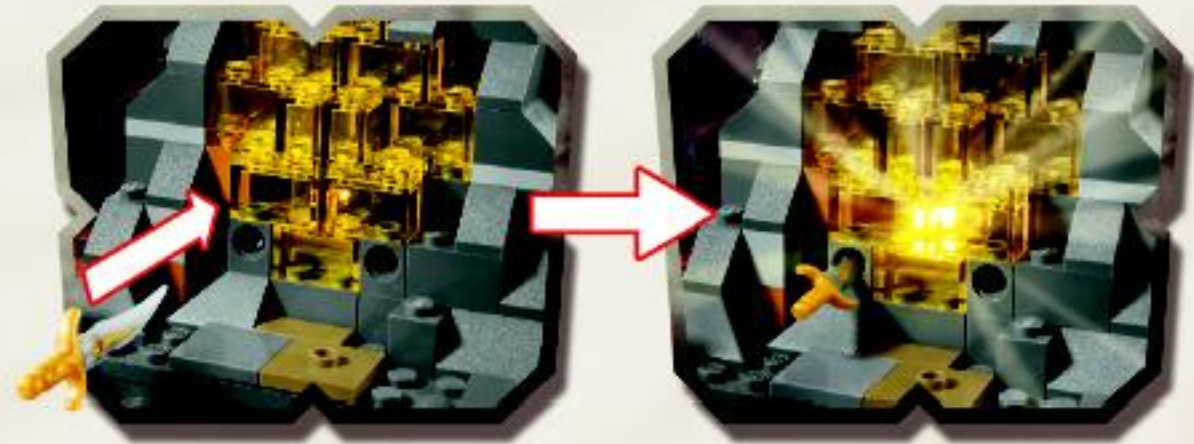
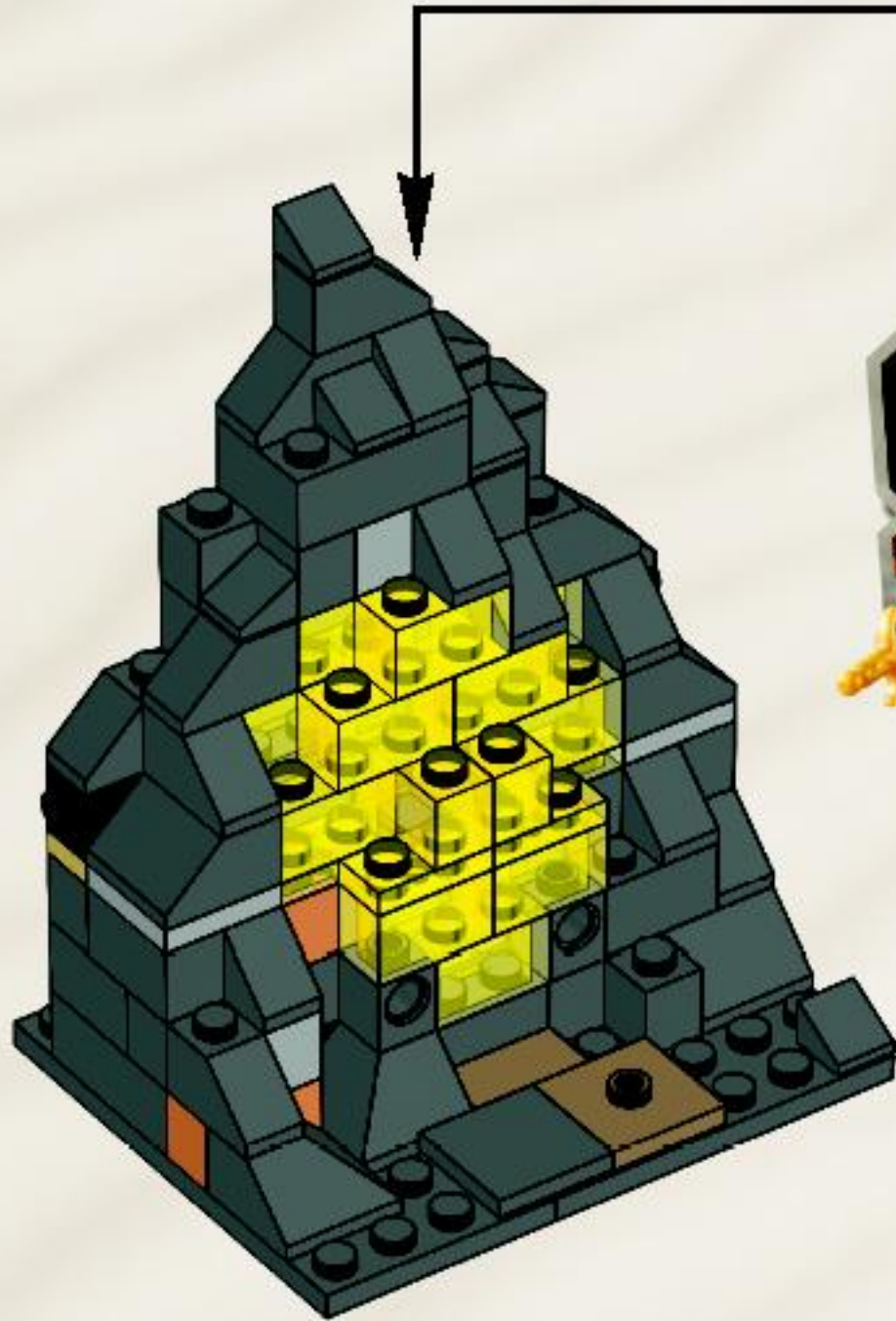
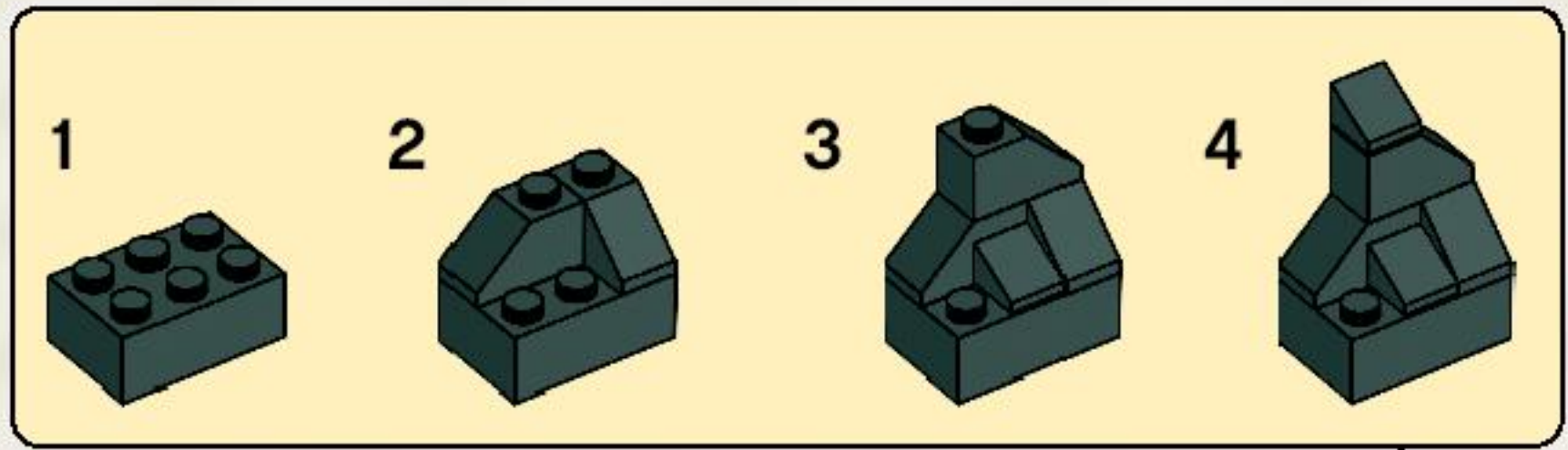

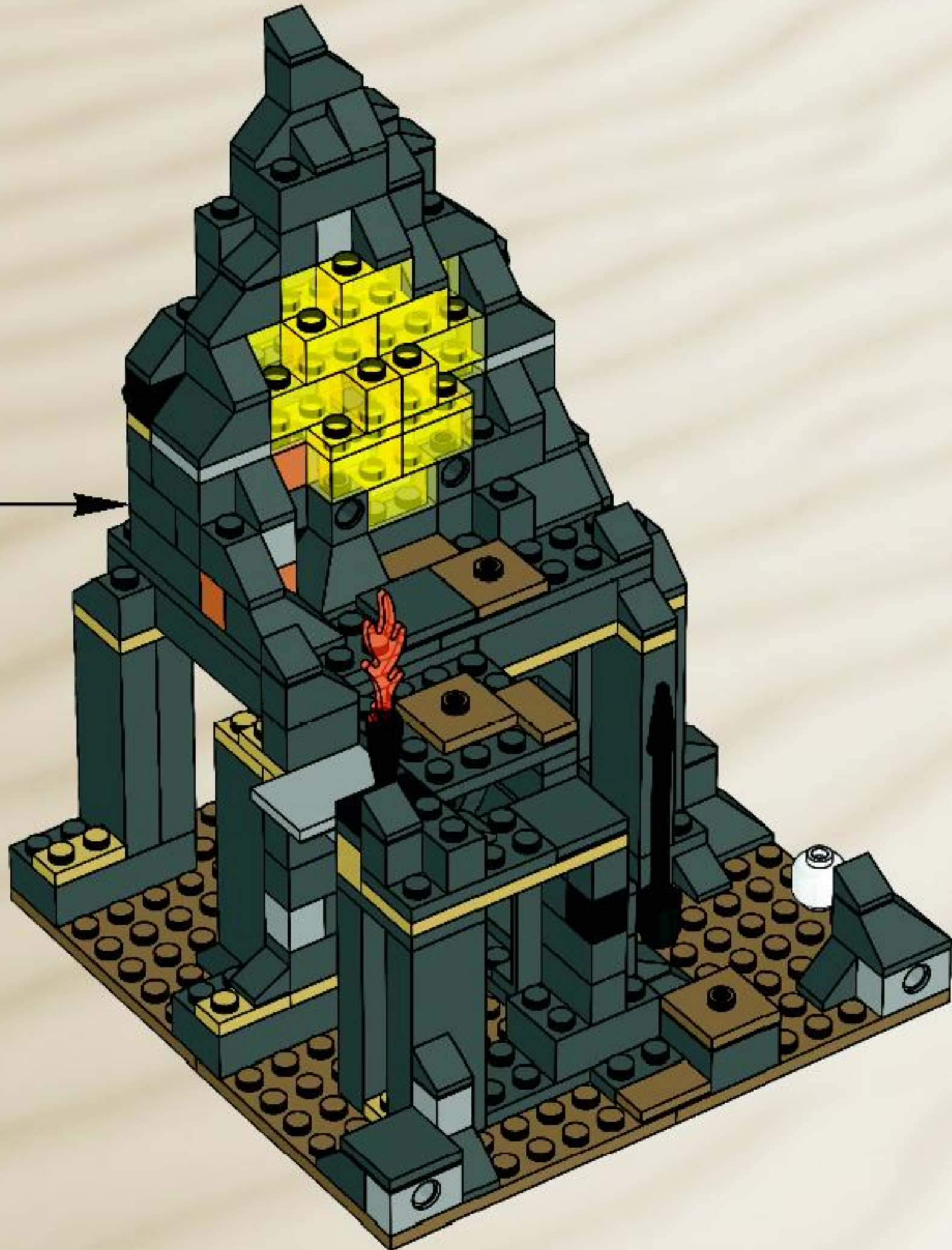

37

