



Friends



3184





Andrea



Mia



Stephanie



Friends



Olivia



Emma

1

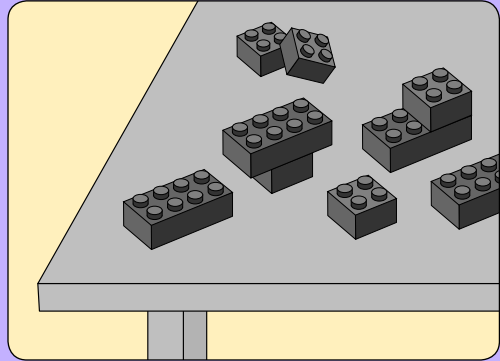
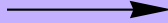
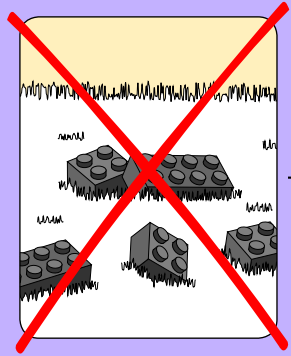

2



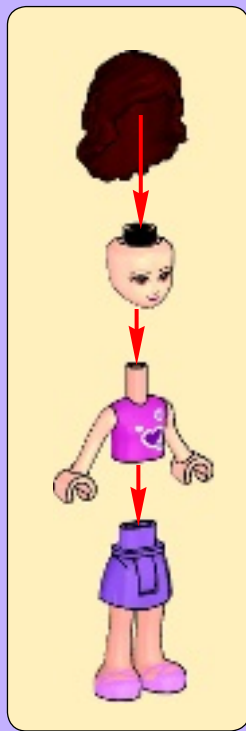

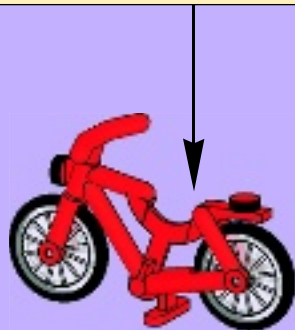

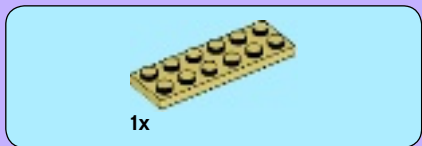

1x

1



1x

2x

2

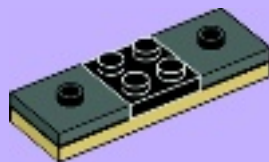



4x



2x

3



1x

4





4x

5



8



2x

6

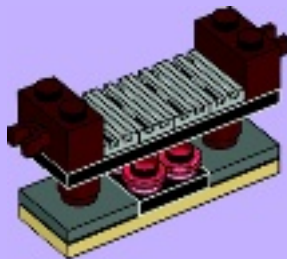

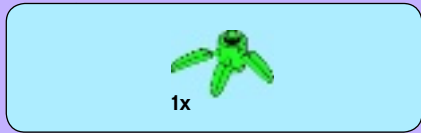

7

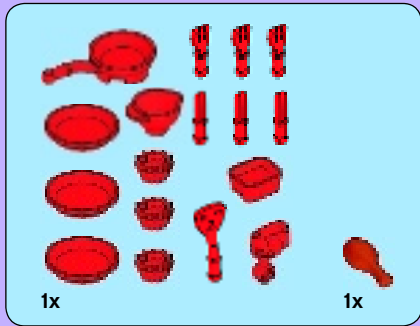
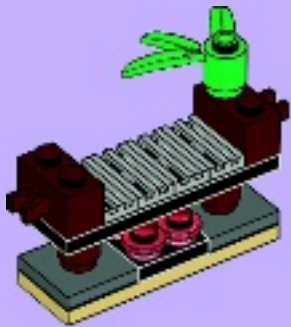

8

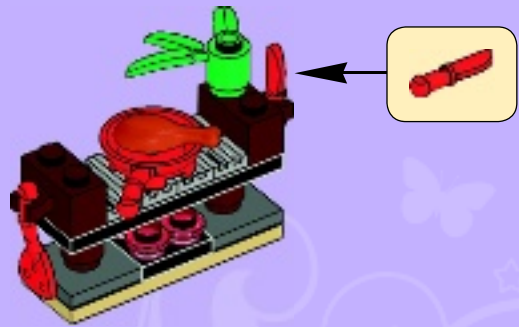

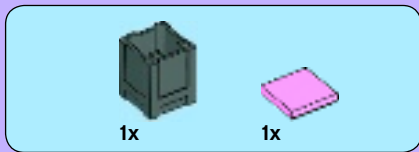

9



1



2

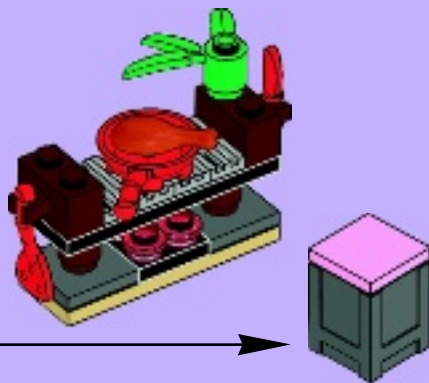

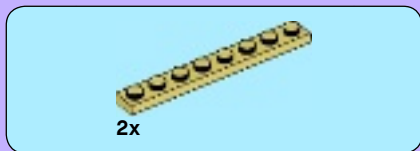

1

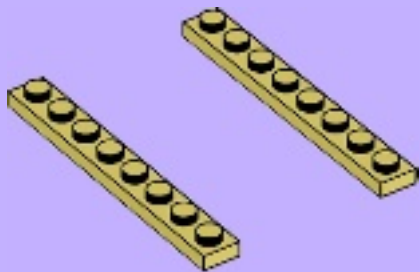

2

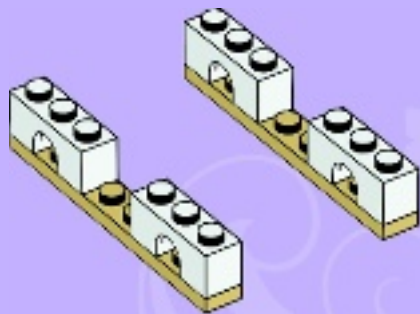



2x

3

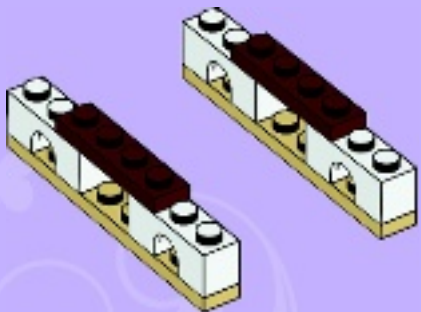

4x

4

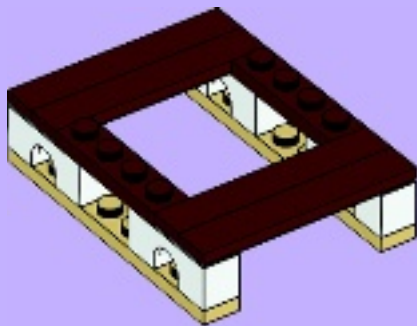



2x

5

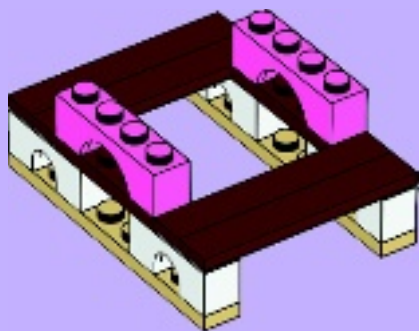

2x



2x

6

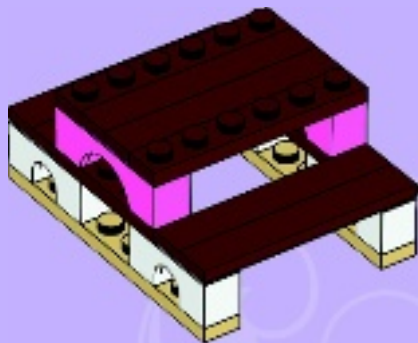



7

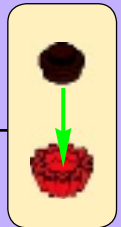
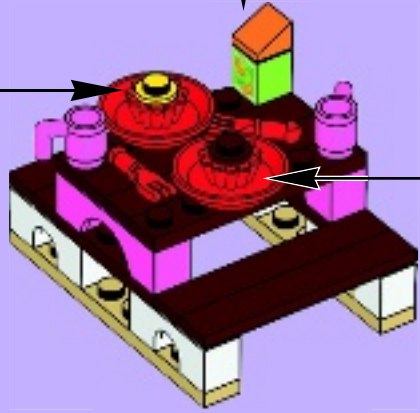
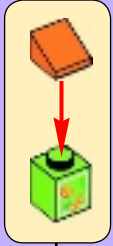



1



2



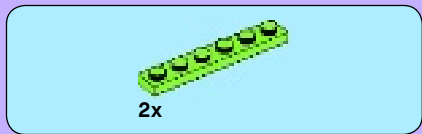

3

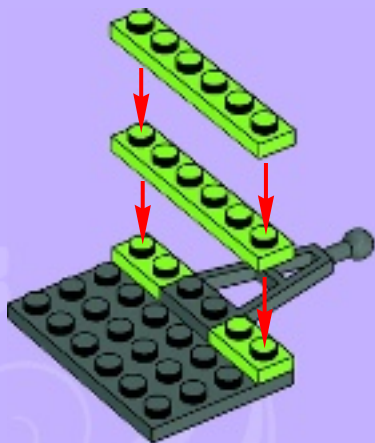

4

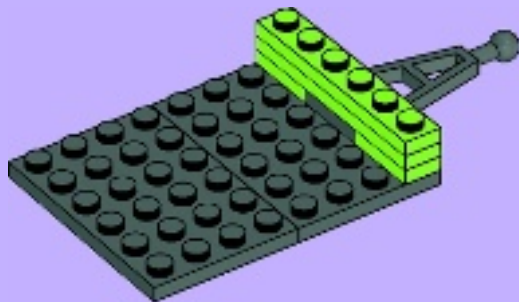

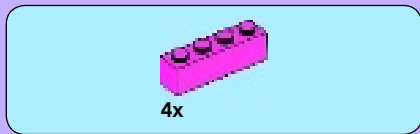

5

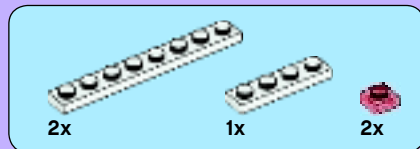
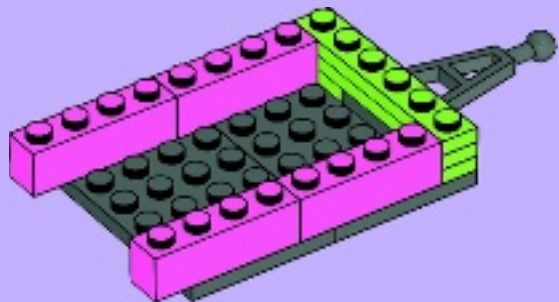

6

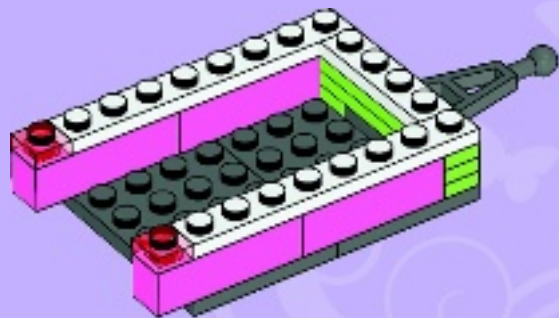

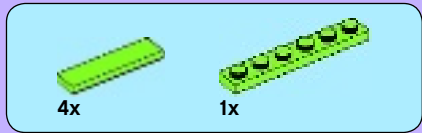

7

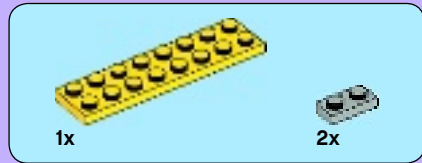
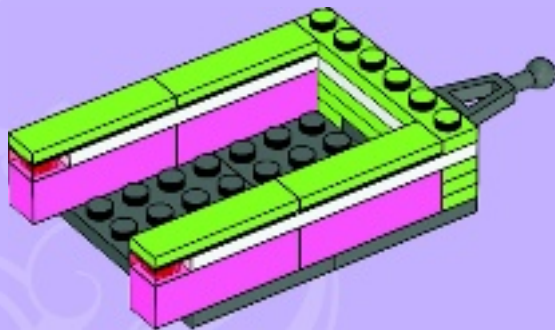

8

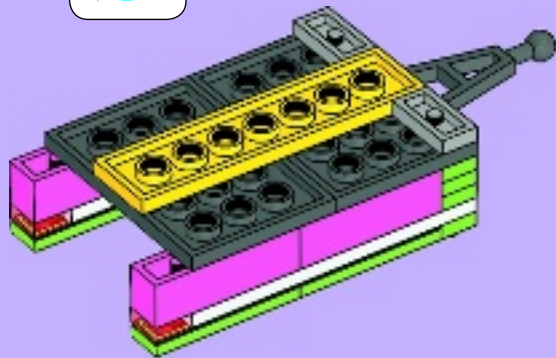
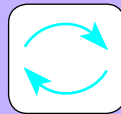

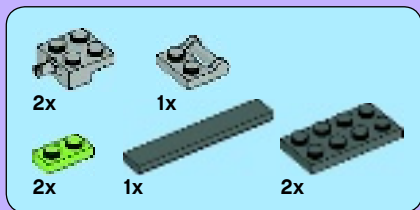

9

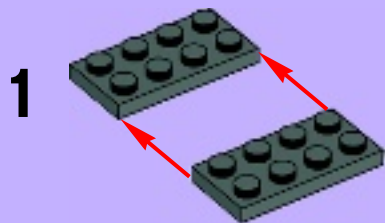

4

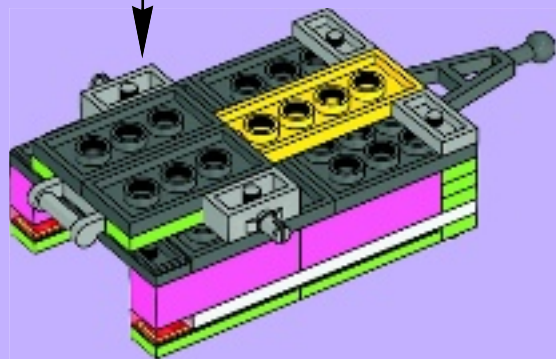
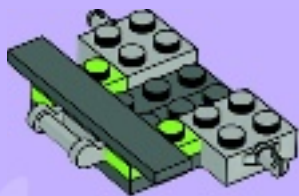



1x



2x



2x

10

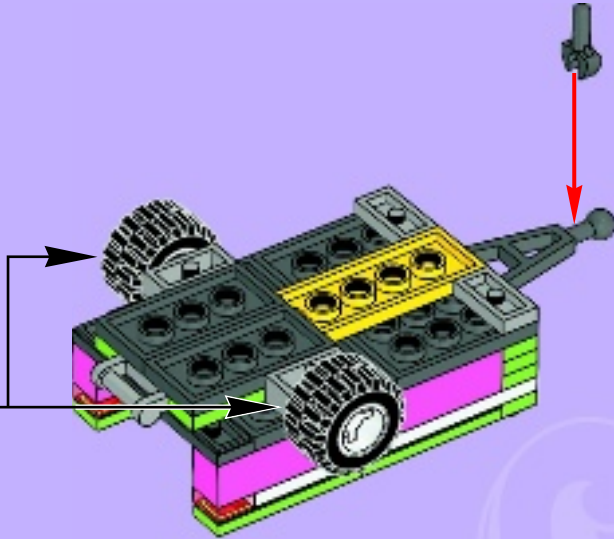
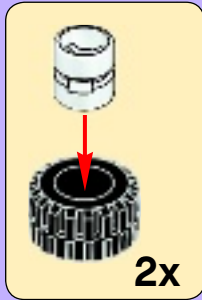

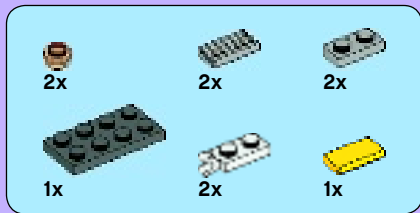

11

1



2



3



4

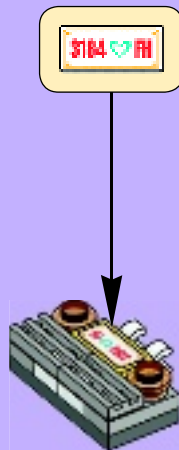

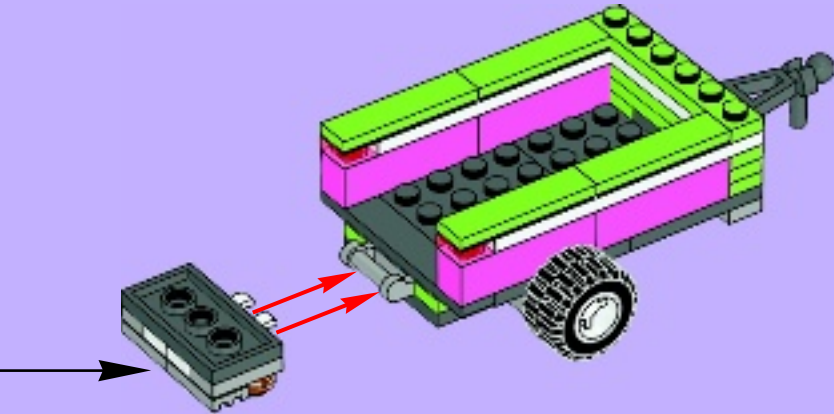

12

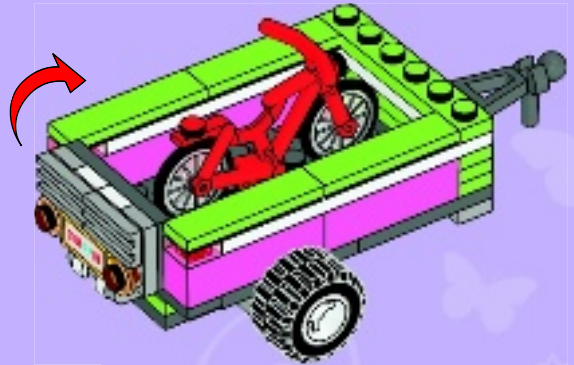



Win!

Go to www.LEGOsurvey.com/product to fill out a survey for a chance to win a cool LEGO® Product.
No purchase necessary.
Open to all residents where not prohibited.



www.LEGOsurvey.com/product

Gewinne! Win!

Nimm an der Umfrage auf www.LEGOsurvey.com/product teil und hab die Chance ein cooles LEGO® Produkt zu gewinnen!

Die Teilnahme am Gewinnspiel führt zu keinerlei Kaufverpflichtungen. Teilnahme in allen nicht ausgeschlossenen Ländern möglich.

LEGO and the LEGO logo are trademarks of the/son des marques de commerce de/son marcas registradas de LEGO Group. ©2012 The LEGO Group.

Ga naar www.LEGOsurvey.com/product, vul een enquêteformulier in en maak kans op een cool LEGO® product.

Geen aankoopverplichting. Iedereen mag deelnemen, uitgezonderd ingezetenden van landen waar een enquêteverbod geldt.

Gagne! 当てよう!

Visite www.LEGOsurvey.com/product pour répondre à un questionnaire et avoir une chance de gagner un produit LEGO® très cool!

Aucune obligation d'achat. Ouvert à tous les résidents des pays autorisés.

www.LEGOsurvey.com/product にアクセスして、アンケートにご記入ください。当選者にはレゴ® 製品を差し上げます。

お買い上げの必要はありません。

禁止されていない限り、すべての皆様にご利用いただけます。

6014698 / 6014699





Friends



3184

2



+

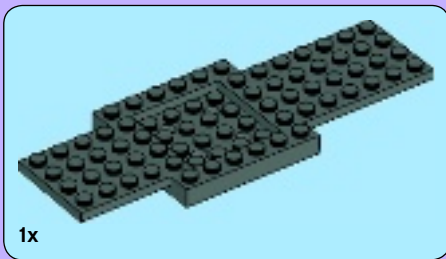

1

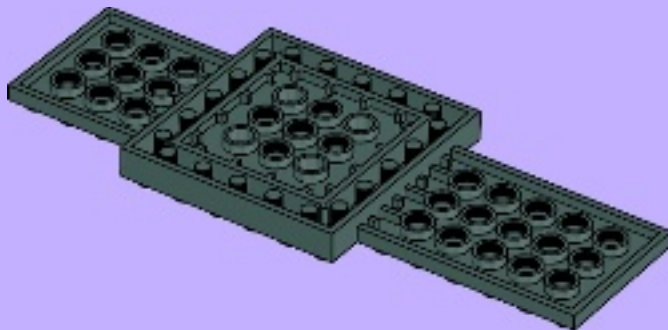



1x

2

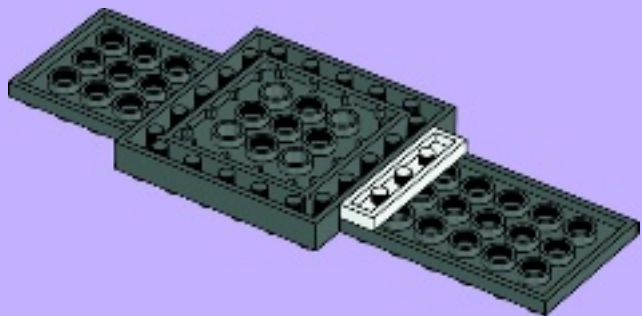

2x

3

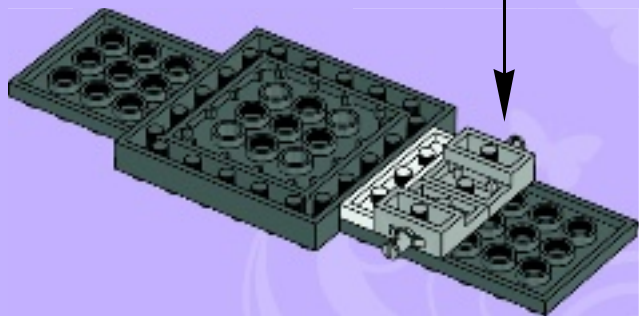

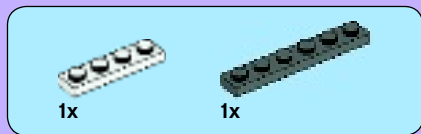

4

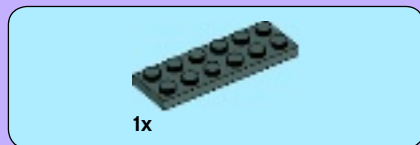
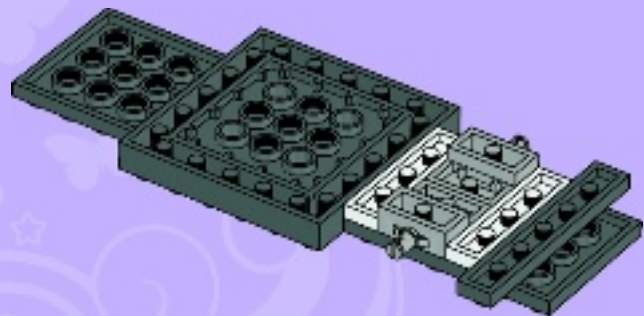

5

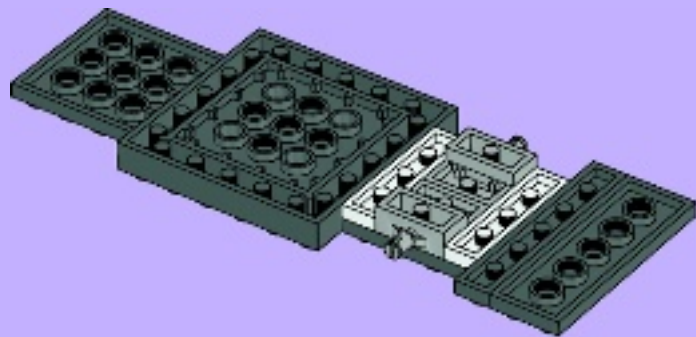

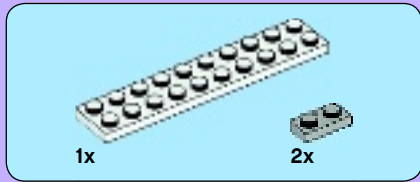

6

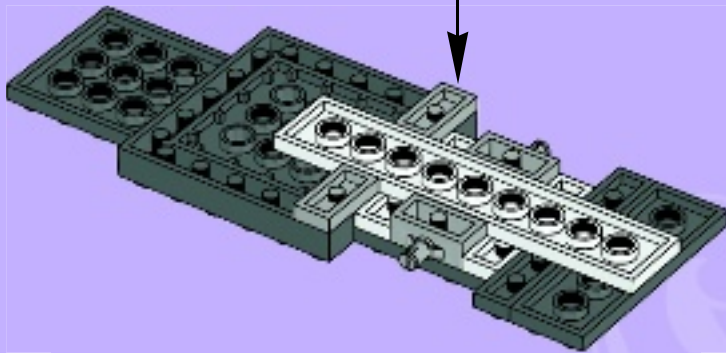
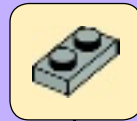



7

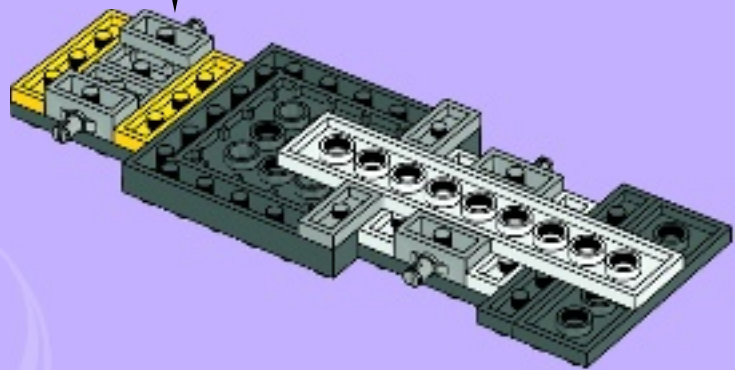

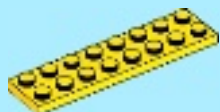

1x

8

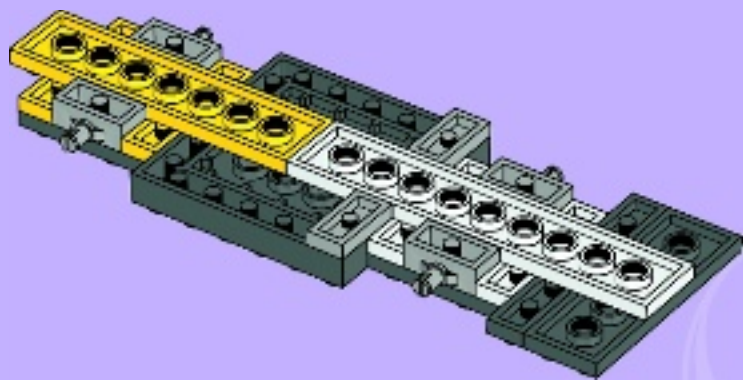

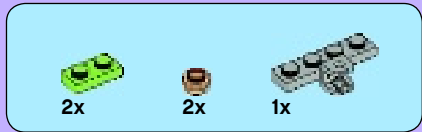

9

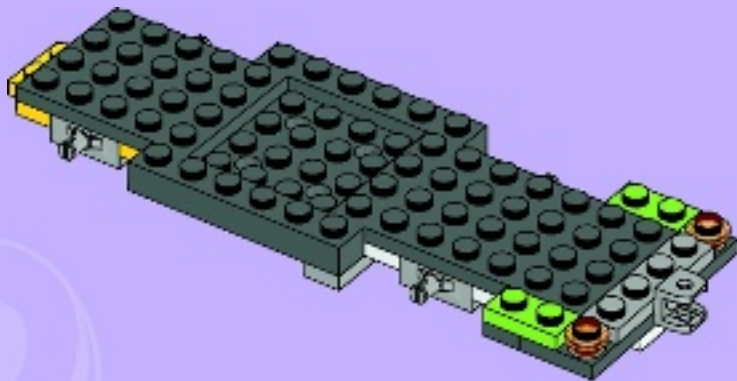
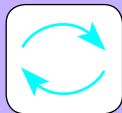



10

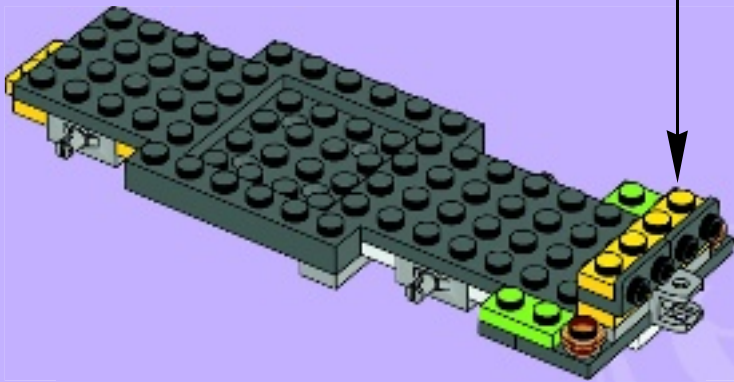
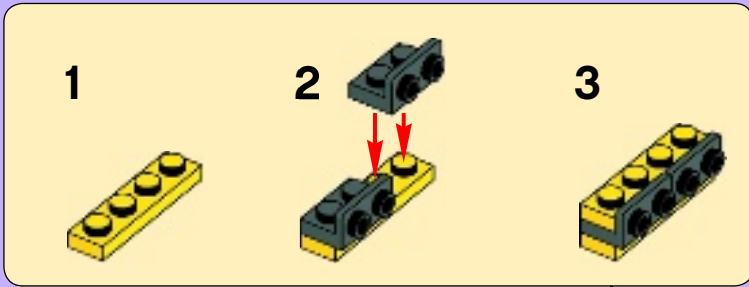



2x



2x

11

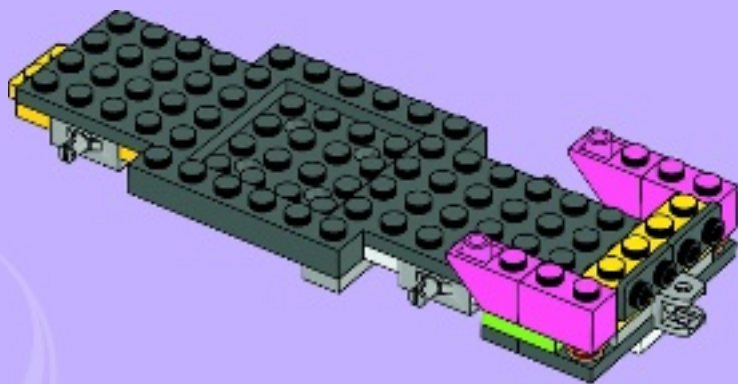



2x



4x

12

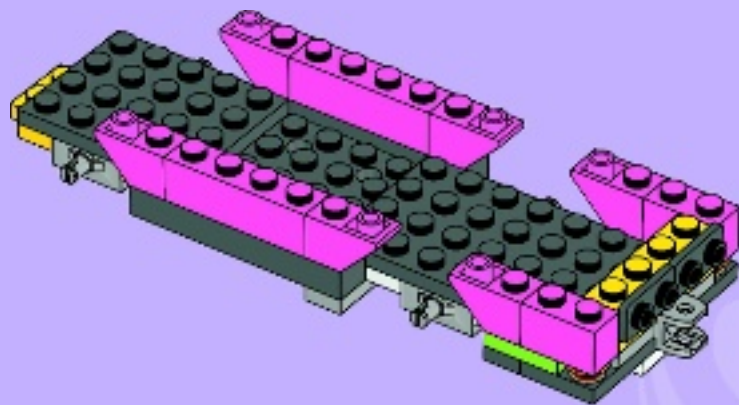



13

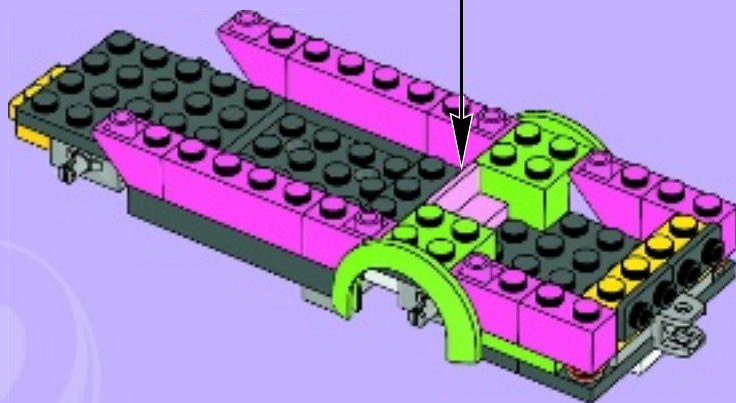
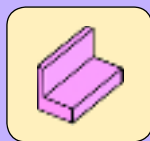



14

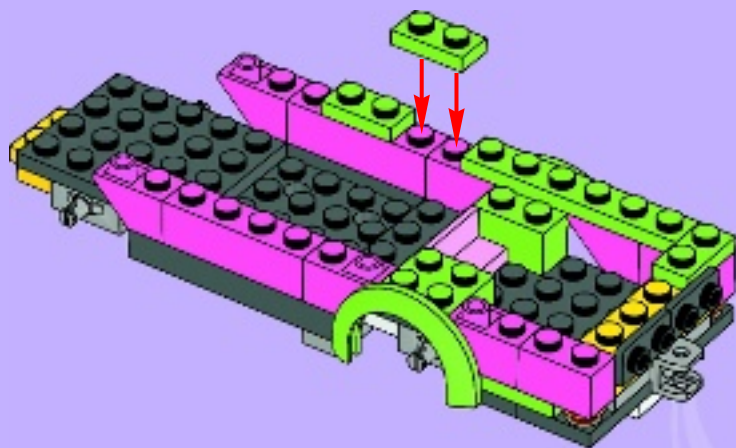

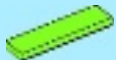

2x



2x



2x

15

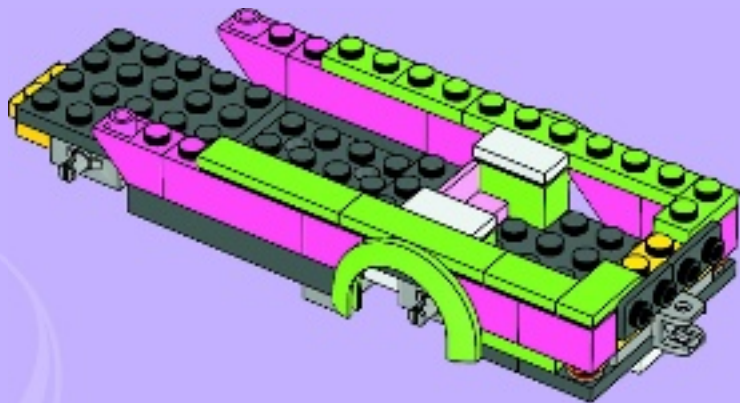

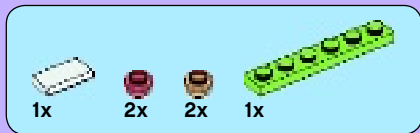

16

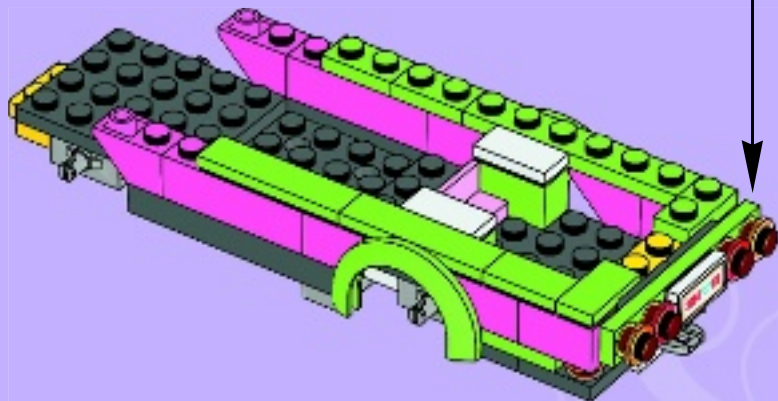



1x



1x

17

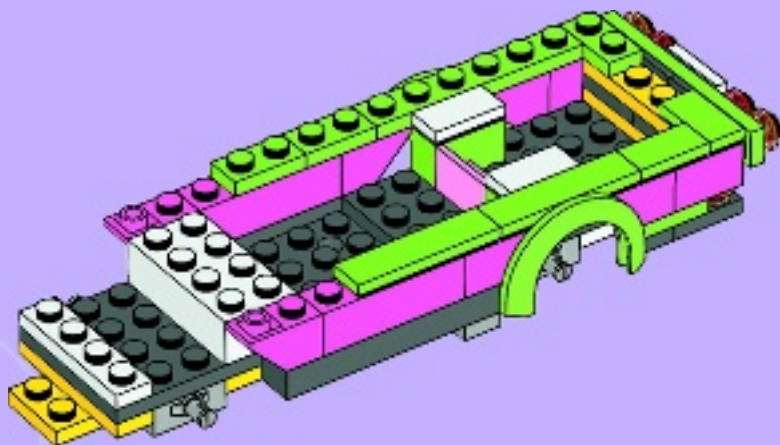



18

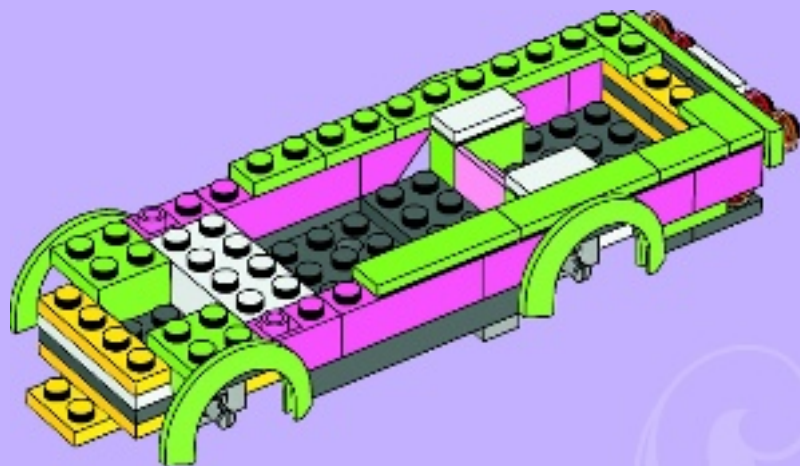

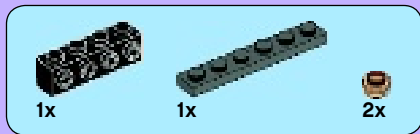

19

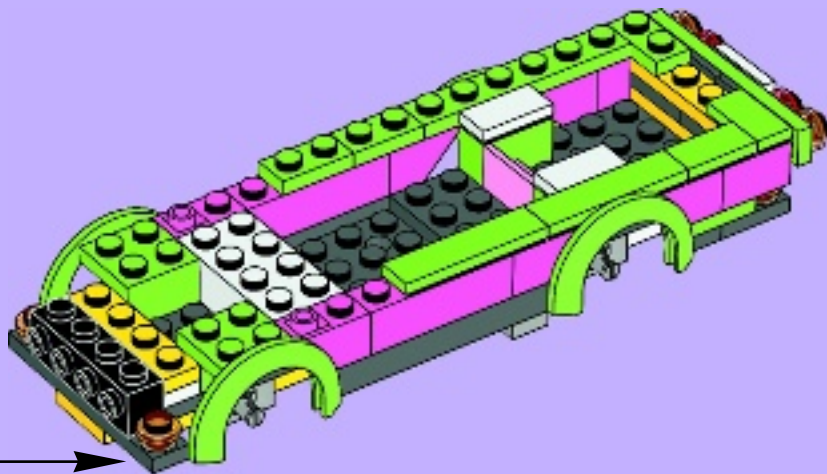
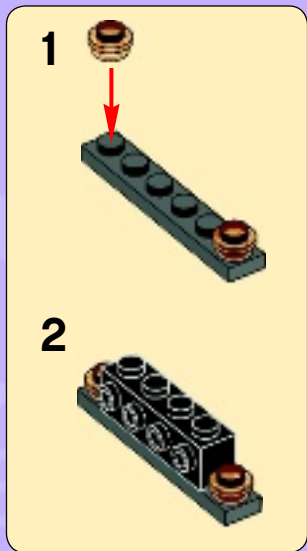



1x

20

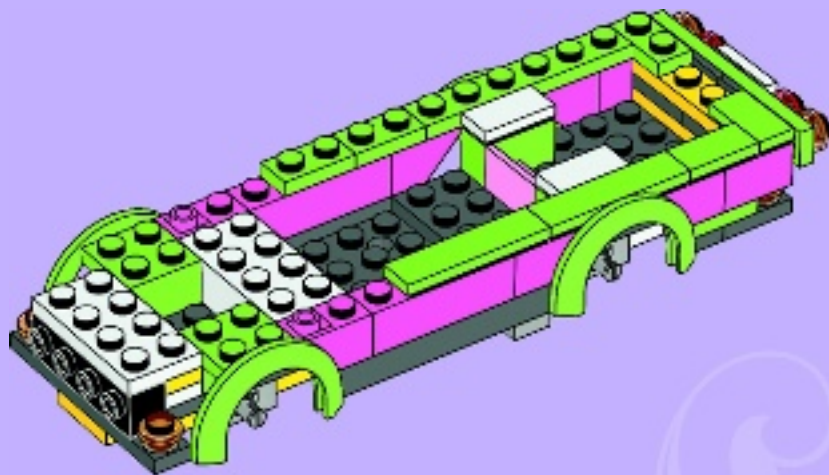



2x

21



2x

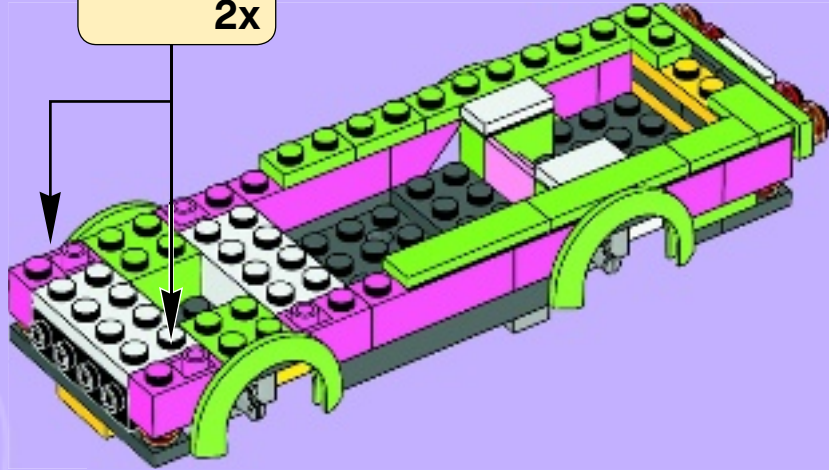



3x

22

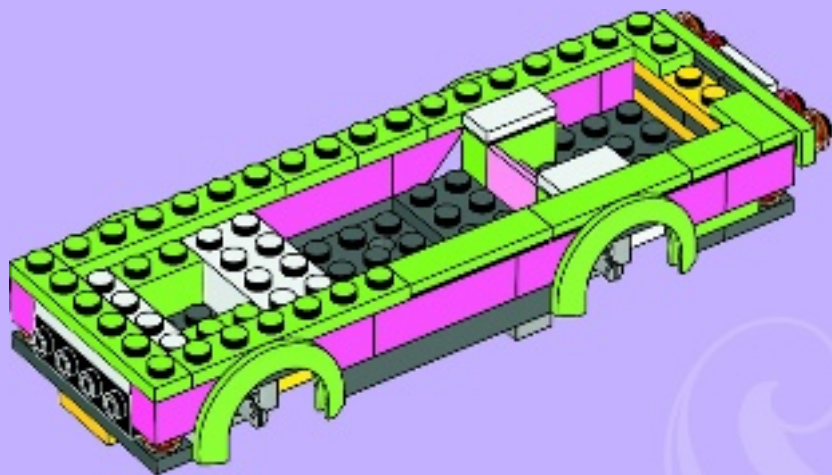



23

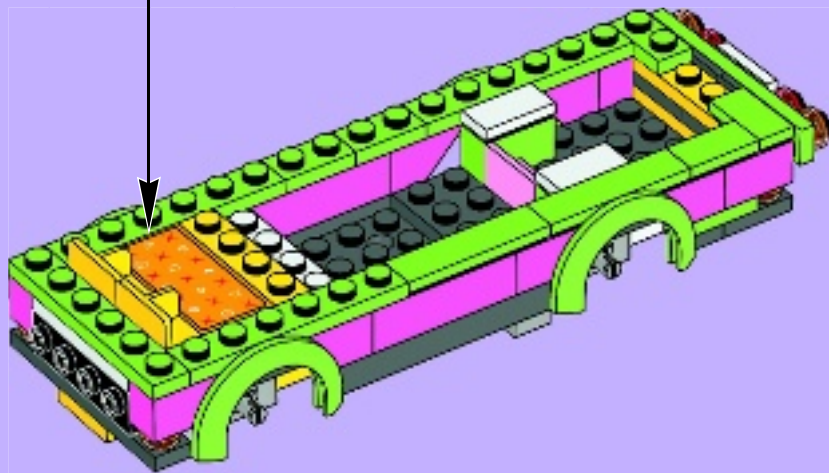
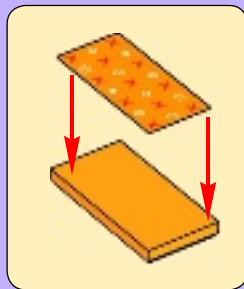



1x



1x

24

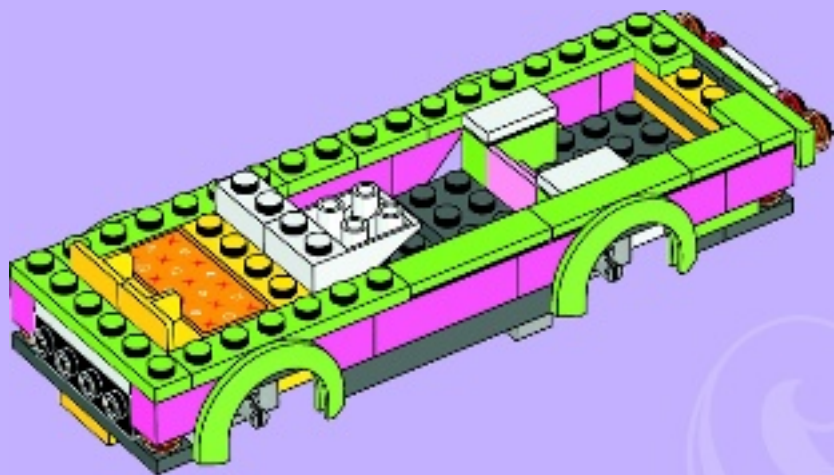

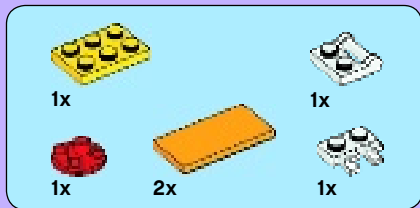

25

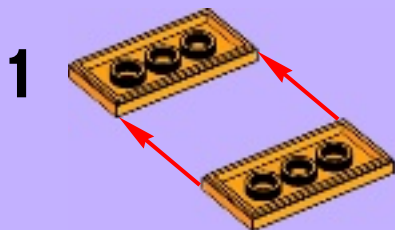

3



4

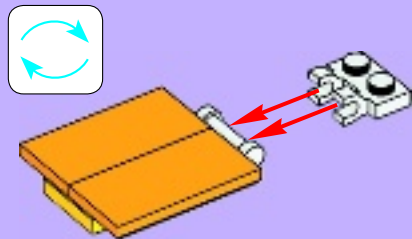

5

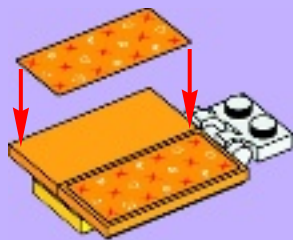

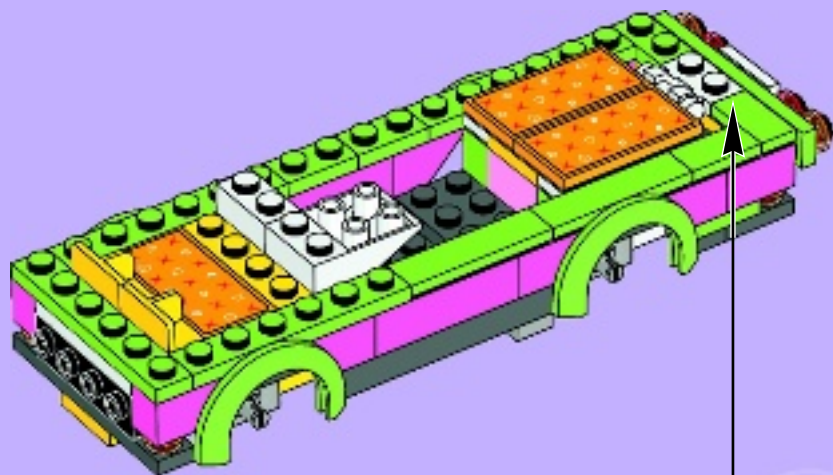

26

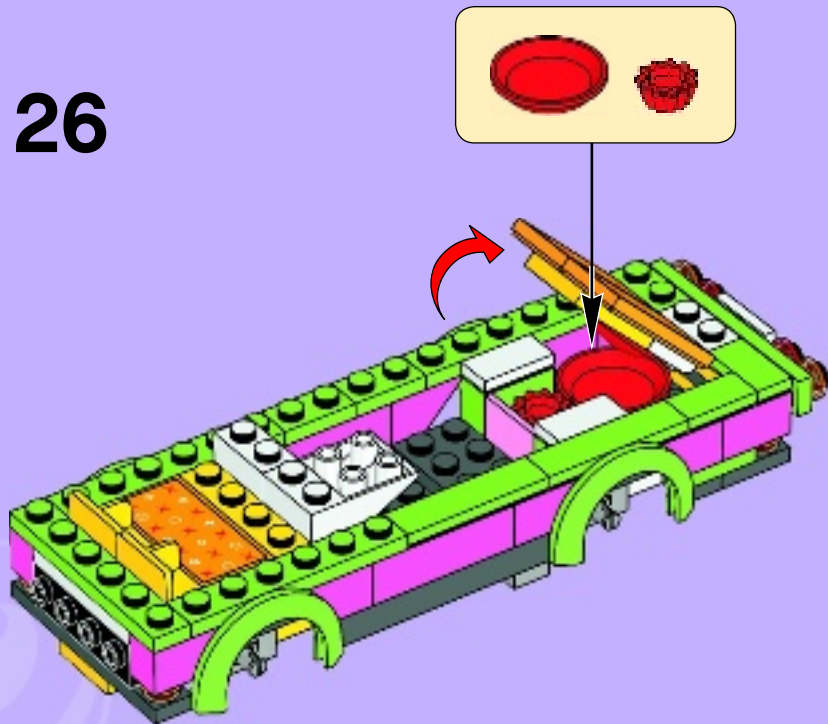

3



1x



1x

27

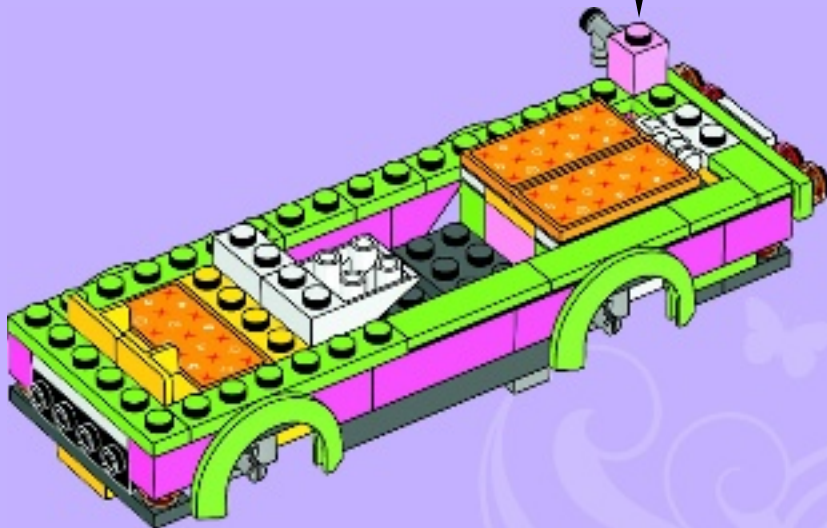
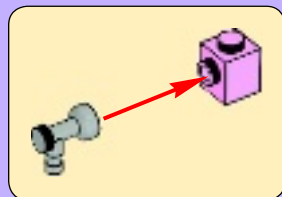

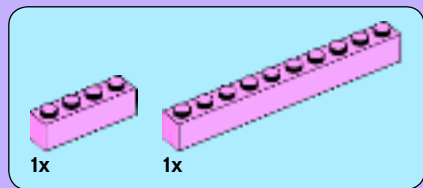

28

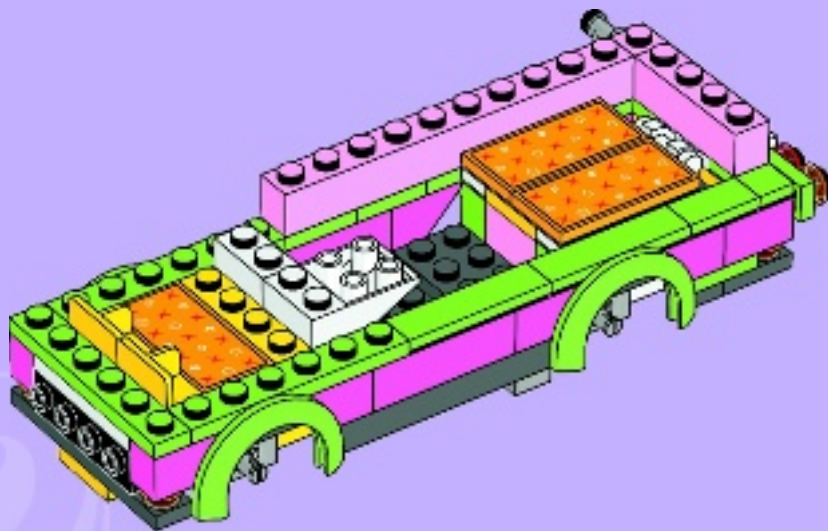



1x



1x



1x

29

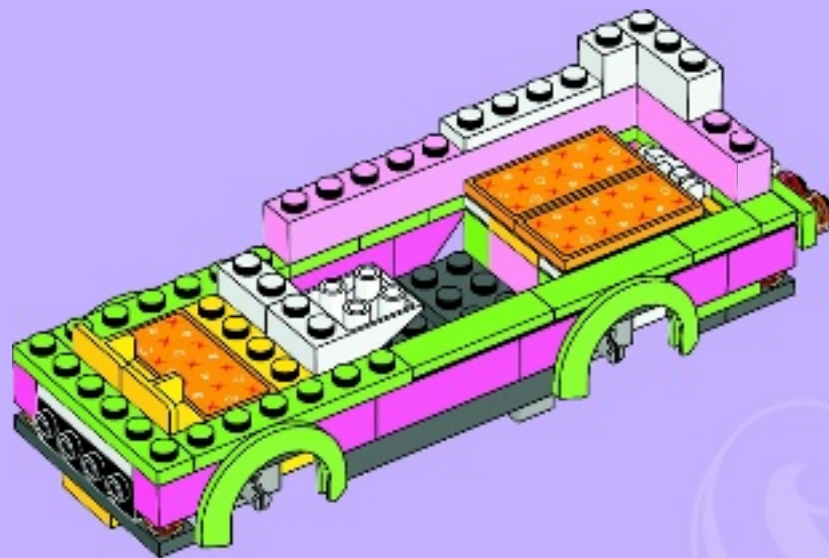

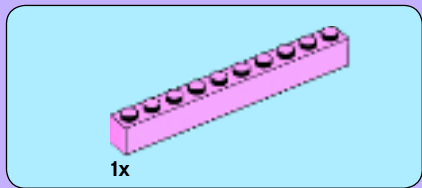
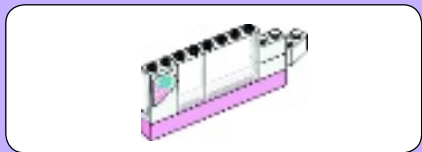

1

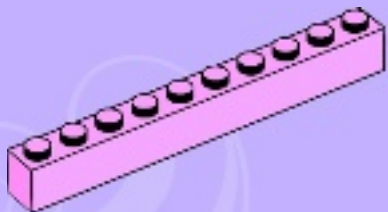

2

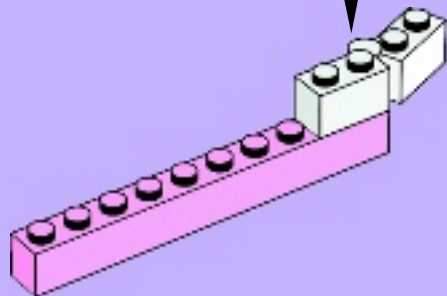
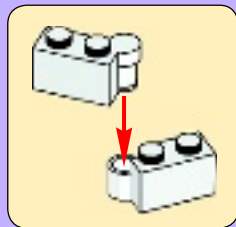



3

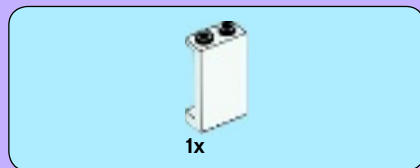
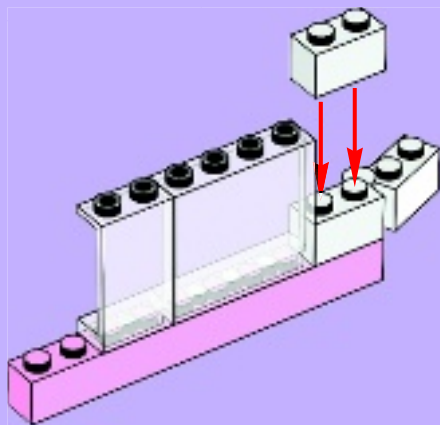

4

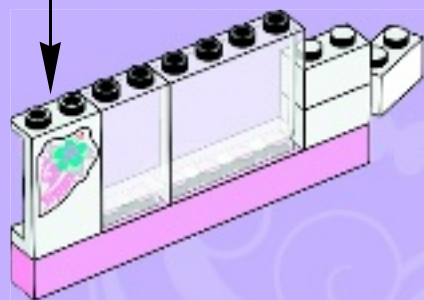
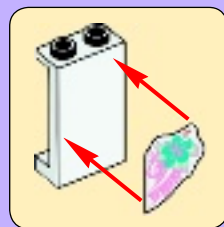

30

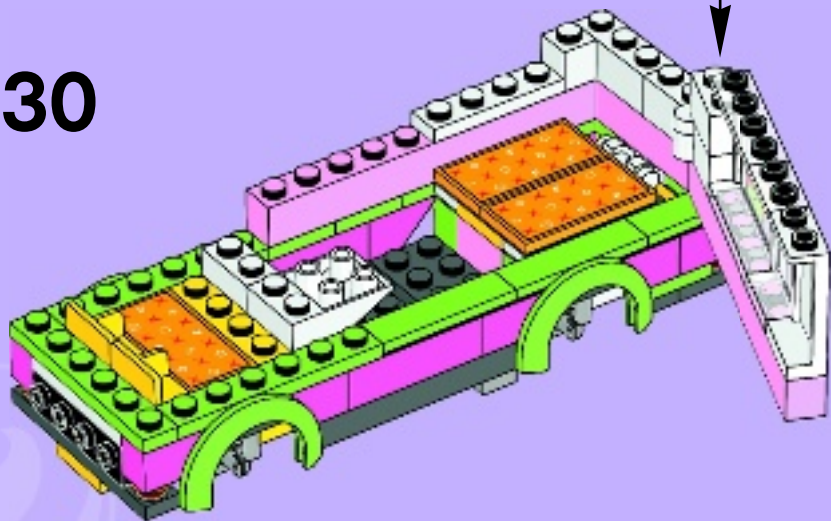



1x



1x

31

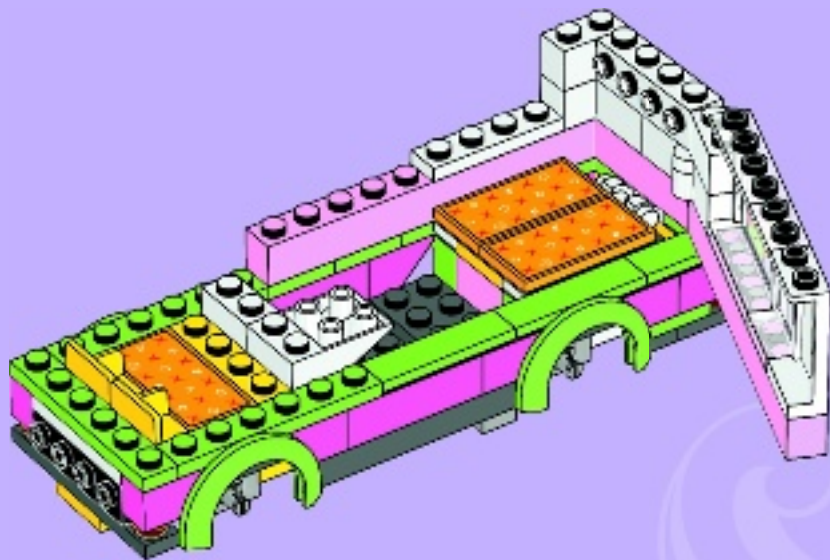



1x



1x



1x

32

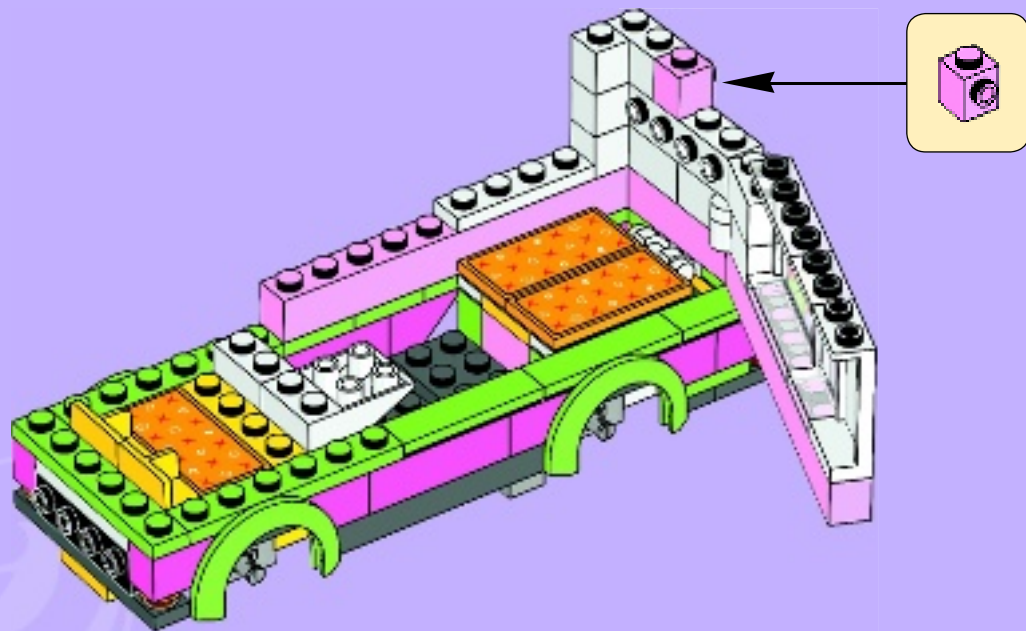



1x



1x

33

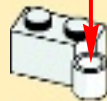
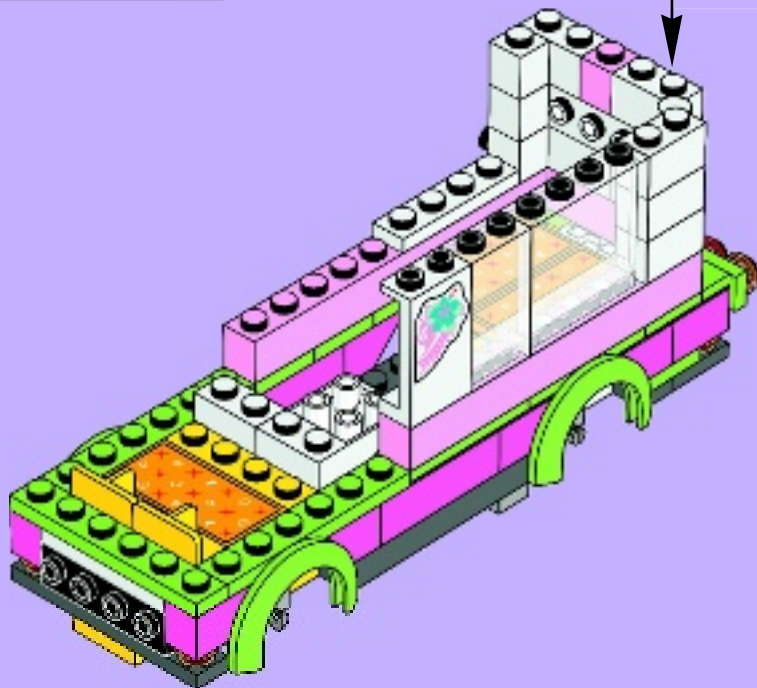

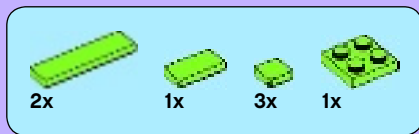

34

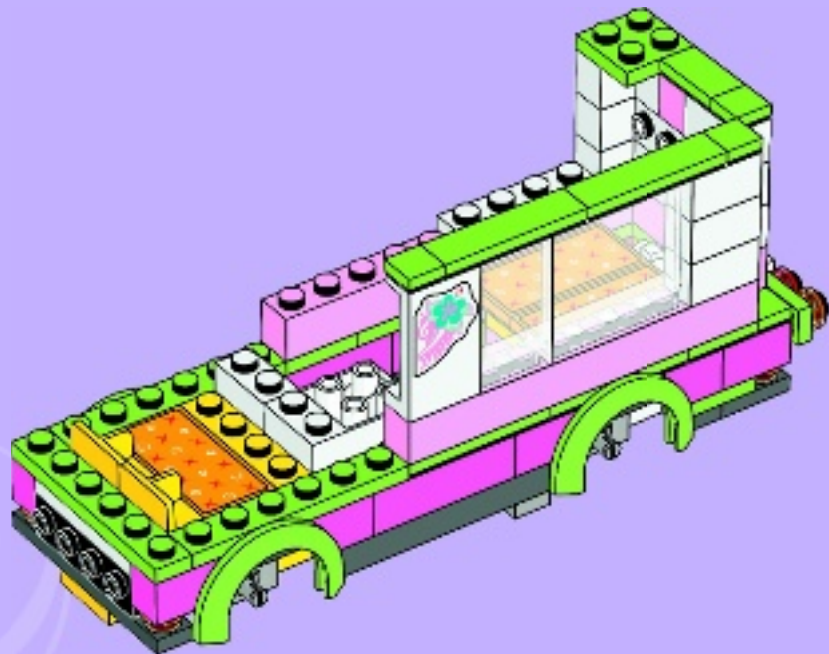

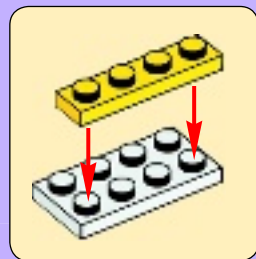

35

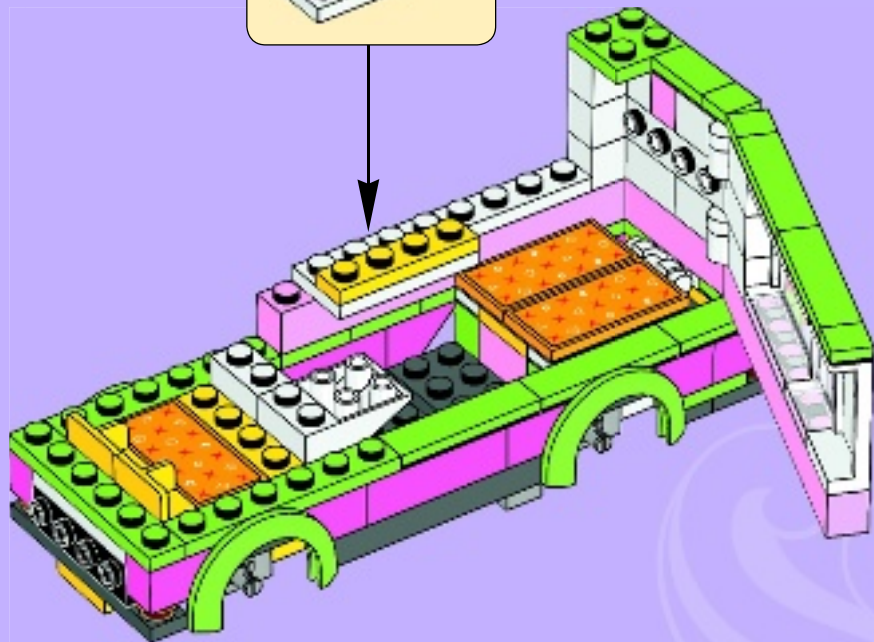



36

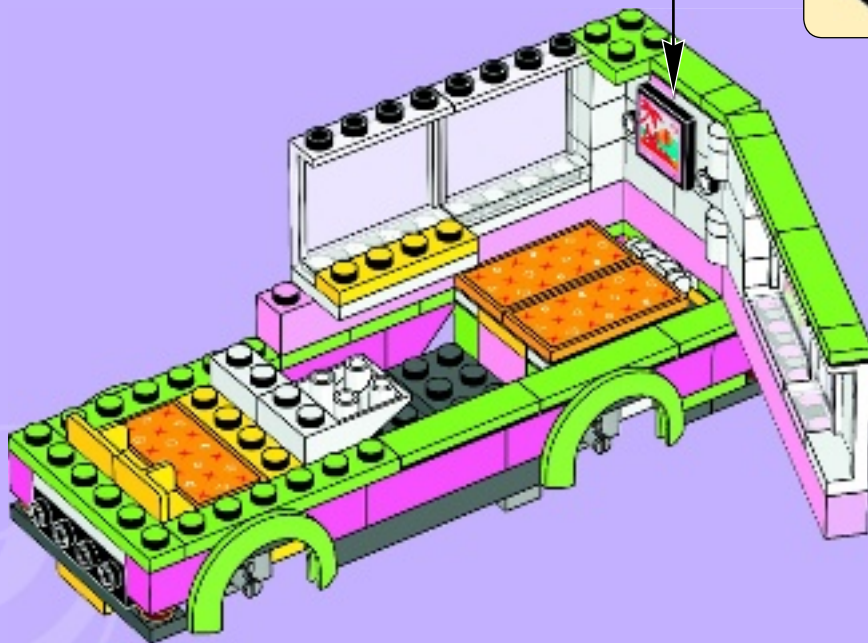



1x

37

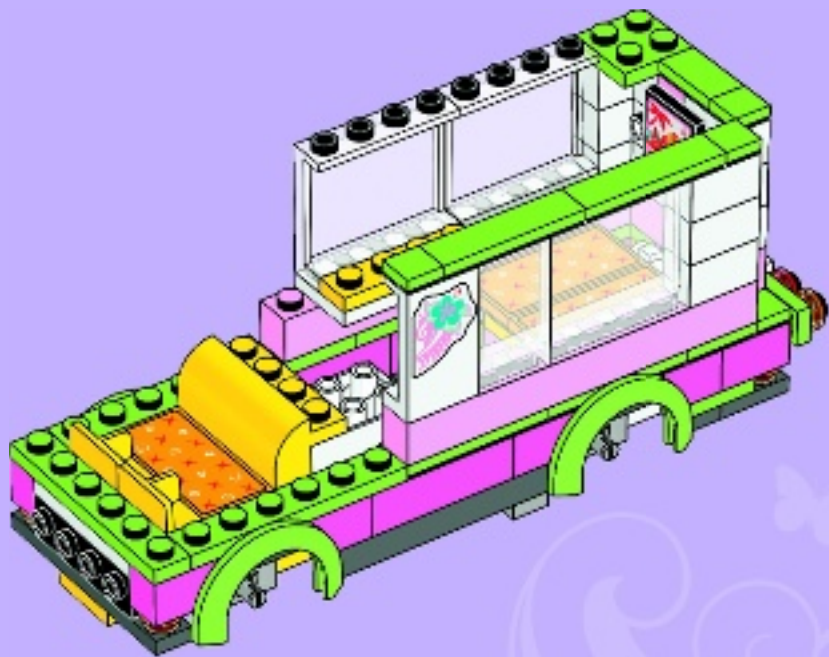

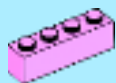

2x



2x

38

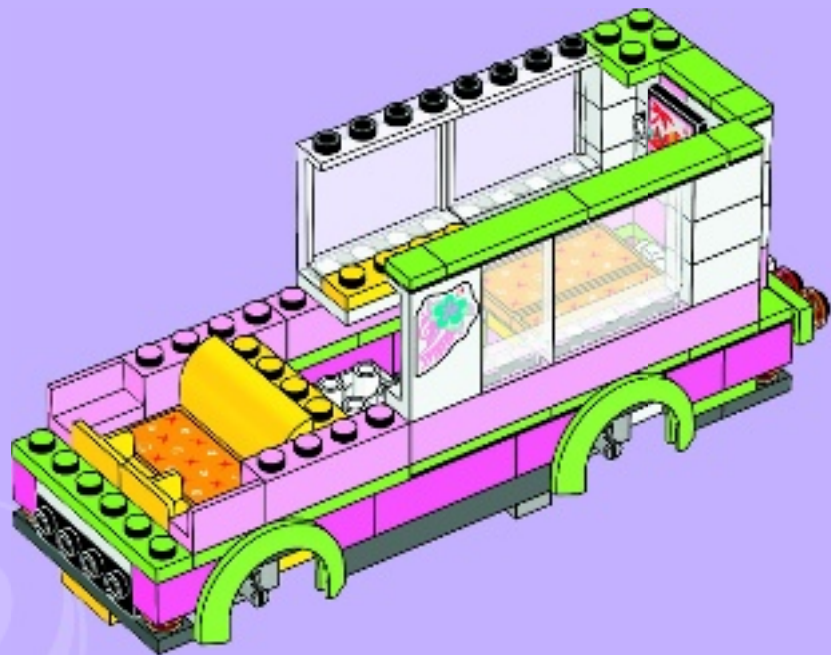



2x



1x

39





1x



2x

40

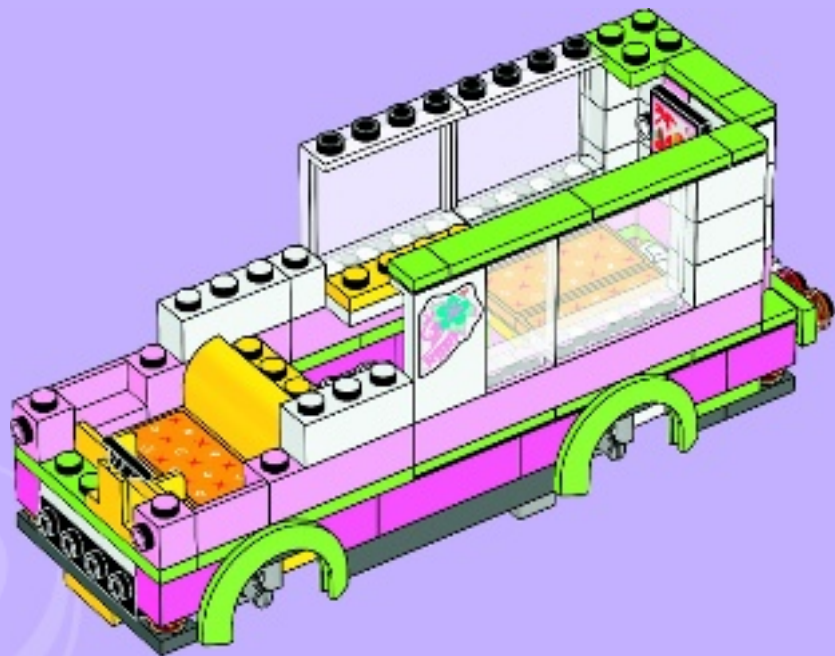



1x



2x

41





42

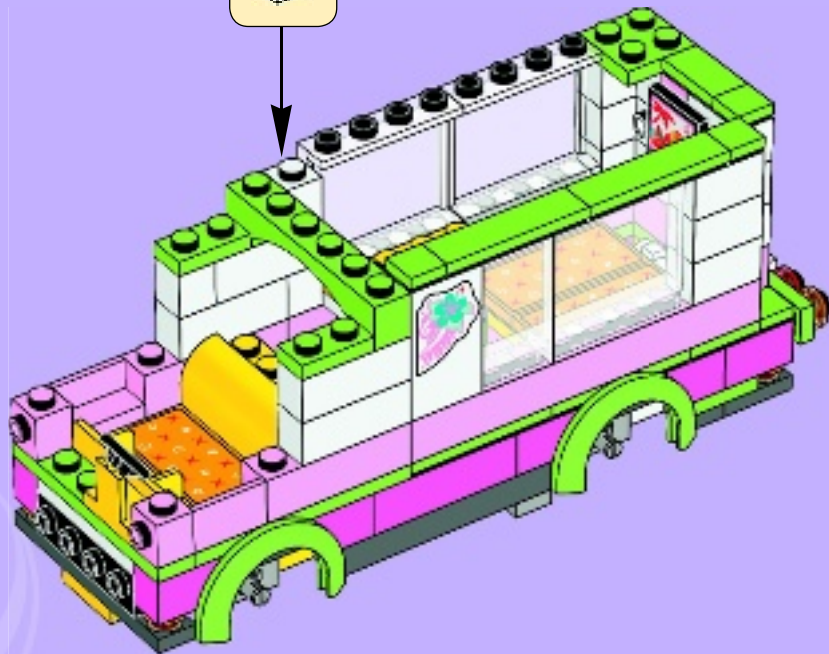
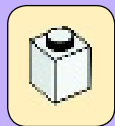



1x

43





1x



1x

44





1x



2x



3x

45



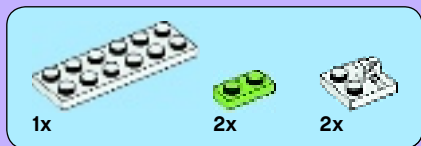

46

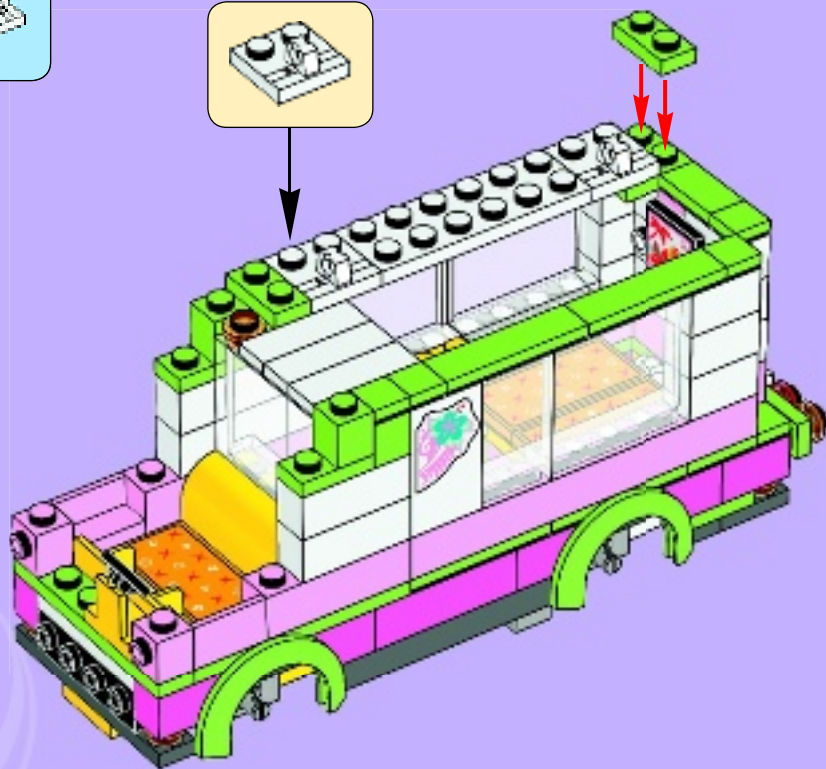



3x

47

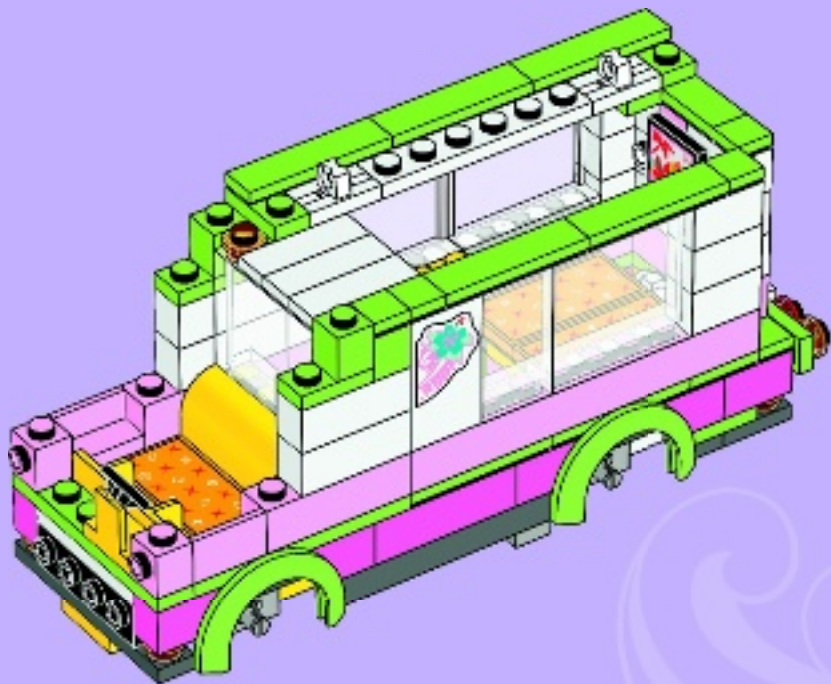

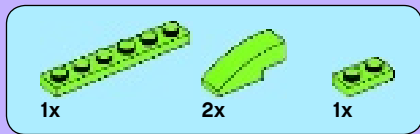

48

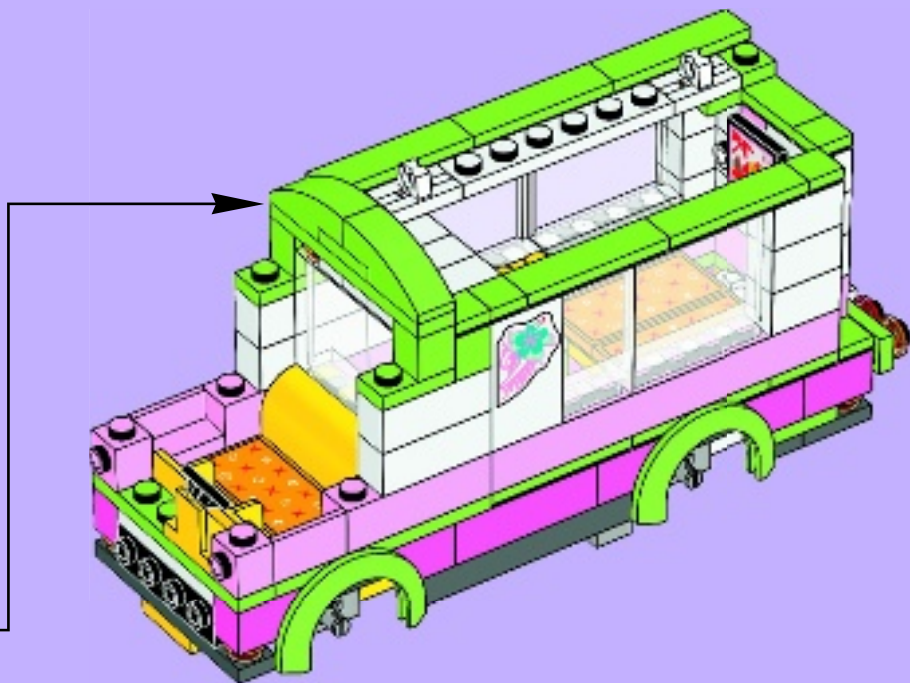
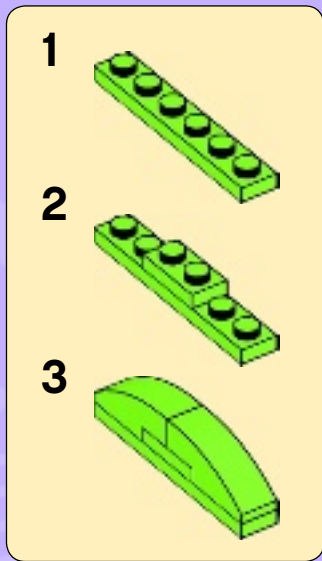



1

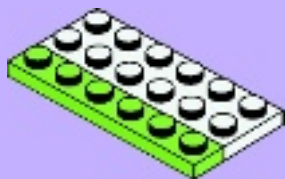

2



3





3x



2x

4



1x



2x



2x

5

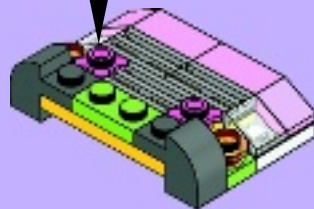



1x

6

49

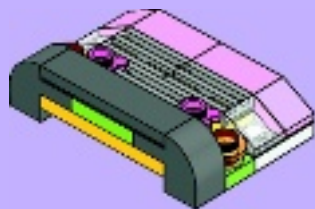

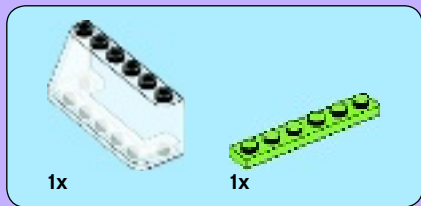

50

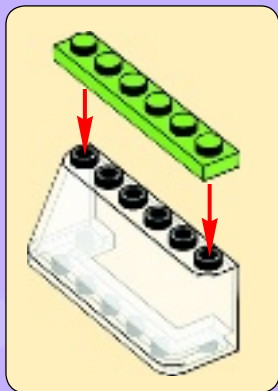

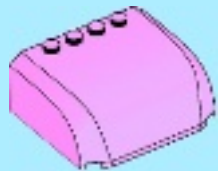

1x

51



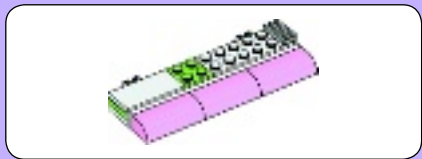

1

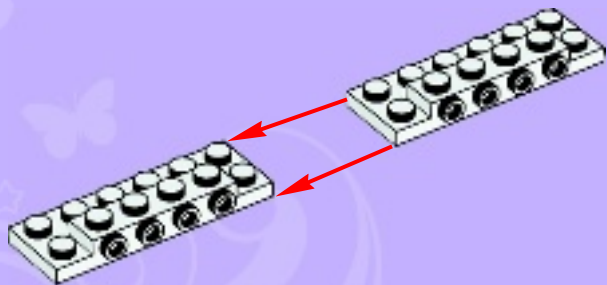

2

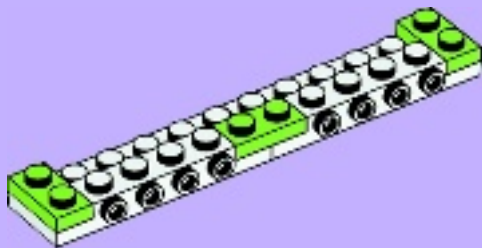

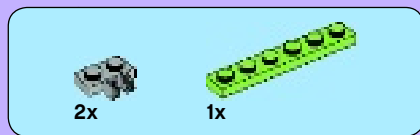

3

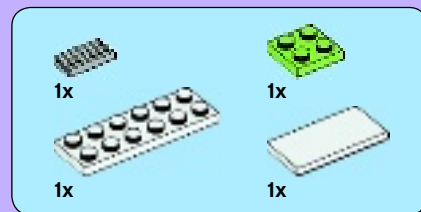
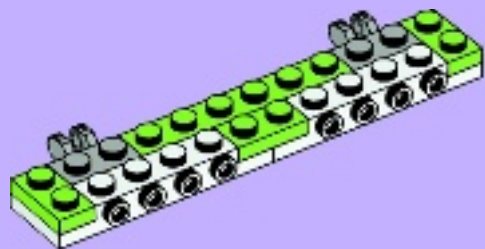

4

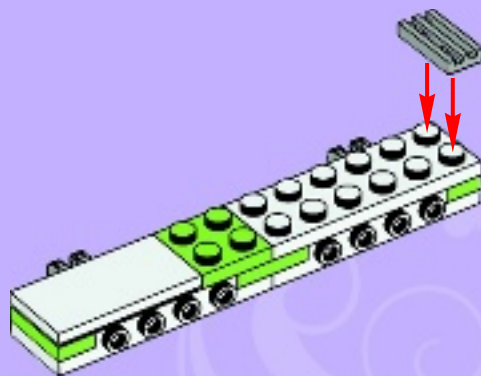

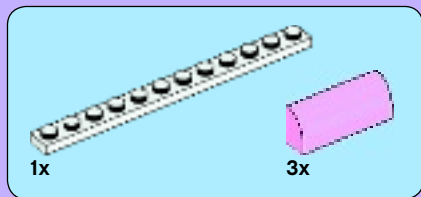

5

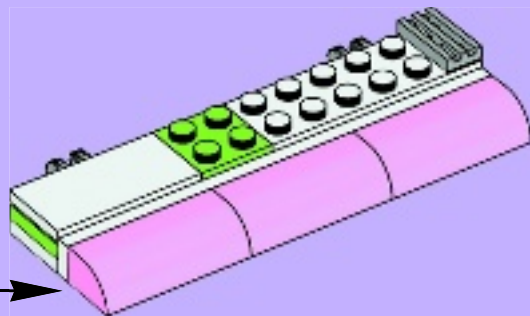
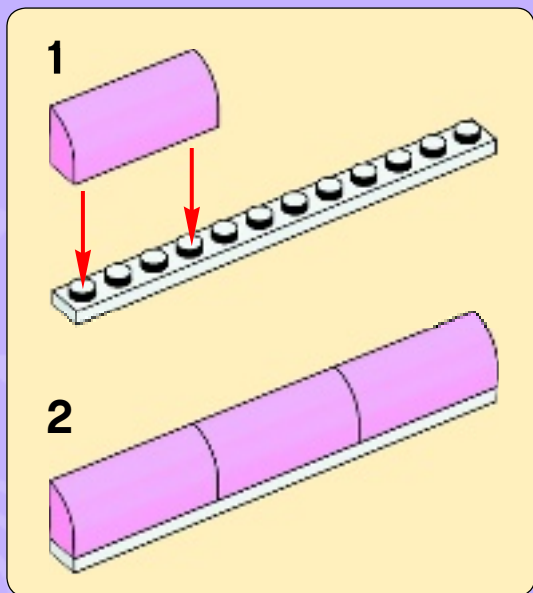

52



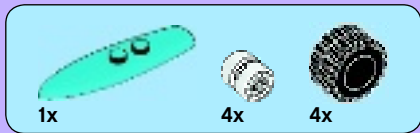

53

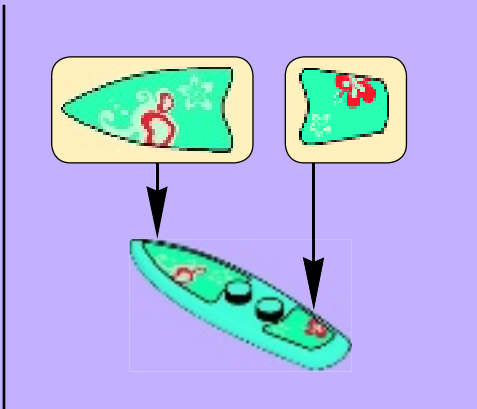

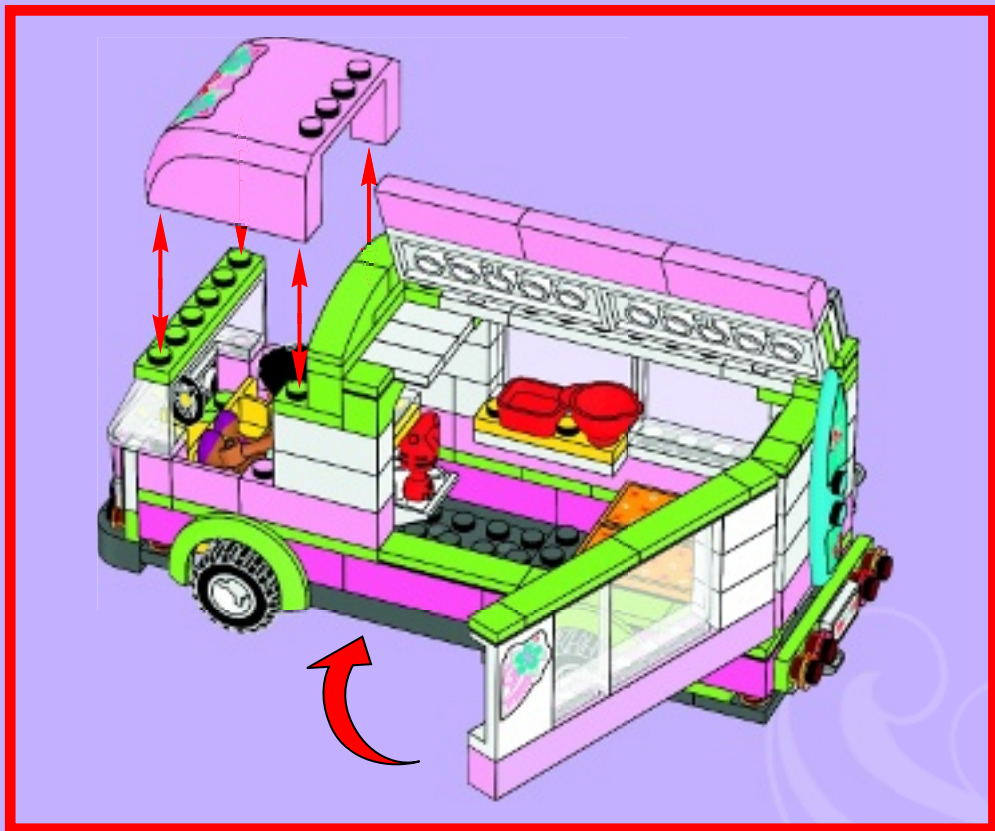



| | | | | | | |
|---|--|--|--|---|--|--|
|  5x 300501 |  3x 379501 |  3x 4558168 |  1x 4204625 |  1x 4113993 |  1x 4162443 |  2x 4244362 |
|  4x 300401 |  2x 346001 |  1x 4560178 |  1x 302124 |  2x 4114324 |  1x 302226 |  1x 6010737 |
|  5x 362201 |  1x 383201 |  2x 4560929 |  7x 371024 |  2x 4621545 |  1x 379526 |  4x 4594686 |
|  1x 300101 |  1x 4514842 |  1x 4585448 |  1x 4243817 |  6x 4621542 |  1x 306826 |  1x 4502193 |
|  1x 4143254 |  1x 4556152 |  6x 4170457 |  2x 303424 |  8x 4622743 |  1x 4650864 |  2x 3000841 |
|  1x 4500469 |  2x 4535737 |  2x 6011456 |  1x 306924 |  2x 4244613 |  6x 4568644 |  6x 3005741 |
|  4x 4520970 |  1x 4222017 |  2x 383101 |  1x 614124 |  2x 4216479 |  1x 4114348 |  1x 4504371 |
|  5x 371001 |  2x 4613762 |  3x 306901 |  2x 4621603 |  2x 4618670 |  1x 4278013 |  1x 4596241 |
|  2x 302001 | |  4x 4622574 |  1x 9553 | | | |

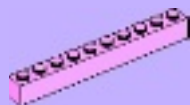

2x
4621550



1x
4615728



3x
4518890



3x
4619591



2x
4580010

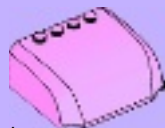

1x
4621553



4x
4621554



3x
4599830



2x
4599538



11x
4222960



1x
6011435



1x
4612387



1x
4621988



1x
6011436



1x
4622827



1x
4621993



2x
4220634



2x
4537928



1x
4625474



18x
4164037



3x
4537937



12x
4529160



4x
4537251



3x
4500125



11x
4164021



4x
4571221



1x
4622047



6x
4211398



2x
4515341



10x
4211350



1x
4244627



1x
4667166



1x
4211503



6x
6018081



1x
4620433



1x
6003734



2x
4215496



2x
4211183



2x
4211190



2x
4221590

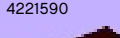

6x
4211204



1x
4216581



2x
4210797



2x
4565322



3x
4211065



2x
4211056



1x
4211002



2x
4211115

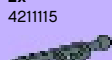

1x
4656697



1x
4520307



1x
4211053



1x
4210651



1x
4259901



1x
4652900



1x
4278275



1x
4558856



2x
6000606



1x
4289542



3x
4621543



3x
4621543



1x
4621637

Customer Service

Kundenservice

Service Consommateurs

Servicio Al Consumidor

www.lego.com/service or dial



00800 5346 5555 :



1-800-422-5346 :



1



2



3

www.LEGOclub.com/Nina

www.LEGOclub.com/Nina

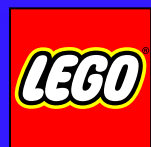

clubTM

FREE*! GRATIS! GRATUIT!

*Paid subscription in Australia and New Zealand.
*Abonnement payant en Australie et Nouvelle-Zélande.



Heartlake City



LEGO Friends



3934



3187



3183



3936



3935



3942



3186



3063



3065



3061



3184



Friends



LEGOFriends.com

 www.LEGO.com

LEGO and the LEGO logo are trademarks of the/son
des marques de commerce de/son marcas registradas
de LEGO Group. ©2012 The LEGO Group.
6014701 / 6014702