



# NINJAGO

Masters of Spinjitzu



9445



**FANGDAM INCLUDED**







1

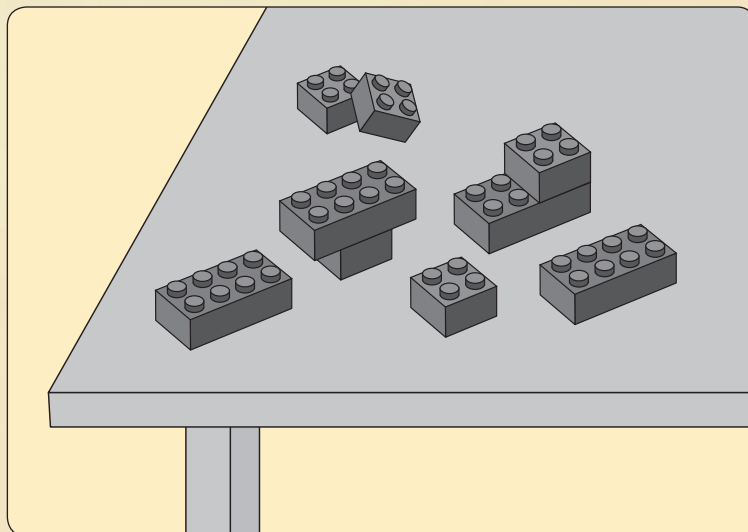
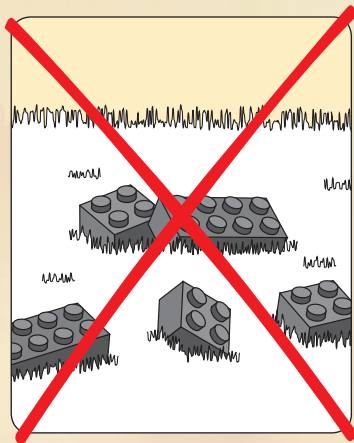

2

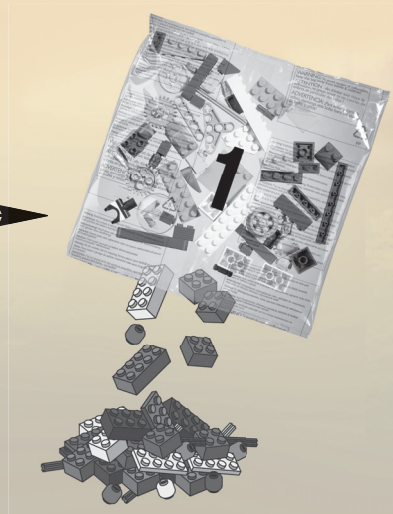

2





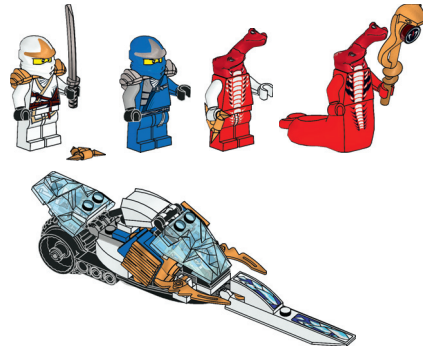

FANGDAM INCLUDED  
ENTHÄLT FANGDAM  
FANGDAM INCLUS  
INCLUYE A FANGDAM  
INCLUI FANGDAM  
FANGDAM A DOBOZBAN

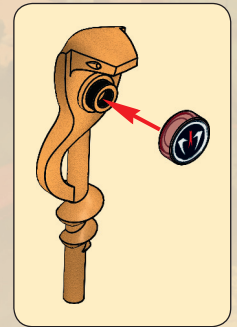
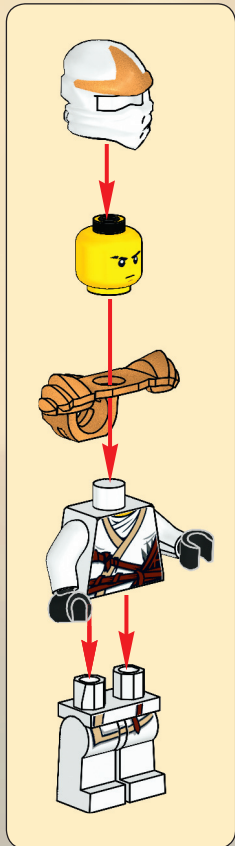



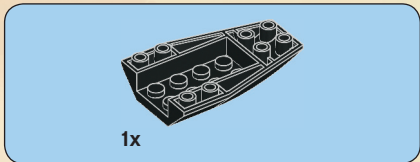
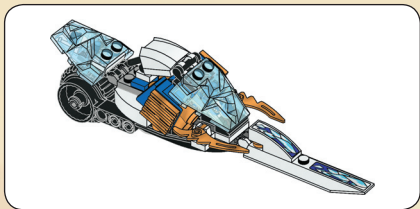

1

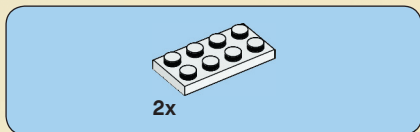
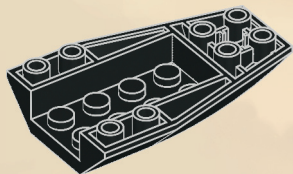

2

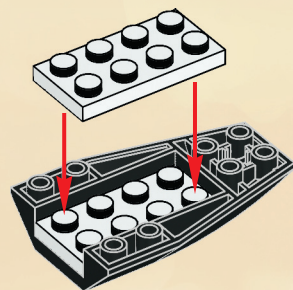



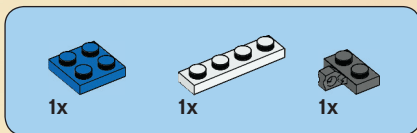

3

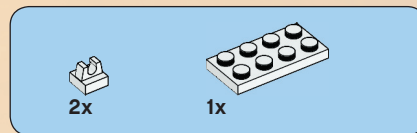
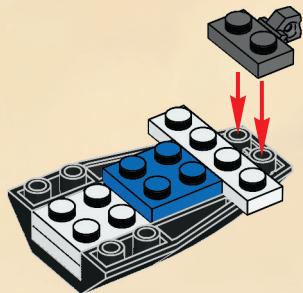

4

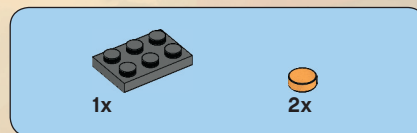
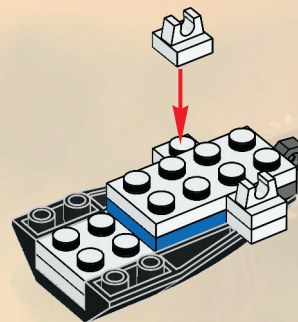

5

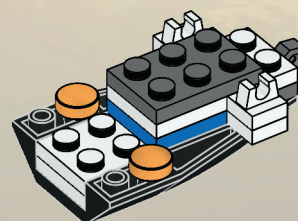





6

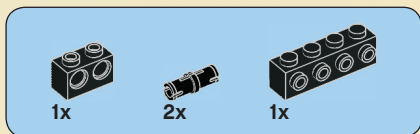
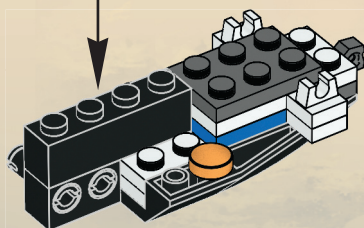
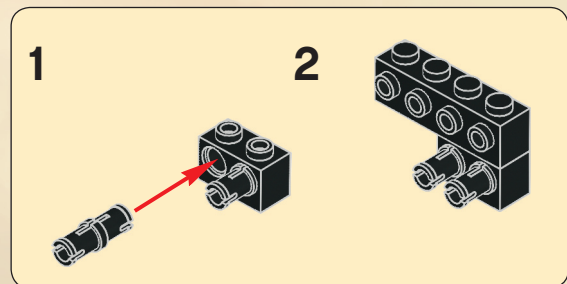

7

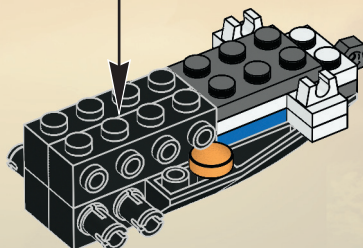
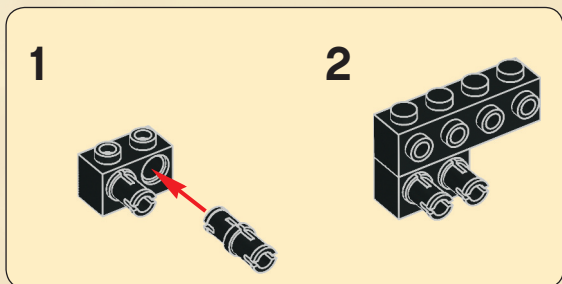



8

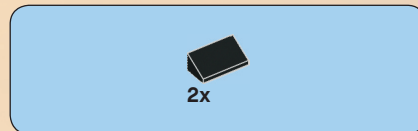
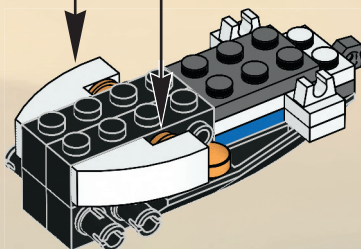
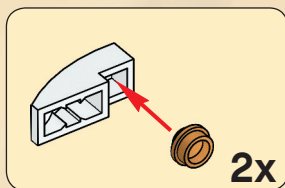

9

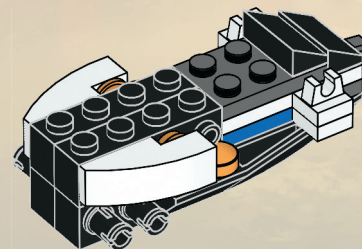



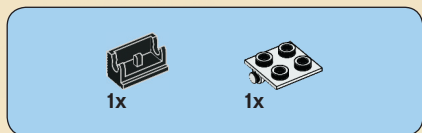

10

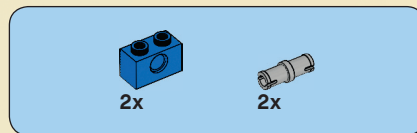
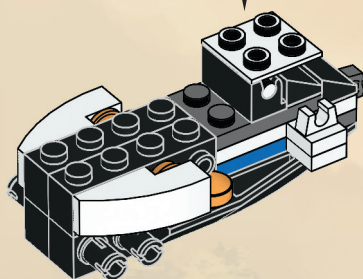
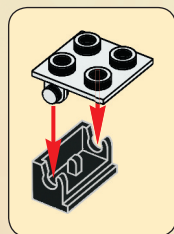

11

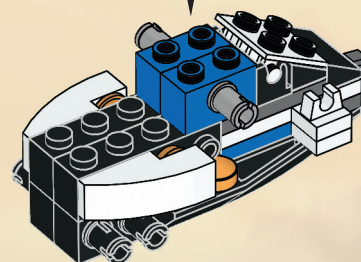
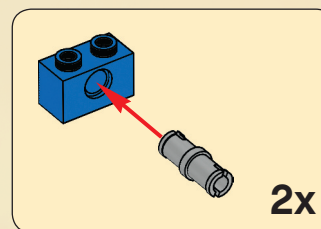

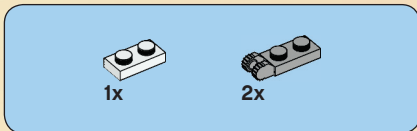

# 12

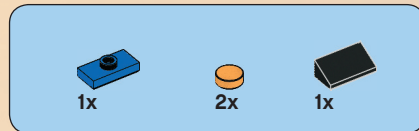
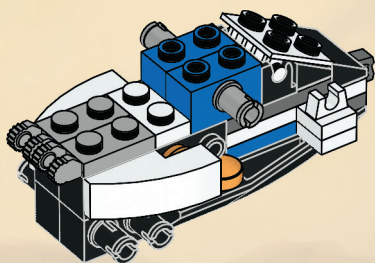

# 13

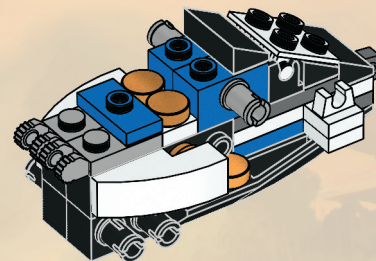

# 14

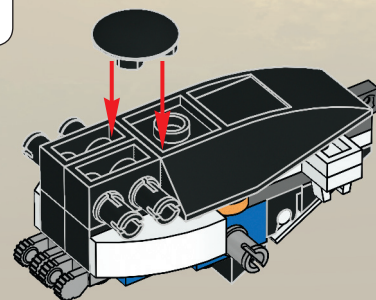
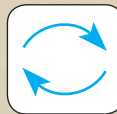



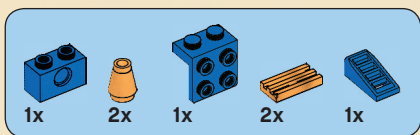

# 15

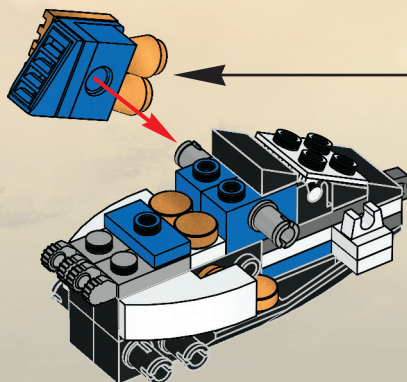
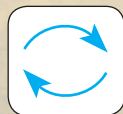
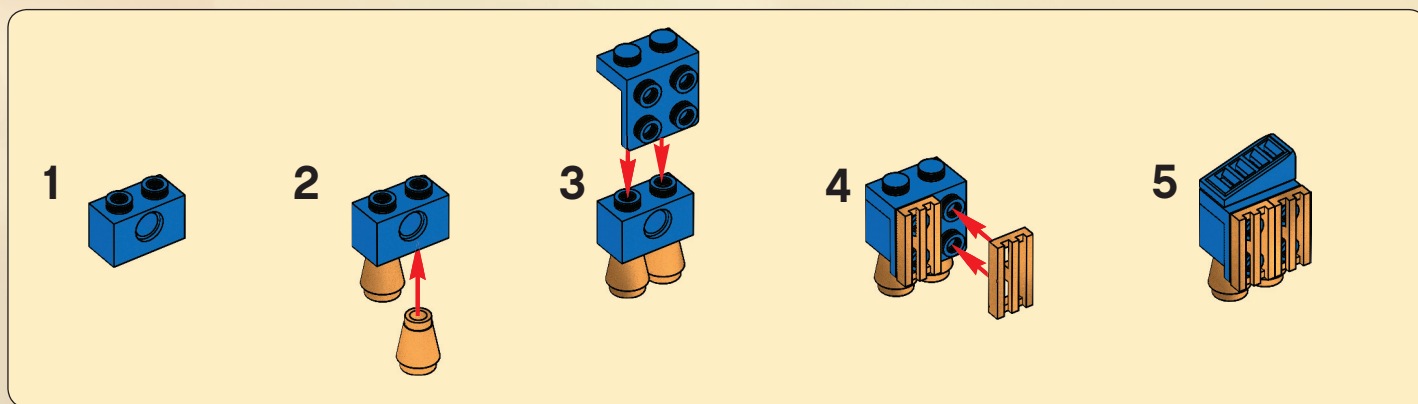

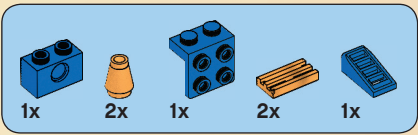

# 16

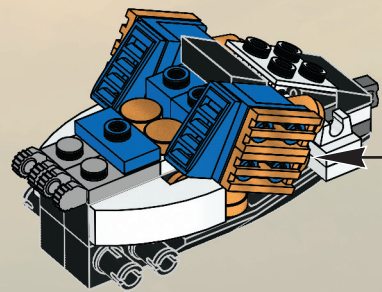
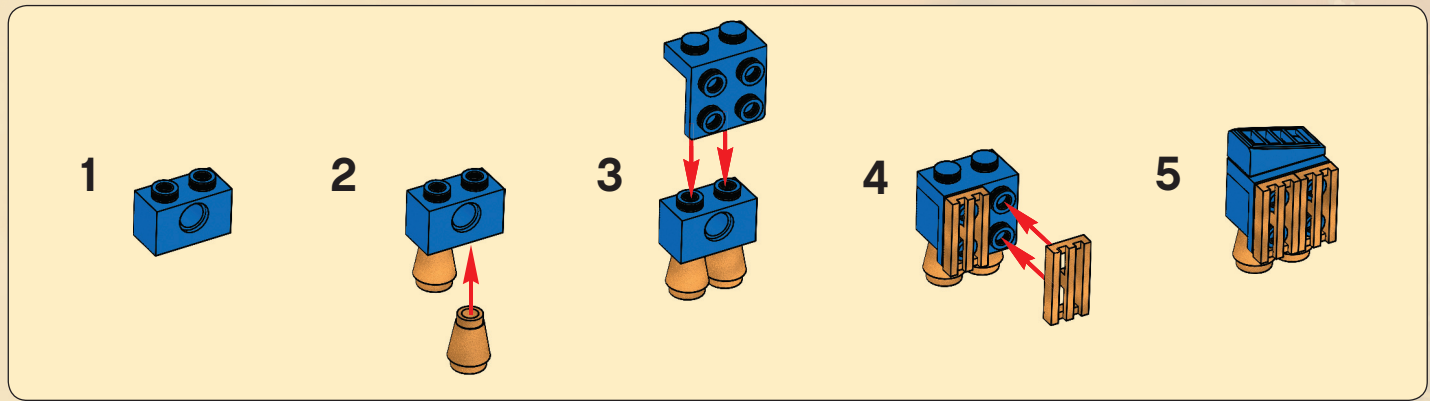





1x



1x

# 17

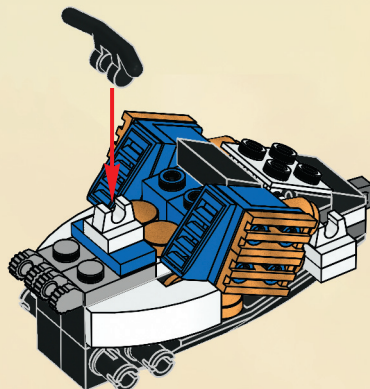

2x

# 18

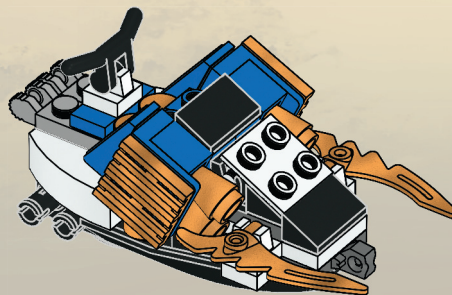



1x

# 19

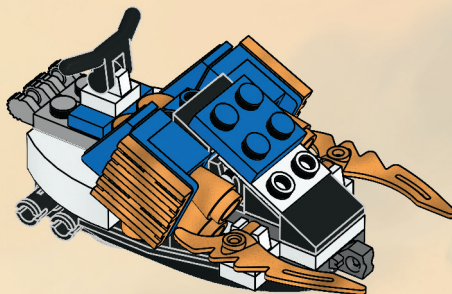

1x

# 20

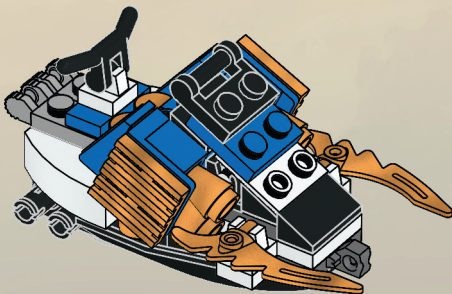



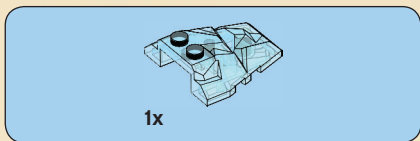

# 21

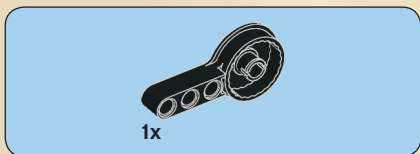

# 22

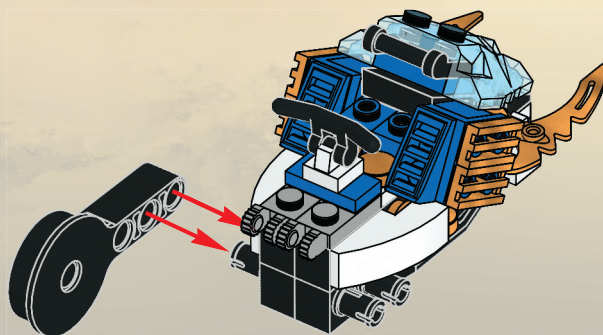

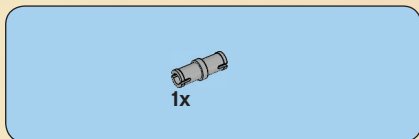

# 23

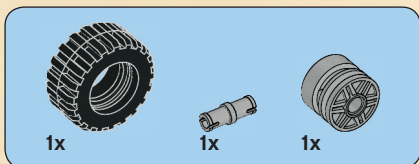
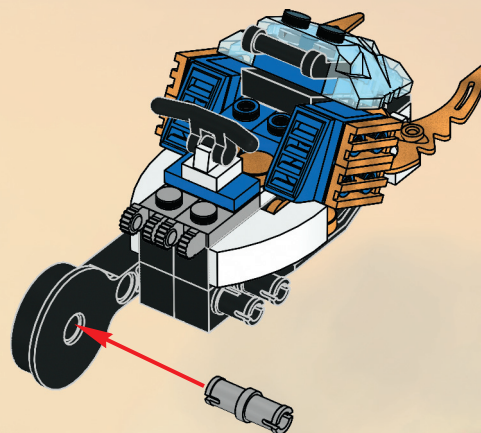

# 24

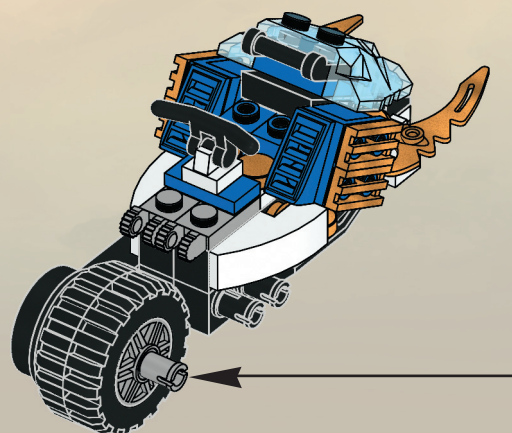
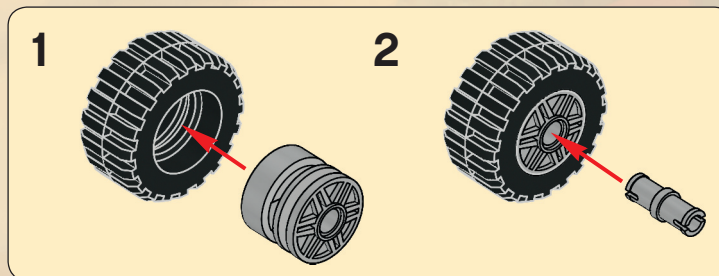

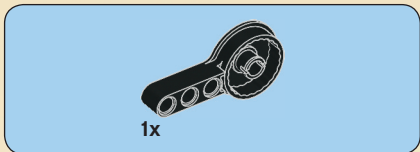

# 25

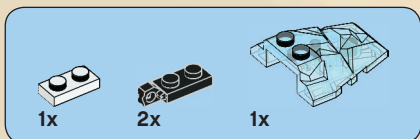
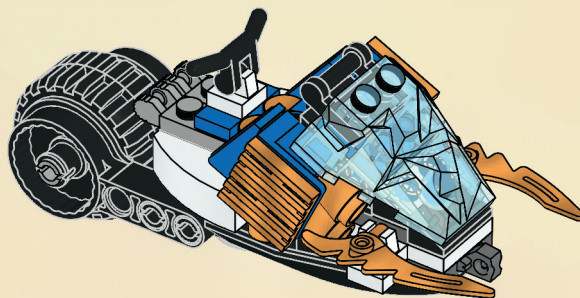

# 26

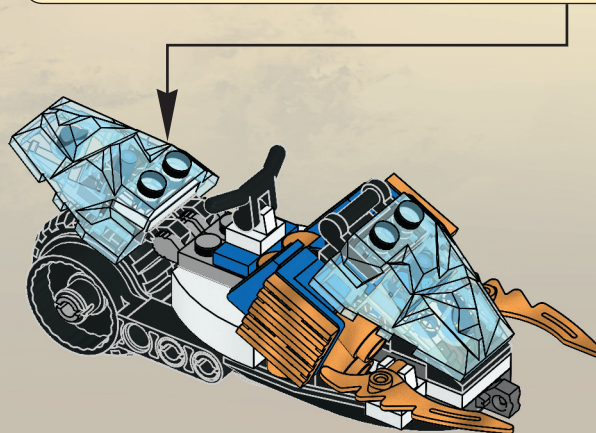
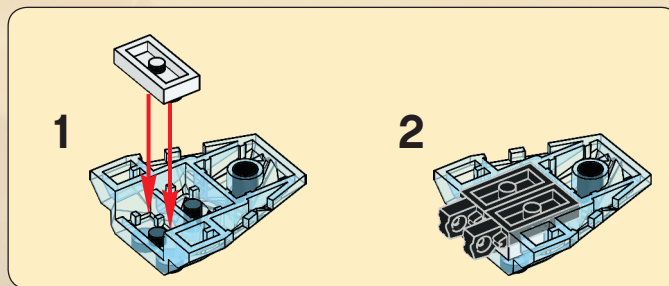

16





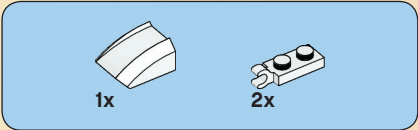

27

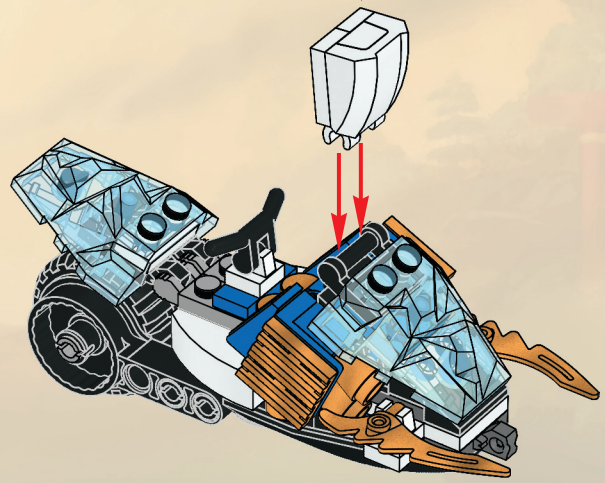
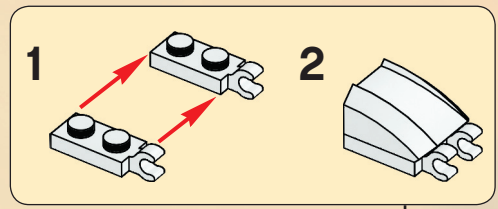

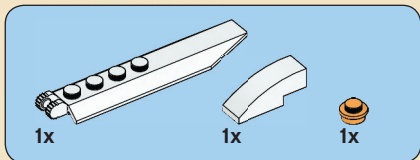

# 28

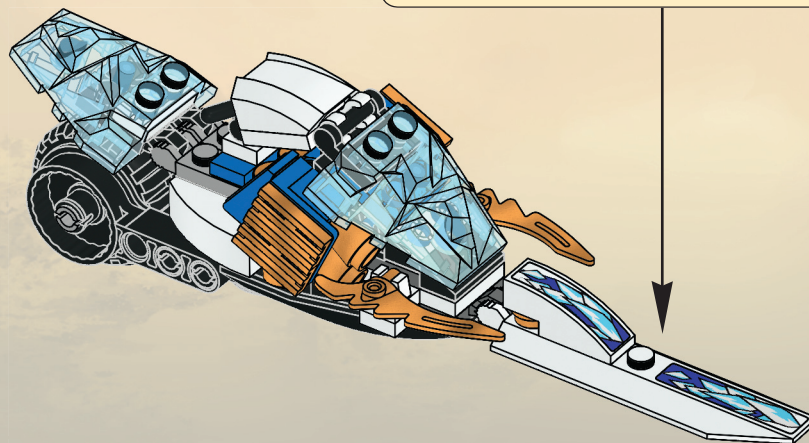
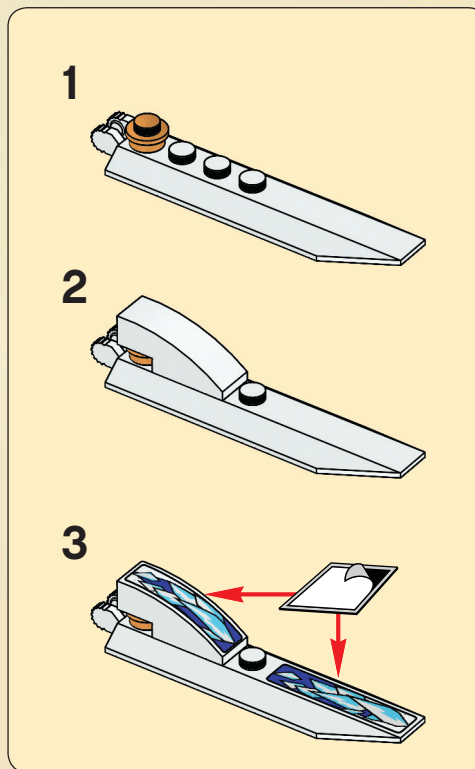



29

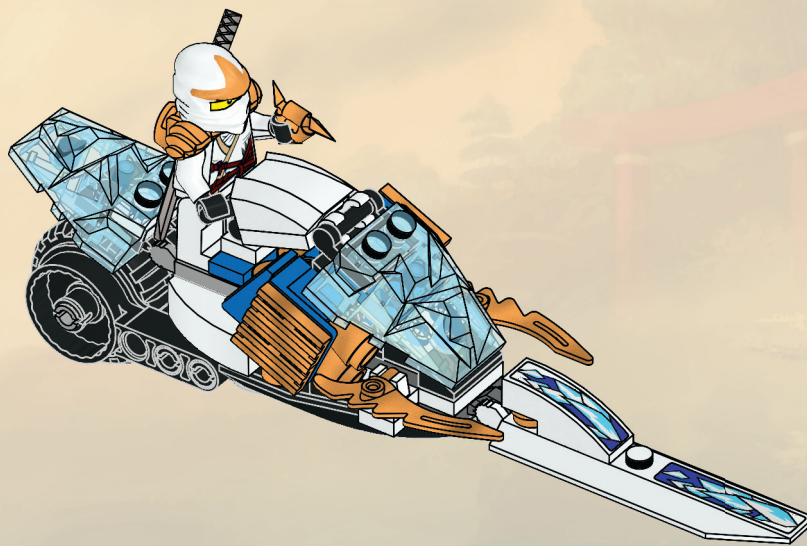



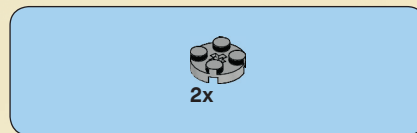

2

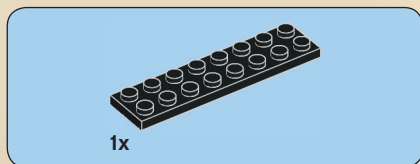
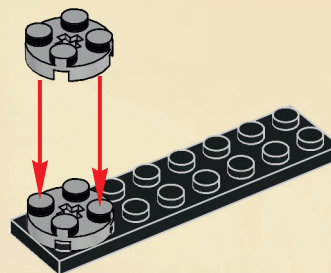

1

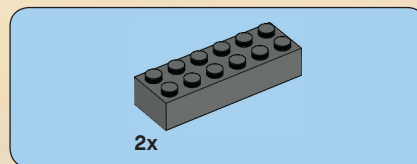
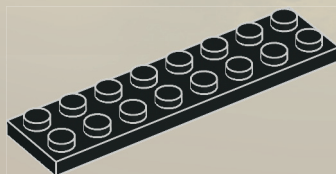

3

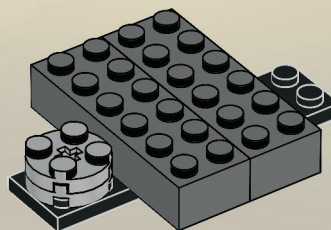

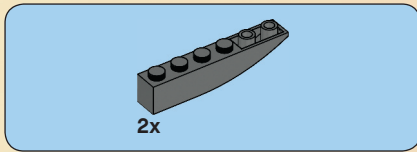

4

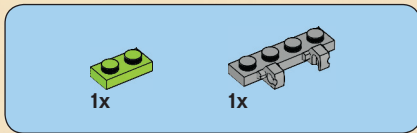
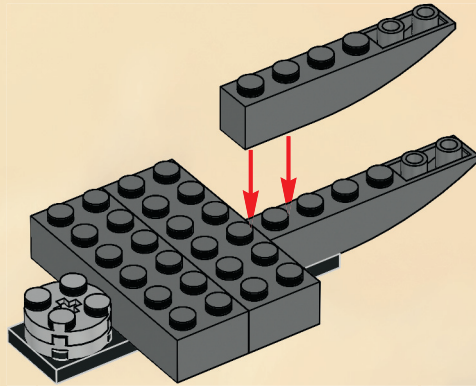

5

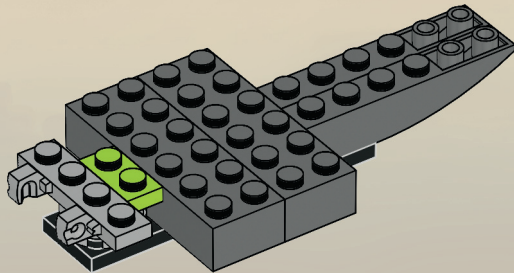

6

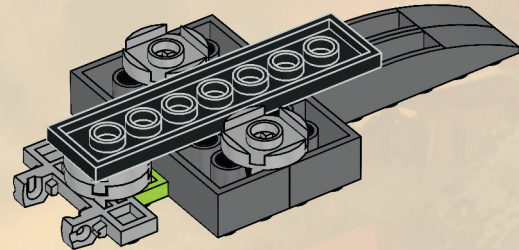
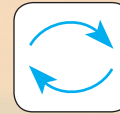

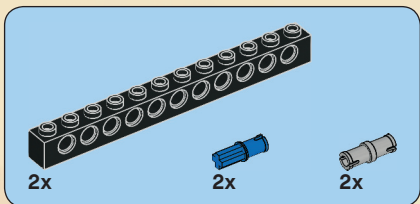

7

1

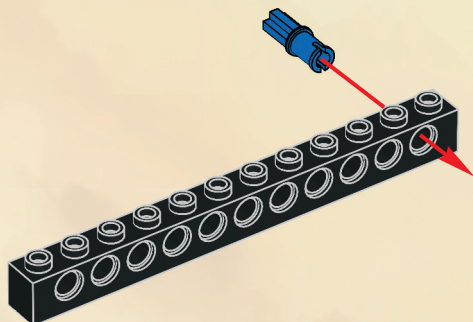

2

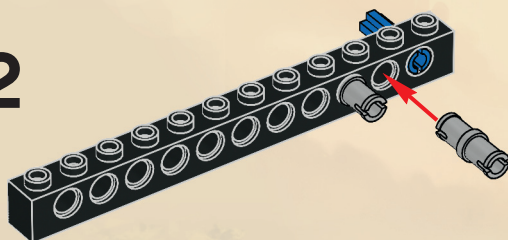

3

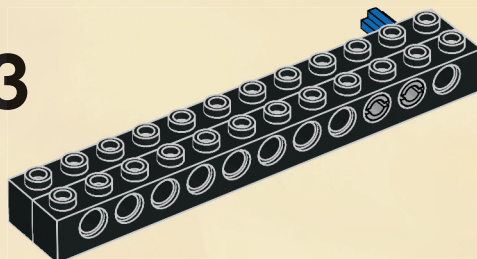

4

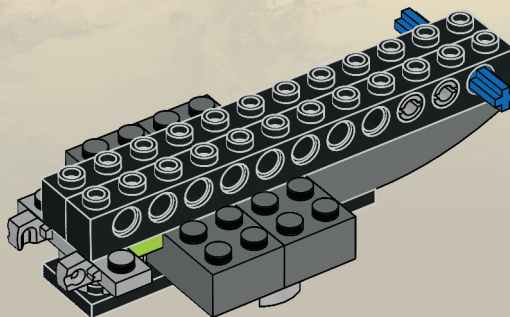
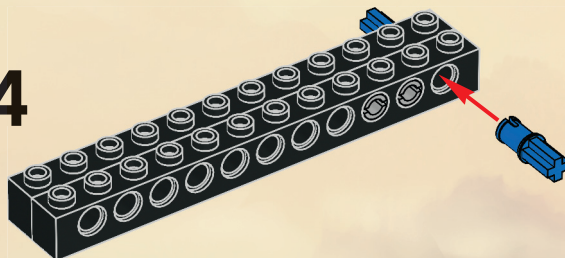



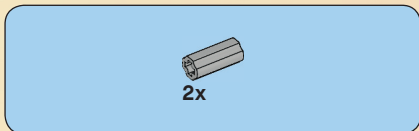

8

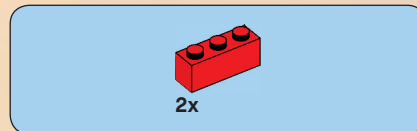
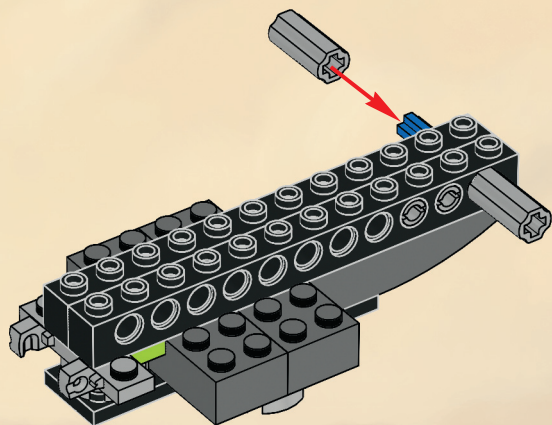

9

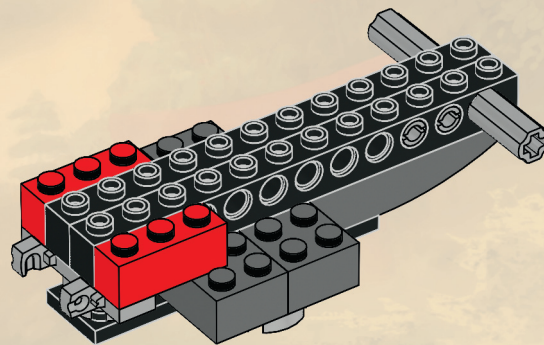

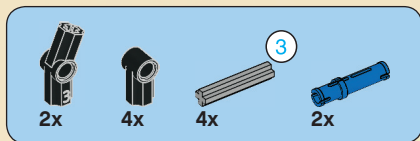

# 10

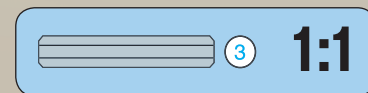
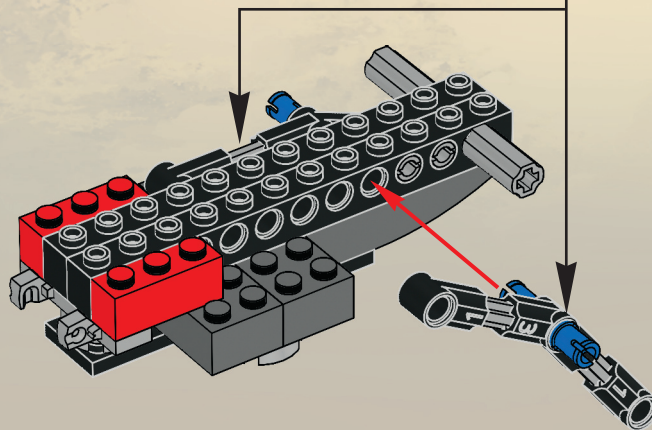
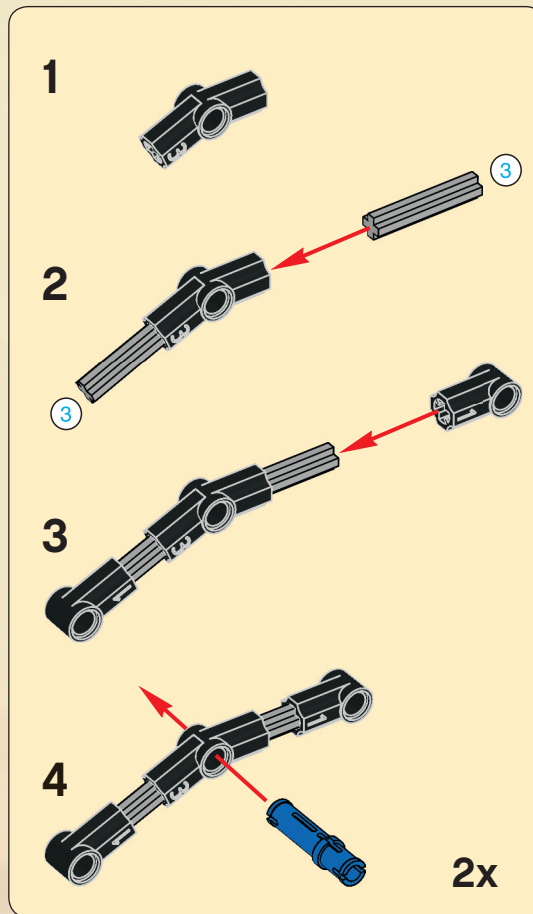

24



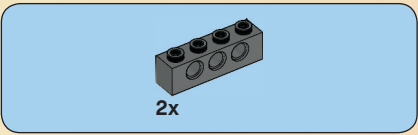

11

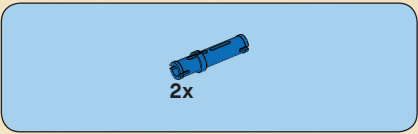
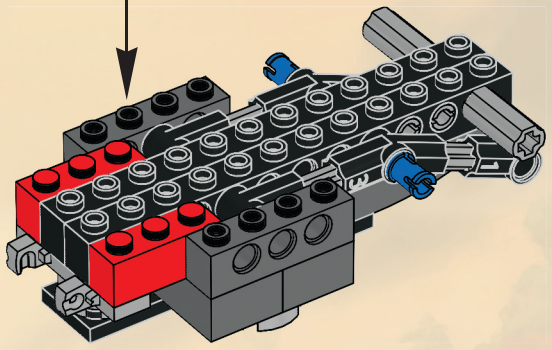
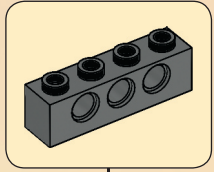

12

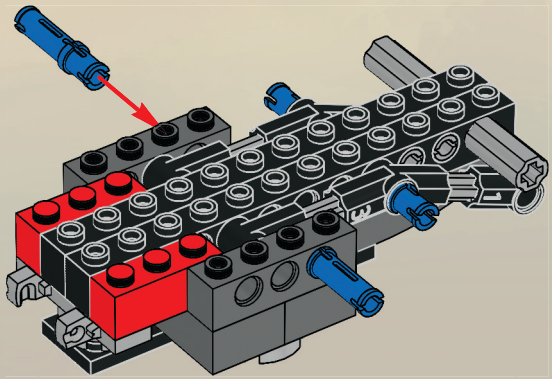



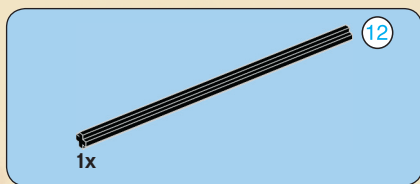

# 13

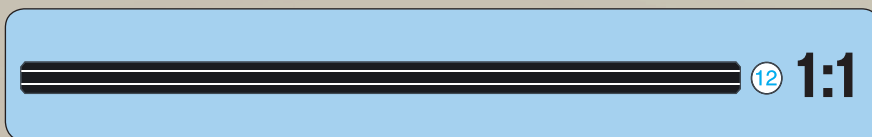
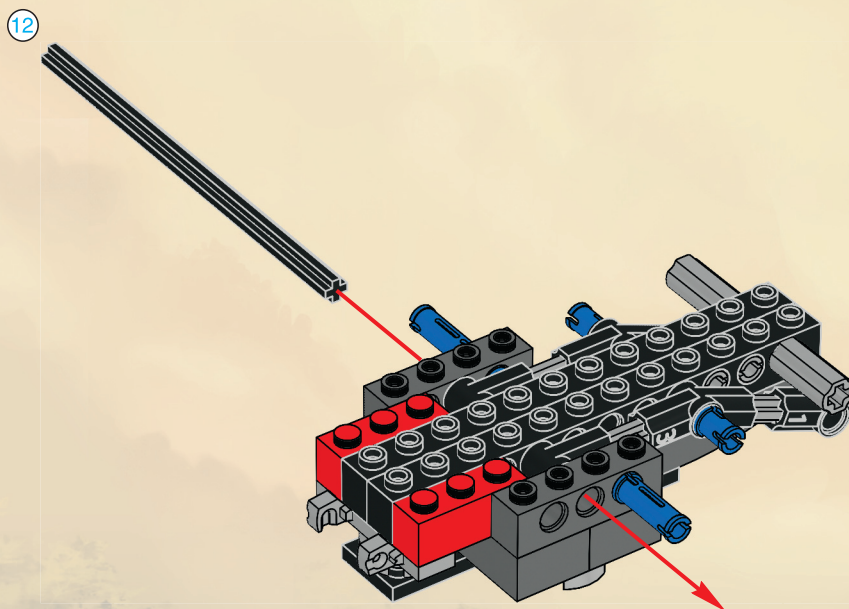

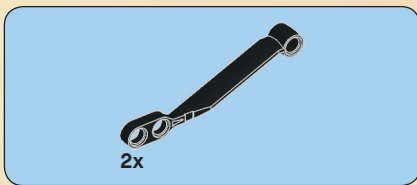

# 14

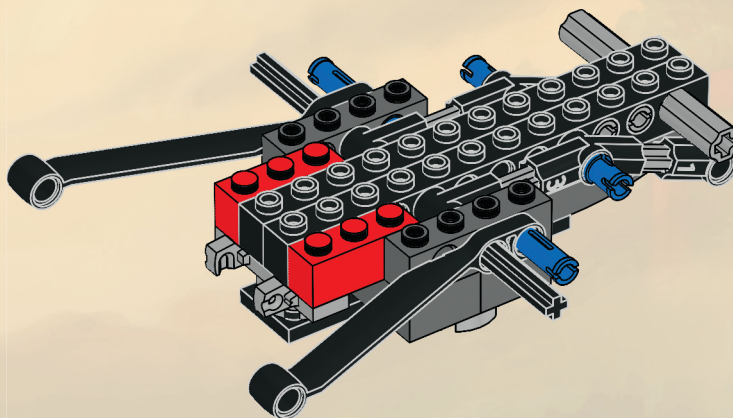

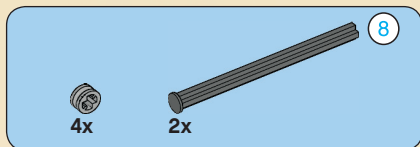

15

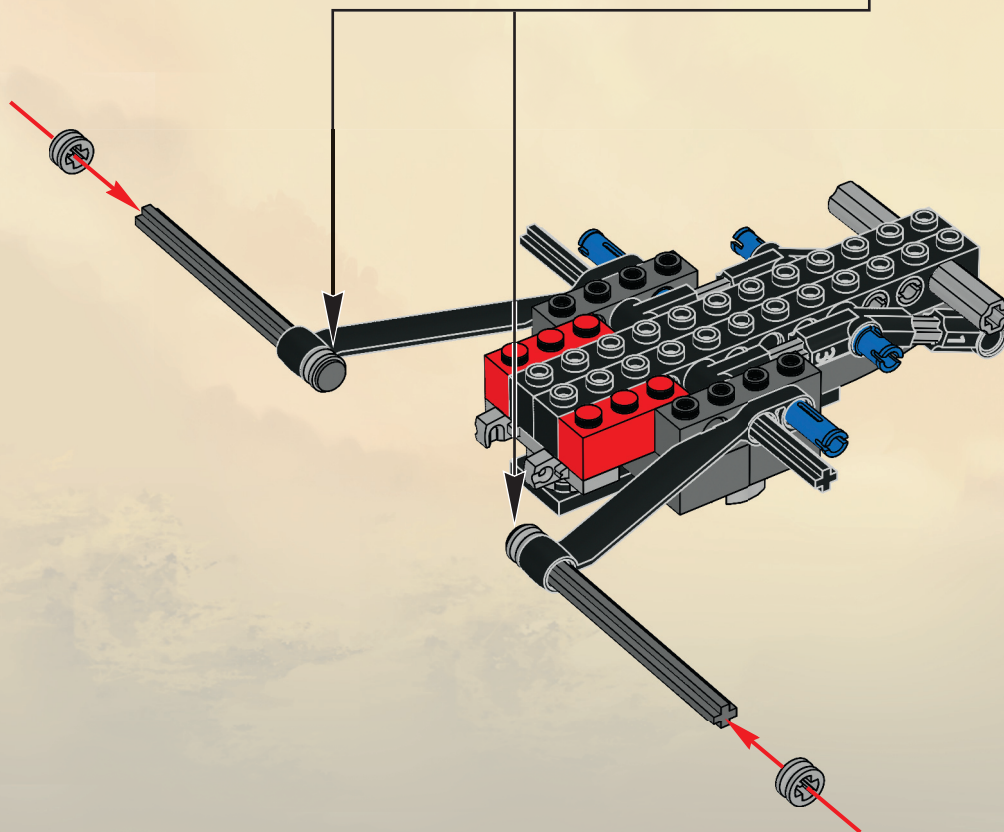
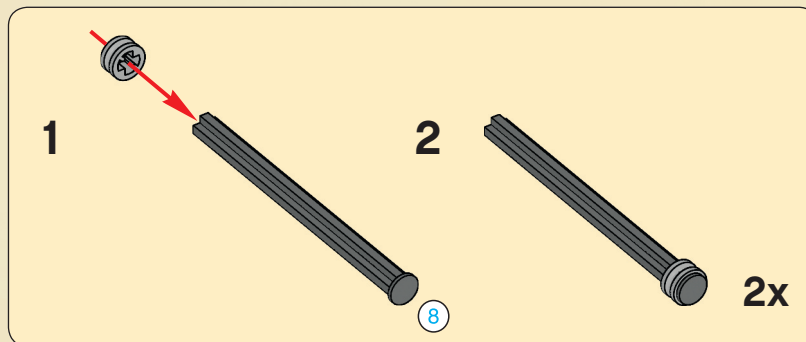



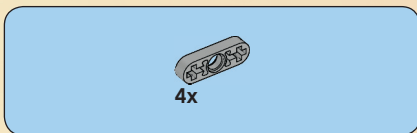

# 16

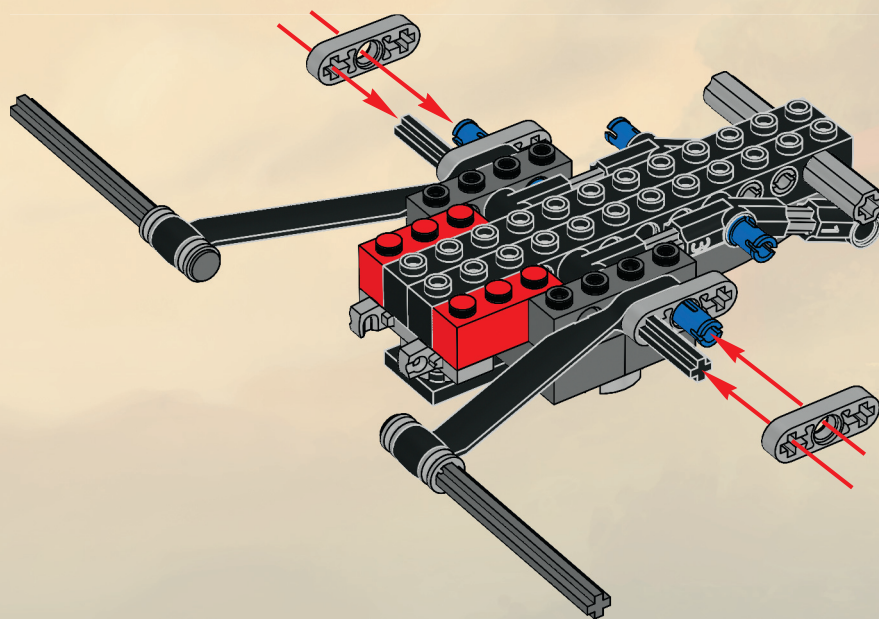

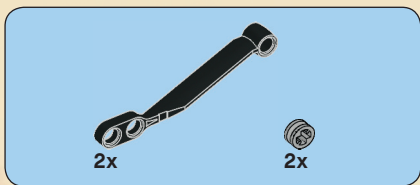

# 17

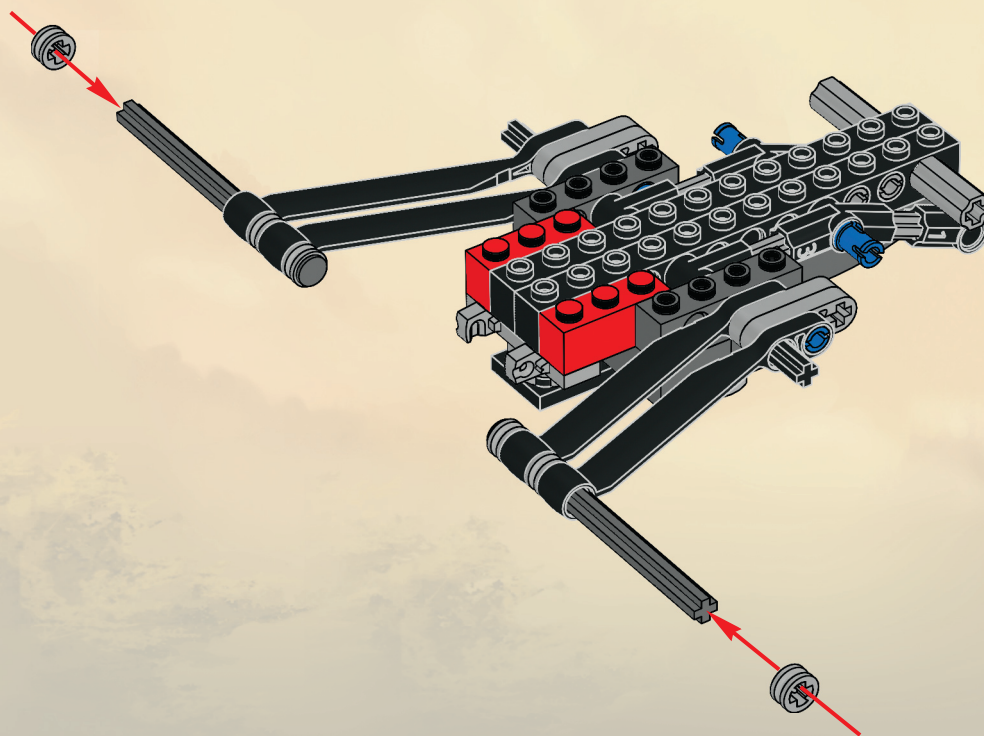

30





18

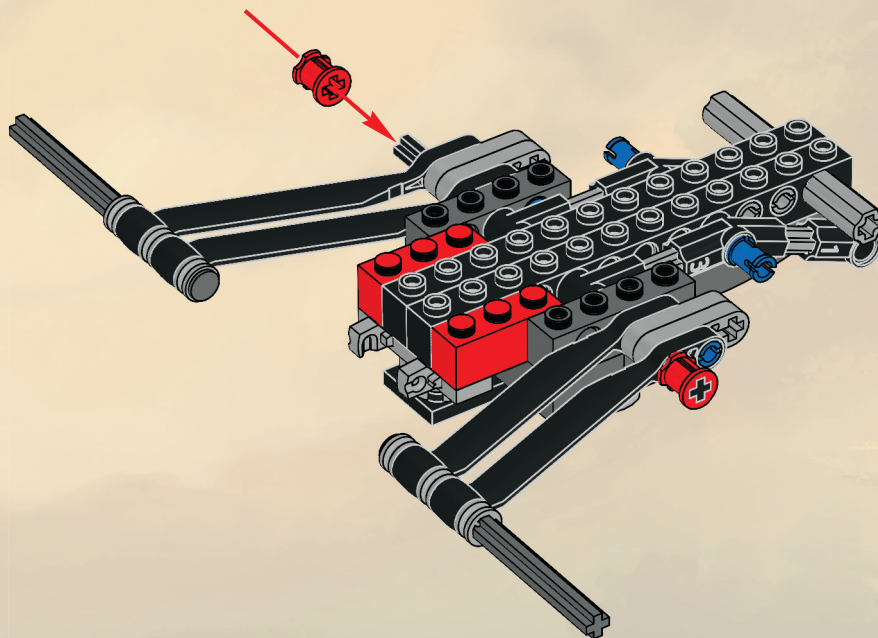



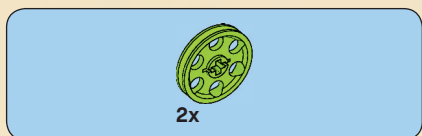

# 19

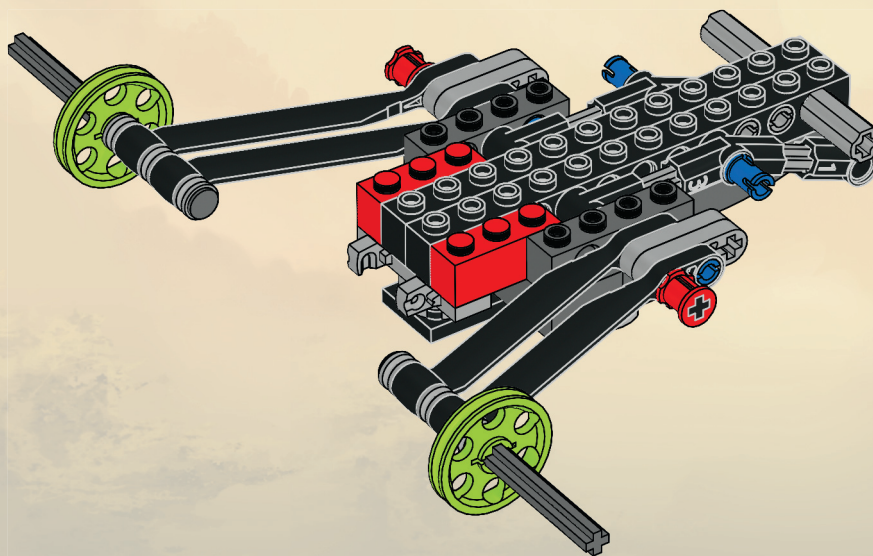

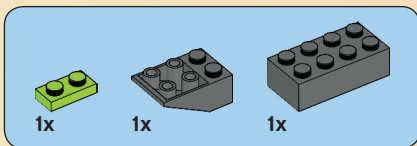

# 20

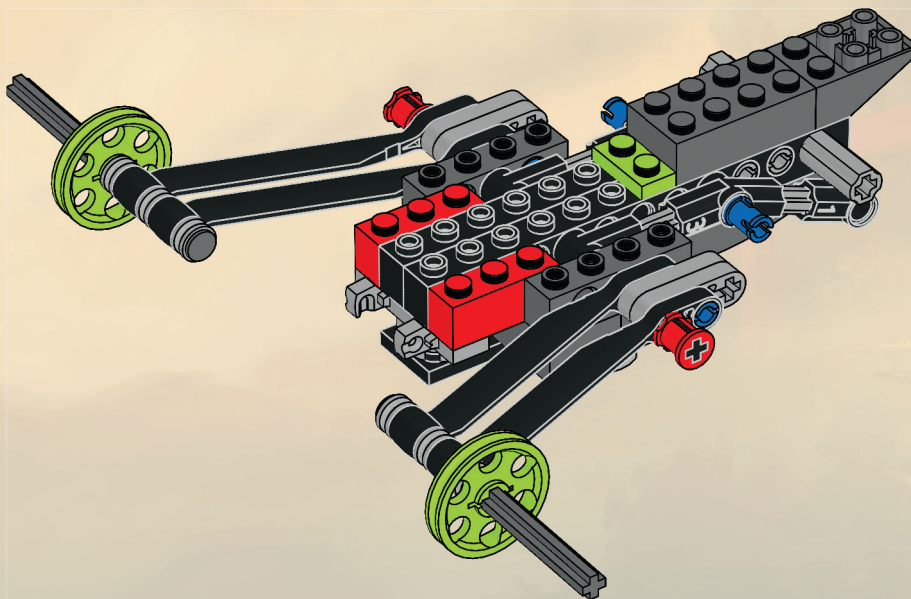

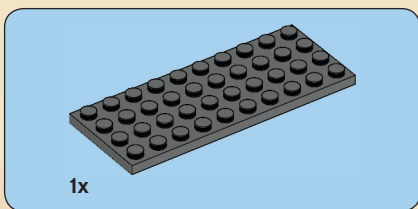

# 21

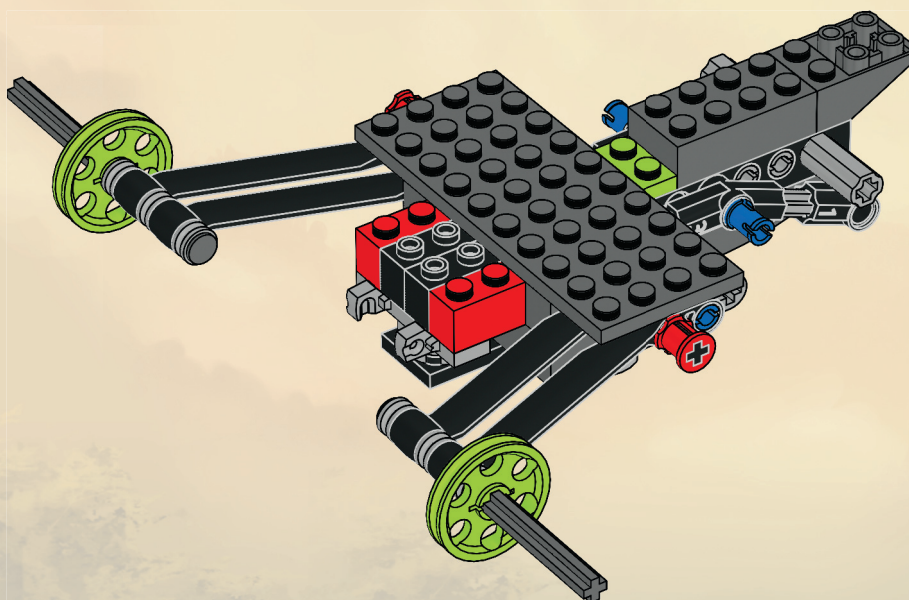



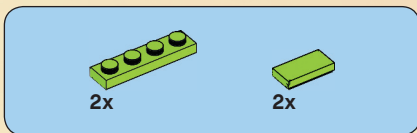

# 22

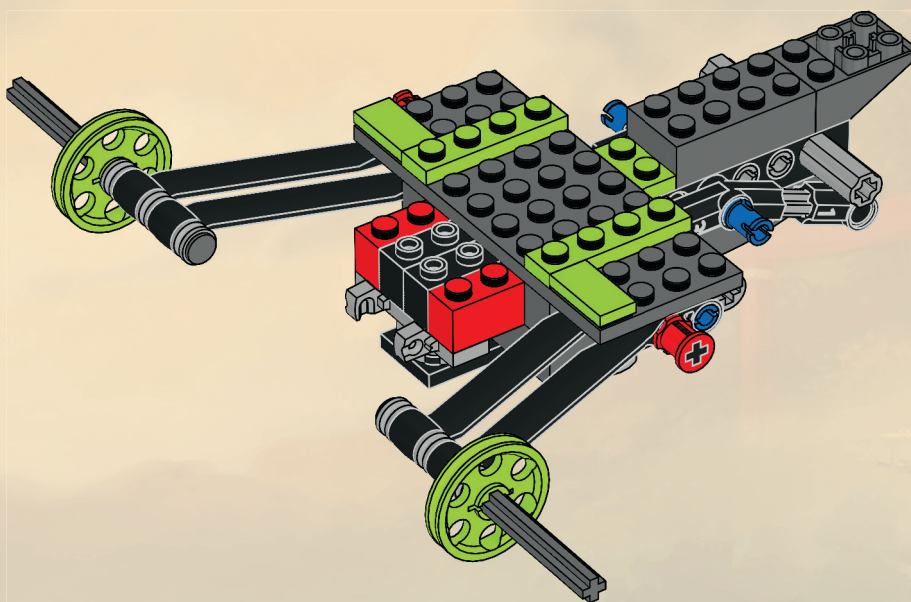

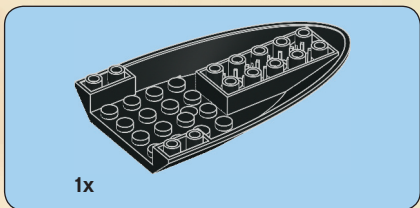
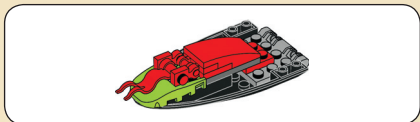

1

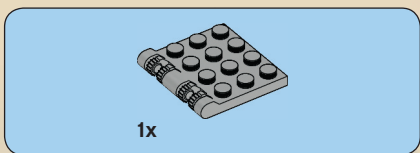
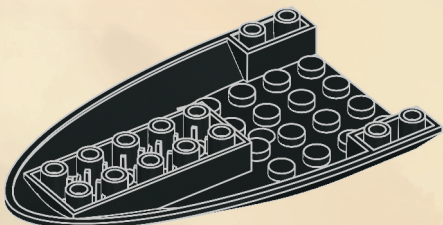

2

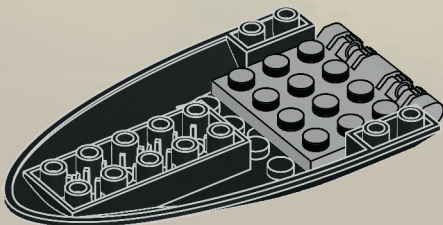

36



3

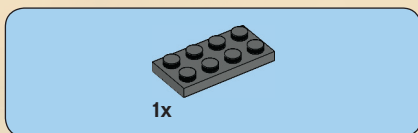
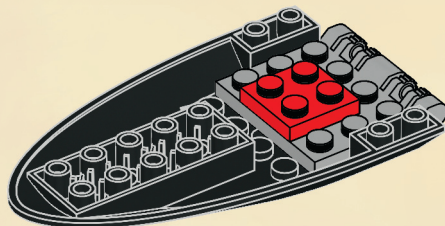

4

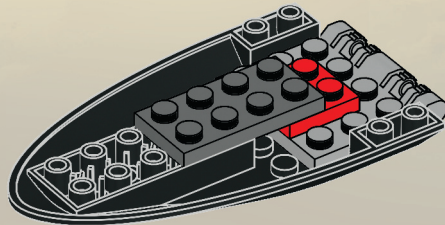



5

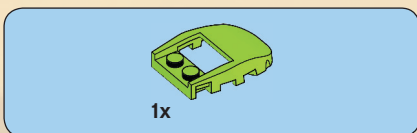
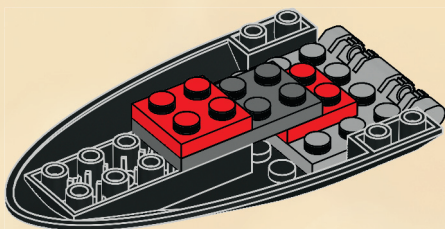

6

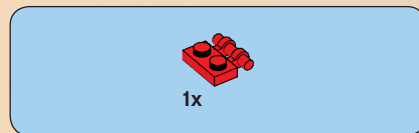
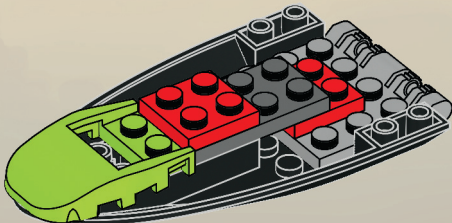

7

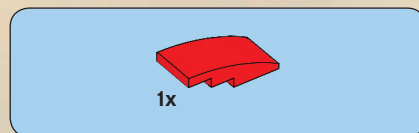
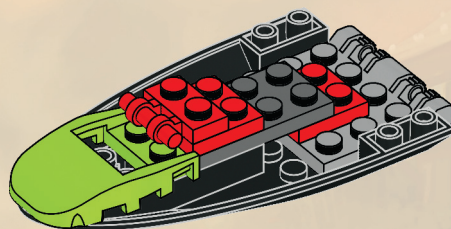

8

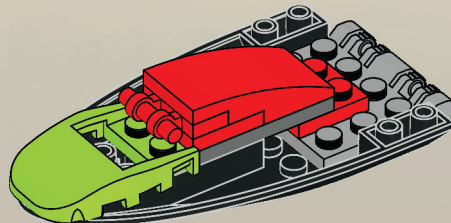



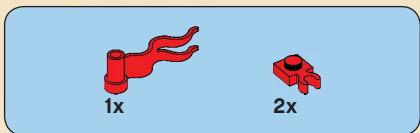

9

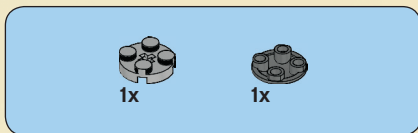
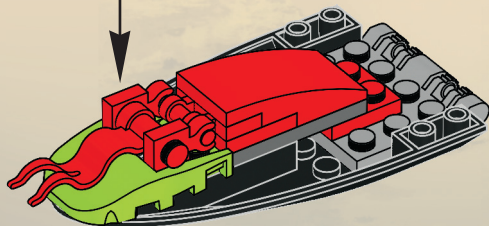
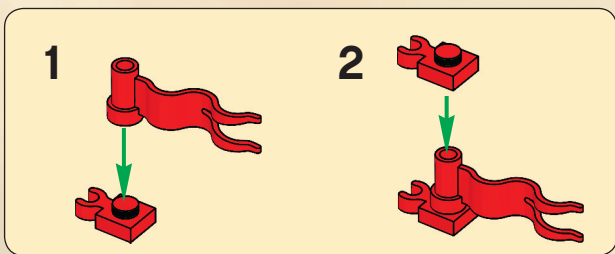

10

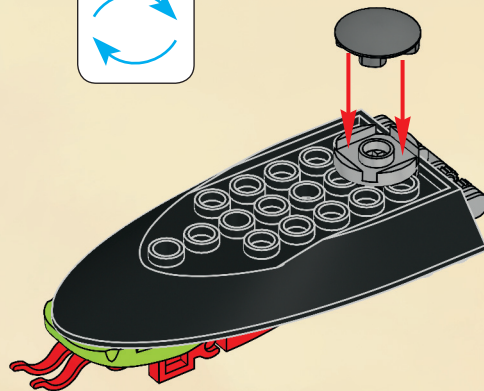
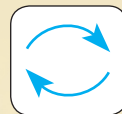

11

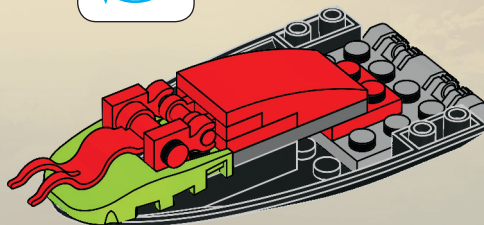
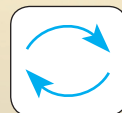



23

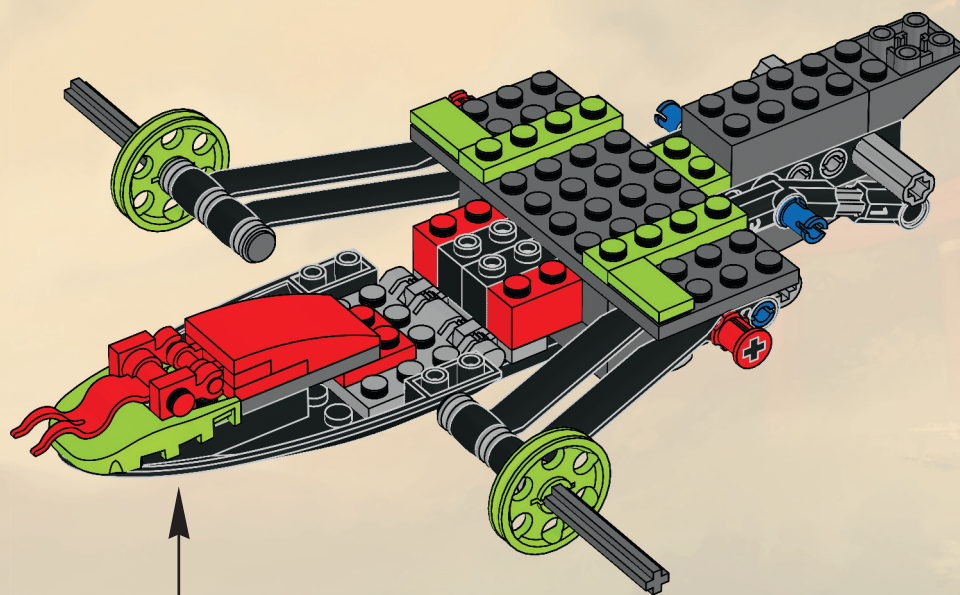

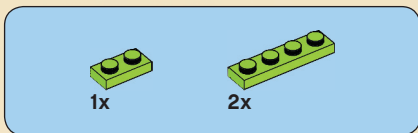

# 24

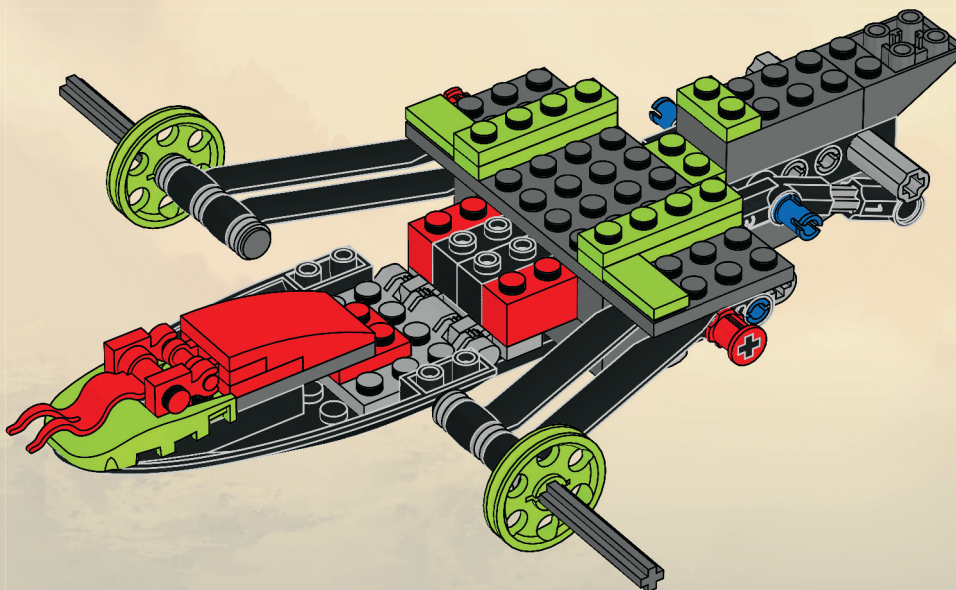



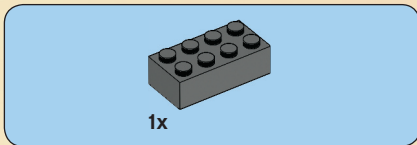

# 25

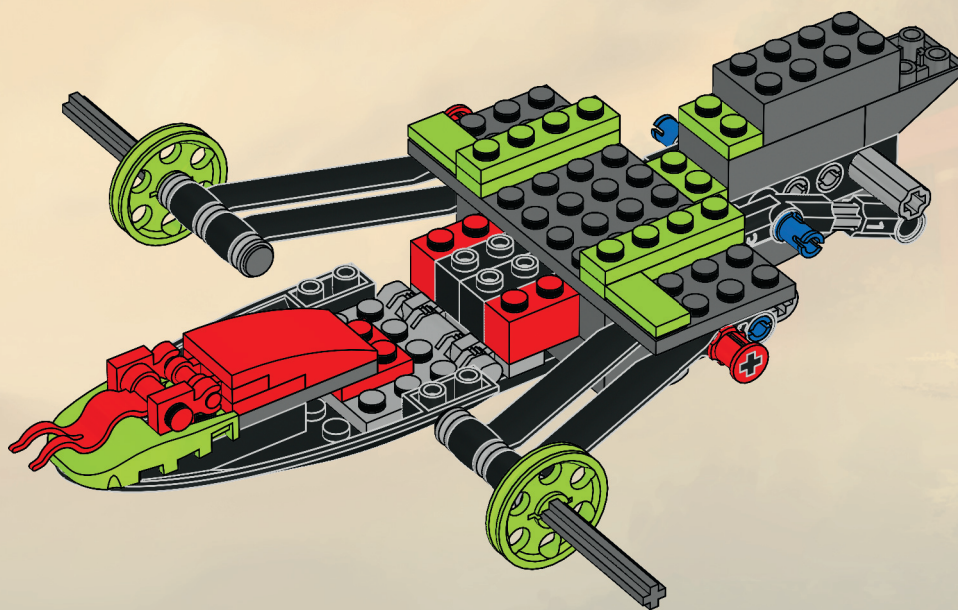

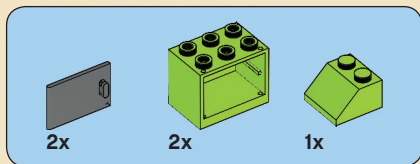

# 26

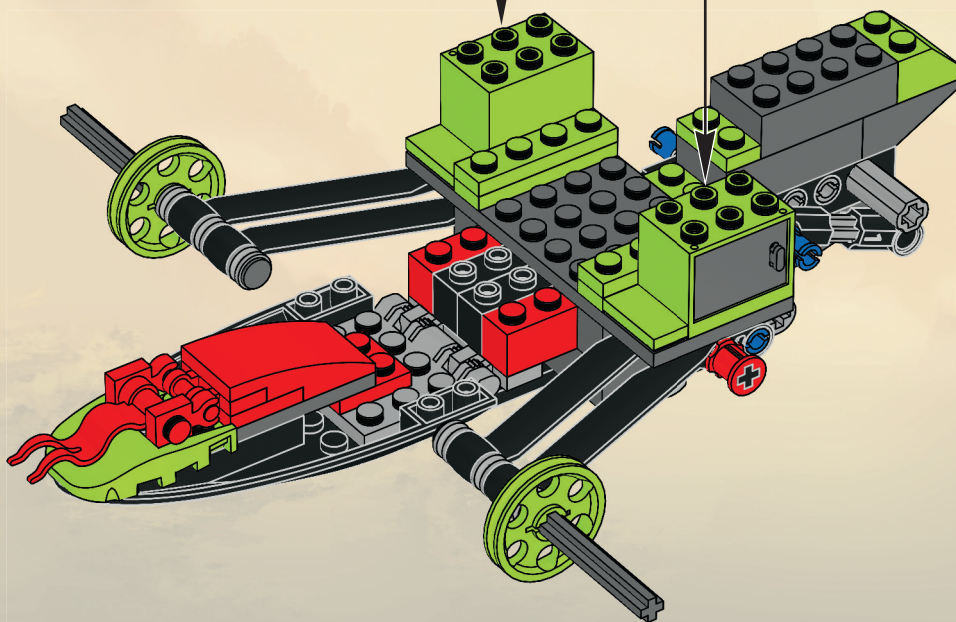
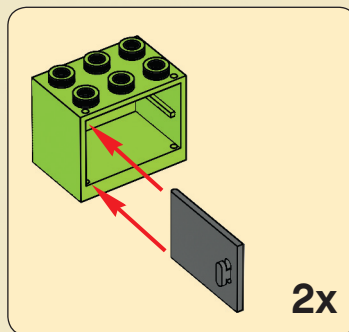

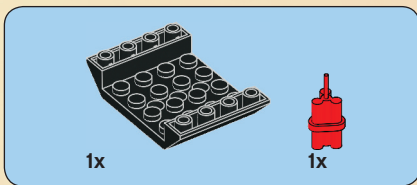

# 27

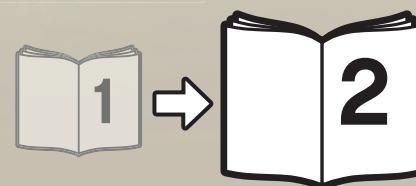
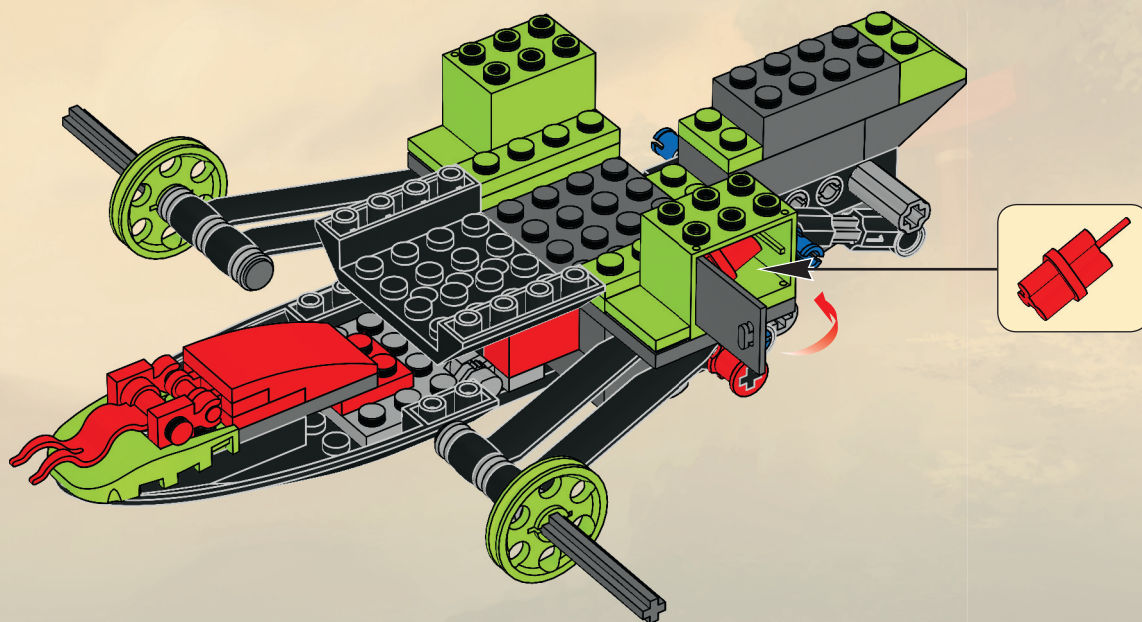



**LEGO club**  
FREE! GRATIS! GRATUIT!



www.LEGOclub.com



LEGO® Club Magazine



LEGO® Club Email

VISIT THE WORLD'S  
BIGGEST LEGO® SHOP!

www.LEGOshop.com

00800 5346 5555

US & Canada only

1-866-534-6258 • 1-877-518-5346

Canada seulement

- \* Freephone. Mobile charges may apply. Numéro sans frais. Des frais peuvent s'appliquer avec les téléphones cellulaires.
- \* Gebührenfrei, Kosten für Anrufe aus Mobilfunknetzen können abweichen.
- \* Gratis telefonnummer vanaf vaste lijn. Det er et gratis nummer, når du ringer fra fasttelefon.
- \* Det är gratis, när du ringer från en fast telefon.
- \* Numéro sans frais. Des frais peuvent s'appliquer avec les téléphones portables.



B115

**YES!** I want to join the LEGO® Club FREE! **OUI!** Je veux m'abonner au LEGO® Club GRATUITEMENT!  
**Ja!** Ich möchte Mitglied im kostenlosen LEGO® Club werden. **Ja!** Ik wil graag GRATIS lid worden van de LEGO® Club.  
**Ja!** Jeg ønsker å melde meg inn i LEGO® Club gratis! **Ja!** Jag vill gå med i LEGO® Club GRATIS!

First name • Prénom  
Vorname • Voornaam  
Fornavn • Förnamn

Last name • Nom de famille  
Name • Achternaam  
Etternavn • Efternamn

Date of Birth • Date de naissance  
Geburtsdag • Geboortedatum  
Födelsedato • Födelsedatum

Boy • Garçon  
Junge • Jongen  
Gutt • Pojk

Girl • Fille  
Mädchen • Meisje  
Jente • Flicka

Street • Adresse  
Straße, Hausnr.  
Straat, huisnr. • Adress

City • Ville  
Ort • Woonplaats  
Poststed • Postort

State  
Prov.  
County

Zip/Postcode  
Code Postal • PLZ  
Postcode  
Postnummer

Country  
Pays  
Land

Email • Courriel  
E-Mail • E-post

- Fill in your email address and we will send you a membership confirmation and monthly email newsletters. If you do not wish to receive the newsletters please tick here. Remplis ton adresse e-mail et nous t'enverrons une confirmation d'adhésion ainsi que le bulletin e-mail mensuel. Si tu ne désires pas recevoir le bulletin, coche cette case. Vul je e-mailadres in en we sturen je een bevestiging van je lidmaatschap en maandelijkse e-mail nieuwsbrieven. Als je geen e-mail wilt ontvangen, kruis dan dit vakje aan.
- Ich möchte per E-Mail den monatlichen LEGO Club Newsletter erhalten. Ønsker du at vi skal sende en liten hilsen til barnet ditt for å bekrefte medlemskapet, ber vi deg krysse av i feltet, samt oppgi e-postadressen som hilsenen skal sendes til. Om du vill att vi ska skicka en bekräftelse på ditt barns medlemskap, ber vi dig sätta ett kryss i rutan och skriva den e-post adress som bekräftelsen ska skickas till.
- If you do not wish to receive additional mailings from the LEGO Club please tick here. Si tu ne désires pas recevoir de courrier supplémentaire du Club LEGO, coche cette case. Als je geen verdere post van de LEGO Club wilt ontvangen, kruis dan dit vakje aan.
- Dersom du ønsker å motta annen informasjon fra LEGO Gruppen, setter du et kryss her.

Mail to: / Poster à: LEGO® Club  
P.O. Box 1157  
Enfield, CT USA  
06083-1157

Per Post an: LEGO® Club  
Postfach 14 15  
D-36243 Niederaula

Send til: LEGO® Club Norge  
Postboks 58  
1314 Vøyenenga

Mail to: LEGO® Club  
33 Bath Road  
Slough SL1 3UF  
United Kingdom

Stuur op naar: LEGO® Club  
Postbus 40250  
3504 AB Utrecht

Skickas till: LEGO® Club Sverige  
Ubox 841  
202 29 Malmö

Poster à: LEGO® Club  
21 rue de la banque  
75 002 PARIS  
FRANCE

**EN** The English language version of the magazine can only be mailed to addresses in the US, Canada, the UK, and Republic of Ireland. Club membership is valid for two years and includes free copies of the LEGO Club Magazine and e-mail newsletters. In the US and Canada please allow up to 6 weeks for delivery of your first magazine. In the UK and Republic of Ireland please allow six to 14 weeks for delivery of your first magazine. By signing this form you consent the LEGO Club to use your child's data for LEGO mailings. The data will only be used for LEGO mailings and will not be sold, rented or otherwise disclosed to any company outside the LEGO Company except for disclosure to companies acting as our agents to help us provide services requested by the child. This coupon is valid for one free membership per person, group or organization. Photocopied coupons are accepted. **FR** La version française du magazine peut être émise uniquement au Canada. L'abonnement est valide pour 2 ans et inclut des exemplaires gratuits du Magazine LEGO. Aux É.-U. et au Canada, allouer 6 semaines pour la livraison initiale. En remplissant ce formulaire, vous consentez à ce que LEGO utilise les informations de votre enfant pour des envois postaux de LEGO. L'information sera utilisée uniquement pour des envois postaux par LEGO et ne sera en aucun cas, vendue, louée, échangée ou divulguée à d'autres compagnies autres que la compagnie LEGO, à l'exception des compagnies affiliées qui nous procurent des services auxquels l'enfant en a fait la demande. Formulaires photocopiés acceptés. **DE** Mit der folgenden Unterschrift erkläre ich, für mein Kind den Beitritt als Mitglied zum kostenlosen LEGO Club, der von der LEGO GmbH, D-85627 Grasbrunn, betrieben wird. Die Mitgliedschaft beinhaltet die Zusendung des LEGO Club Magazins und kann beiderseits jederzeit beendet werden. Mit der Mitgliedschaft im LEGO Club sind keinerlei Verpflichtungen verbunden. Das deutschsprachige LEGO Club Magazin wird nur an Adressen in Deutschland, Österreich und der Schweiz versendet. Eine Anmeldebestätigung kann nur per E-Mail geschickt werden. Das Magazin erscheint fünfmal jährlich. Daher kann die Zustellung des ersten Heftes bis zu drei Monate dauern. Die Mitgliedschaft ist beiderseitig jederzeit kündbar, ohne dass Ihnen Kosten entstehen. Sie können der werblichen Nutzung Ihrer Daten jederzeit widersprechen, Kündigung und Widerspruch können Sie telefonisch erklären (00800 / 5346 5555, Anruf gebührenfrei, Kosten für Anrufe aus dem Mobilfunknetz können abweichen) oder an die LEGO GmbH senden. **NL** Het Nederlandse LEGO Club Magazine kan alleen worden gestuurd naar adressen in Nederland. Het lidmaatschap is 2 jaar geldig en geeft recht op toezending van het gratis LEGO Club Magazine en LEGO Club e-mails. Het eerste magazine zal binnen 12 tot 14 weken toegestuurd worden. Het lidmaatschap kan op ieder moment opgezegd worden en kan na 2 jaar gratis worden verlengd, tenzij LEGO met deze activiteit stopt. Uw gegevens worden uitsluitend gebruikt voor mailings van LEGO en zullen niet worden verkocht, verhuurd of op welke wijze dan ook verstrekt aan derden buiten de LEGO Group, uitgezonderd de organisaties die namens ons optreden om de informatie te sturen waarvoor toestemming is verleend. **NO** Den norske utgaven av magasinet sendes kun til adresser i Norge. Medlemskap i klubben gjelder i 2 år og inkluderer gratisutgaver av LEGO Club Magazine. Påregnet minimum opp til seks uker leveringstid for første magasin. Ved å undertegne dette skjemaet, gir du ditt samtykke til at LEGO Club kan bruke opplysningene om barnet ditt i LEGO forendelser. Dataene vil utelukkende bli brukt i LEGO forendelser og vil ikke bli solgt, utleid eller på annen måte gjort tilgjengelig for selskaper utenfor LEGO gruppen, unntatt selskaper som er våre agenter og som hjelper oss å tilby tjenestene barnet ettertar. Dette skjemaet gjelder for ett gratis medlemskap per person, gruppe eller organisasjon. **SE** Den svenska versionen av tidningen kan endast skickas till adresser i Sverige. Club-medlemskapet är giltigt i 2 år och innefattar gratis exemplar av LEGO Club Magazine. Villigen räkna med minimum 6 veckor för leverans av din första tidning. Genom att skicka in det här formuläret godkänner du att LEGO Club använder barnets uppgifter för LEGO utskick. Uppgifterna kommer bara att användas för LEGO utskick och kommer inte att säljas, hyras ut eller vidarebefordras till något företag som inte tillhör LEGO Gruppen, med undantag av företag som agerar som våra ombud för att tillhandahålla tjänster som barnet har begärt. Den här kupongen gäller för ett gratis medlemskap per person, grupp eller organisation. **FR** En complétant ce bulletin d'adhésion, vous acceptez que LEGO Club utilise les données relatives à votre enfant pour l'envoi de courriers concernant LEGO. Ces données seront uniquement utilisées pour l'envoi d'information concernant LEGO et ne seront ni vendues, ni louées, ni utilisées par d'autres sociétés que le groupe LEGO, à l'exception des sociétés agissant pour le compte de LEGO en tant que sous-traitant de services divers. L'abonnement au LEGO Club est valable pour une période de 2 ans. Il inclut l'envoi par courrier du magazine LEGO Club et par email des newsletters. Un délai de 6 à 14 semaines est à prévoir pour la réception de votre premier magazine. Ce bulletin d'adhésion gratuit est valable pour l'inscription d'une seule personne. Les photocopies sont acceptées. ATTENTION! Le bulletin d'adhésion doit être rempli et signé par un parent ou un tuteur.

Parent's signature • Signature d'un parent ou d'un tuteur •  
Unterschrift Erziehungsberechtigte/r • Handtekening ouders •  
Foreldres/foresattes underskrift • Föräldras/förmyndares underskrift

Date  
Datum  
Dato

LEGO and the LEGO logo are trademarks of the LEGO Group. ©2012 The LEGO Group. 6002056



# NINJAGO

Masters of Spinjitzu



9445



**FANGDAM INCLUDED**





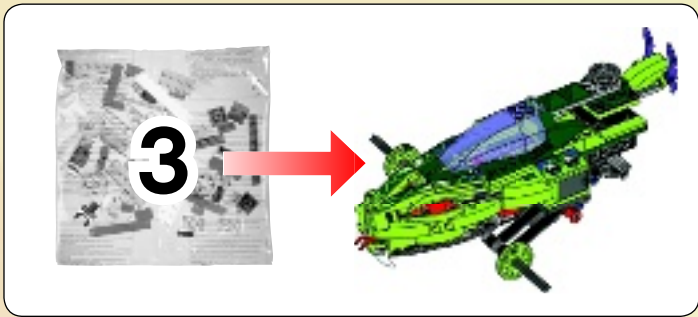

FANGDAM INCLUDED  
ENTHÄLT FANGDAM  
FANGDAM INCLUS  
INCLUYE A FANGDAM  
INLUI FANGDAM  
FANGDAM A DOBOZBAN

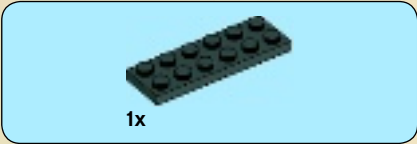

1



2



3

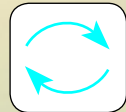





4



5



6

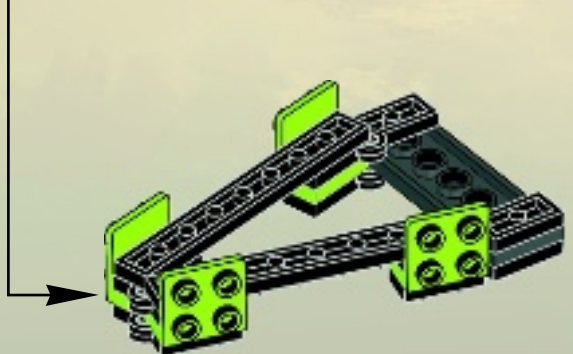
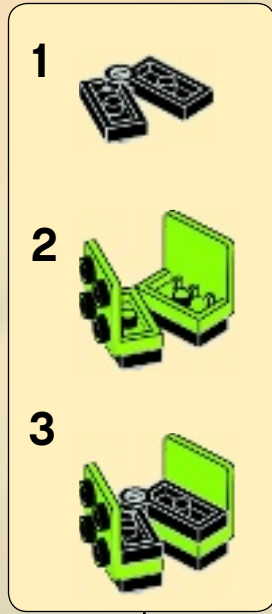



4x

7

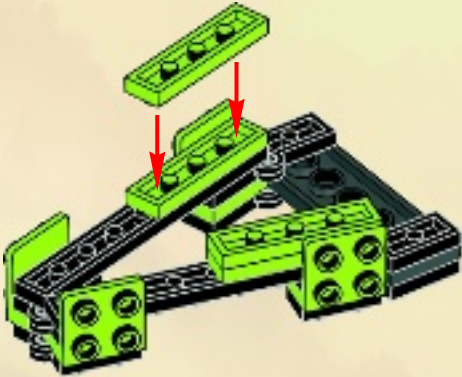

2x

8



2x



2x

9



2x

10

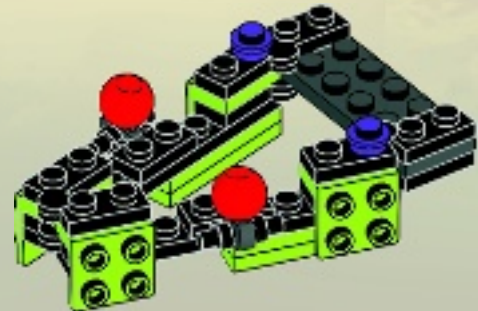



# 11

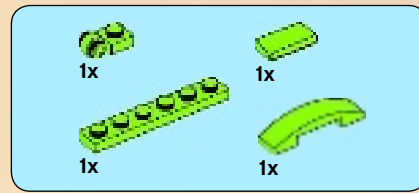

# 12

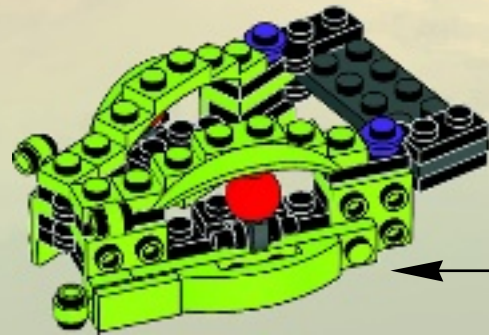
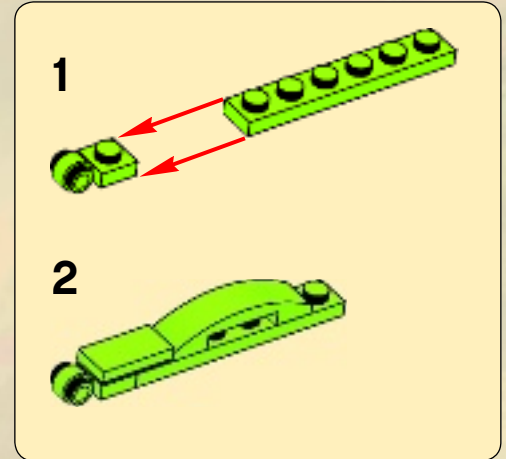



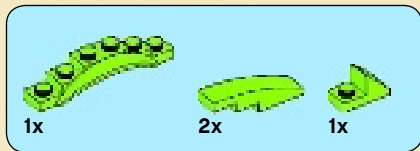

# 13

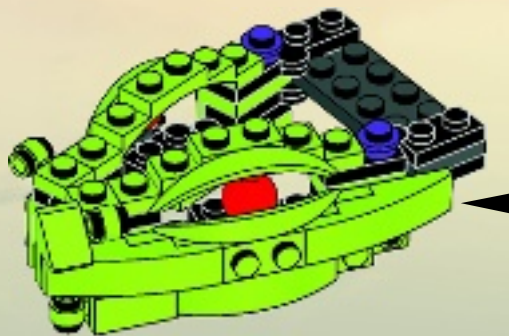
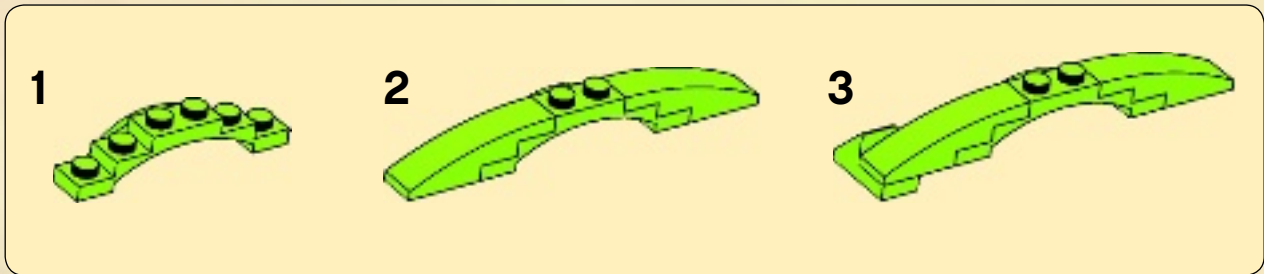

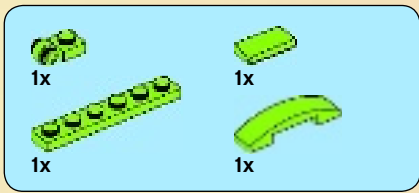

# 14

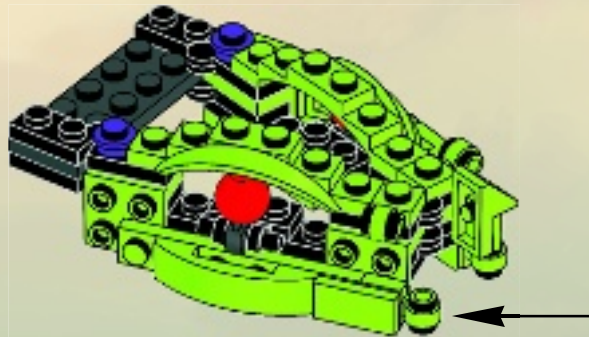
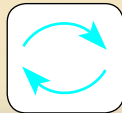
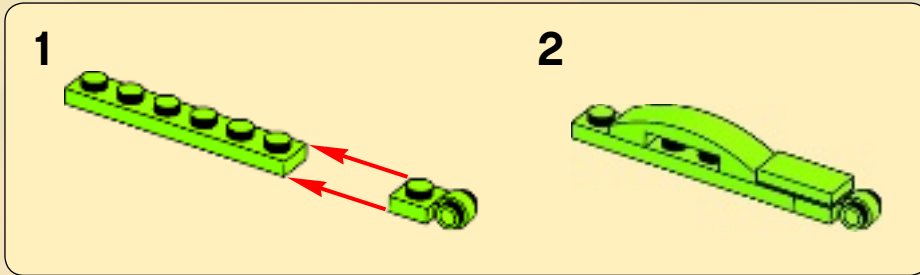

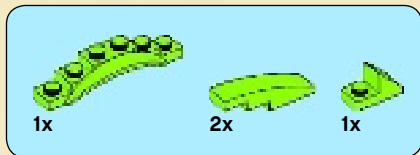

# 15

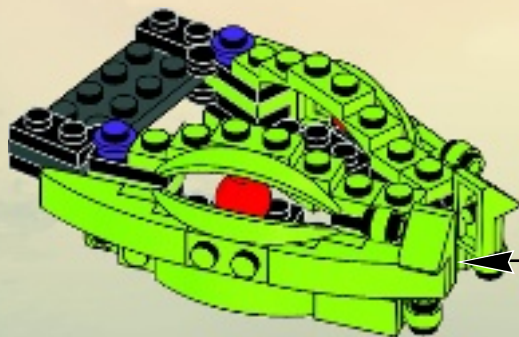
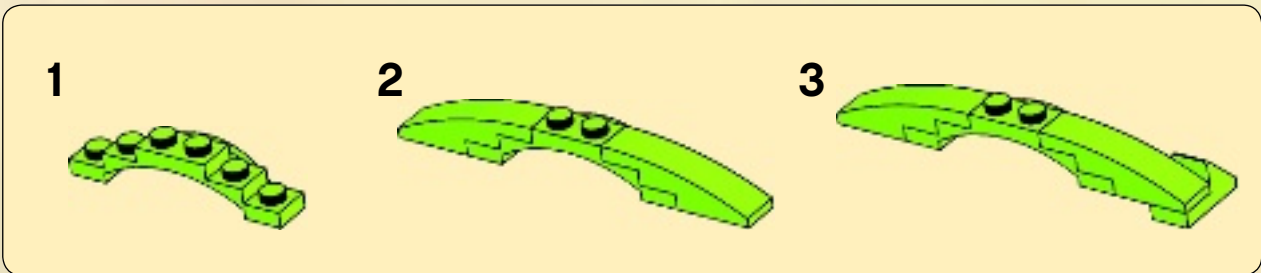





2x

# 16

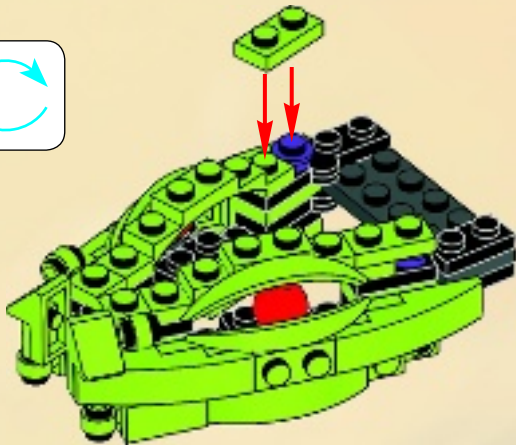

2x



2x

# 17

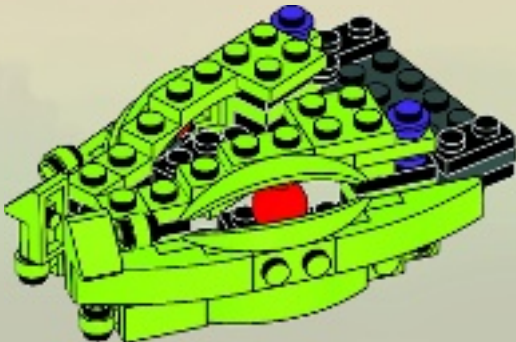

2x

# 18

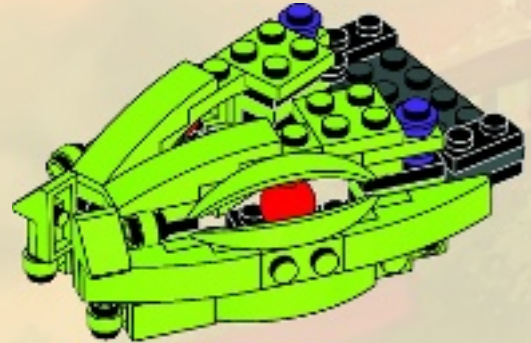

2x

# 19

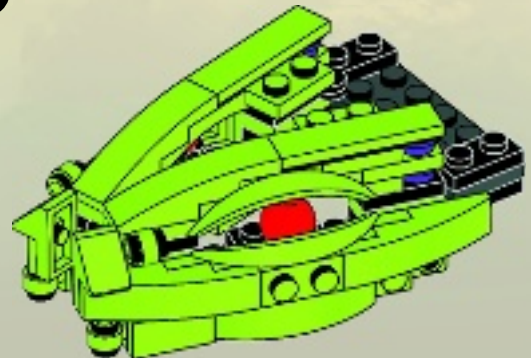

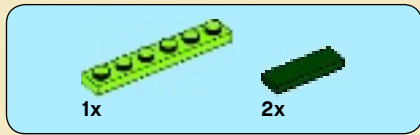

20

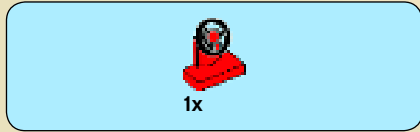
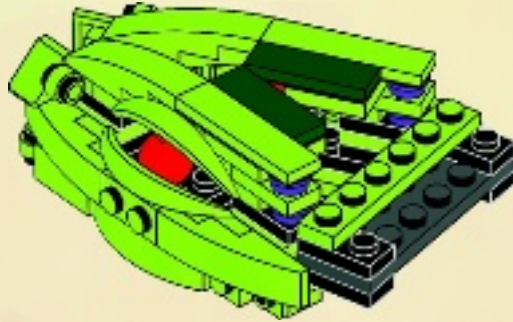

21

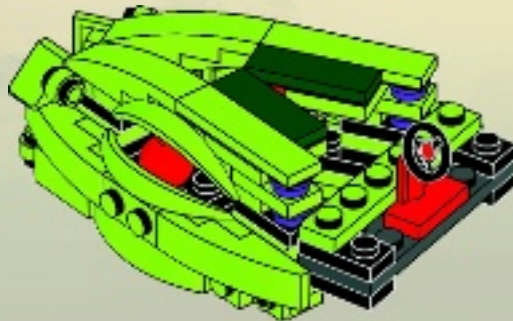



22

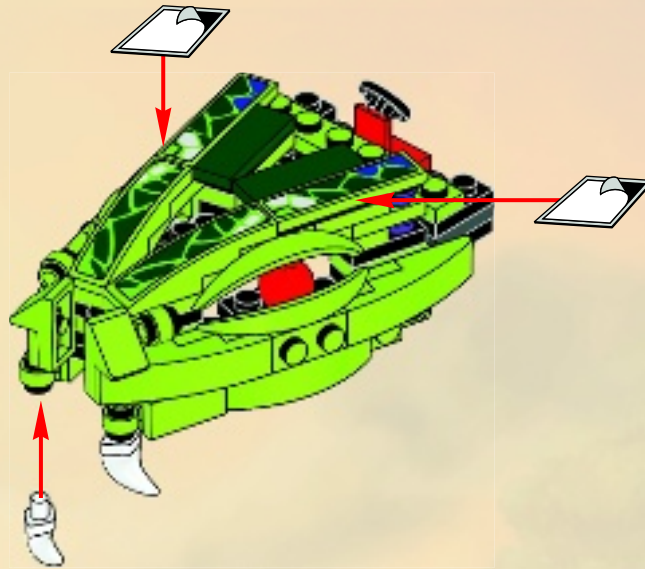

23

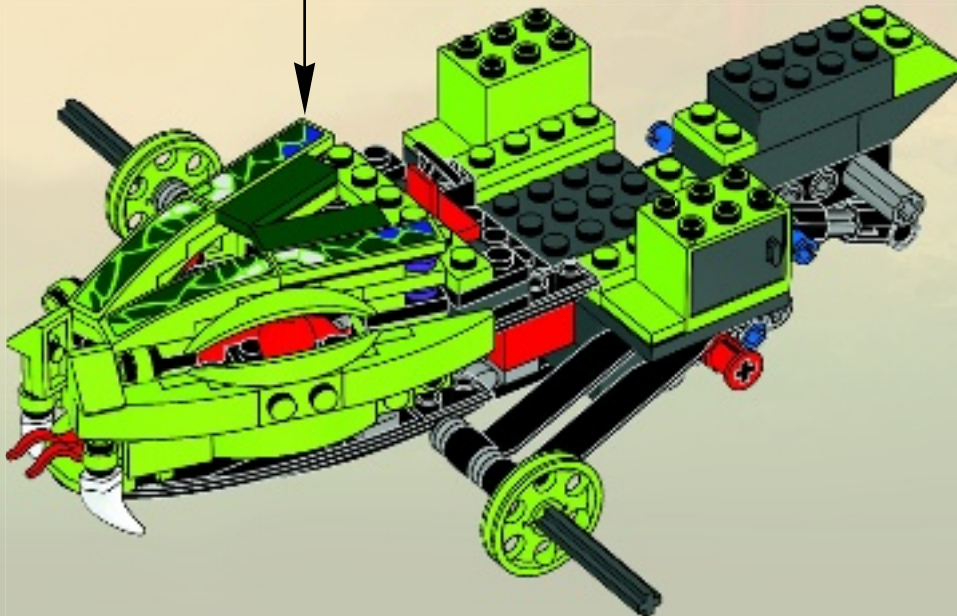



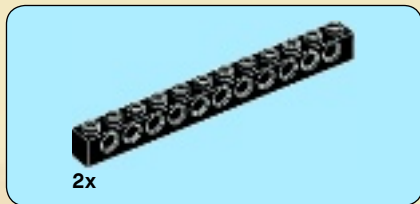

24





2x

# 25

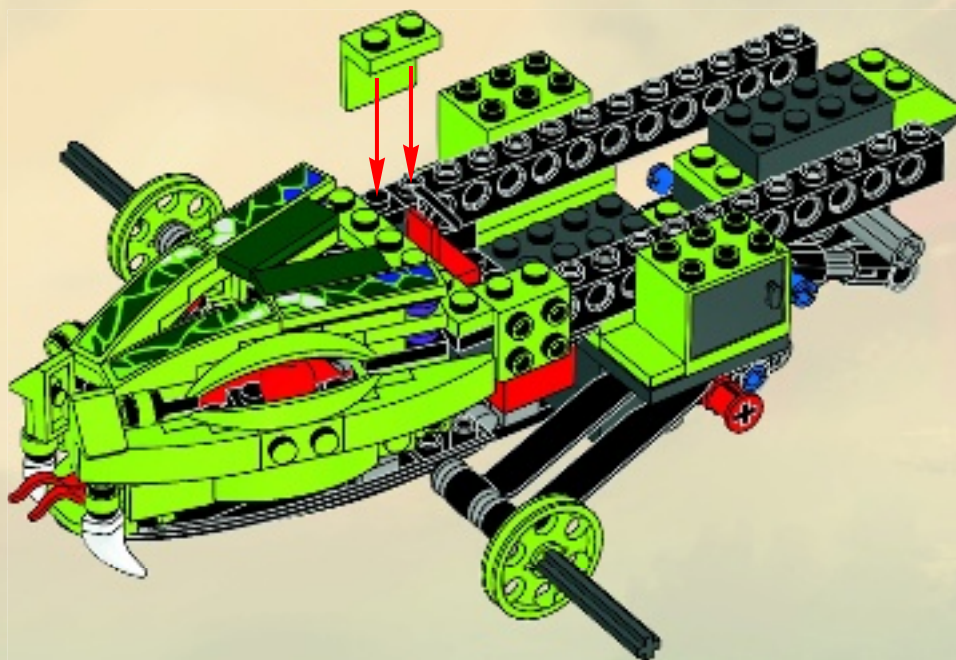

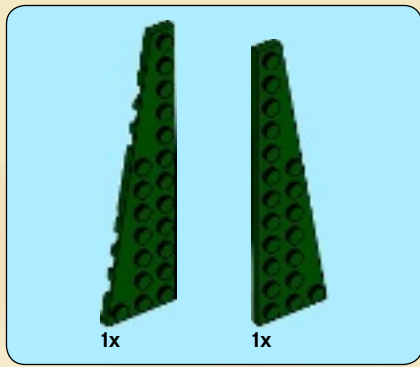

26

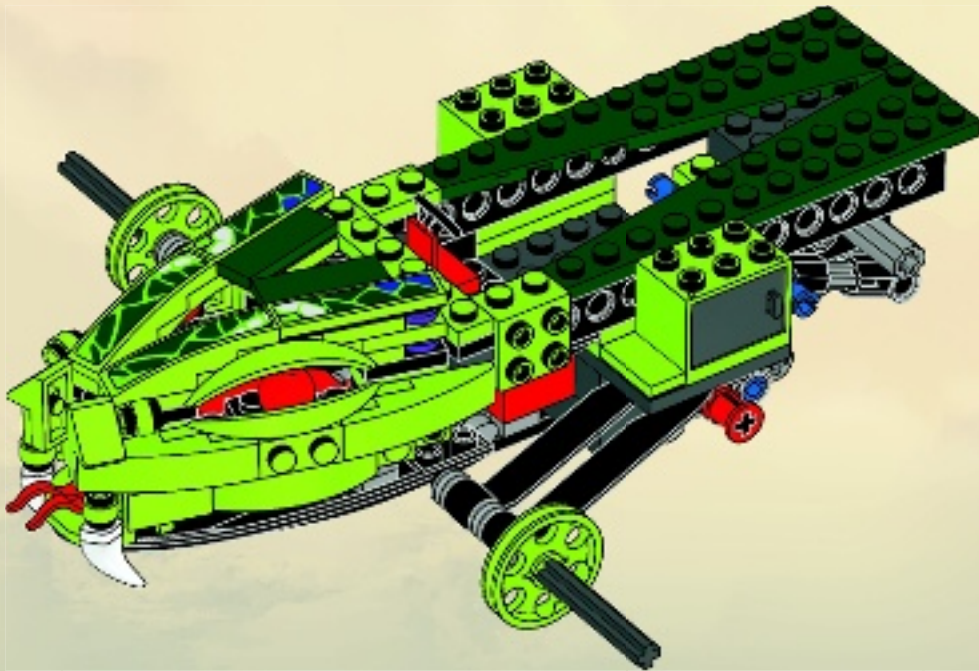





4x

# 27

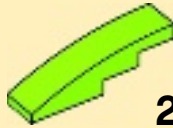

2x

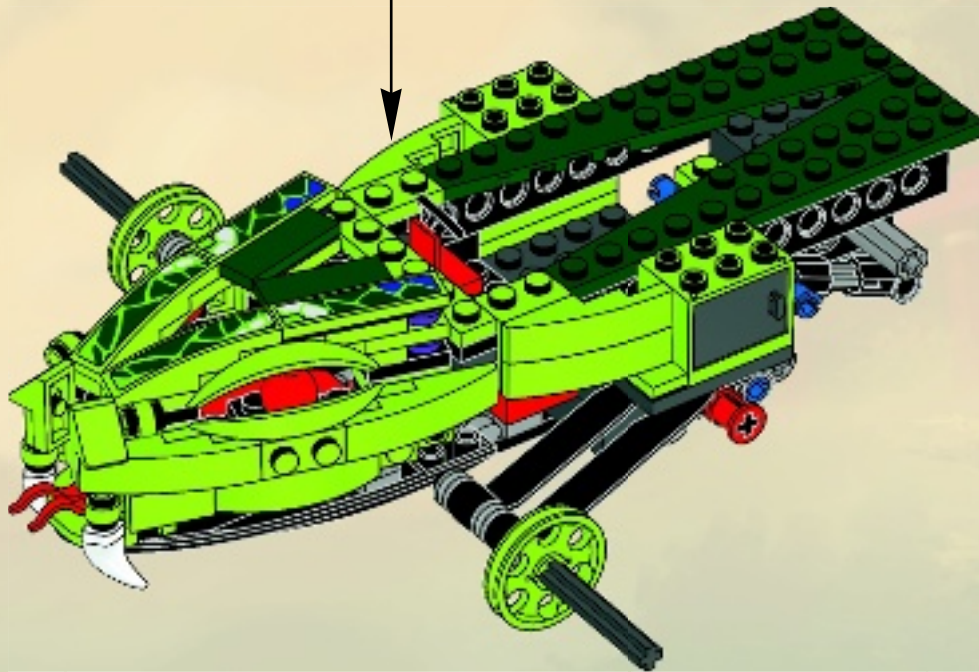



4x

28

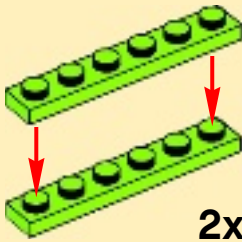

2x

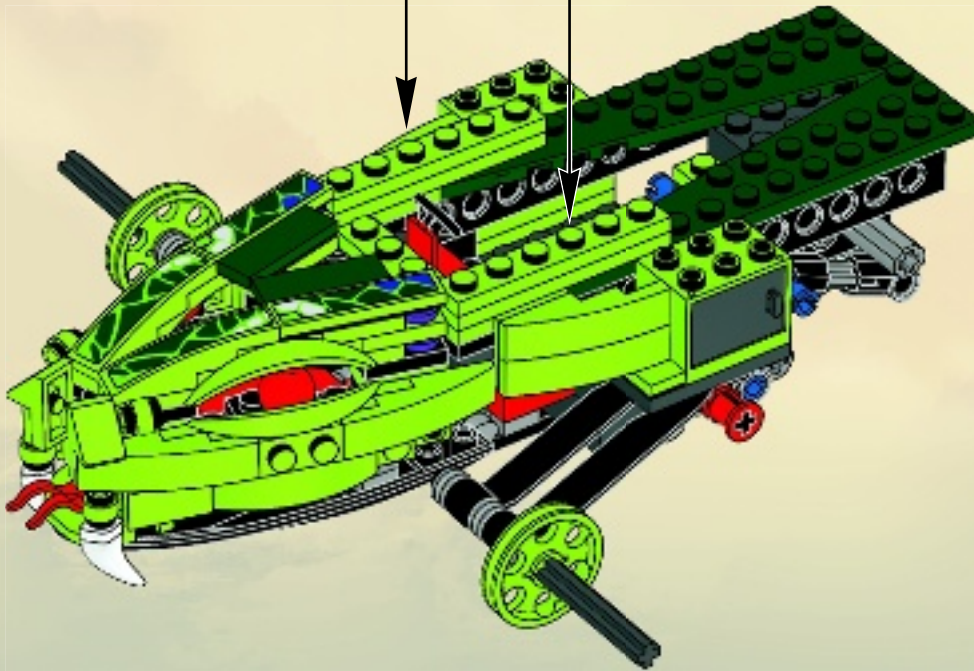



3x

# 29

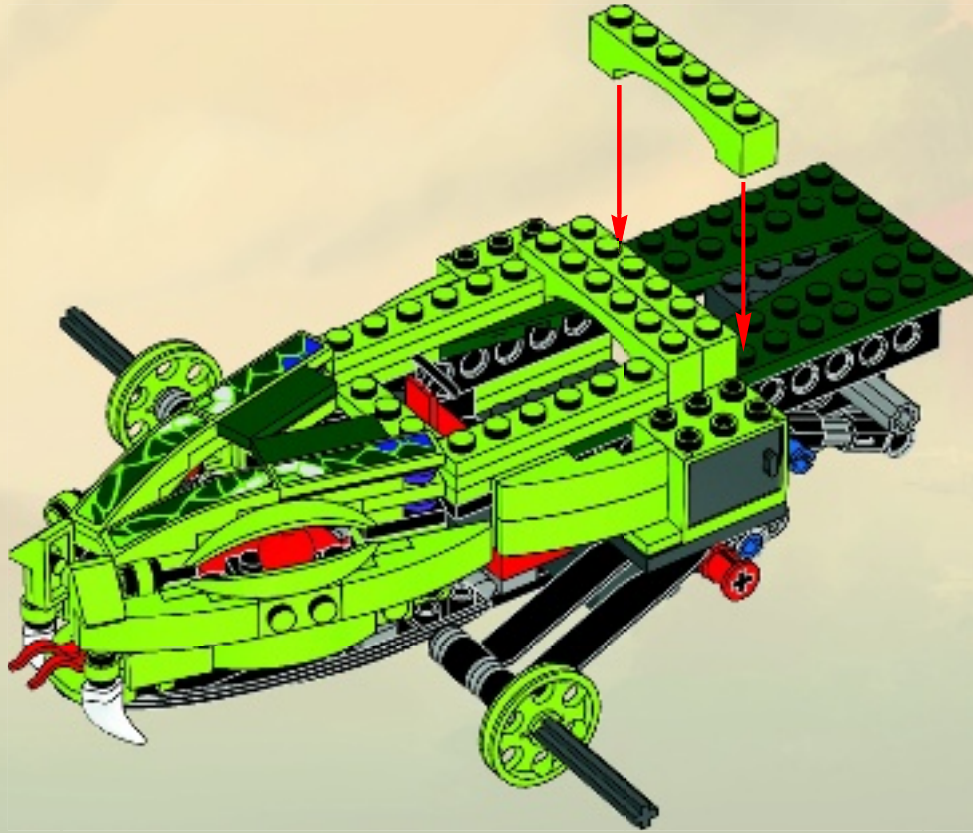





30

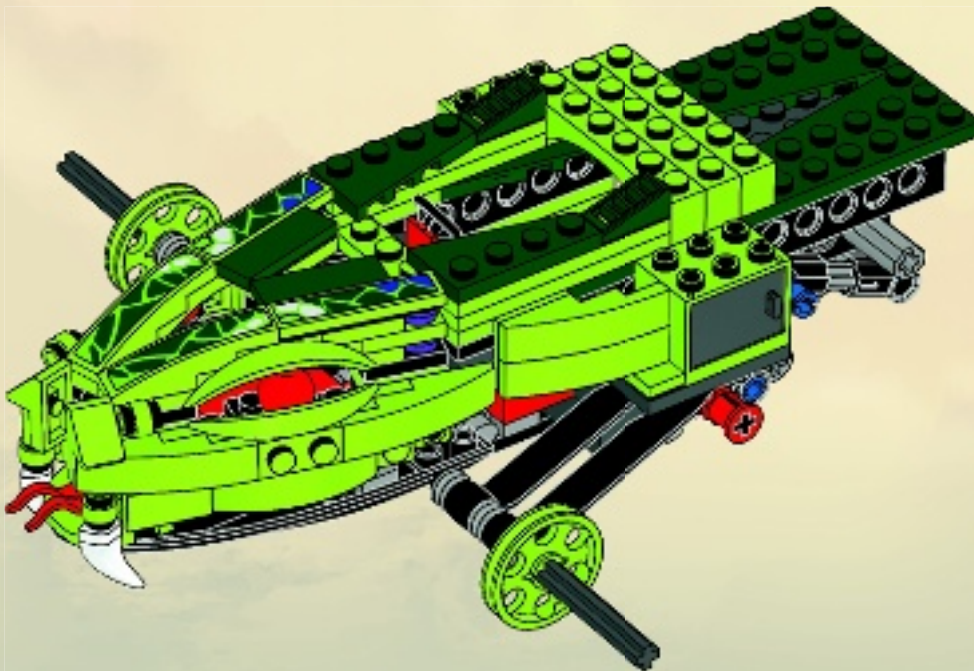

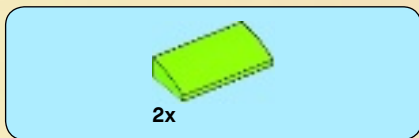

# 31

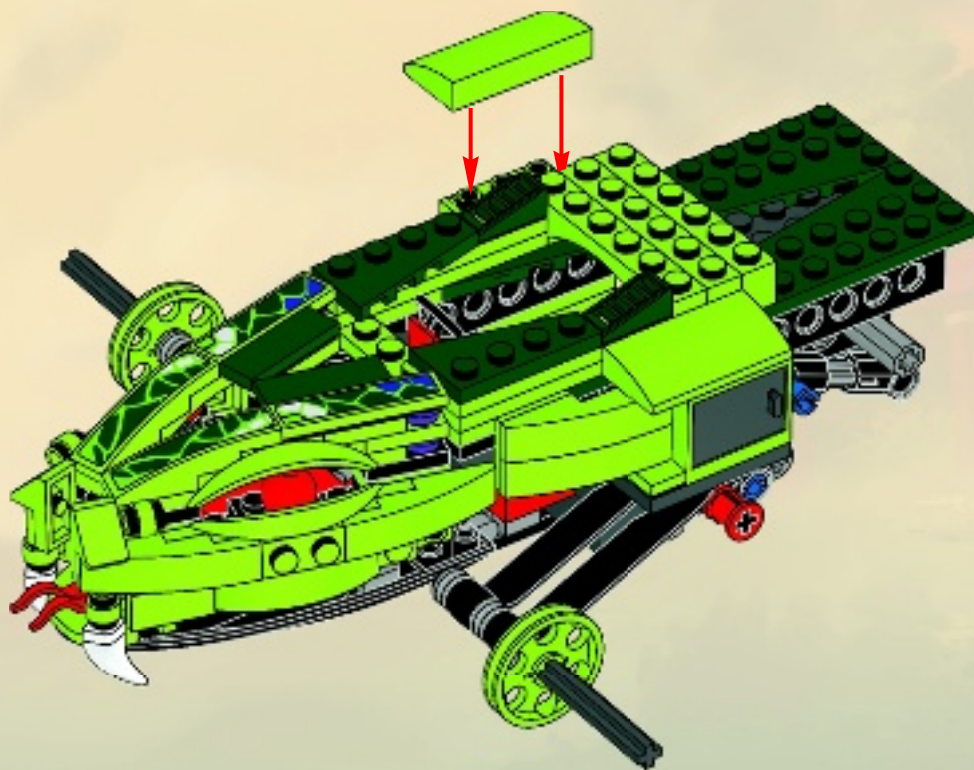

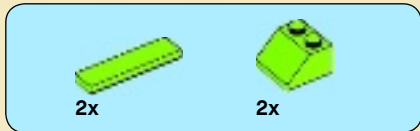

# 32

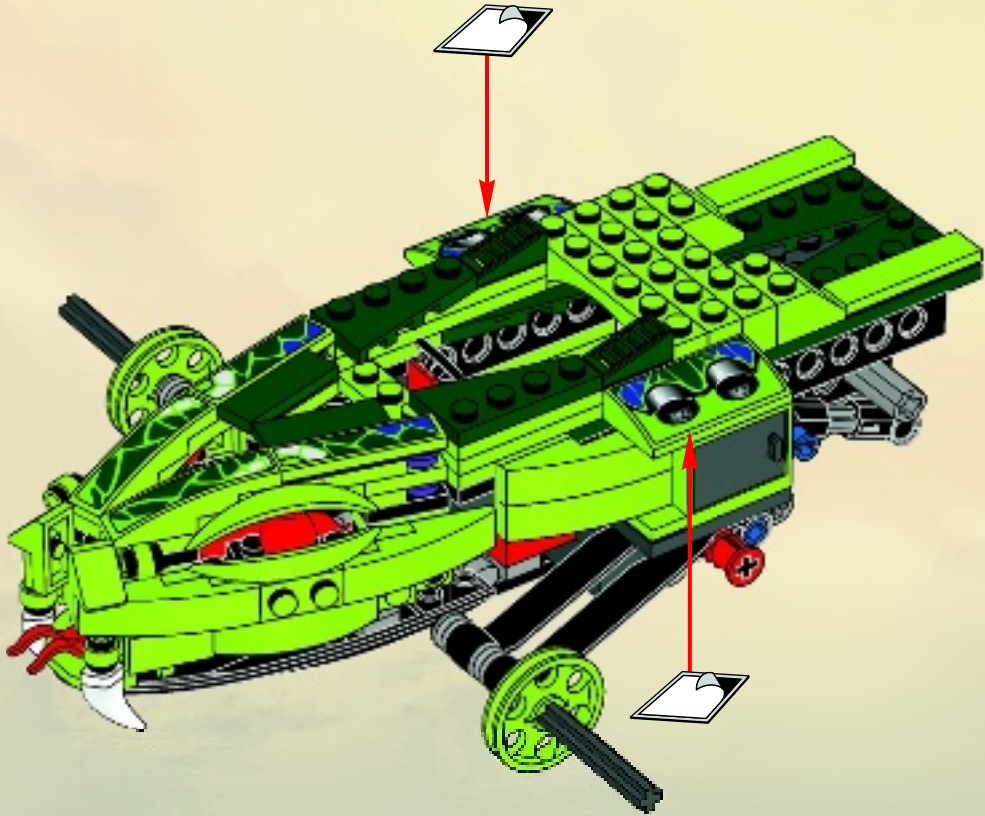



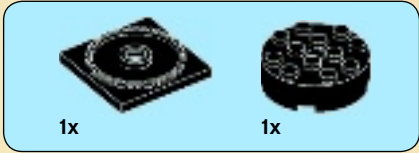

1

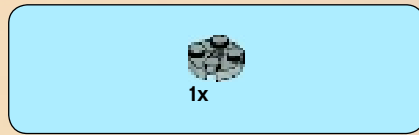
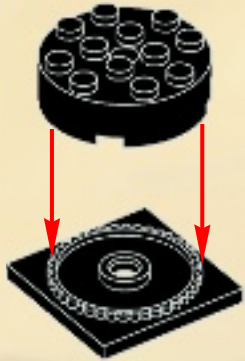

2



3



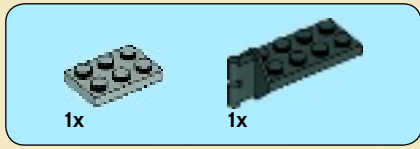

4

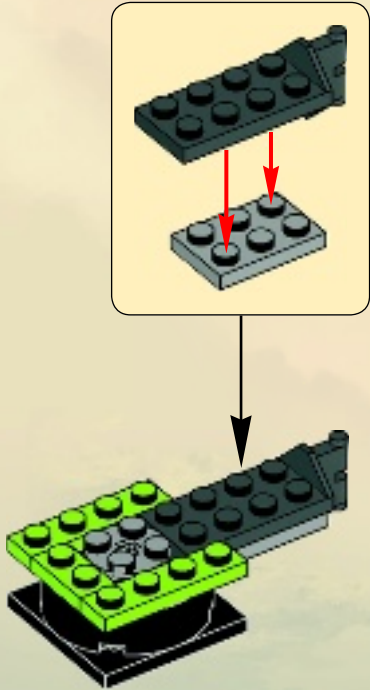

5



6

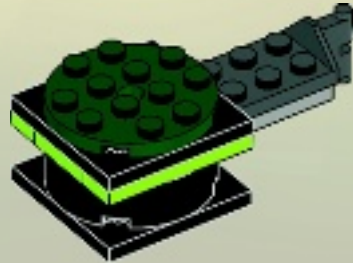



2x

7

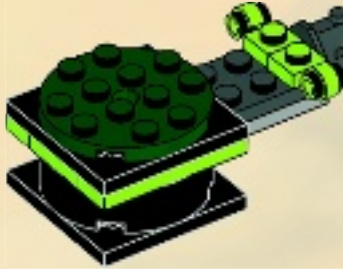

2x

8

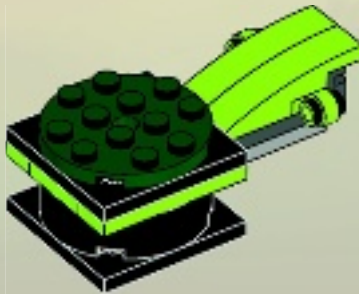





2x

9



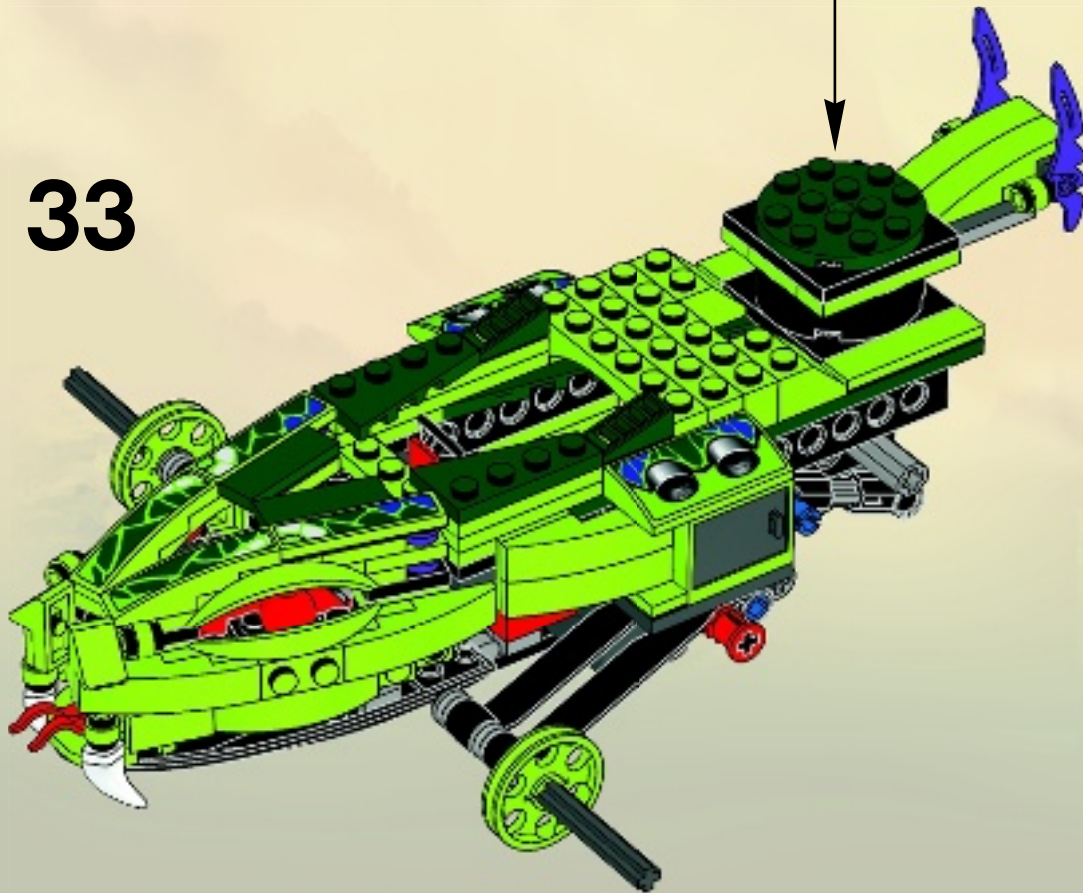

33



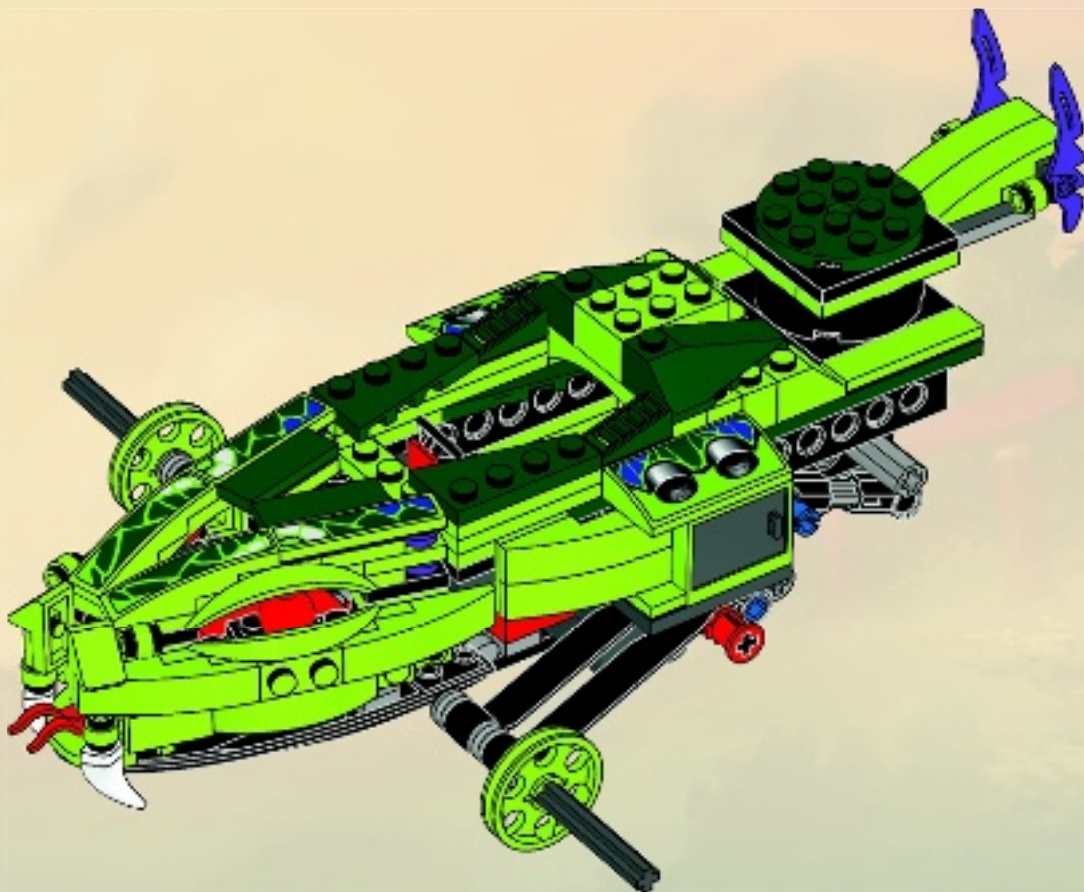

34



1x  2x 

# 35

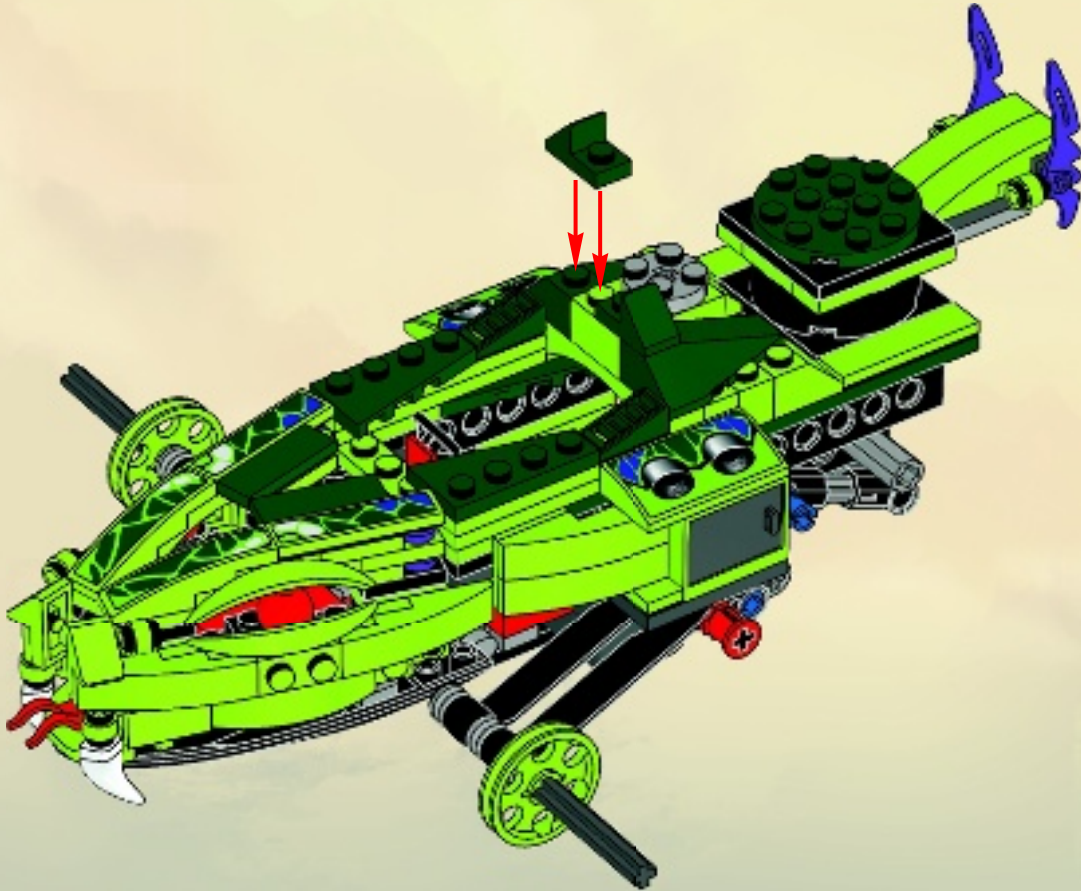



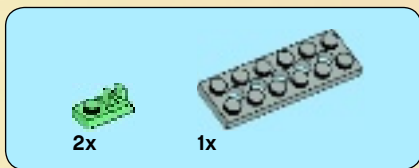

36

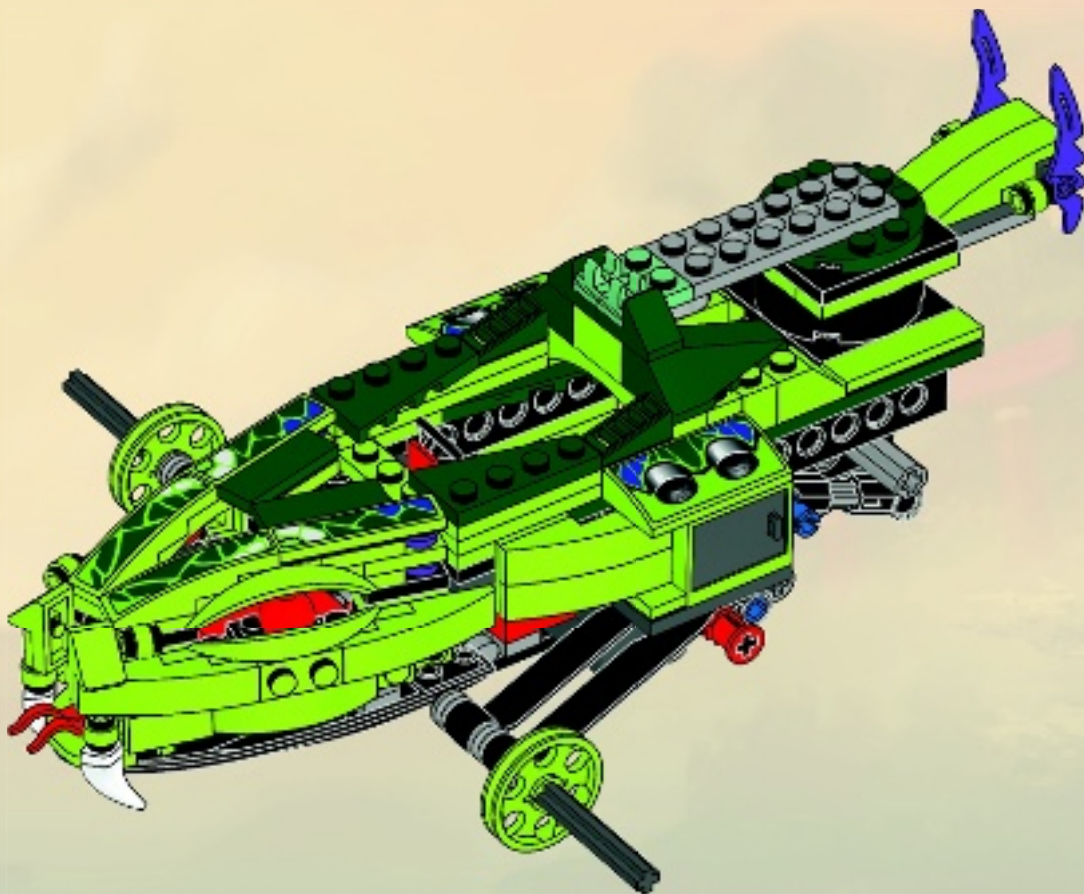



4x

# 37

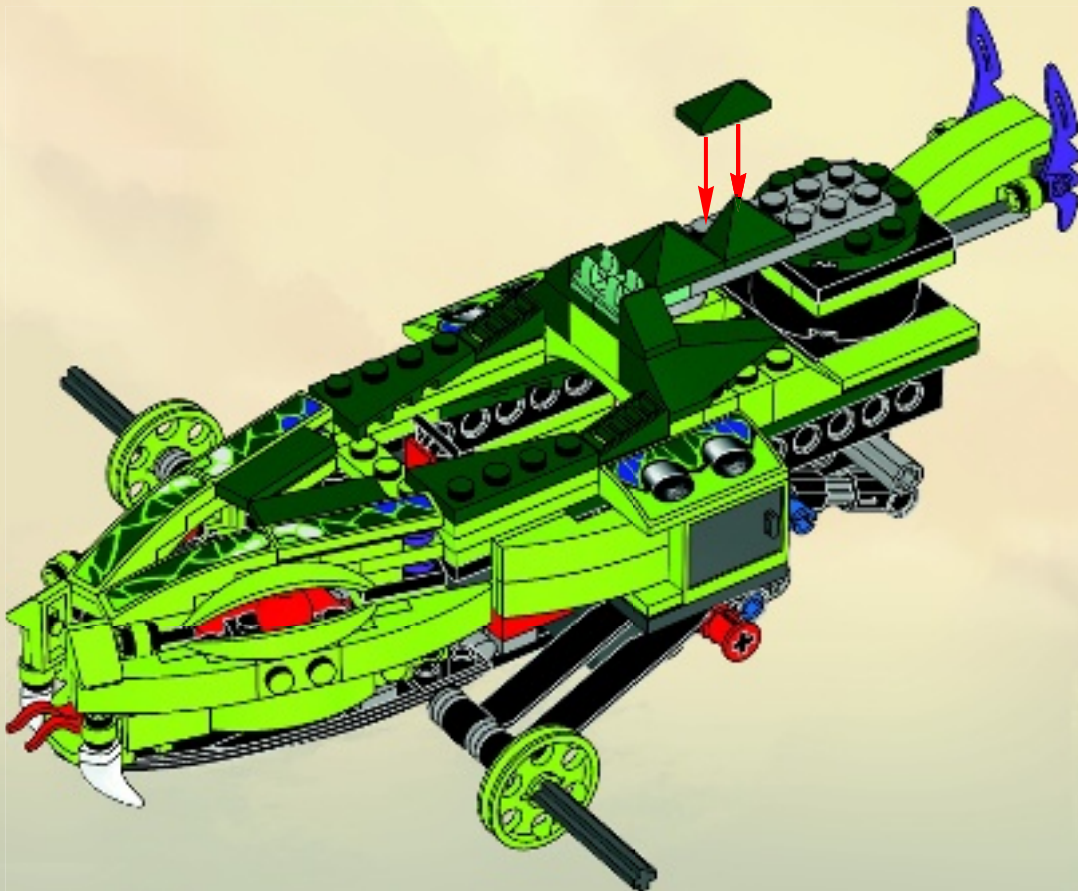

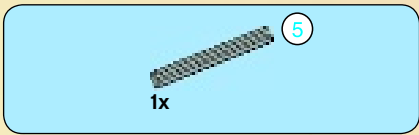

# 38

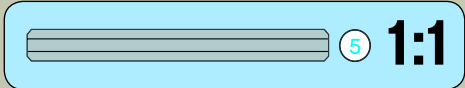





1x

# 39

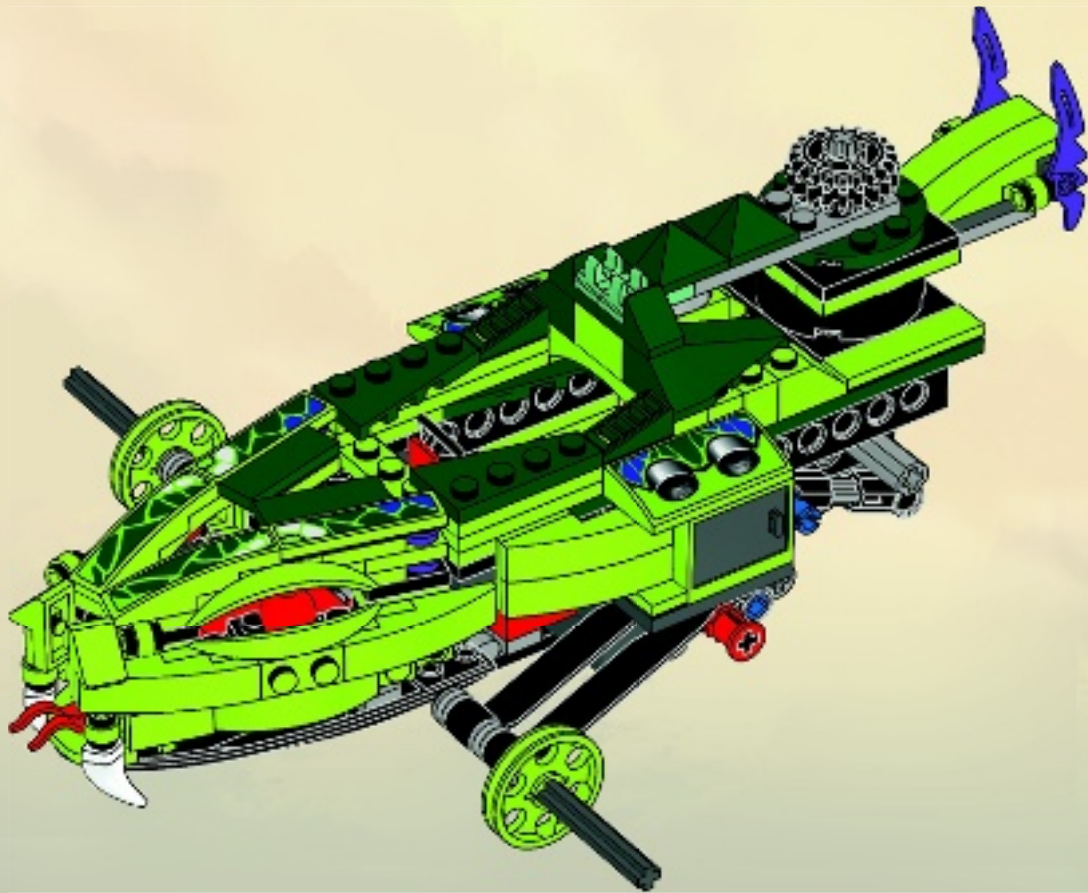

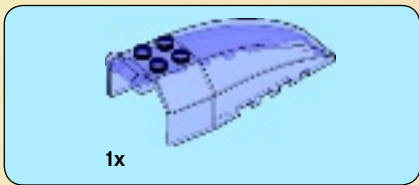

40

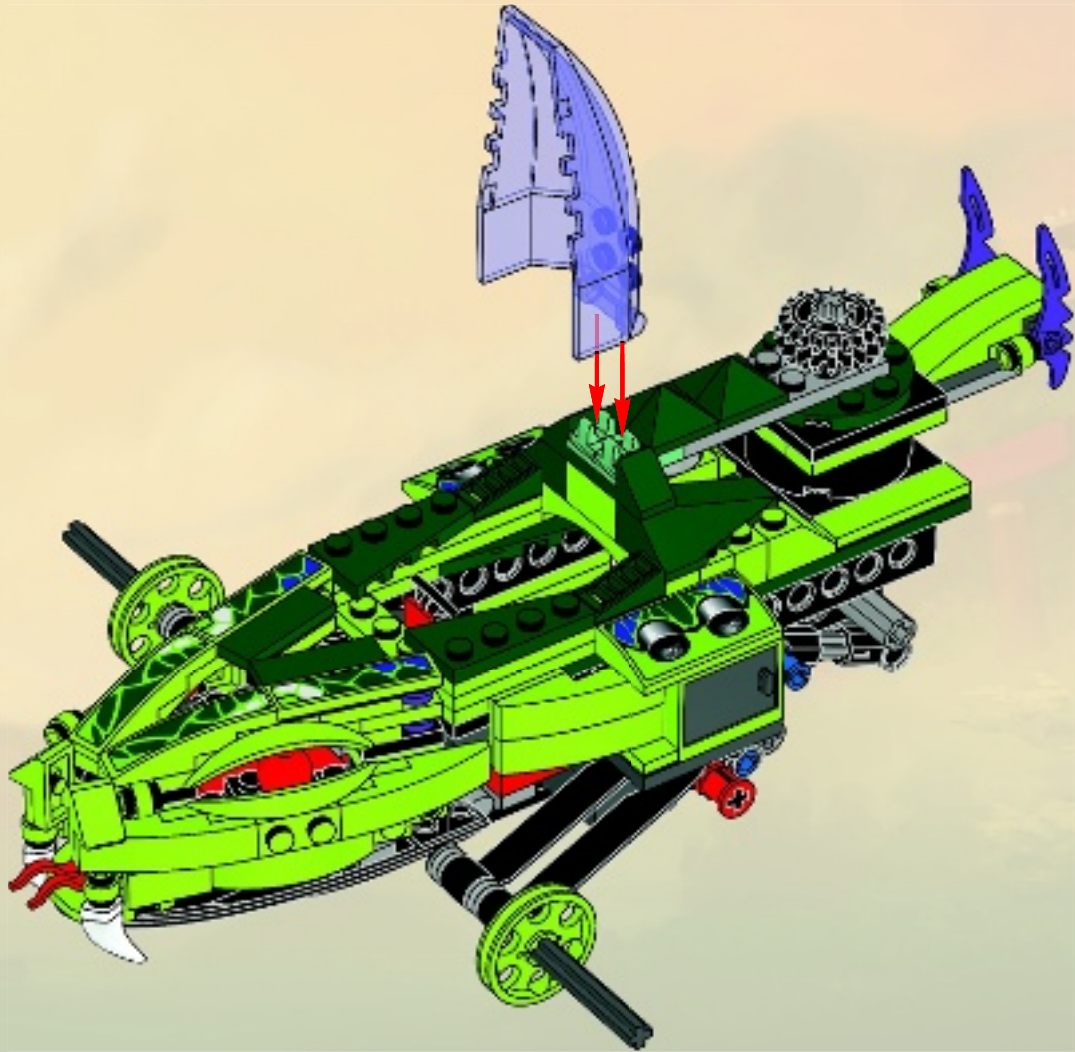

4



1x



1x



1x

1

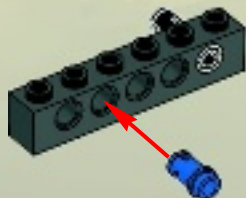

2x

2



1x

3





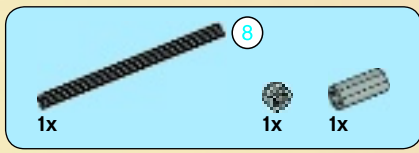

4

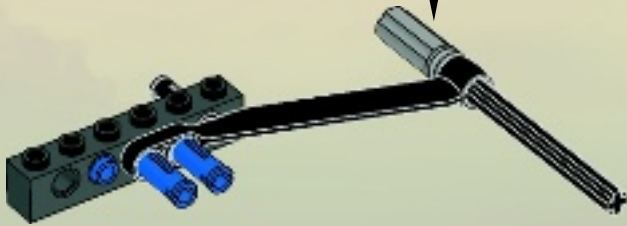
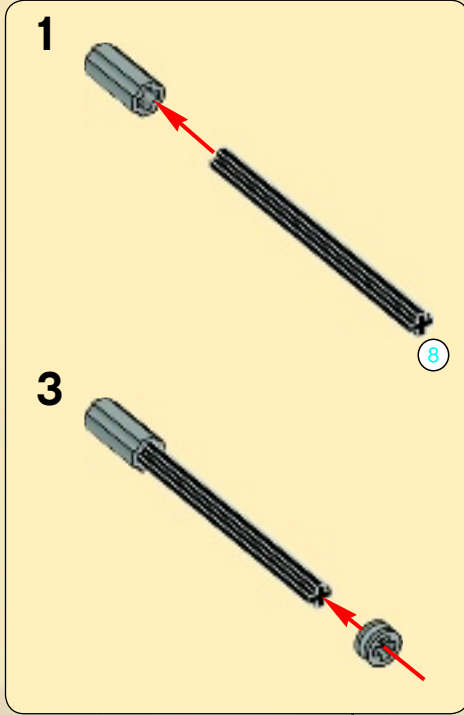

5

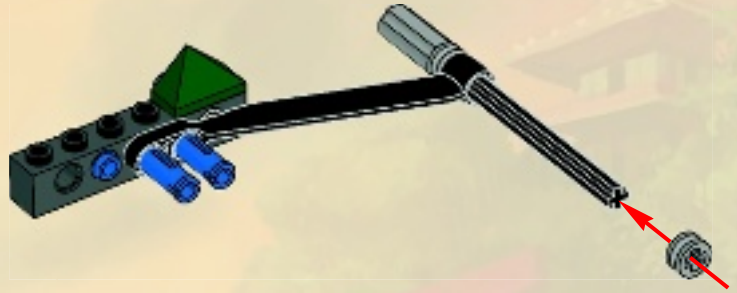

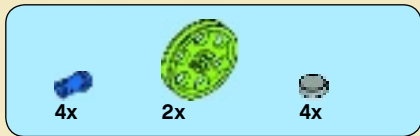

6

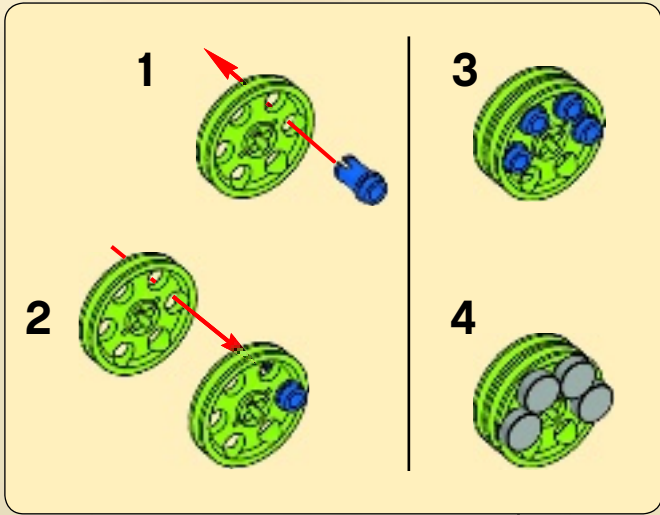

7

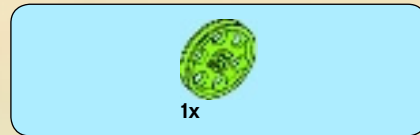
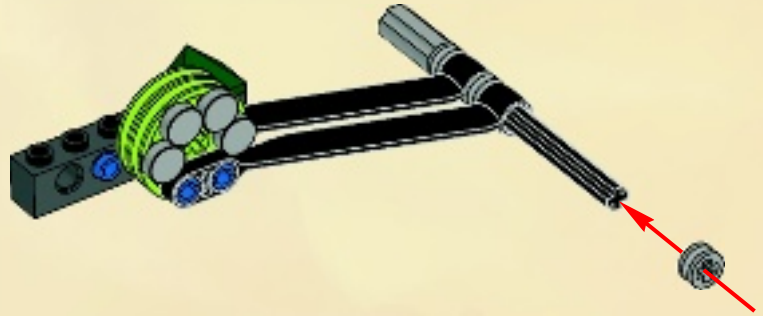

8

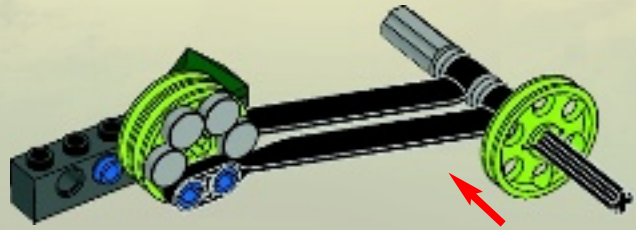

41

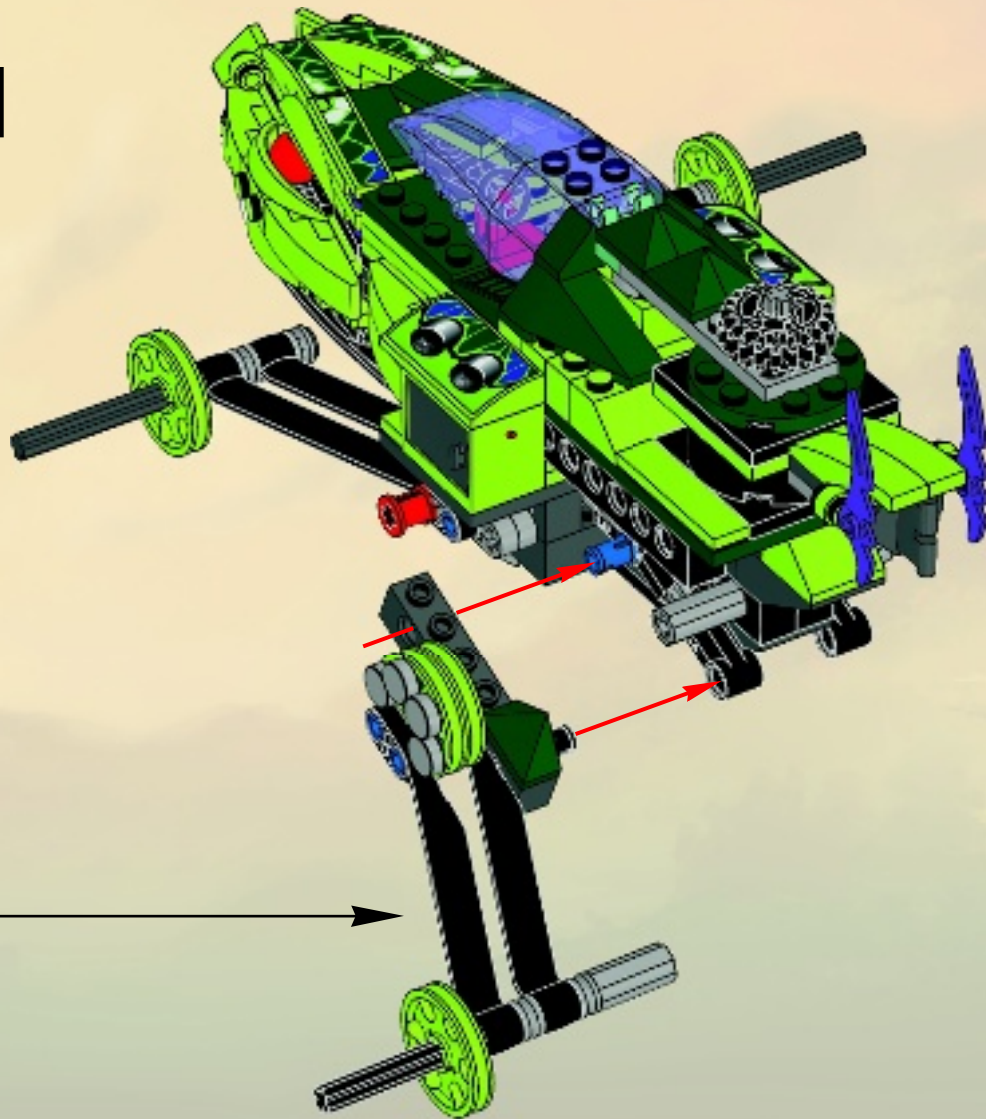

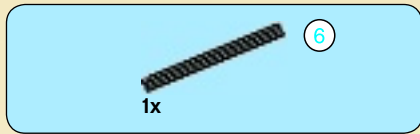

42

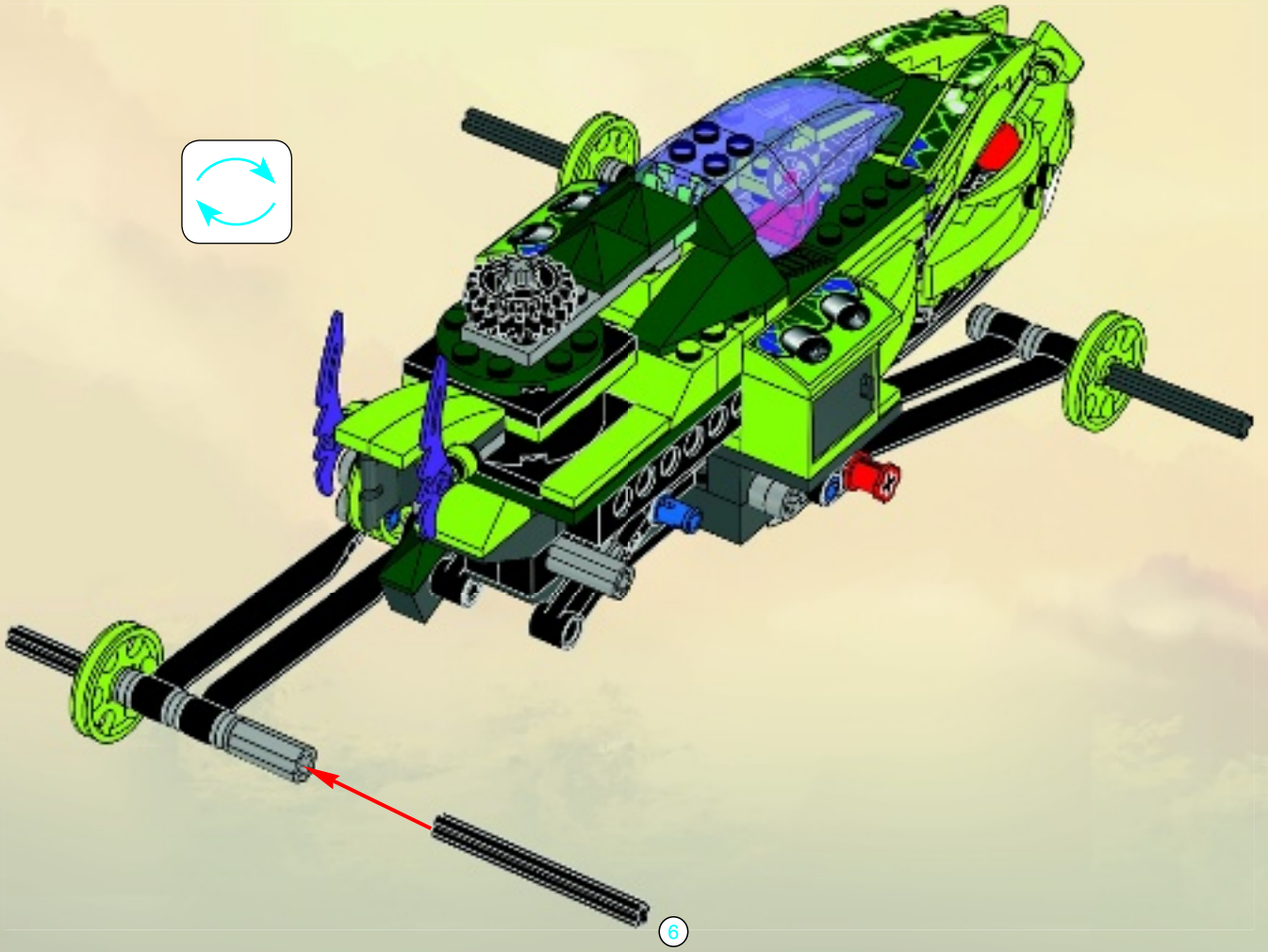
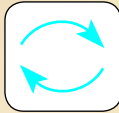





# NINJAGO

Masters of Spinjitzu



NINJAGO.COM



**LEGO** NINJAGO  
Masters of Spinjitzu



9445

9442

9443

9446

9567  
9552

9564

9563

9561

9552

9566

9566

9441  
9558  
9579



9444

9441  
9558

9441  
9444  
9446

9579

9562  
9440

9444  
9566

9551

9440  
9445  
9446  
9553  
9558

9562

9558

9563  
9567

9564





9551   
  9443   
  9446   
  9446   
  9443   
  9446   
  9552   
  9444  
 9579   
  9561  
 9553   
  9442  
 9558   
  9579  
 9558



9562   
  9564   
  9443   
  9442  
 9445   
  9446   
  9446  
 9551  
 9558  
 9561   
  9558  
 9579   
  9579   
  9567   
  9553   
  9440   
  9445





# NINJAGO

Masters of Spinjitzu



9446



9445



9444



9443



9442



9441



9440





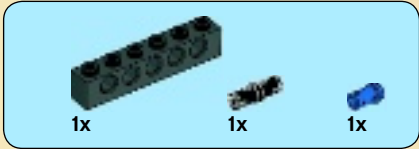

1



2



3



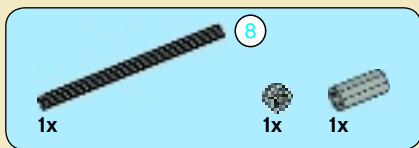

4

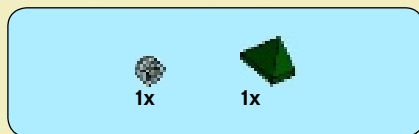
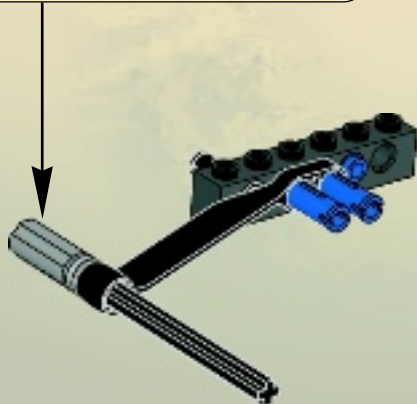
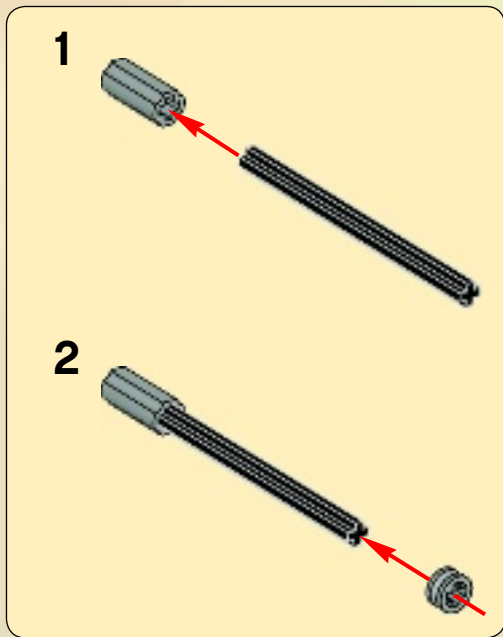

5

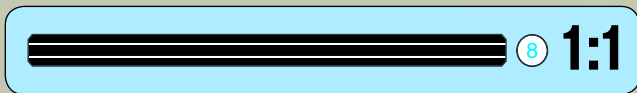
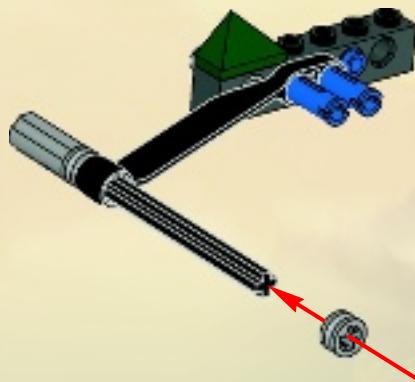

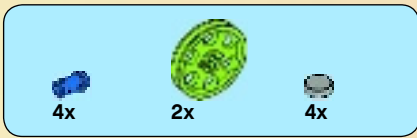

6

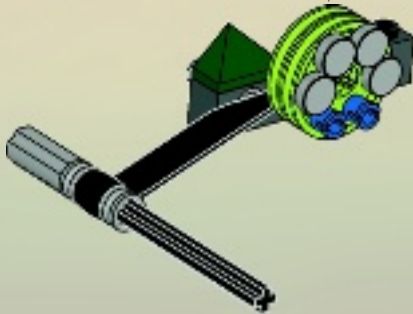
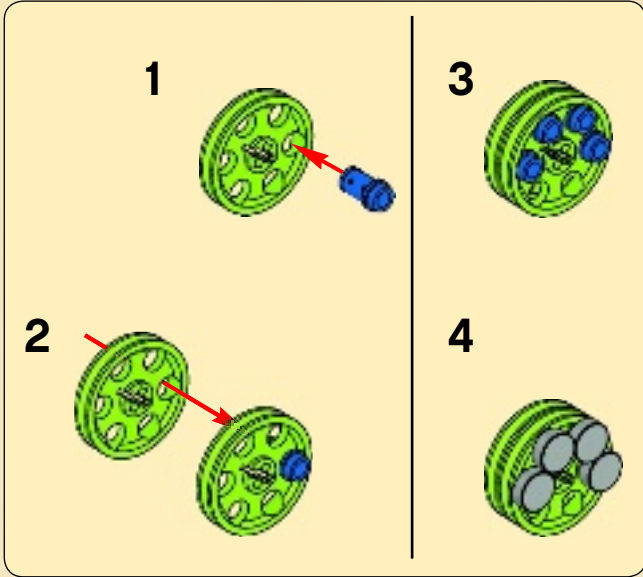

7

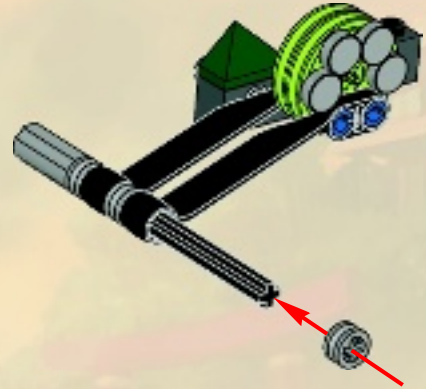

8

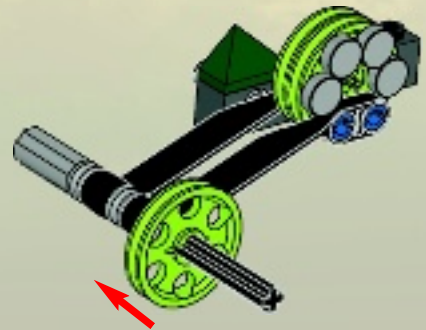



43



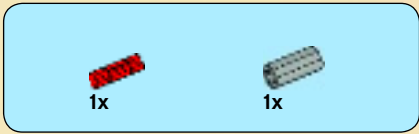

1

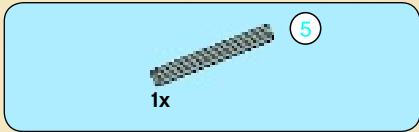
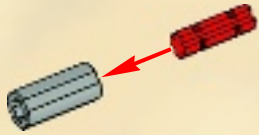

2

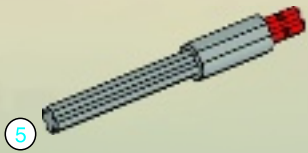

3

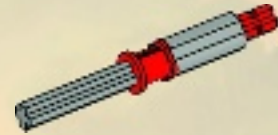

4

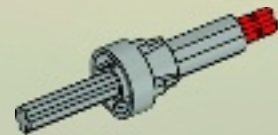



1x

5

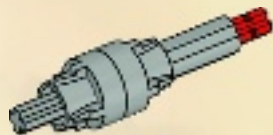

1x

6

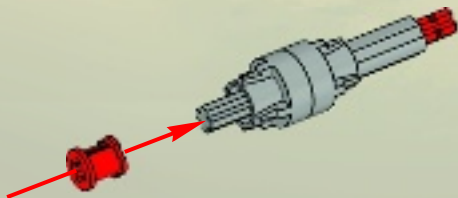

1x

7

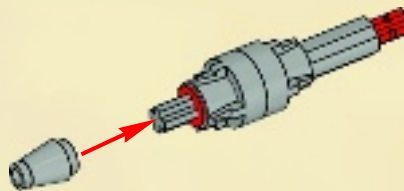

1x

8

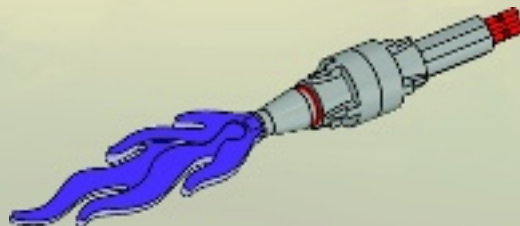





1x

9

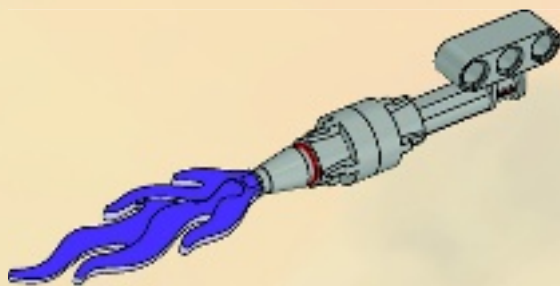

2x



1x

10

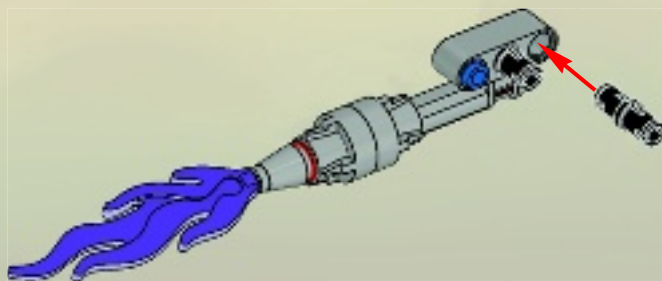



1x

11

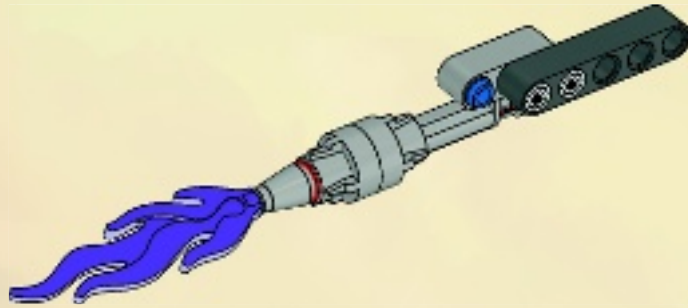

2x

12

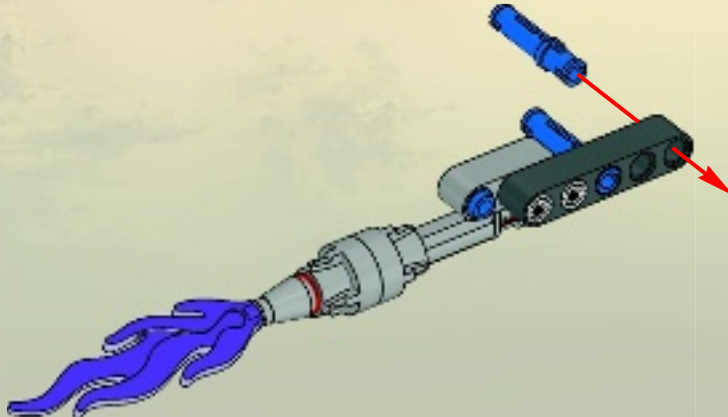

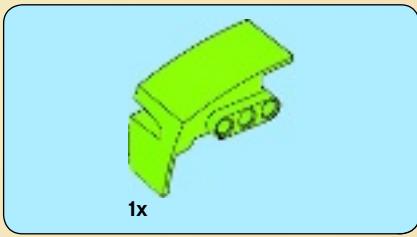

13

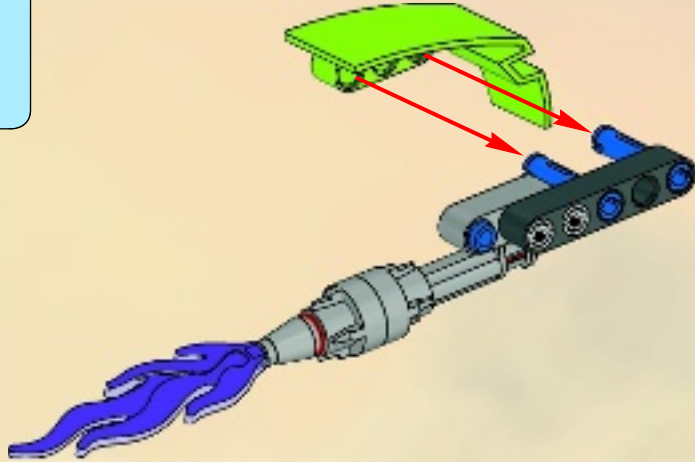

14

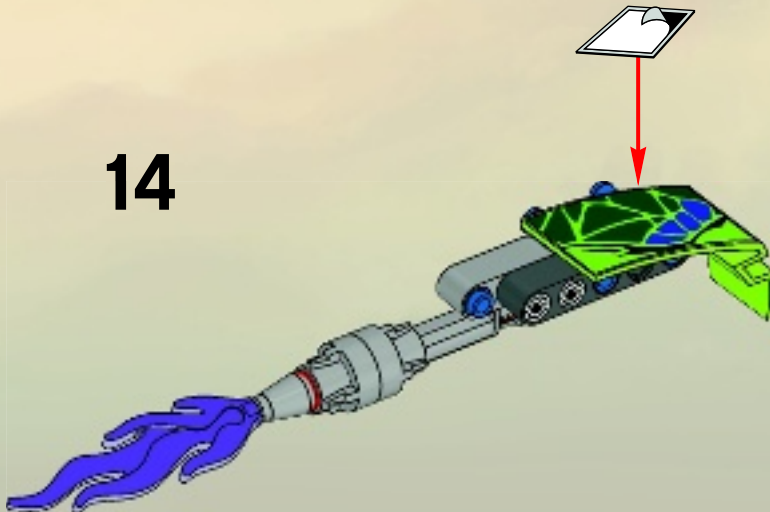



44

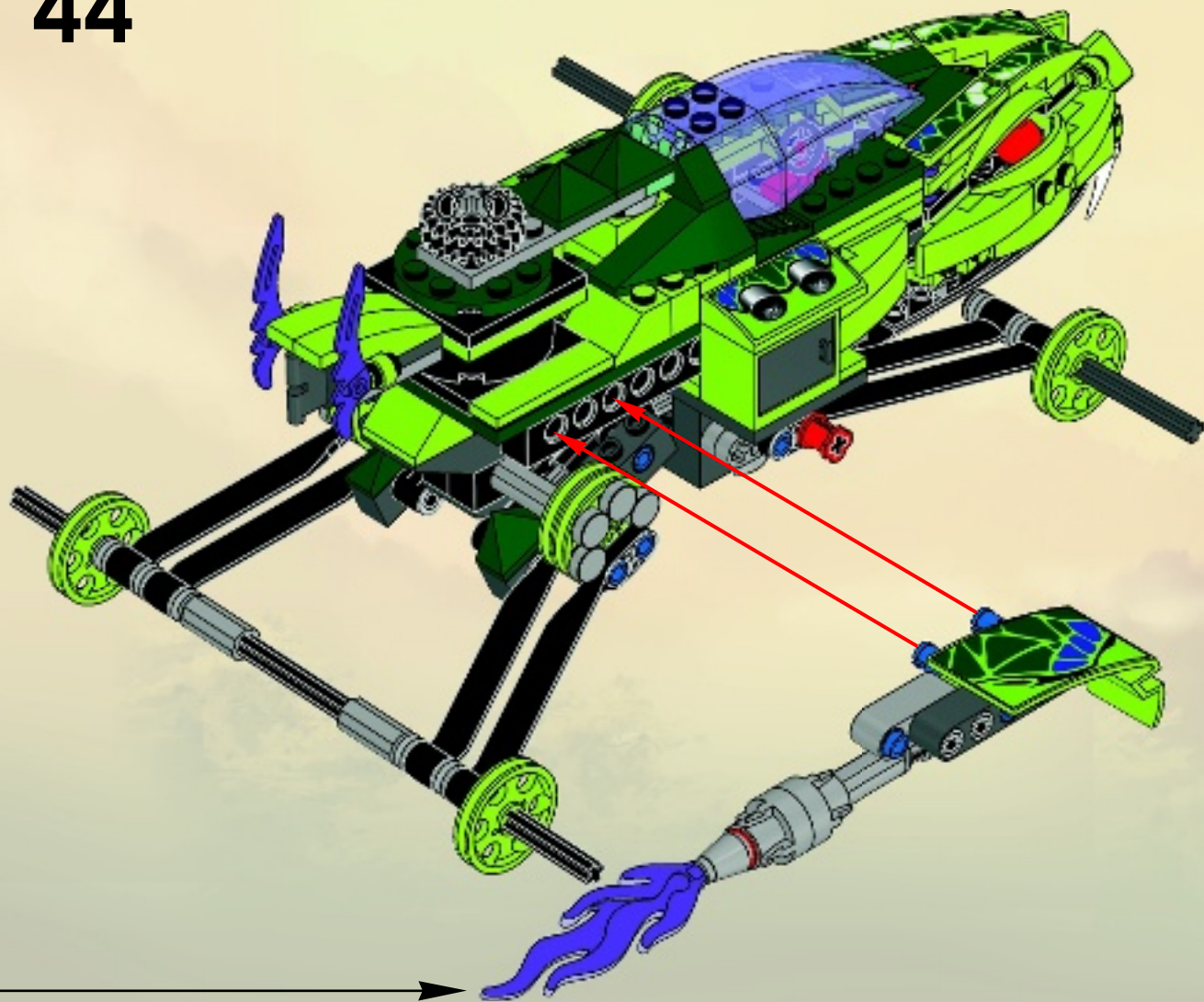

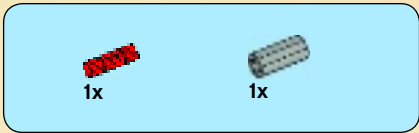
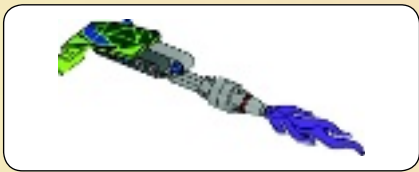

1

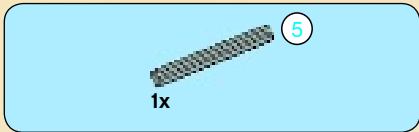
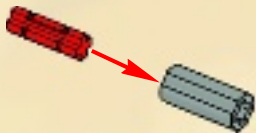

2

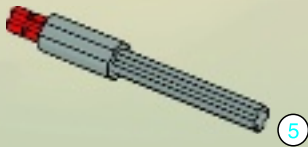

3

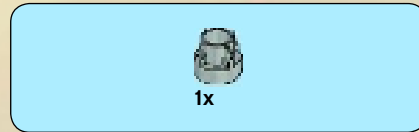
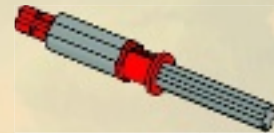

4

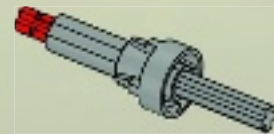



1x

5

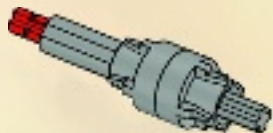

1x

6

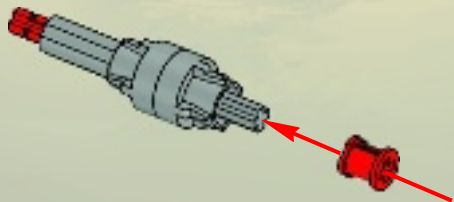

1x

7

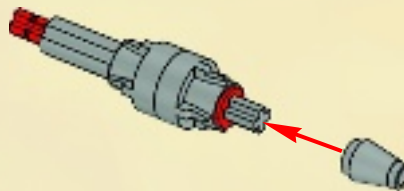

1x

8

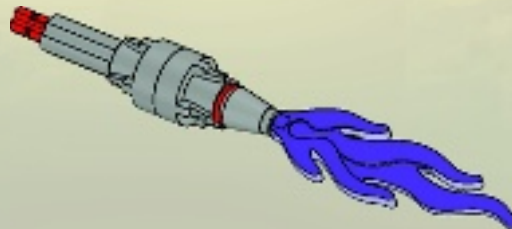





1x

9

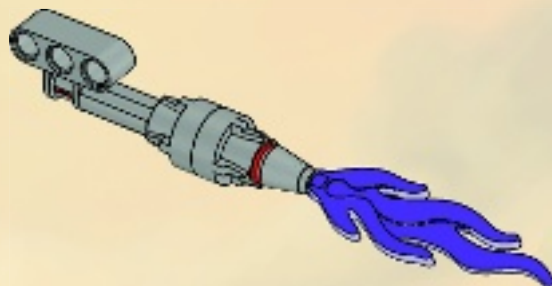

2x



1x

10

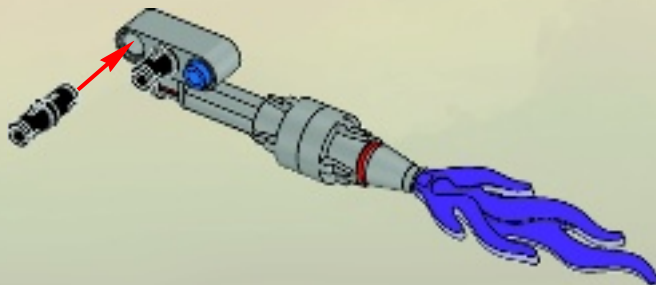



1x

11

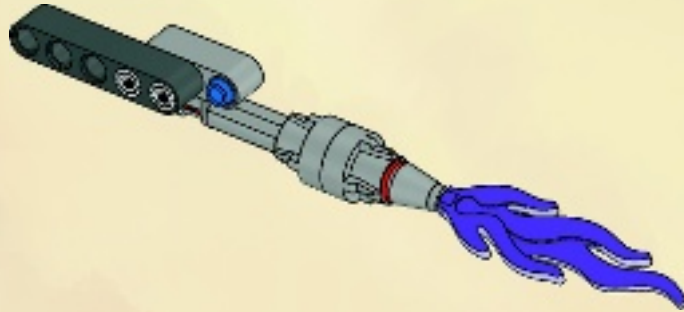

2x

12

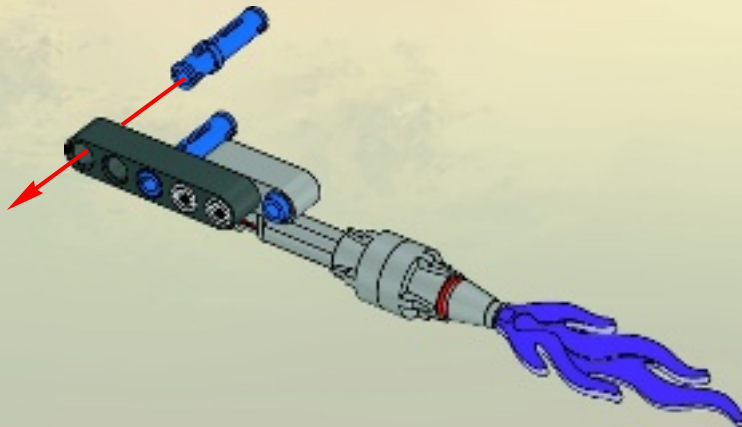

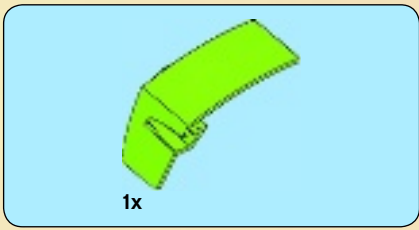

13

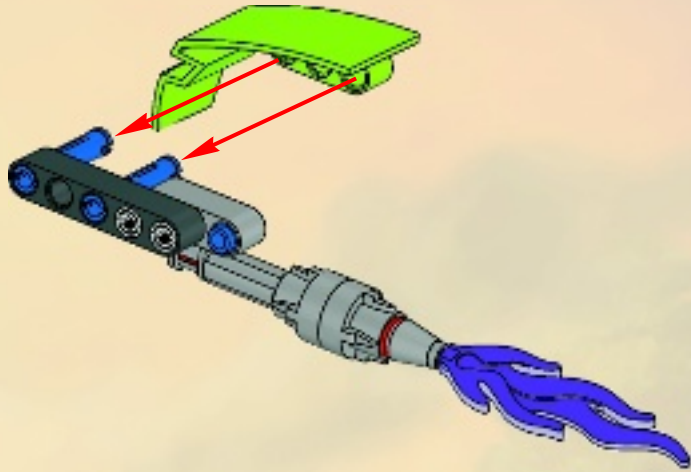

14

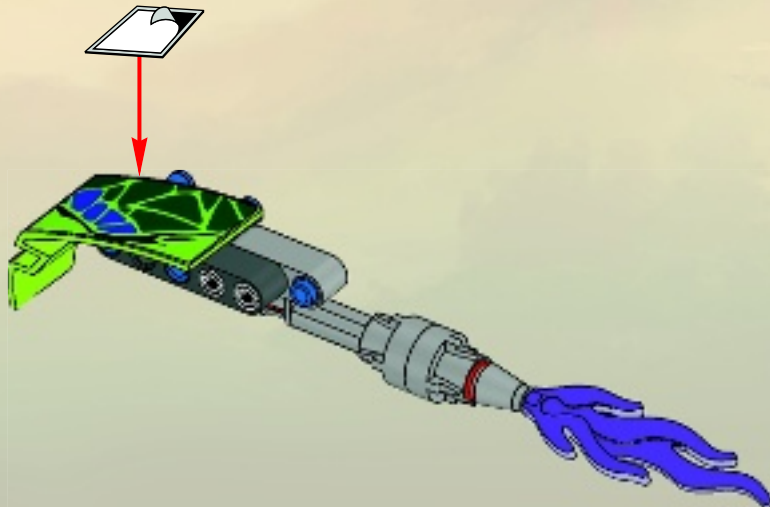

45

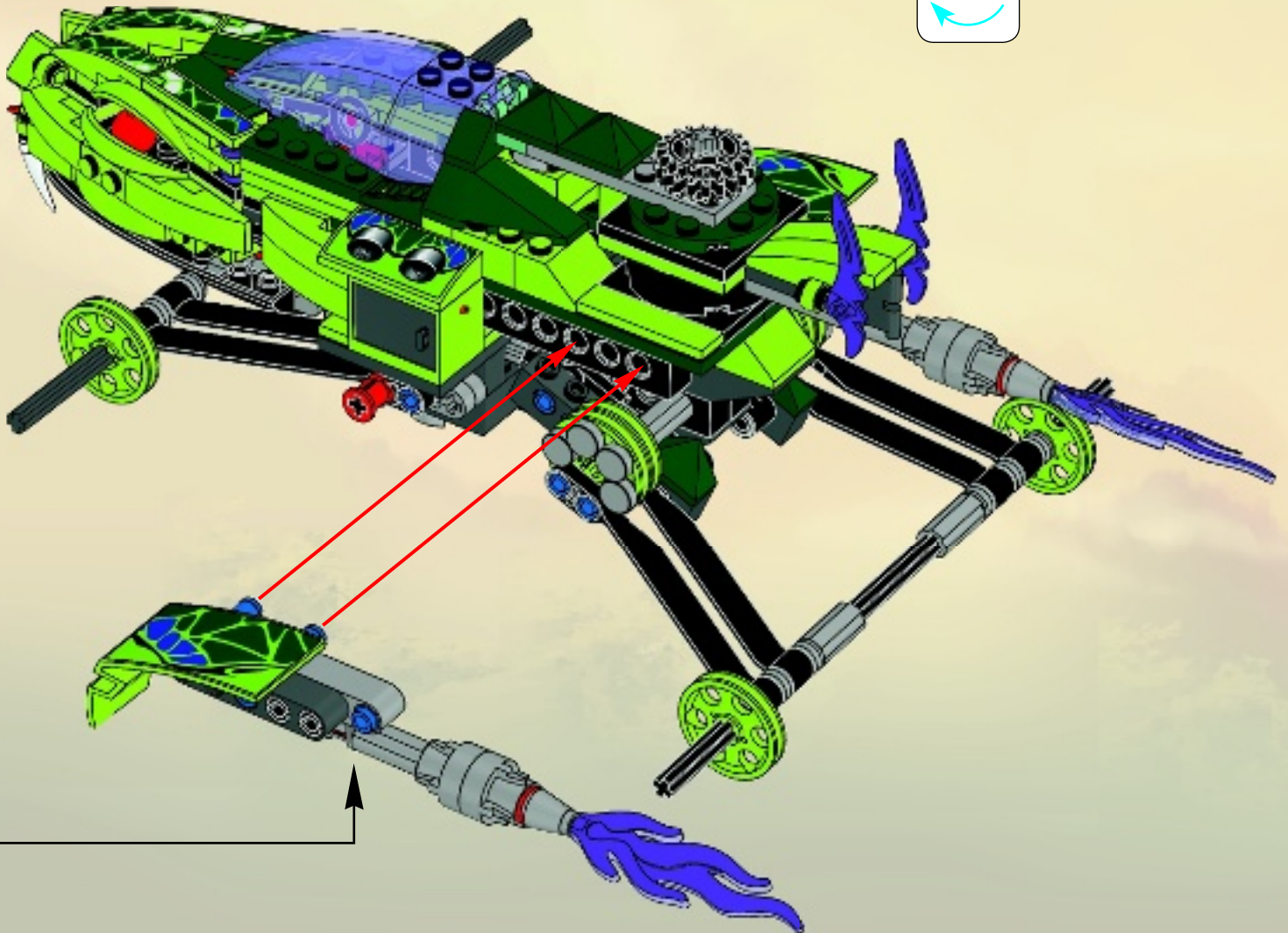
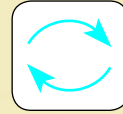





3x



1x

1



1x

2



1x

3



1x

4





1x

5



1x

6



1x

7

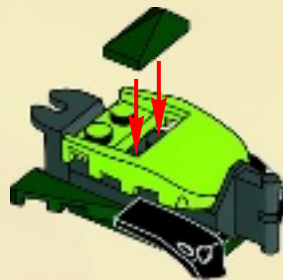

1x

8



3x

46

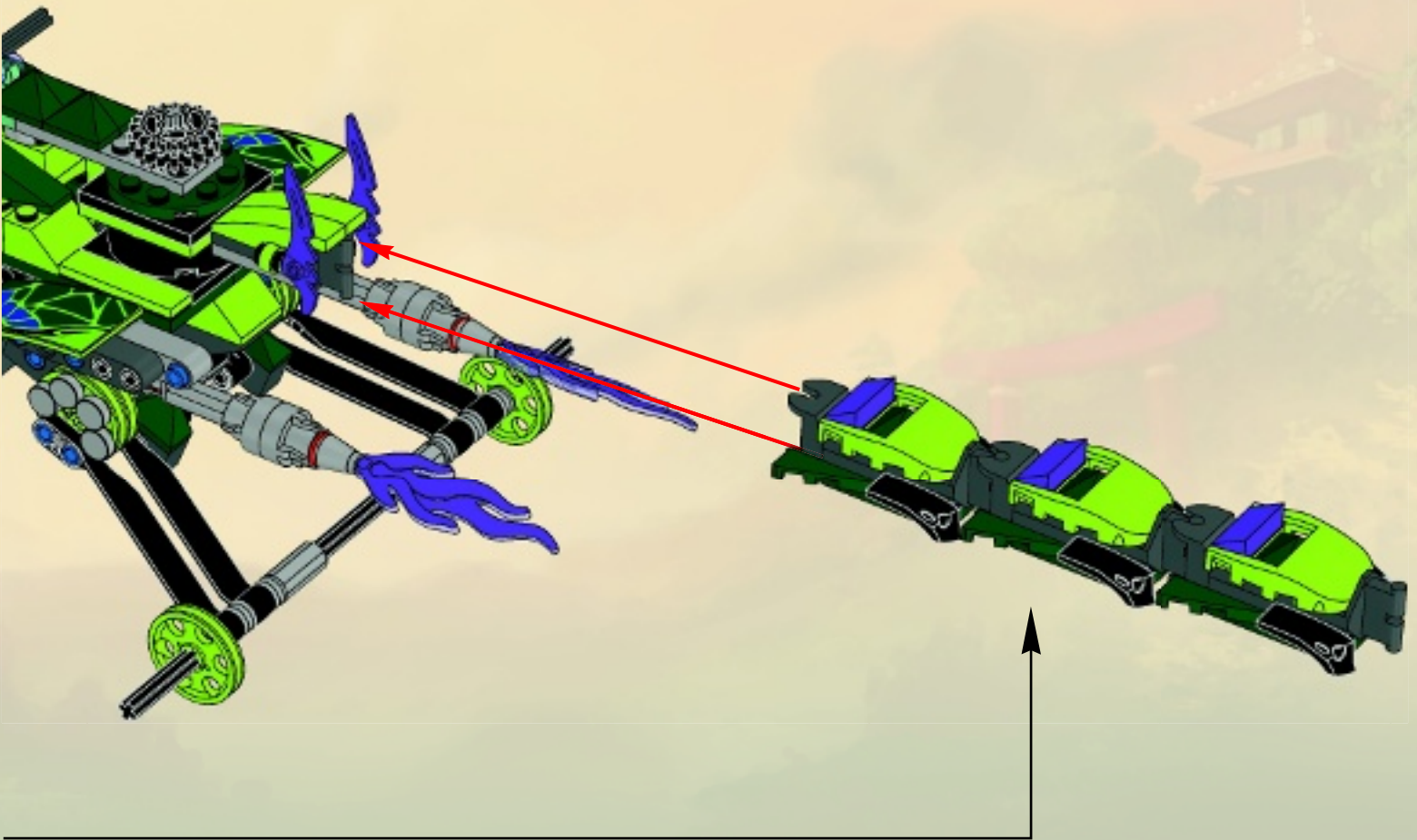

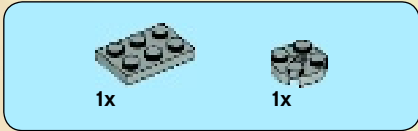

**1**

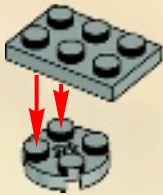

**2**



**3**



**4**

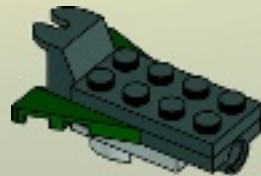





5

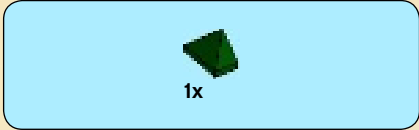

6

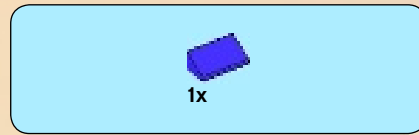
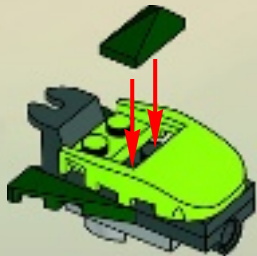

7

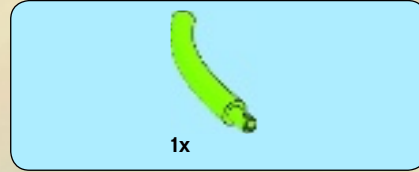
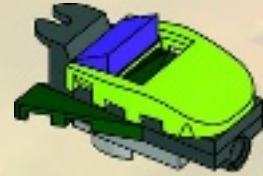

8

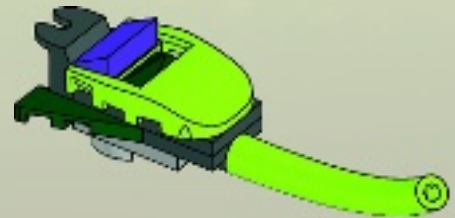

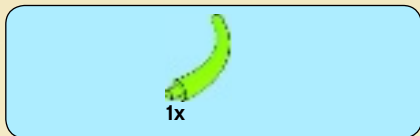

9

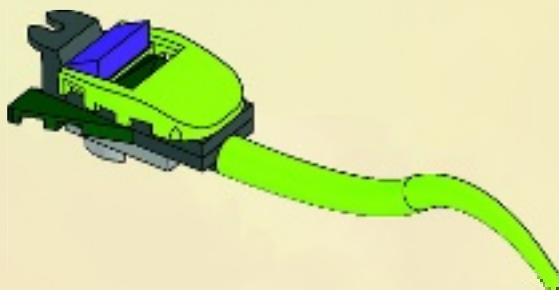

47

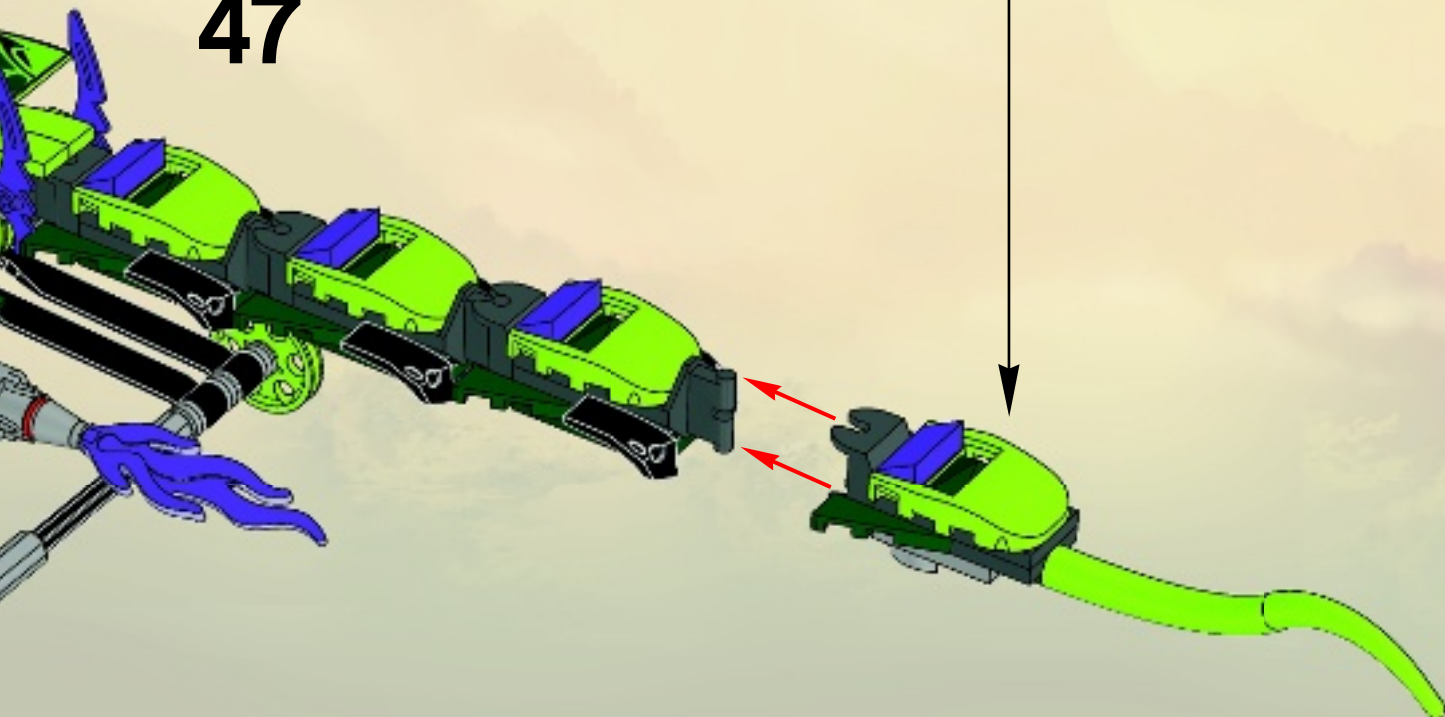

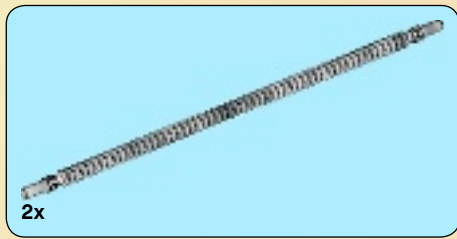

48

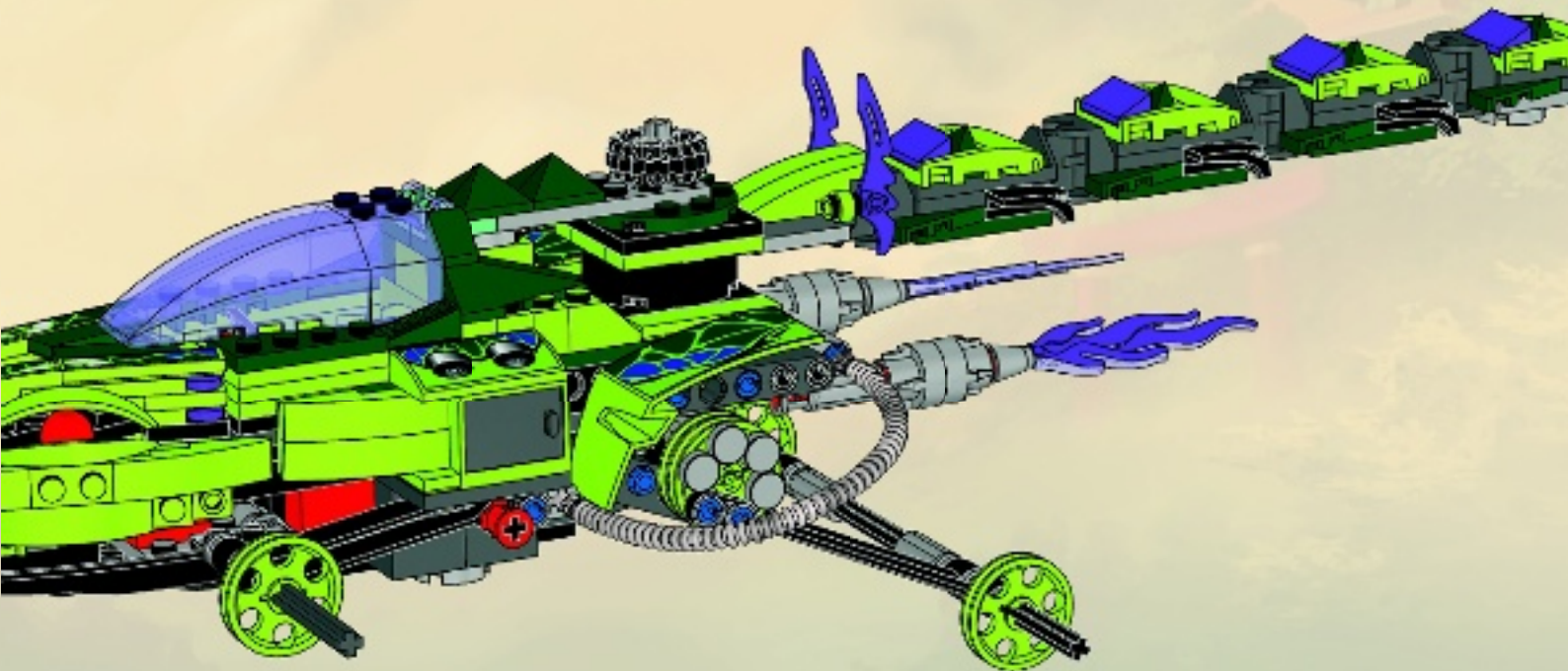



49

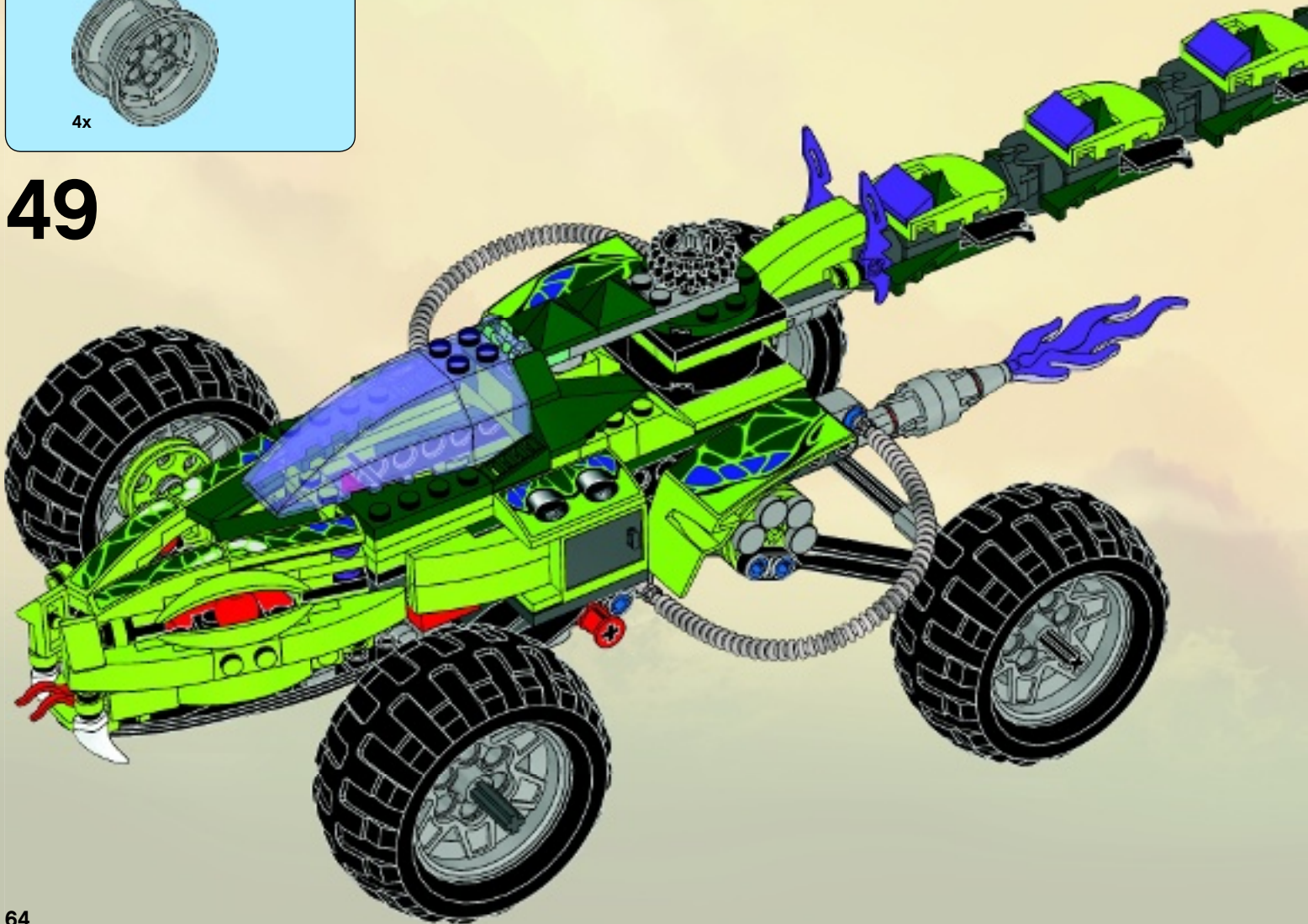



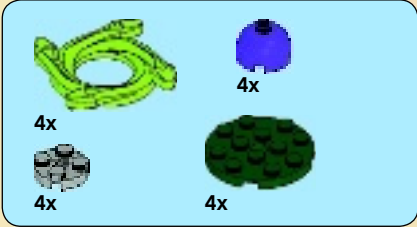

**50**

**1**



**2**



**3**





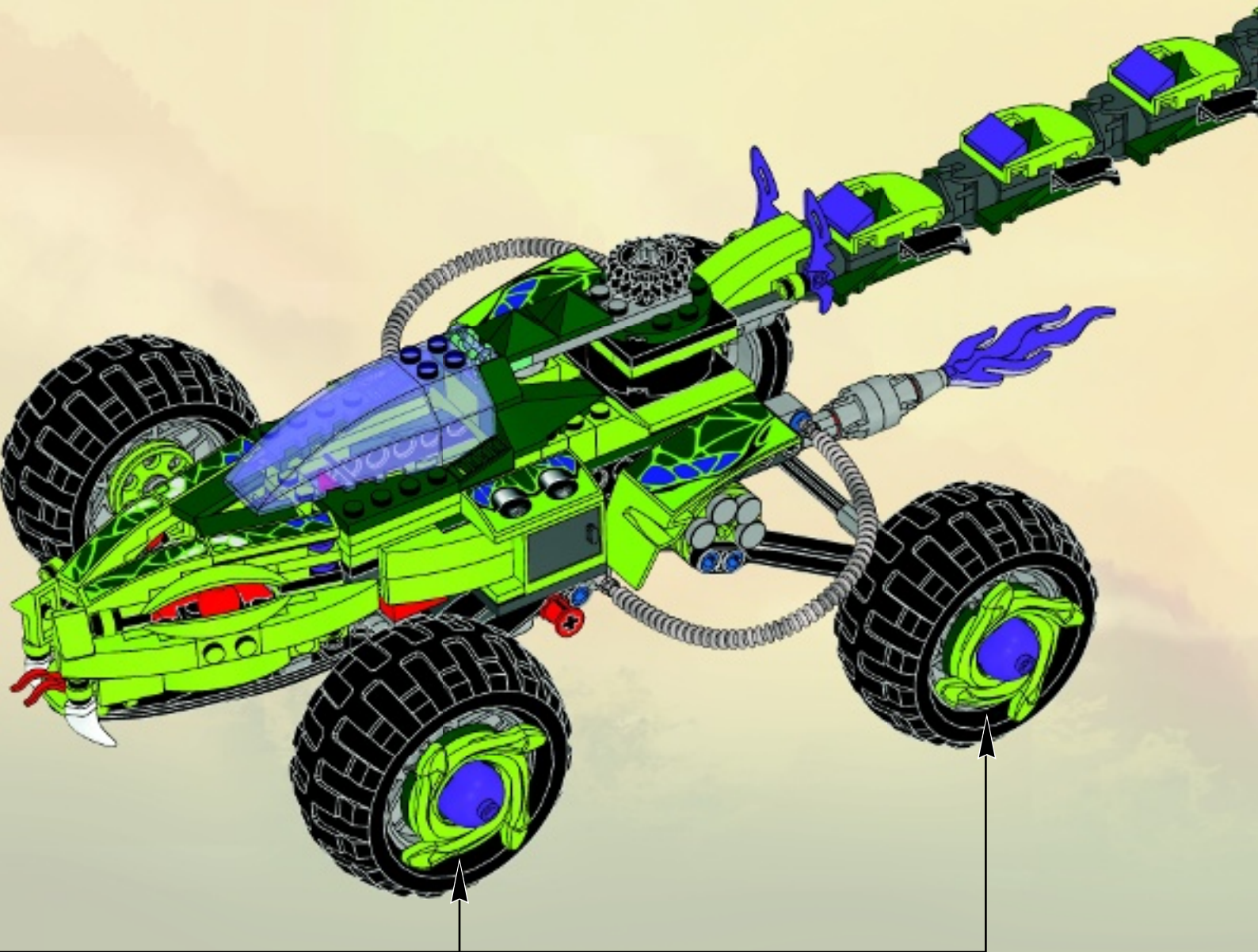

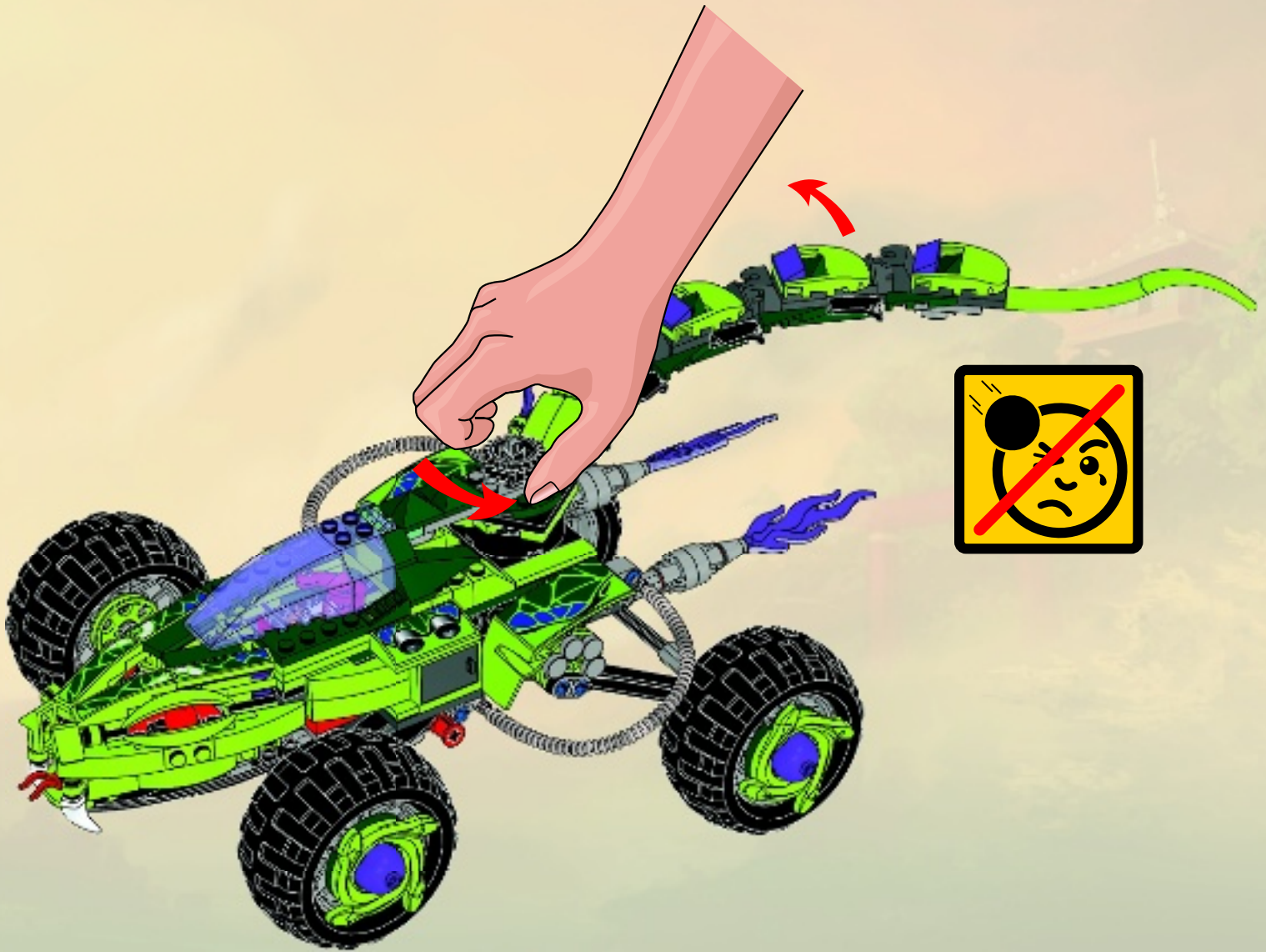



































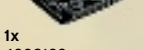











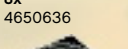





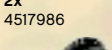





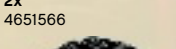













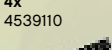

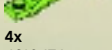



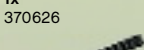

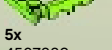



**4x**









 3x 4249112	 1x 4613174	 6x 4227155	 2x 4140588	 1x 393726	 4x 4107085	 2x 4537937
 2x 302301	 2x 302221	 2x 4142865	 1x 4225201	 6x 74011	 2x 4107082	 10x 4187743
 1x 371001	 2x 4588003	 4x 370023	 2x 4183043	 1x 4140670	 10x 4121715	 7x 4529160
 3x 302001	 1x 4140585	 2x 302223	 3x 4298011	 1x 4603189	 1x 4278359	 6x 4632576
 3x 255501	 1x 449521	 1x 379423	 1x 4558957	 8x 4650636	 1x 3003126	 4x 4500125
 2x 4535737	 1x 4648092	 2x 4505907	 2x 3200026	 3x 4548180	 1x 4177430	 6x 4569452
 1x 4650588	 1x 4647306	 1x 4650492	 1x 4541984	 2x 4517986	 1x 4653402	 2x 4625623
 1x 4650494	 1x 4647443	 1x 4650129	 1x 4180469	 2x 4651566	 1x 4220631	 1x 4650634
 1x 4650130	 1x 4648354	 1x 4650118	 2x 4162443	 4x 4539110	 3x 4650630	 1x 4650635
 1x 4650119	 1x 4648360	 2x 4597338	 2x 346026	 1x 370626	 2x 4648274	 4x 4610474
 2x 4566256	 1x 4538780	 12x 4143005	 1x 303426	 2x 370726	 12x 4537927	 5x 4567882
 1x 4195869	 1x 9552	 2x 4206482	 2x 346026	 1x 370626	 2x 4617069	 2x 4597561
 1x 4612342	 1x 4648351	 12x 4514553	 4x 389526	 2x 370826	 3x 4625474	 2x 4597561
 2x 362221	 2x 4290714	 1x 4611427	 4x 389526	 1x 370826	 6x 4164037	 4x 4647108



8x  
4494219



1x  
4518814

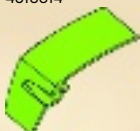

1x  
4518816



1x  
4651579



10x  
4266666



2x  
4650622



2x  
4648467



3x  
4586057



1x  
4500060



1x  
4500059



1x  
4293614



1x  
4293615



1x  
4648340



1x  
4648342



4x  
4649051



5x  
4612728



2x  
4651834



2x  
4211396



2x  
4211804



1x  
4211840



1x  
4211841



1x  
4211542



12x  
4211475



8x  
4650260



1x  
4299119



2x  
4538007



1x  
4646815



4x  
4634091



2x  
4600448



2x  
4625236



2x  
4529241



4x  
4211566



12x  
4211573



6x  
4211807



6x  
4512360



4x  
4211815



3x  
4211639



1x  
4612900



4x  
4278756



2x  
4210875



2x  
4213607



2x  
4210917



1x  
4211064



2x  
4210779



2x  
4211085



1x  
4211065



1x  
4211002



1x  
4211122



2x  
4615232



2x  
4210686



2x  
4499858



1x  
4211043



1x  
4210892



2x  
4210811



4x  
4265486



4x  
4264952



1x  
4196768



1x  
4278274



2x  
4289542



4x  
4529247



4x  
4490599



3x  
4523159



4x  
4649422



2x  
4600519



1x  
4646828



2x  
4646871



1x  
4646814



4x  
4595891



4x  
4566607



4x  
4566522



2x  
4651825



2x  
4651591



Customer Service

Kundenservice

Service Consommateurs

Servicio Al Consumidor

[www.lego.com/service](http://www.lego.com/service) or dial



00800 5346 5555 :

1-800-422-5346 :





# LEGO NINJAGO

Masters of Spinjitzu

**CUSTOMISE YOUR SPINNERS**  
 BAUE DEINE EIGENEN, VERÄNDERBAREN SPINNERS • PERSONNALISE TES TOUPIES  
 PERSONALIZA TUS SPINNERS • PERSONALIZA AS TUAS RODAS  
 TEDD EGYEDIVÉ A PÖRGETTYÜDET!

RAATLA

COLE ZX

9579

**ARENA INCLUDED**  
 INKLUSIVE ARENA • PISTE INCLUSE  
 INCLUYE ÁREA DE COMBATE  
 ARENA INCLUÏDA • ARÉNÁVAL

9551

9552

9553

**CUSTOMISE WITH BOOSTER PACKS**

Noch mehr Action mit den Booster Packs  
 Personnalise grâce aux boosters  
 Personalízalo con los packs de expansión  
 Personaliza com pacotes de expansão  
 Tedd egyedivé kiegészítő készletekkel

**NINJAGO.COM**

COLE ZX VS RAATLA

LASHA

KENDO ZANE

SNARPA

SAMURAI X

WAI ZX

FANG-SUEI

9579

9562

9563

9564

9566

9561

9567





**KENDO ZANE**  
9563 - 9446



**KENDO KAI**  
9558



**KENDO COLE**  
9551



**COLE ZX**  
9579 - 9444



**ZANE ZX**  
9440  
9445



**JAY ZX**  
9553  
9442  
9445



**SAMURAI X**  
9566



**LLOYD GARMADON**  
9552 - 9443



**FANG-SUEI**  
9567 - 9443



**FANGDAM**  
9445



**LASHA**  
9562



**RATTLA**  
9579 - 9441



**SNAPPA**  
9564 - 9442









# NINJAGO

Masters of Spinjitzu



## **CUSTOMISE YOUR SPINNERS**

**BAUE DEINE EIGENEN, VERÄNDERBAREN SPINNERS • PERSONNALISE TES TOUPIES**  
**PERSONALIZA TUS SPINNERS • PERSONALIZA AS TUAS RODAS**  
**TEDD EGYEDIVÉ A PÖRGETTYÜDET!**







# NINJAGO

Masters of Spinjitzu



NINJAGO.COM



# WIN!

Go to [www.LEGOsurvey.com/product](http://www.LEGOsurvey.com/product) to fill out a survey for a chance to win a cool LEGO® Product.  
No purchase necessary.  
Open to all residents where not prohibited.

 [www.LEGO.com](http://www.LEGO.com)



## [www.LEGOsurvey.com/product](http://www.LEGOsurvey.com/product)

### GEWINNE! WIN!

Nimm an der Umfrage auf [www.LEGOsurvey.com/product](http://www.LEGOsurvey.com/product) teil und hab die Chance ein cooles LEGO® Produkt zu gewinnen!  
Die Teilnahme am Gewinnspiel führt zu keinerlei Kaufverpflichtungen. Teilnahme in allen nicht ausgeschlossenen Ländern möglich.

Ga naar [www.LEGOsurvey.com/product](http://www.LEGOsurvey.com/product), vul een enquêteformulier in en maak kans op een cool LEGO® product.  
Geen aankoopverplichting, iedereen mag deelnemen, uitzonderend ingezetenden van landen waar een enquêteverbod geldt.

### GAGNE! 当てよう!

Visite [www.LEGOsurvey.com/product](http://www.LEGOsurvey.com/product) pour répondre à un questionnaire et avoir une chance de gagner un produit LEGO® très cool!  
Aucune obligation d'achat.  
Ouvert à tous les résidents des pays autorisés.

[www.LEGOsurvey.com/product](http://www.LEGOsurvey.com/product) にアクセスして、アンケートにご記入ください。当選者にはレゴ®製品を差し上げます。  
お買い上げの必要はありません。  
禁止されていない限り、すべての皆様にご利用いただけます。