



GALAXY SQUAD

70705





LEGO.com/brickseparator

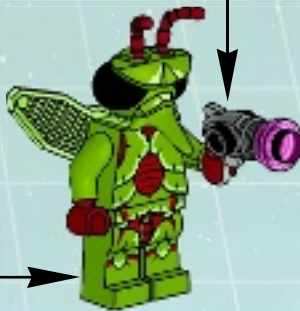
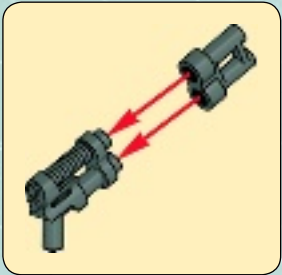
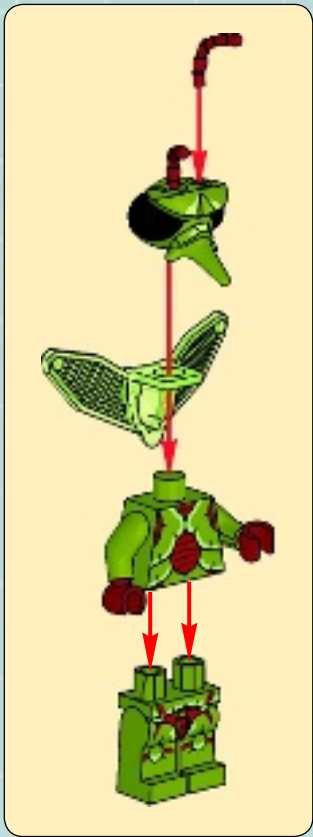
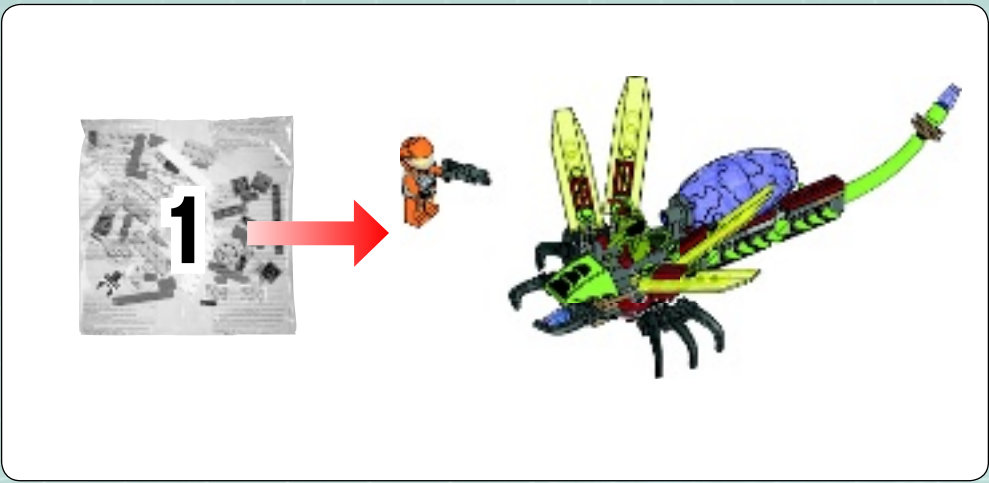

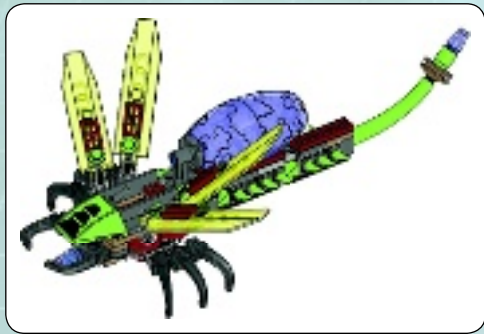

1

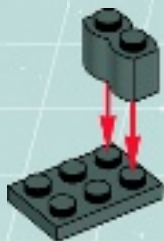

2



3

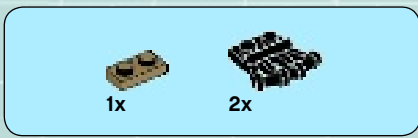

4





5

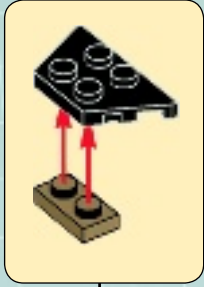

6



7

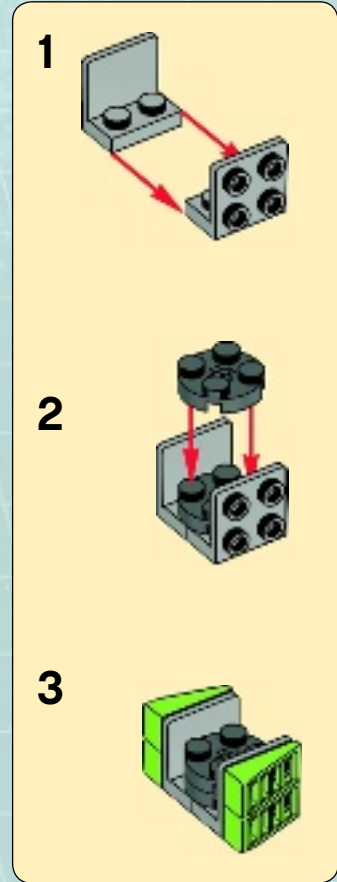



8



10



9

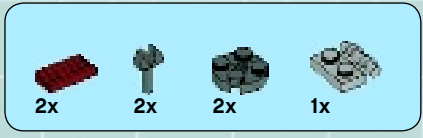

11

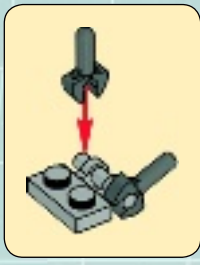
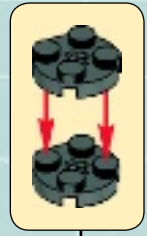

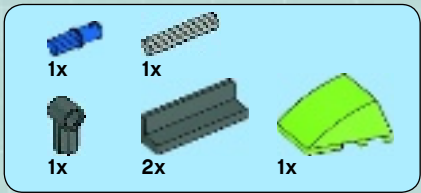

12

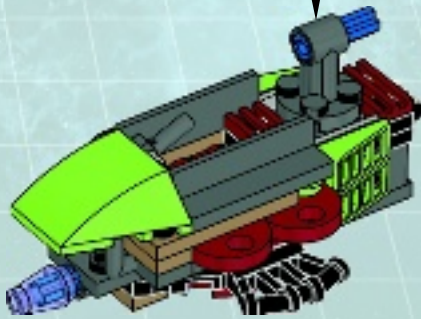
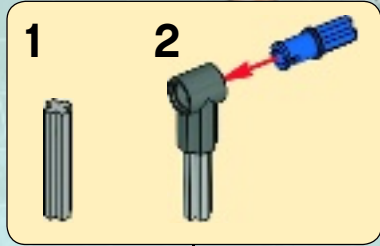

13

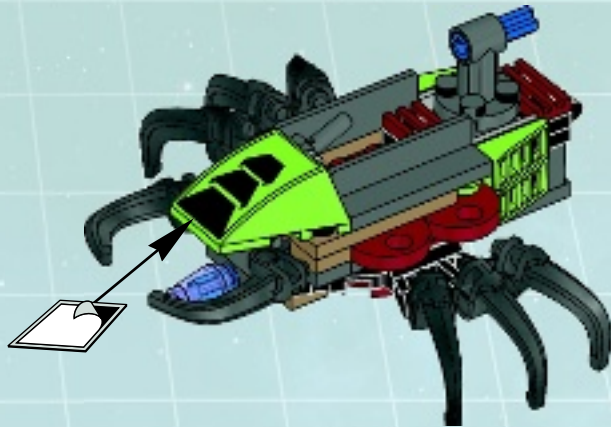

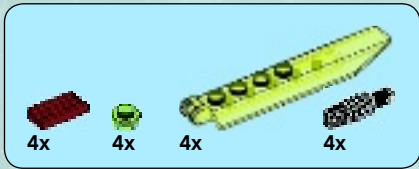

14

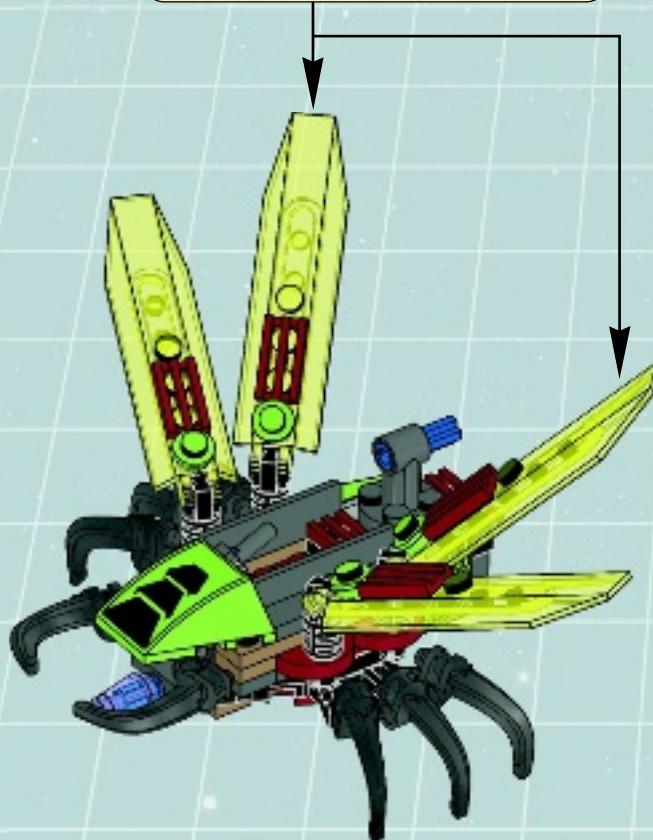
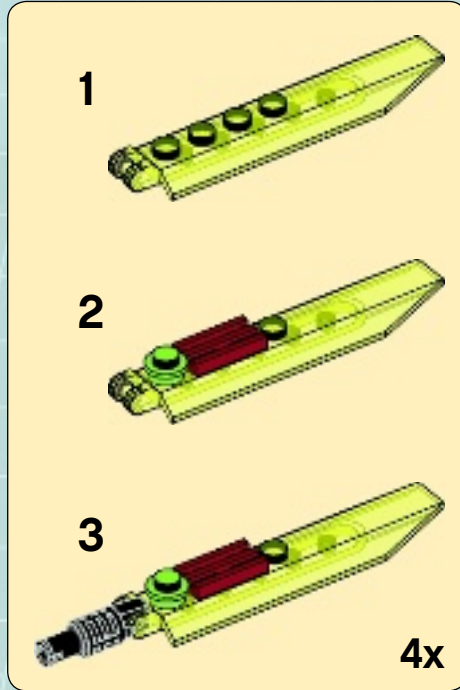

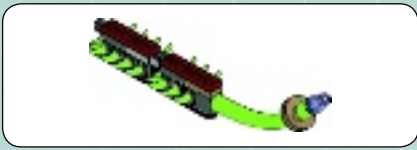

1

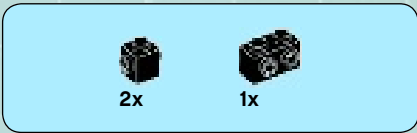

2

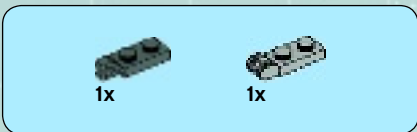
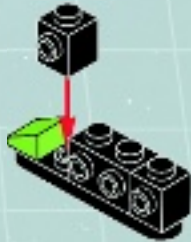

3



4

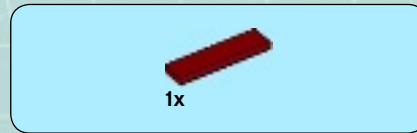

5



6

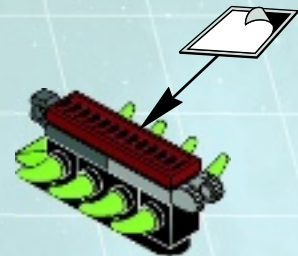

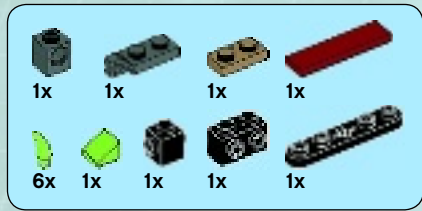

7

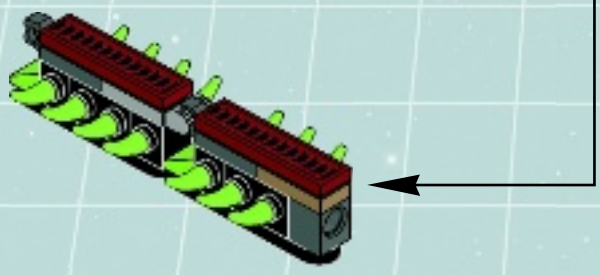
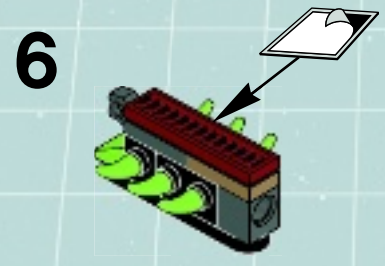
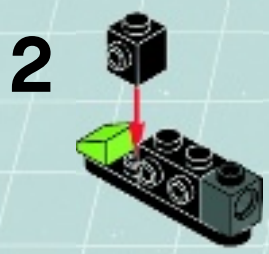

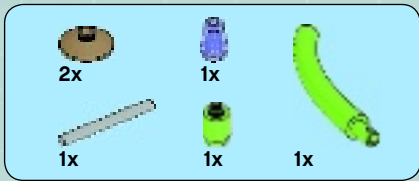

8

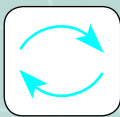
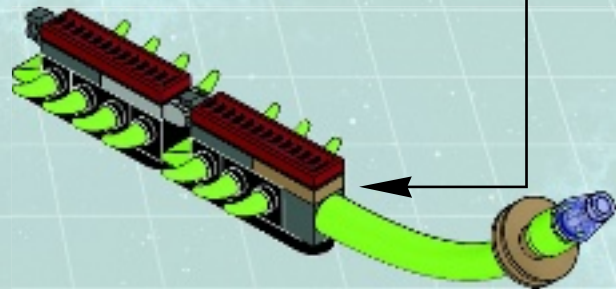
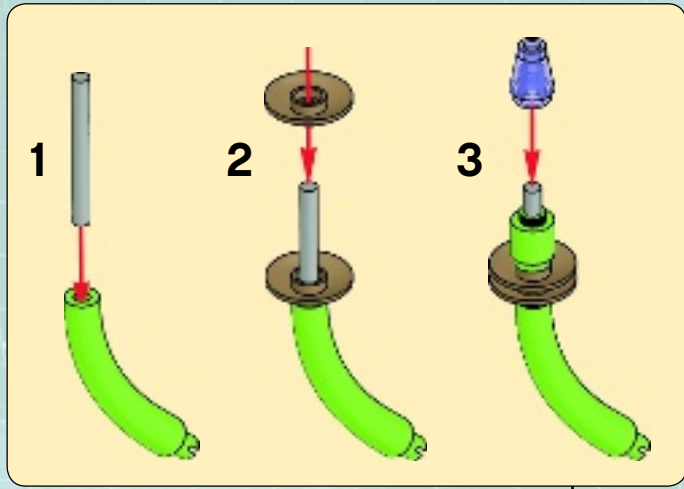

15

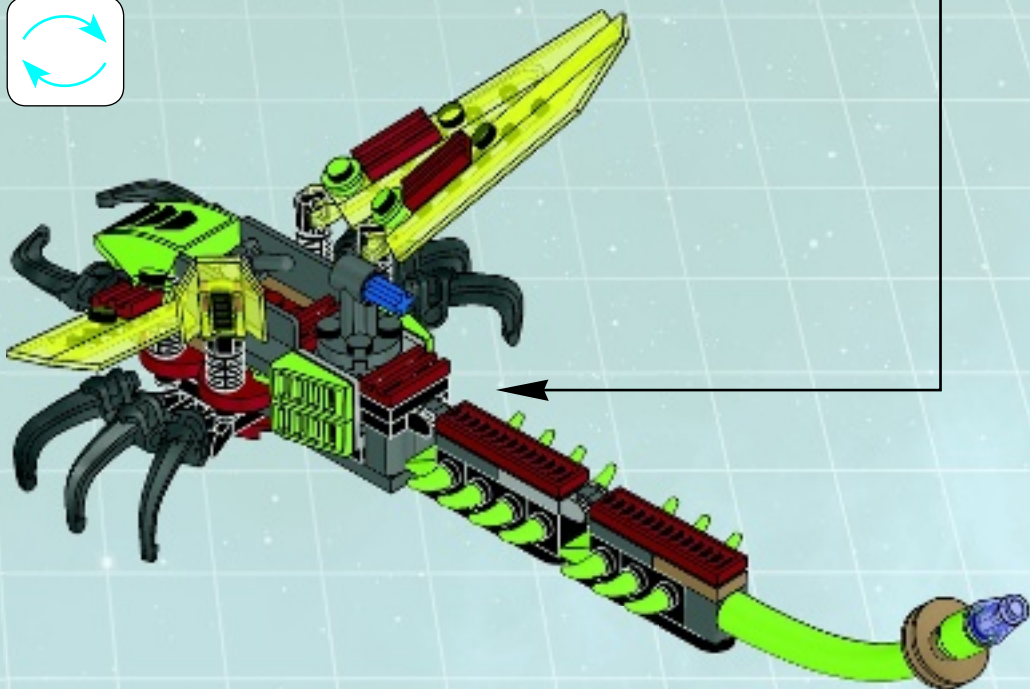



16

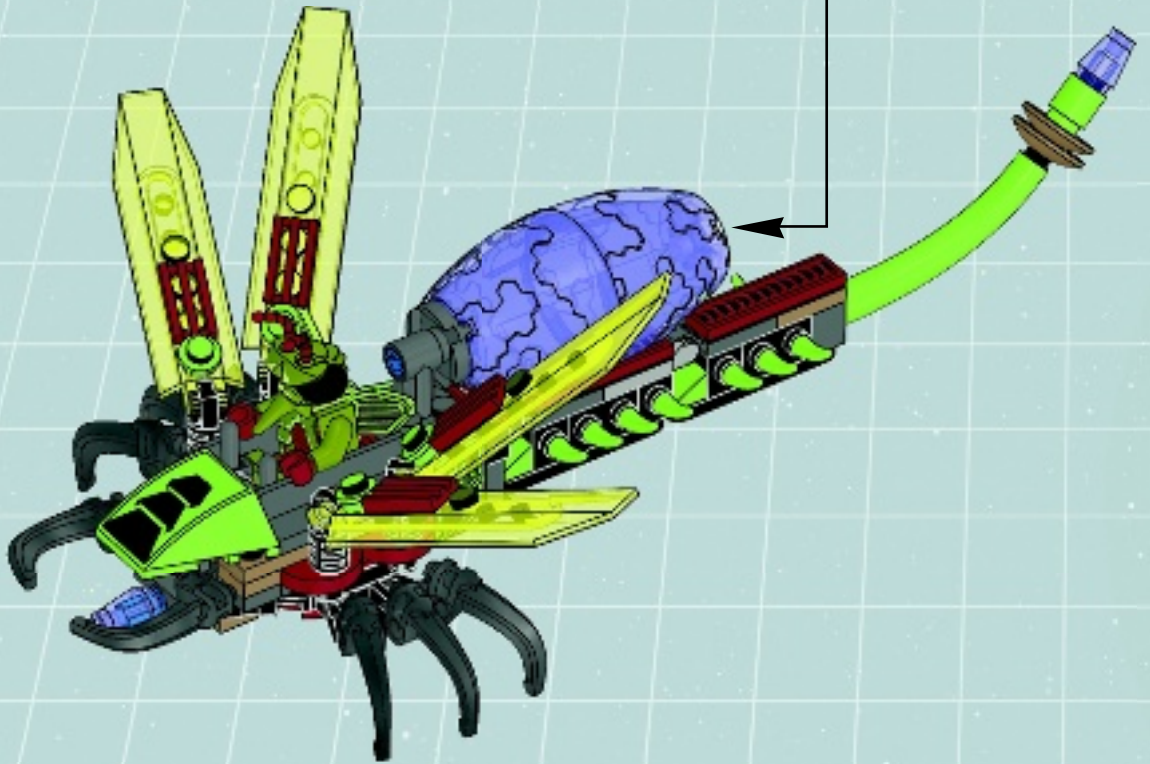
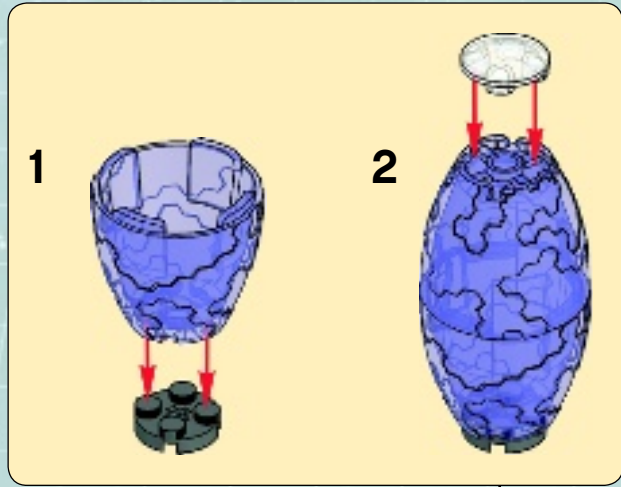

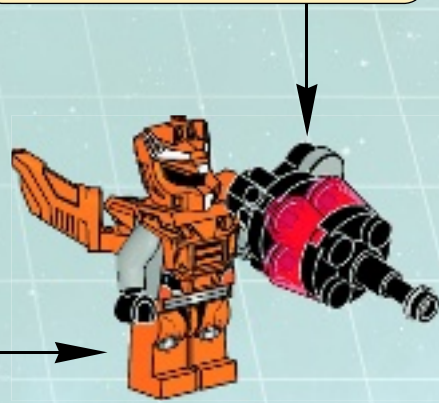
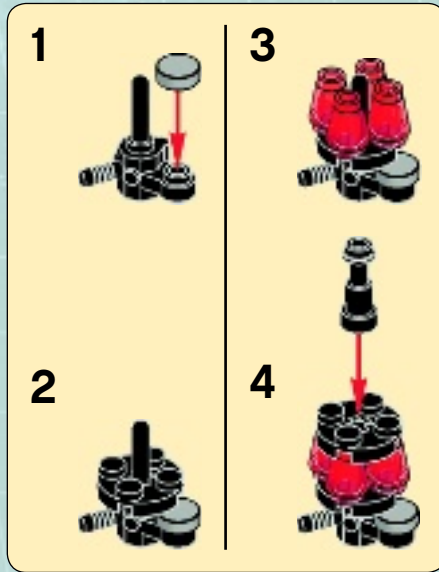
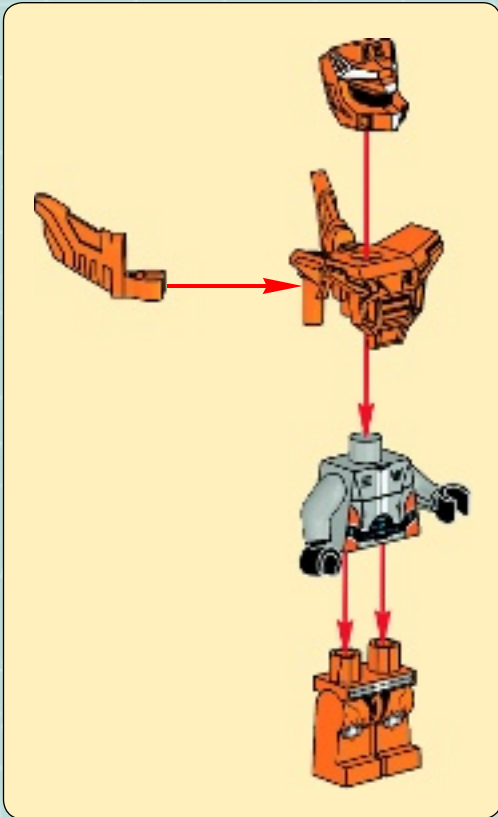
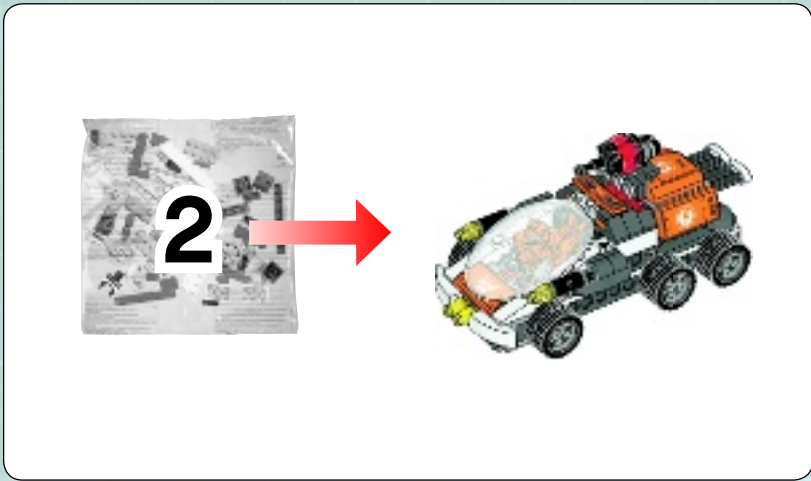

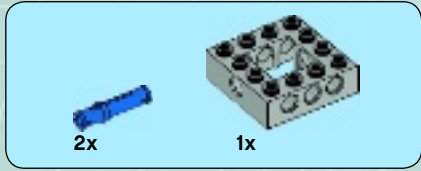

1

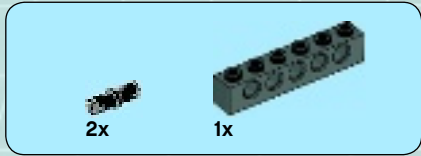
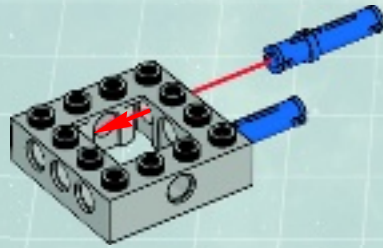

2

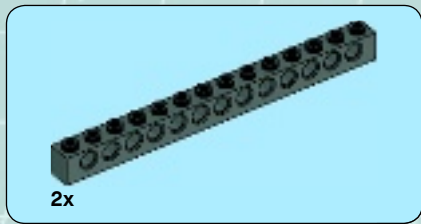

3

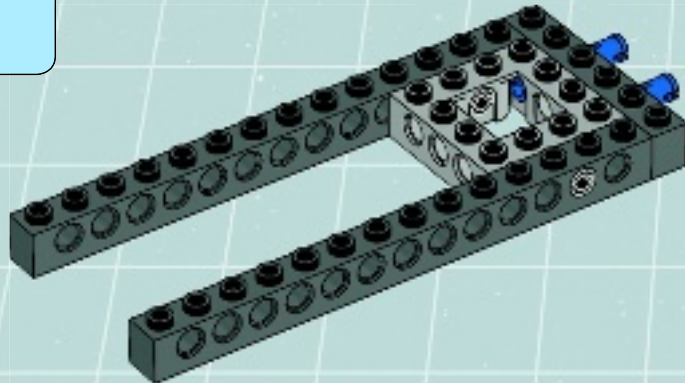

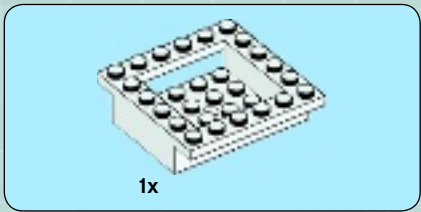

4

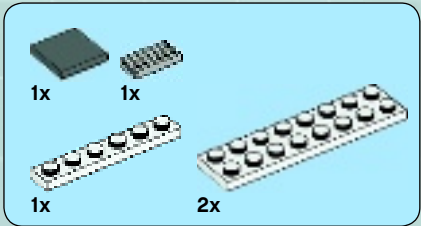
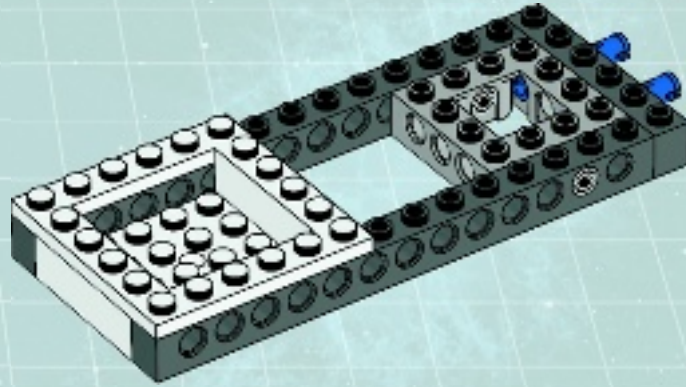

5

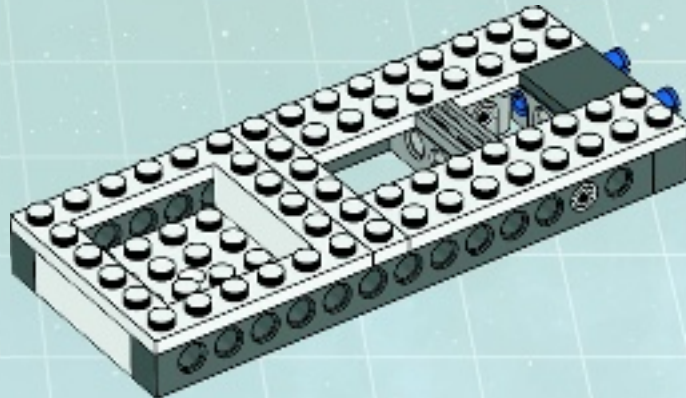

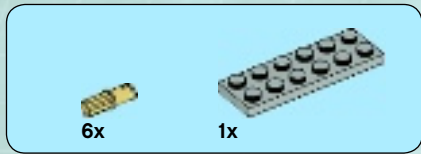

6

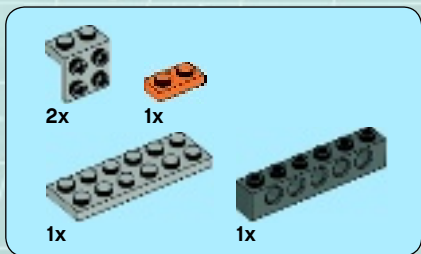
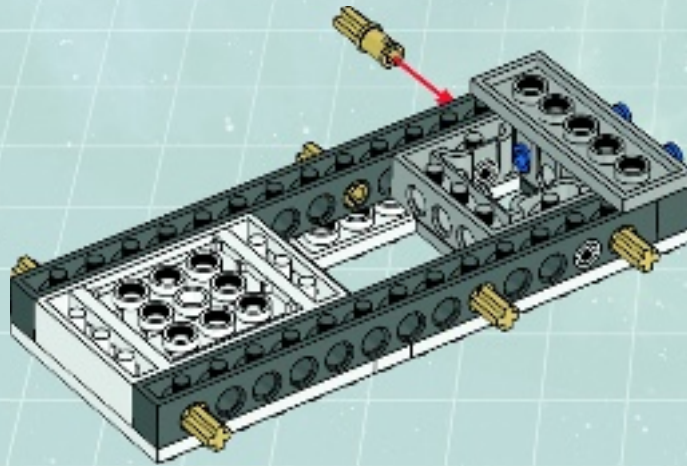
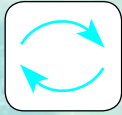

7

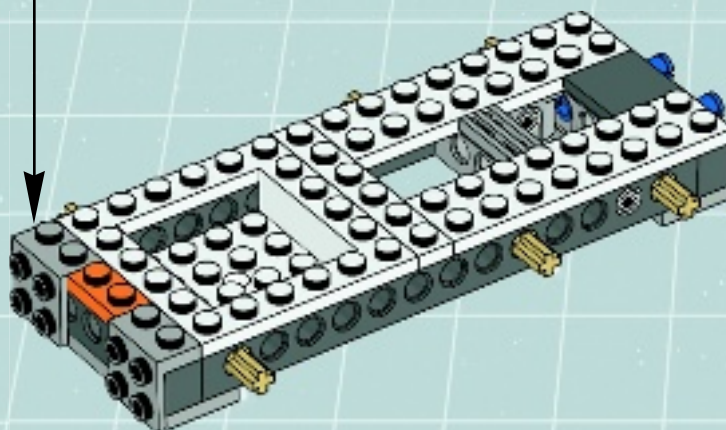
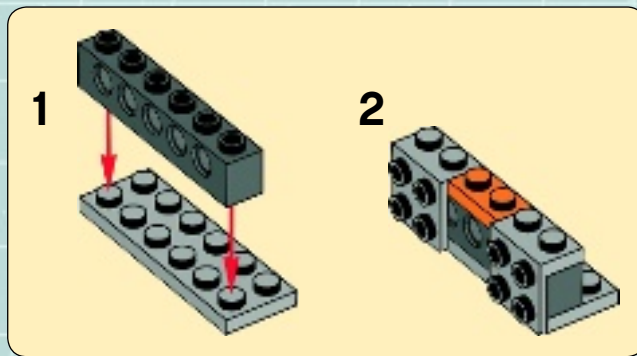
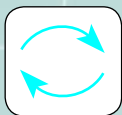

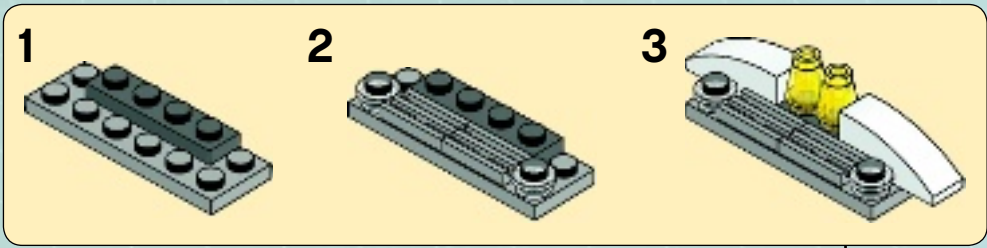
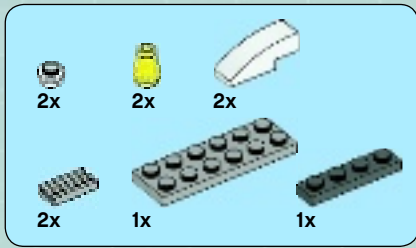

8

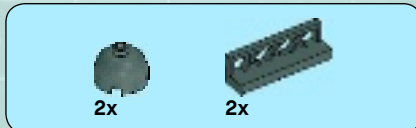
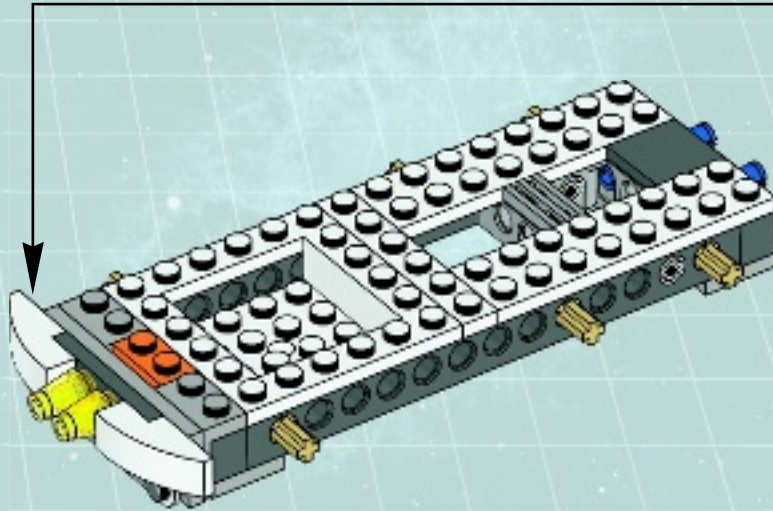

9

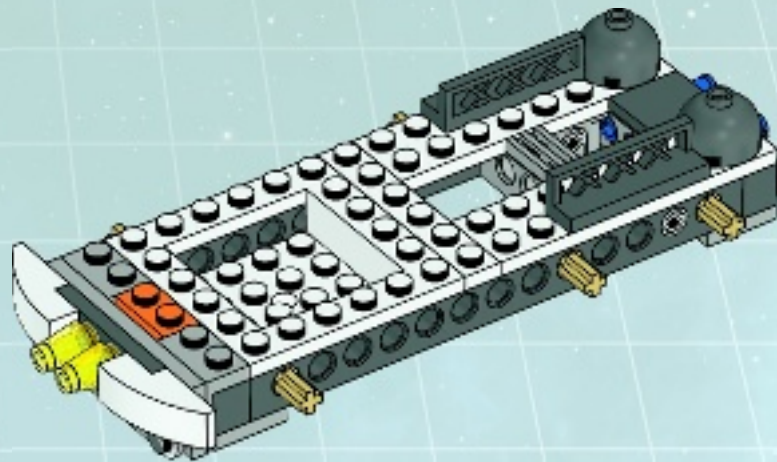

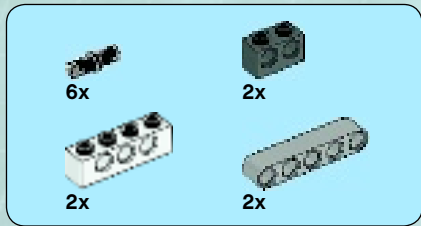

10

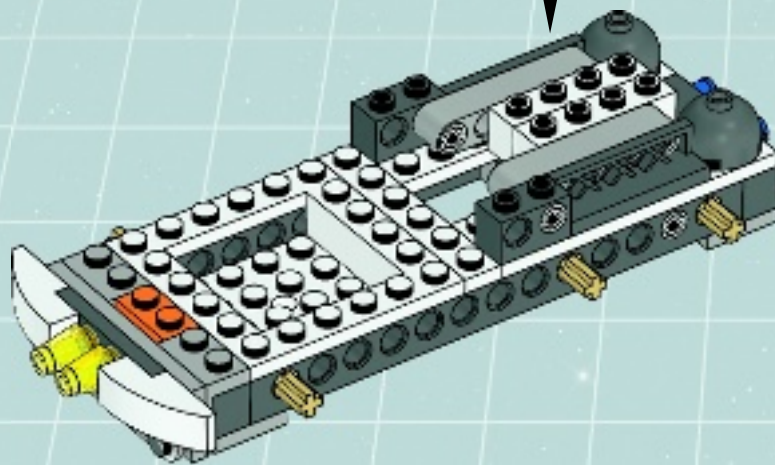
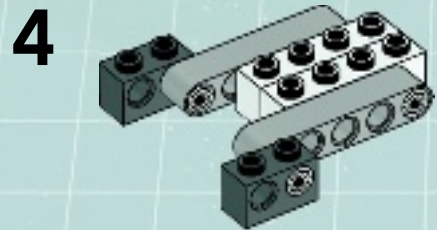
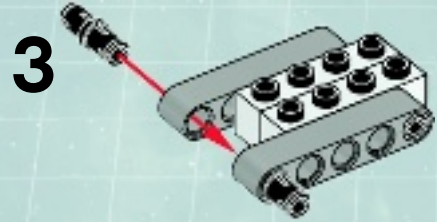
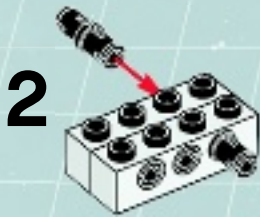



11

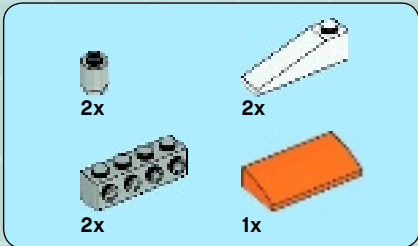
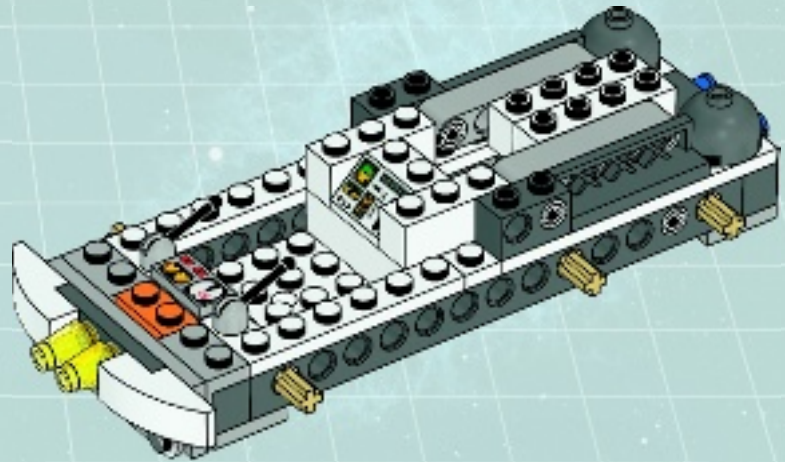

12

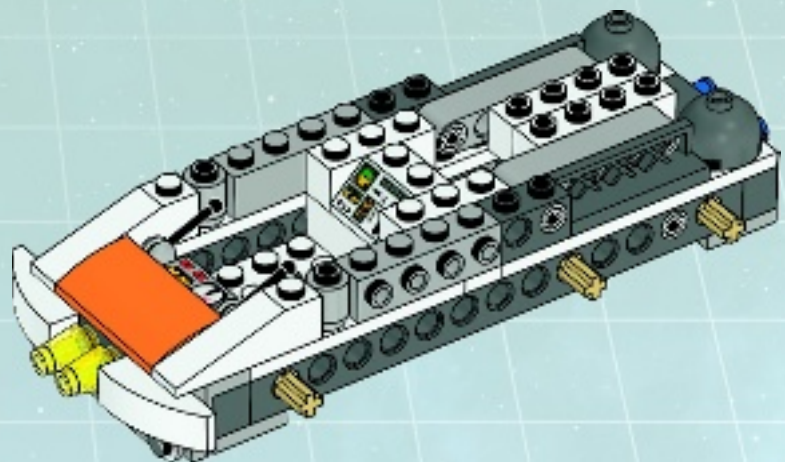

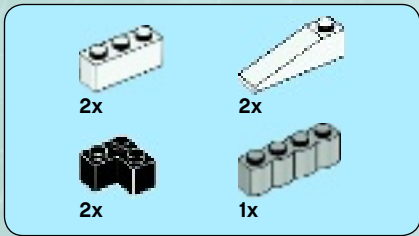

13

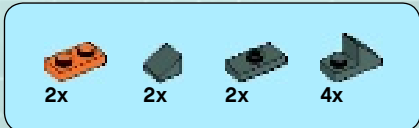
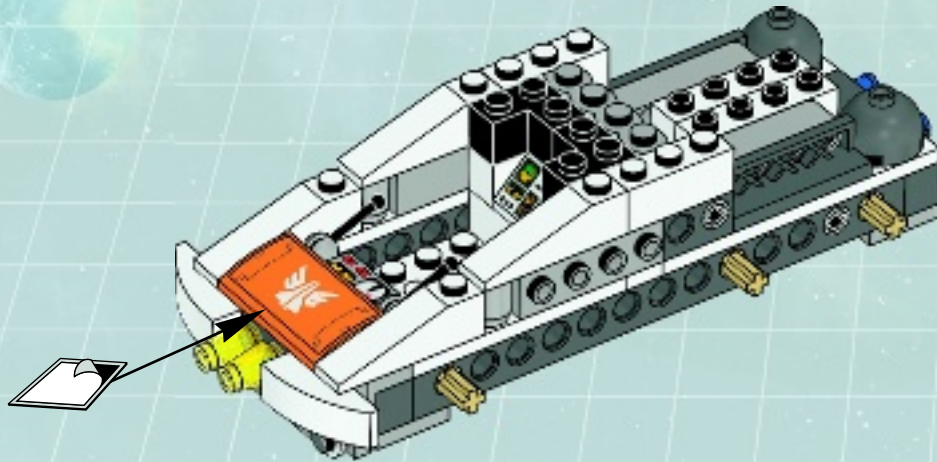

14

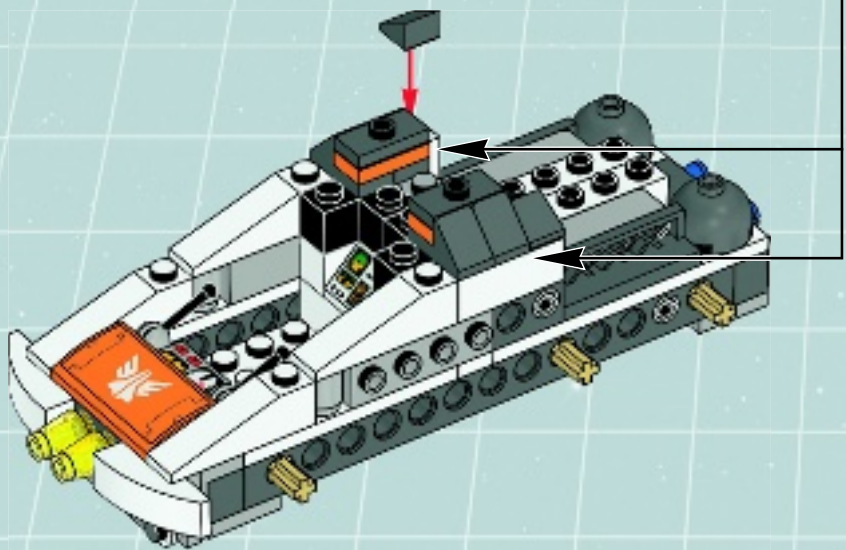



15

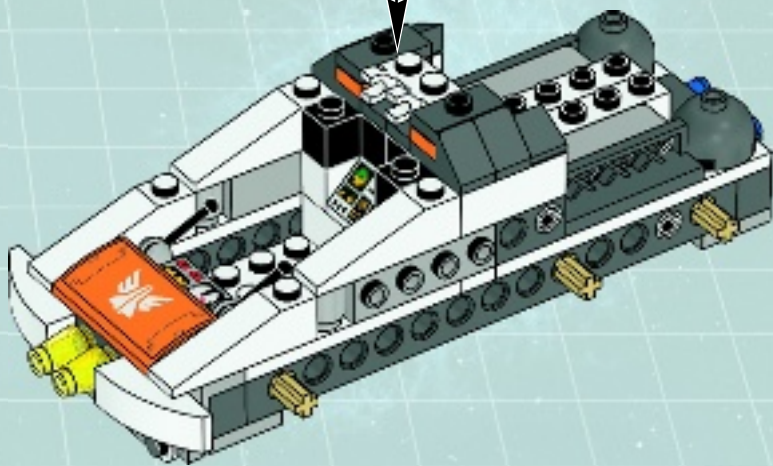

16

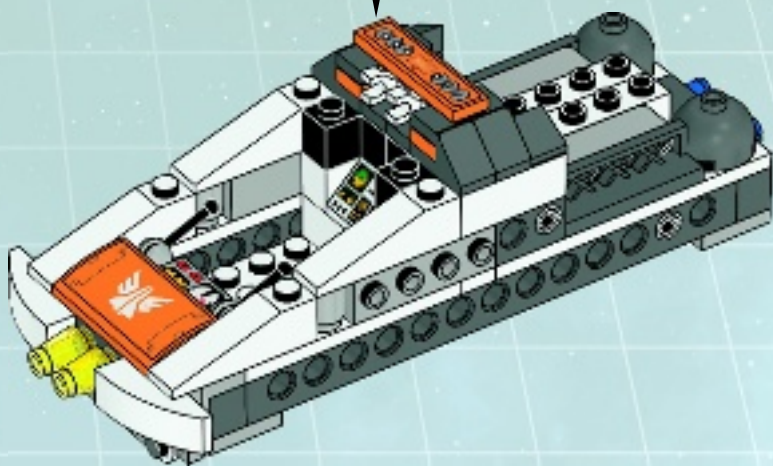
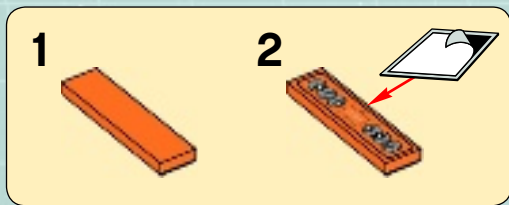



1x

1



2x

2



2x



2x



4x

3

1

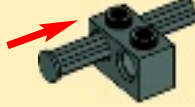

2

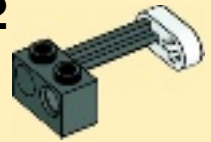

3

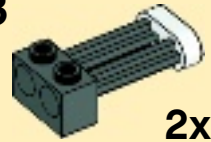

2x

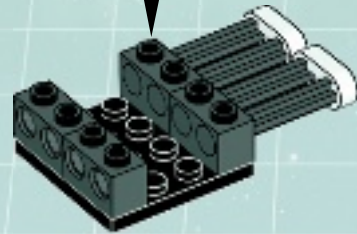

2x



4x

4



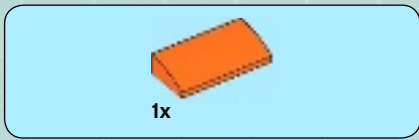

5

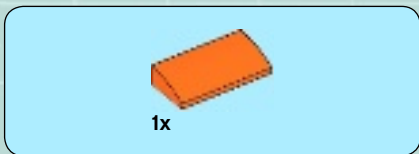
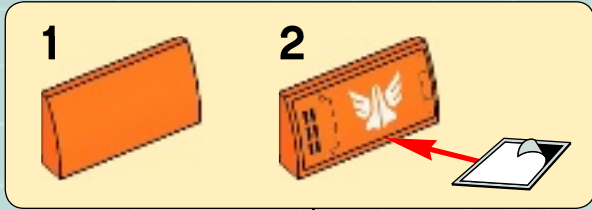

6

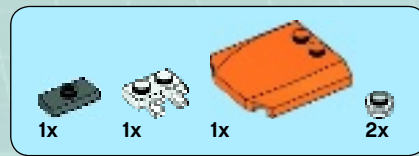
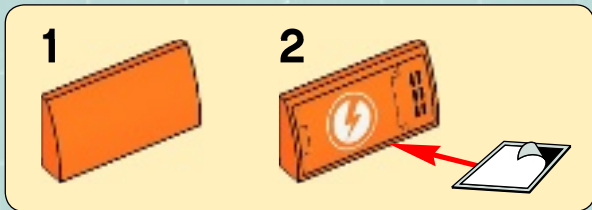

7

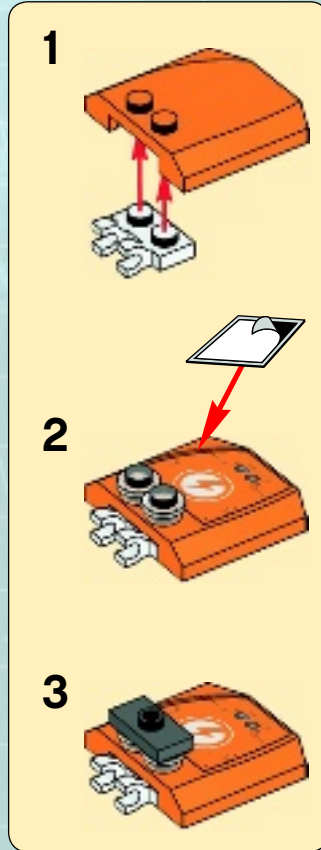

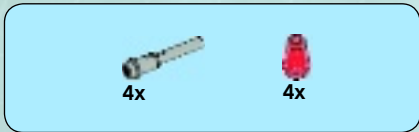

8

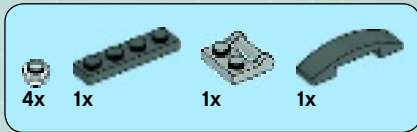
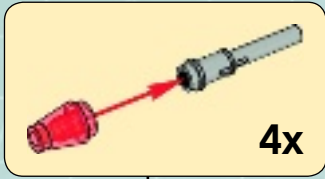

9

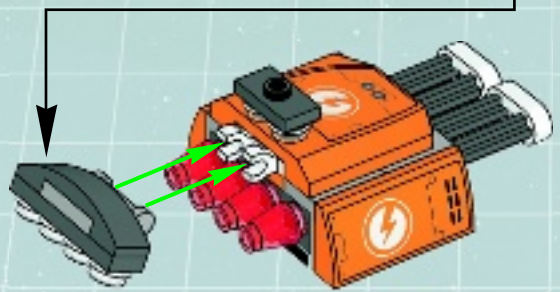
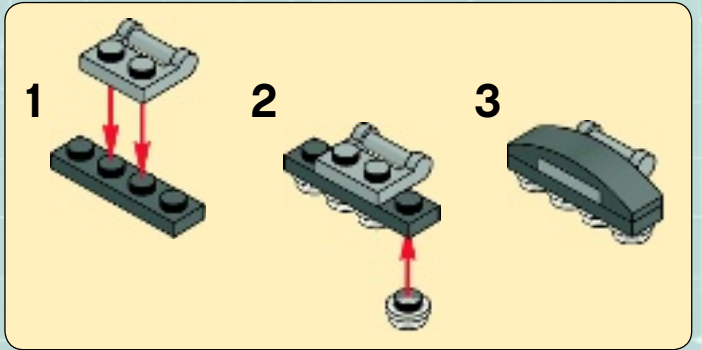

17

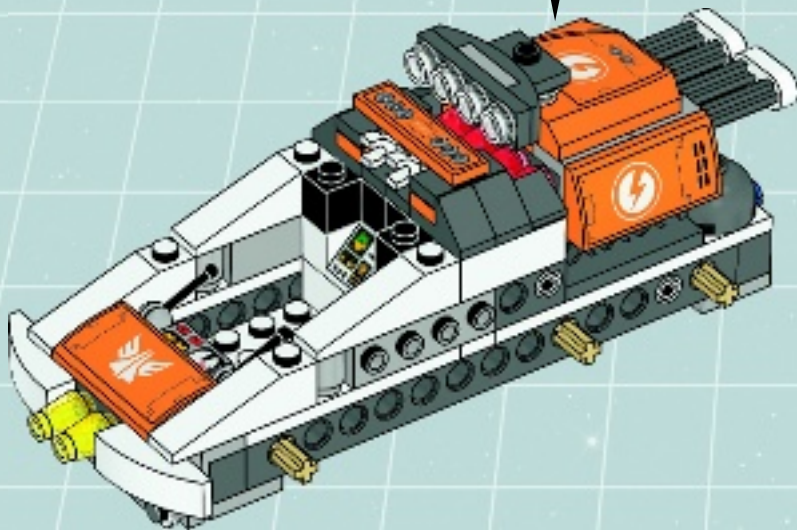



18

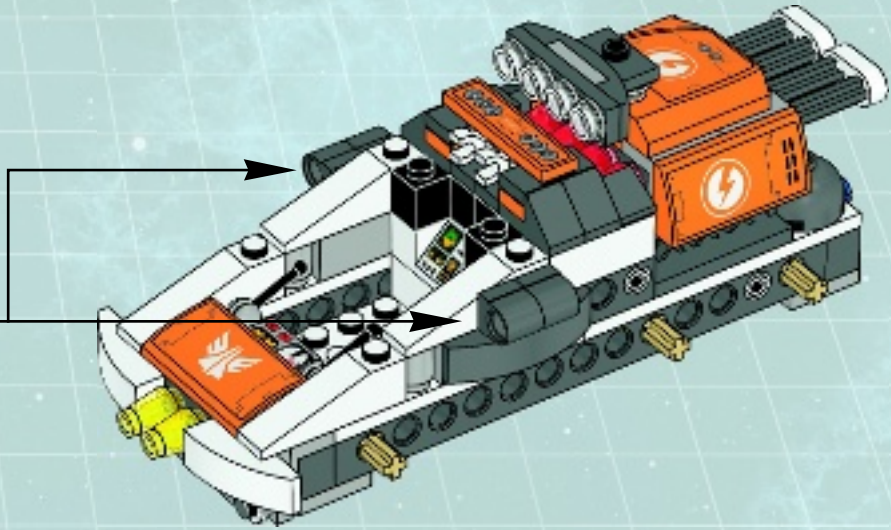
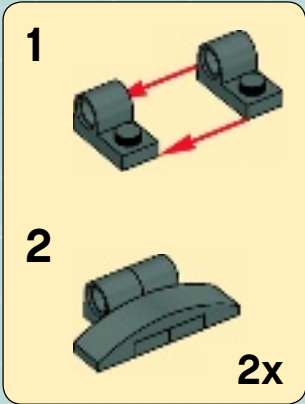

19

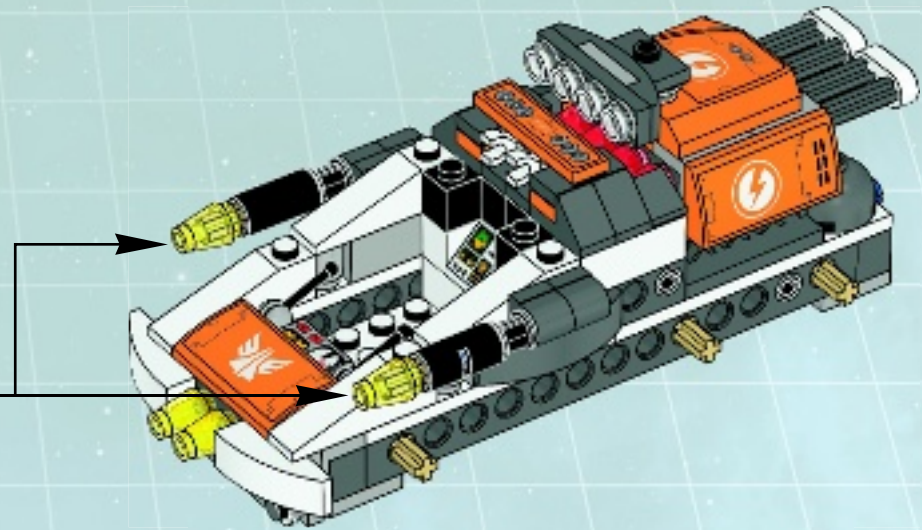
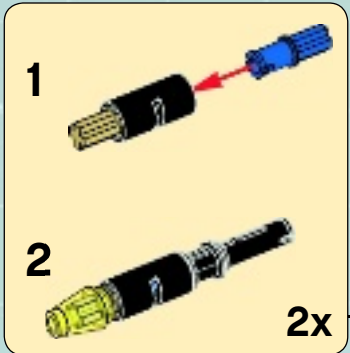



1x

20

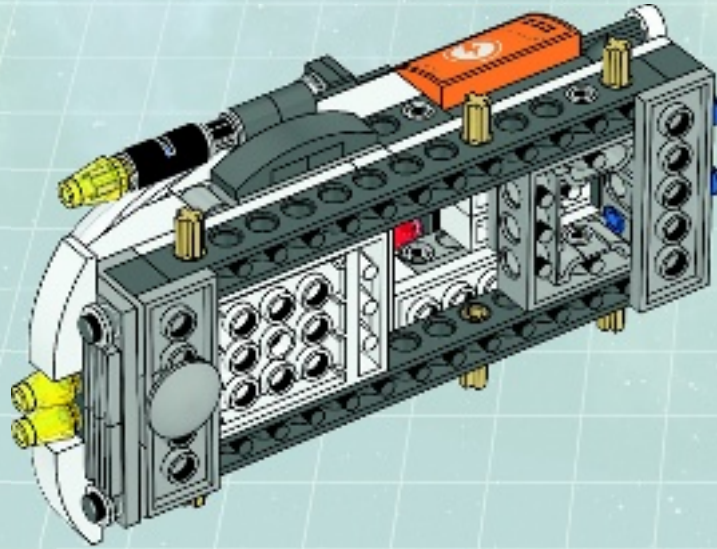
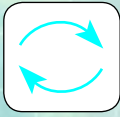

1x

21

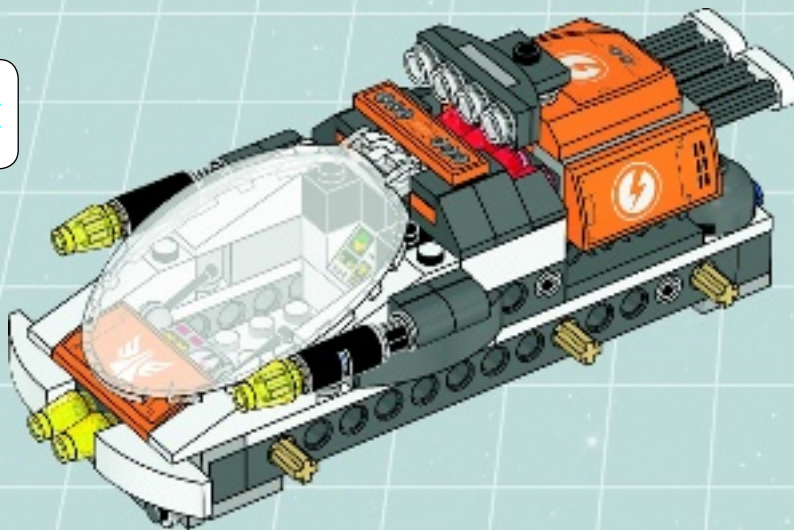
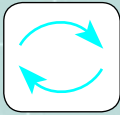

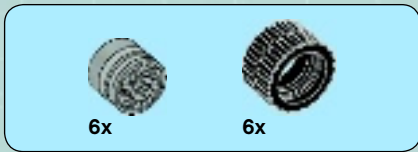

22

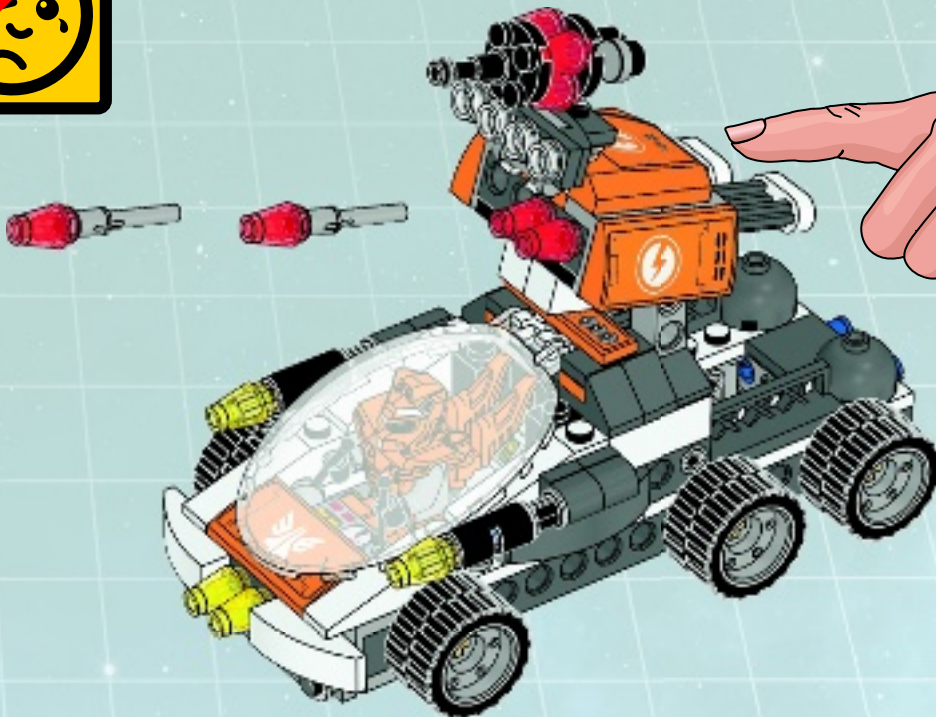
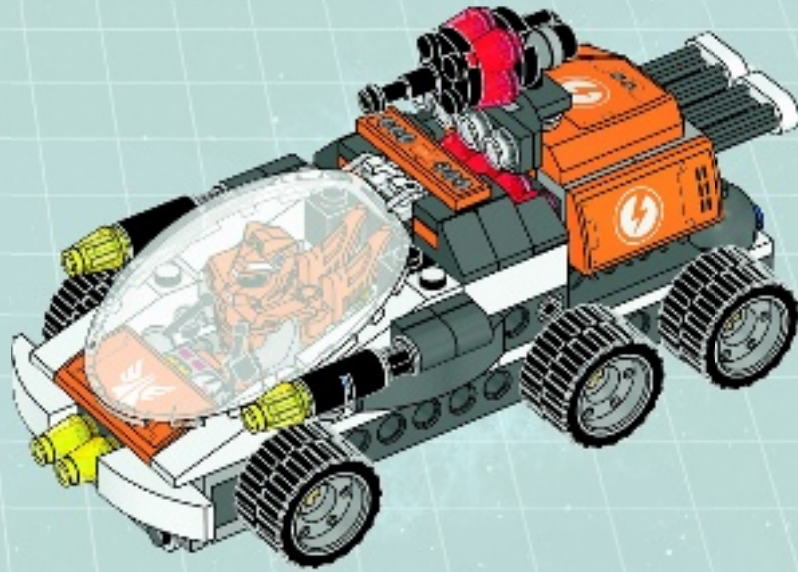

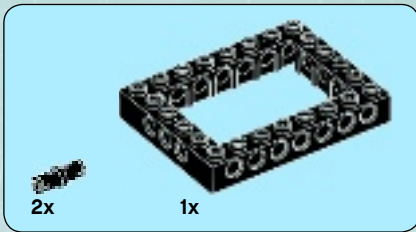

1

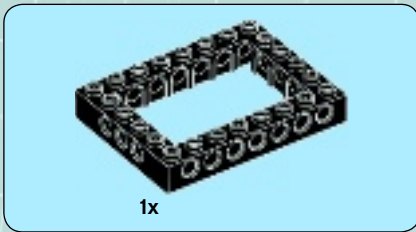
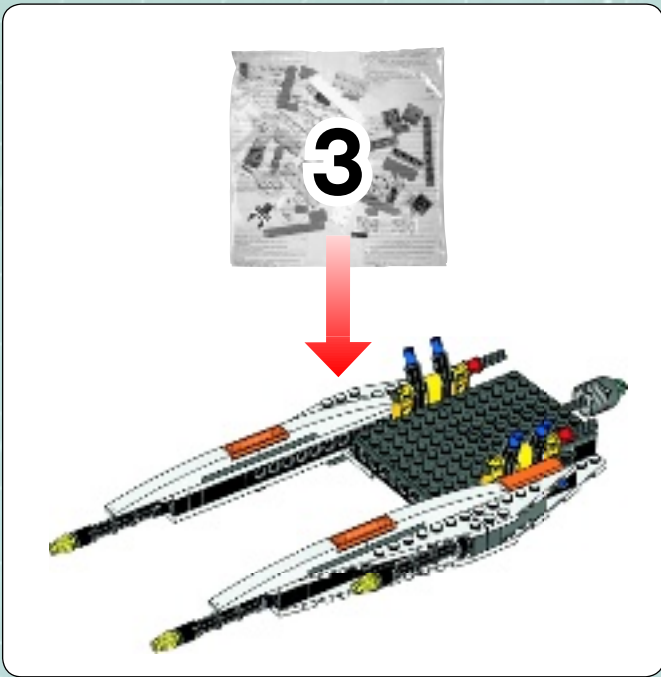
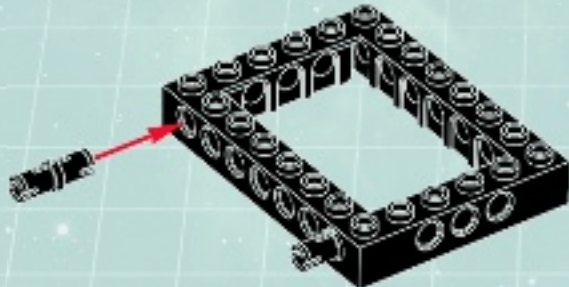

2

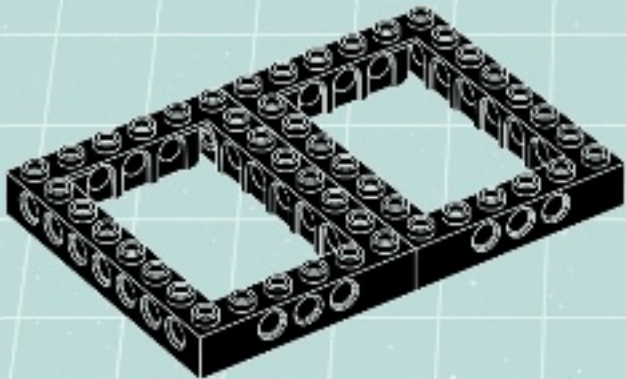

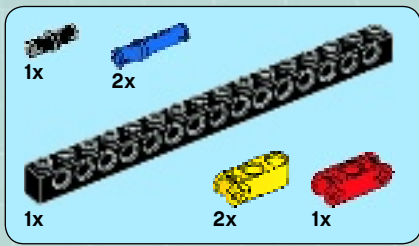

3

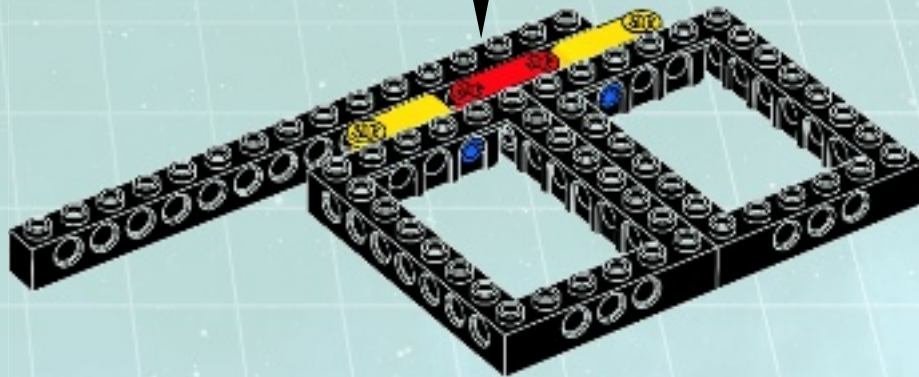
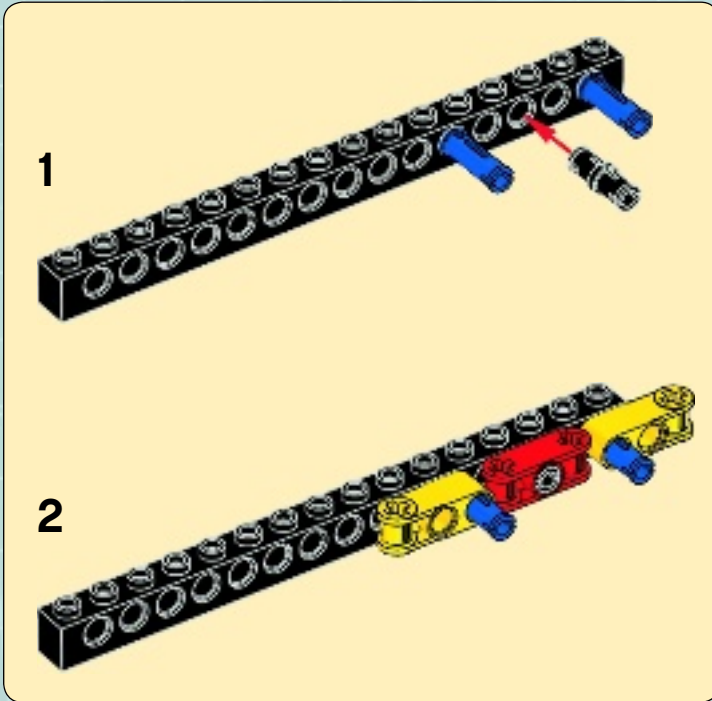

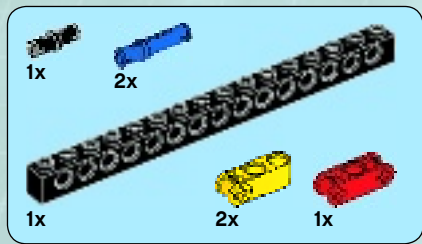

4

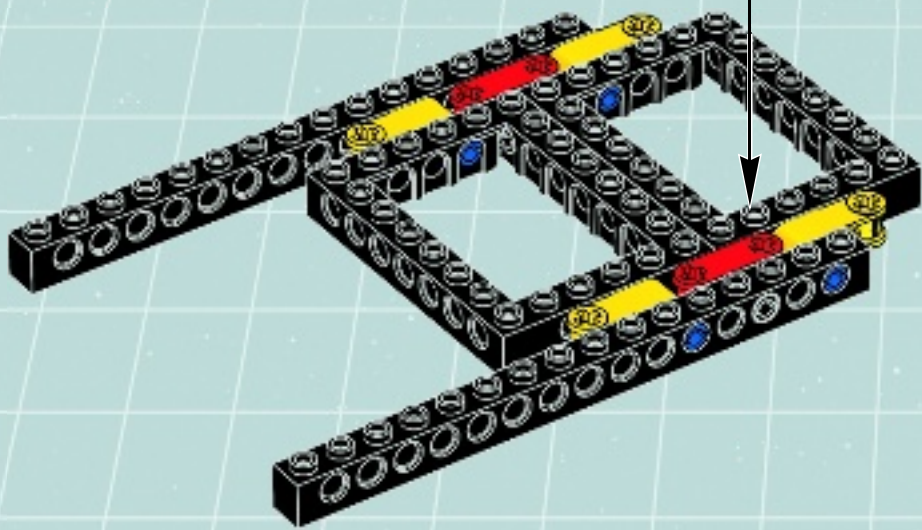
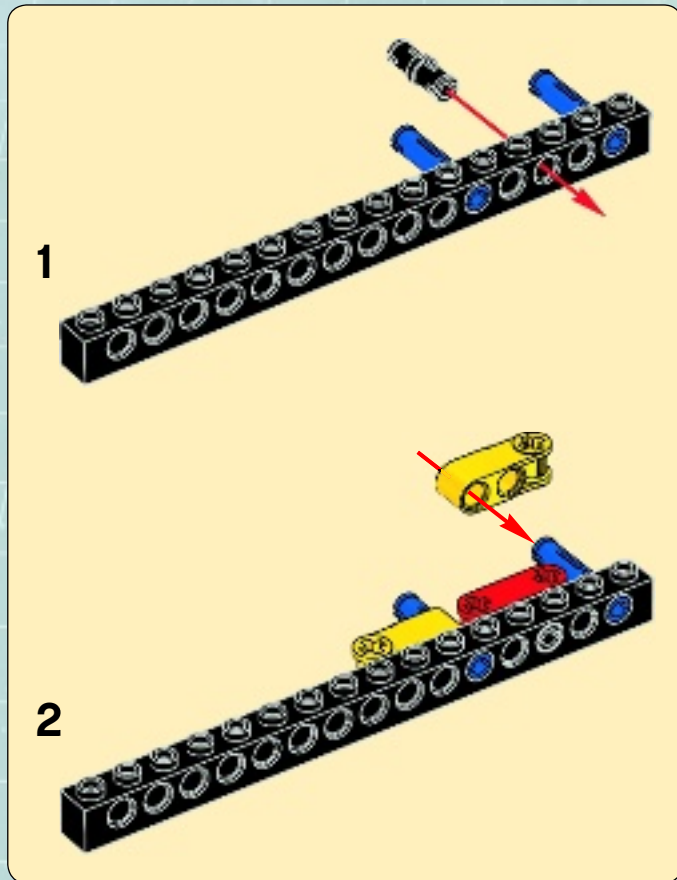

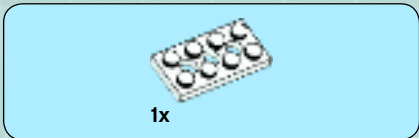

5

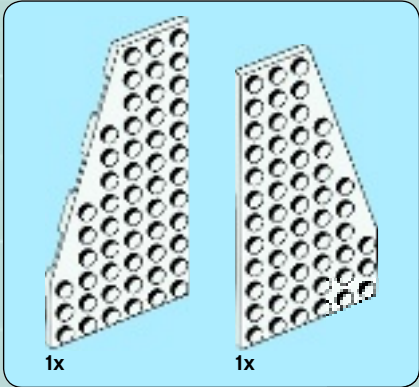
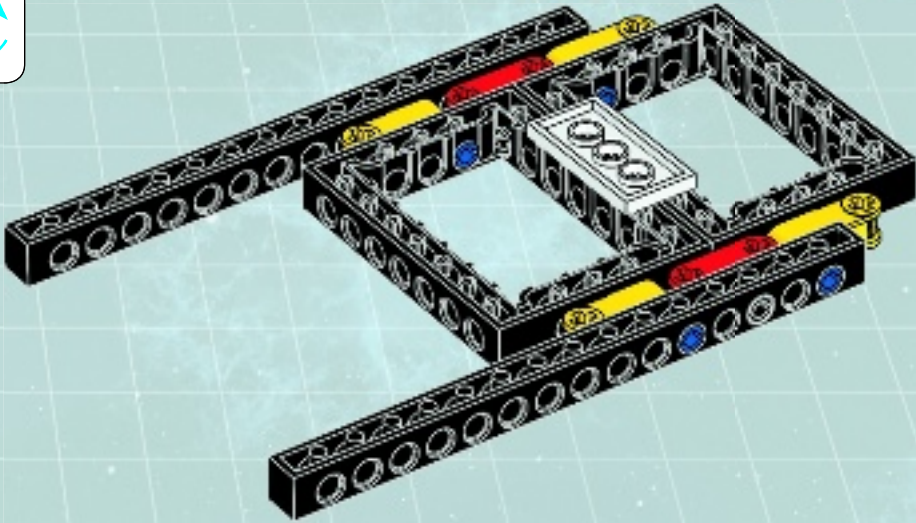

6

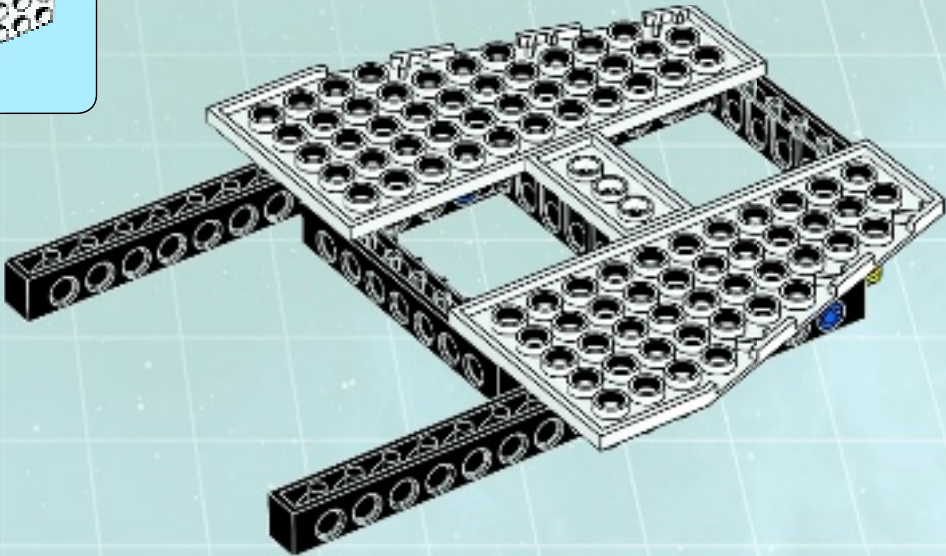

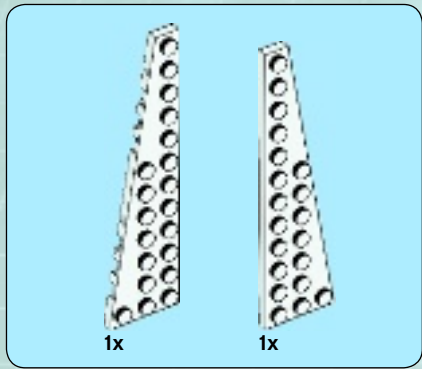

7

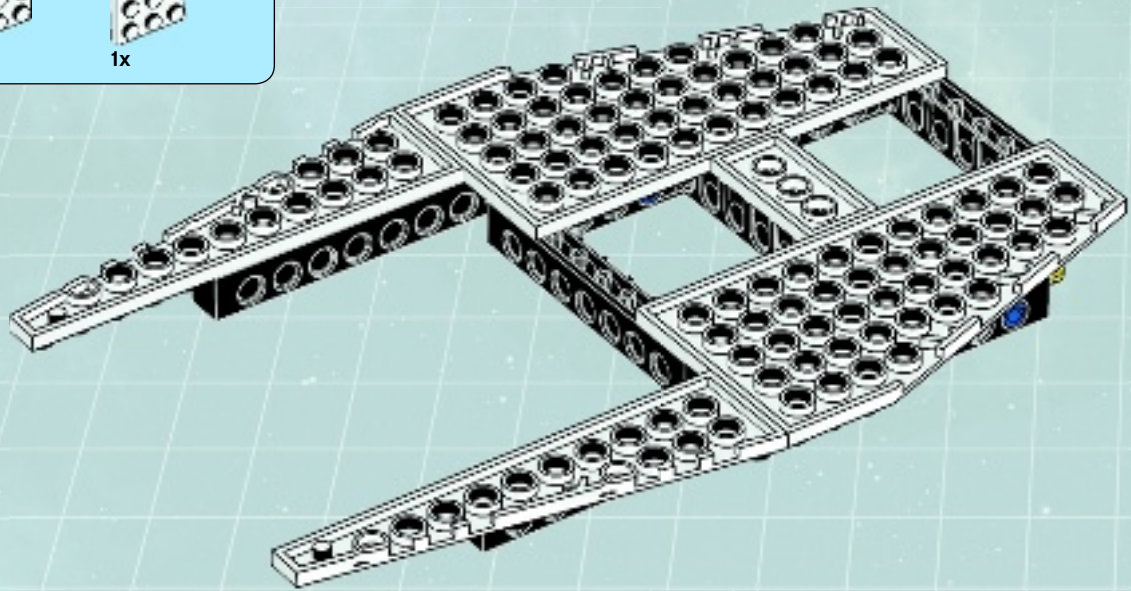

8

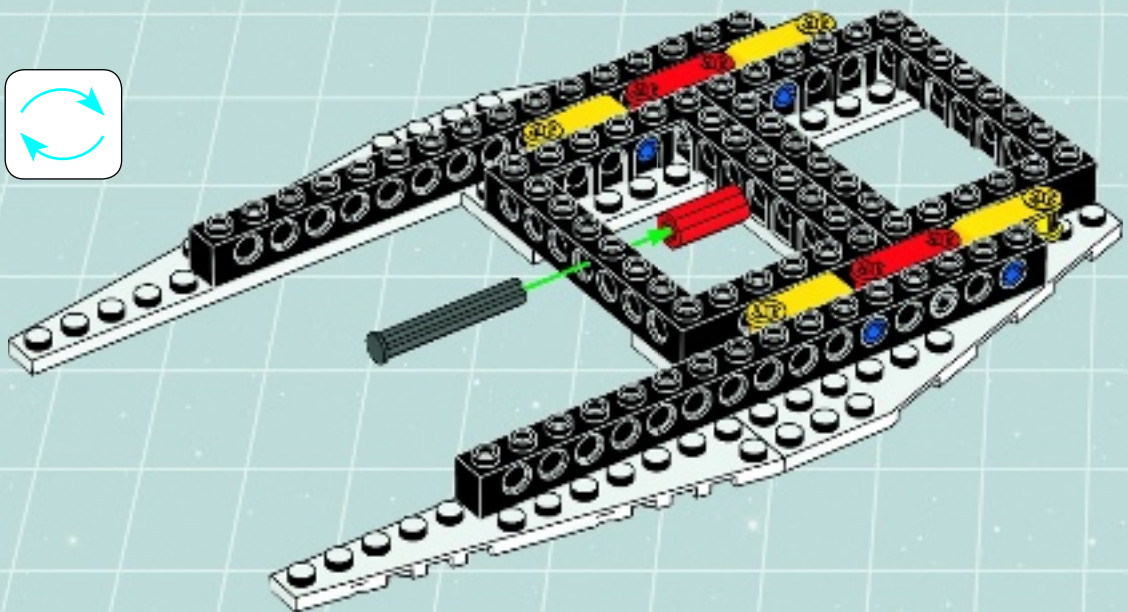
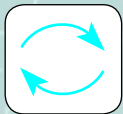

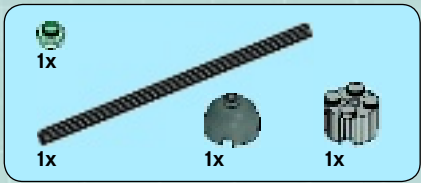

9

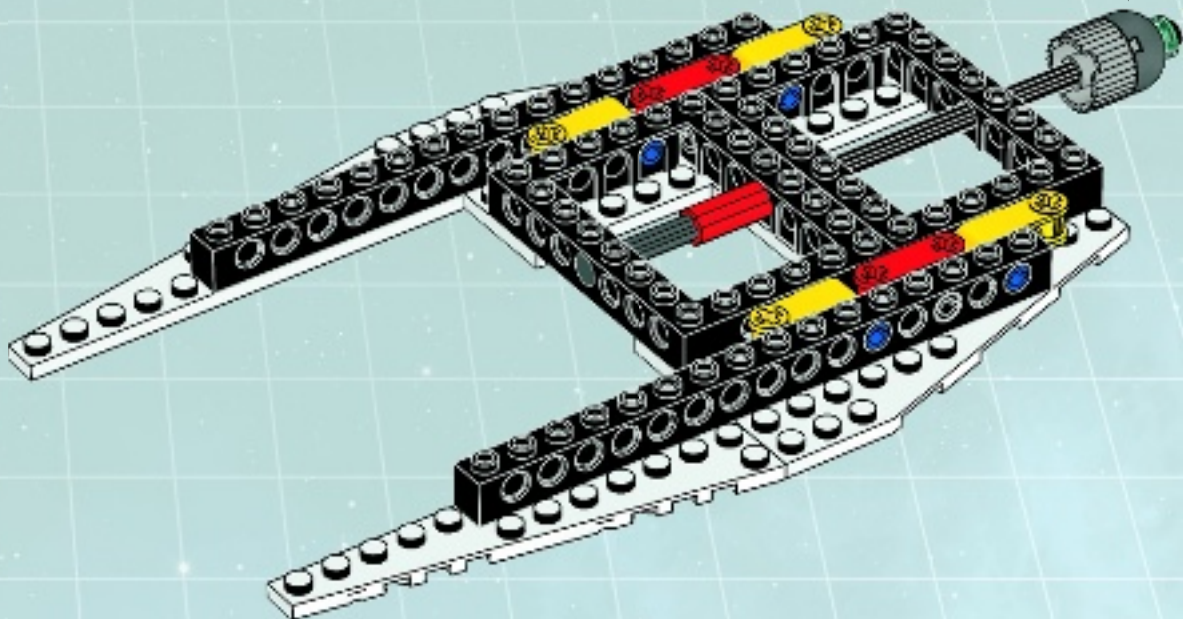
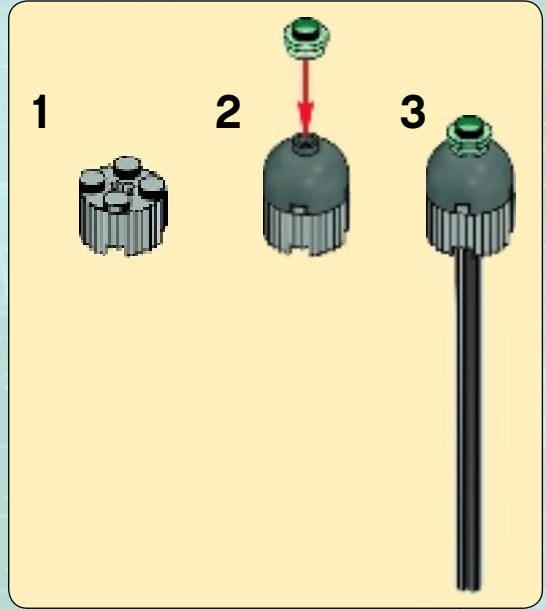



8x

10

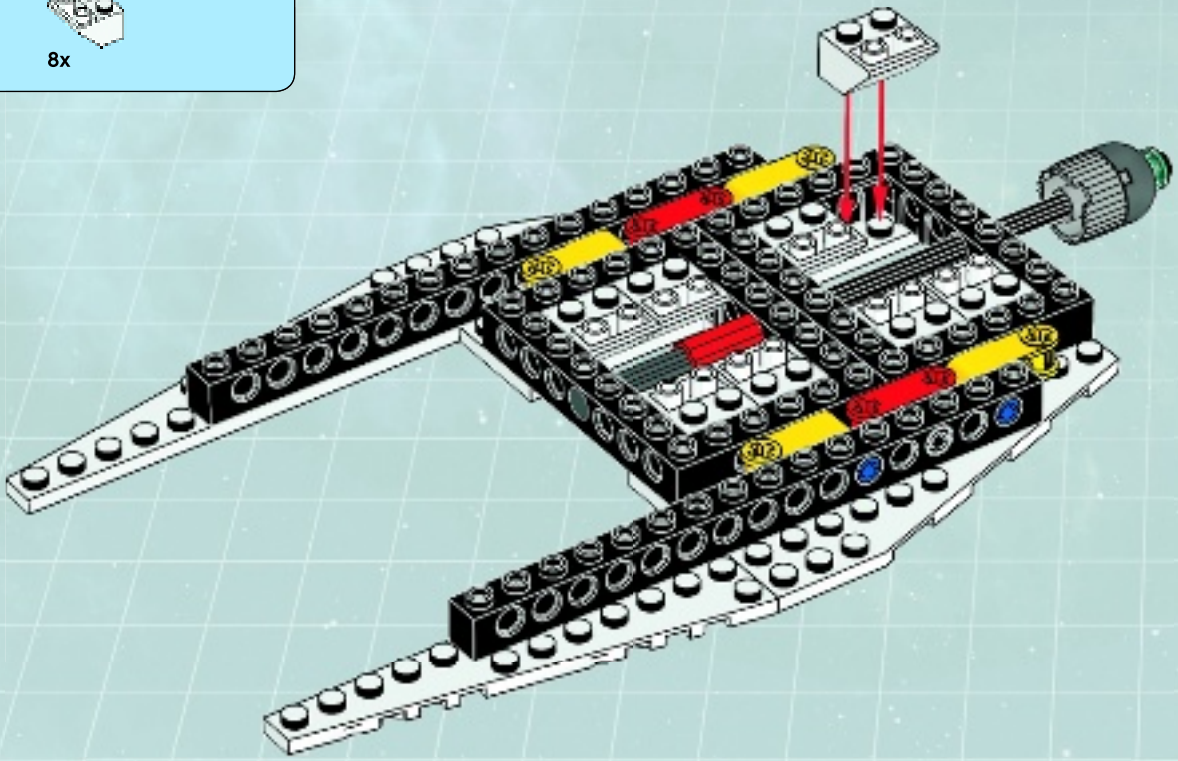

2x



4x

11

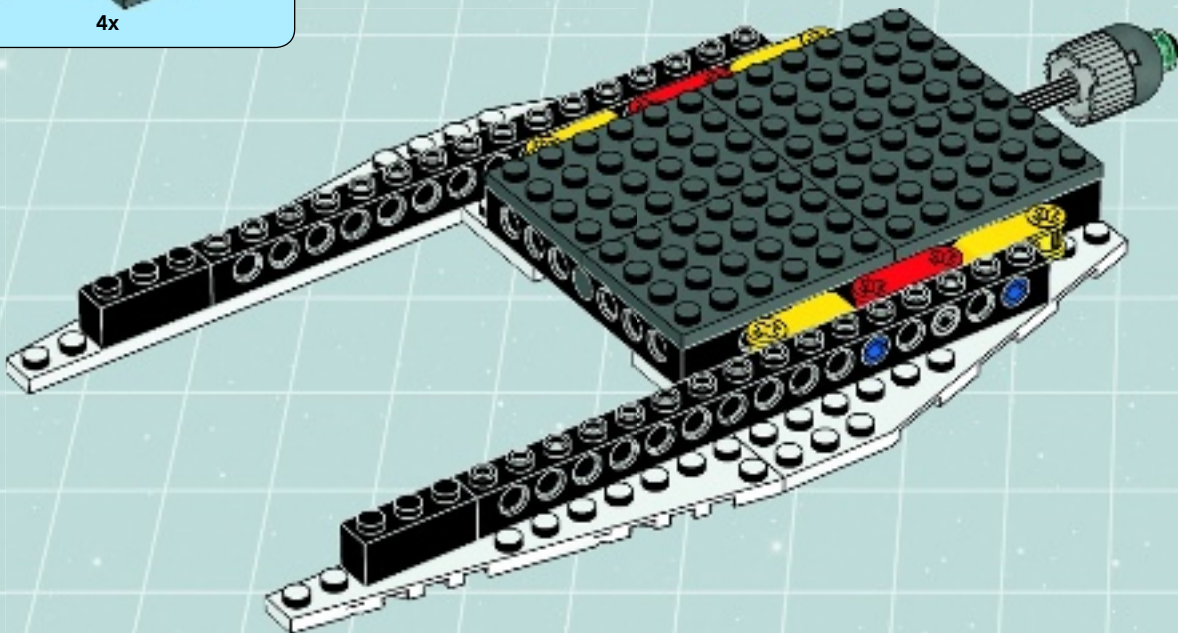

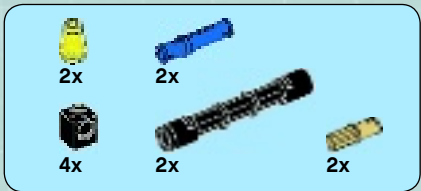

12

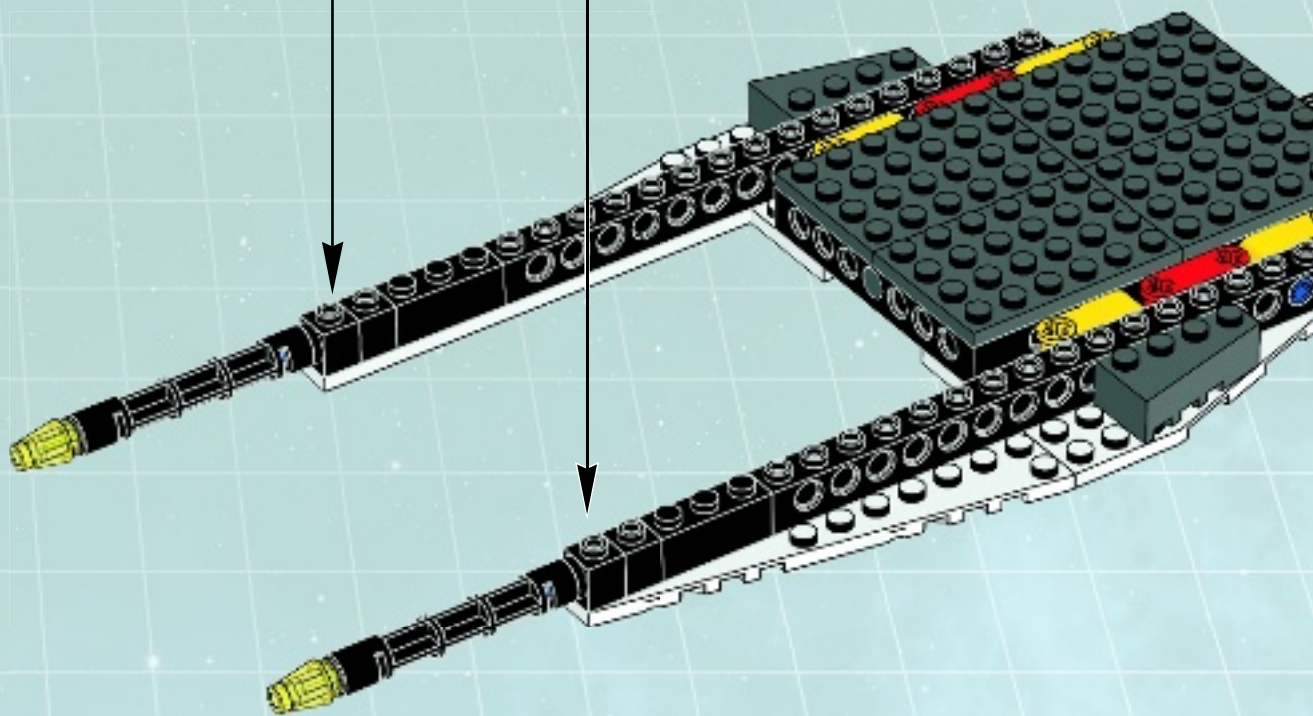
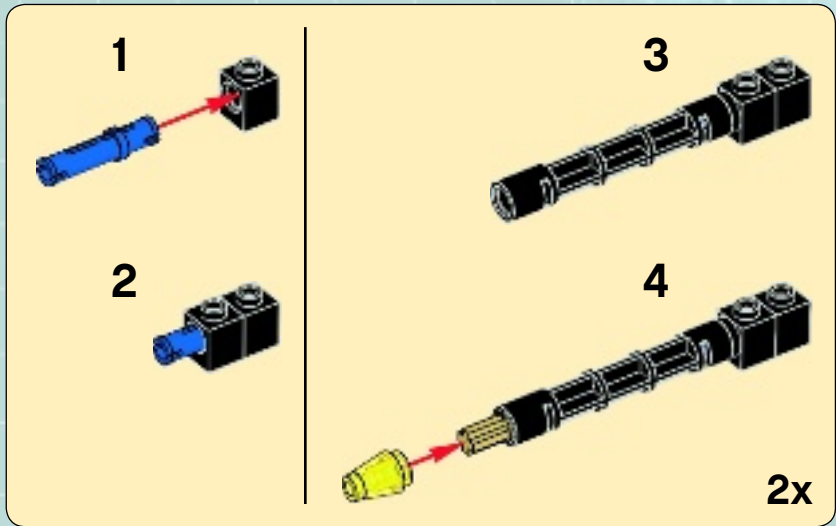

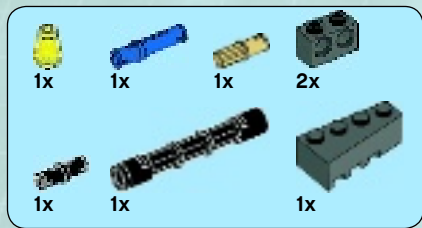

13

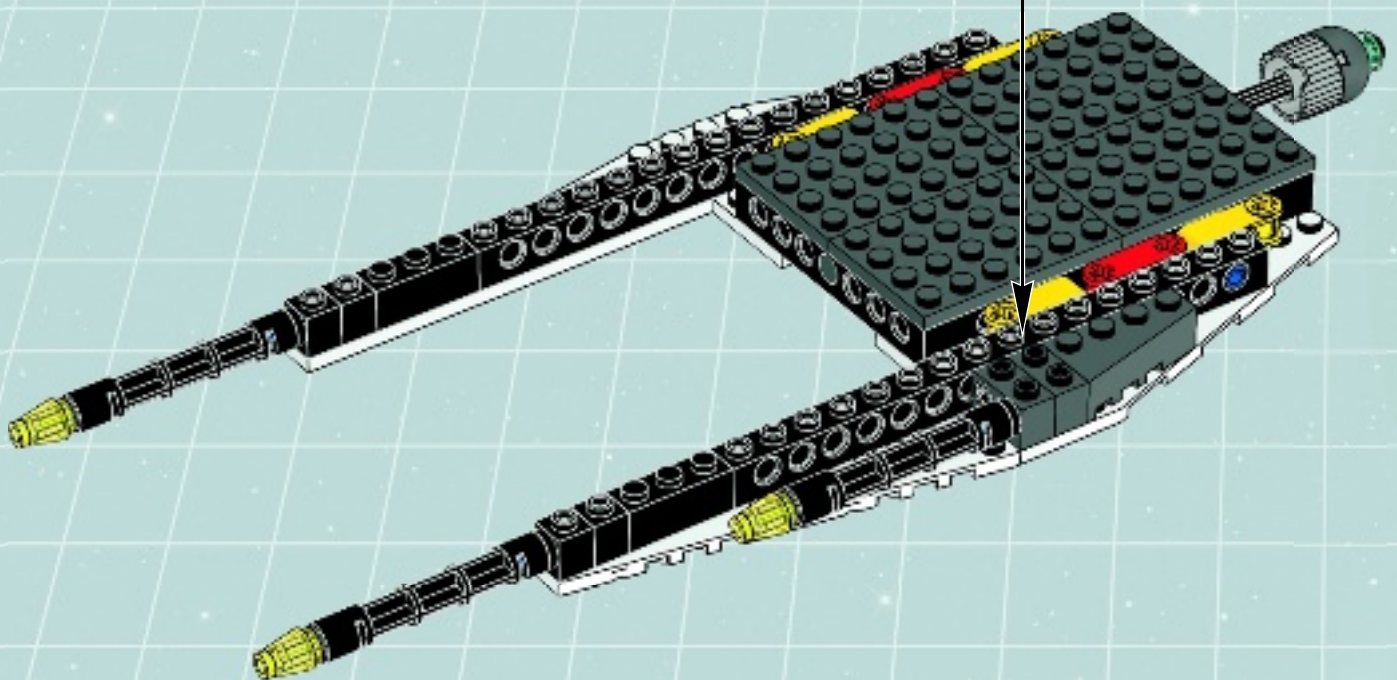
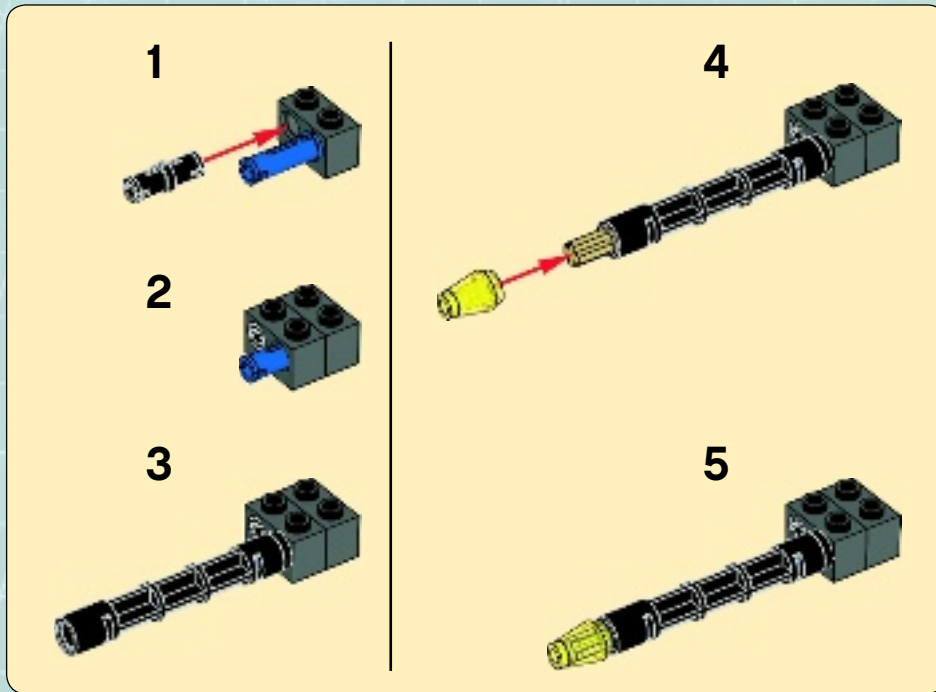

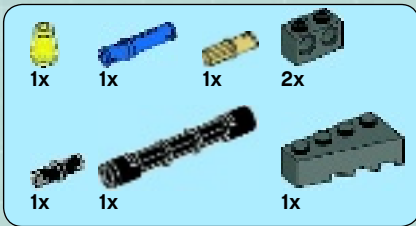

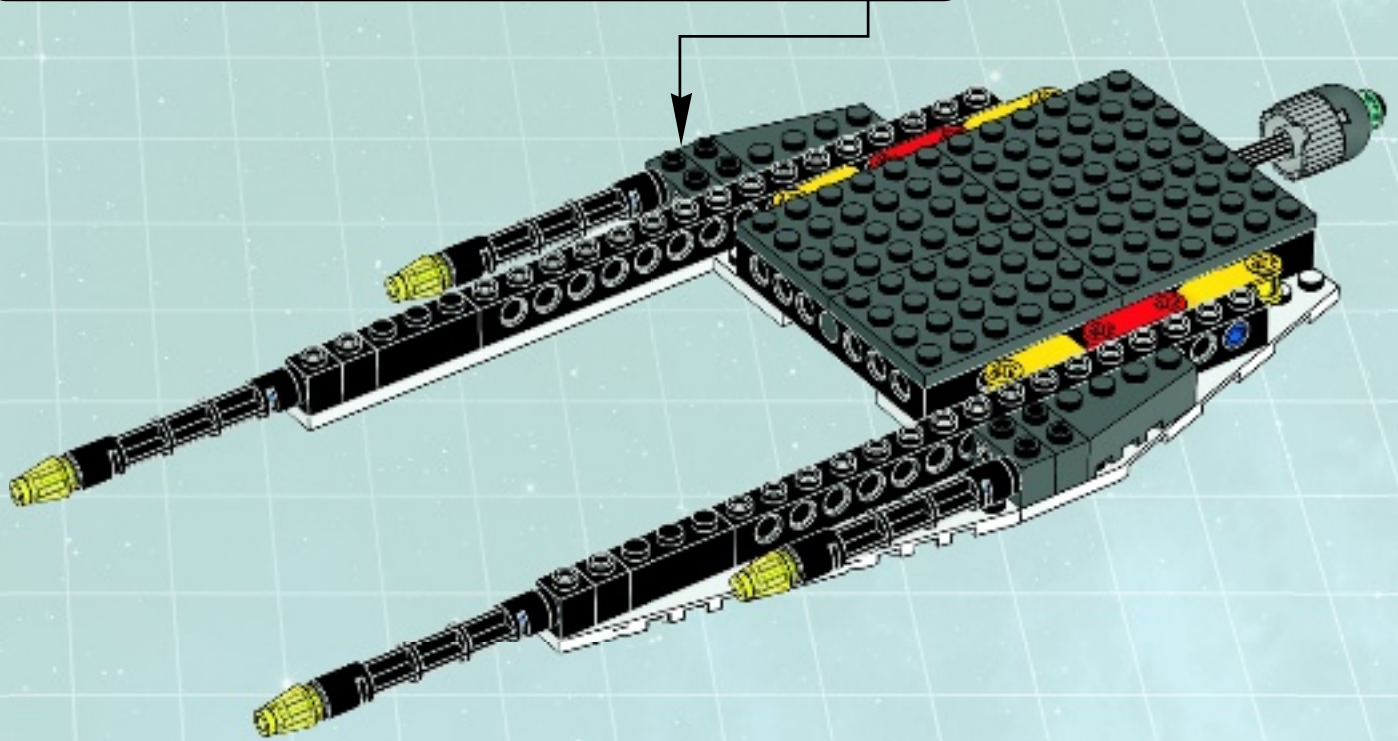
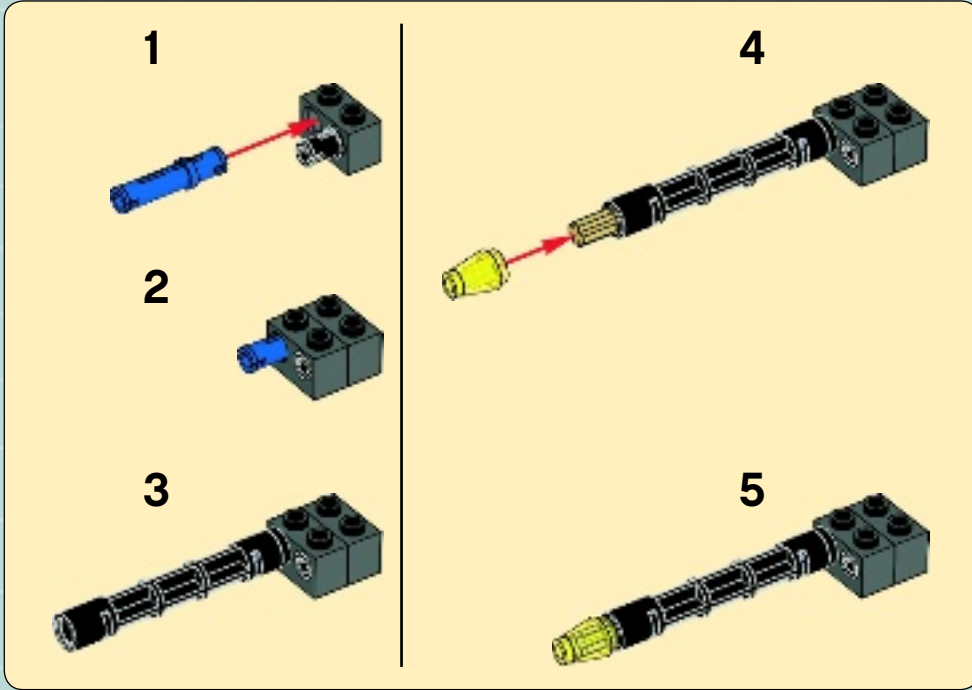

14

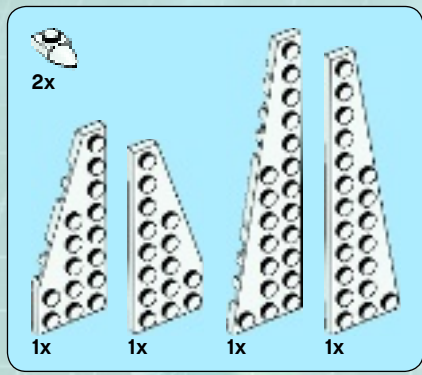



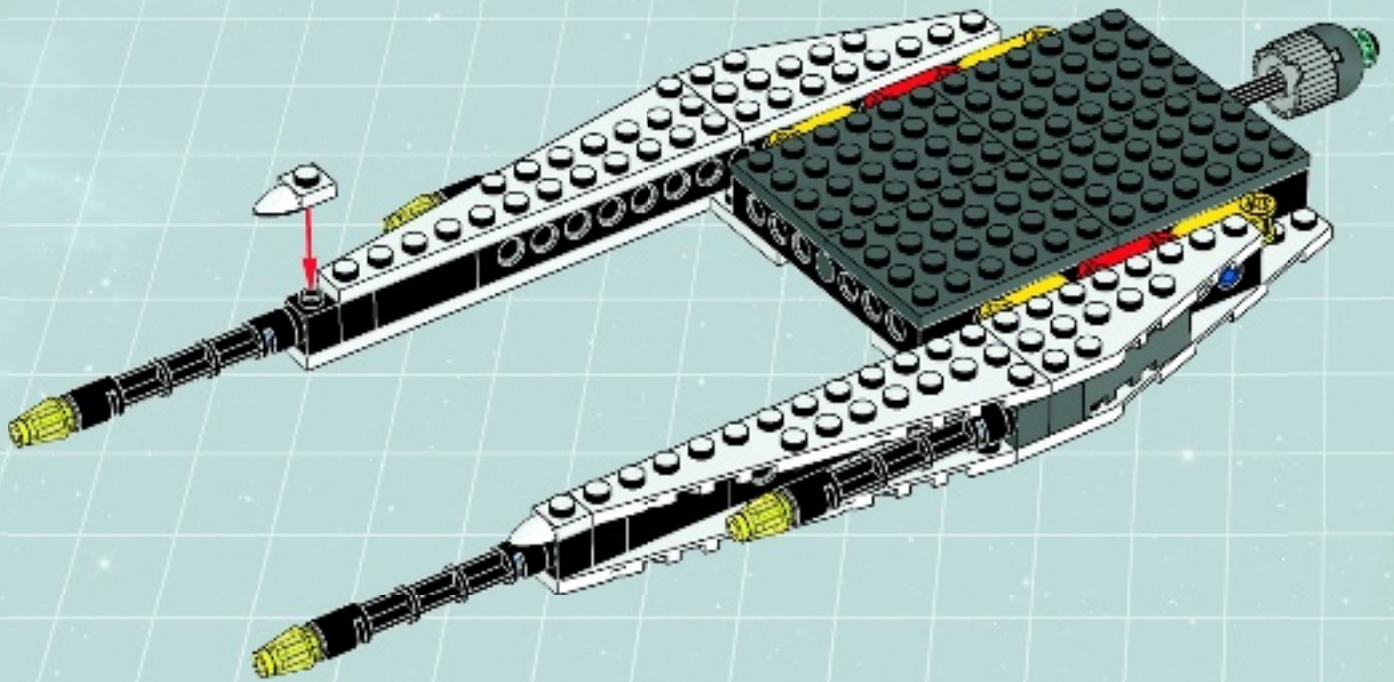

15

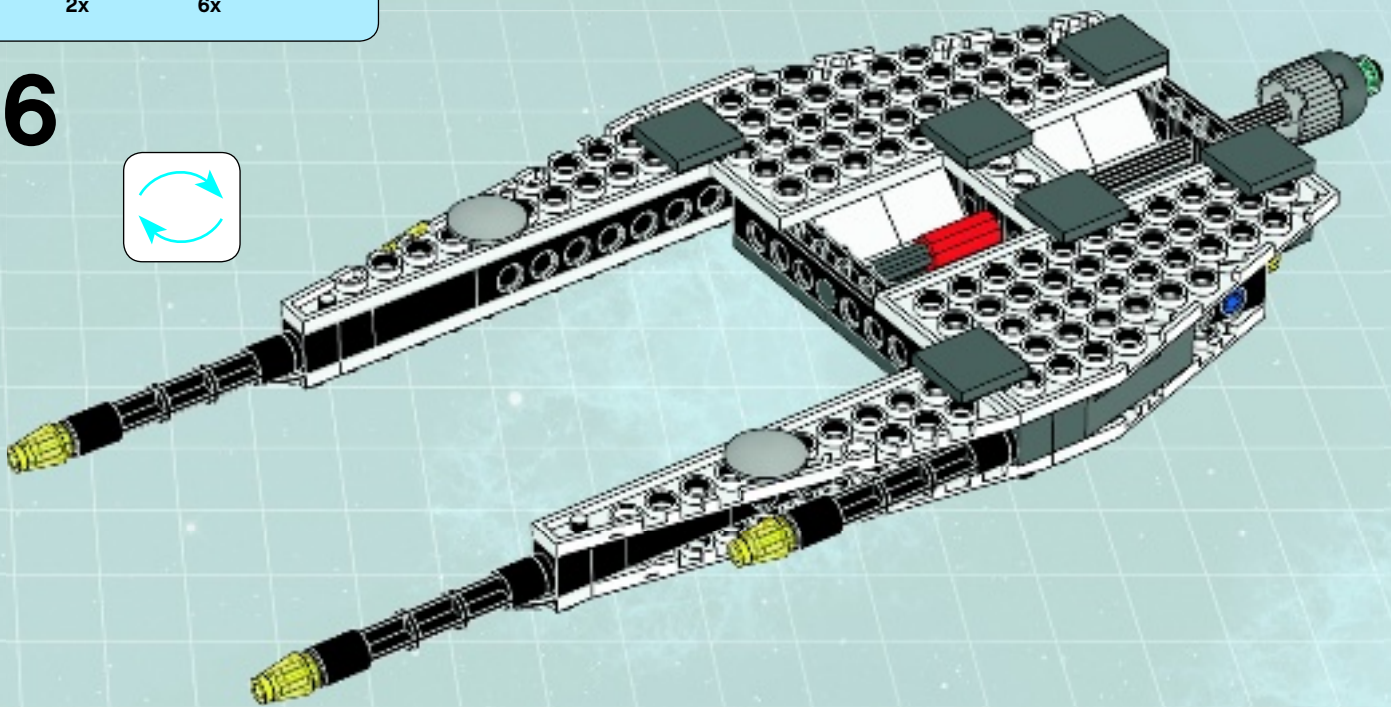
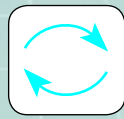

2x  6x 

16



2x  2x 

17

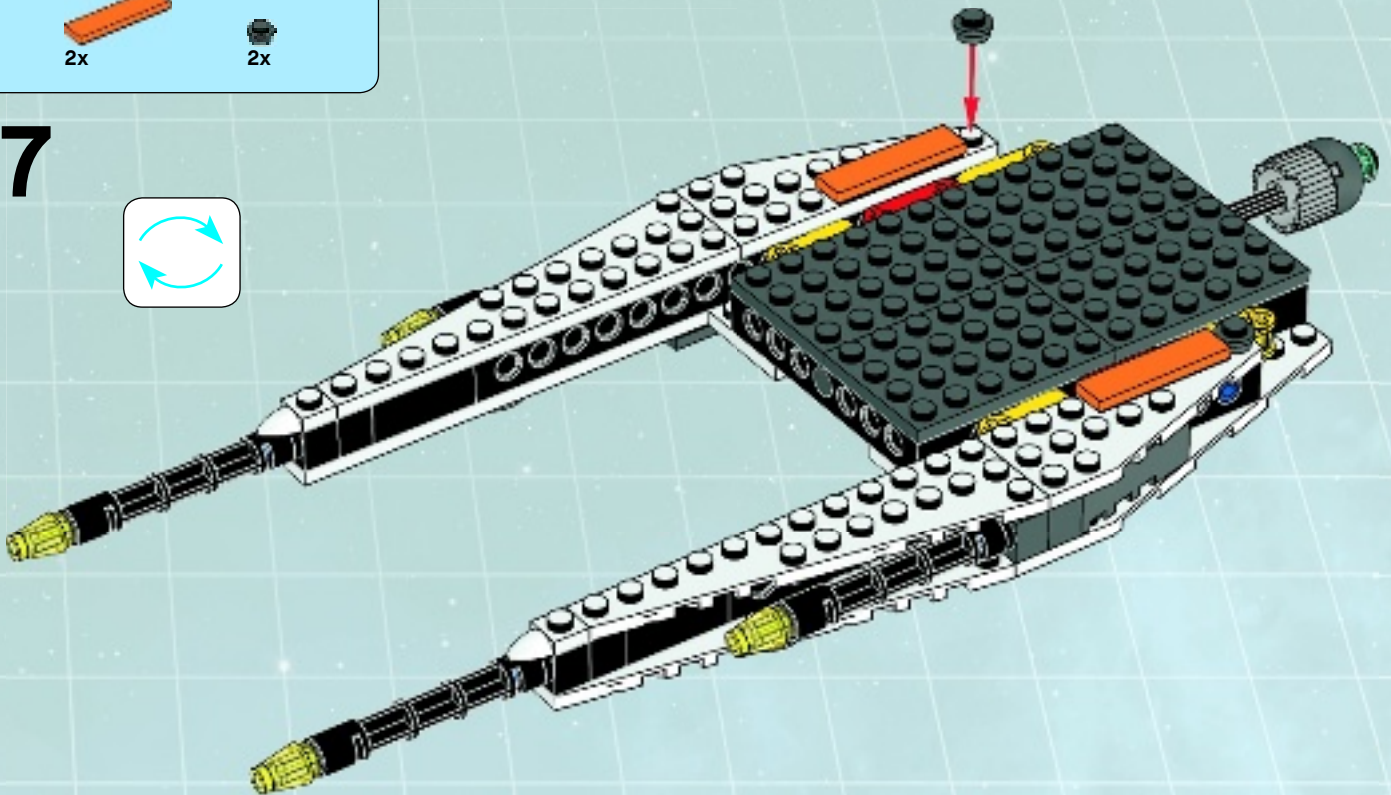

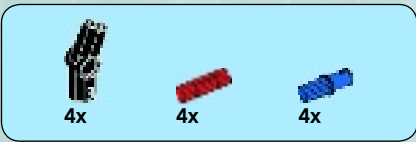

18

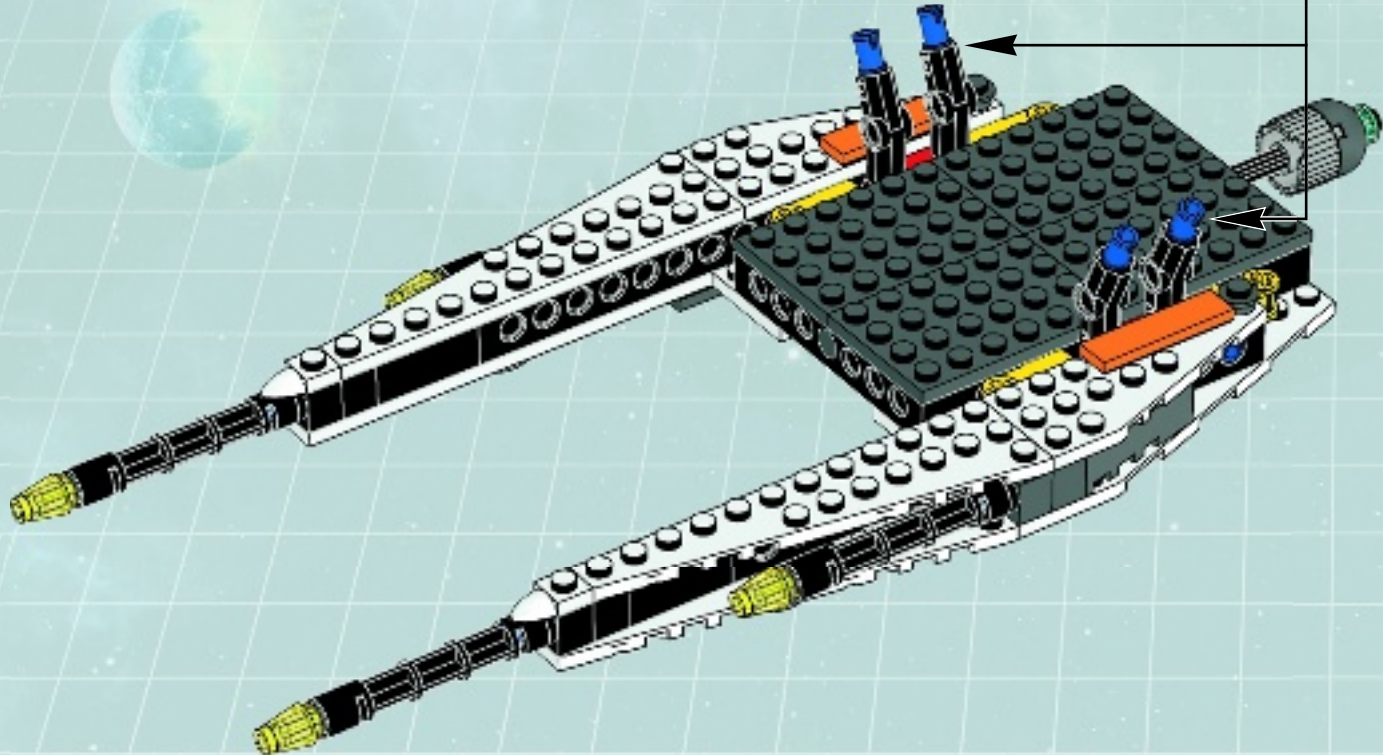

19

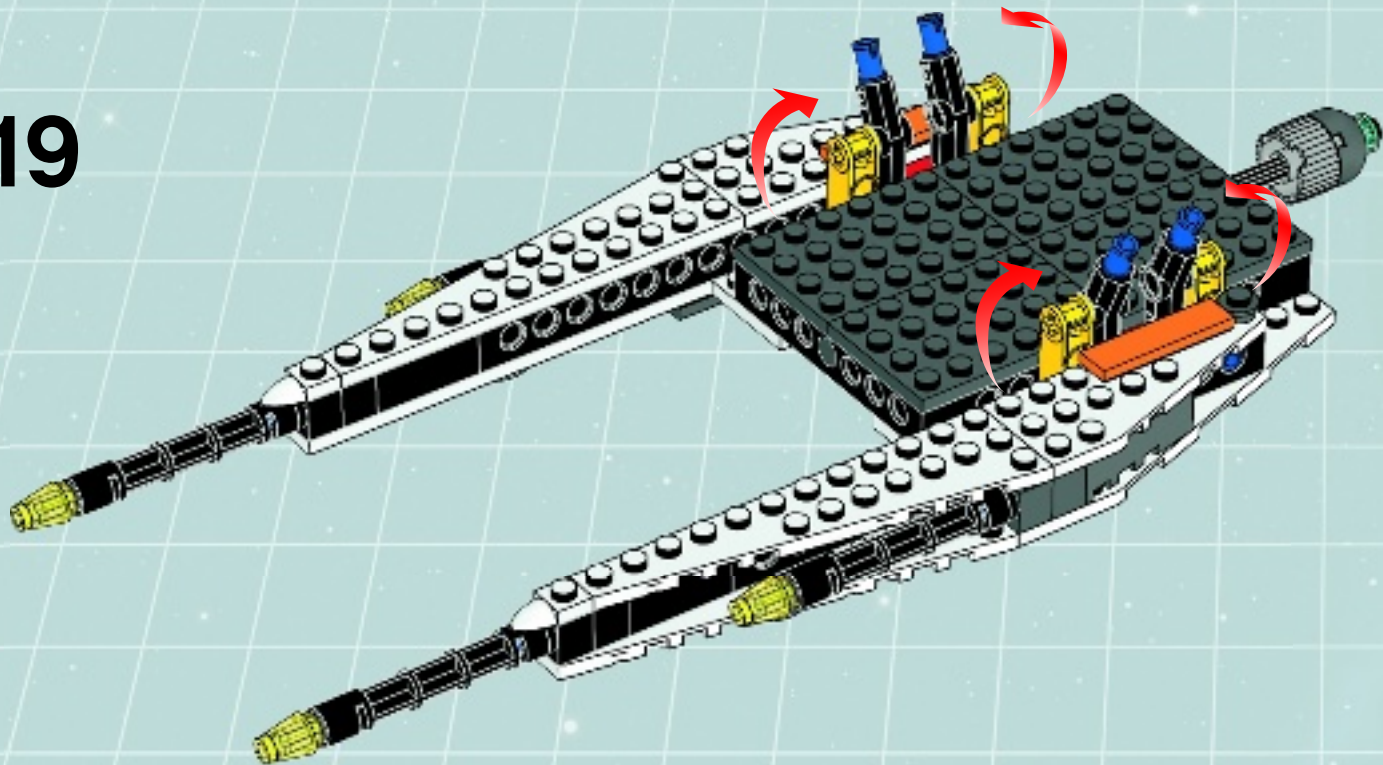

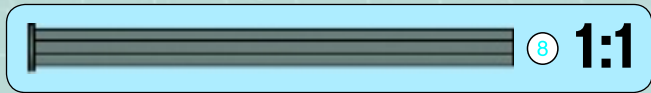
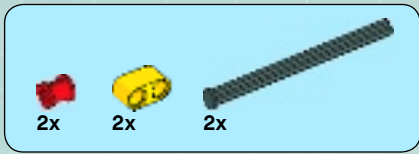

20

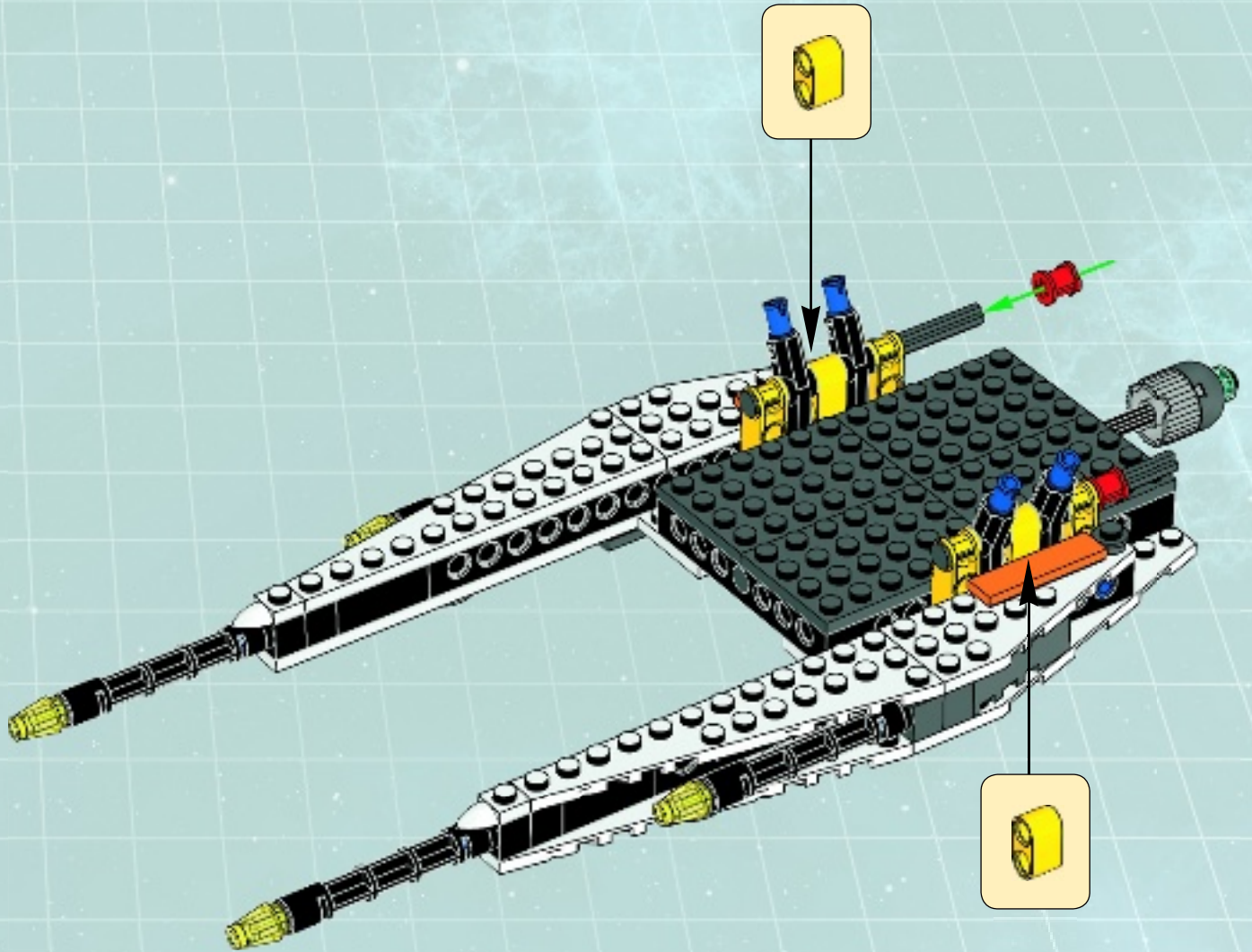

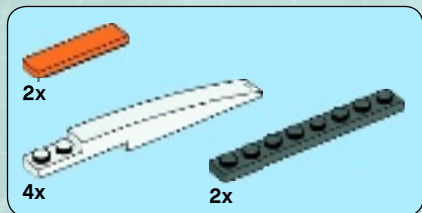

21

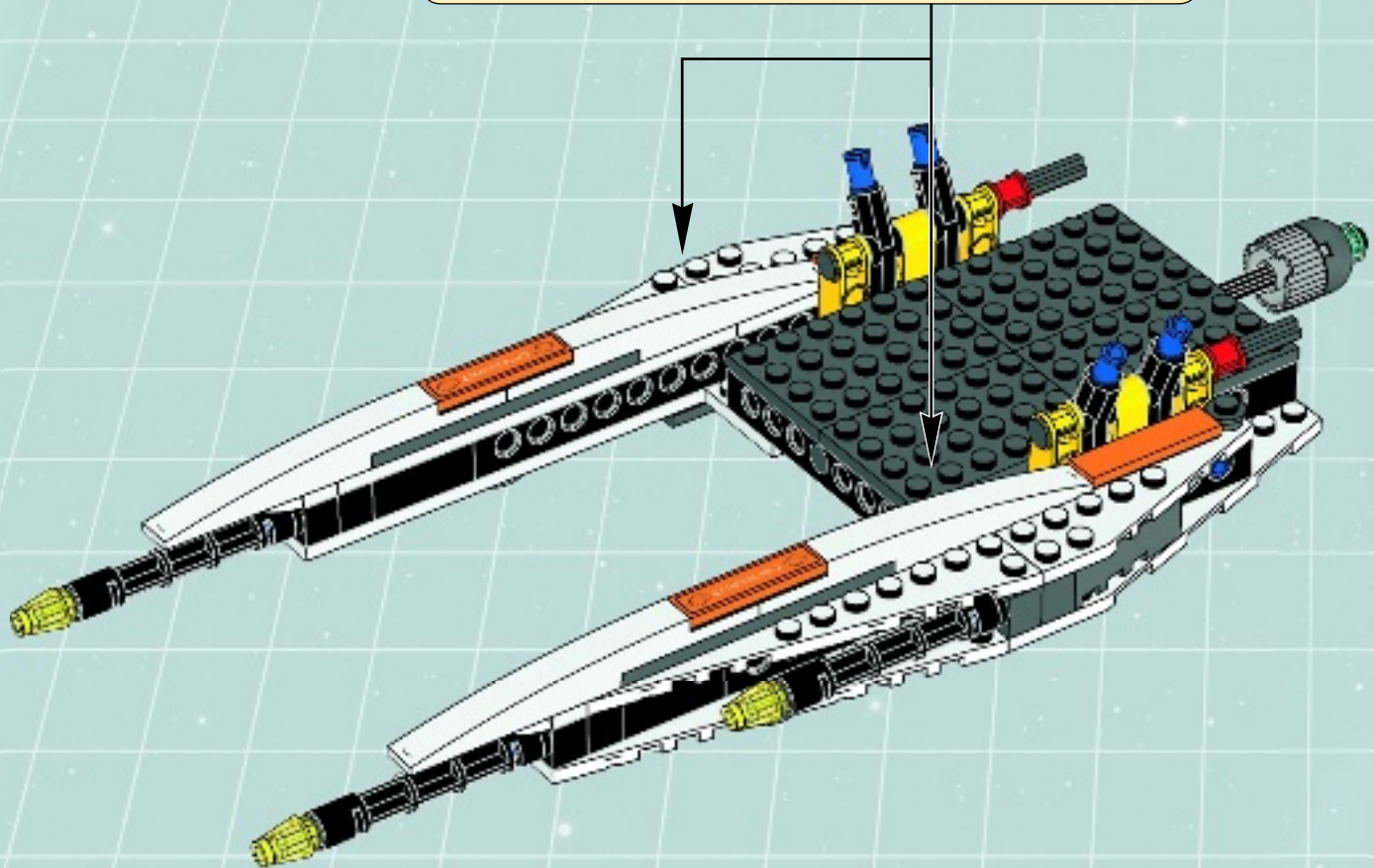
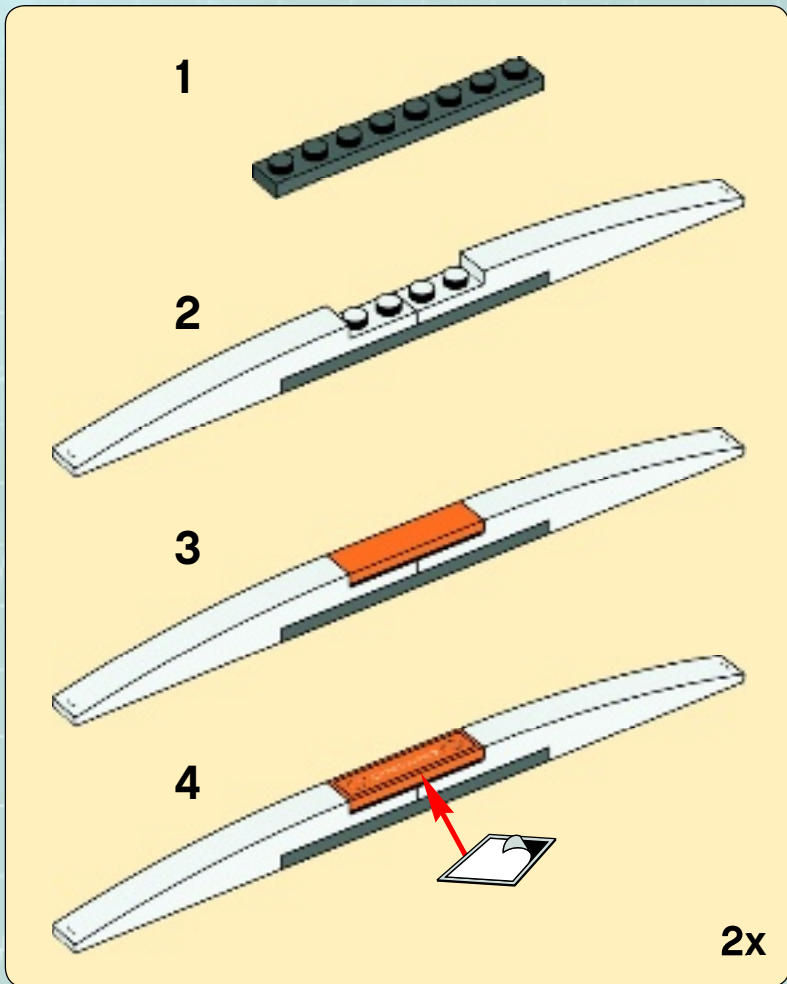

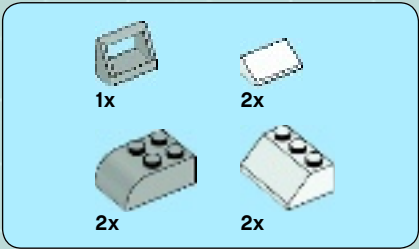
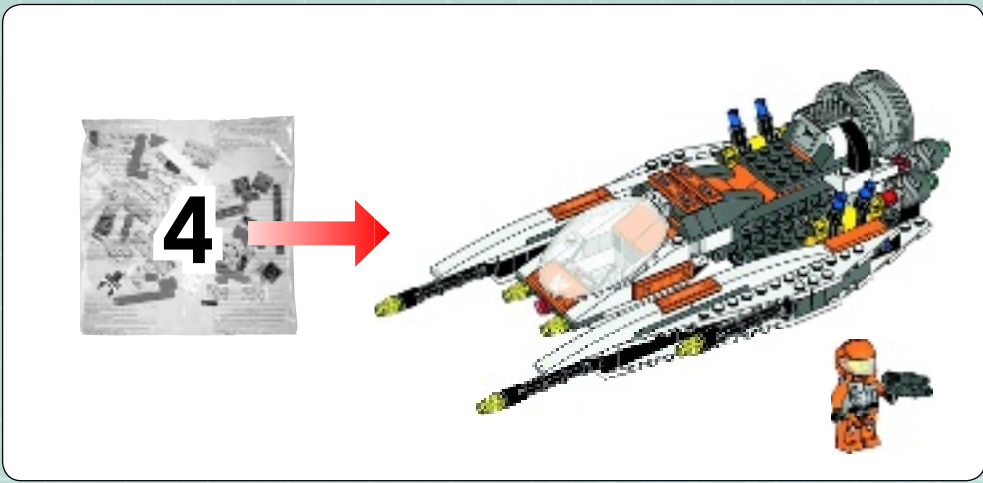

22

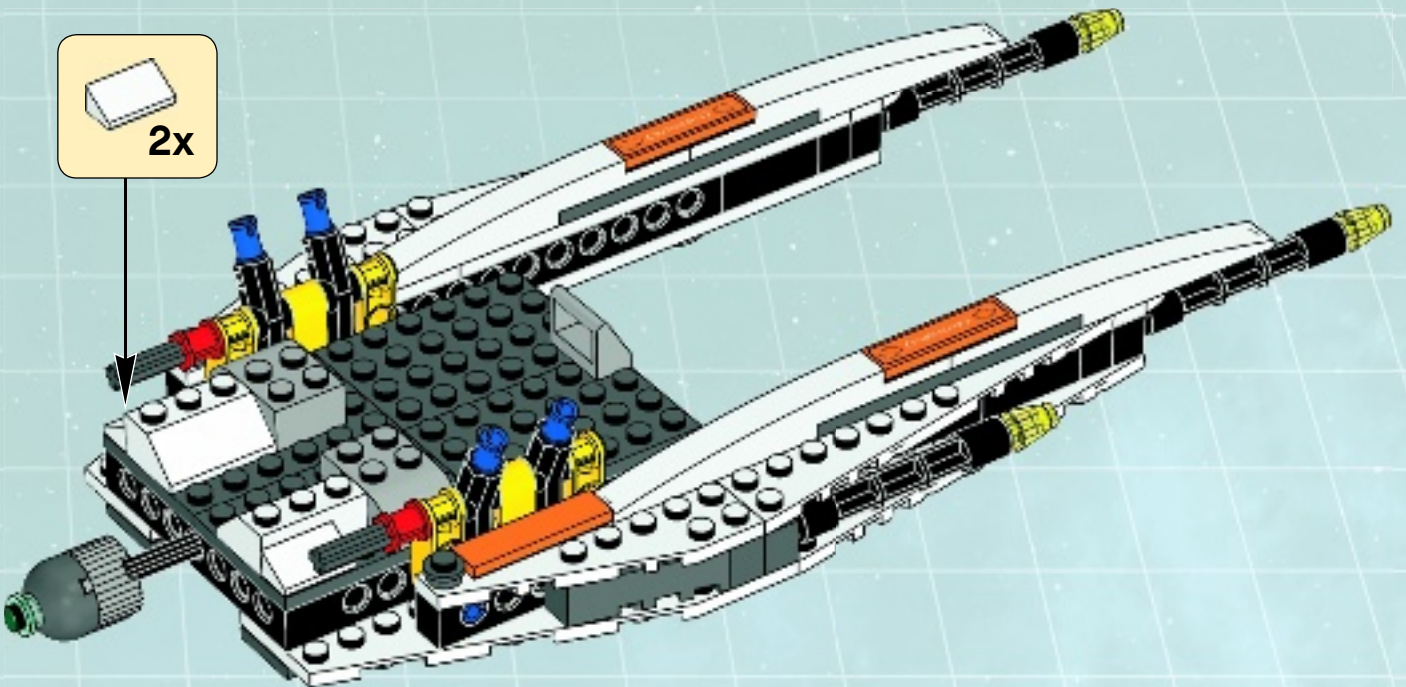
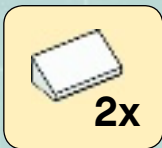
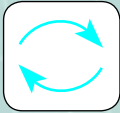

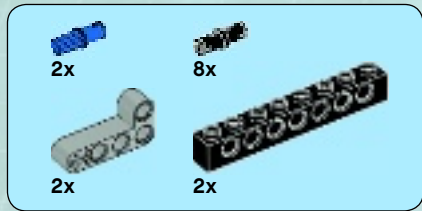

23

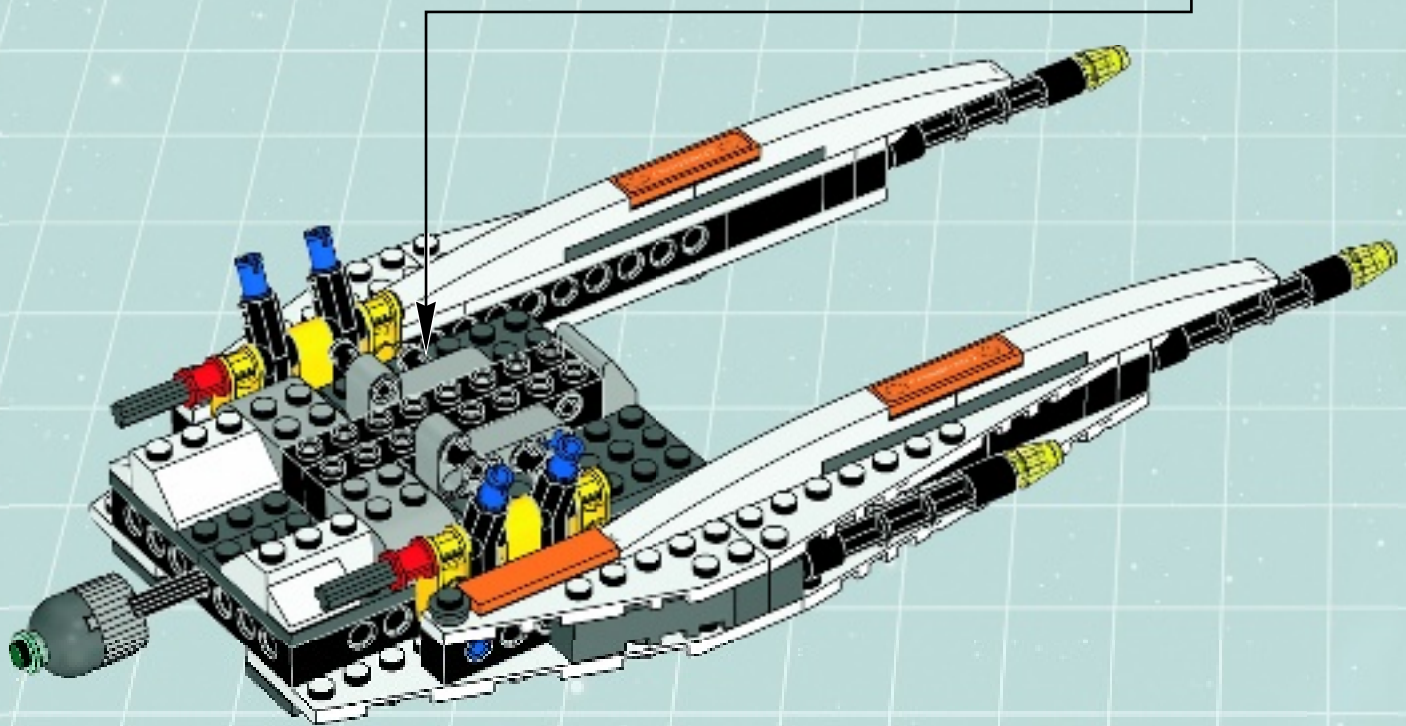
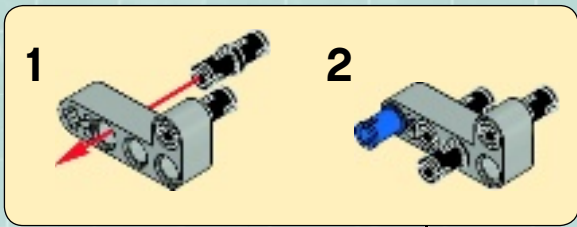
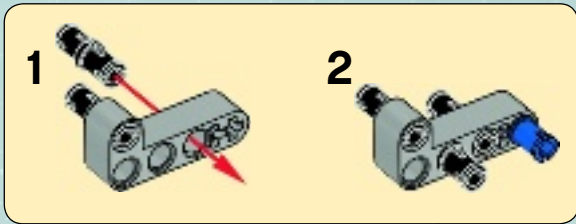

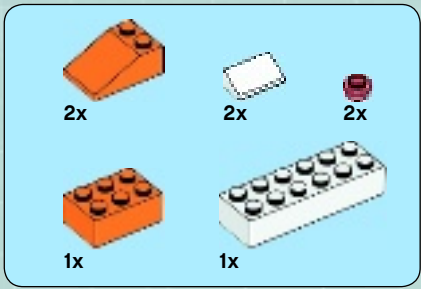

24

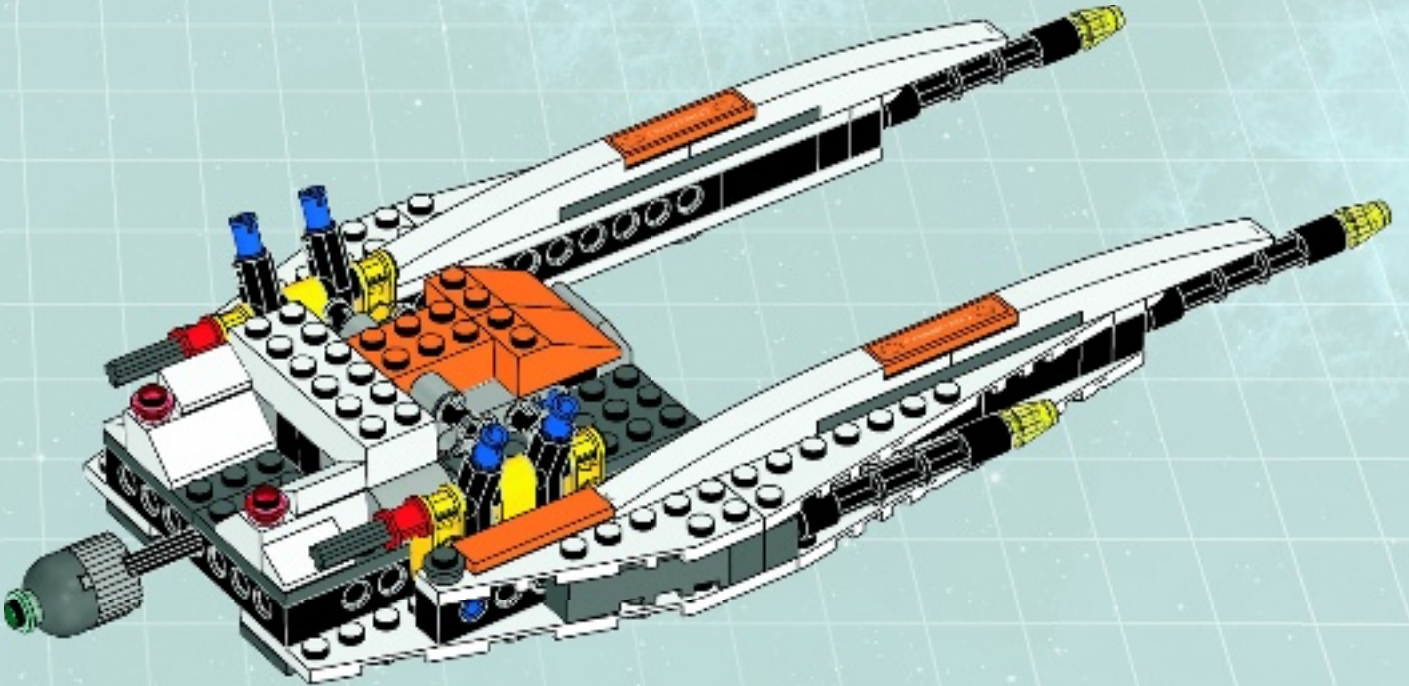

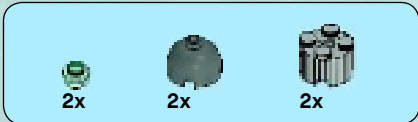

25

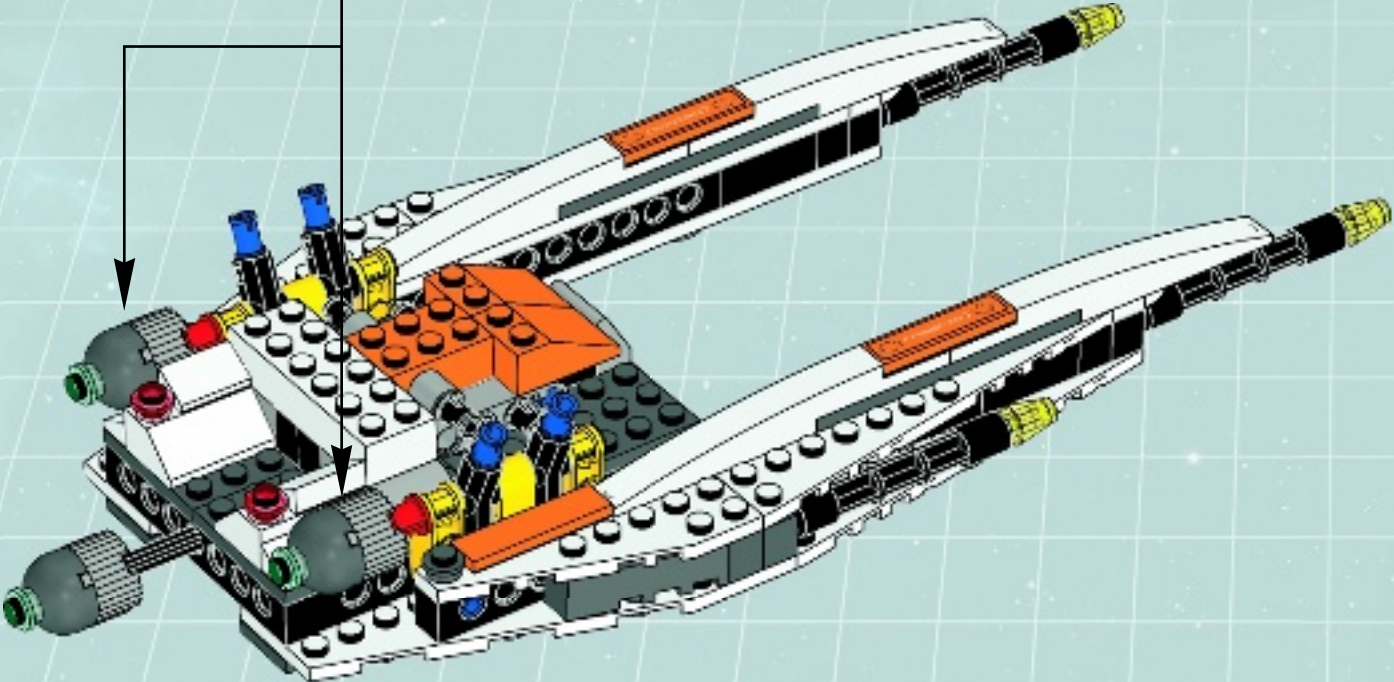
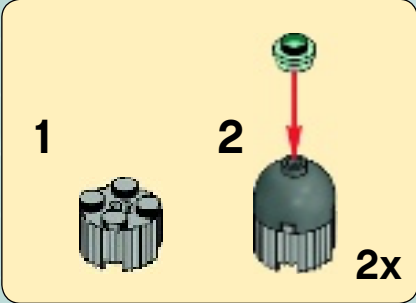



26

1



2



3



4



5

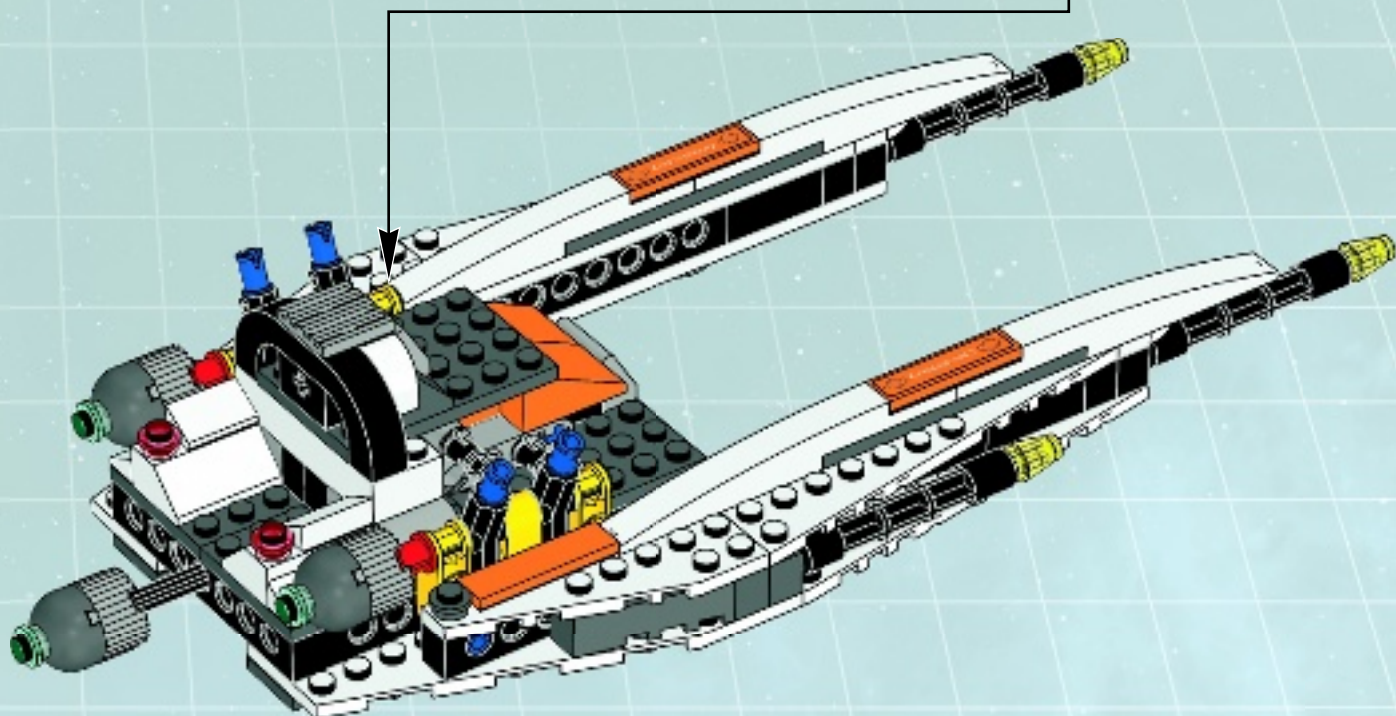

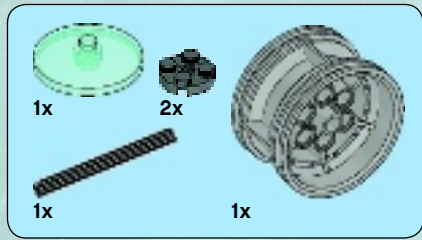

27

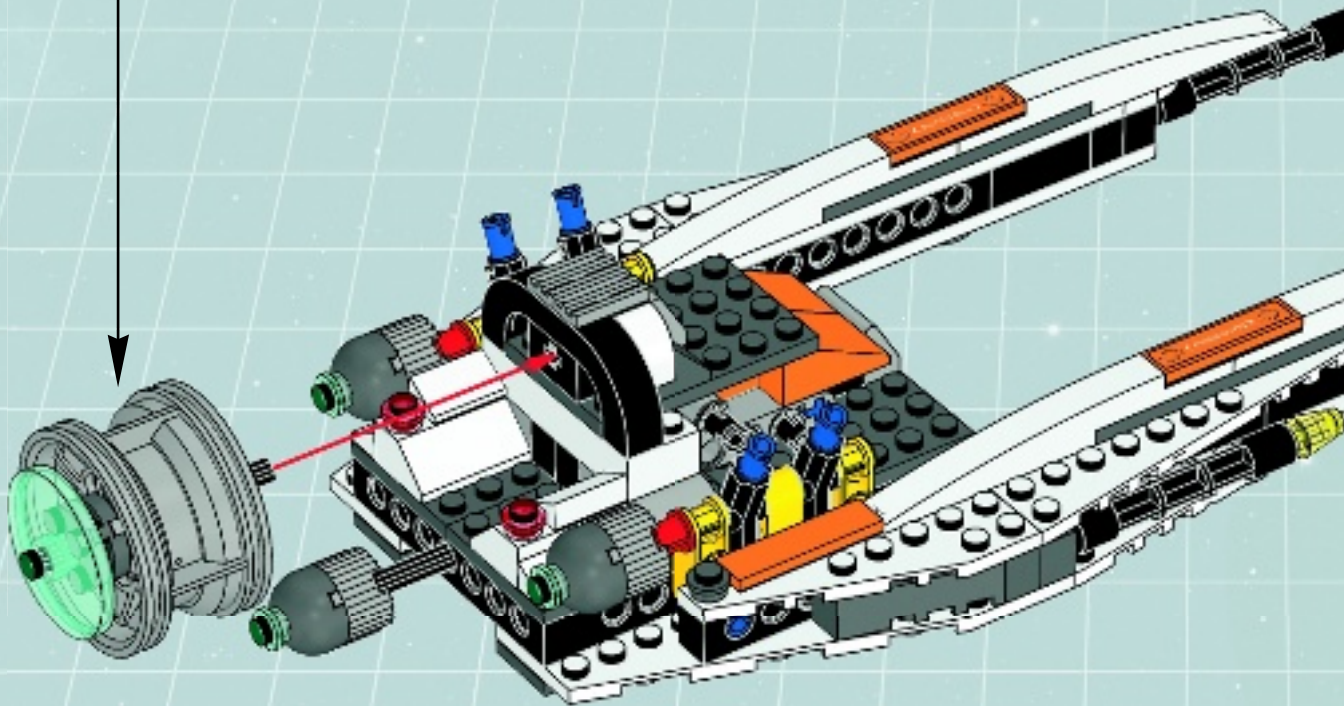
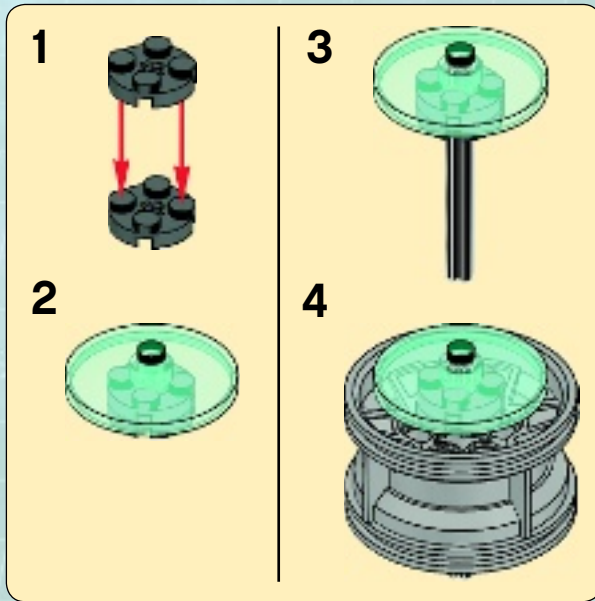

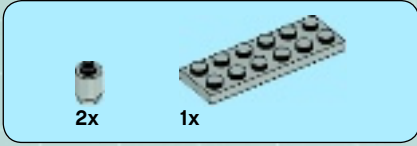
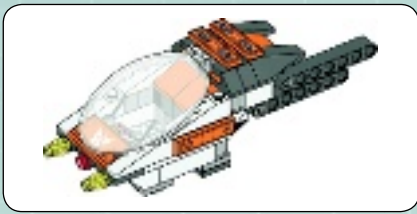

1

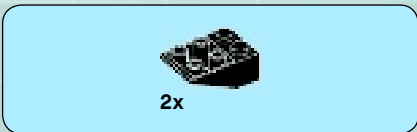
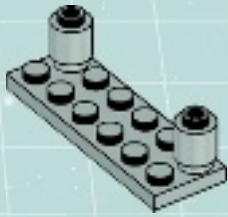

2

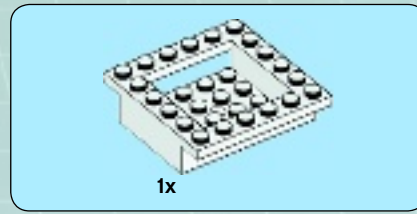

3



4

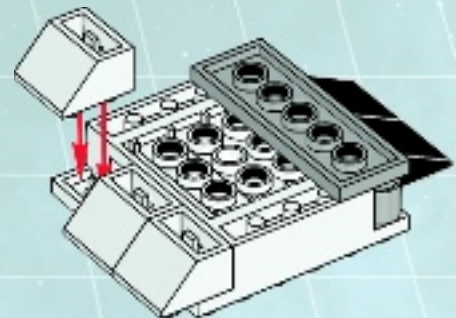
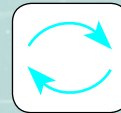



1x

5

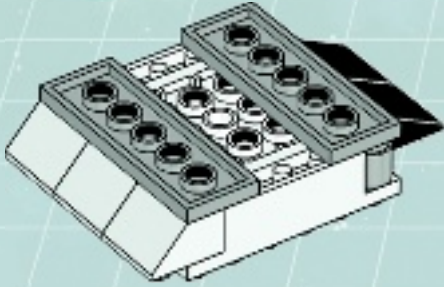

3x



1x



1x

7

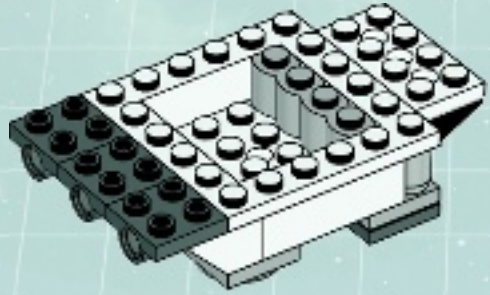
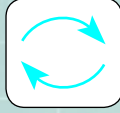

2x



2x

6

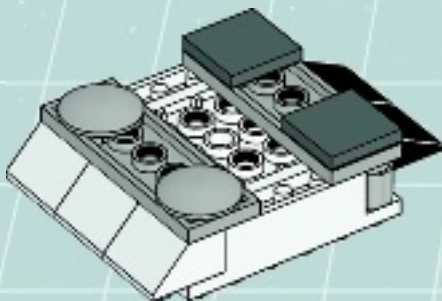

1x



2x



1x



2x

8



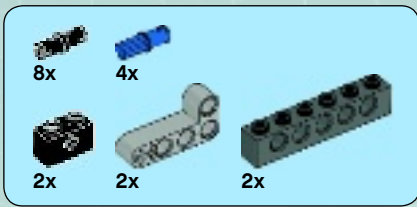

9

1

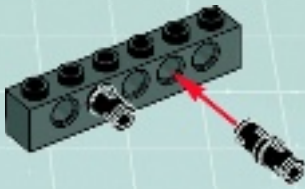

2



3

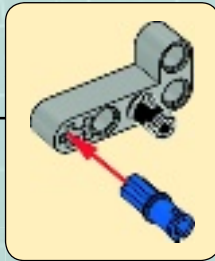

4



5

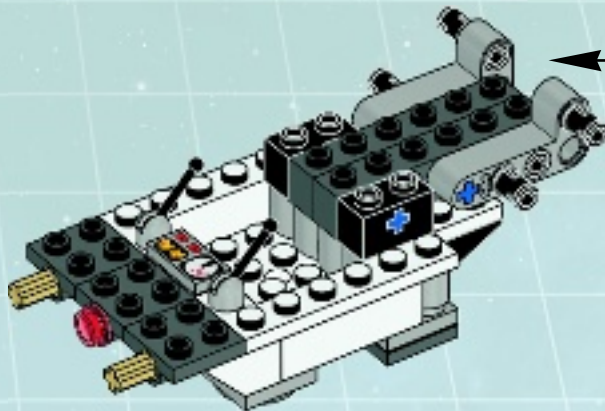

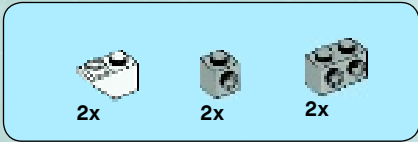

10

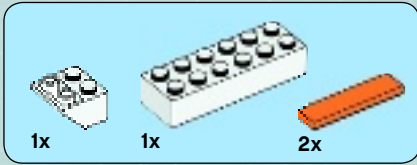
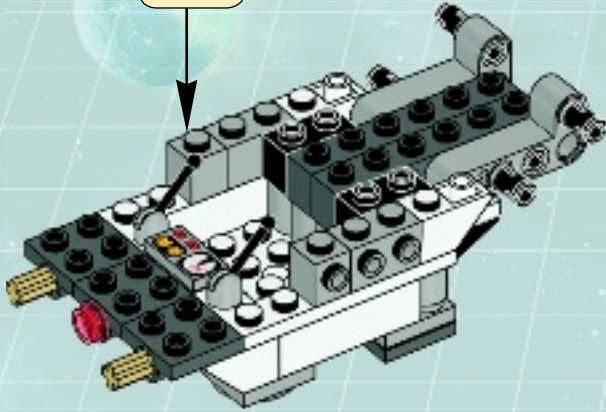

12

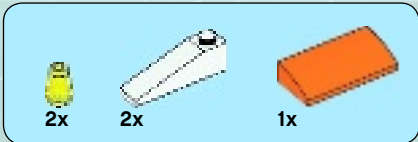
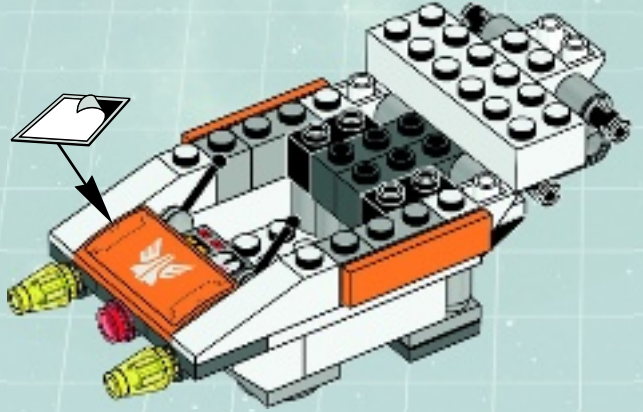

11

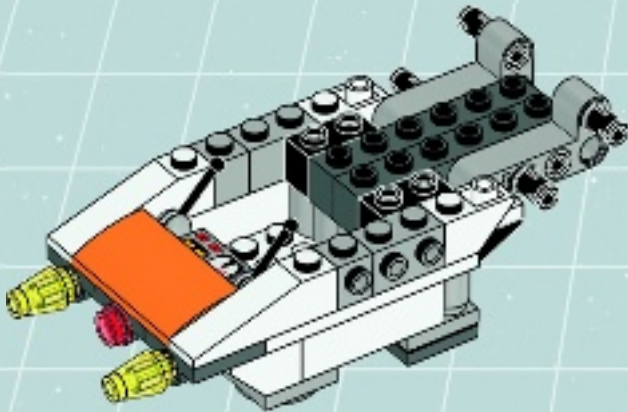

13

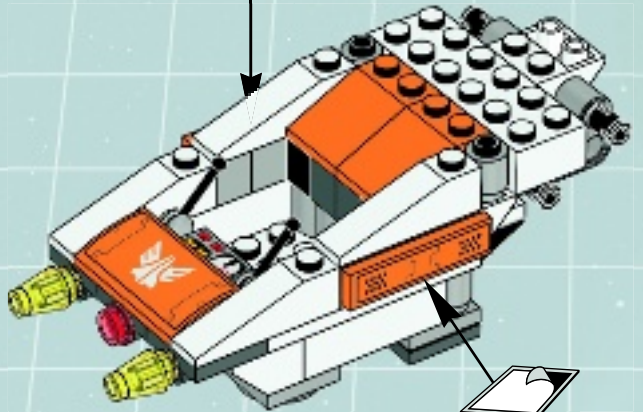
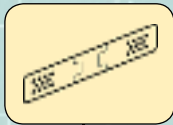

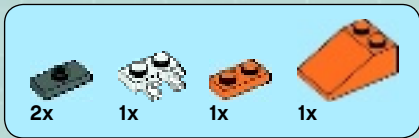

14

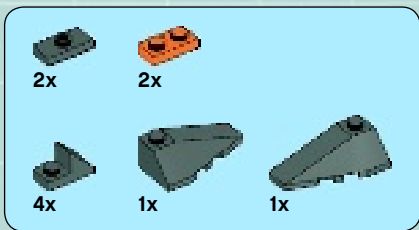
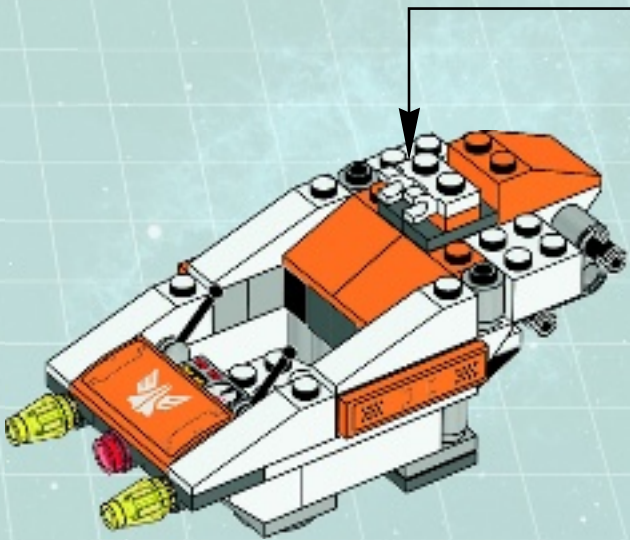

15

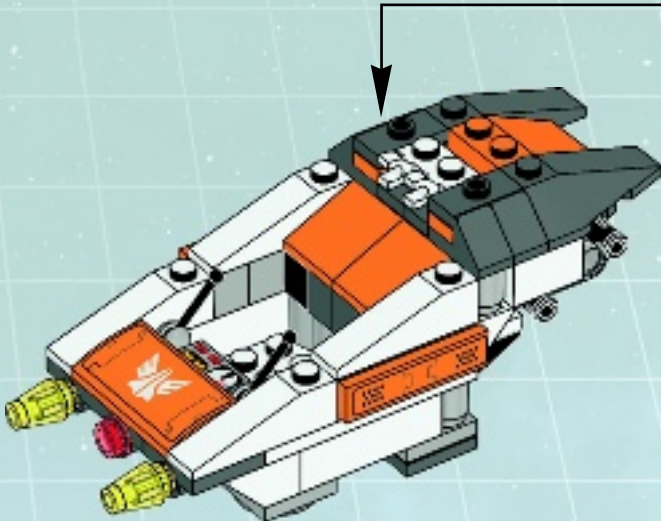
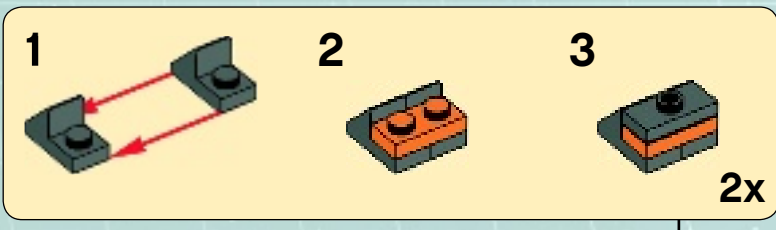

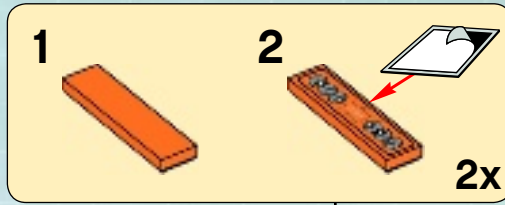
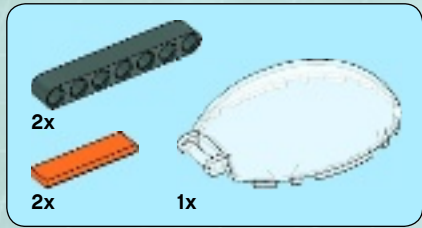

16

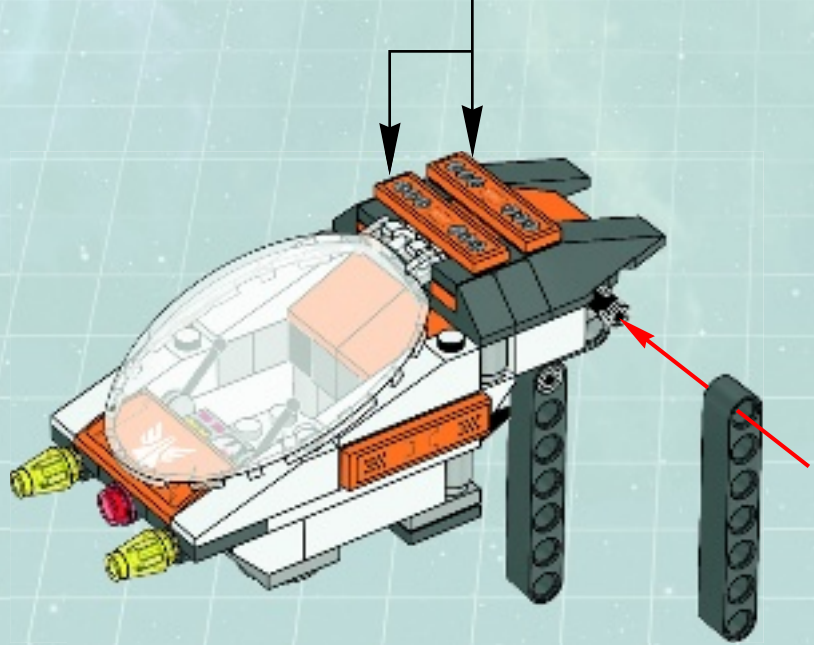

28

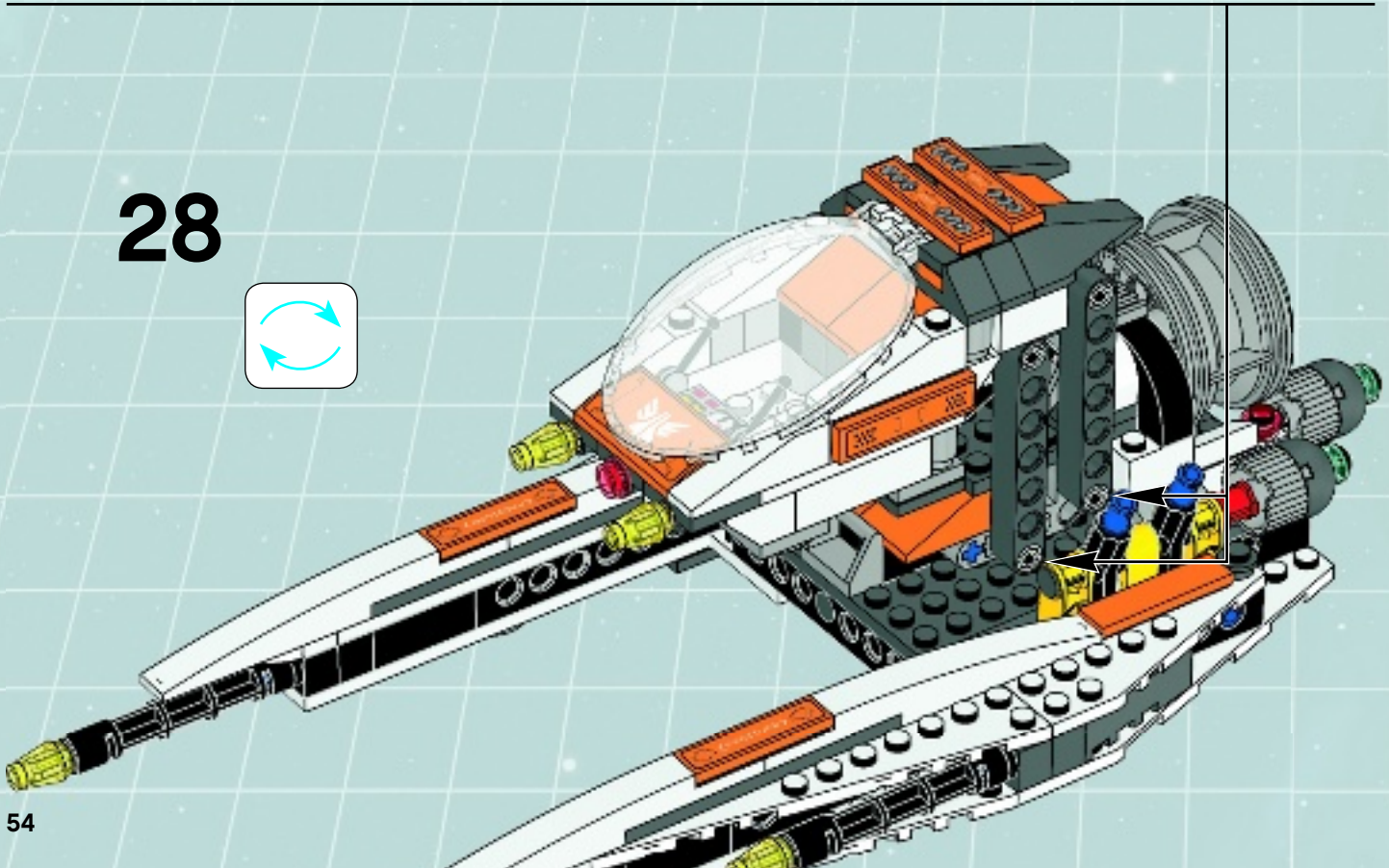
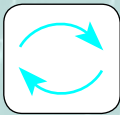

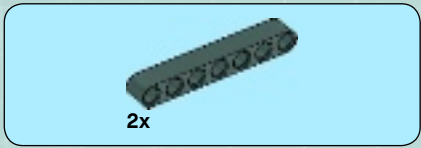

29

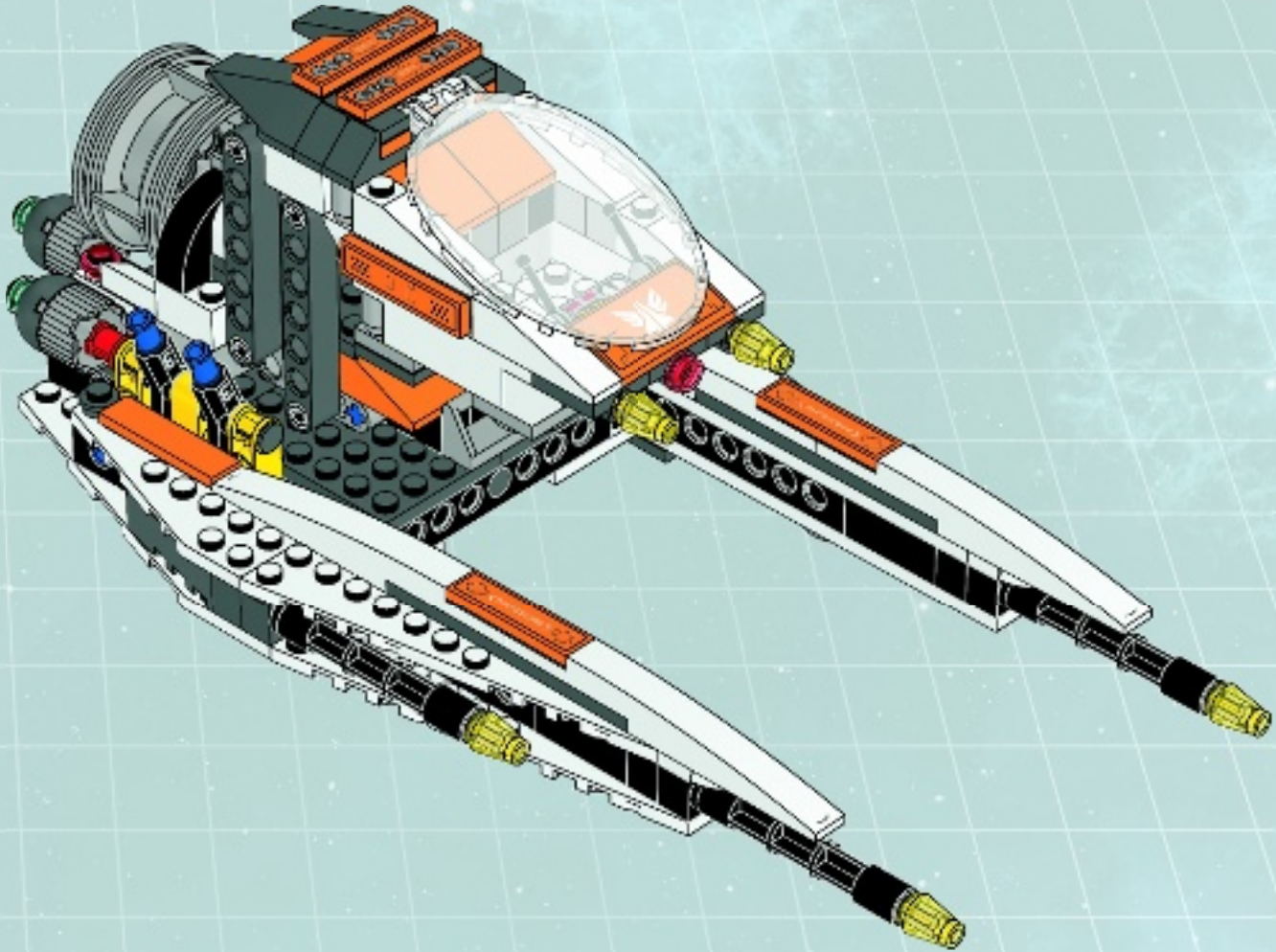



30

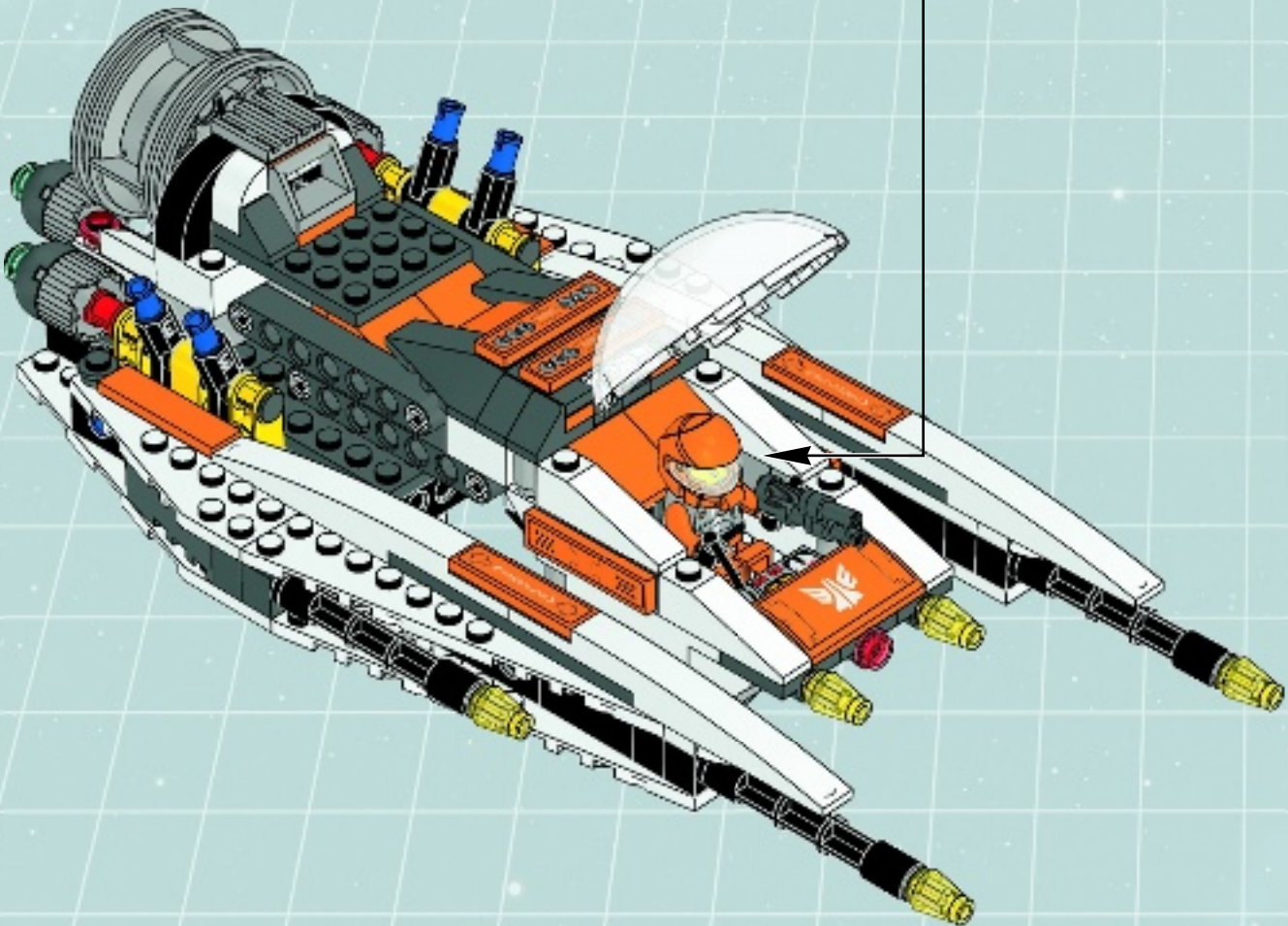
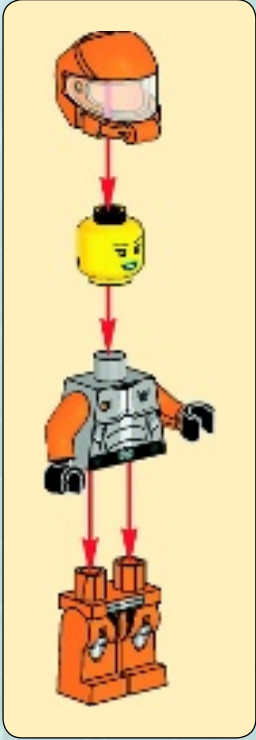

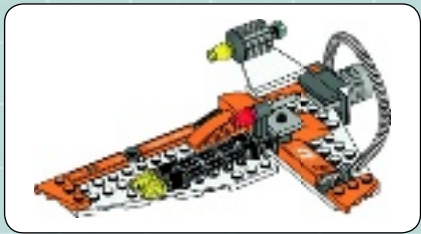
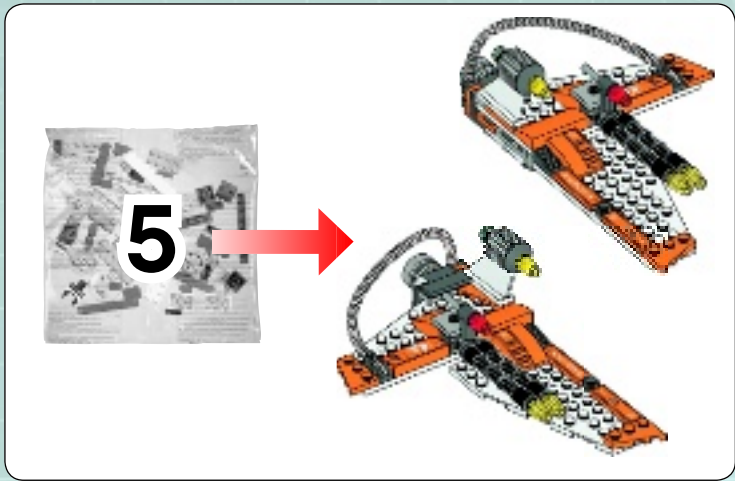

1

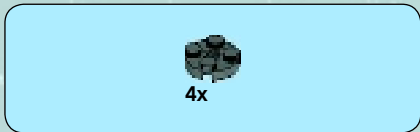

2

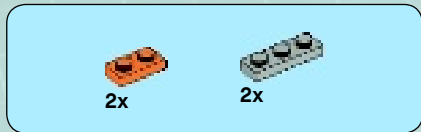

3

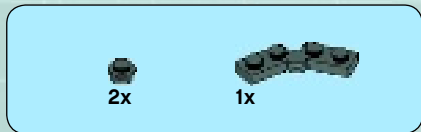
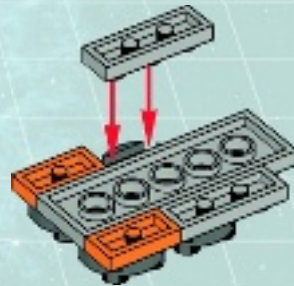
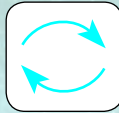

4

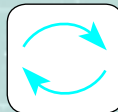

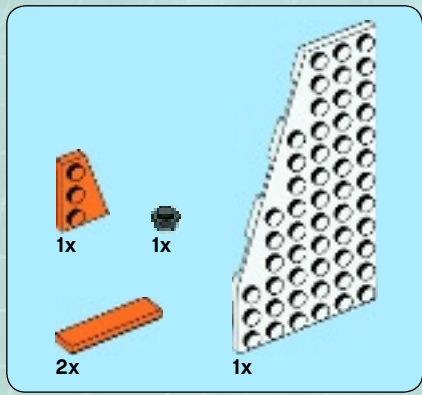

5

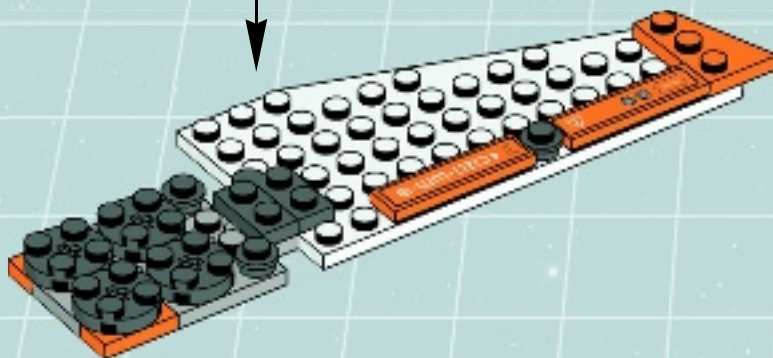
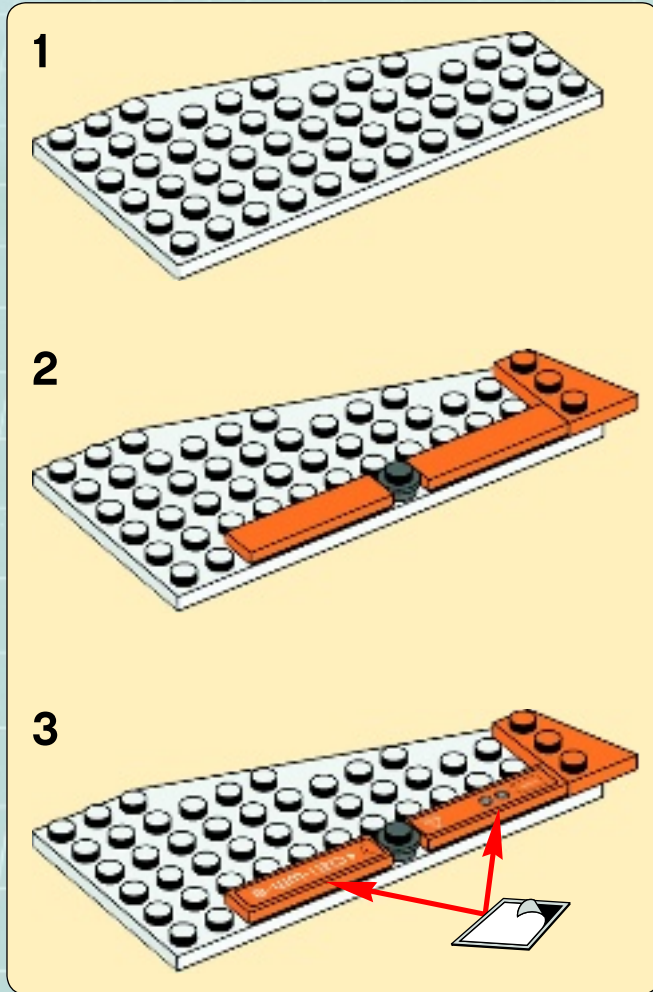



6

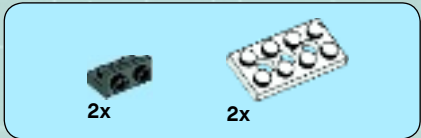
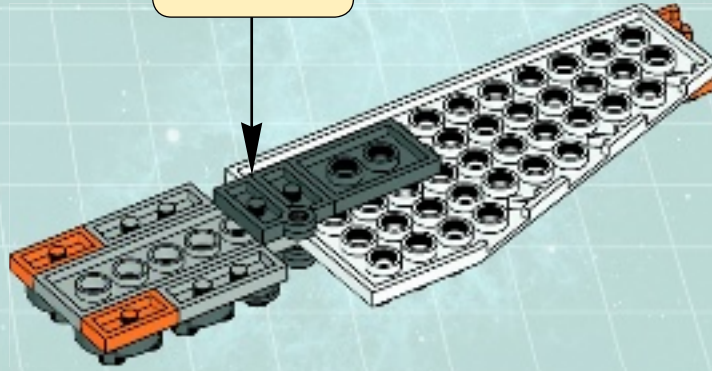
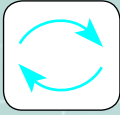

7

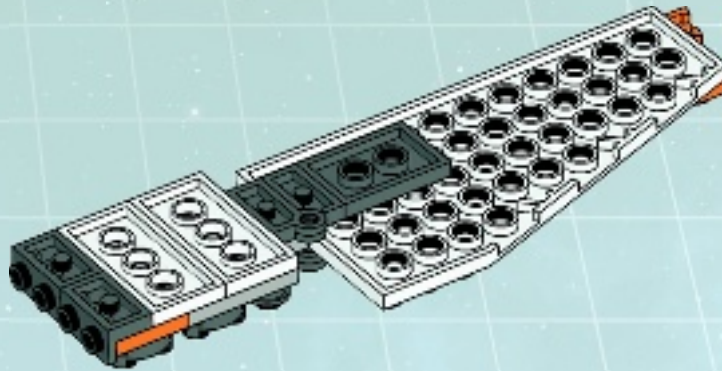

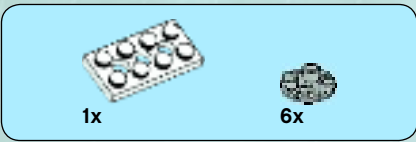

8

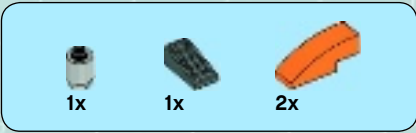
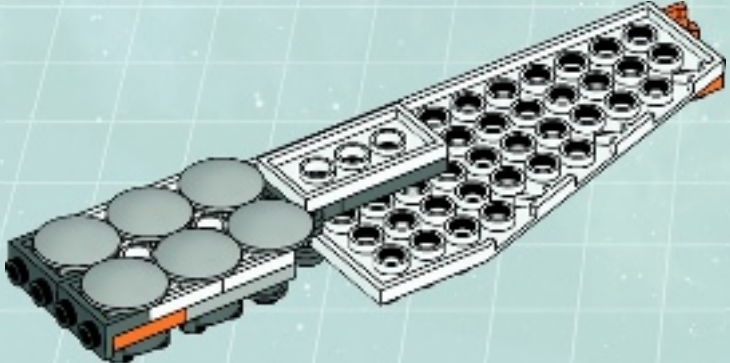

9

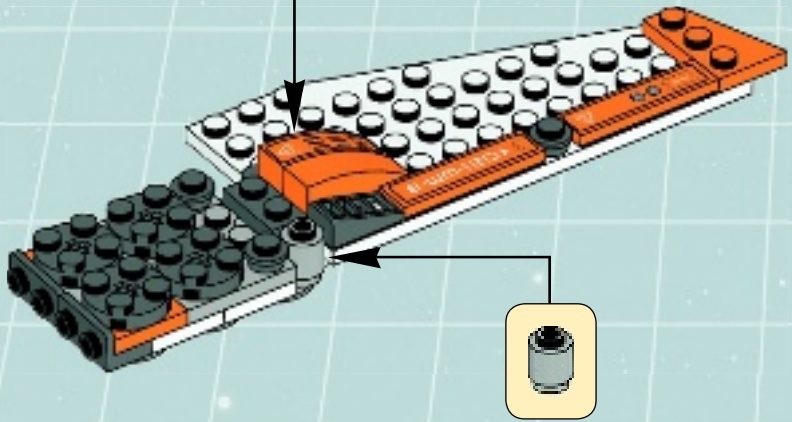
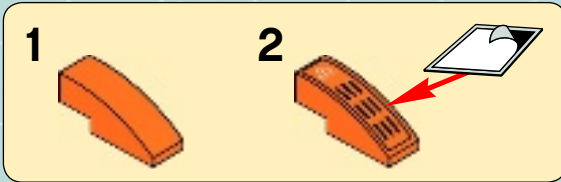

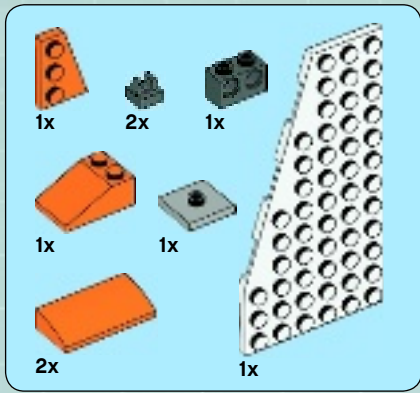

10

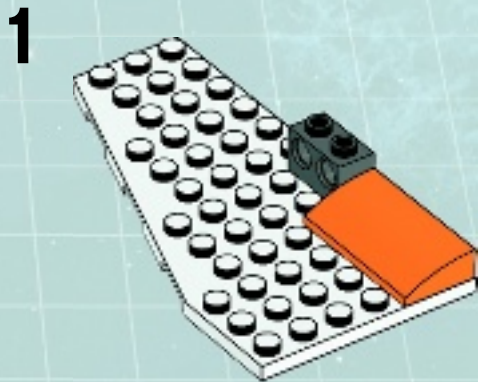

2

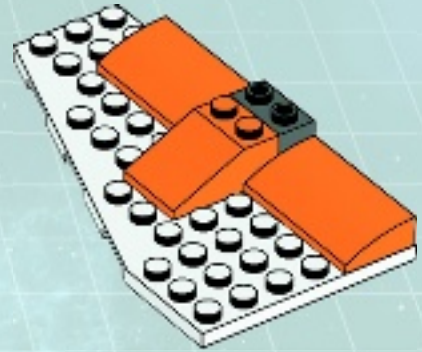

3

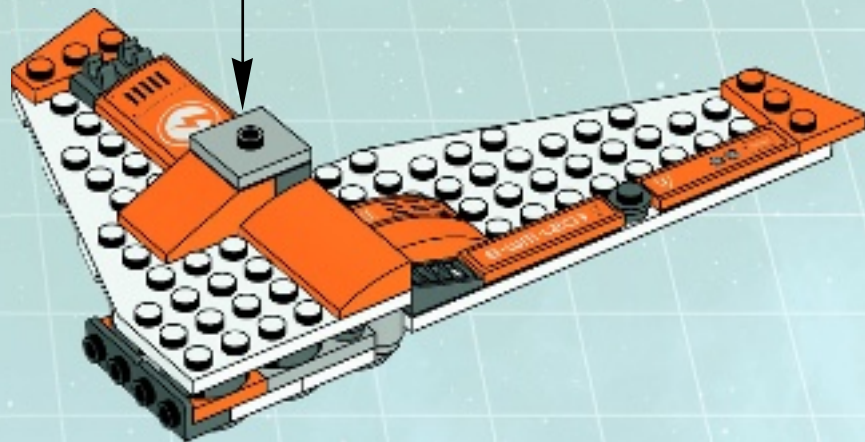
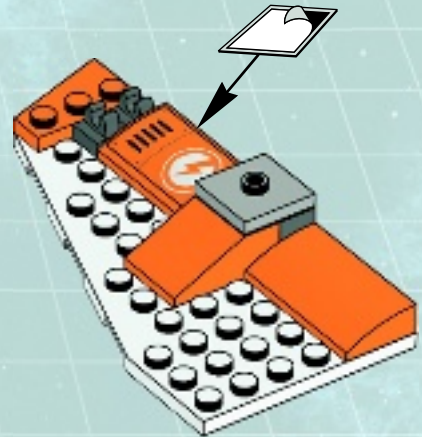

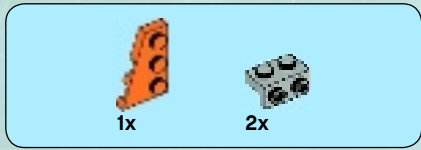

11

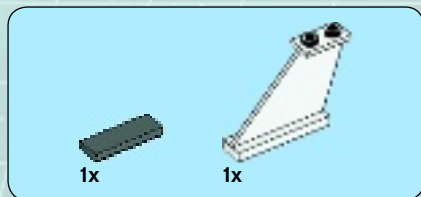
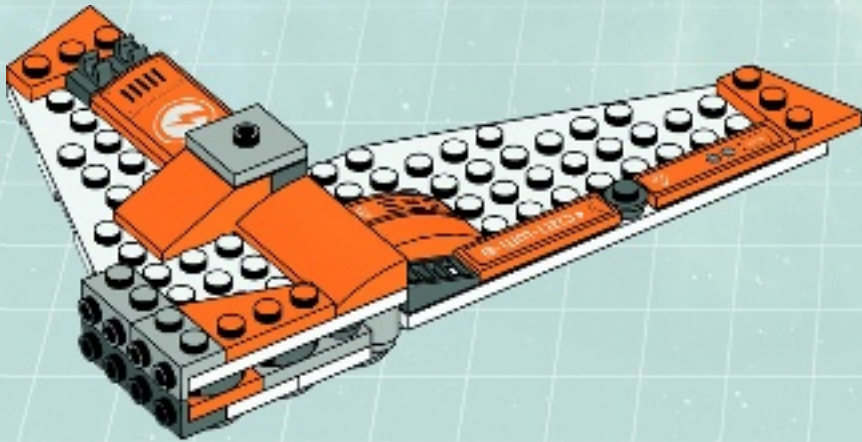

12

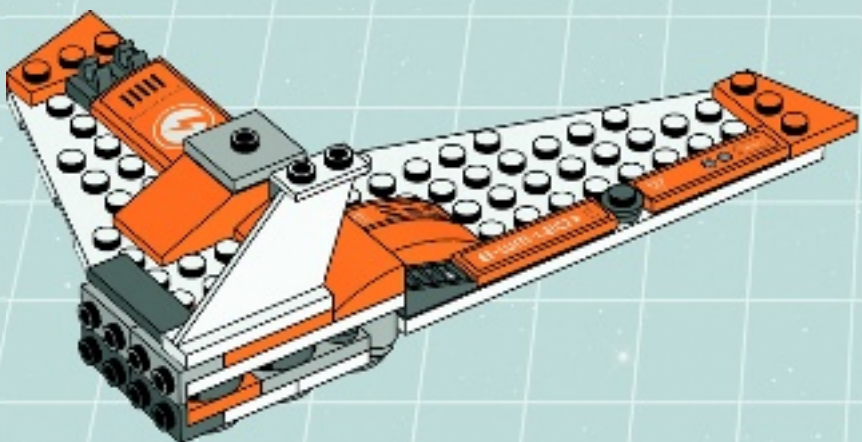



13



| | |
|--------------|--------------|
| 1 | 3 |
| 2 | 4 |

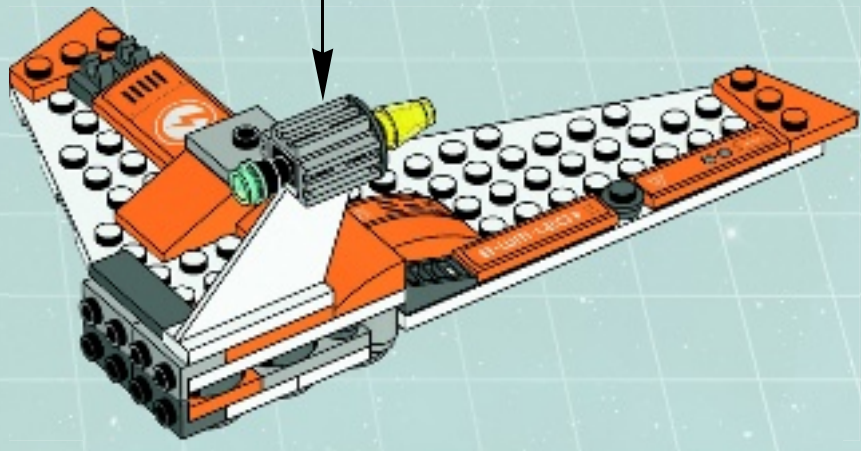

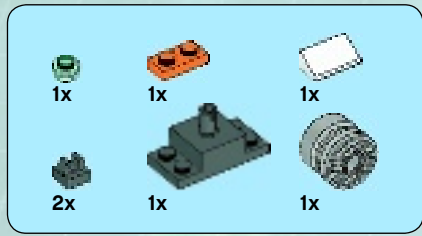

14

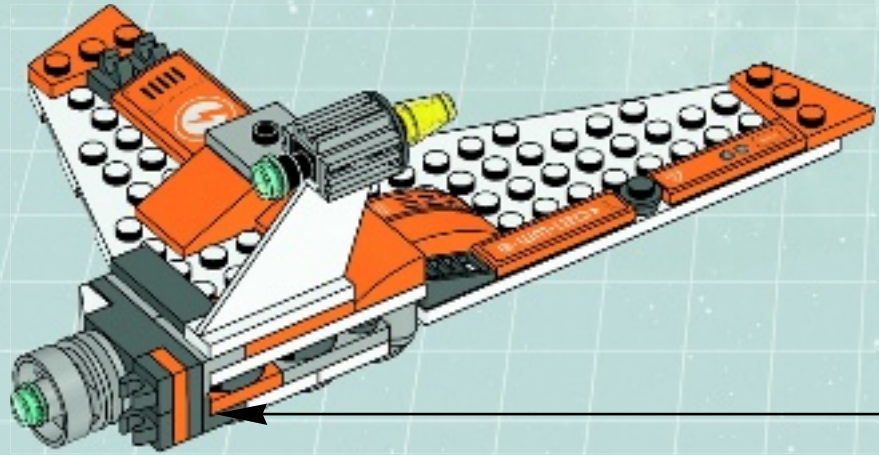
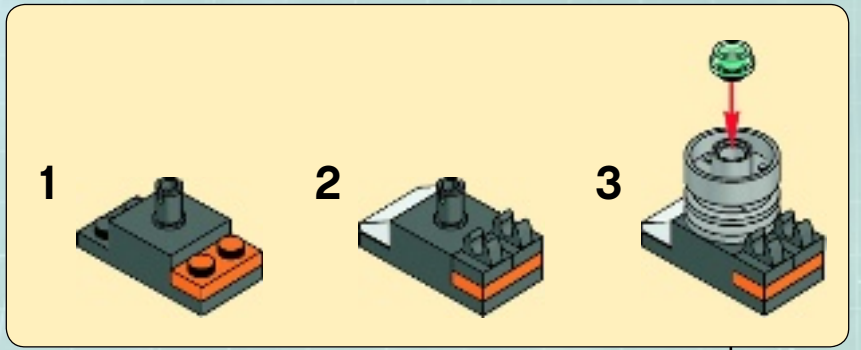

15

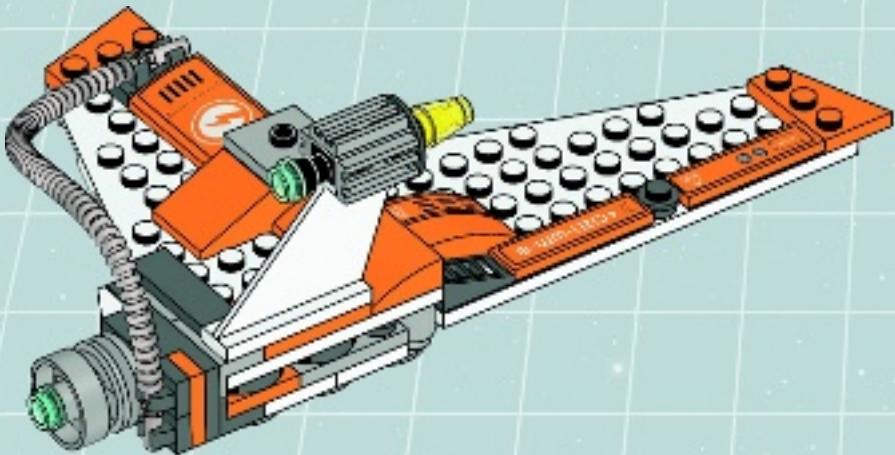

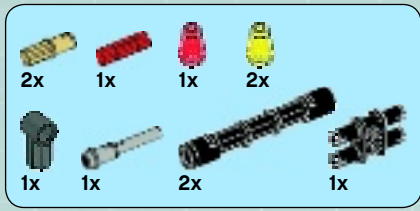

16

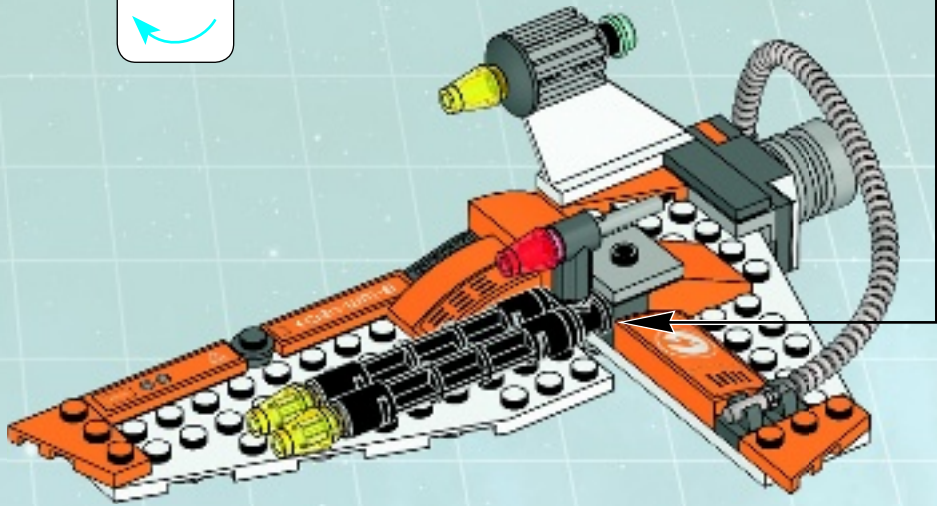
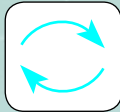
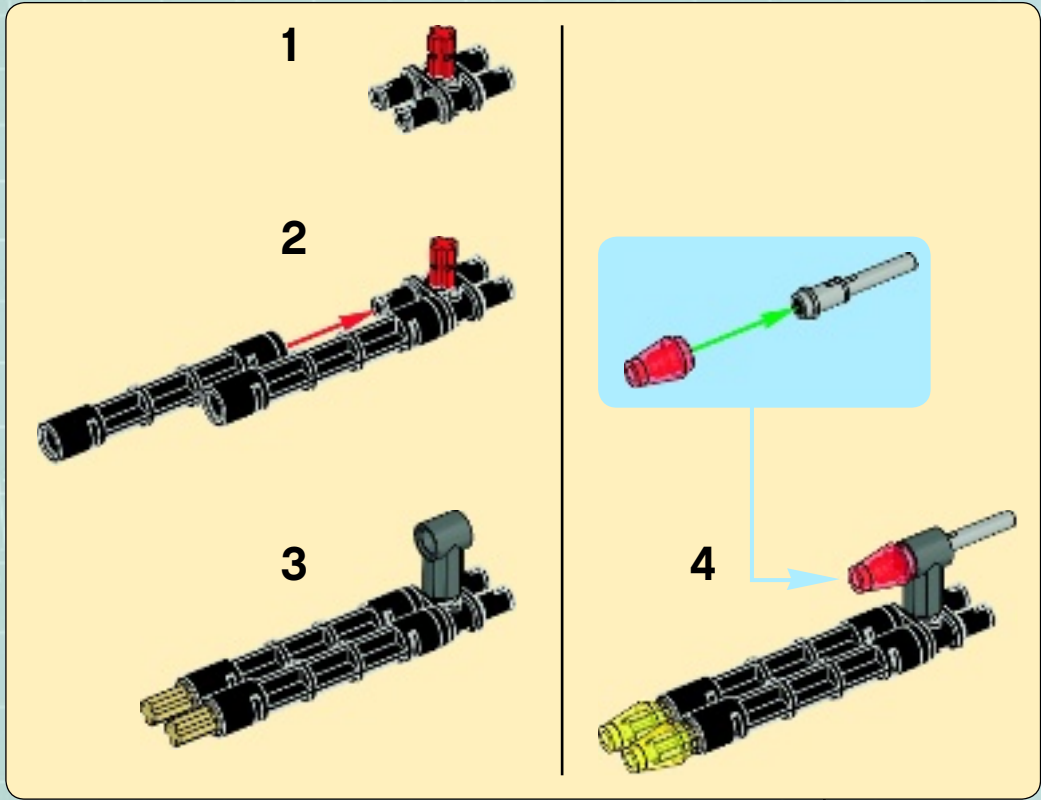

31

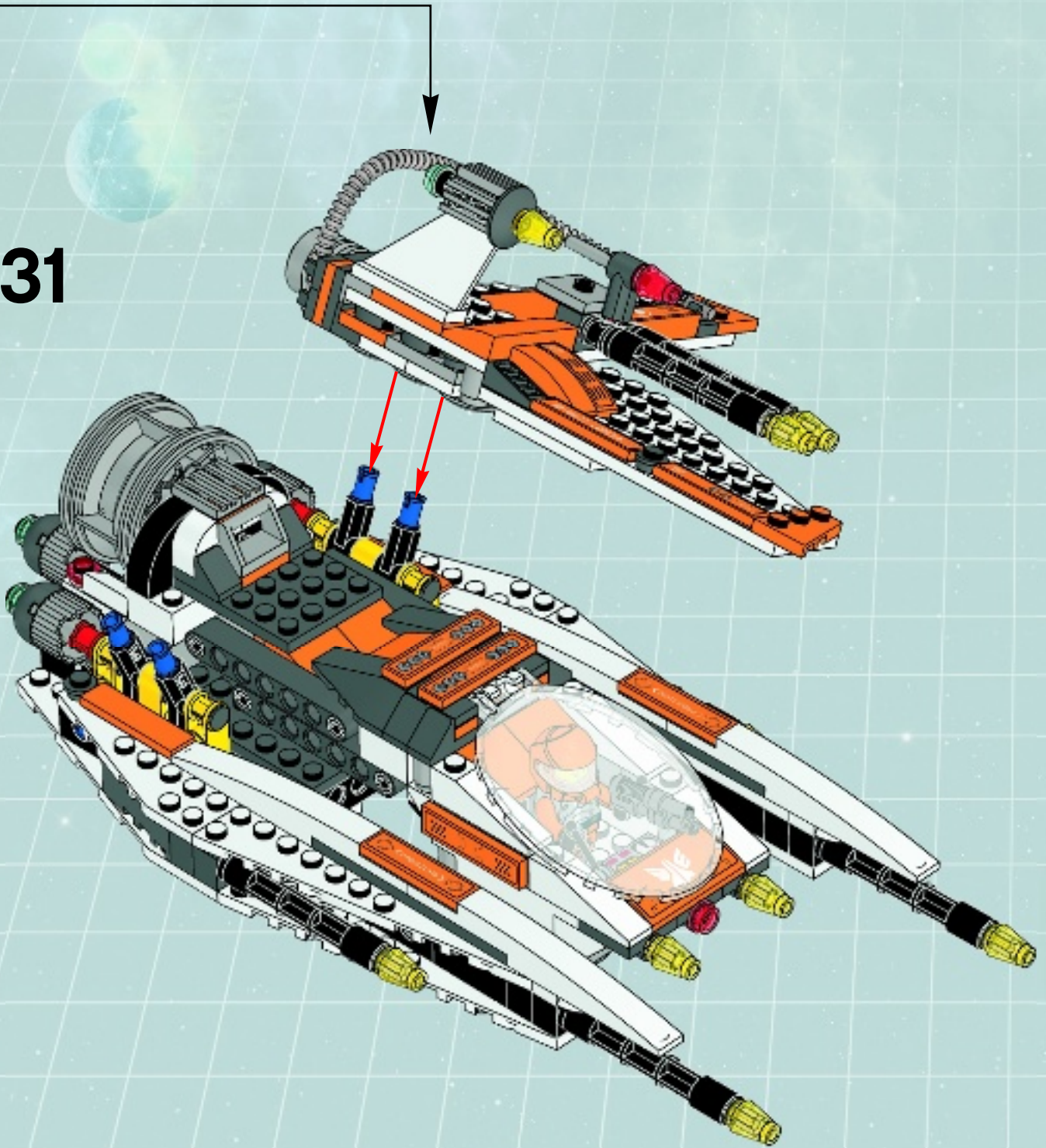

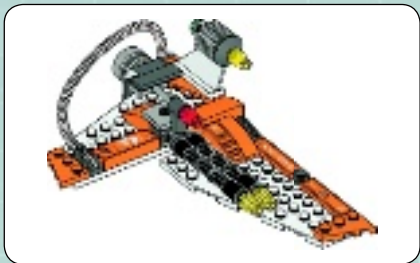

1x

1

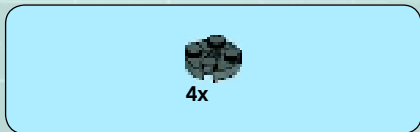

4x

2



2x

2x

3

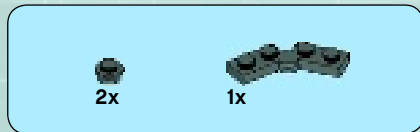
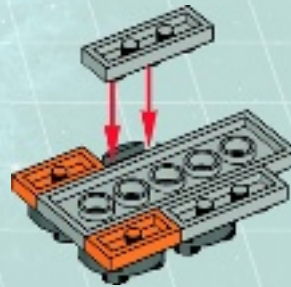
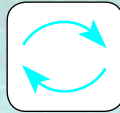

2x

1x

4

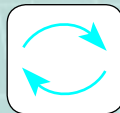

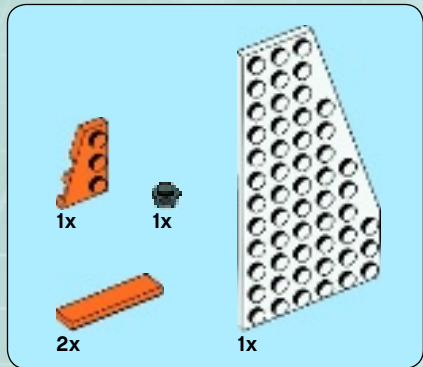

5

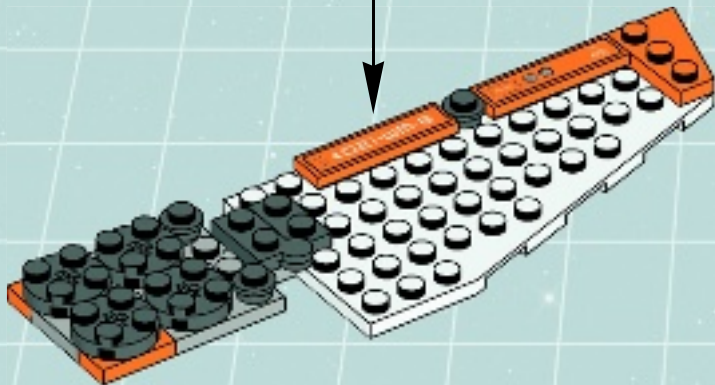
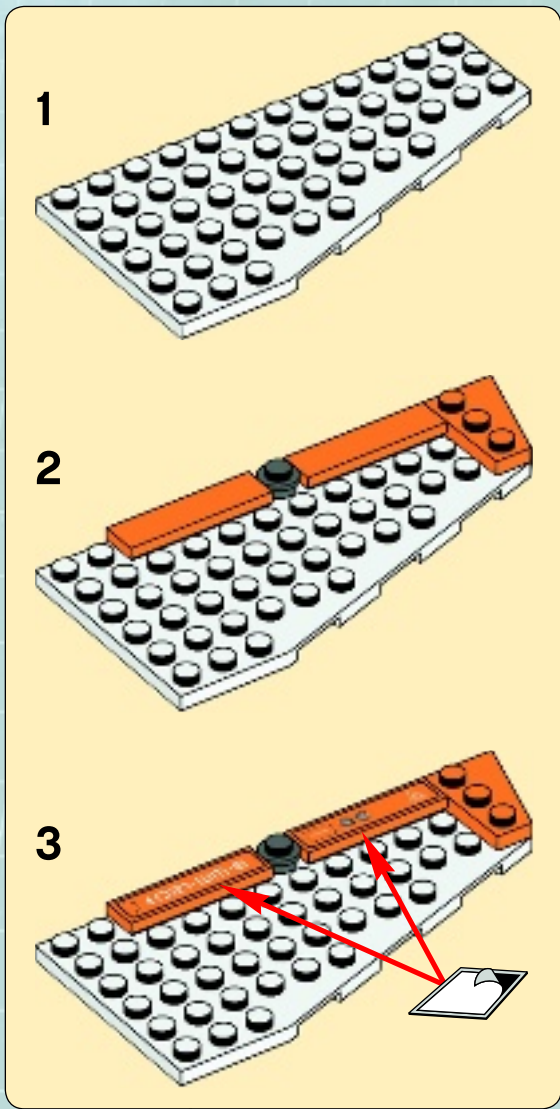



6

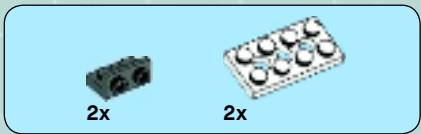
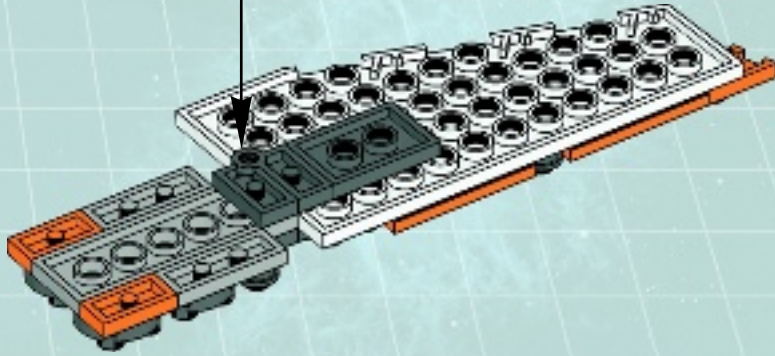
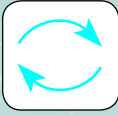

7

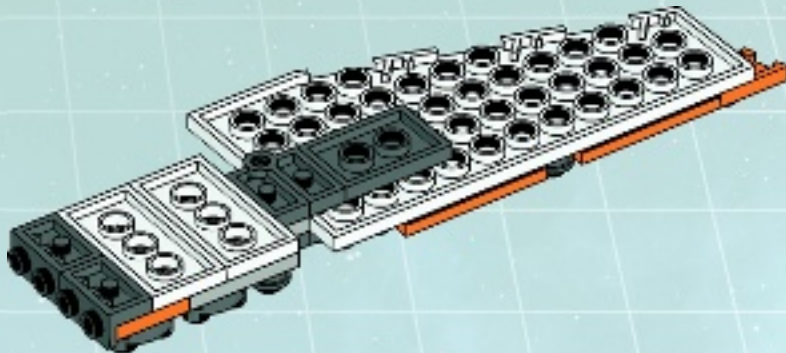

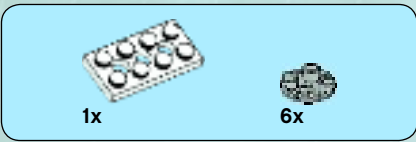

8

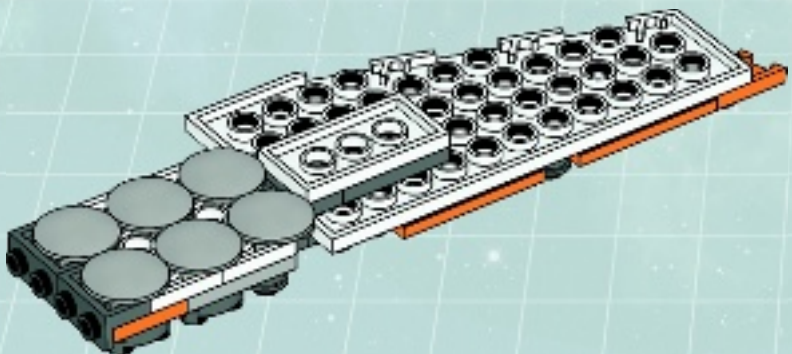

9

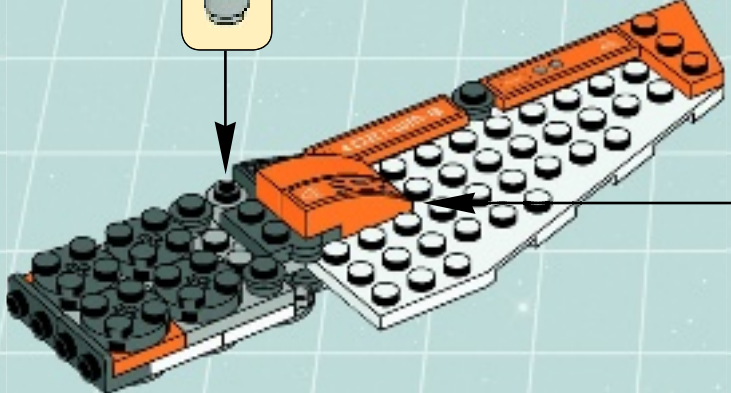
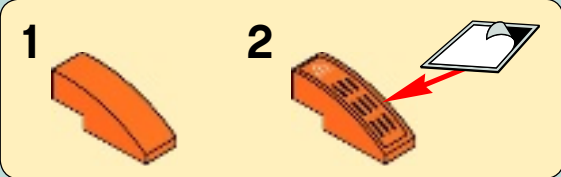

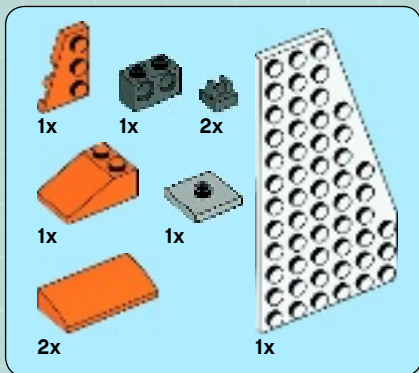

10

1



2

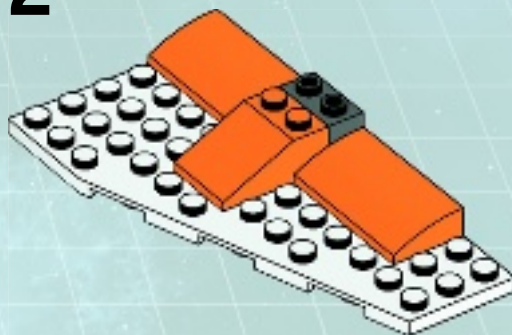

3

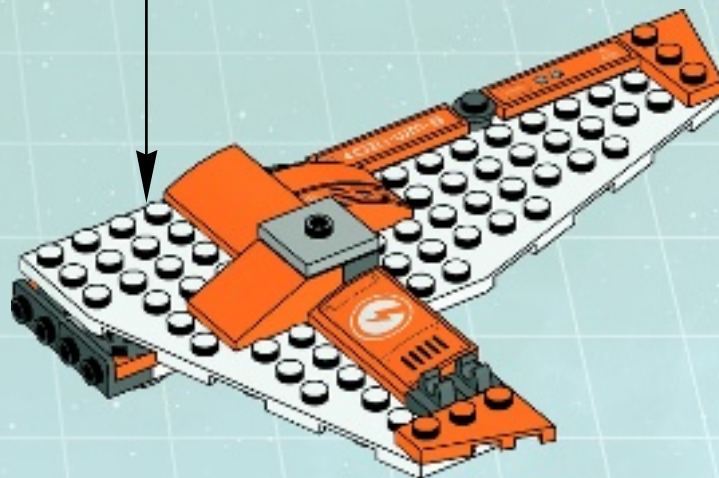
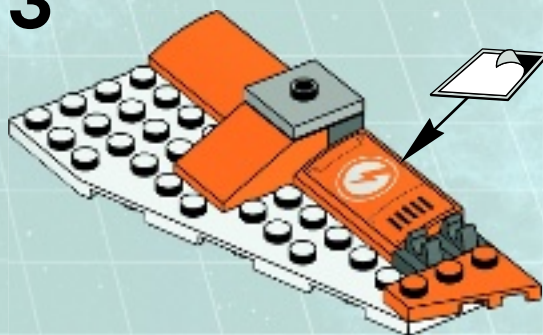

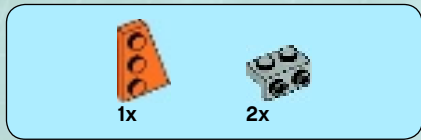

11

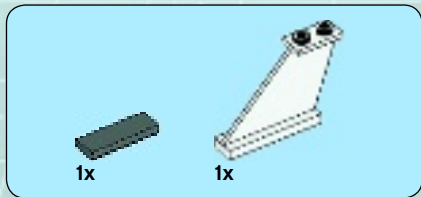
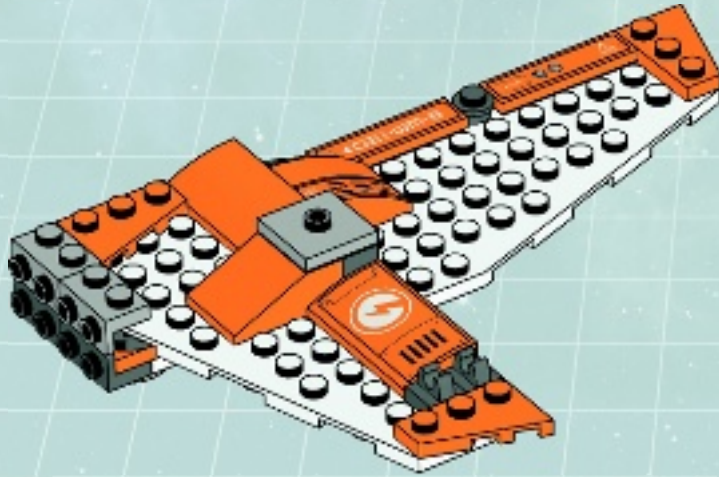

12

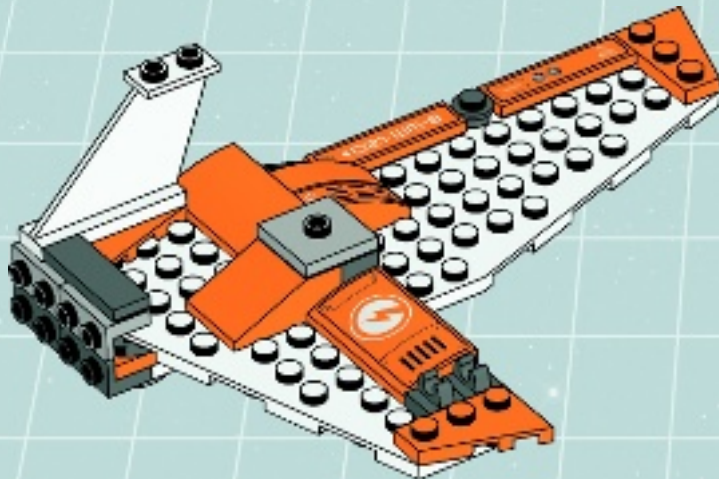

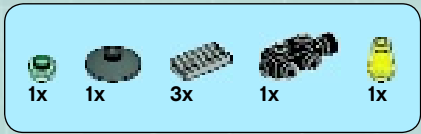

13

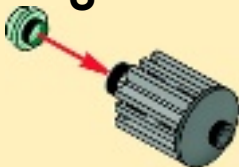
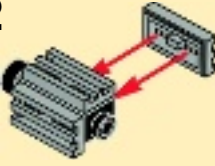
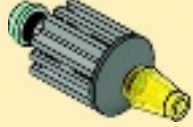

| | |
|--|--|
| <p>1</p>  | <p>3</p>  |
| <p>2</p>  | <p>4</p>  |

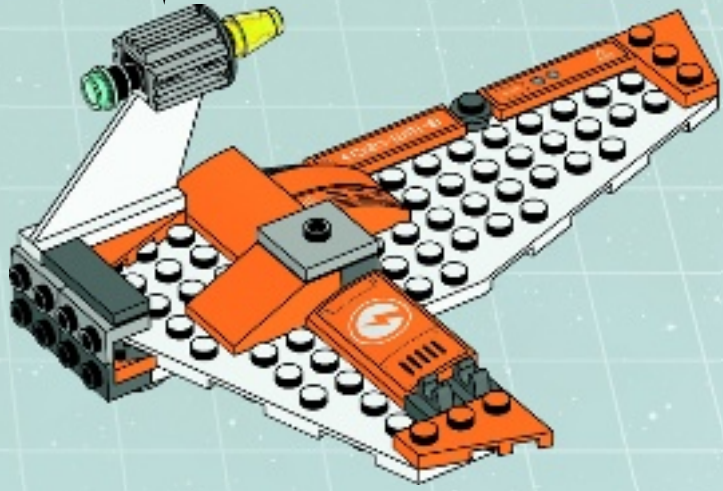



14

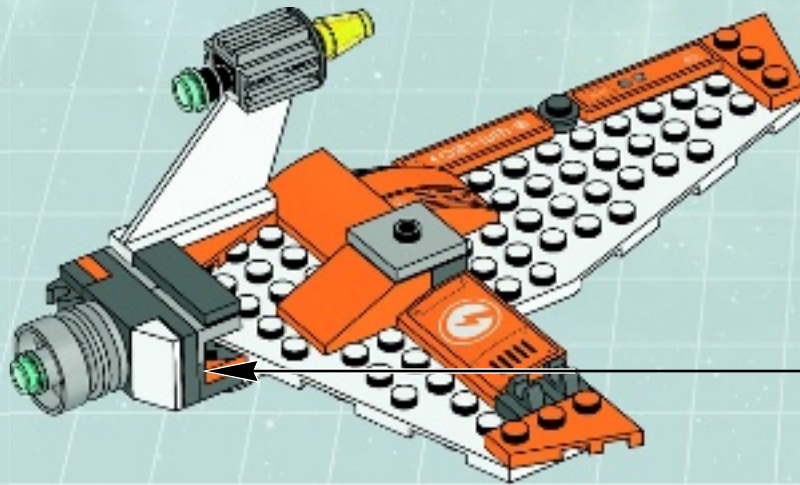
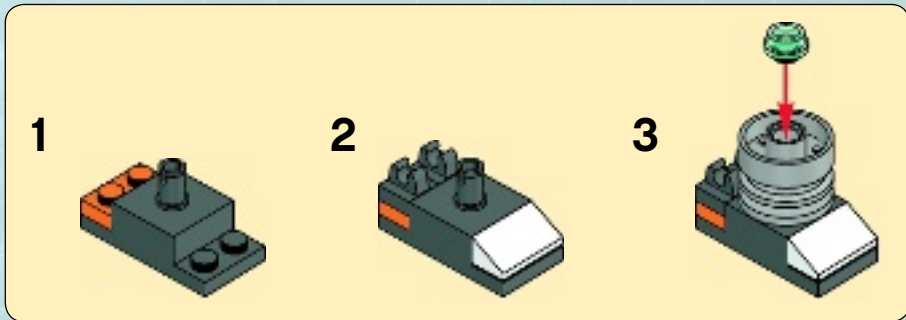

15

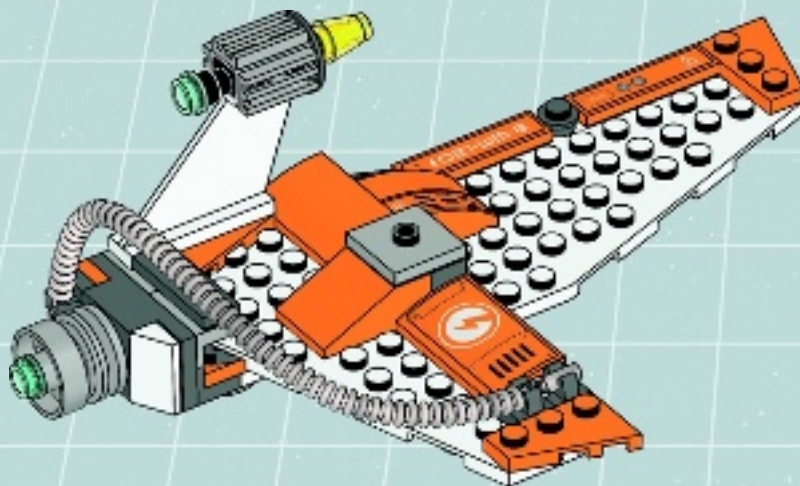

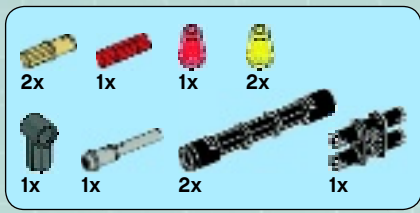

16

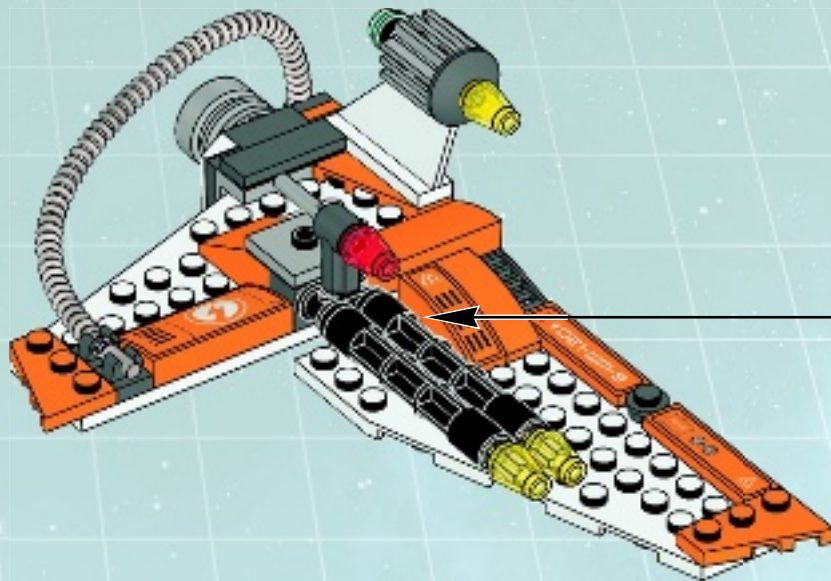
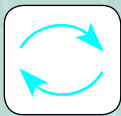
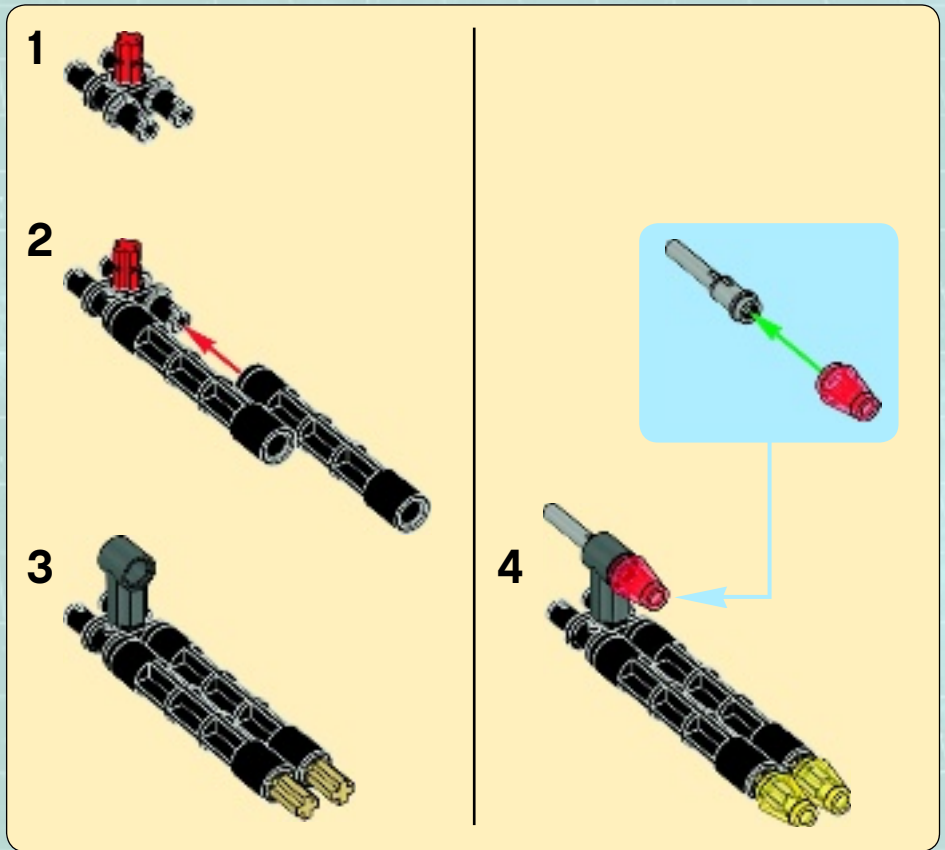

32

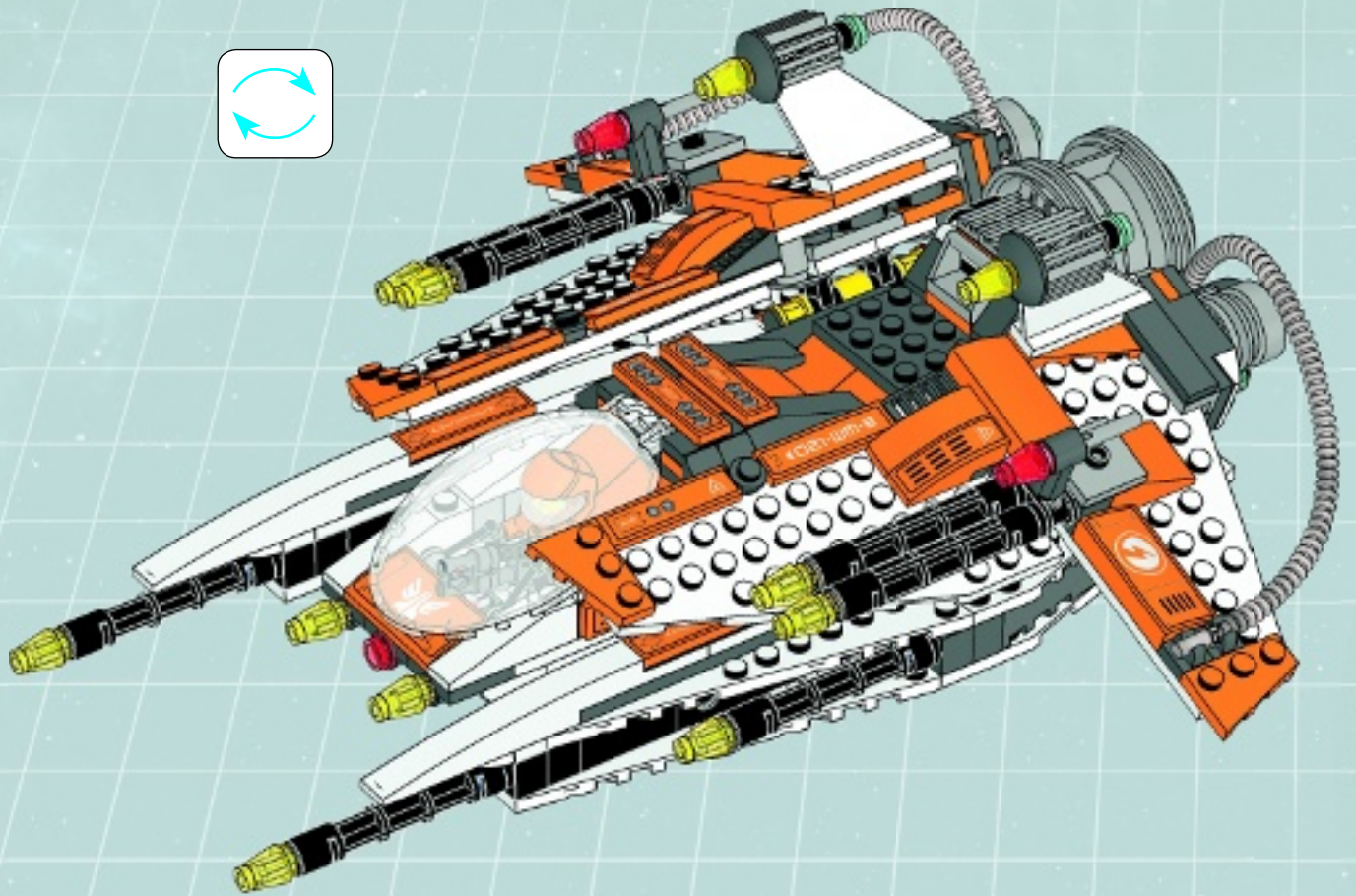
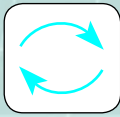

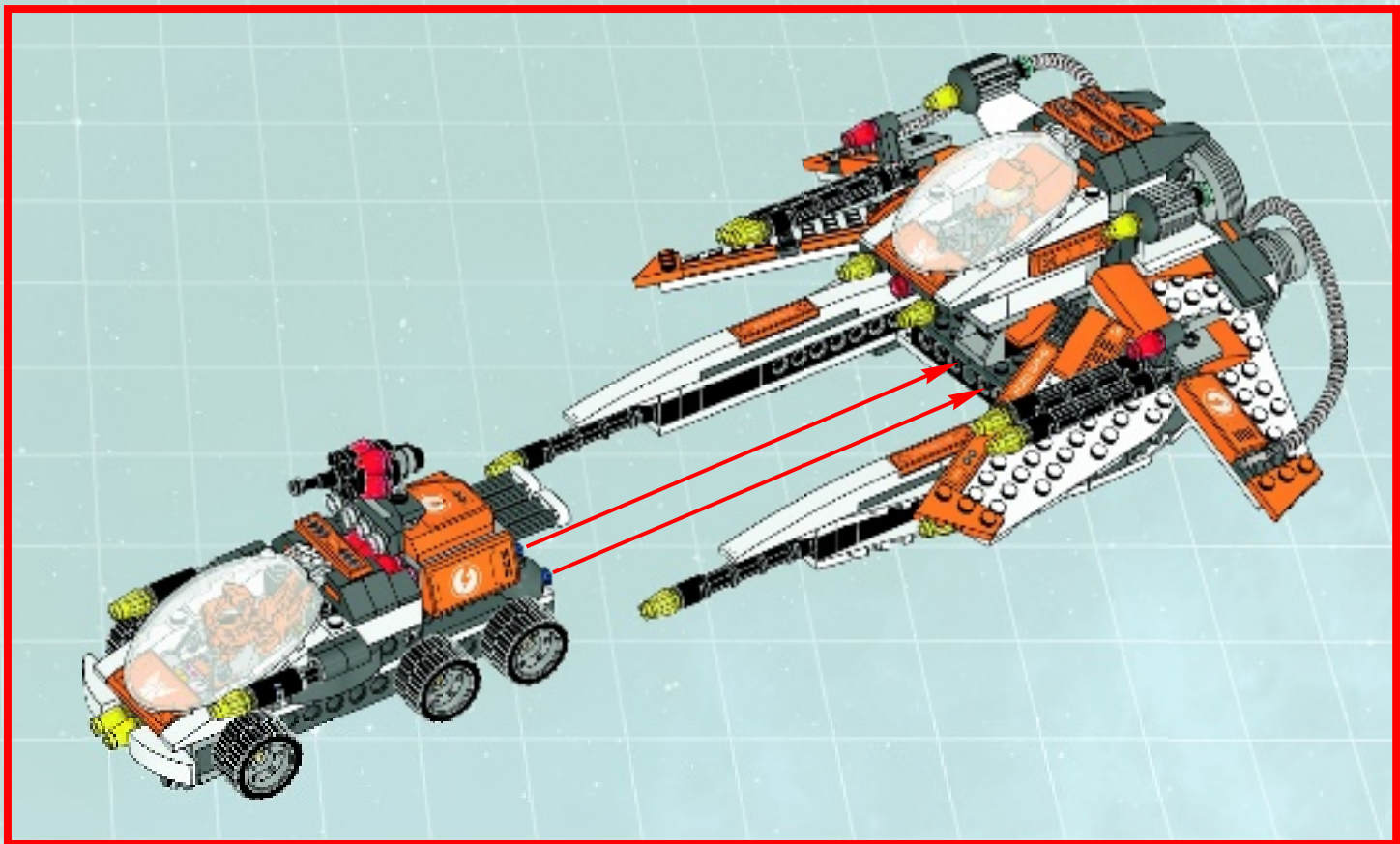
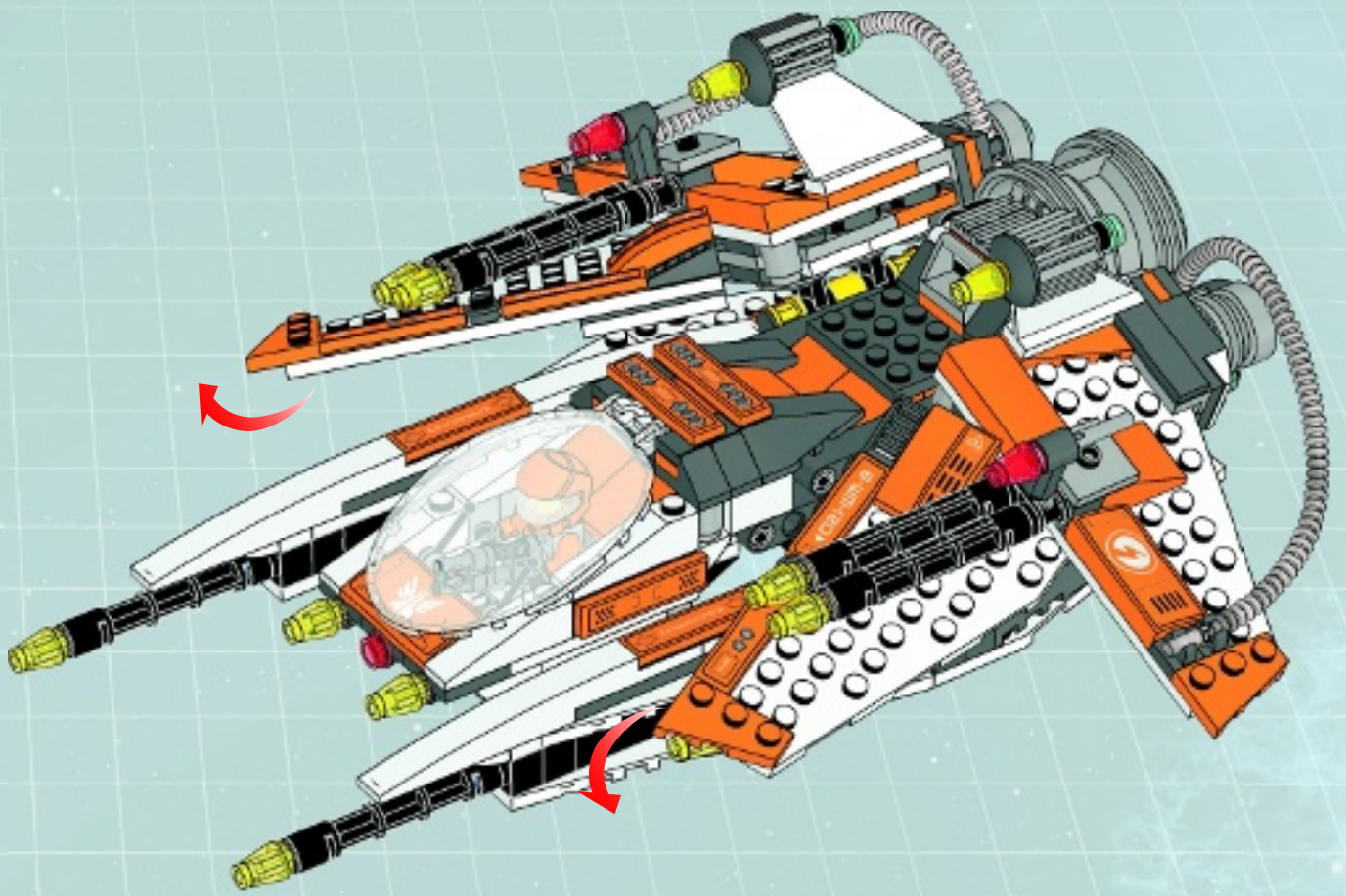

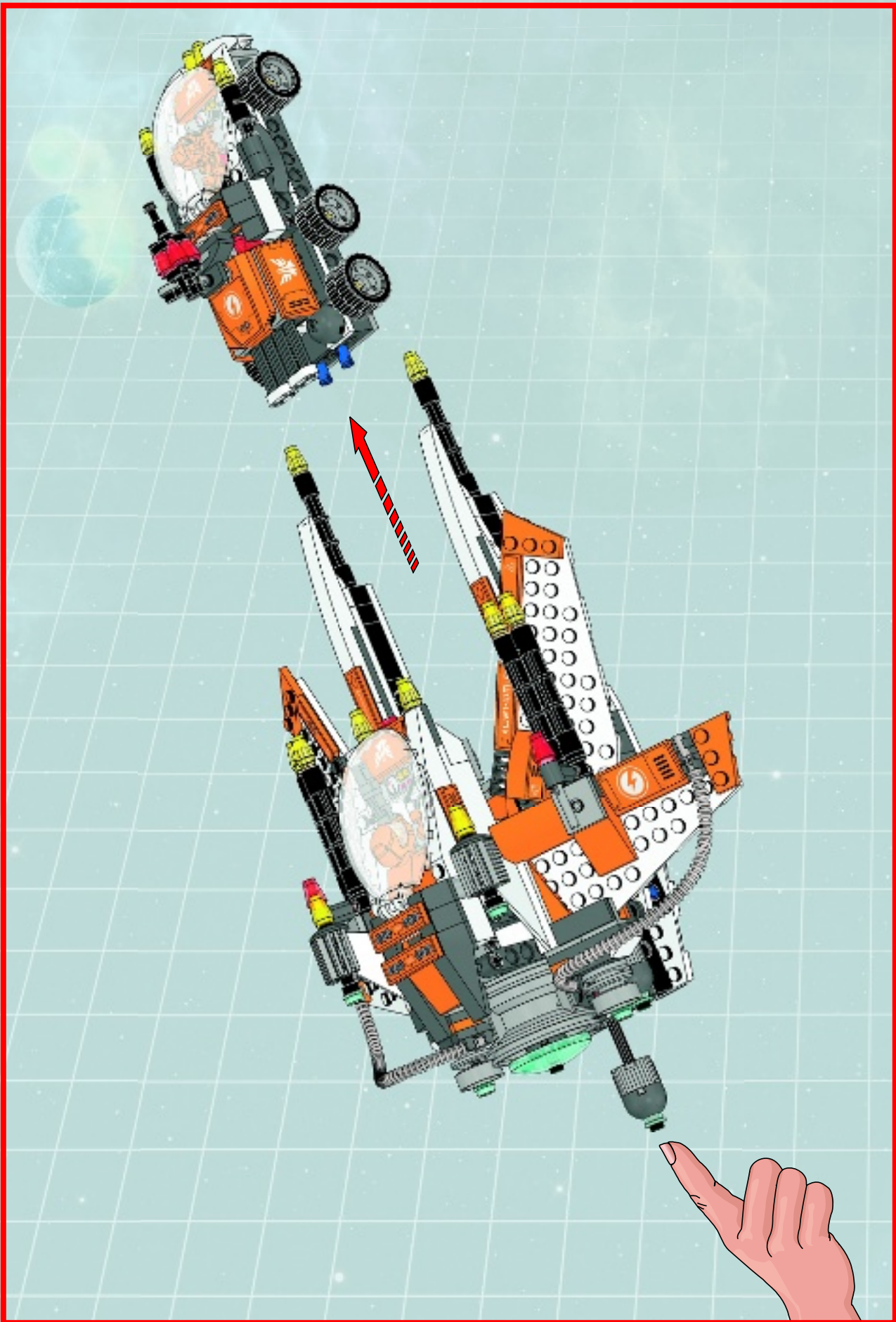

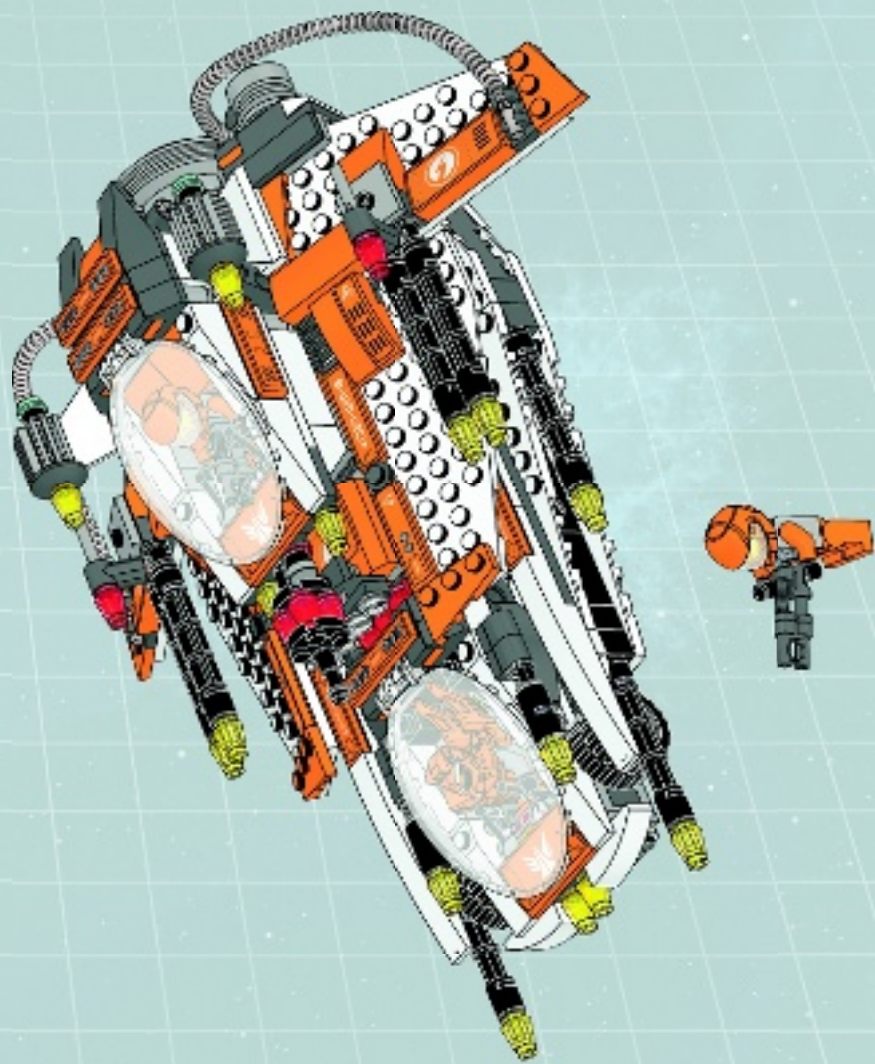

4x
362201



80



2x
4163533



2x
4604304



2x
374726



1x
4153826





1x
4599535

1x
4212454

2x
4504372

8x
4183133

1x
6023954

14x
4579250

1x
4650634

4x
4540385

2x
4567340

2x
6021966

3x
4528604

3x
4626904

2x
6021969

6x
4541506

4x
4568753

2x
4539060

2x
4631233

2x
6028094

2x
4558953

2x
6015344

2x
4211833

2x
4211636

8x
4211412

3x
4650645

1x
4211640

2x
4217918

2x
4565393

4x
4211429

5x
4211452

11x
4211350

2x
4227776

6x
6009014

2x
4654580

4x
4654582

1x
4211632

1x
4244627

1x
4211804

2x
4211542

1x
4650260

17x
4278273

2x
4211357

4x
4221775

6x
4520320

1x
4211815

1x
4211628

2x
6029733

1x
6023015

6x
4490127

2x
4299119

4x
4211610

2x
4211651

1x
4634091

1x
4210867

1x
4210866

8x
6030710

2x
4611703

4x
6000606

2x
4210883

8x
6013082

4x
4196768

1x
4211055

2x
4568734

1x
4211095

4x
6019987

2x
4239373

5x
4161674

1x
4287972

1x
4287973

1x
4210639

12x
4210762

4x
4210917

2x
4211137

2x
4504378

10x
4621917

3x
4648256

2x
4219725

2x
4210844

2x
4211010

9x
4211119

3x
4211043

2x
4211001

1x
4243831

2x
4210998

5x
4211115

2x
4211051

4x
4271344

8x
4210633

15x
4211042

2x
4623236

2x
4540386

2x
4289542

4x
4495931

3x
4210658

5x
4560177

2x
4499858

1x
6021973

1x
4625812

8x
4625376

1x
6023276

1x
6023014

1x
6022916

2x
4615232

Customer Service
Kundenservice
Service Consommateurs
Servicio Al Consumidor

LEGO.com/service or dial



: 00800 5346 5555
: 1-800-422-5346

LEGO

**GALAXY
SQUAD**



70700



70701



70702



70703



70704



LEGO



GALAXY
SQUAD



LEGO.com/galaxysquad



WIN!

Go to www.LEGOsurvey.com/product to fill out a survey for a chance to win a cool LEGO® Product.

No purchase necessary.

Open to all residents where not prohibited.



LEGO.com



www.LEGOsurvey.com/product

GEWINNE!

Nimm an der Umfrage auf www.LEGOsurvey.com/product teil und hab die Chance ein cooles LEGO® Produkt zu gewinnen!

Die Teilnahme am Gewinnspiel führt zu keinerlei Kaufverpflichtungen. Teilnahme in allen nicht ausgeschlossenen Ländern möglich.

WIN!

Ga naar www.LEGOsurvey.com/product, vul een enquêteformulier in en maak kans op een cool LEGO® product.

Geen aankoopverplichting. Iedereen mag deelnemen, uitgezonderd ingezetenden van landen waar een enquêteverbod geldt.

GAGNE!

Visite www.LEGOsurvey.com/product pour répondre à un questionnaire et avoir une chance de gagner un produit LEGO® très cool!

Aucune obligation d'achat. Ouvert à tous les résidents des pays autorisés.

当てよう!

www.LEGOsurvey.com/product にアクセスして、アンケートにご記入ください。当選者にはレゴ製品を差し上げます。

お買い上げの必要はありません。禁止されていない限り、すべての皆様にご利用いただけます。