



# Castle



70404





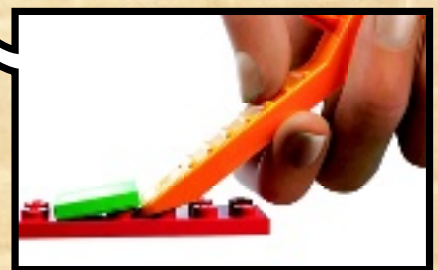
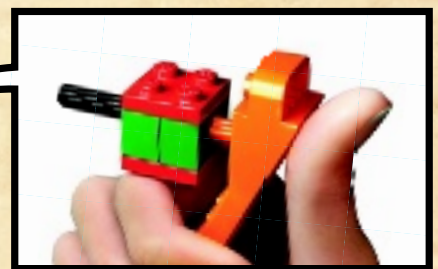
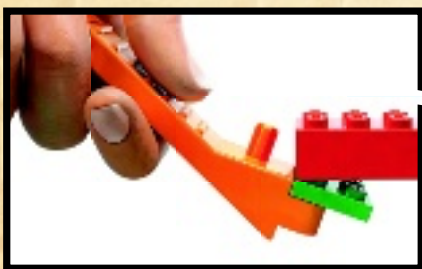
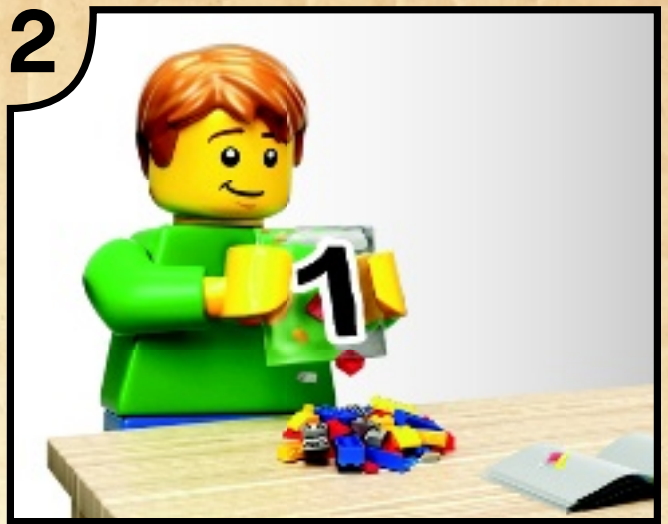



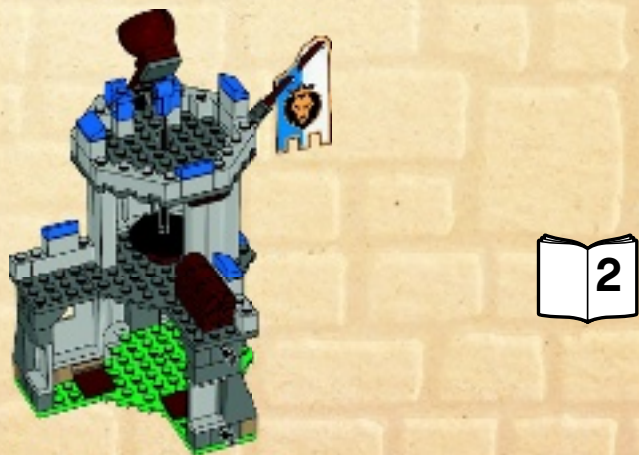
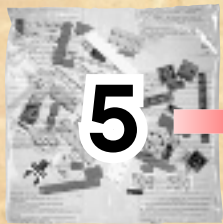
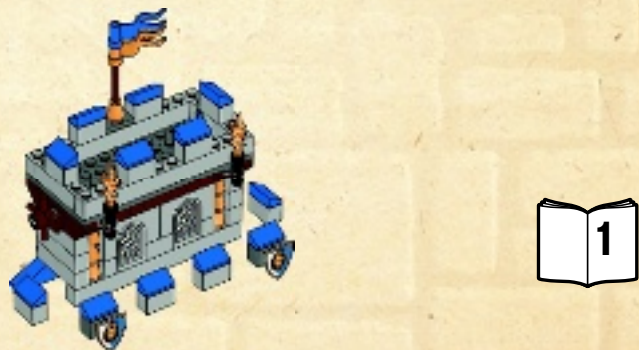
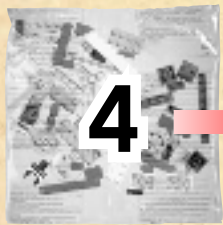
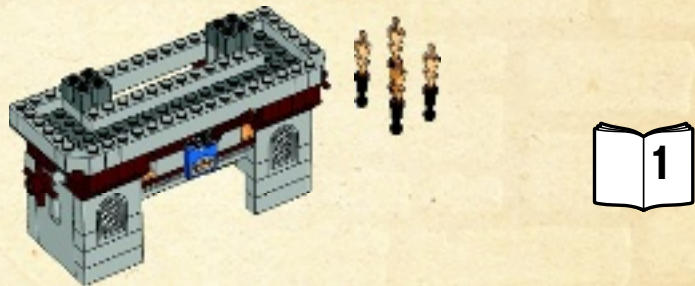
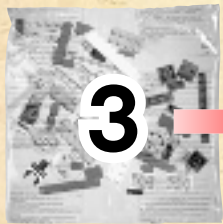
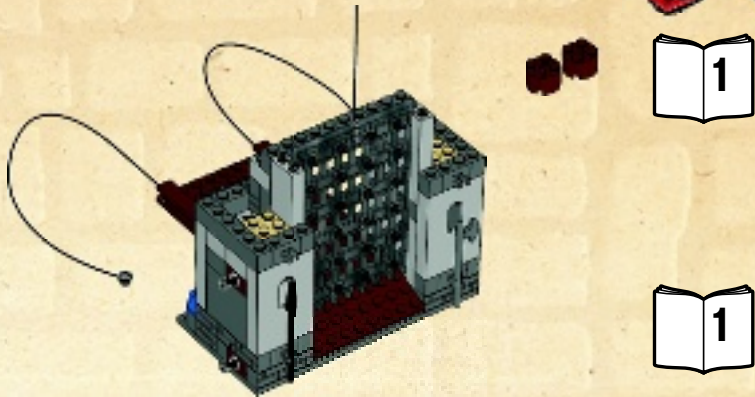
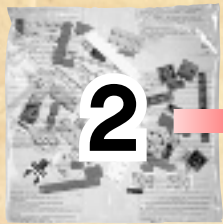





6

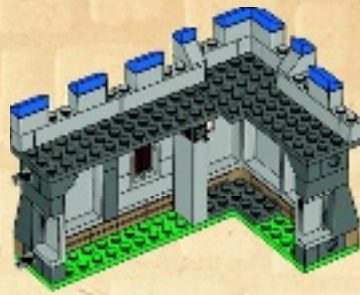

7

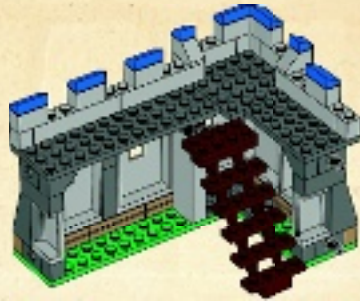

8

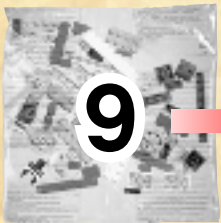
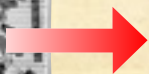

9



10





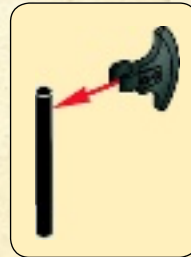
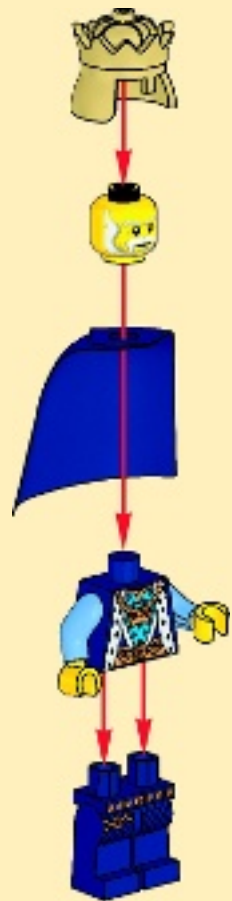



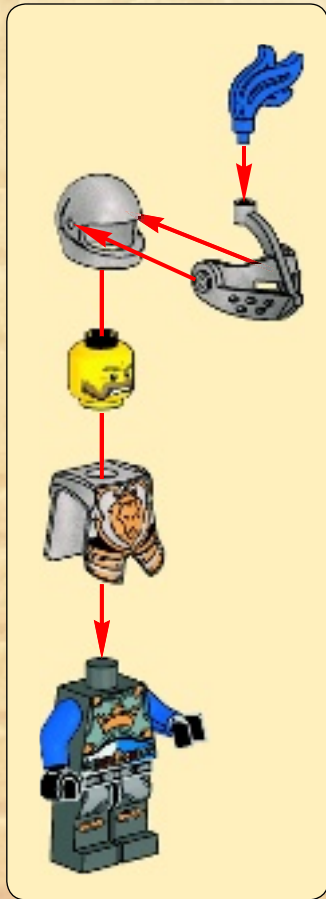

1

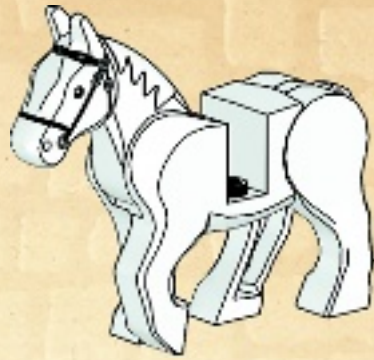

2

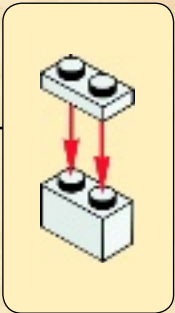
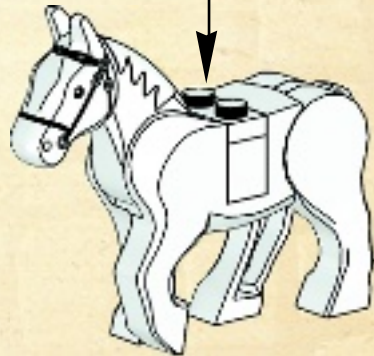

3





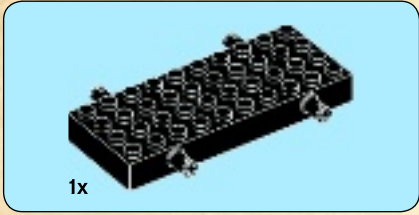
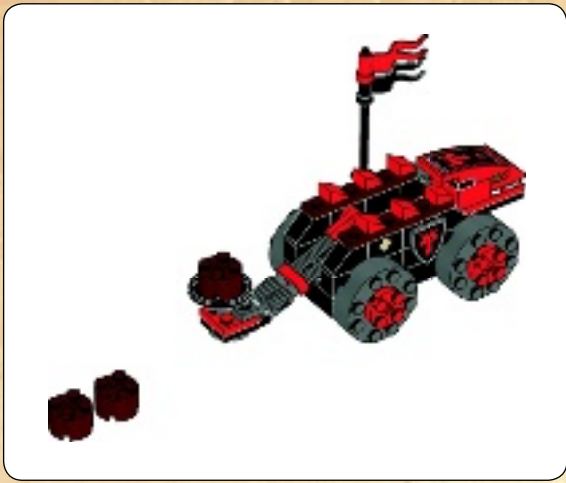

1

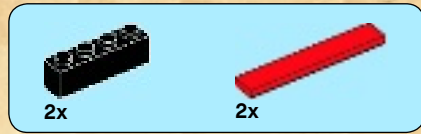
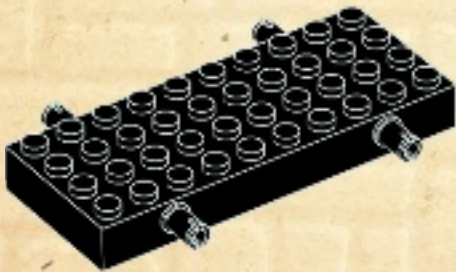

2

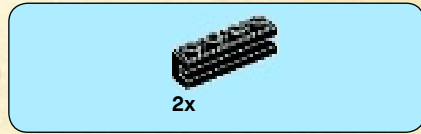
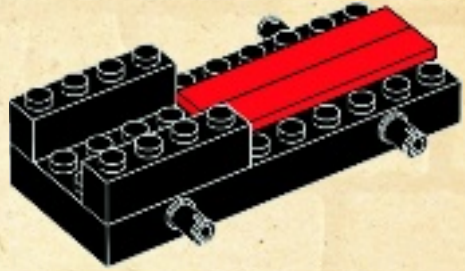

3

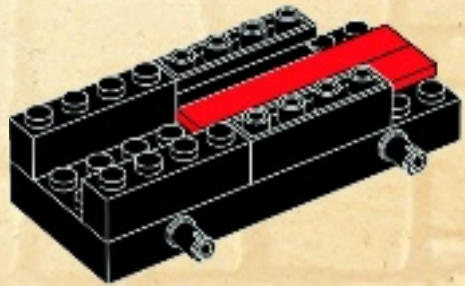



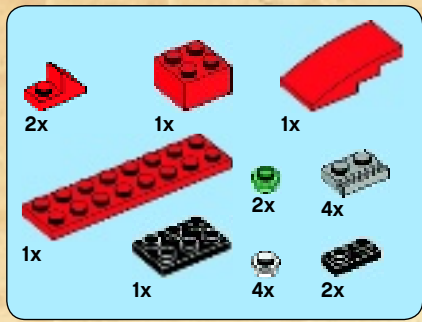

4

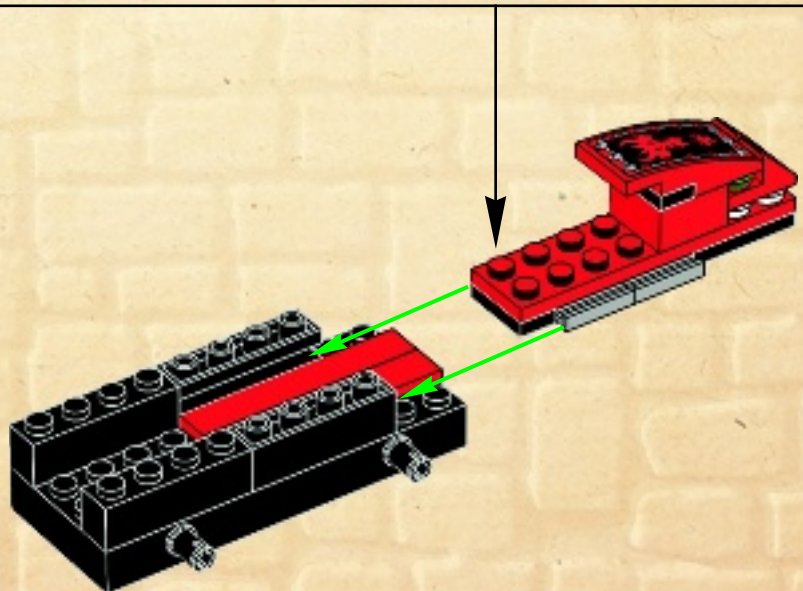
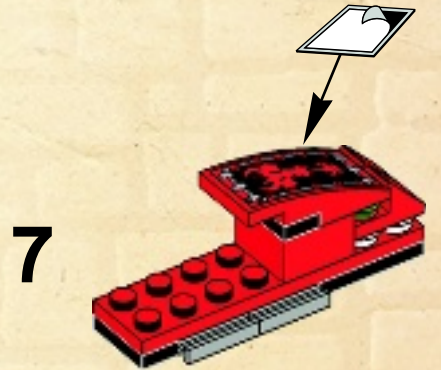
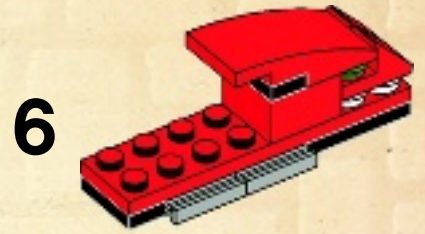
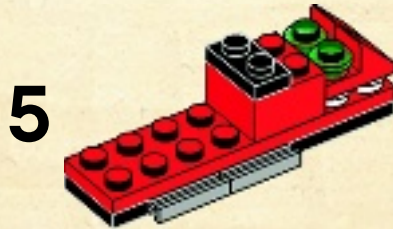
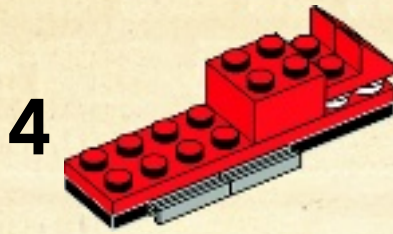
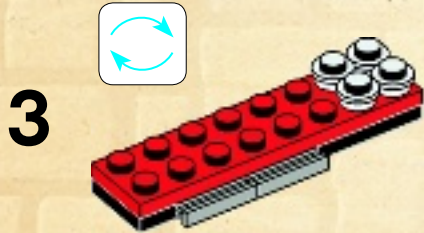
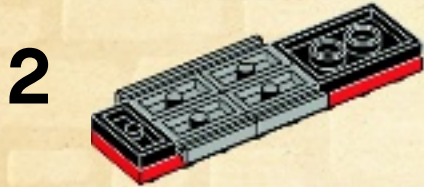



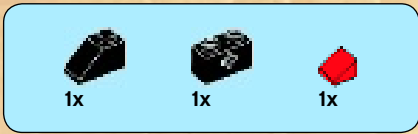

5

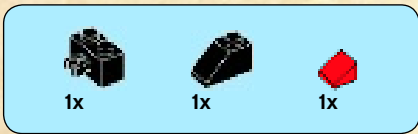
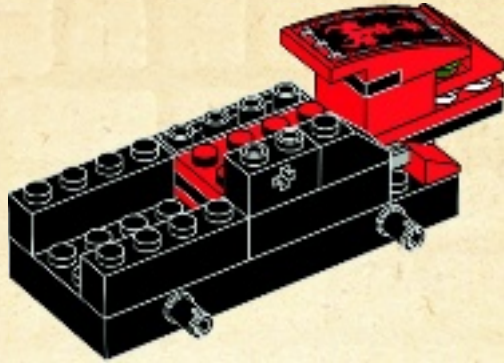

6

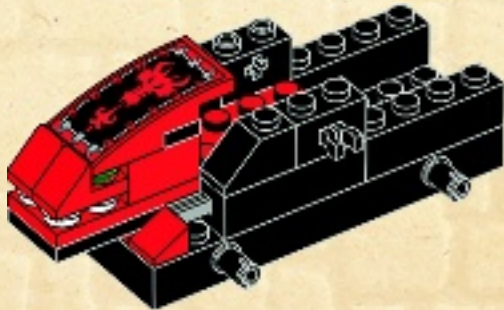
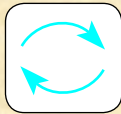





# 7

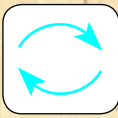

- 1
- 2
- 3

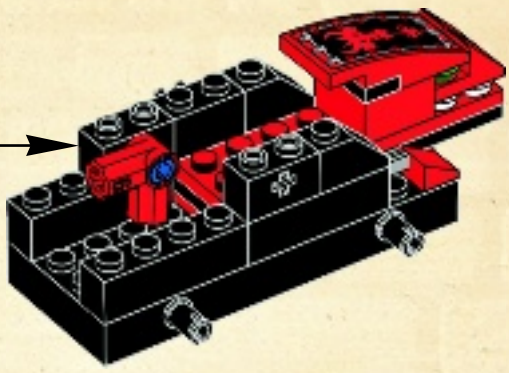

# 8

- 1
- 2
- 3

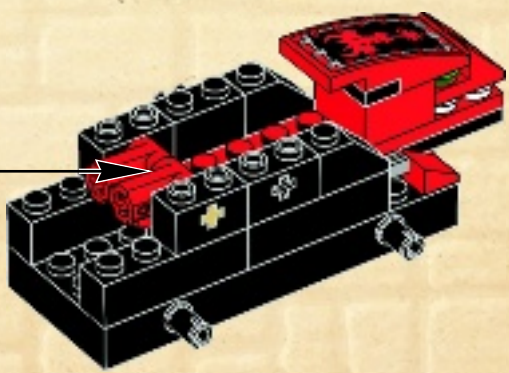



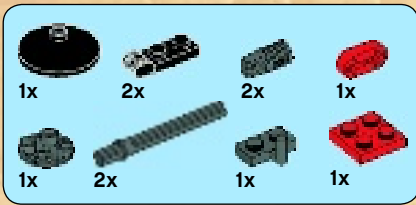

# 9

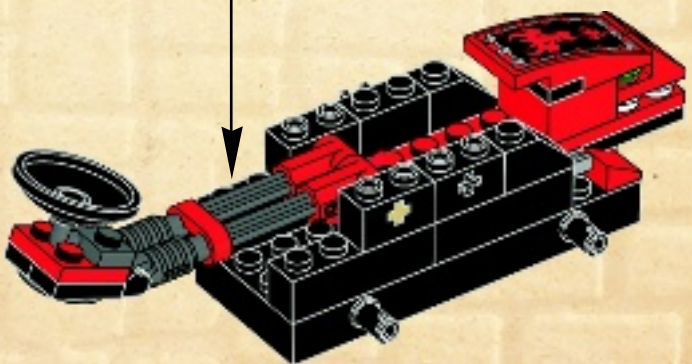
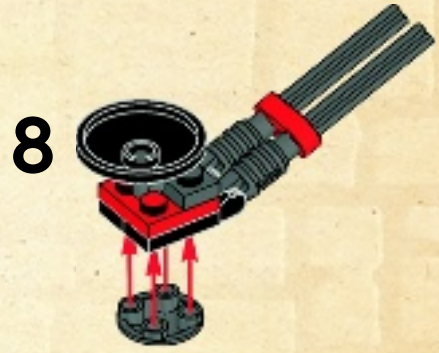
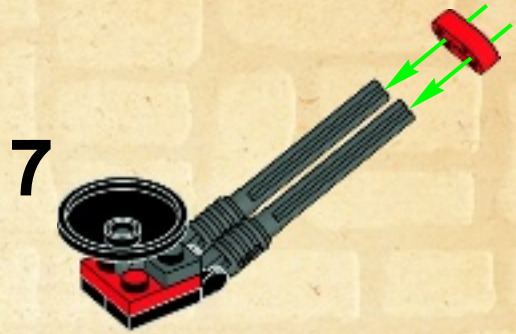
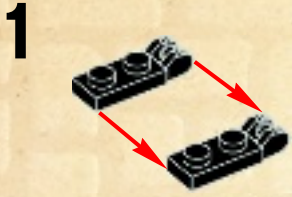





2x

# 10

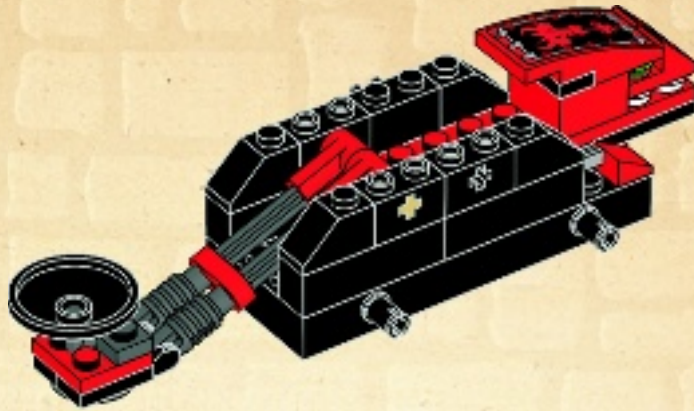

2x

# 11

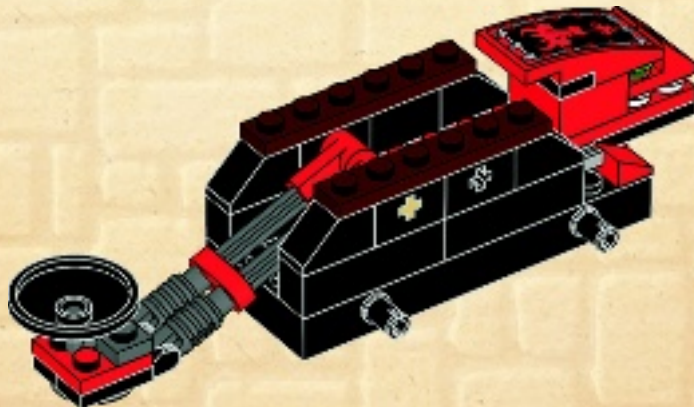





6x

# 12

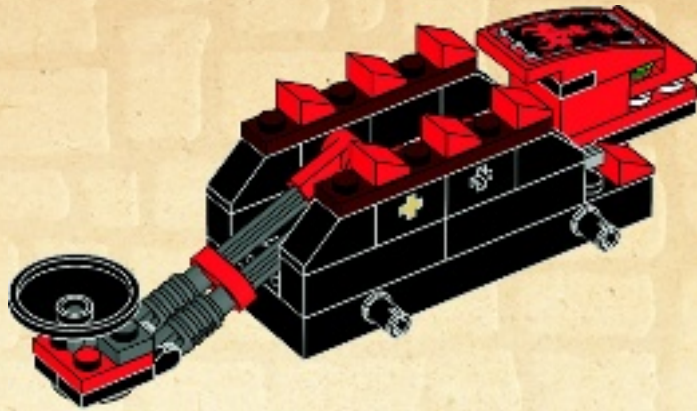

4x



4x

# 13



4x

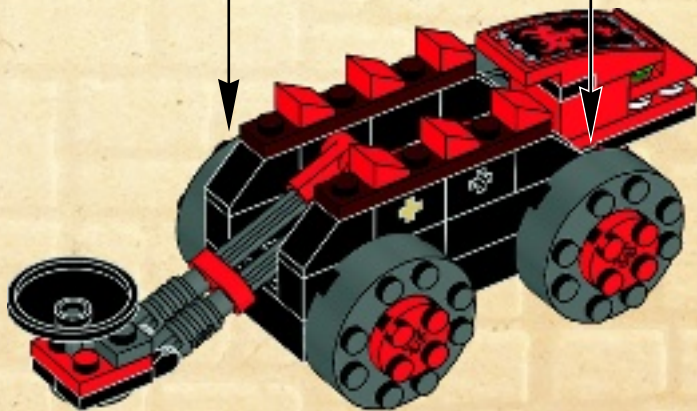



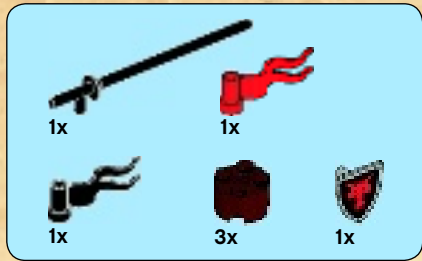

14

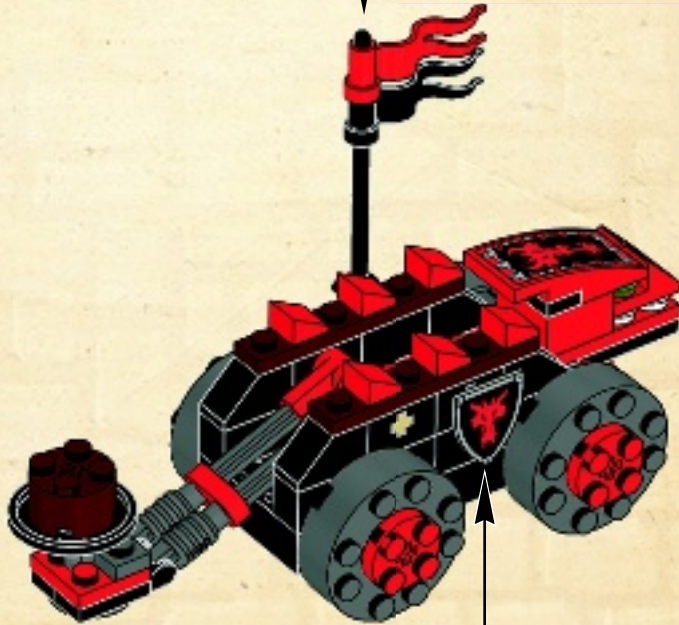
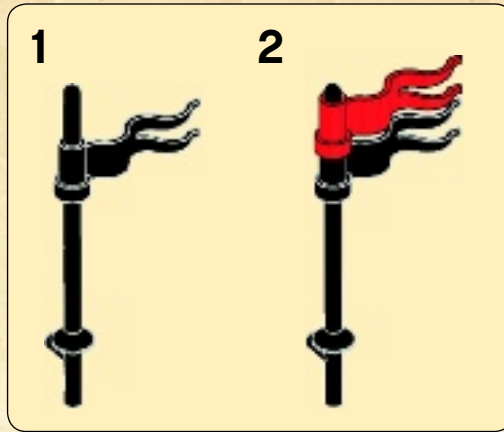



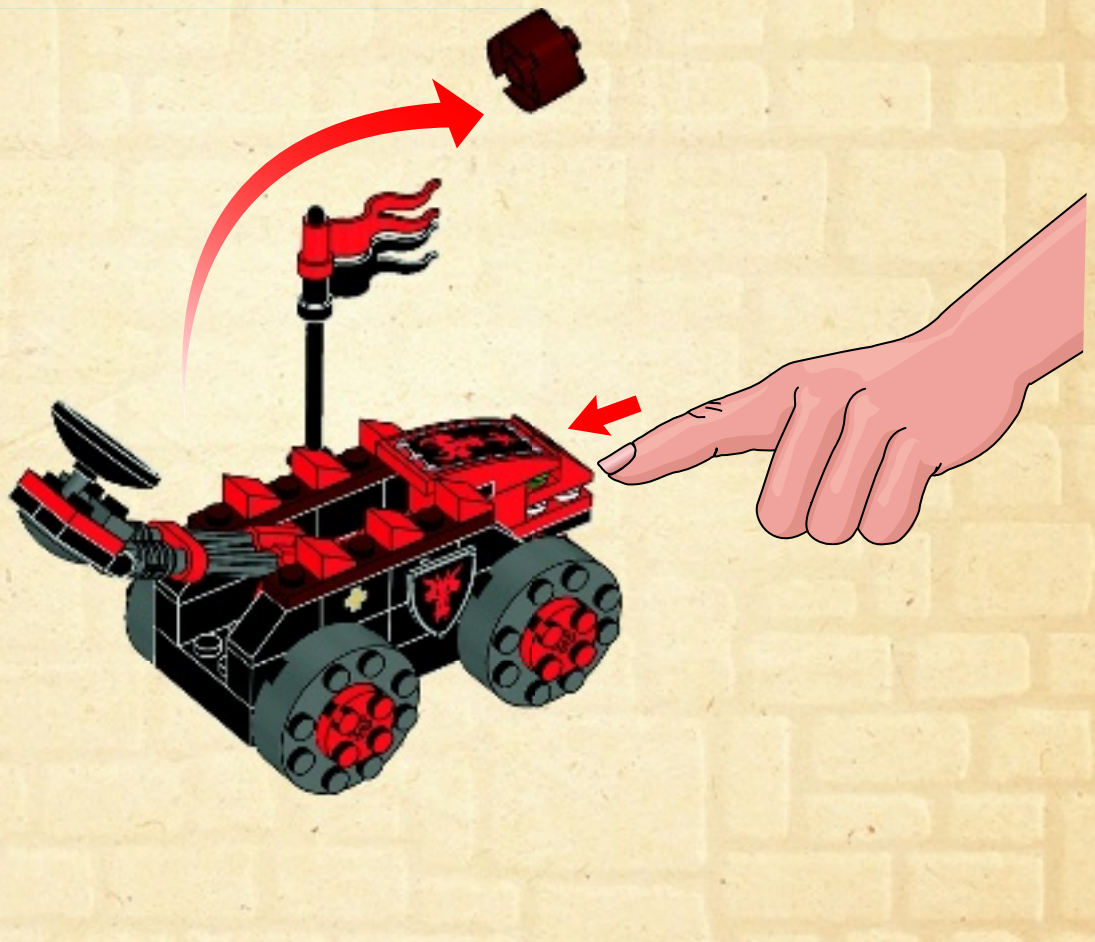



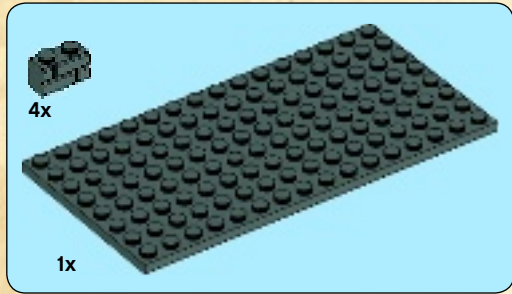
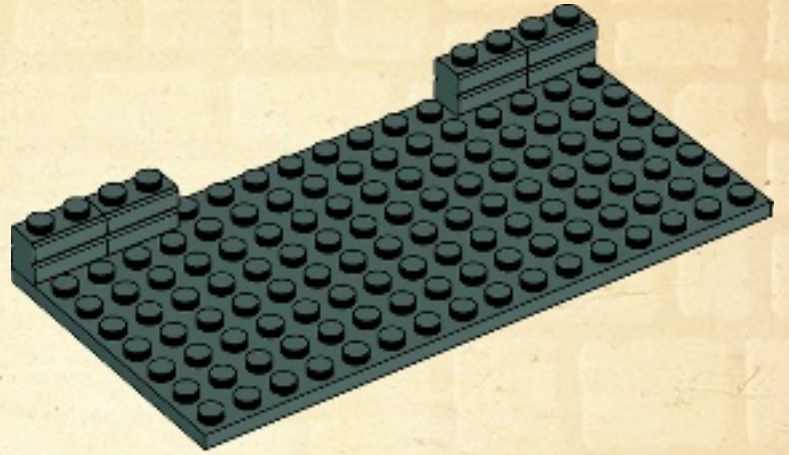
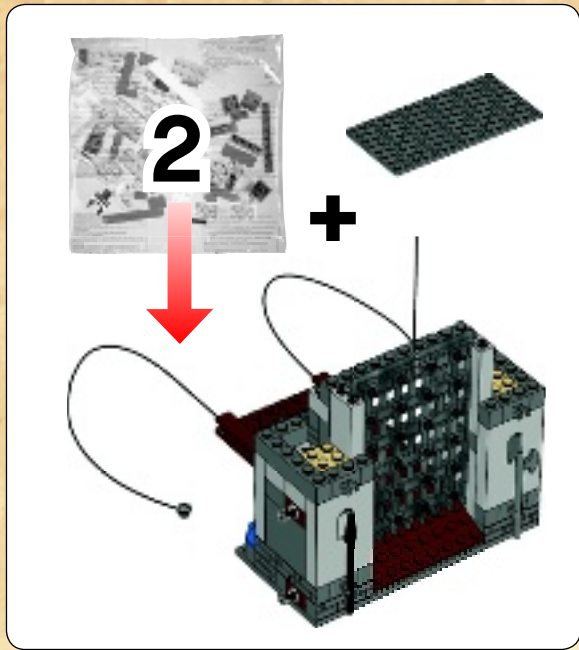

1



2

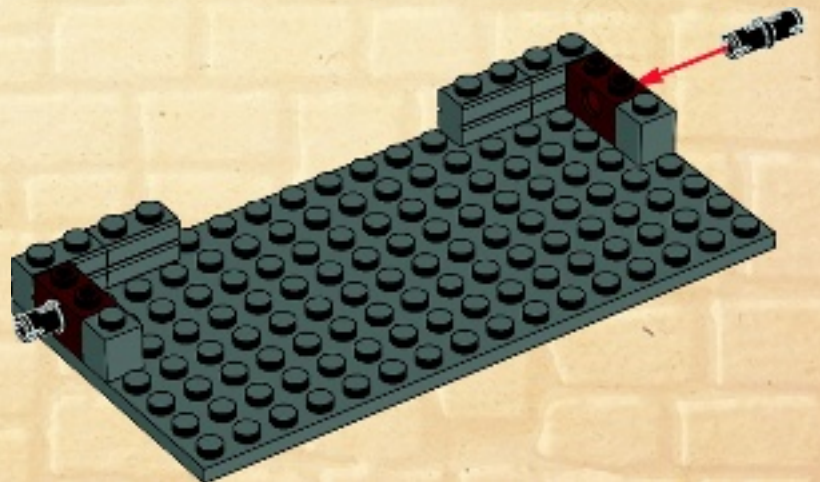



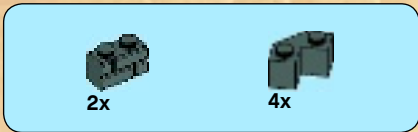

3

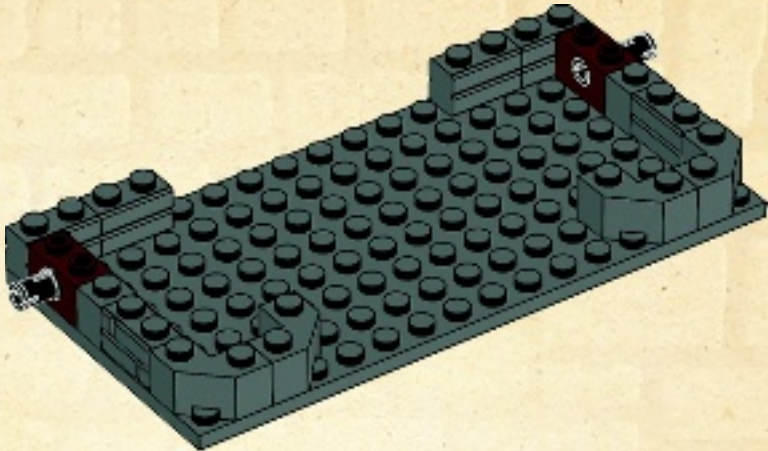

4

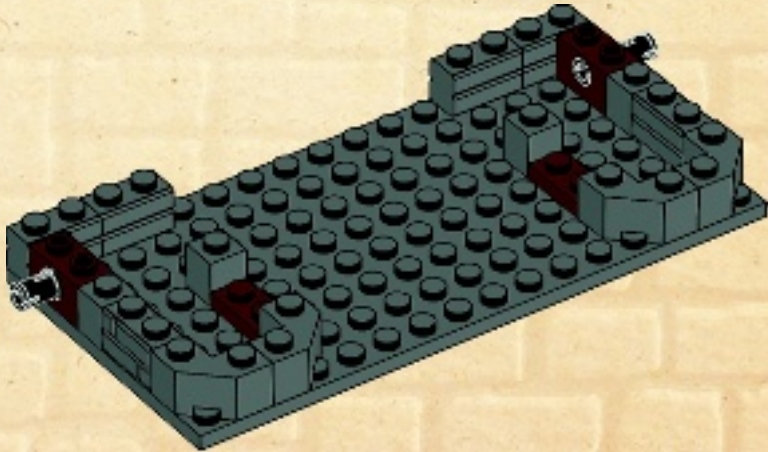





5

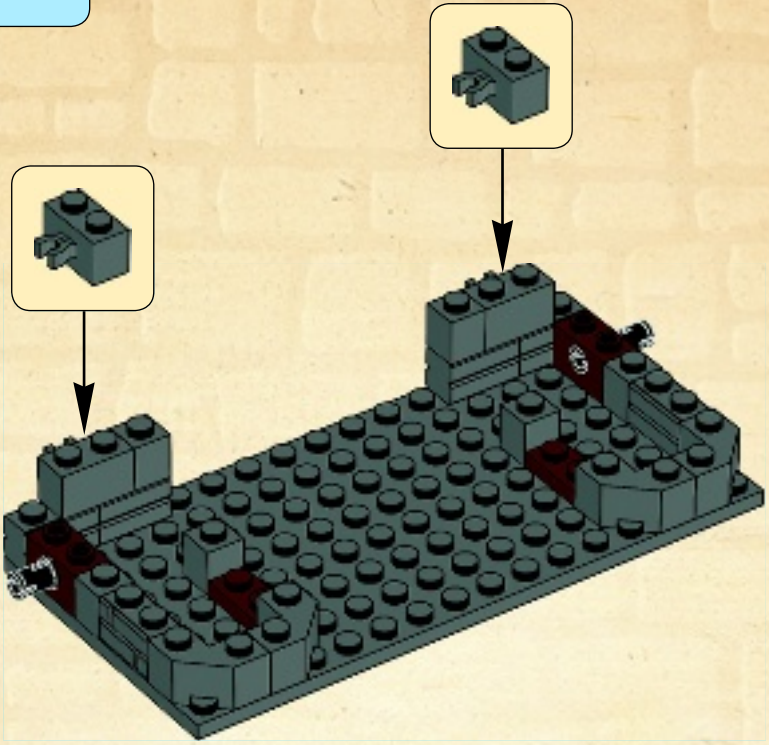

6

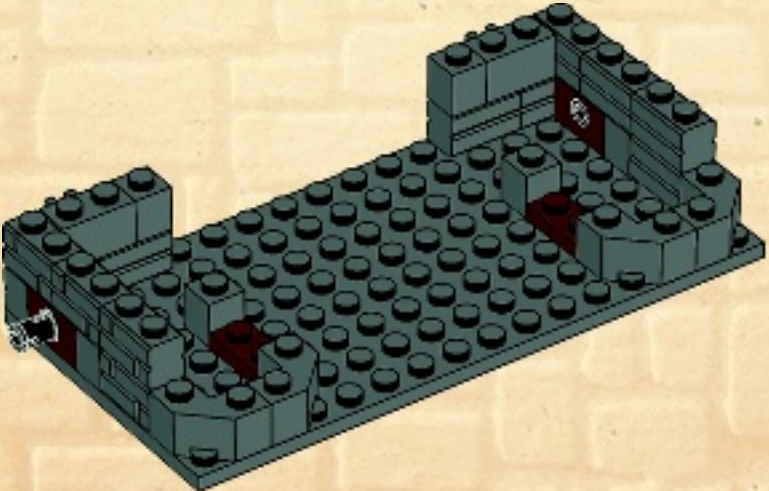



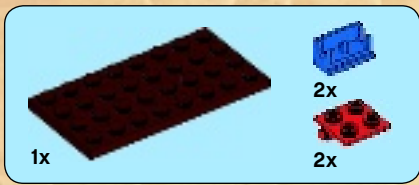

7

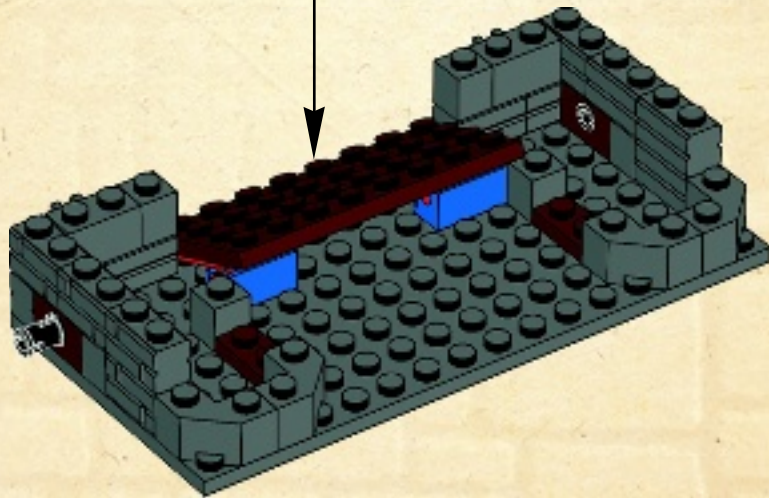
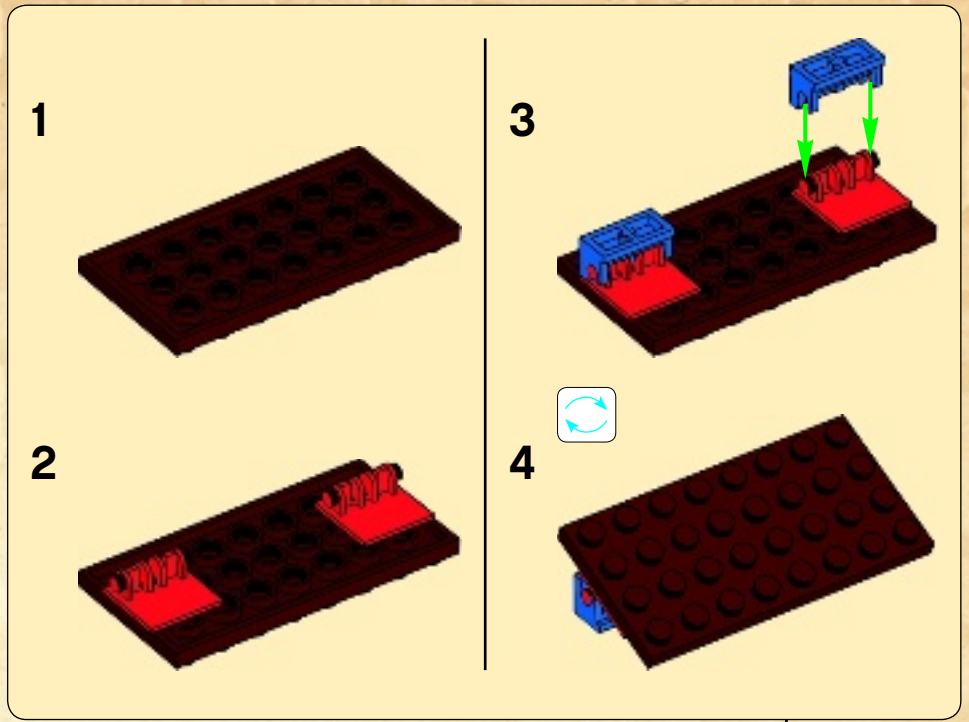



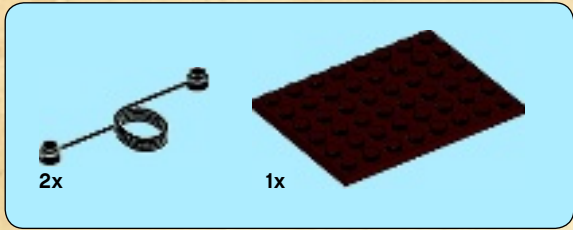

1

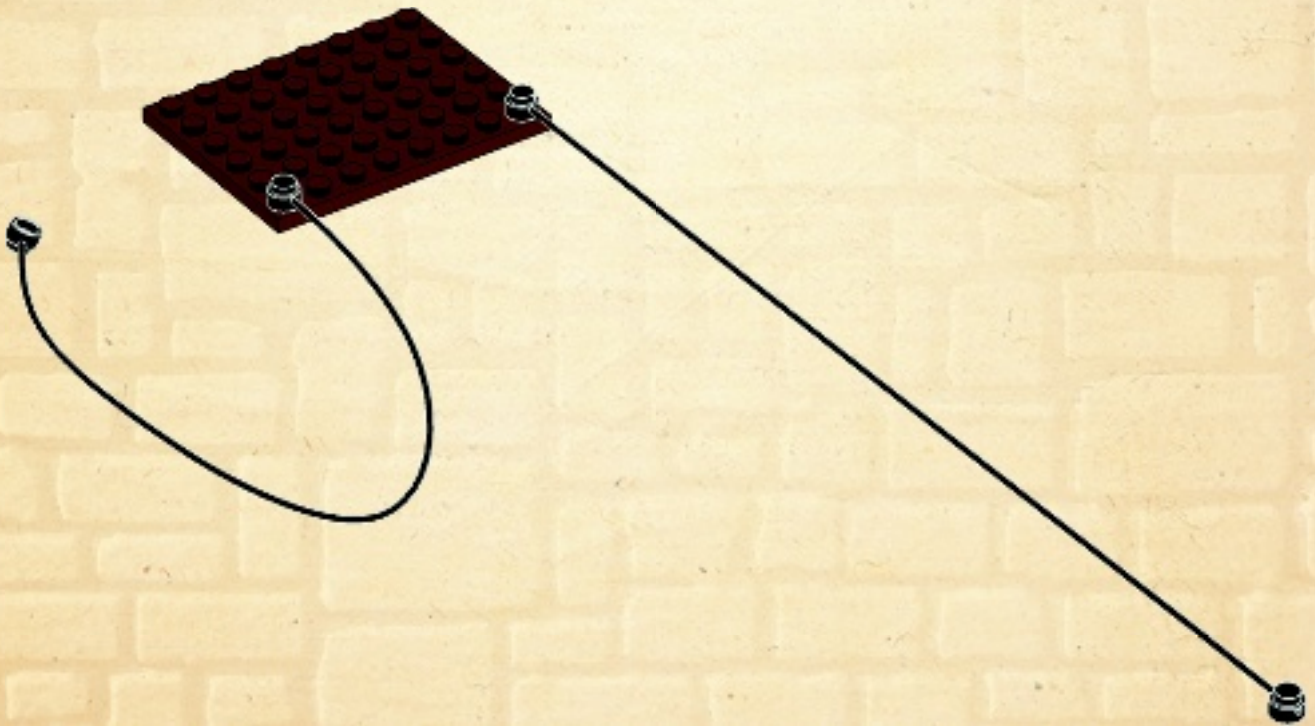



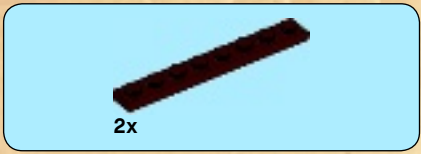

2

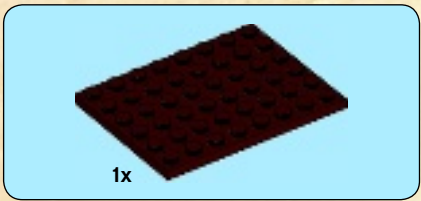
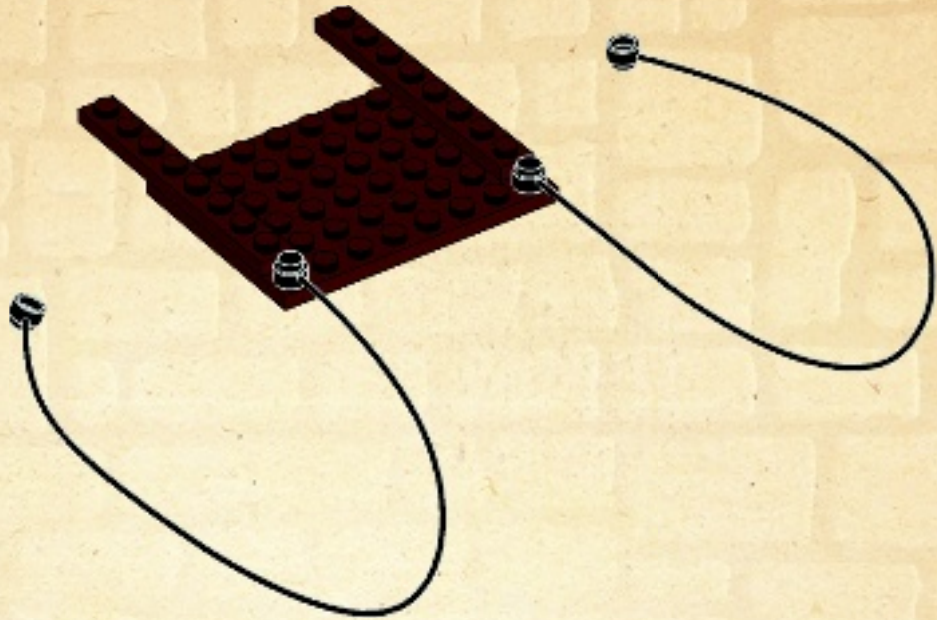

3

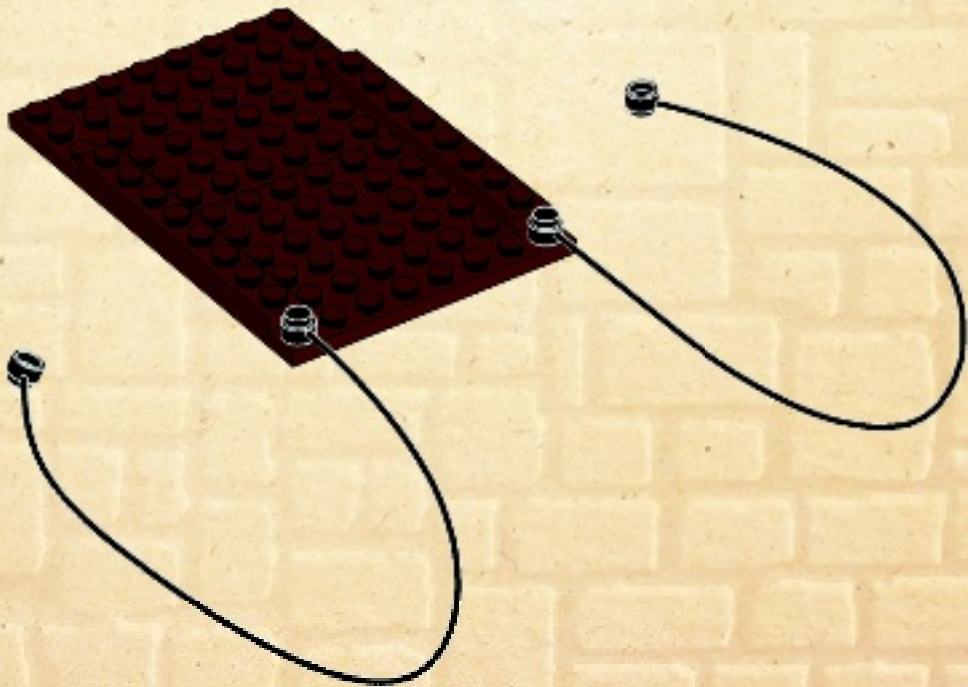



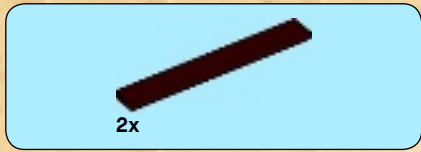

4

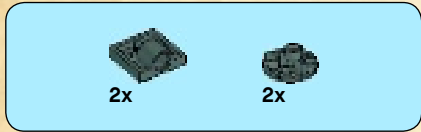
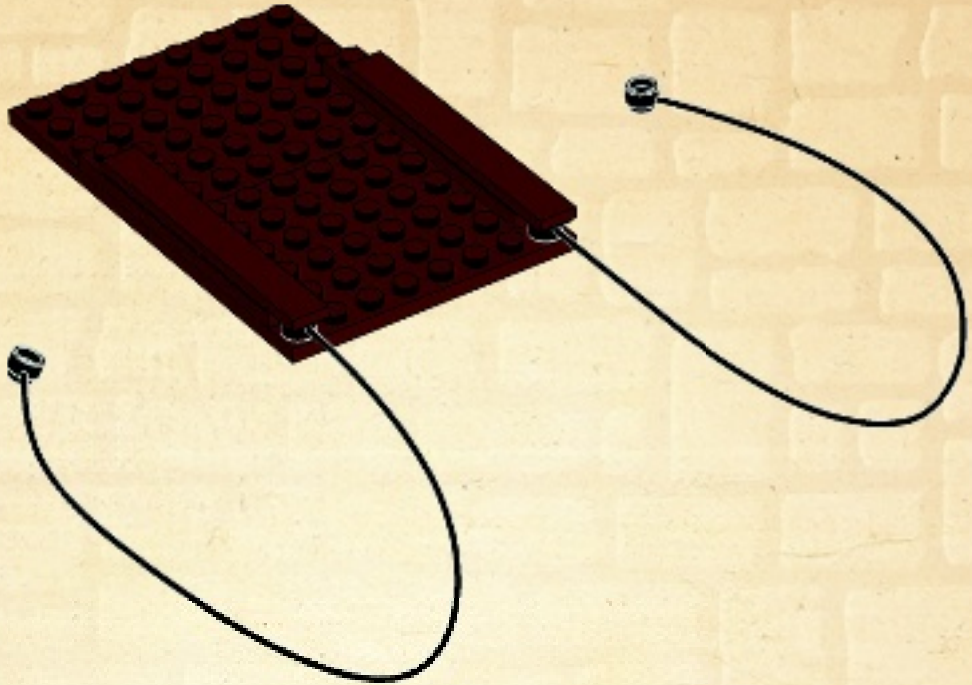

5

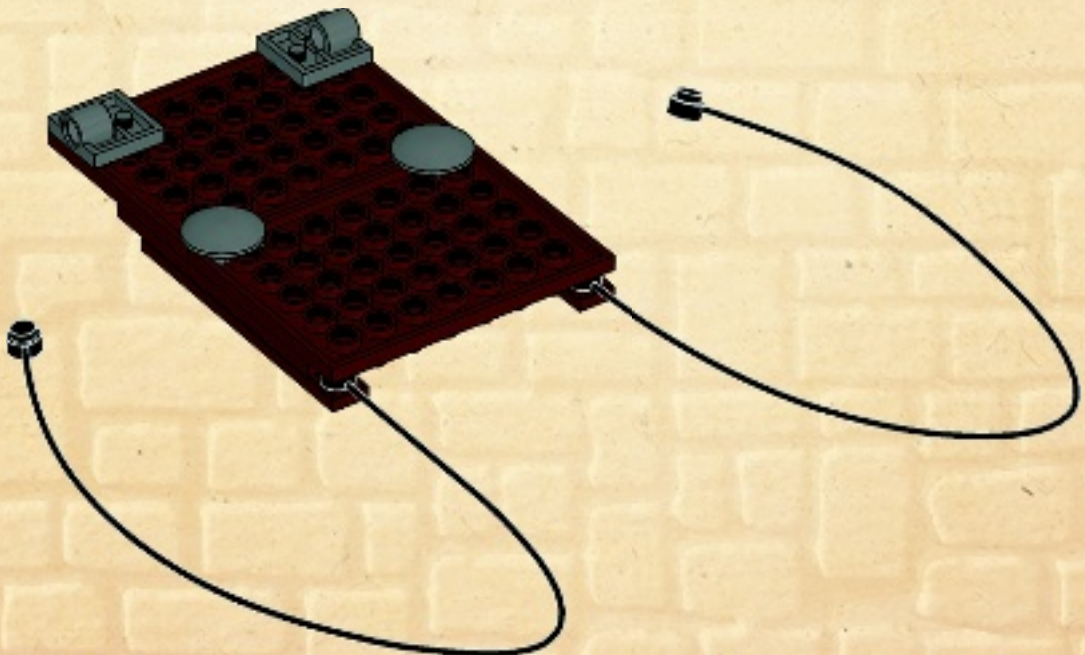
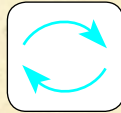



2x



6

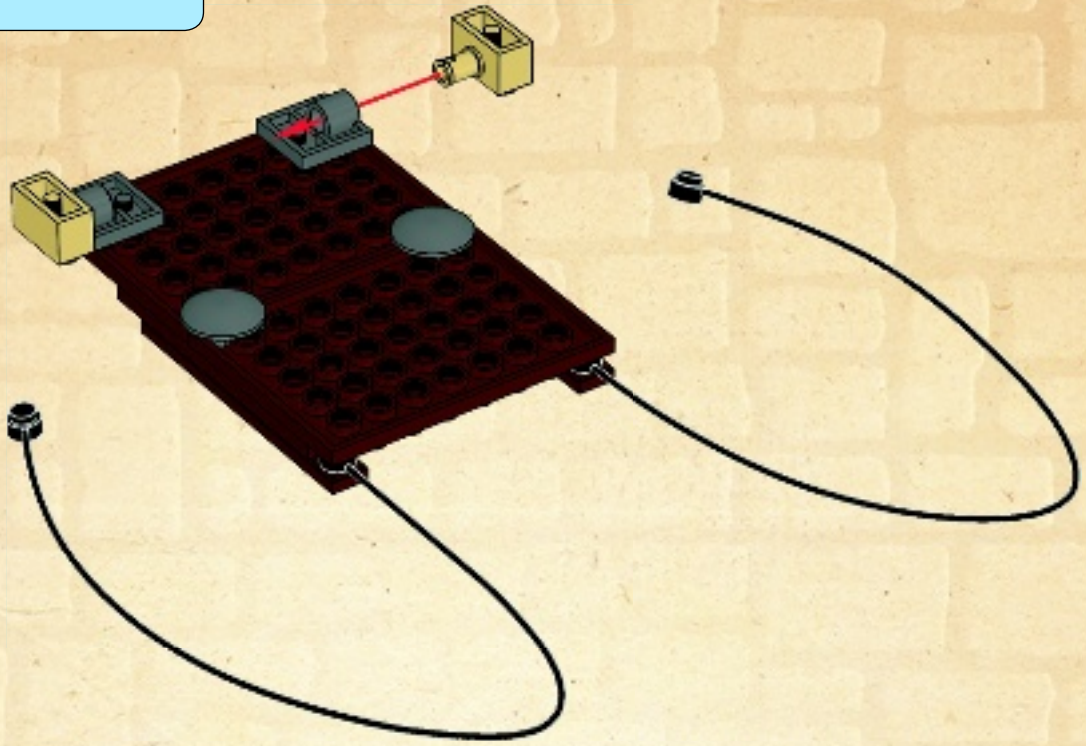

7

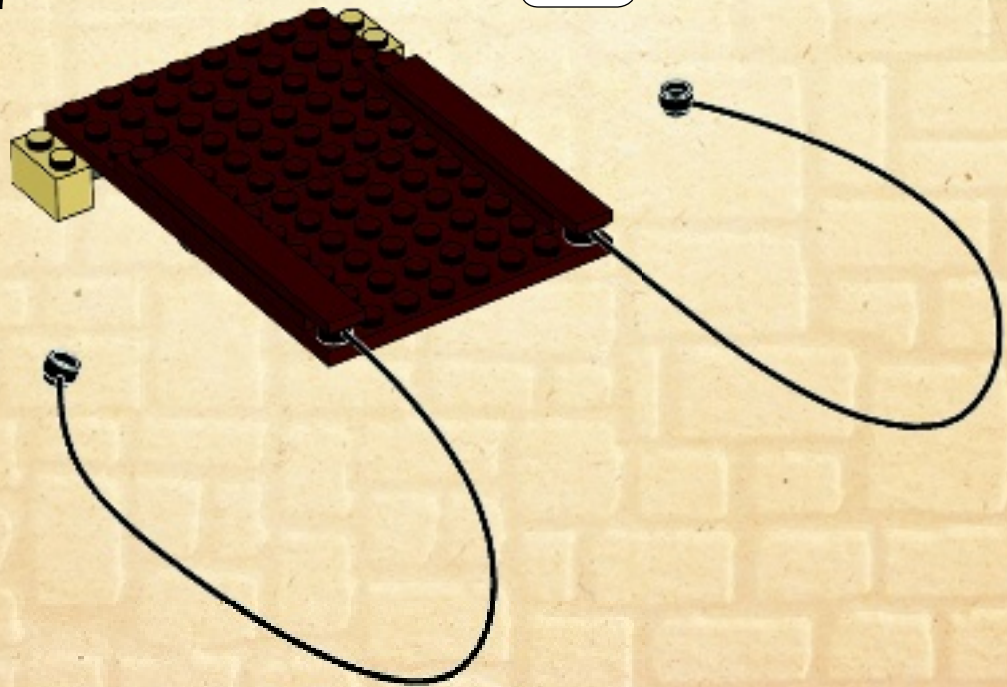
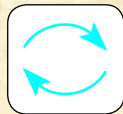



8

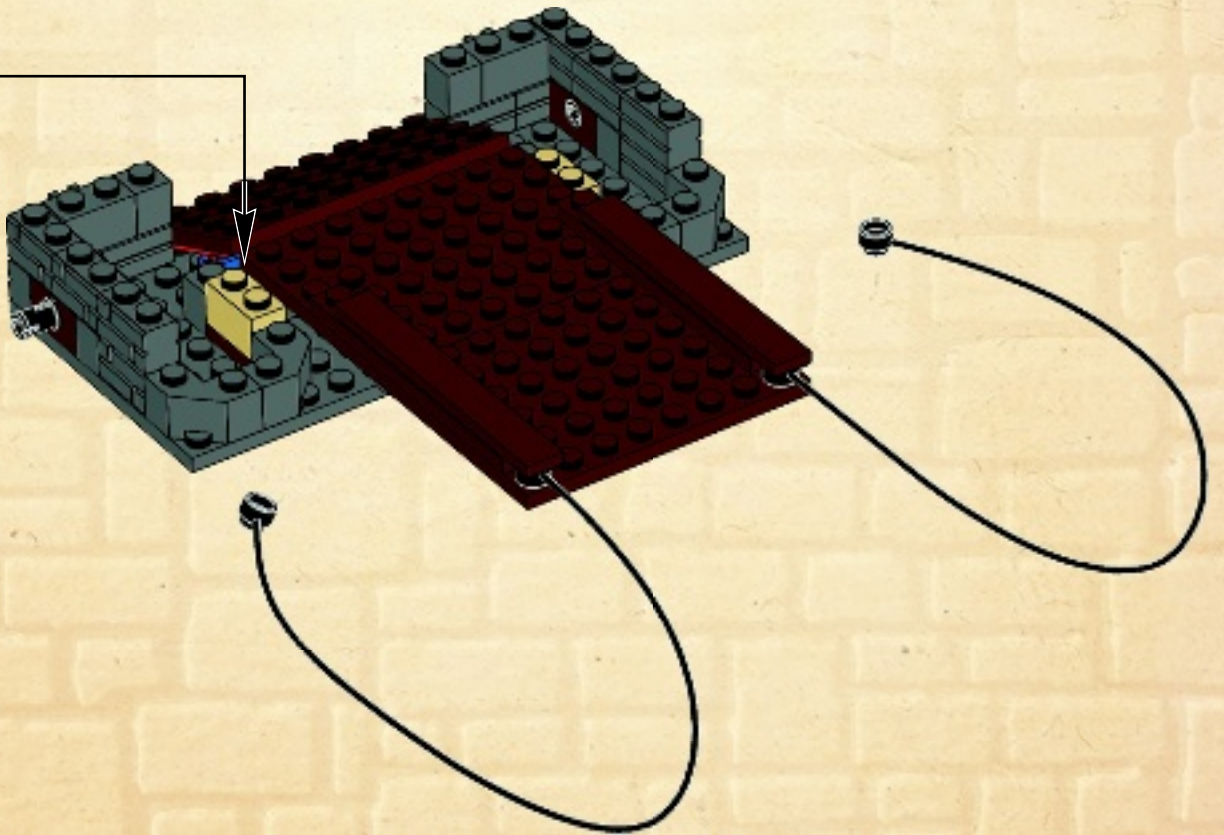





2x



4x

# 9

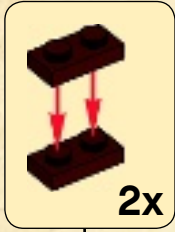

2x

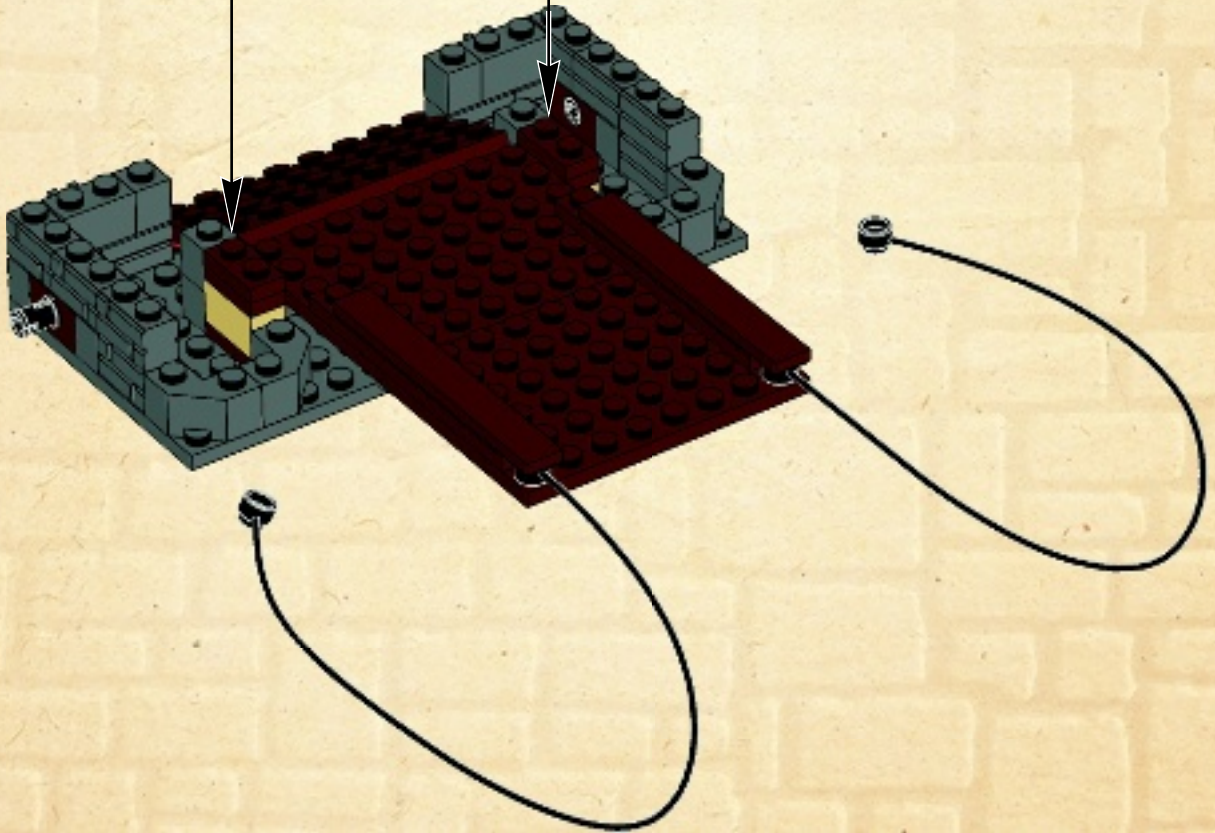



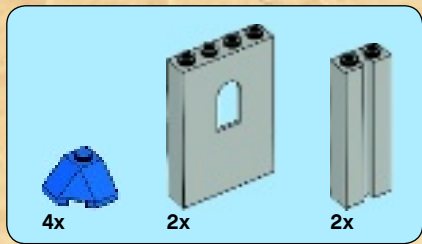

10

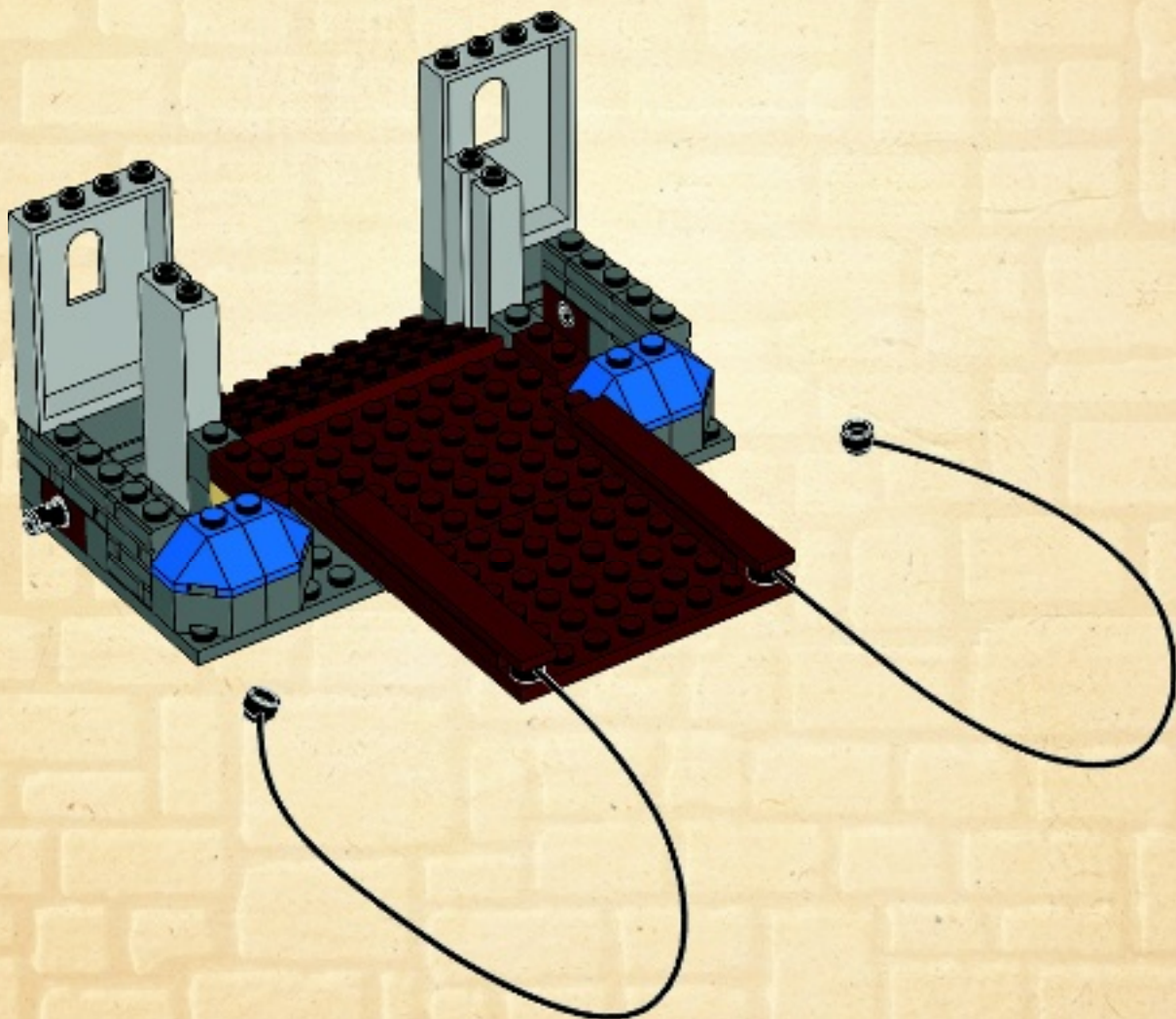



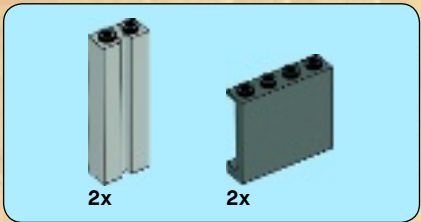

11

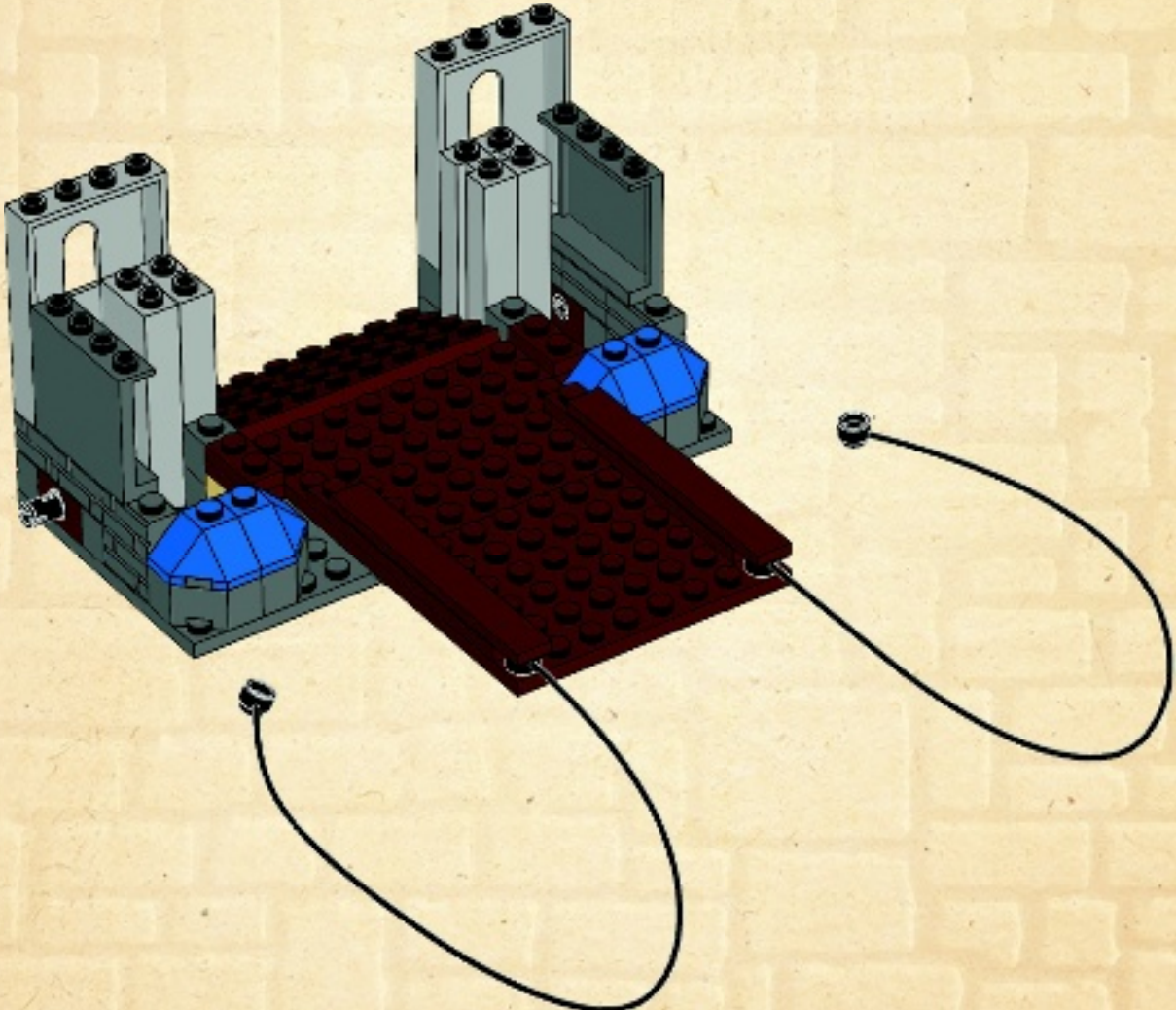





# 12

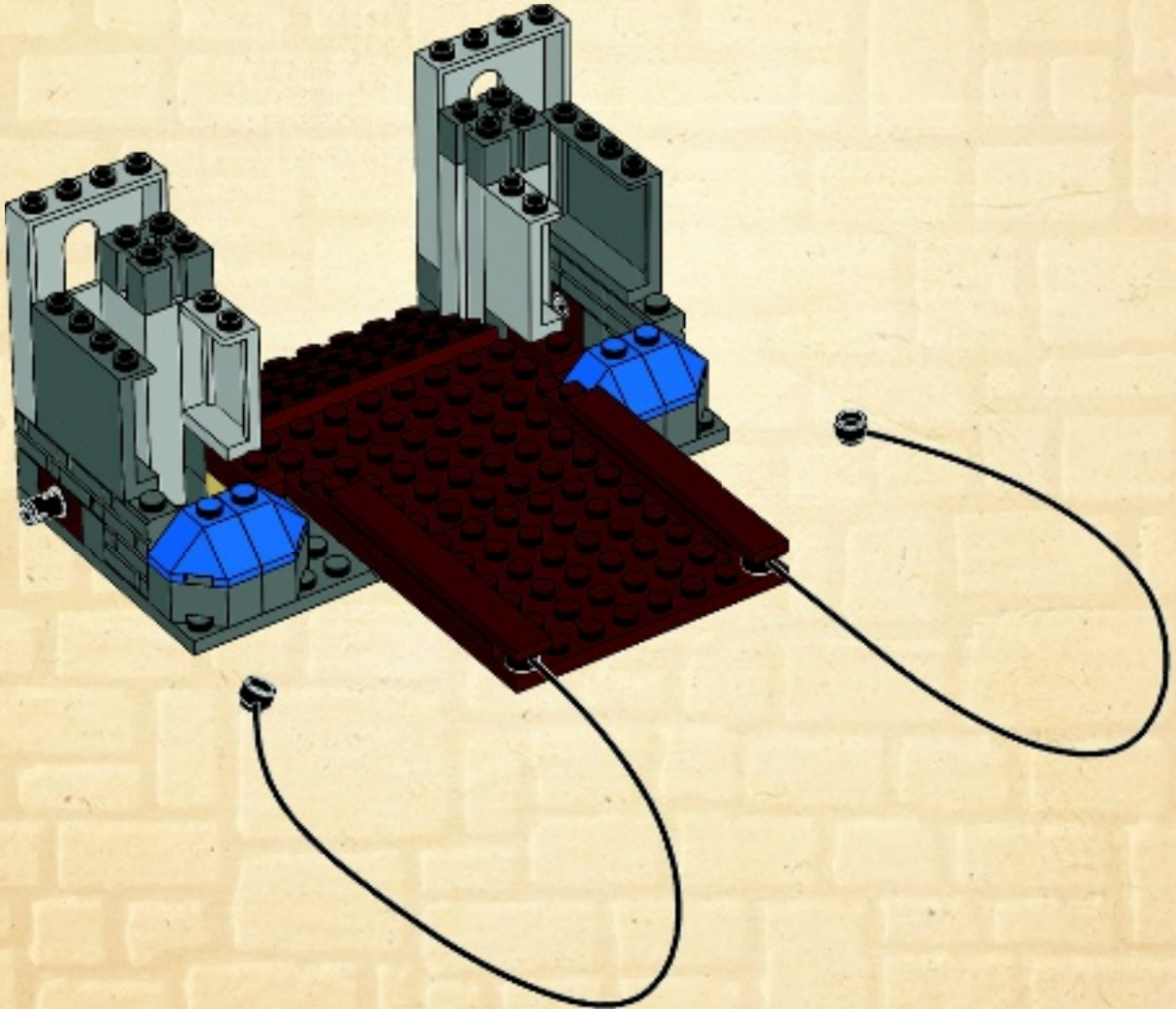





# 13

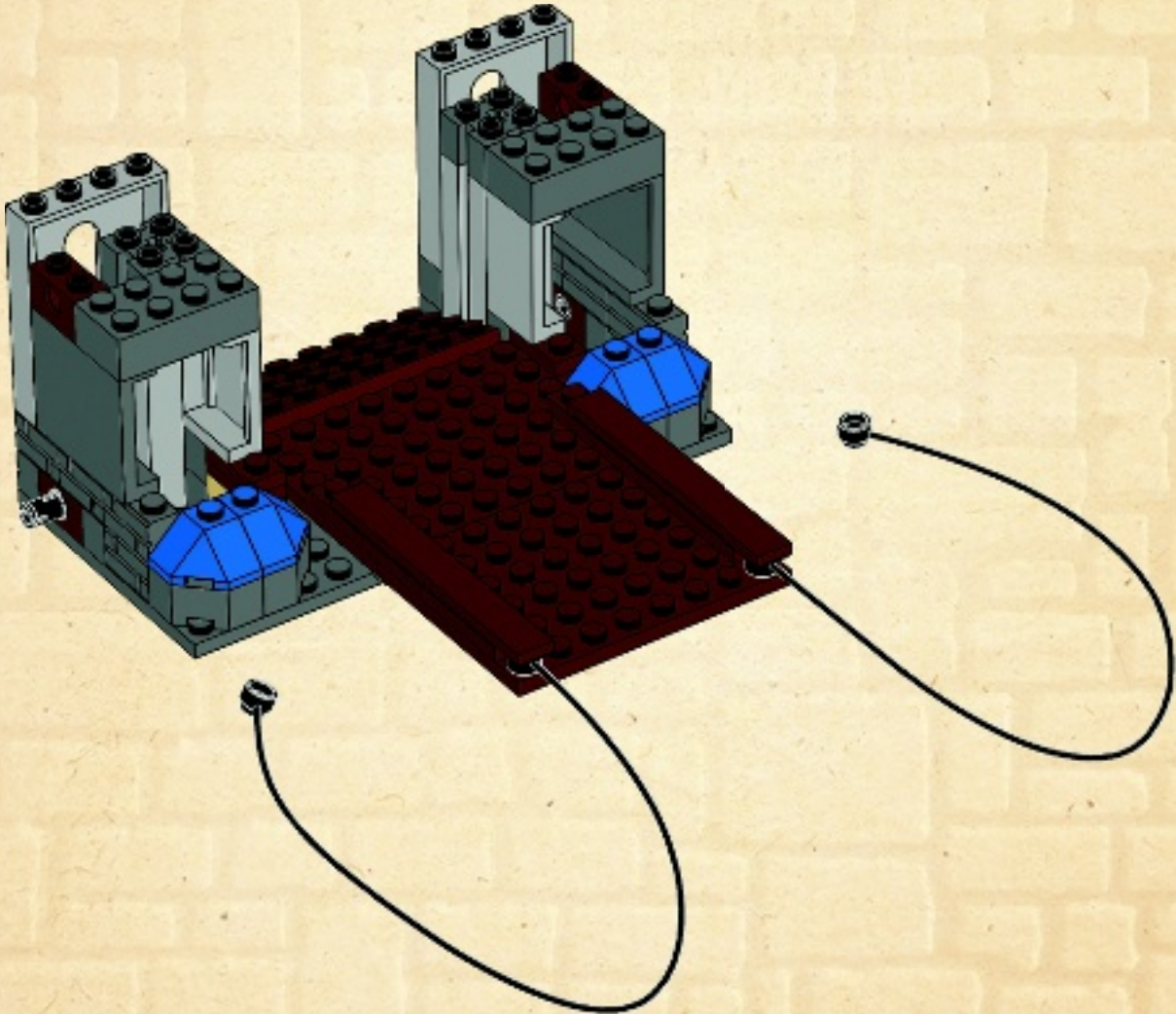



2x 4x 2x

# 14

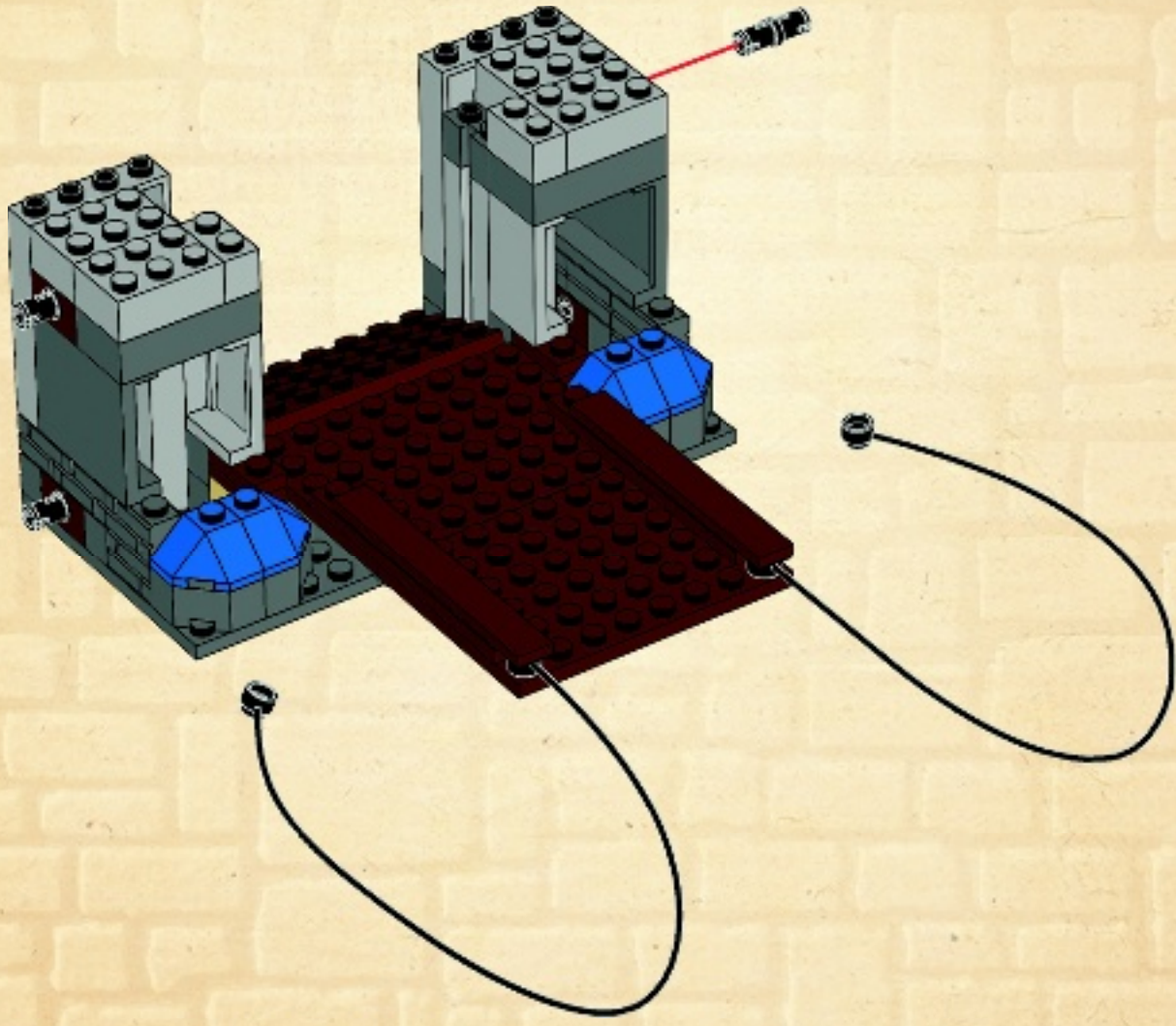



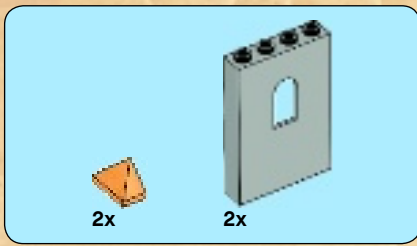

15

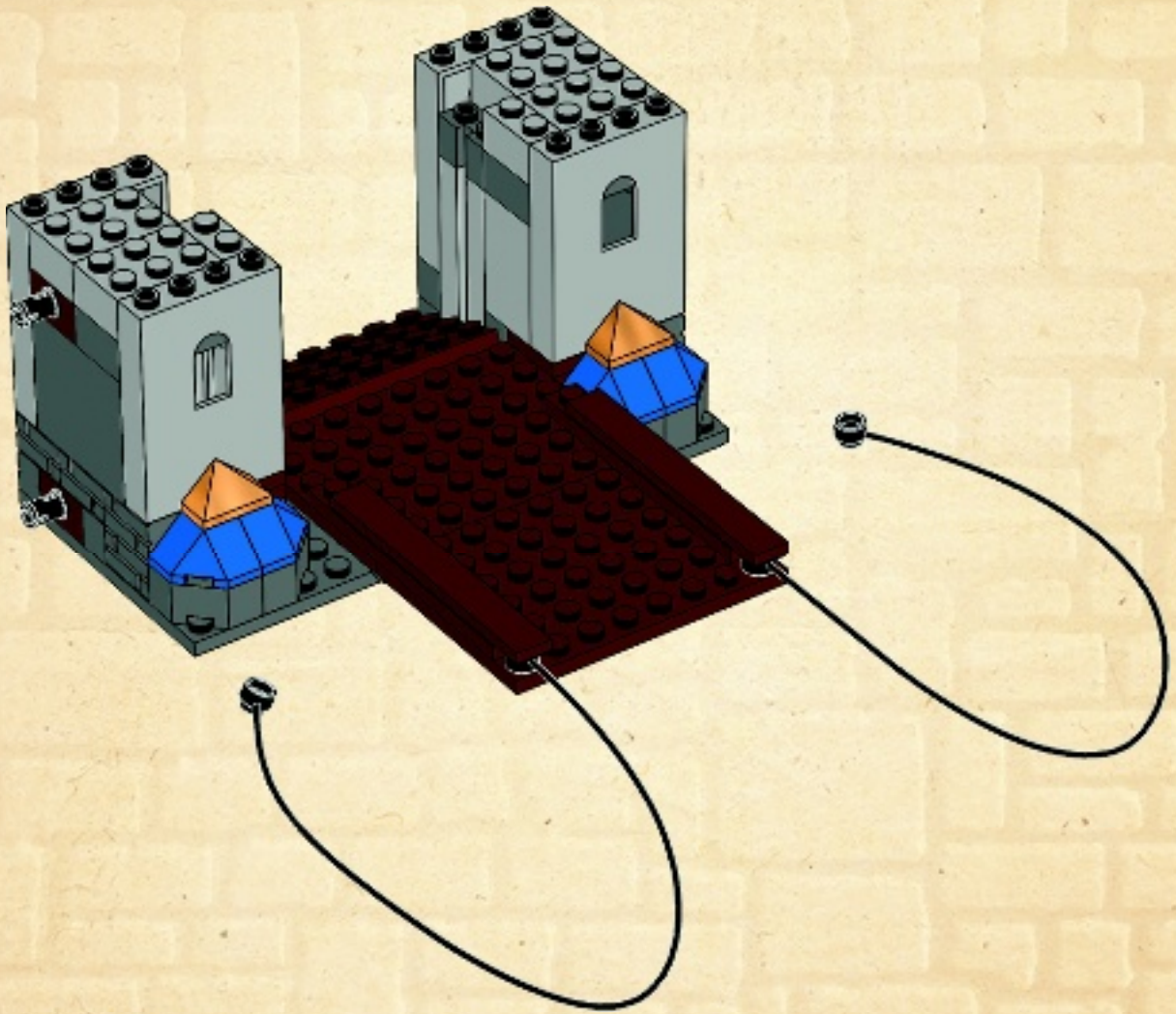



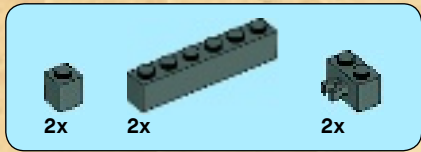

# 16

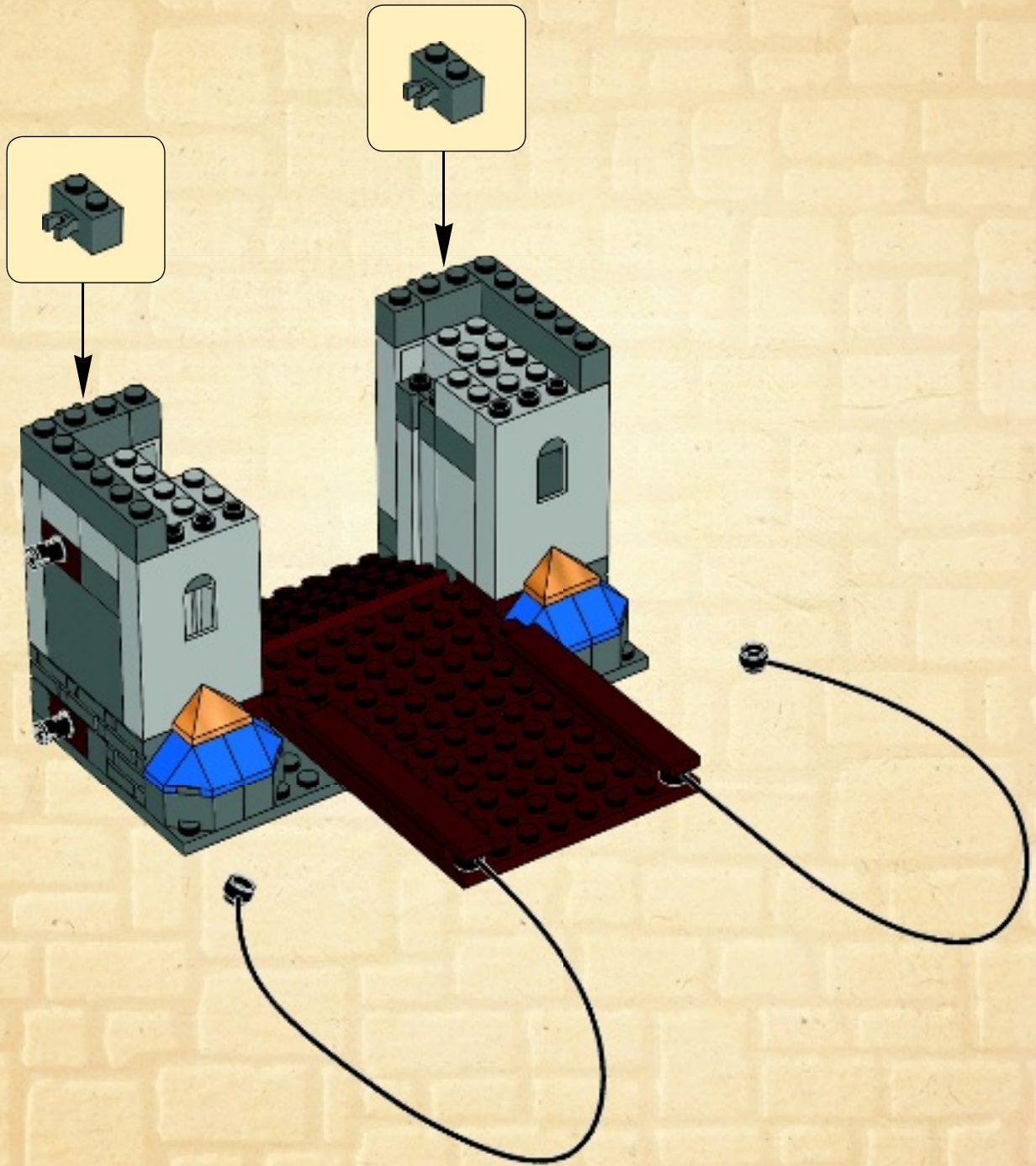



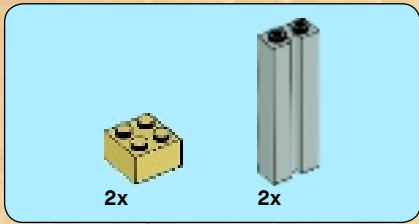

17

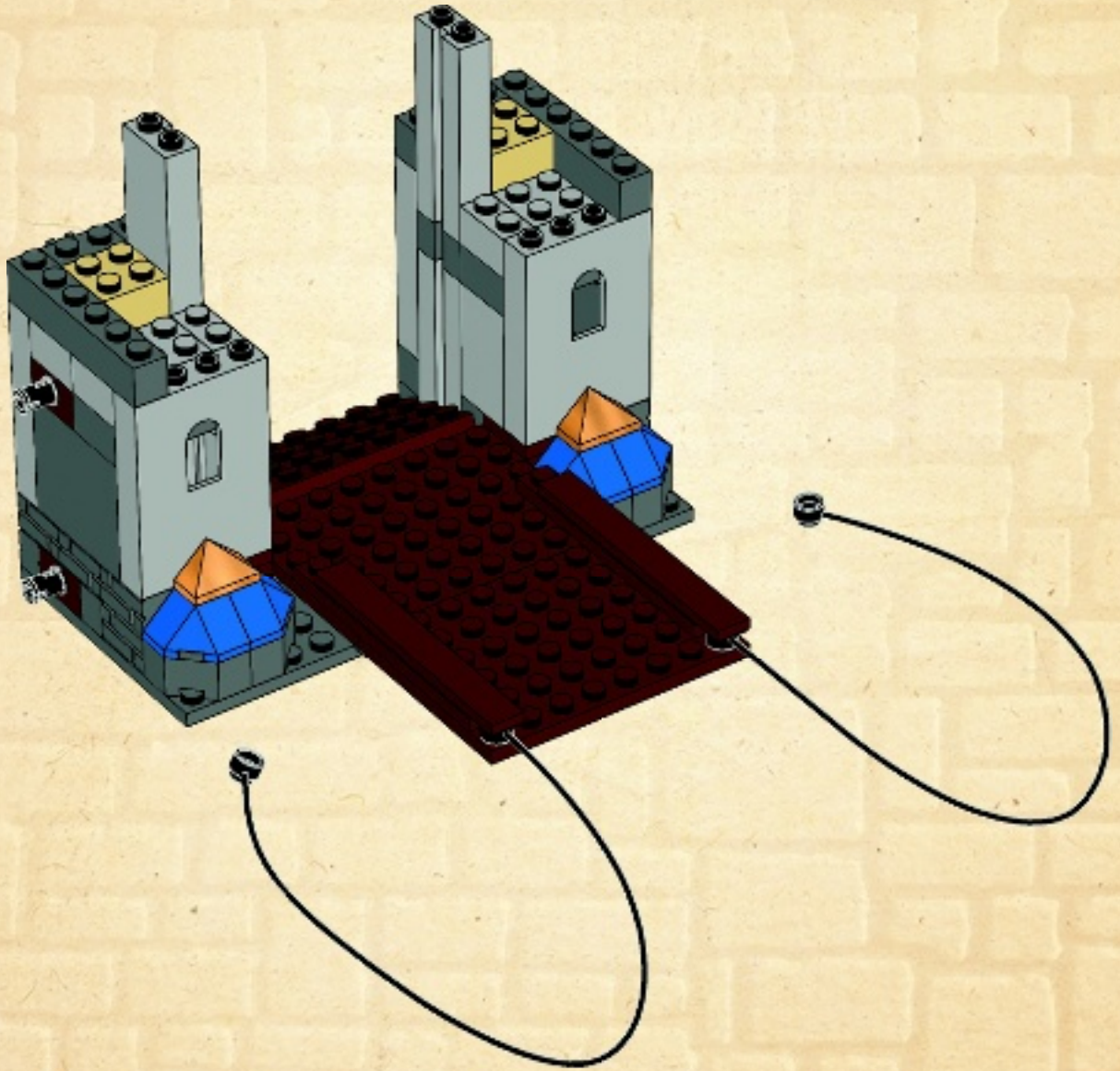



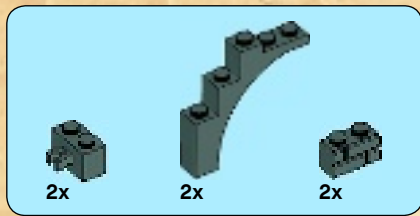

18

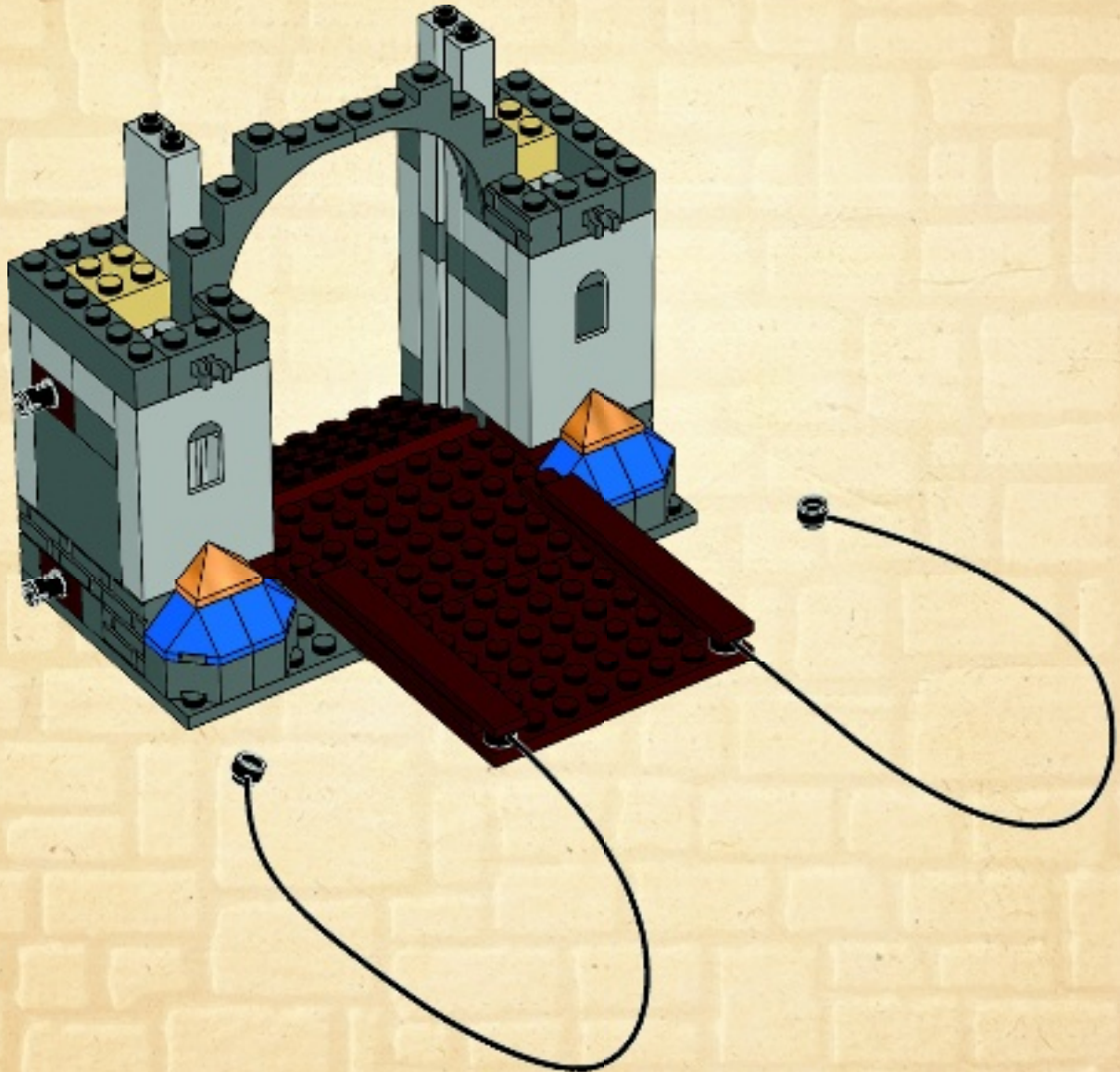





19

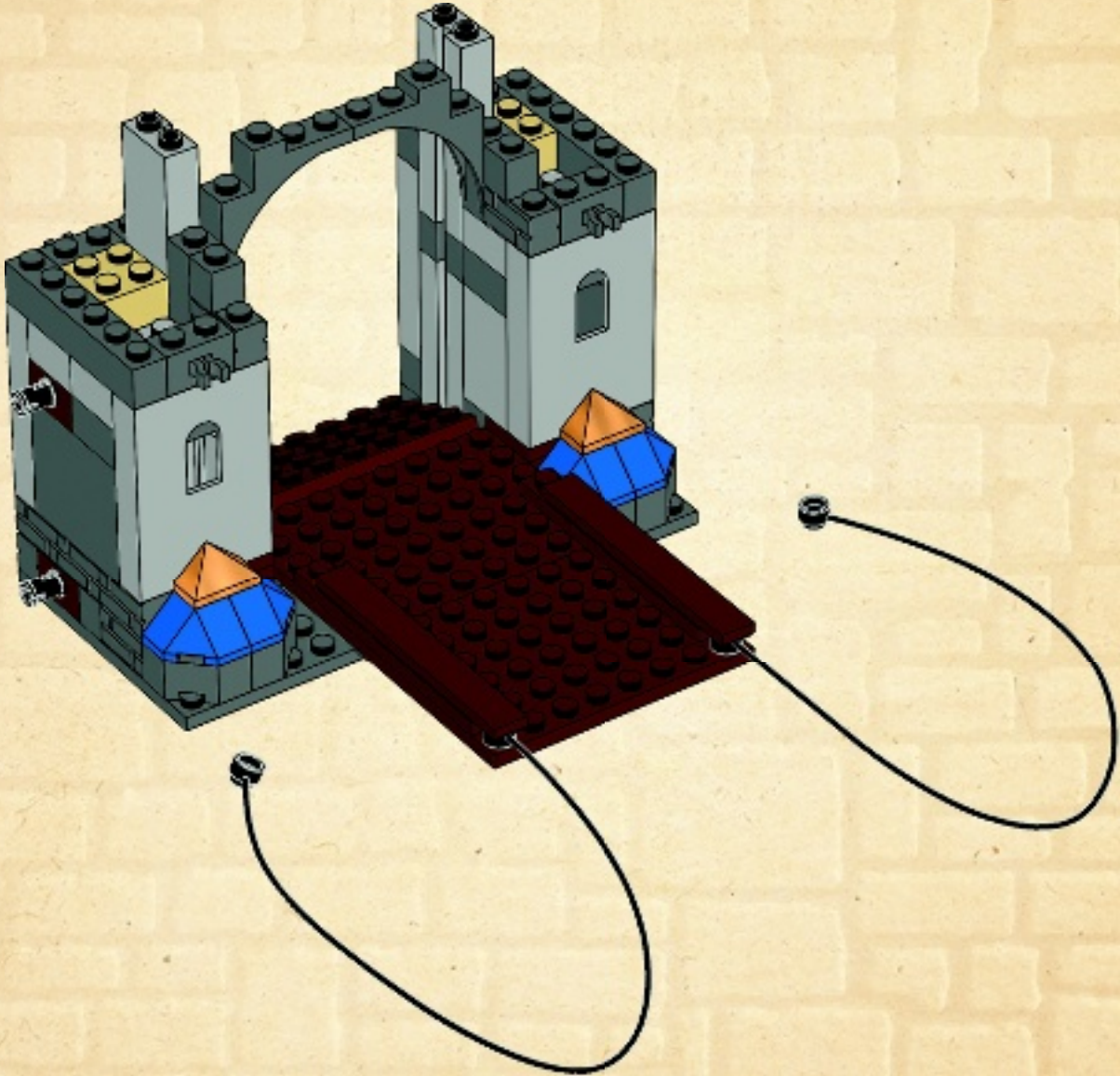





2x

20

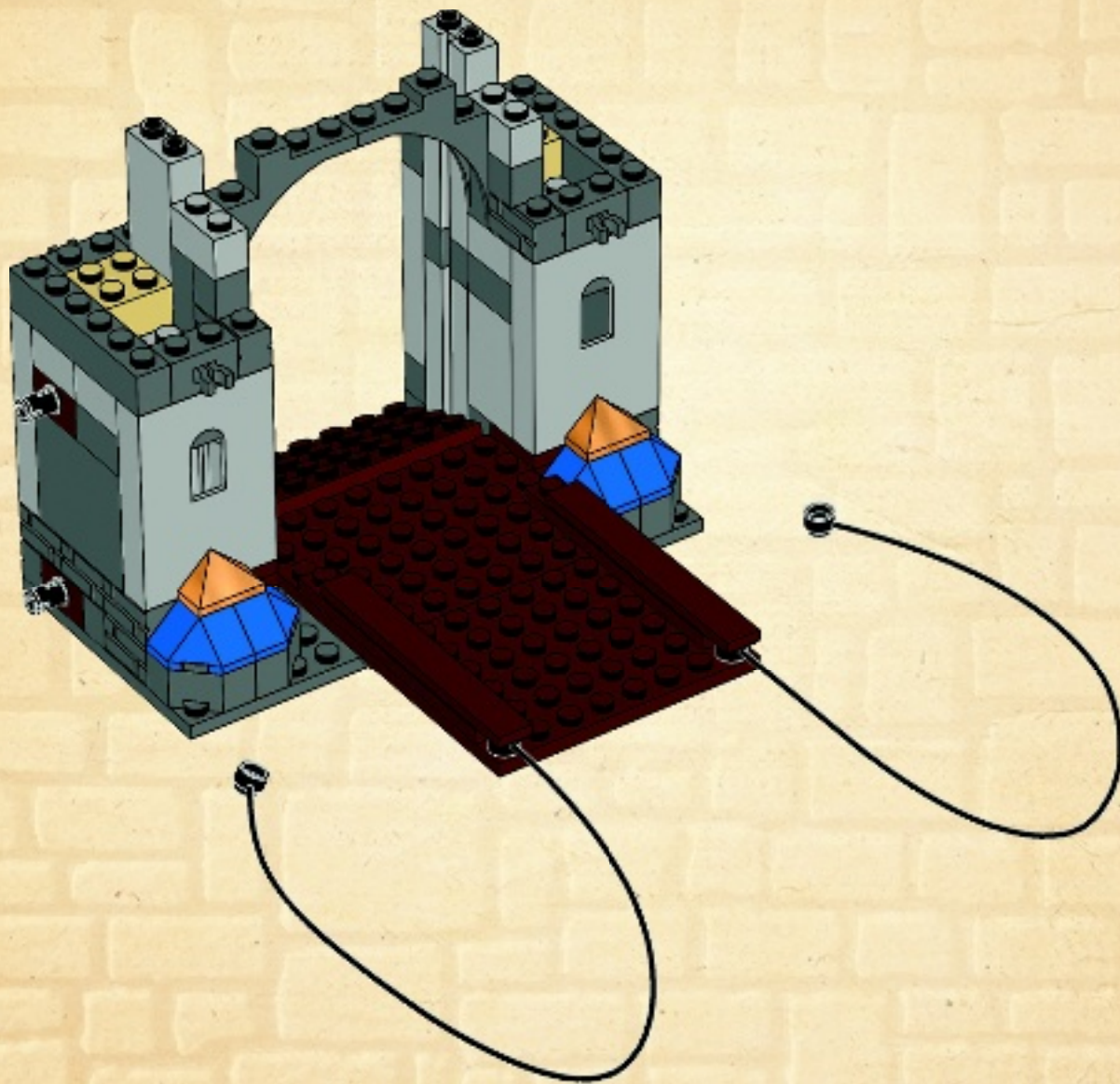





1x



2x

# 21

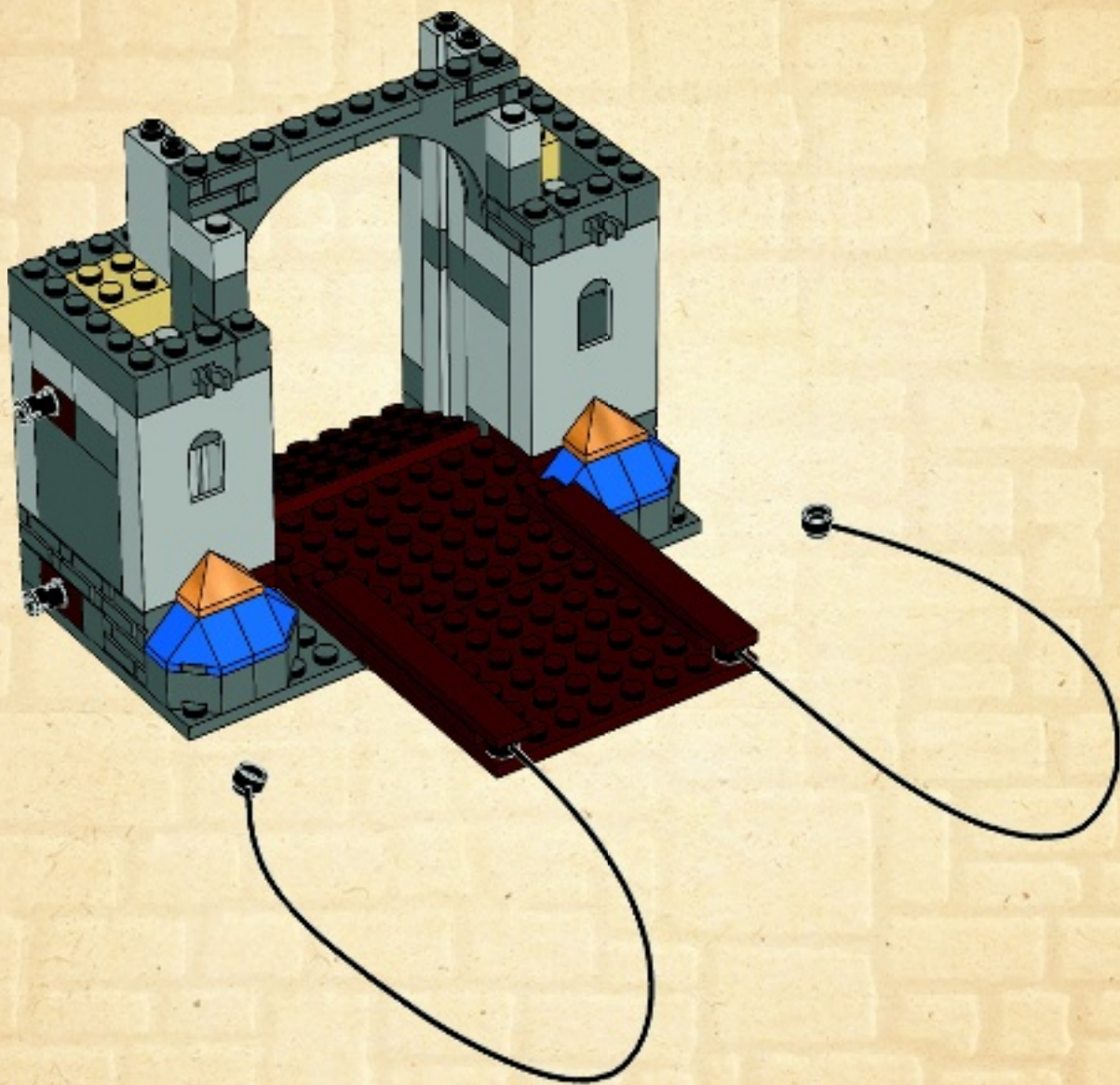



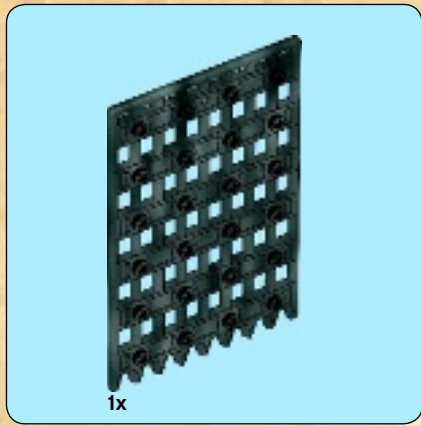

22

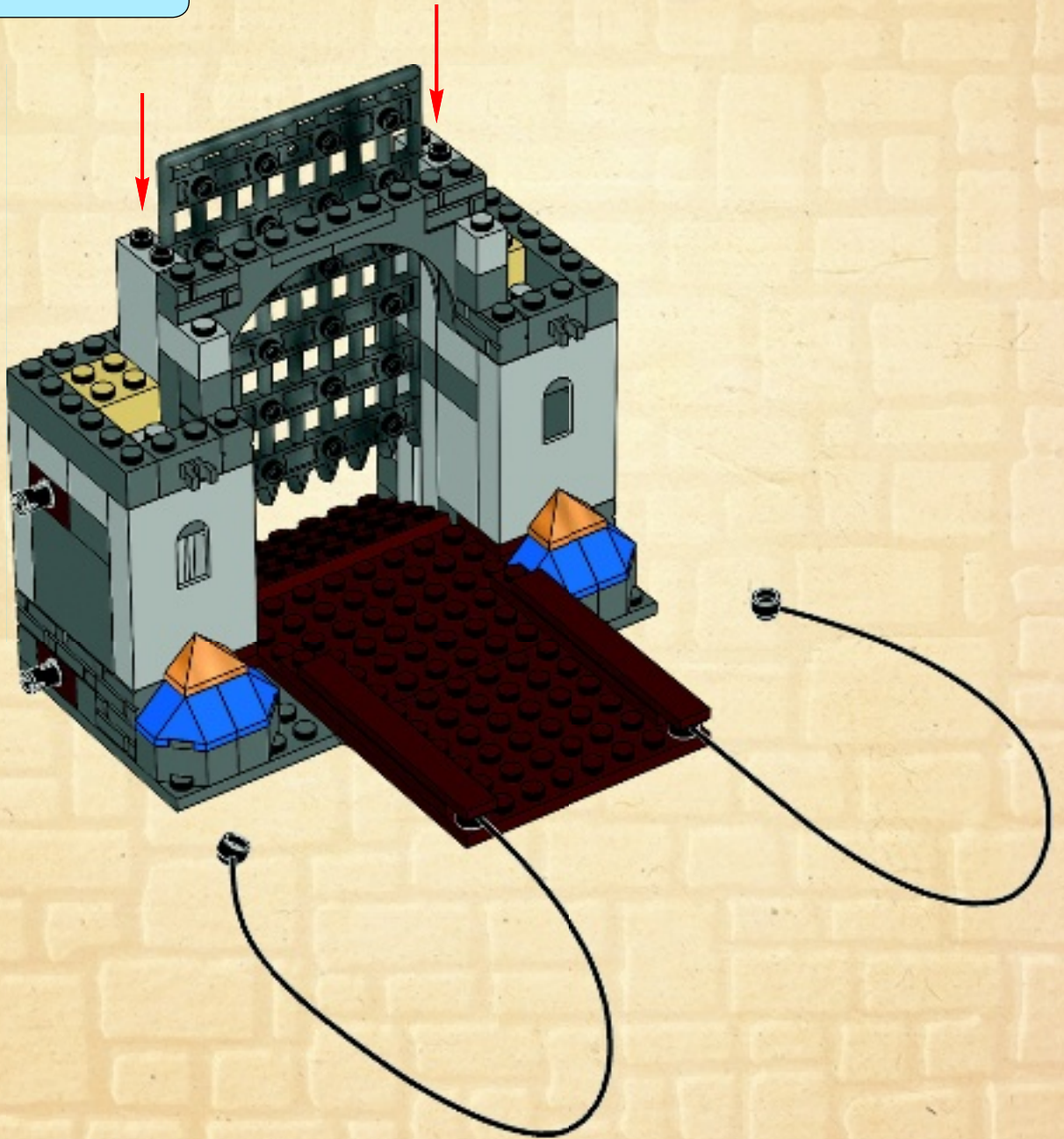



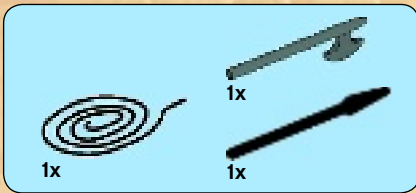

# 23

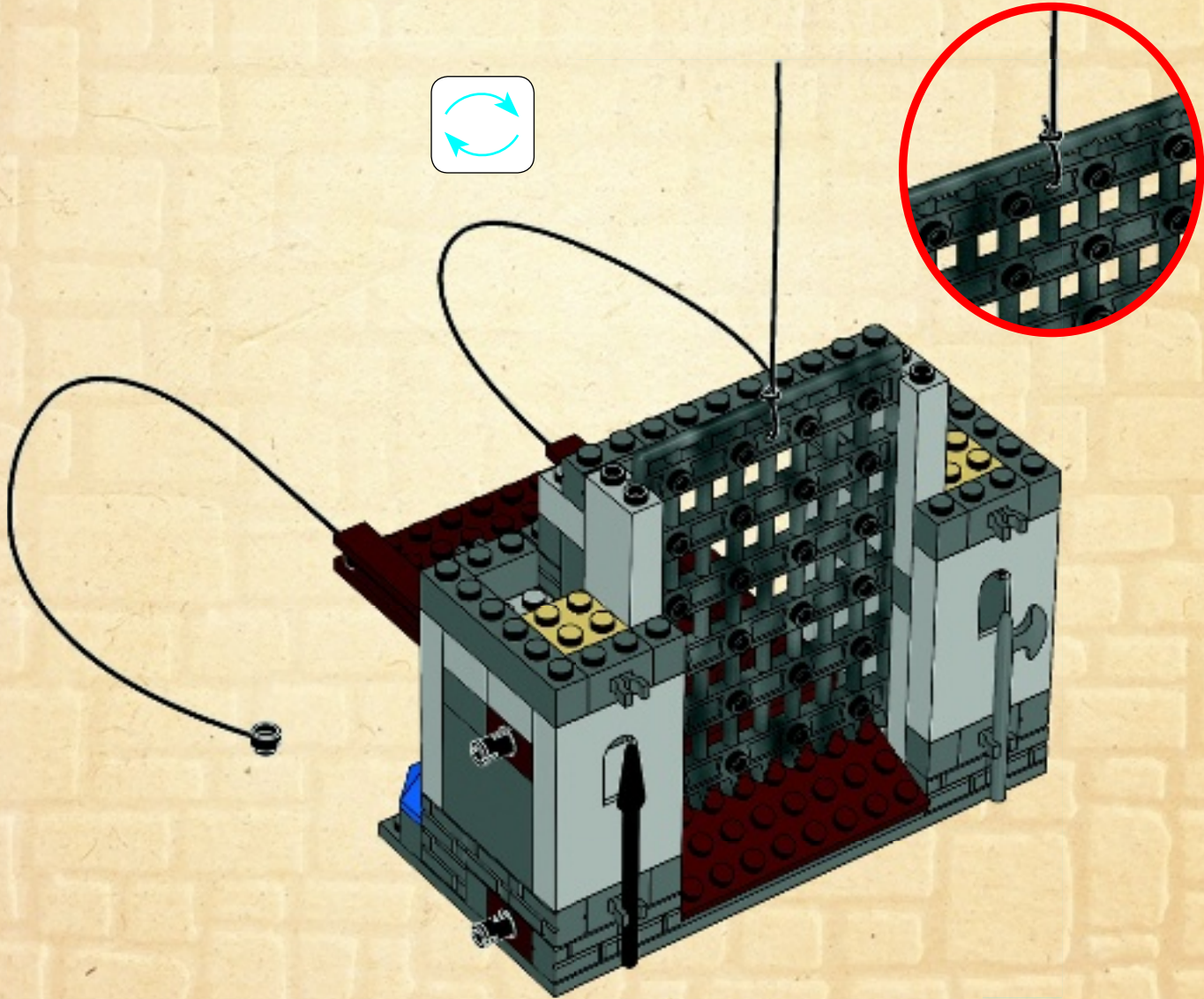
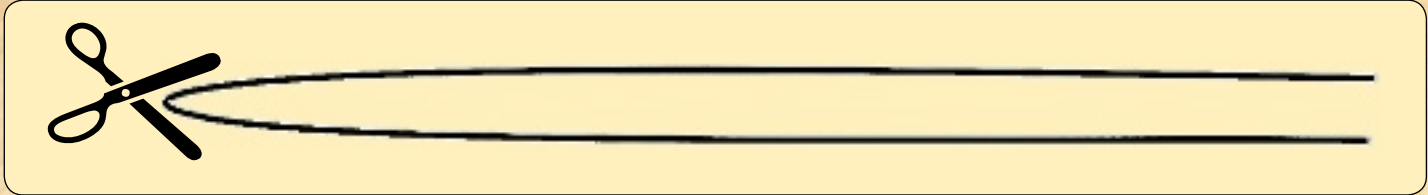





3

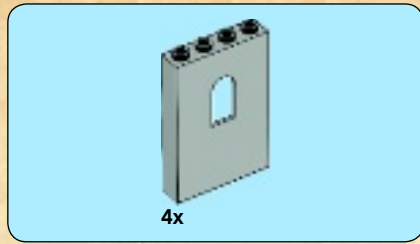
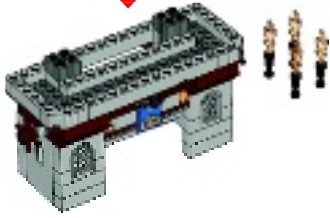

4x

24

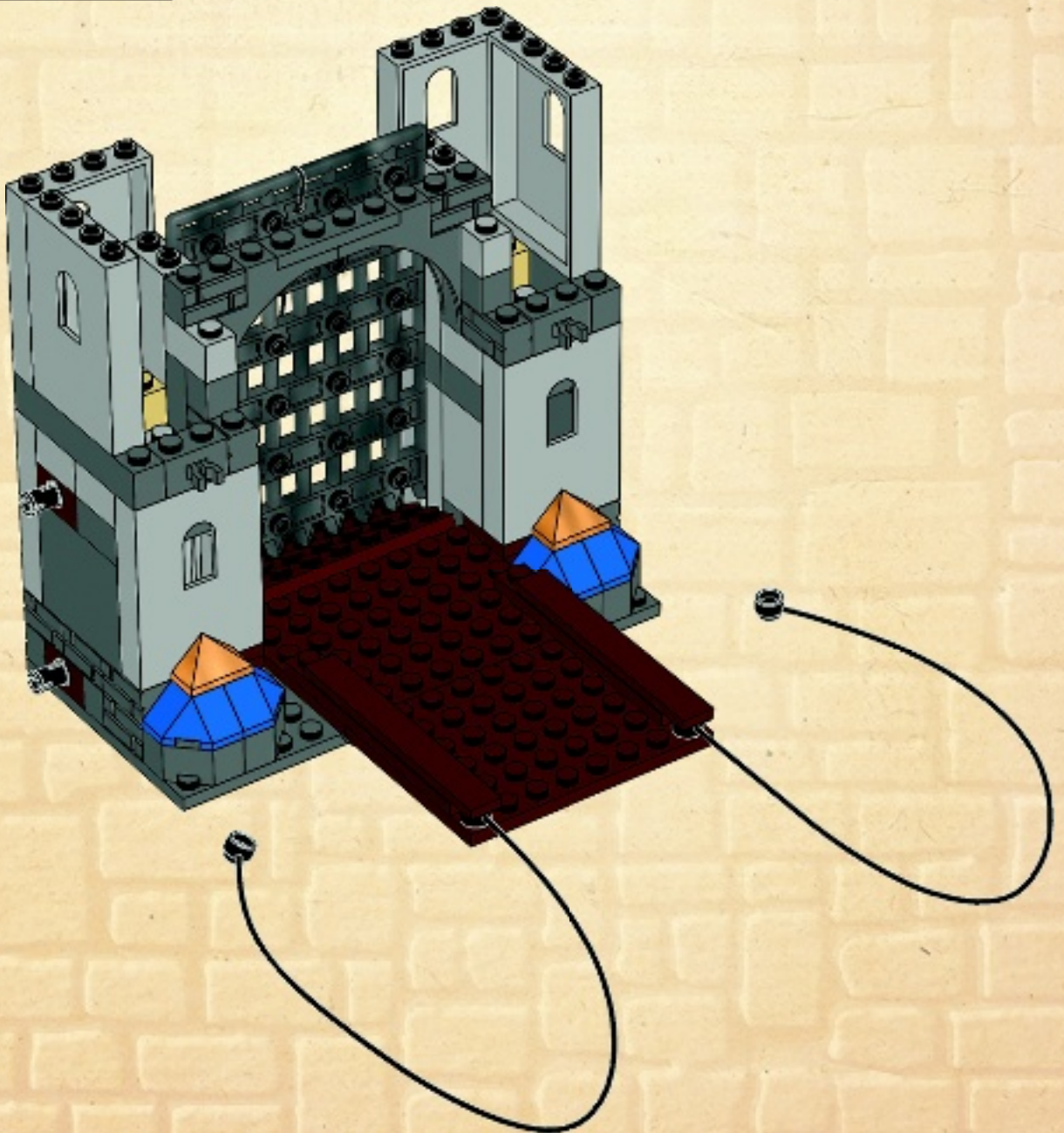
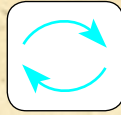



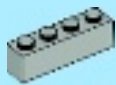

4x

# 25

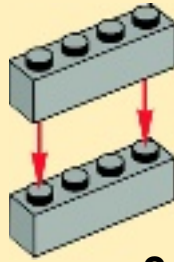

2x

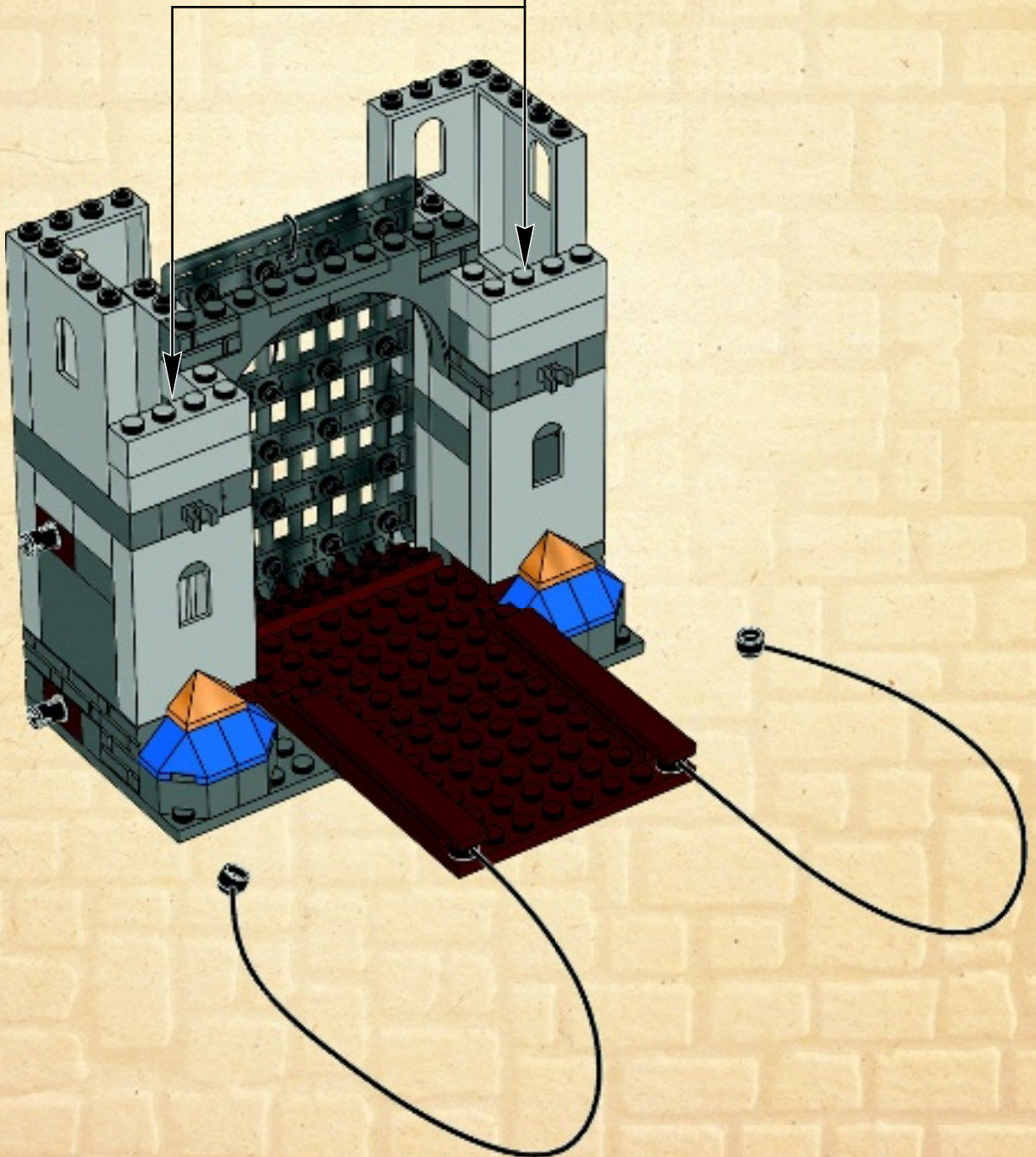





2x



2x

# 26

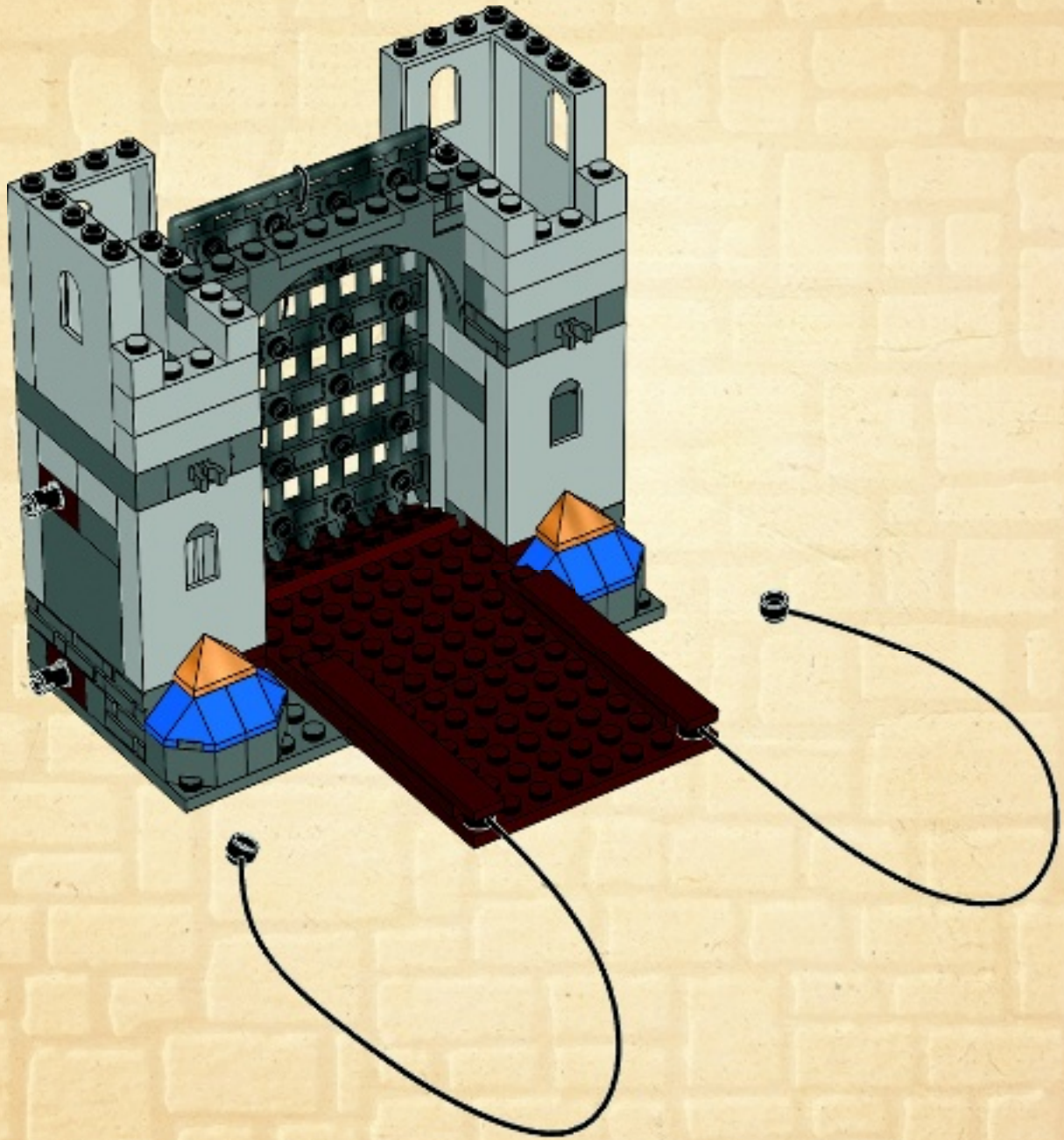



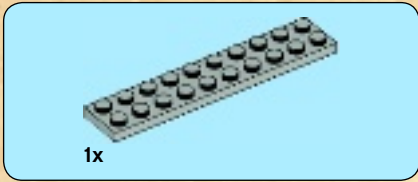
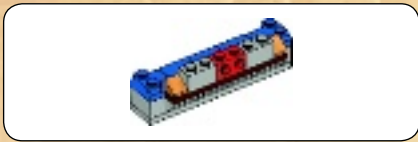

1x

1

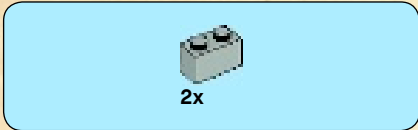
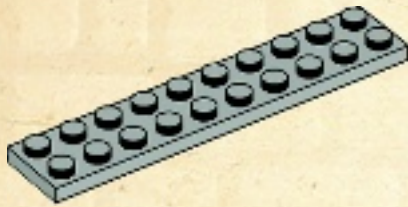

2x

2

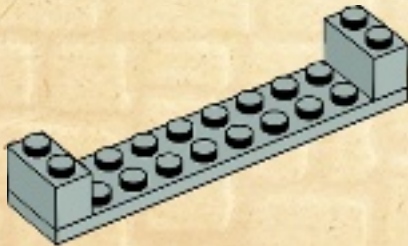

1x

2x

3

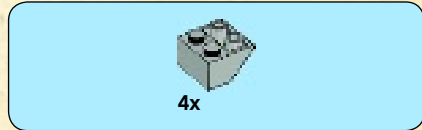
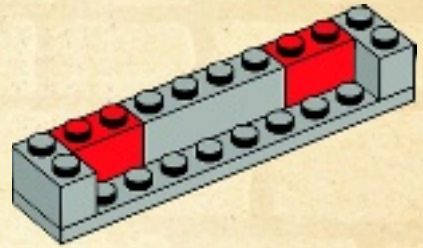

4x

4

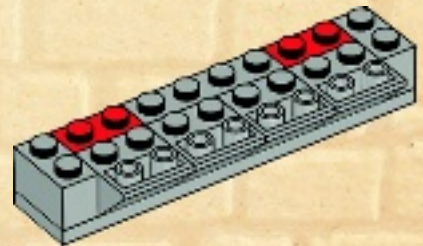



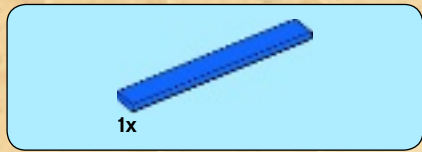

5

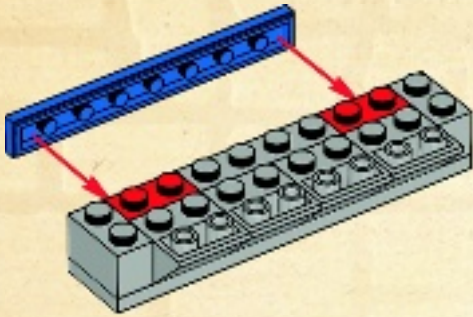

6

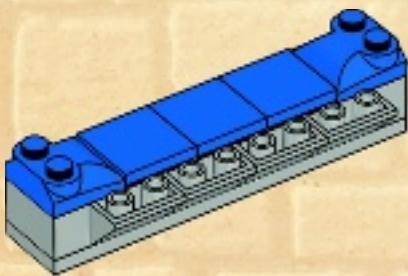

7

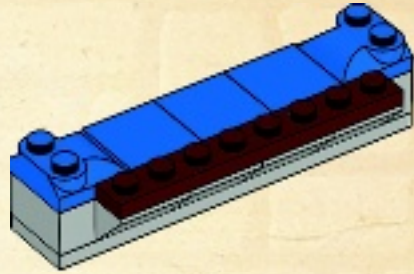

8

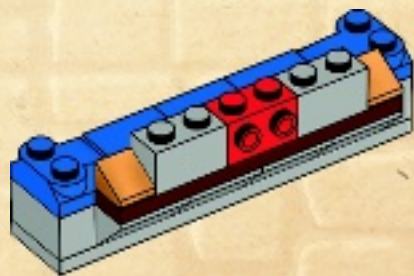



27

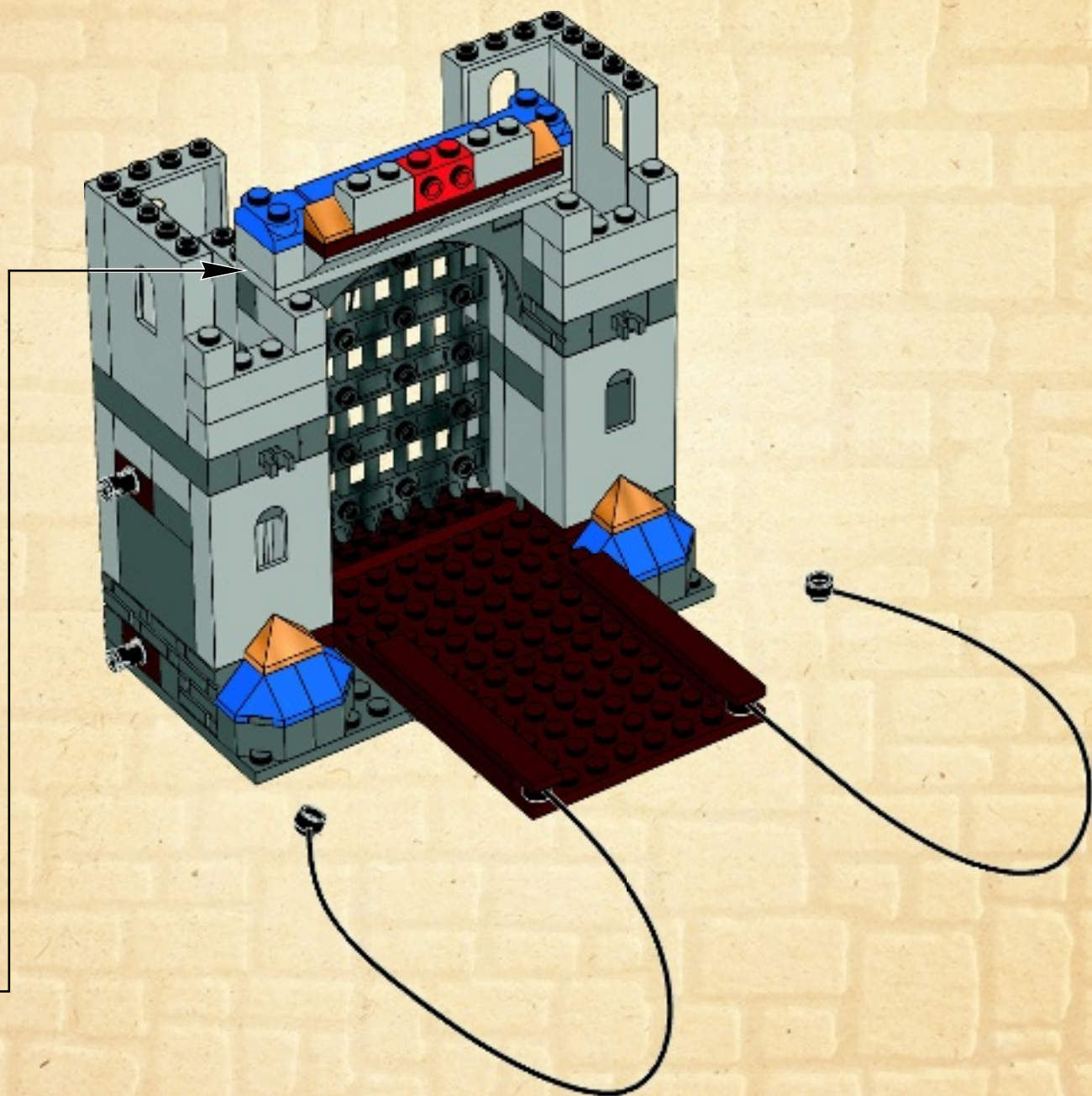



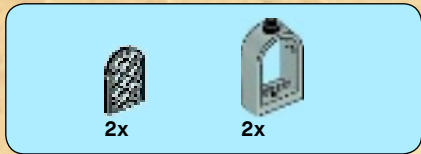

28

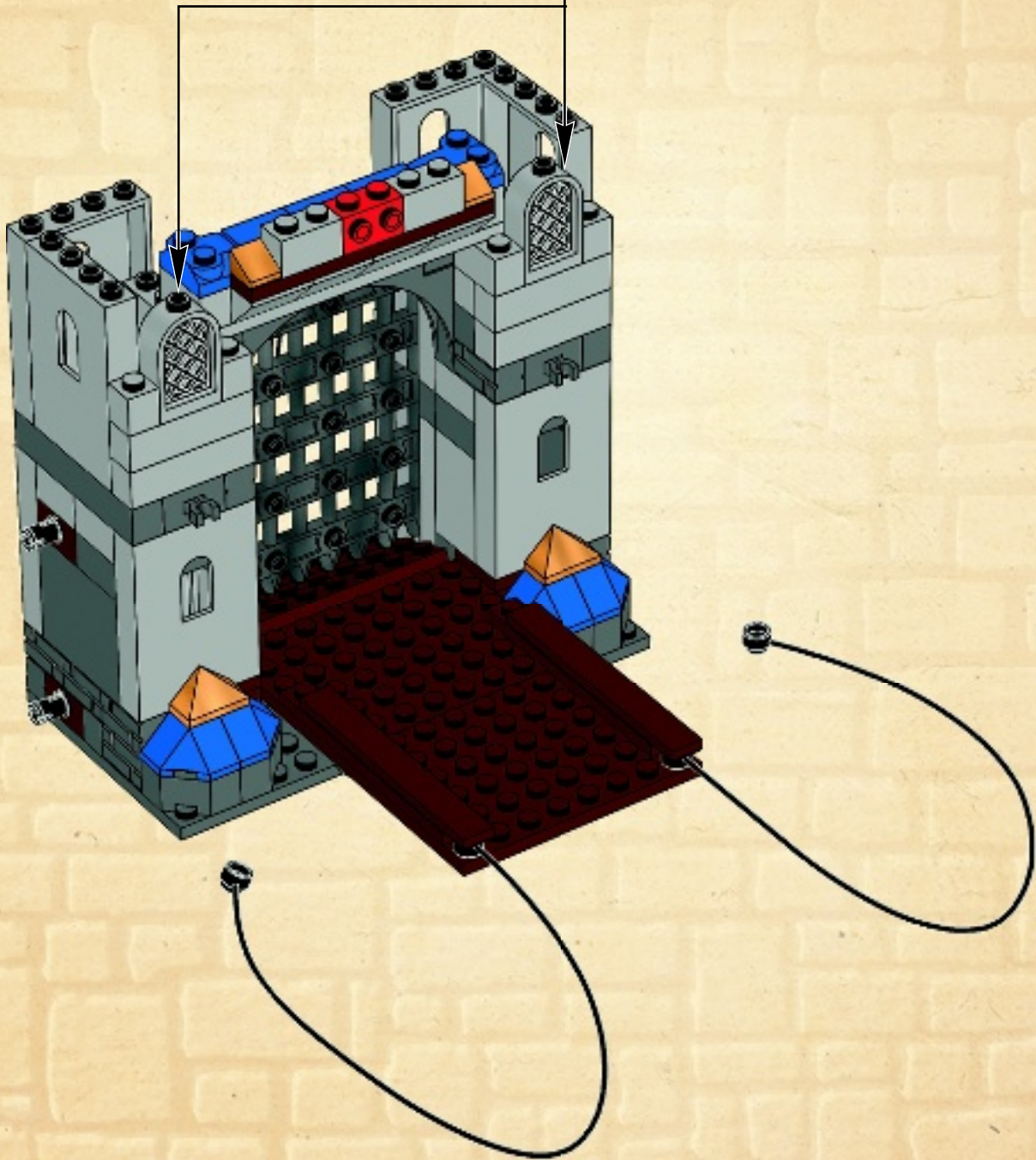
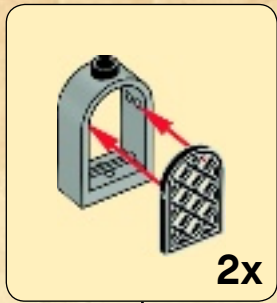





2x

# 29

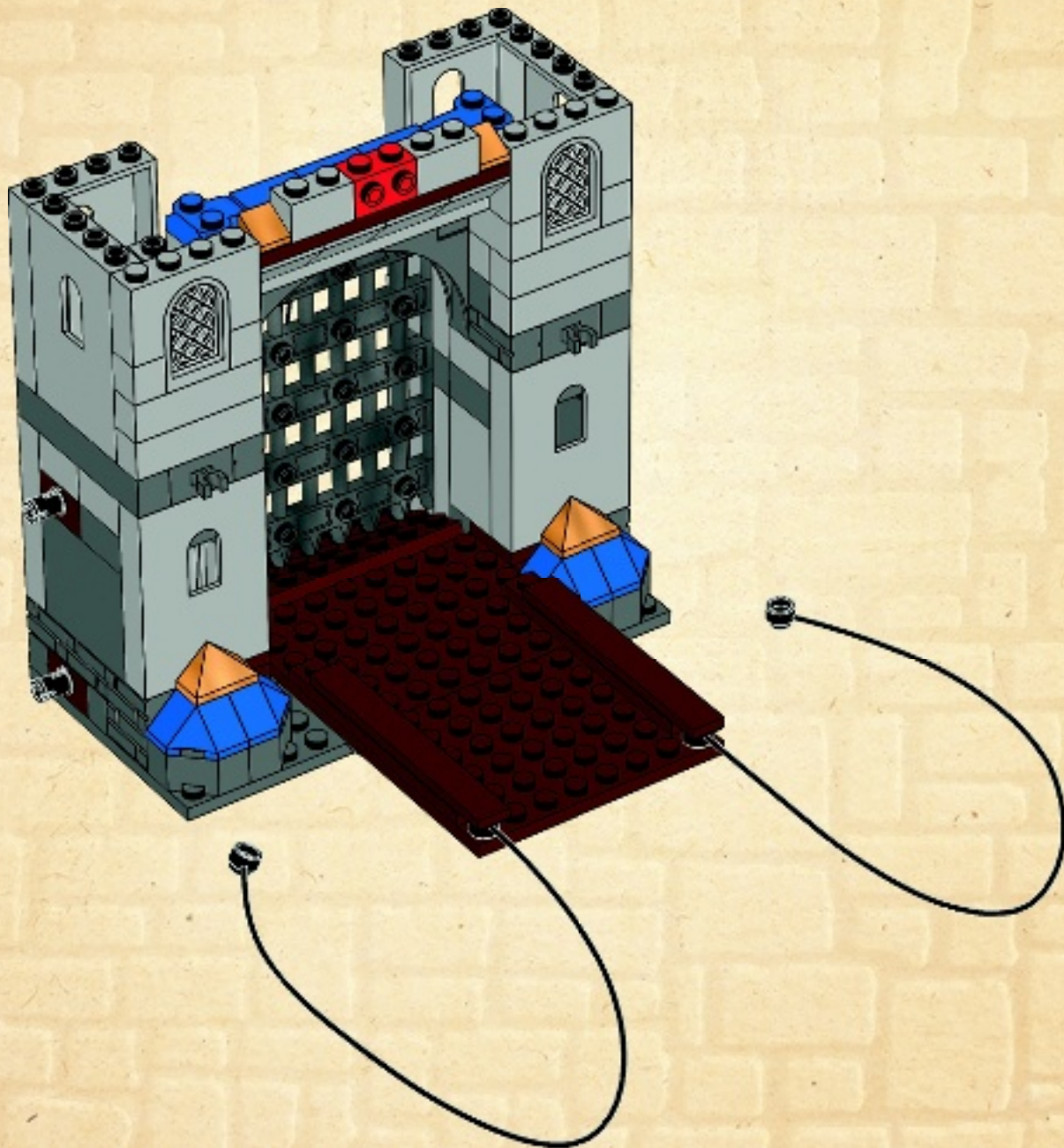





# 30

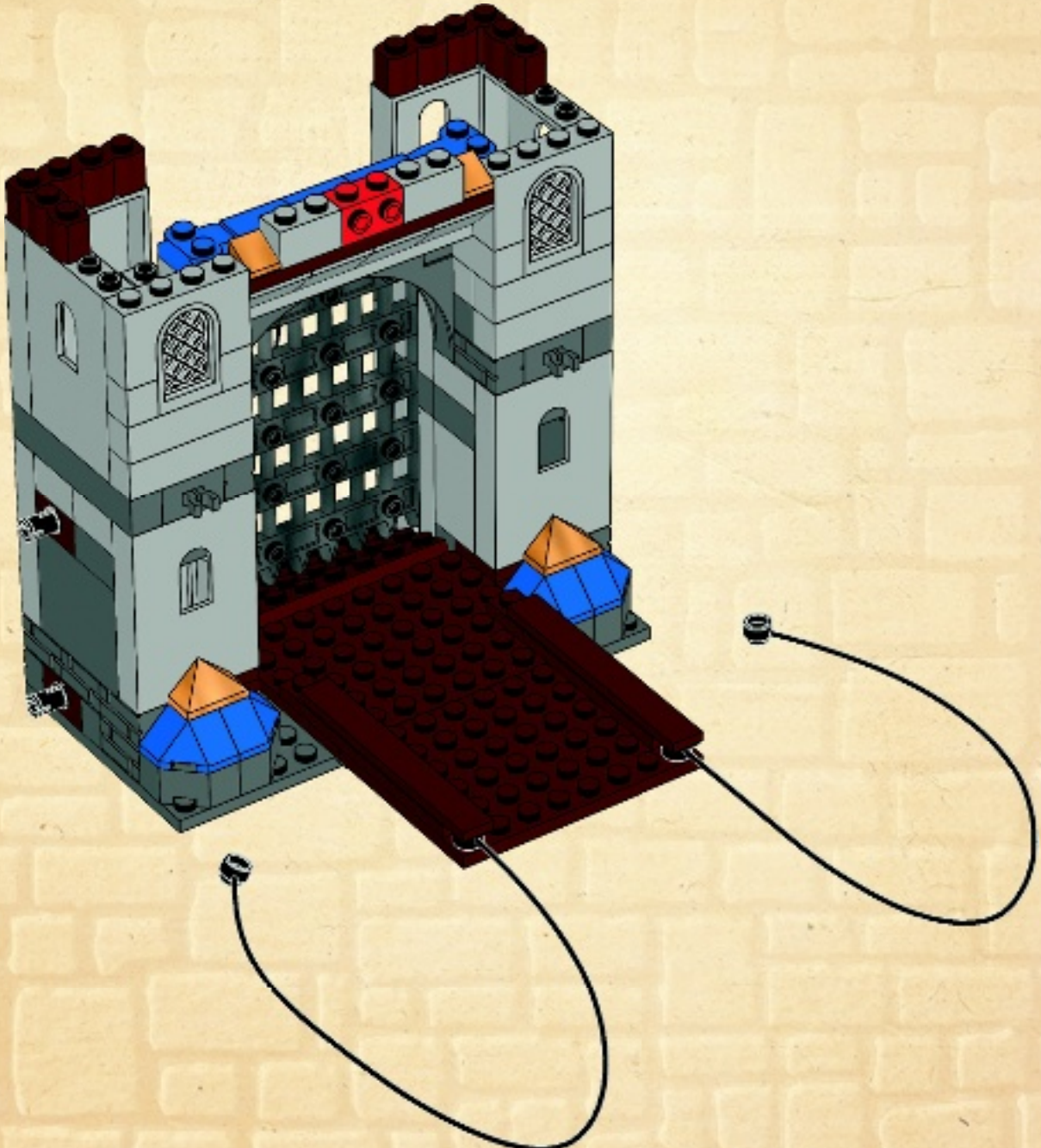



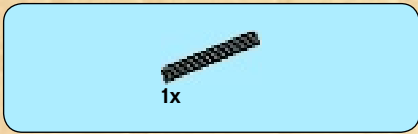

1

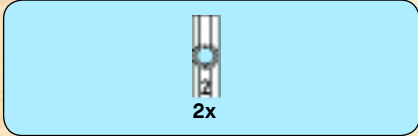

2

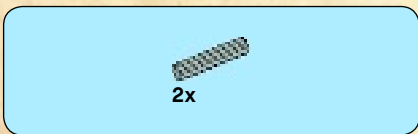
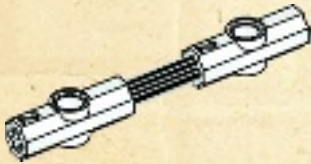

3

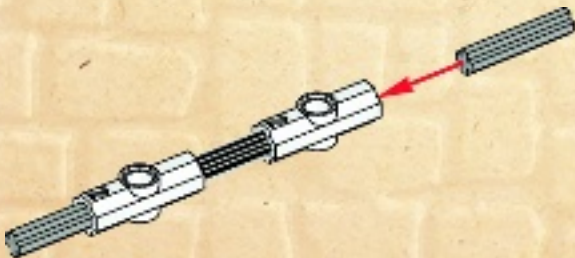

4

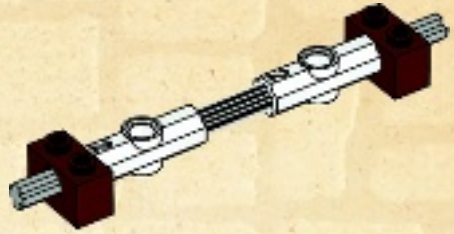

5

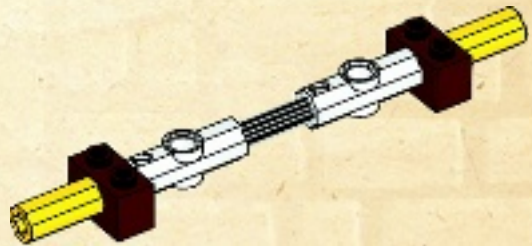





2x

6

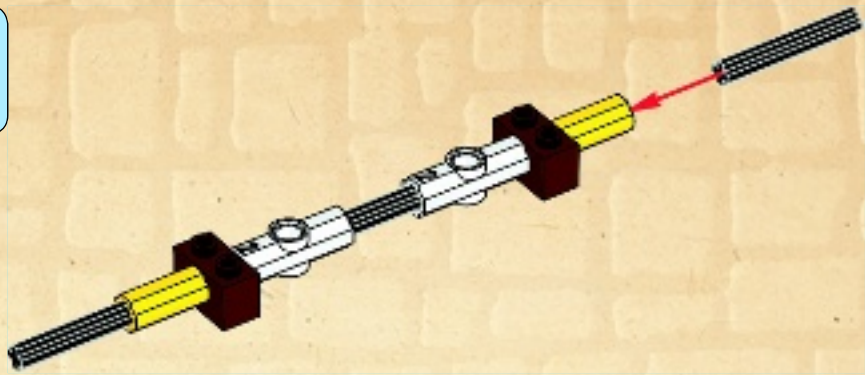

2x

7

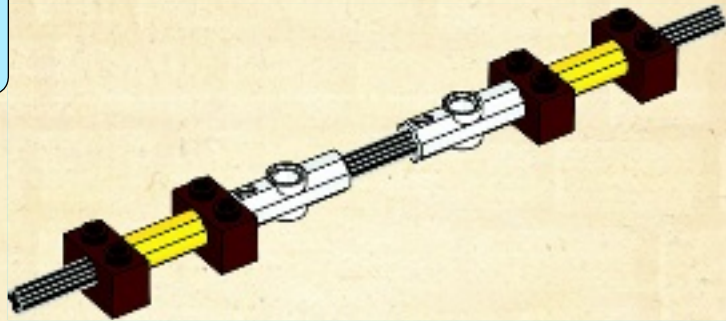

2x

8

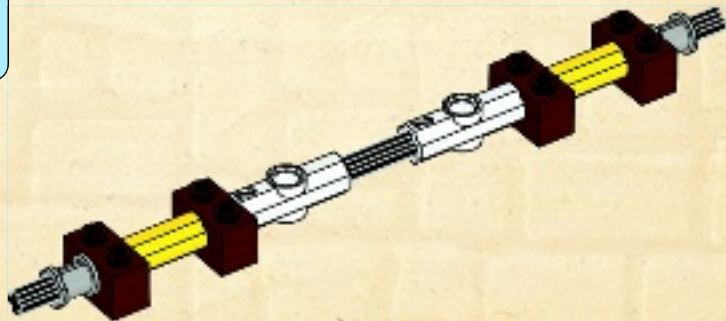

2x

9

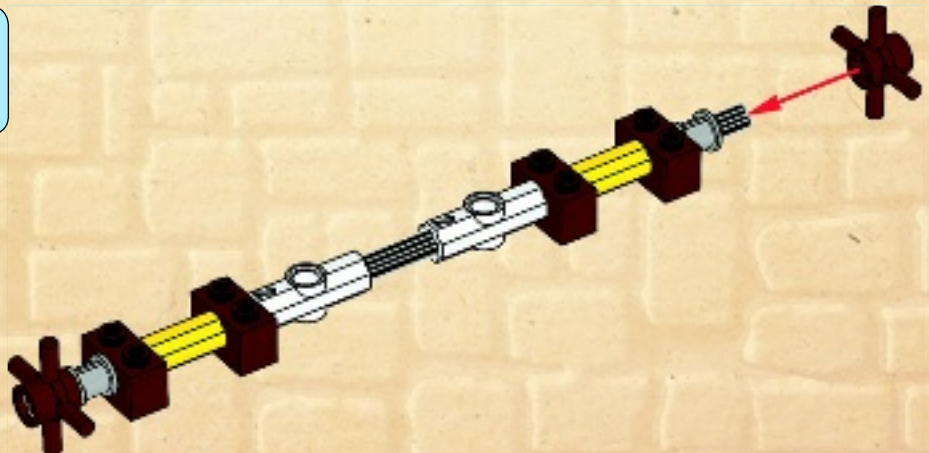



31

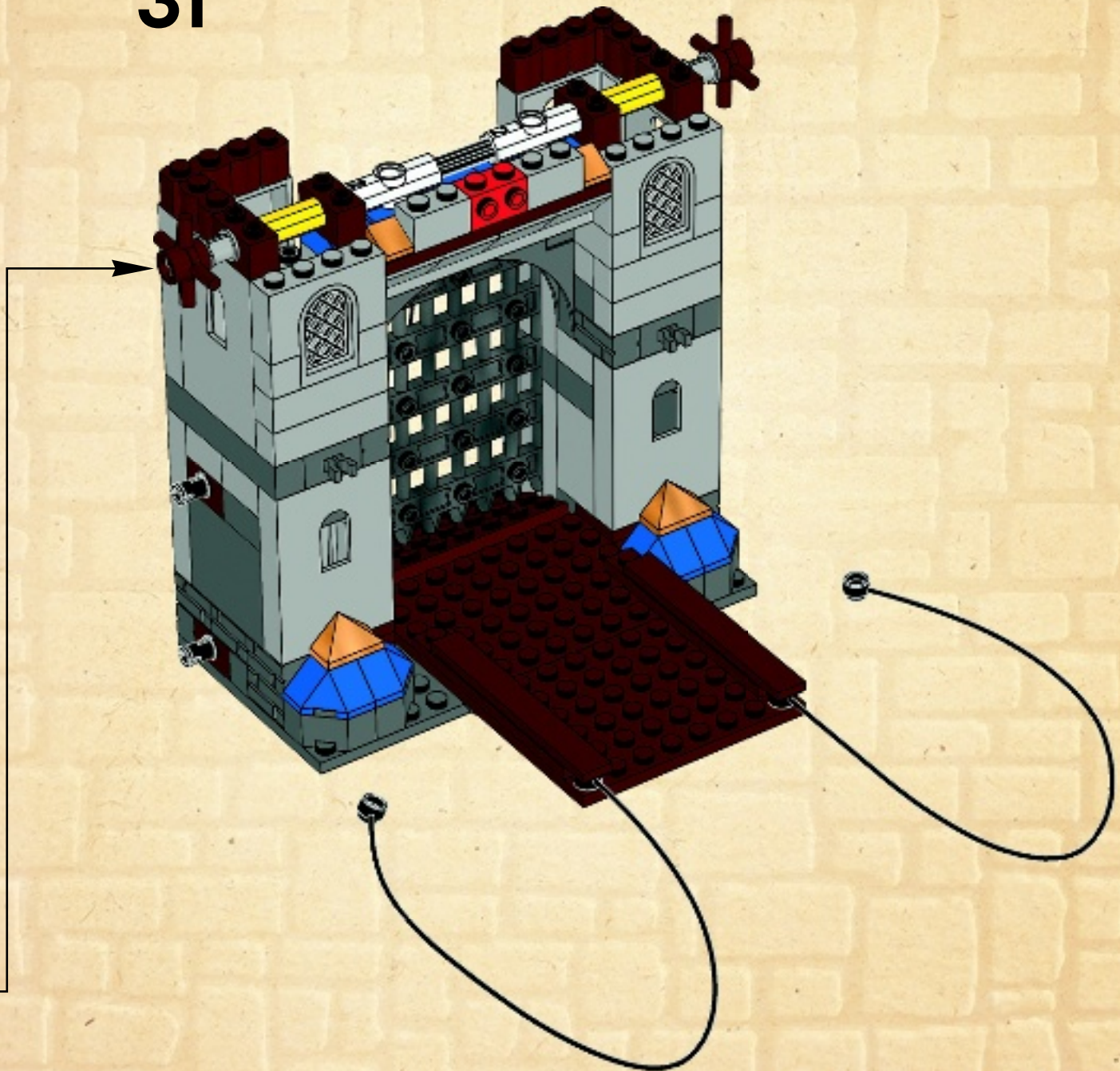



32

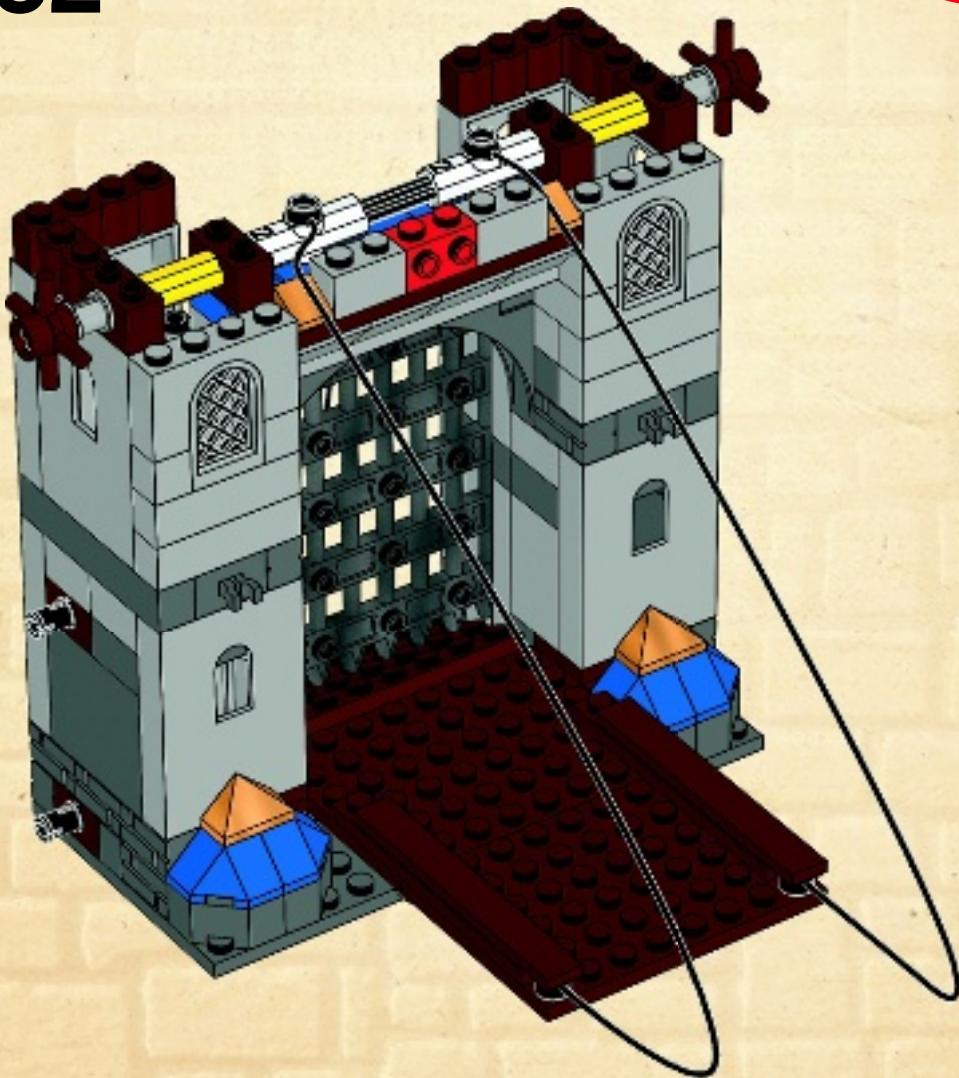
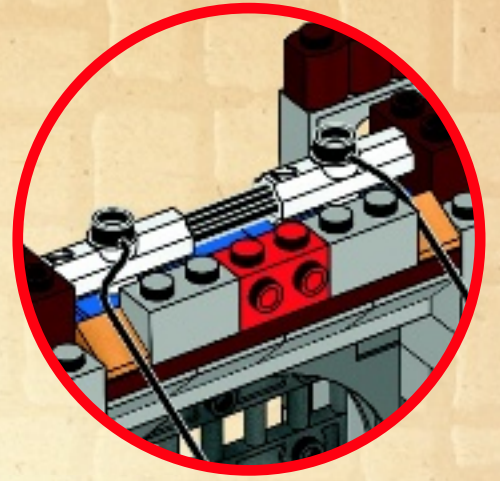





# 33

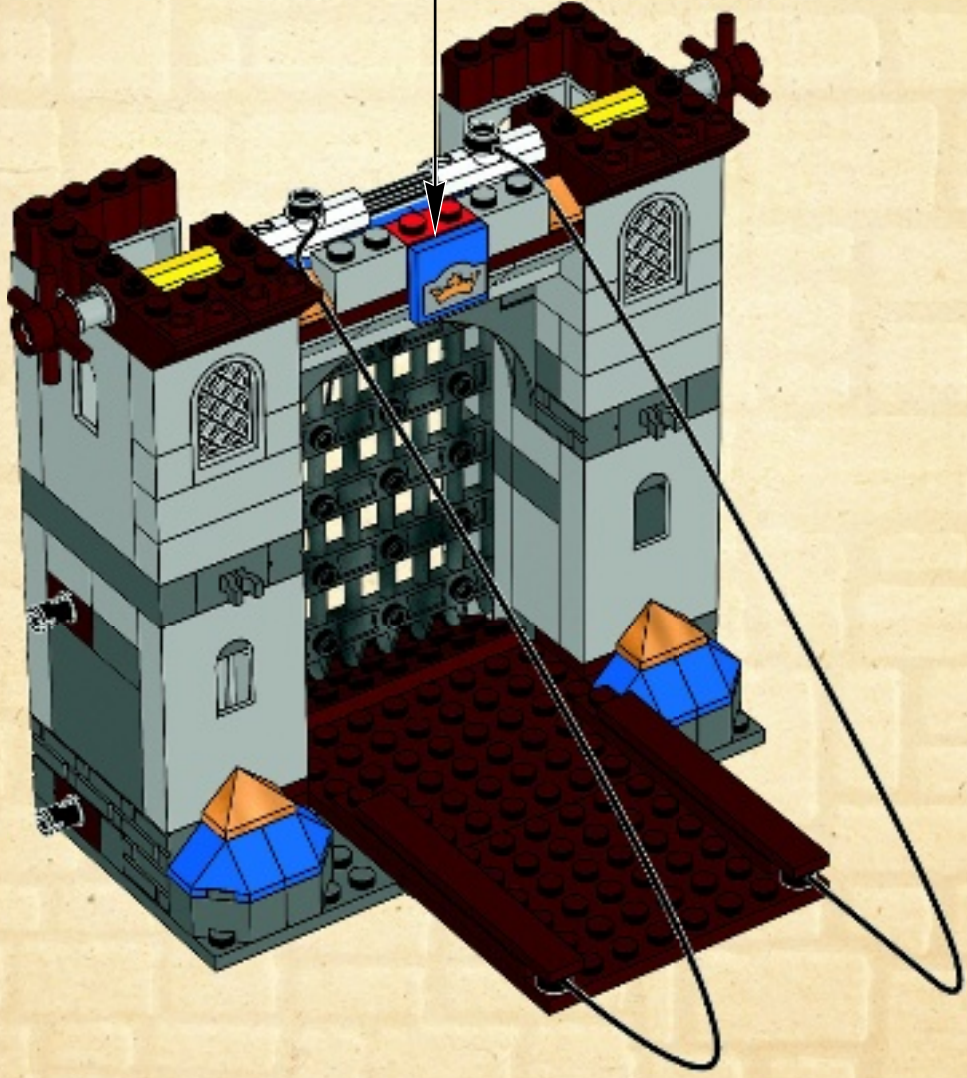
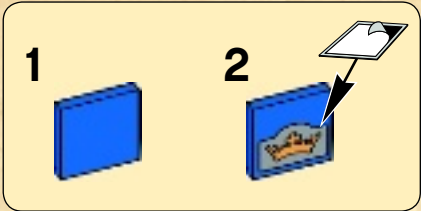





# 34

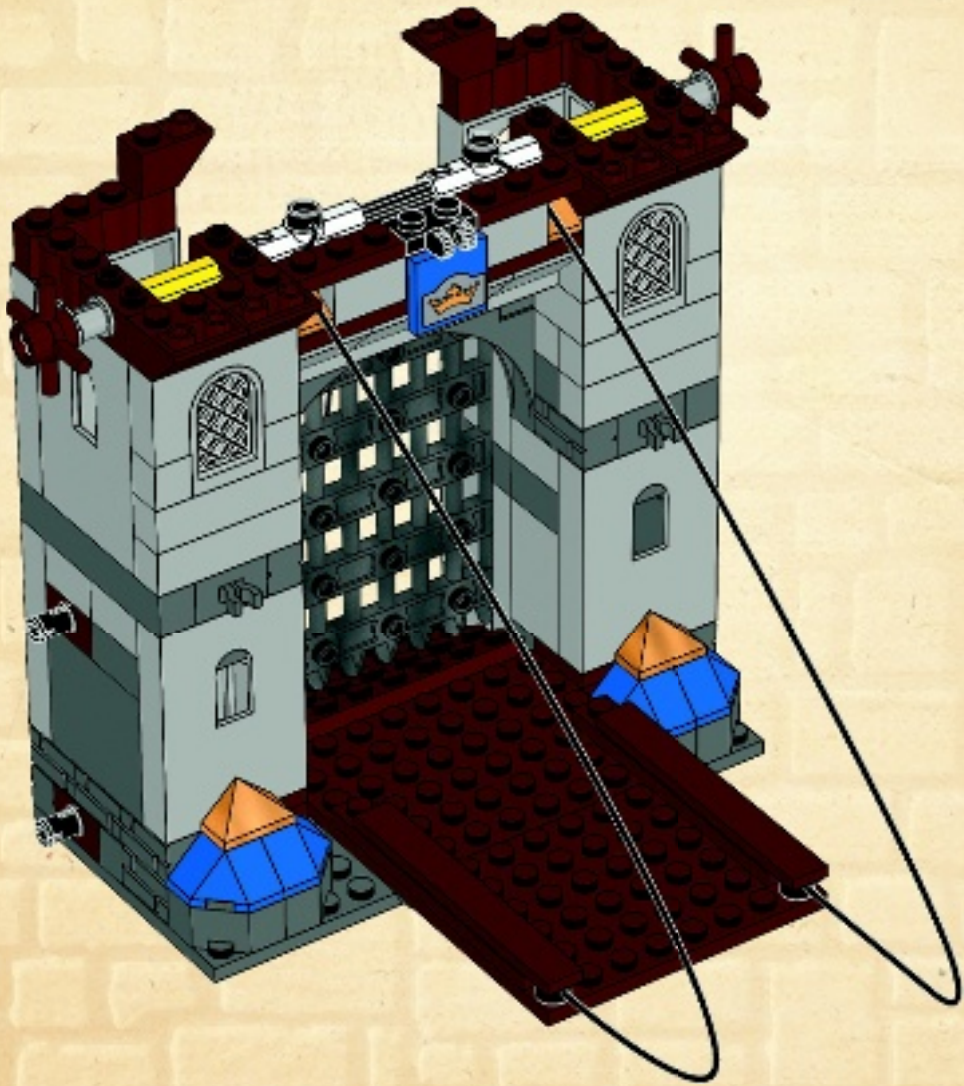



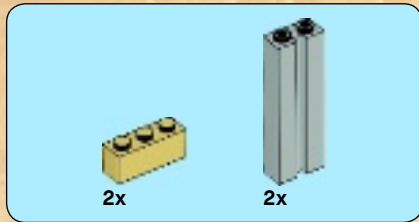

35

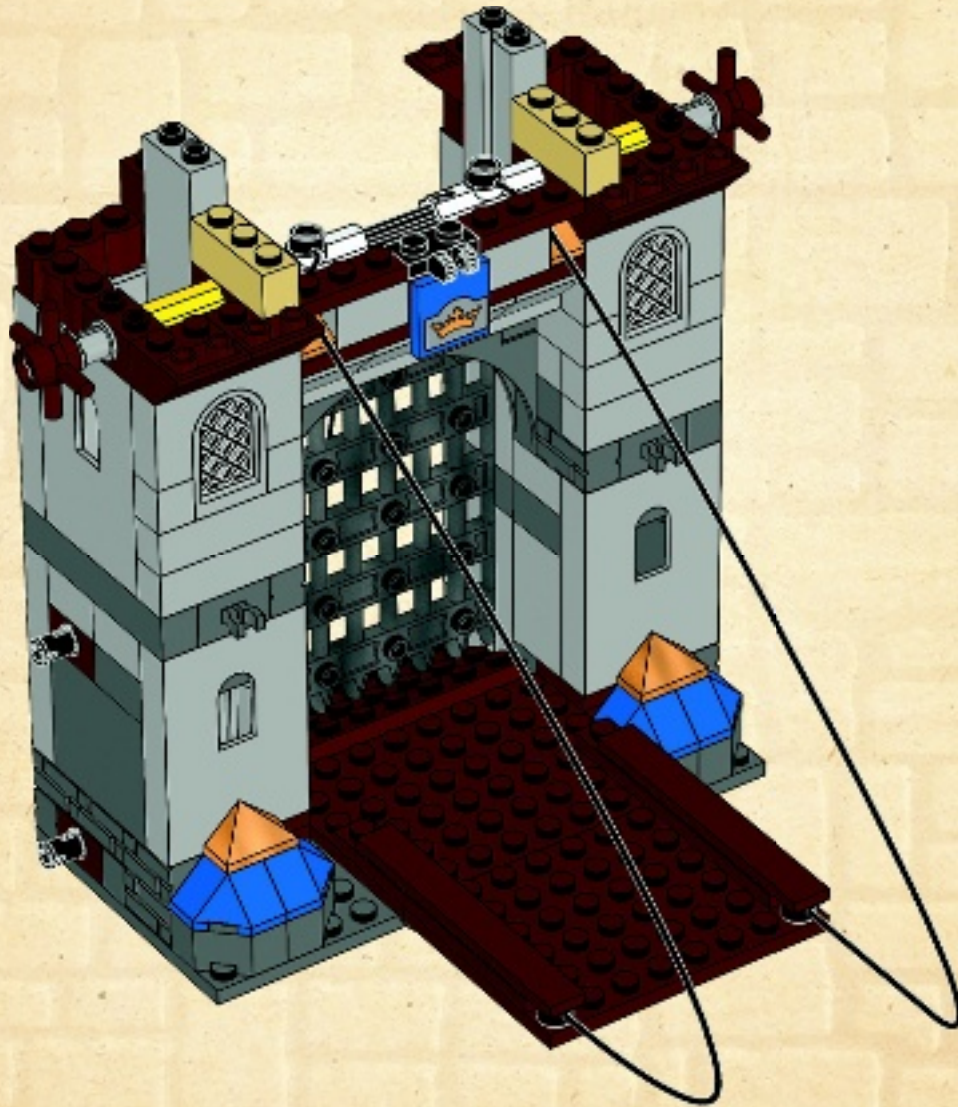



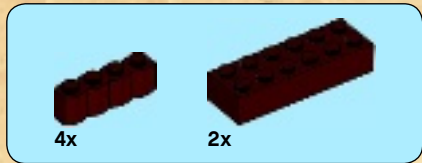

# 36

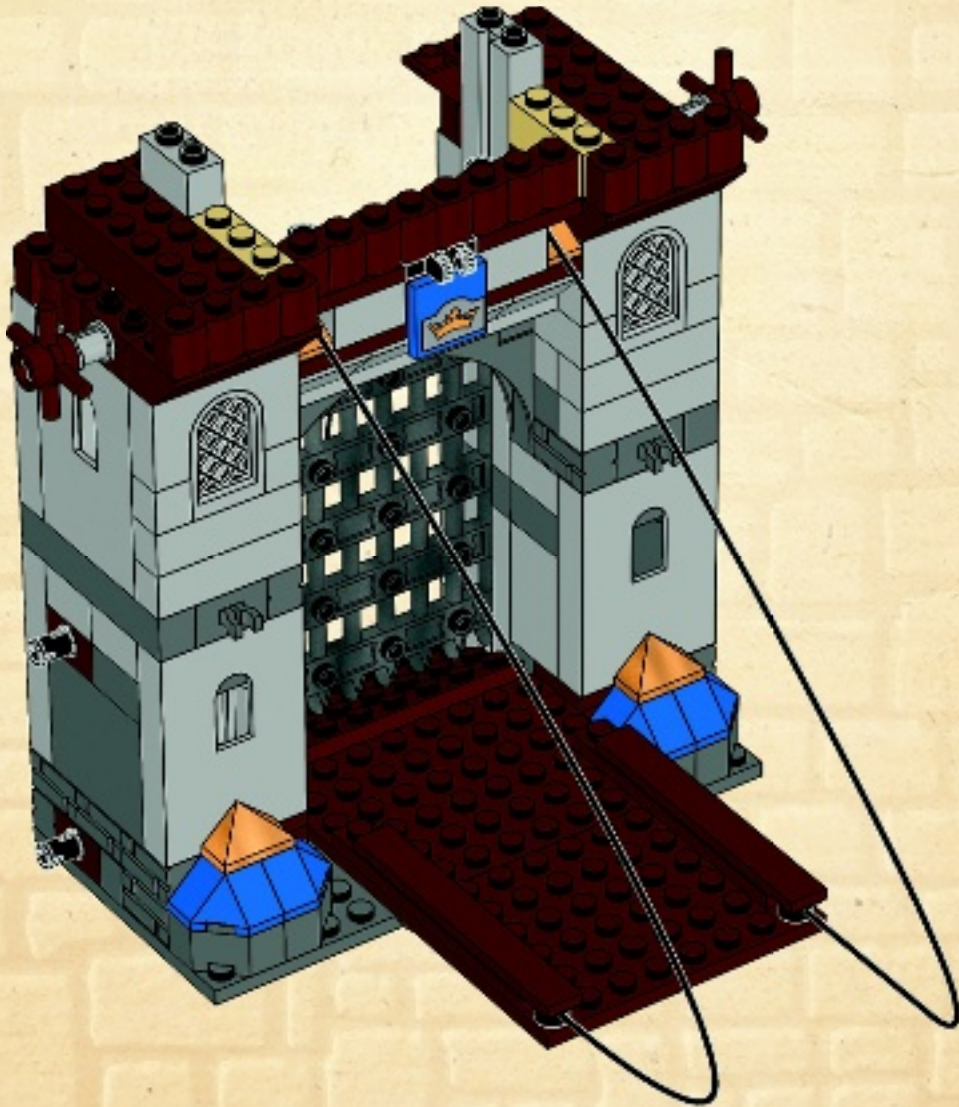





6x

37

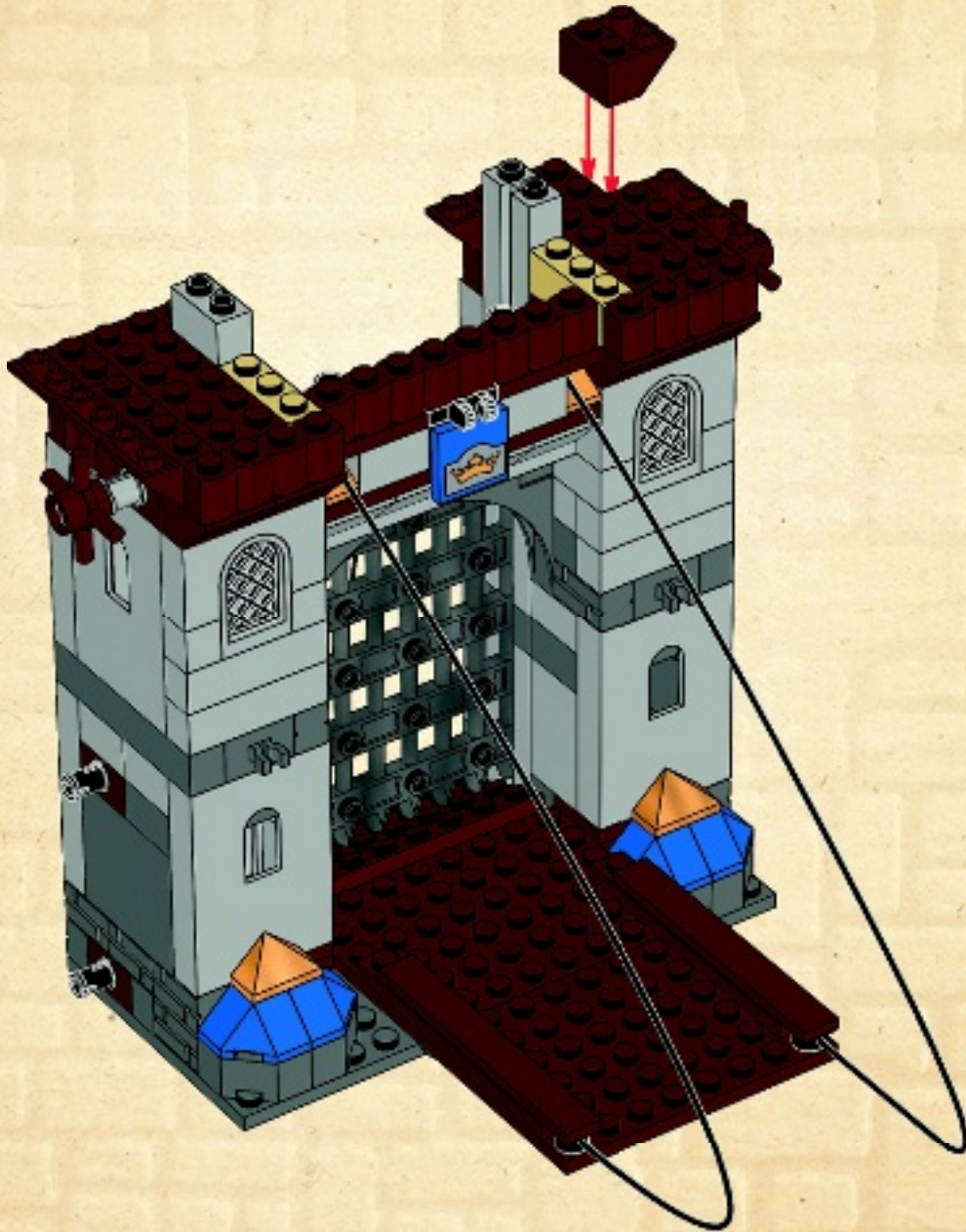



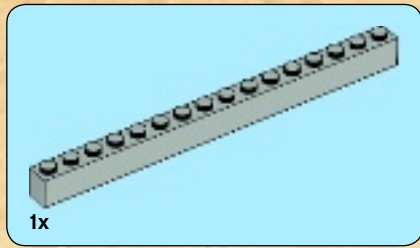

38

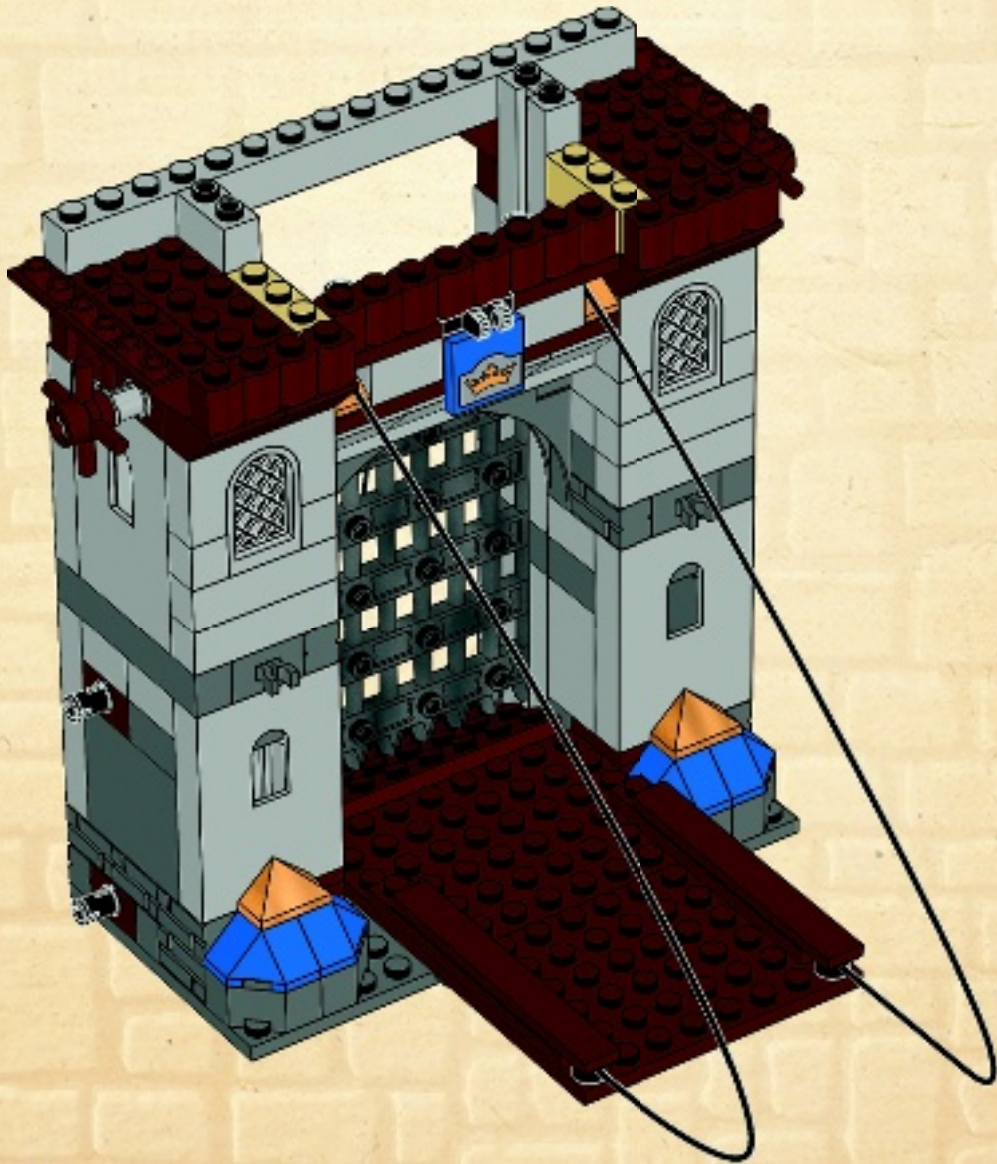



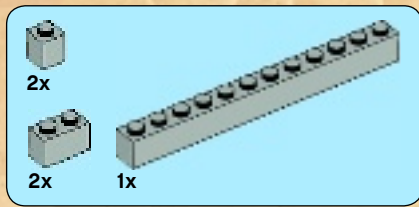

39

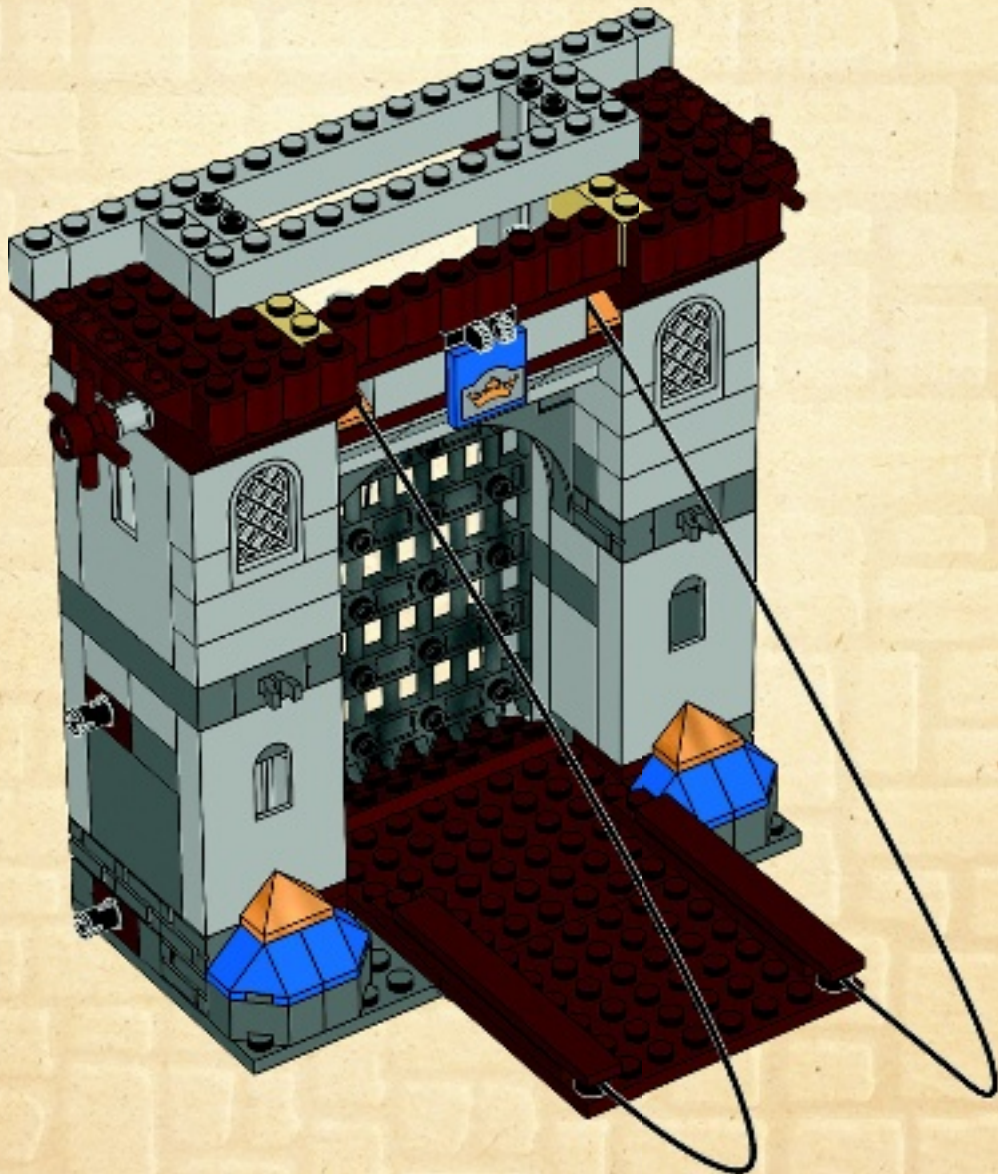



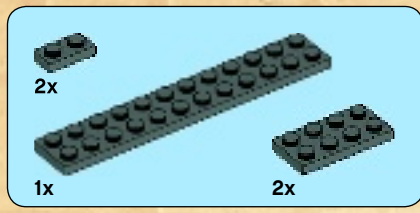

40

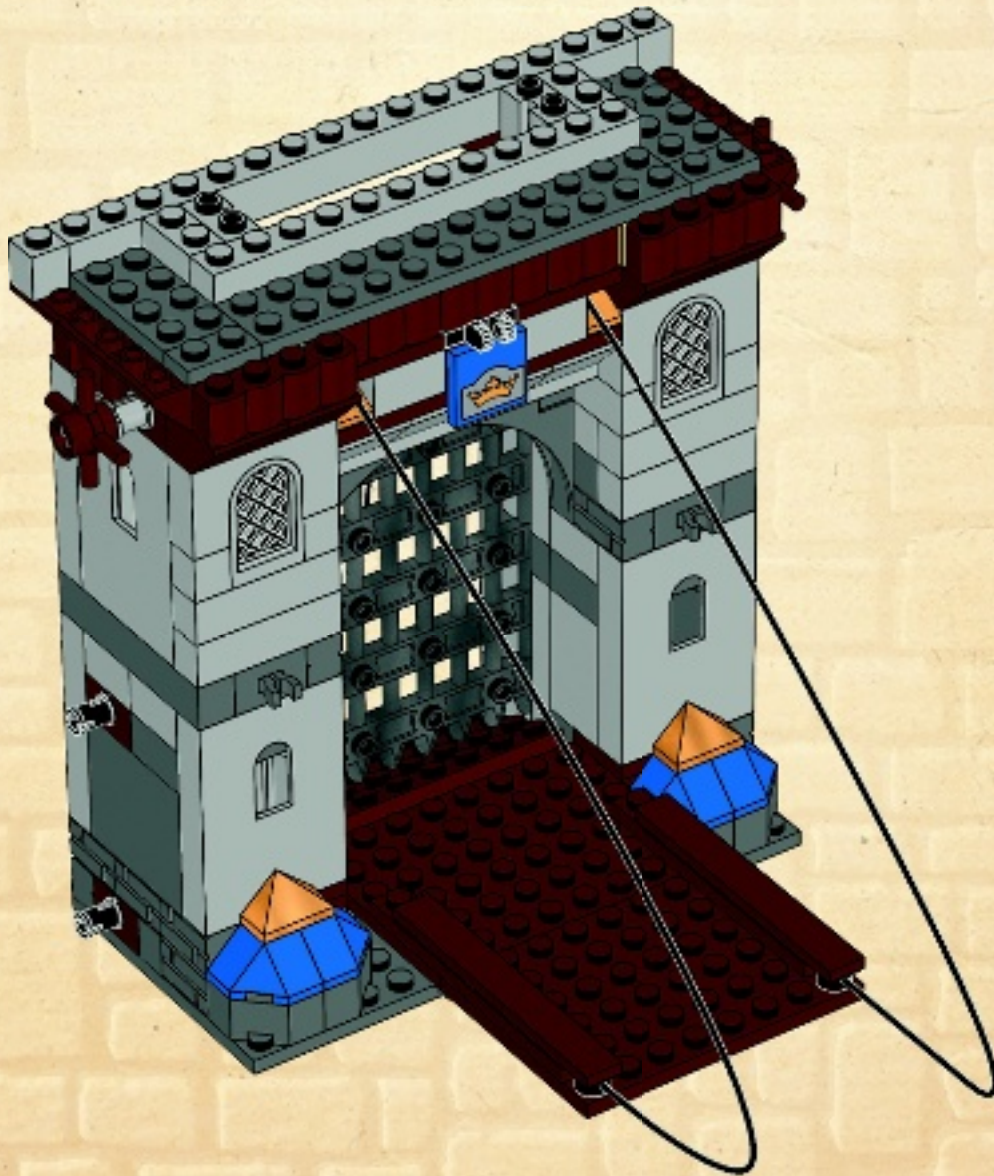



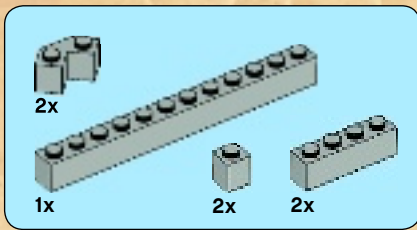

41

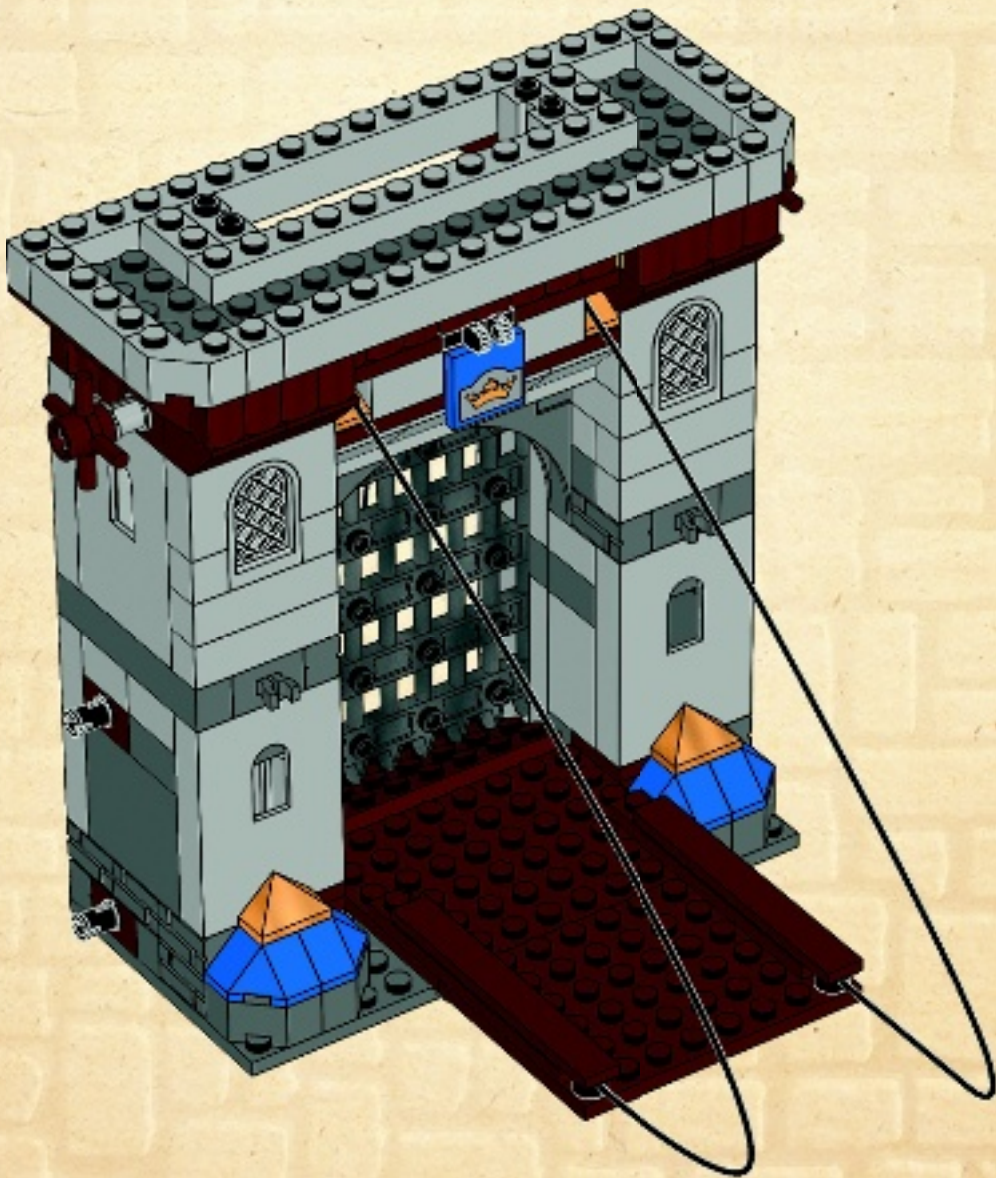





2x



2x

# 42

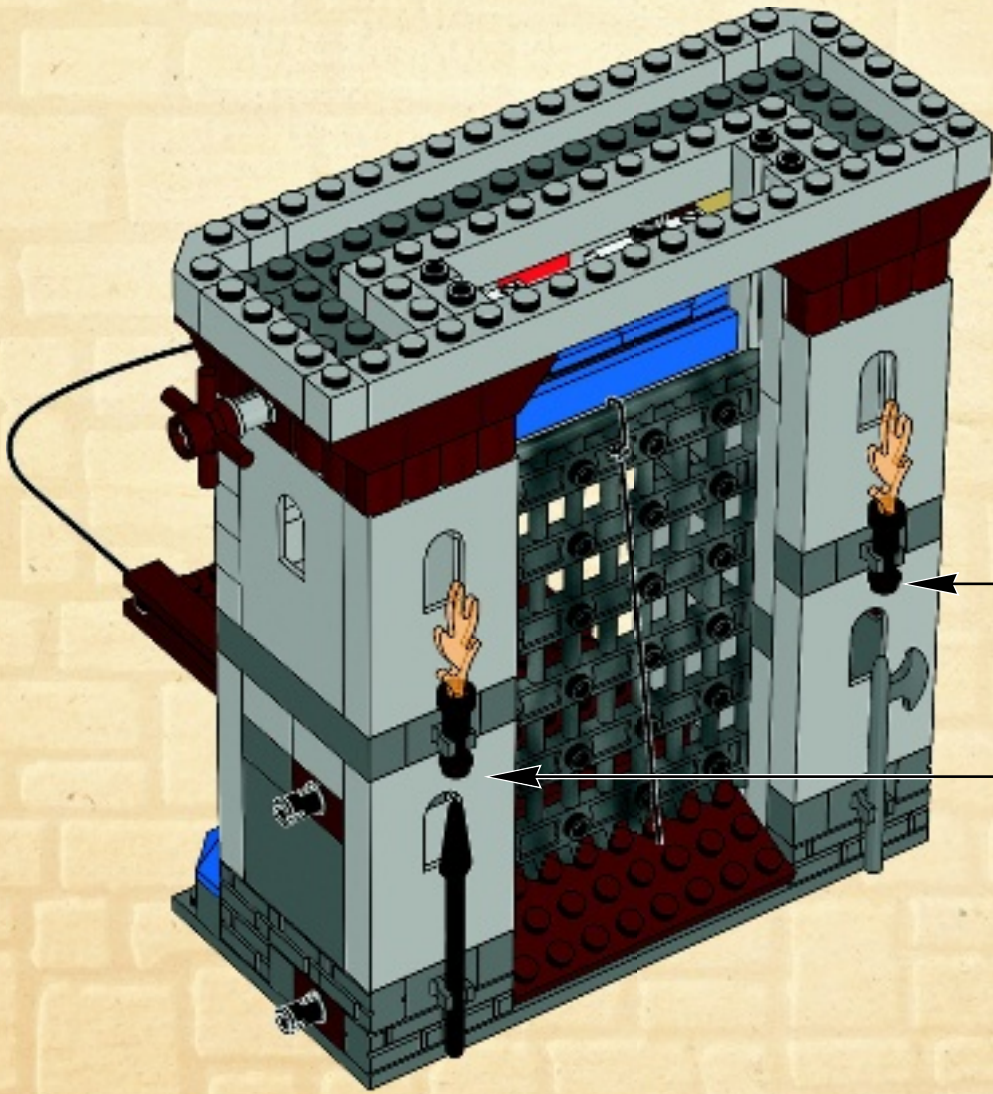
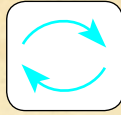

2x



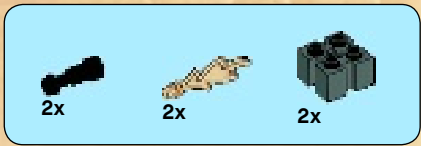

# 43

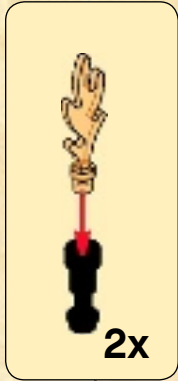
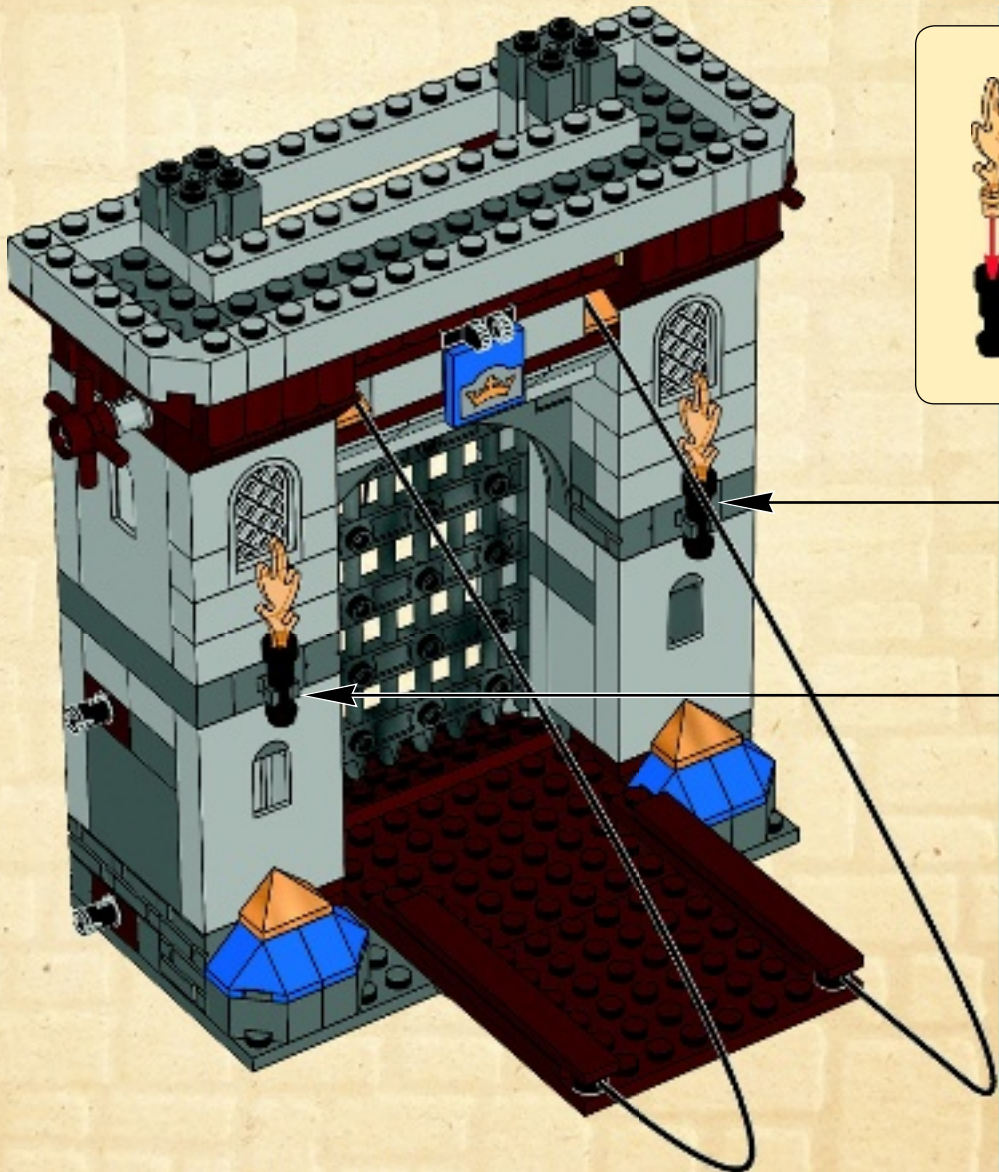





44

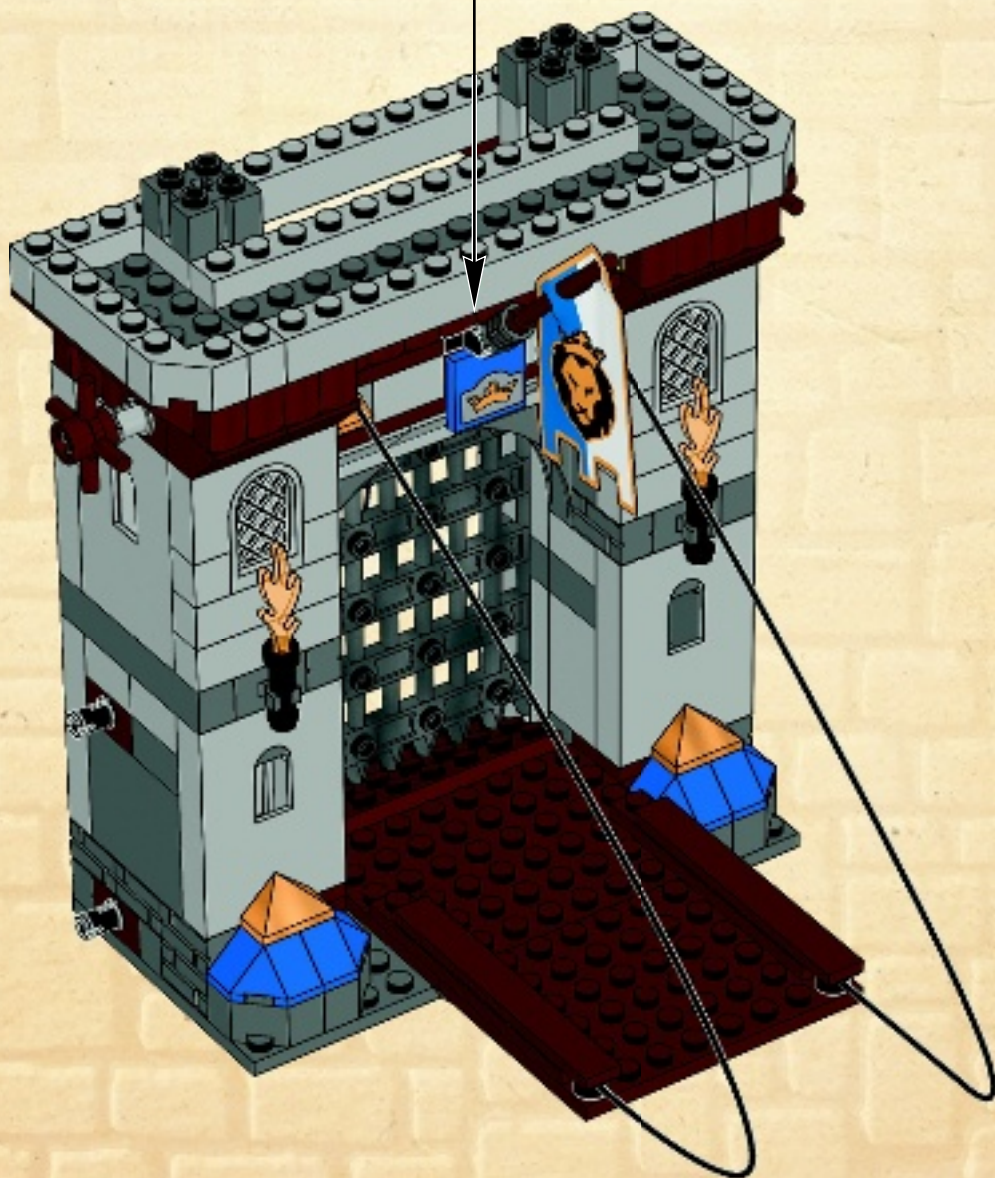



4

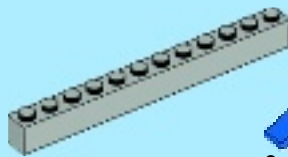
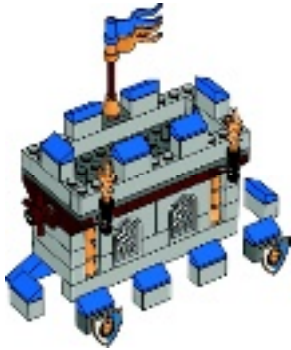

1x



2x

45

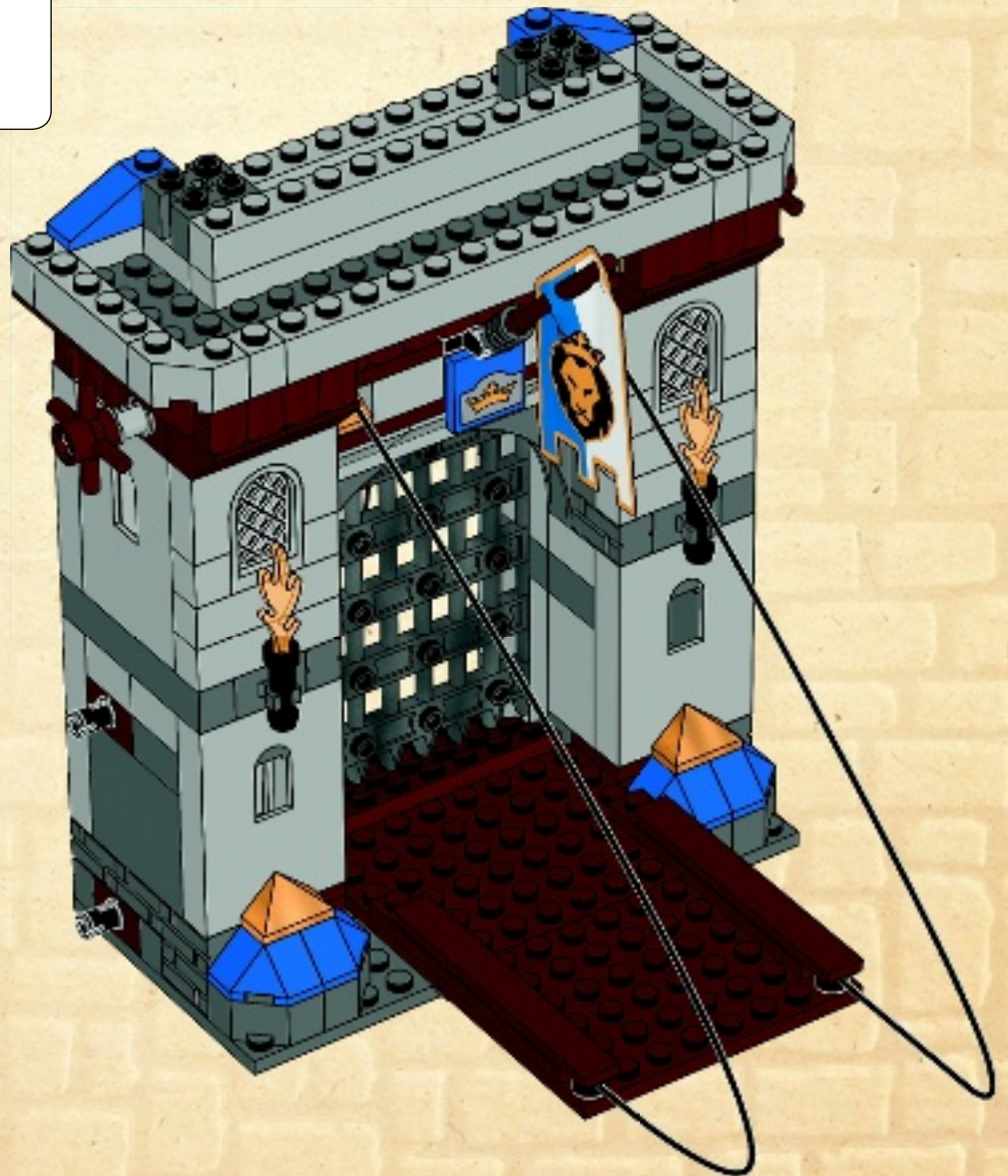





2x



4x

# 46

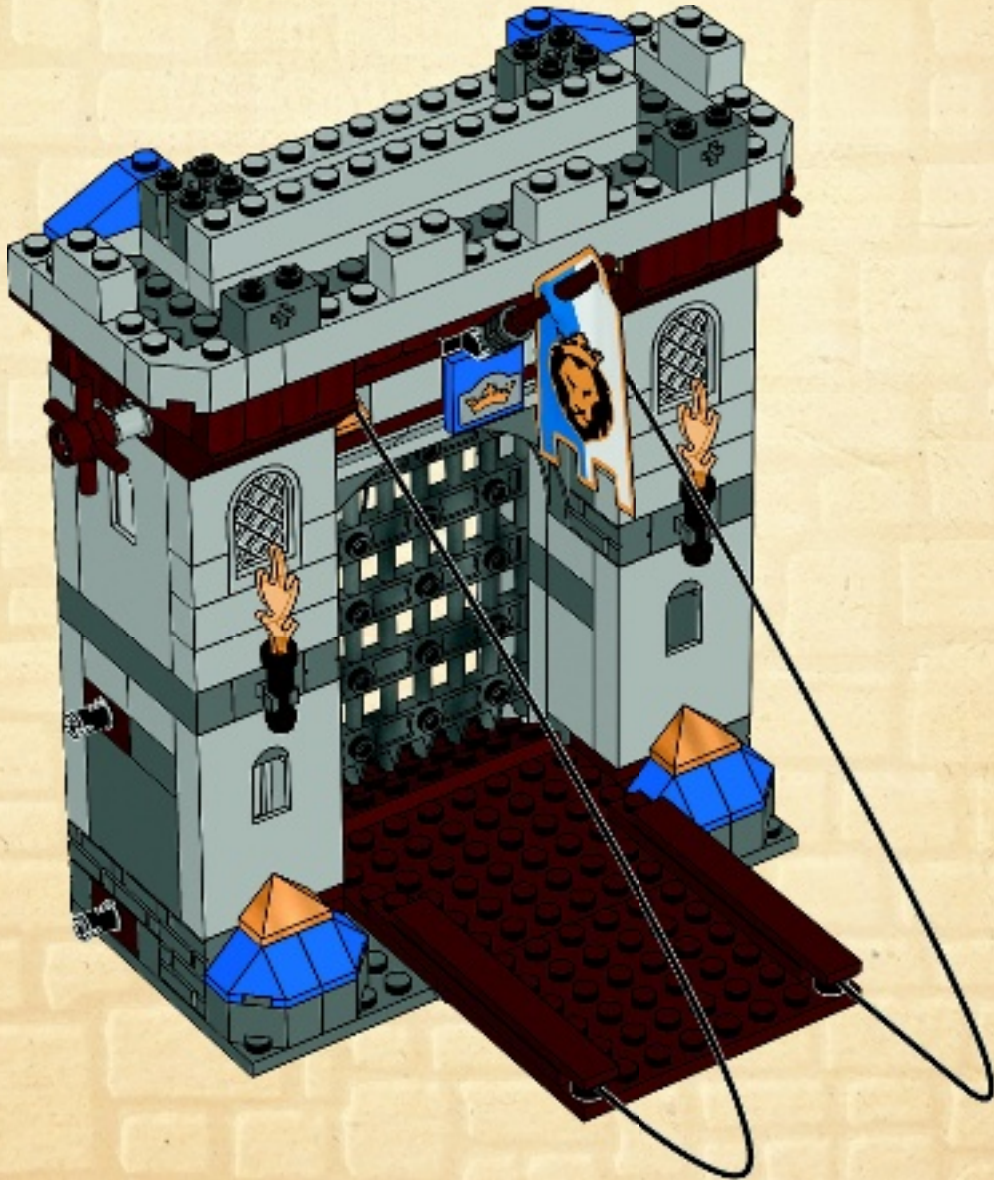





6x



2x

47

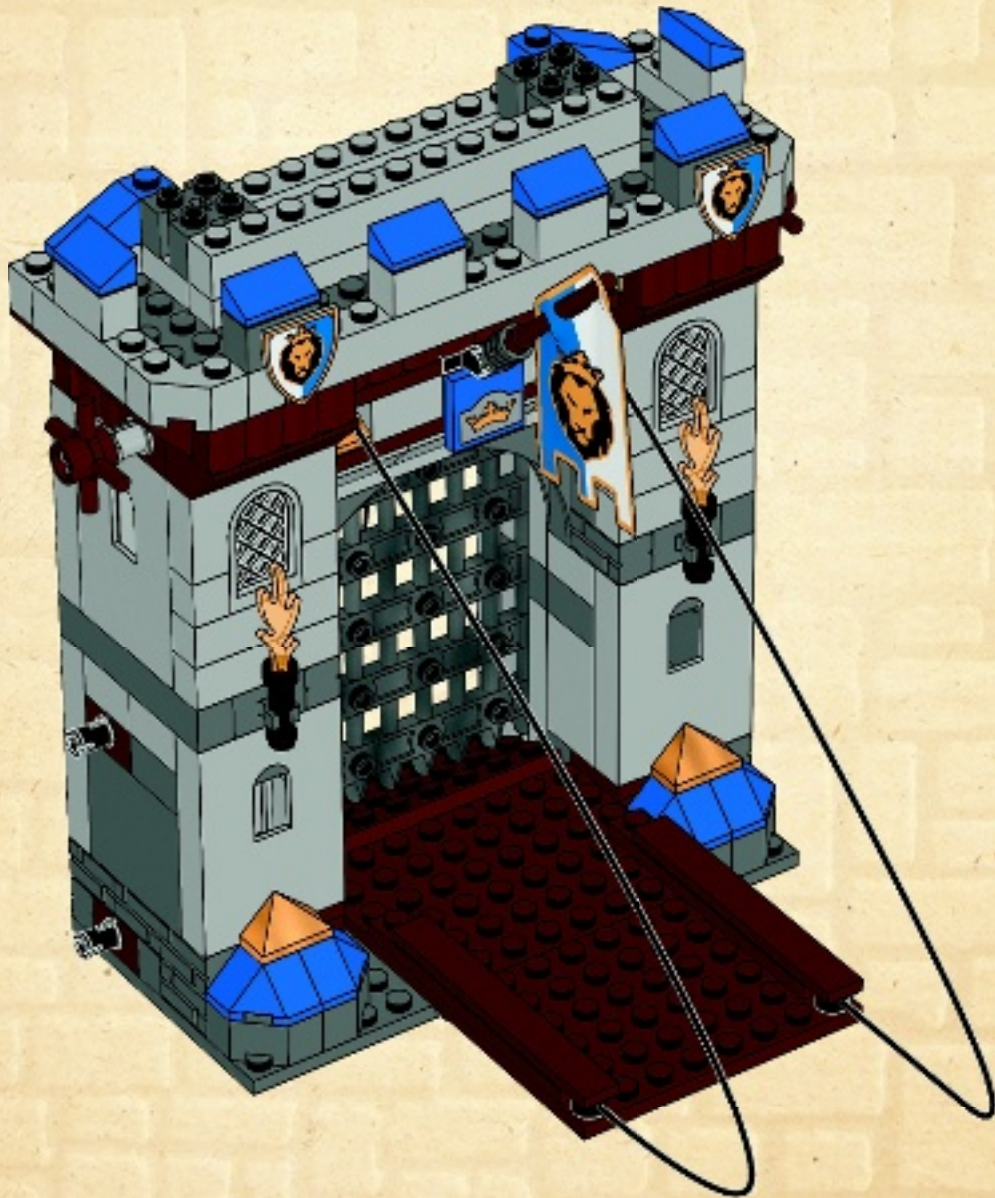





6x

# 48

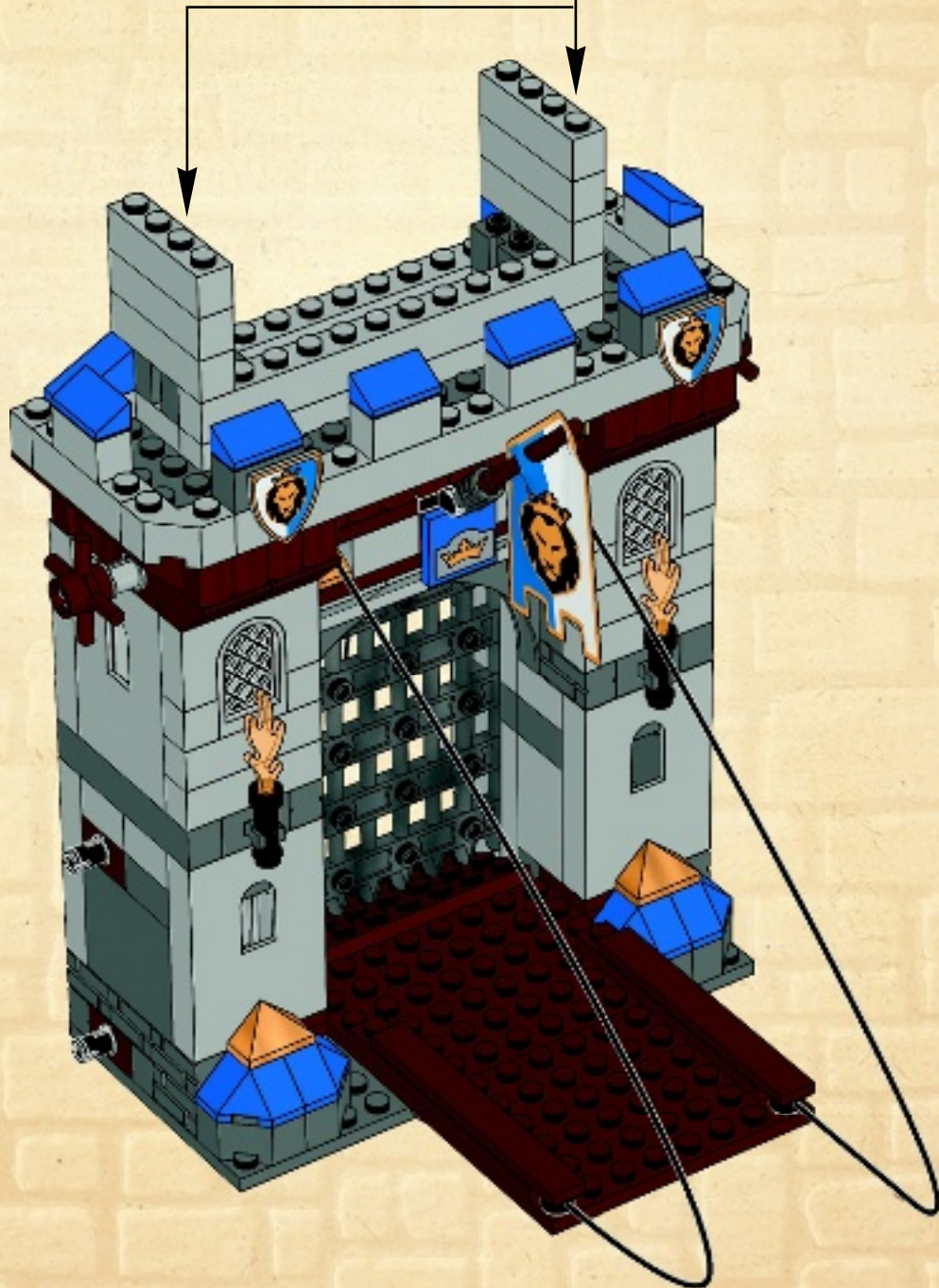
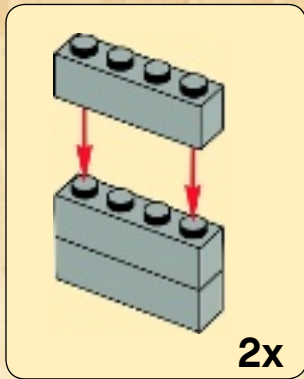



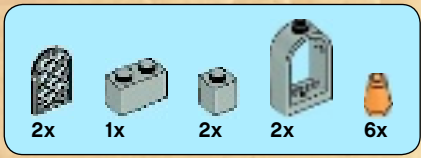

49

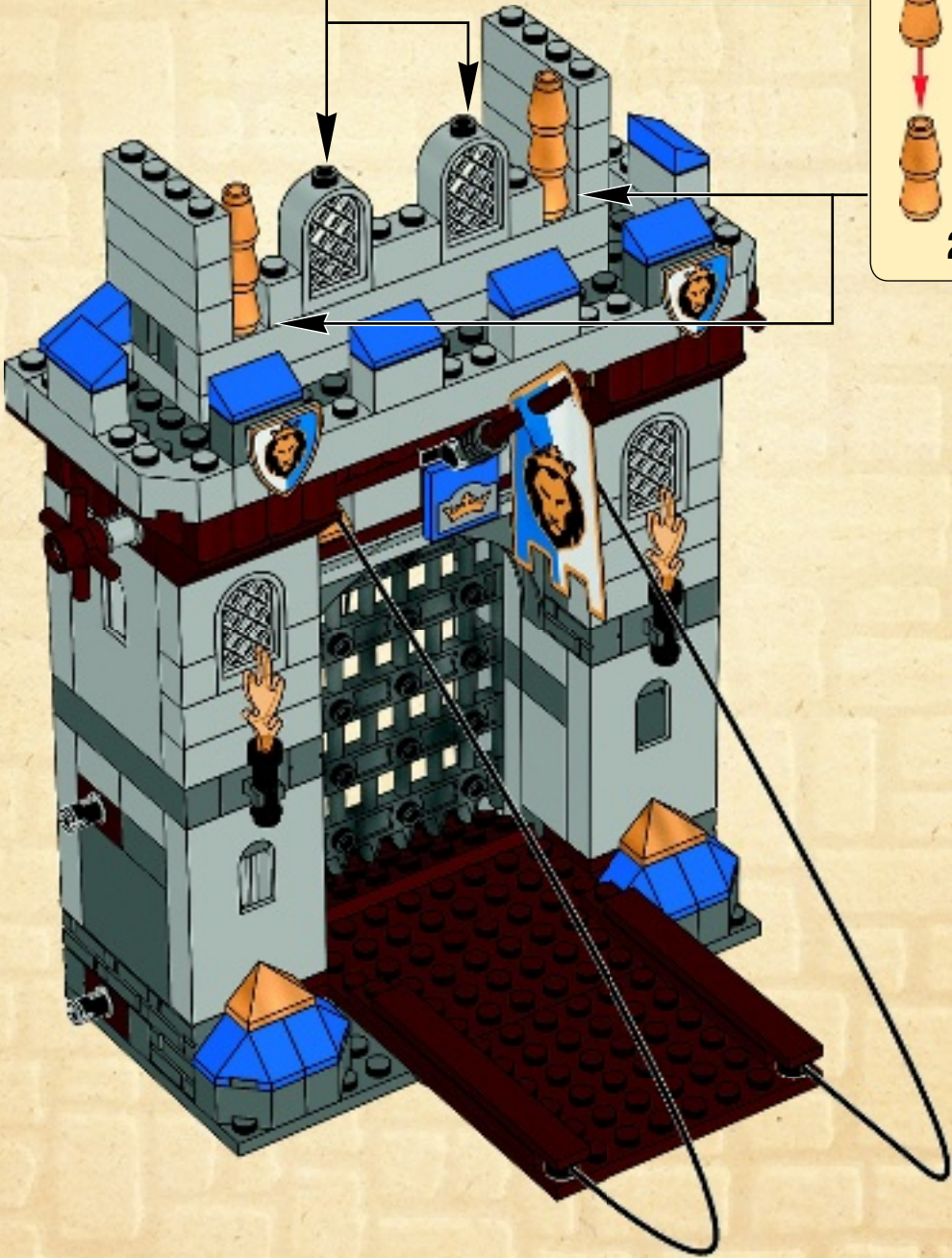
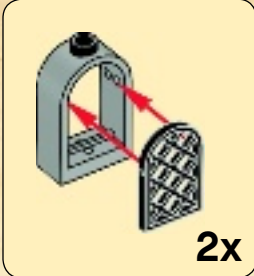



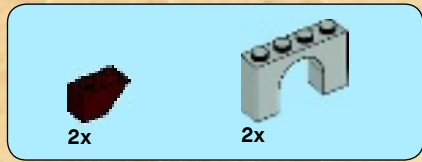

50

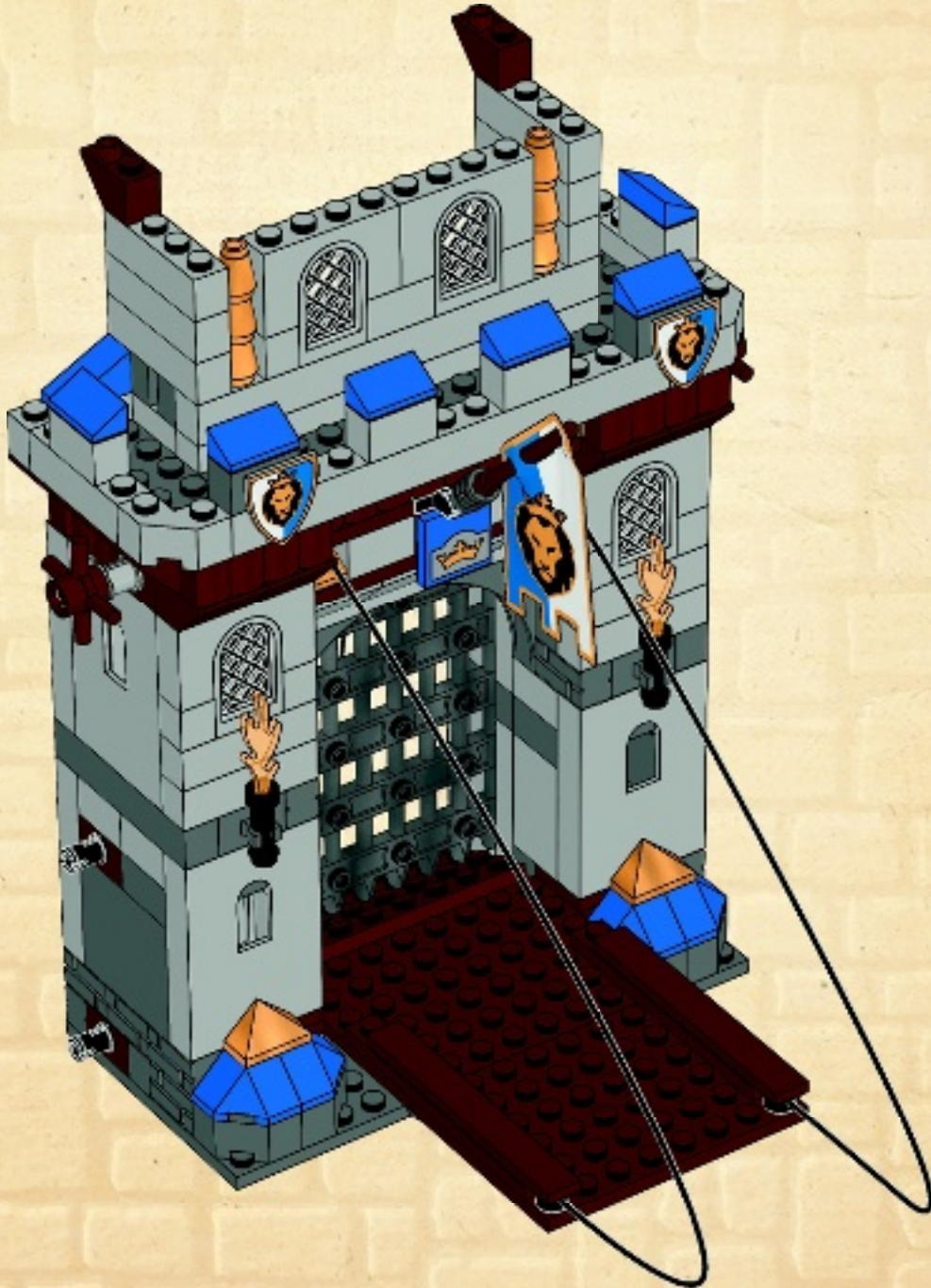



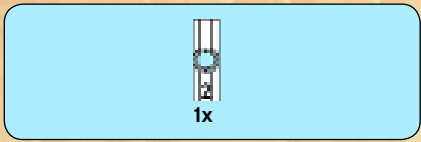

1



3

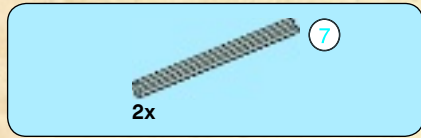
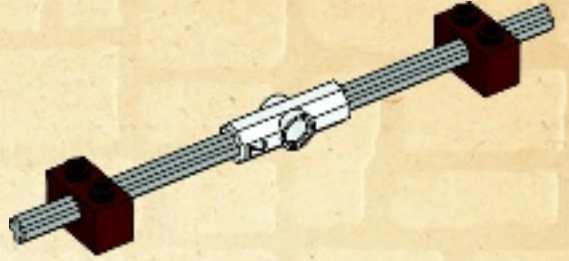

2

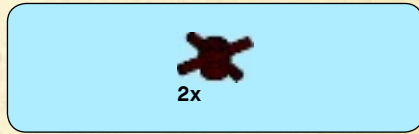
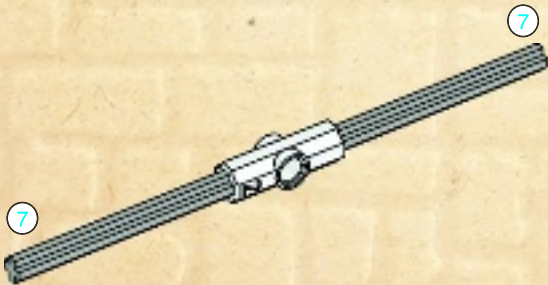

4

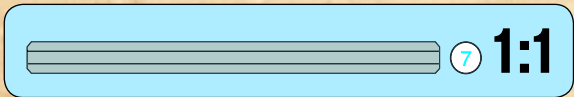
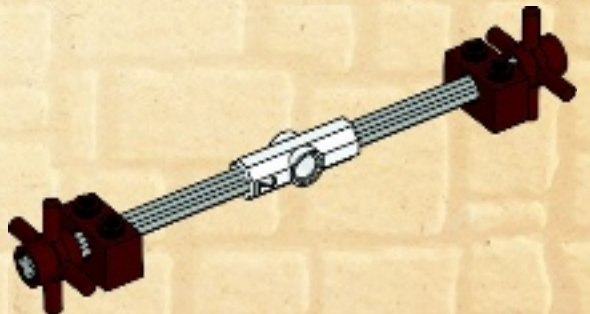



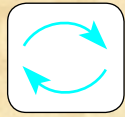

51

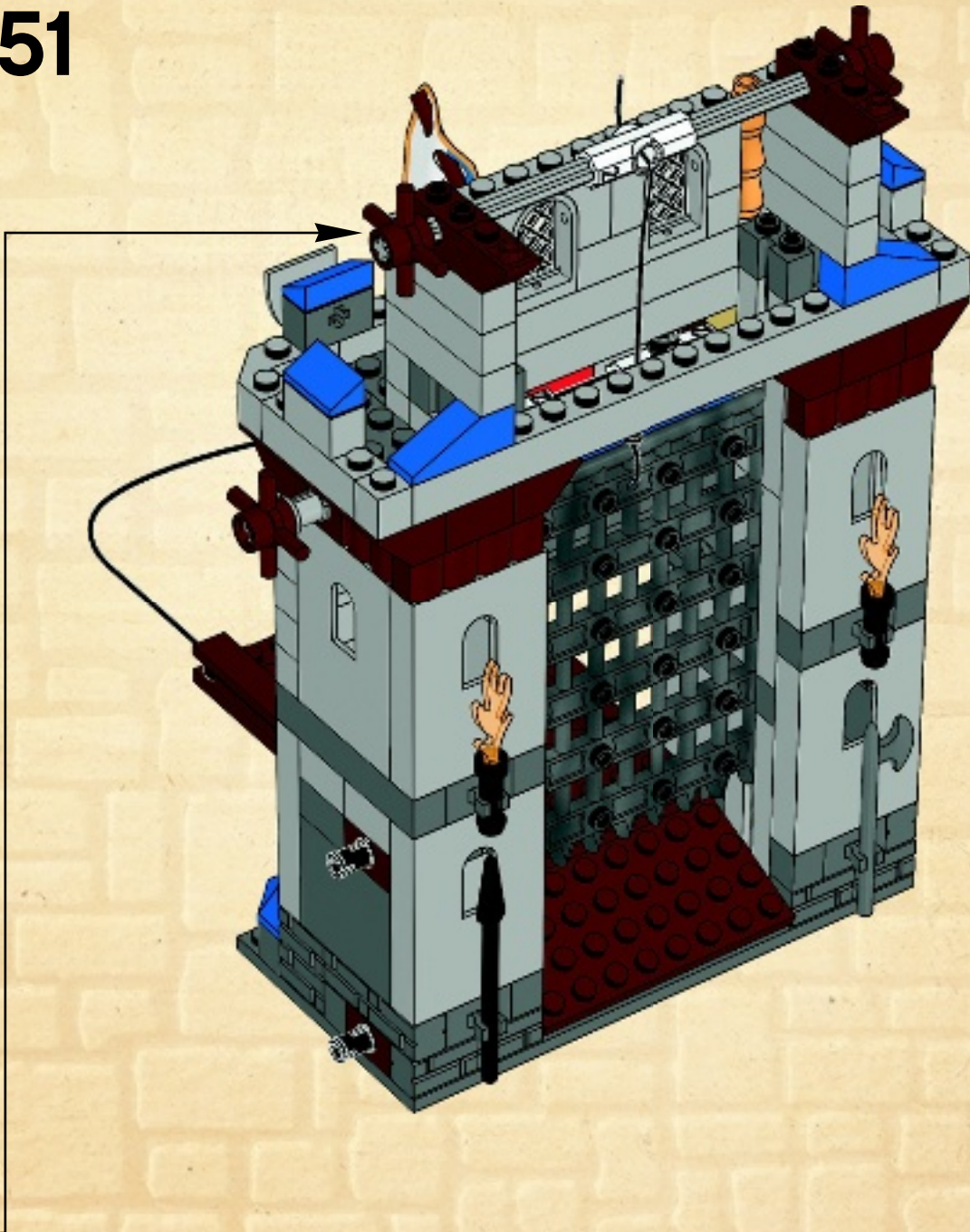



52

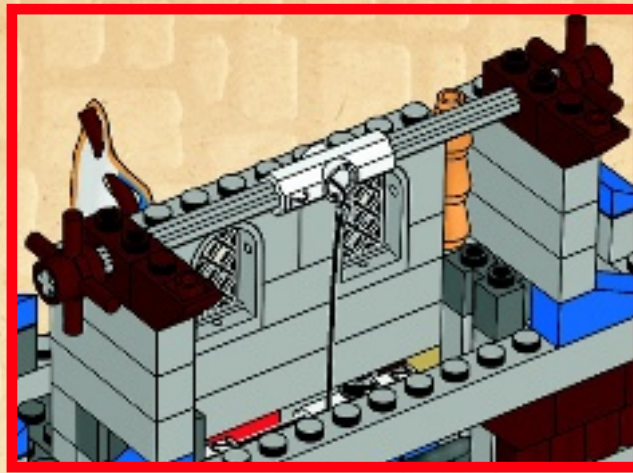

53

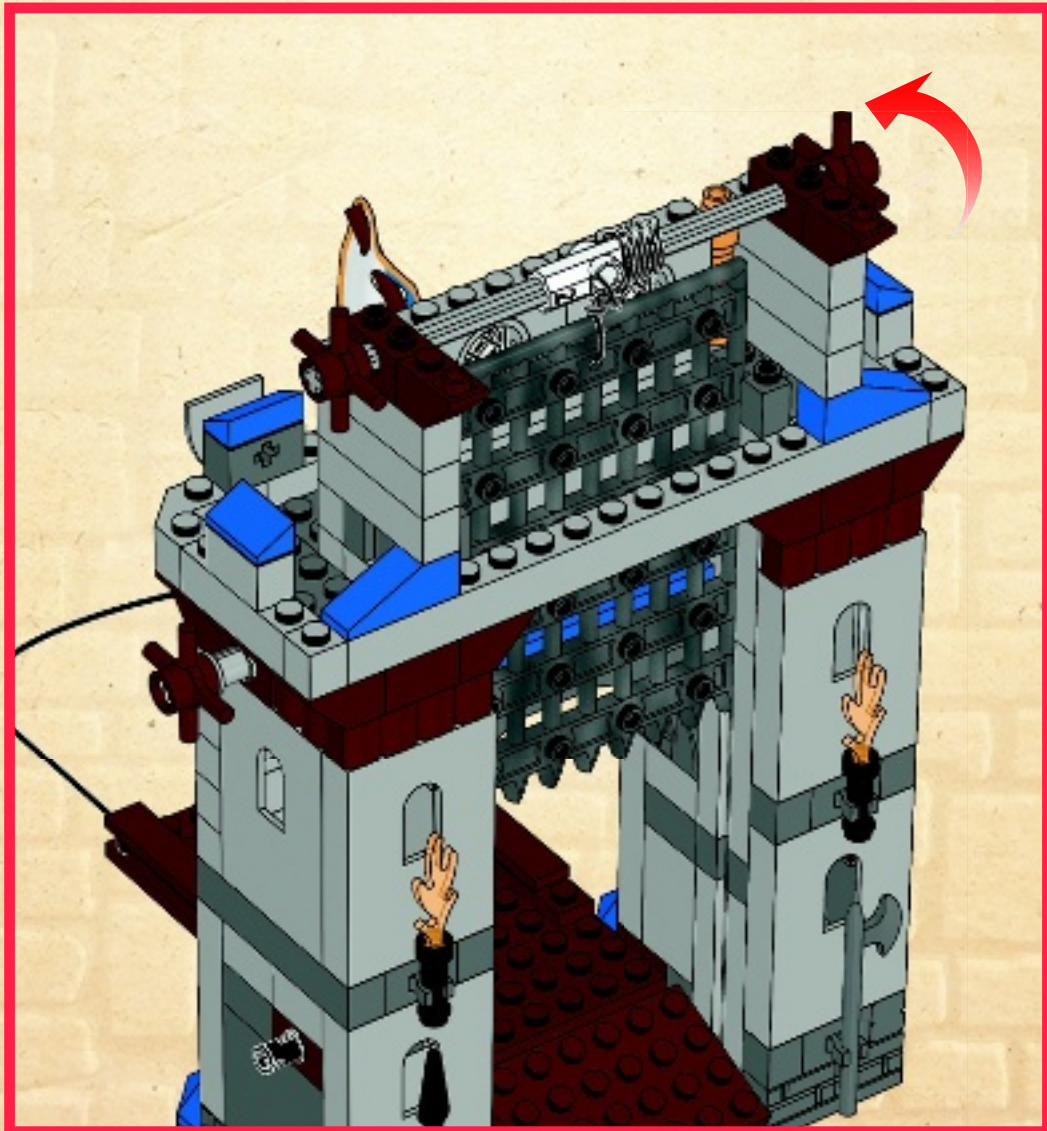



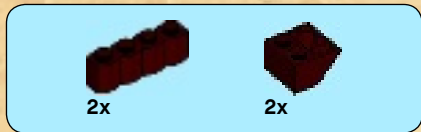

54

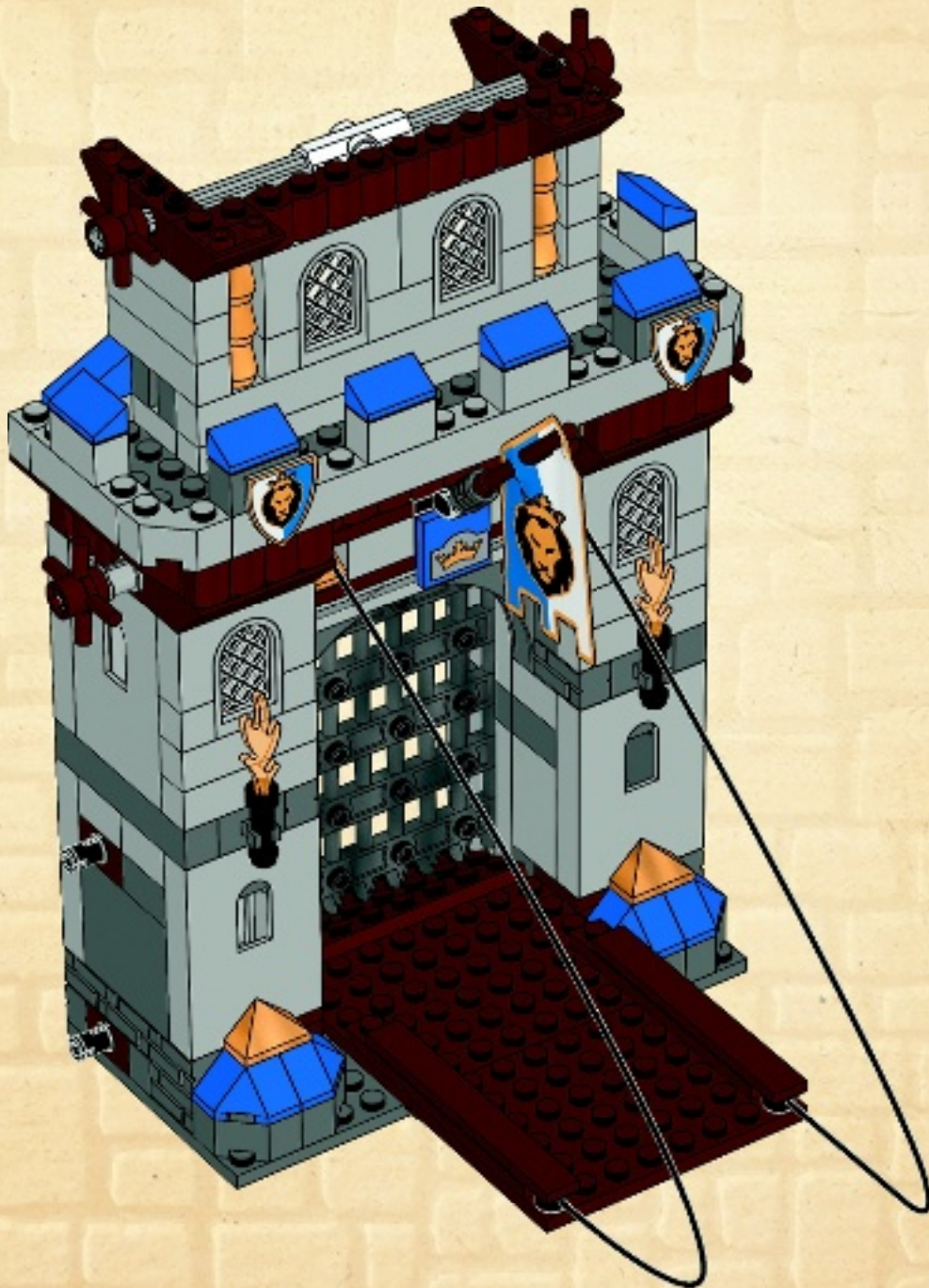



2x  
1x  
2x  
2x

55

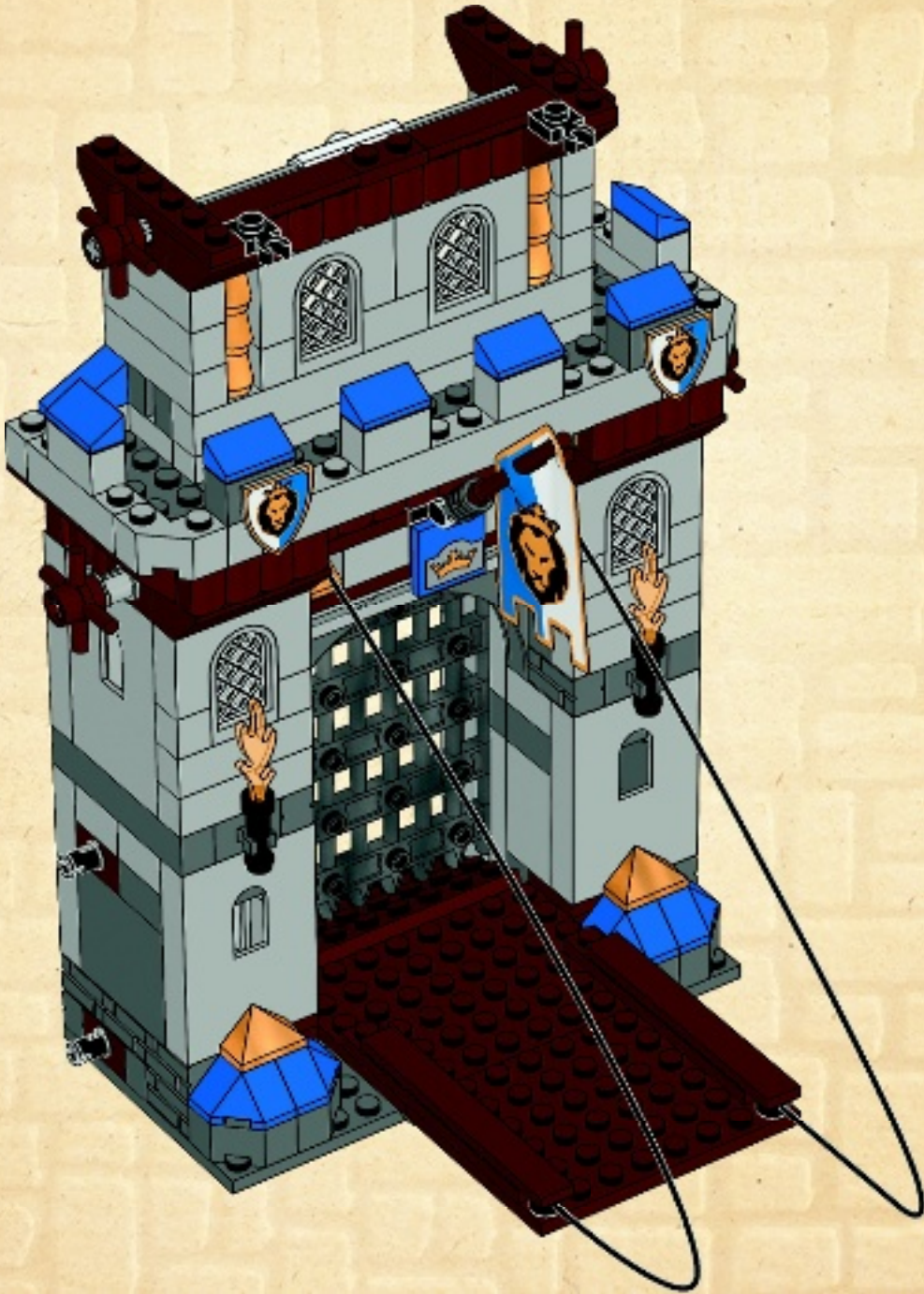



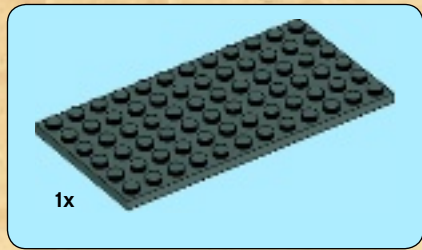

56

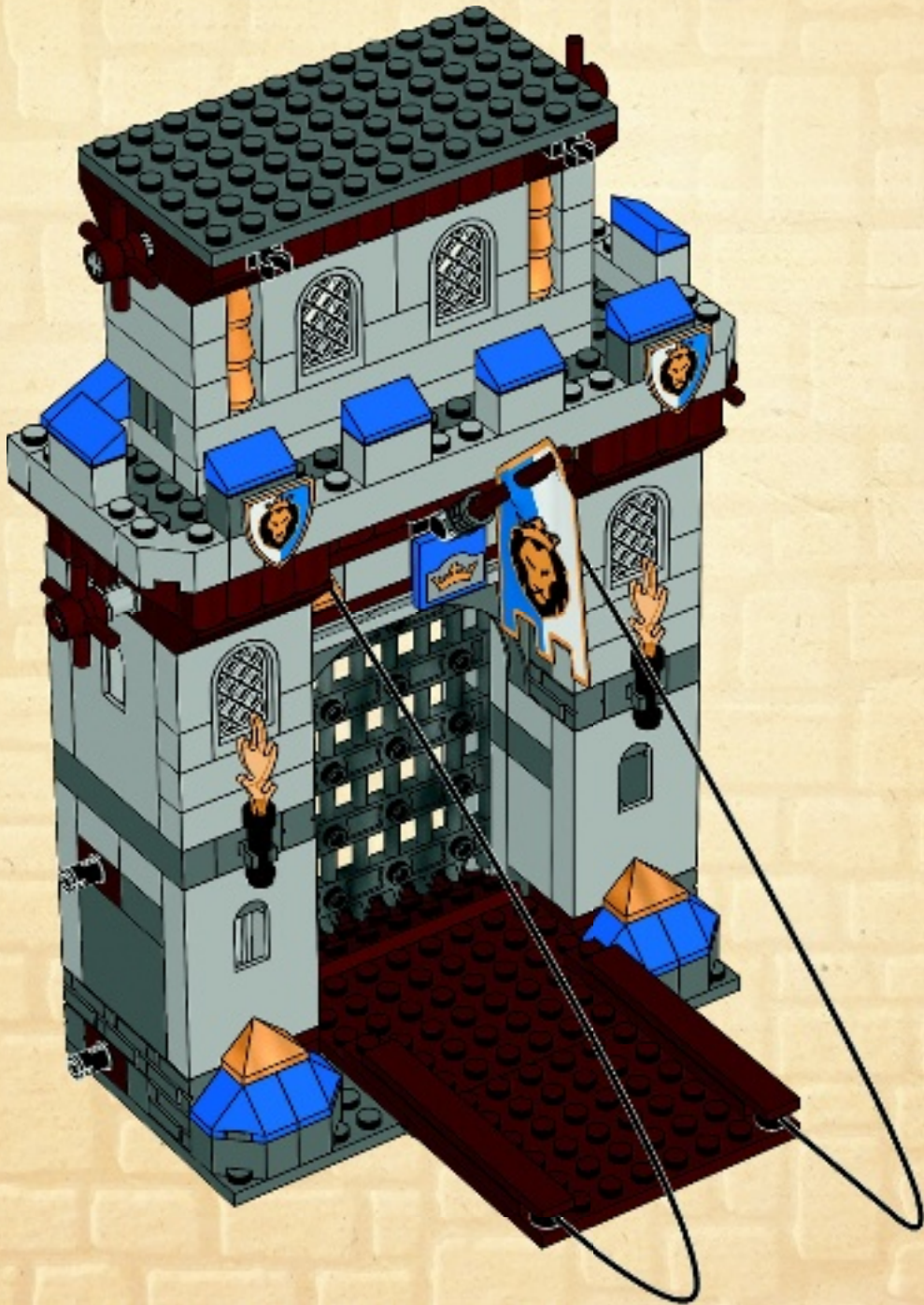



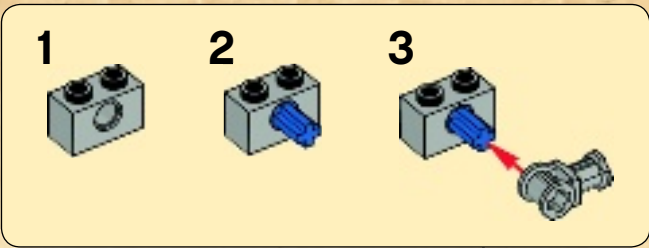
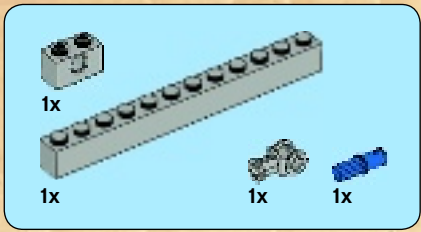

57

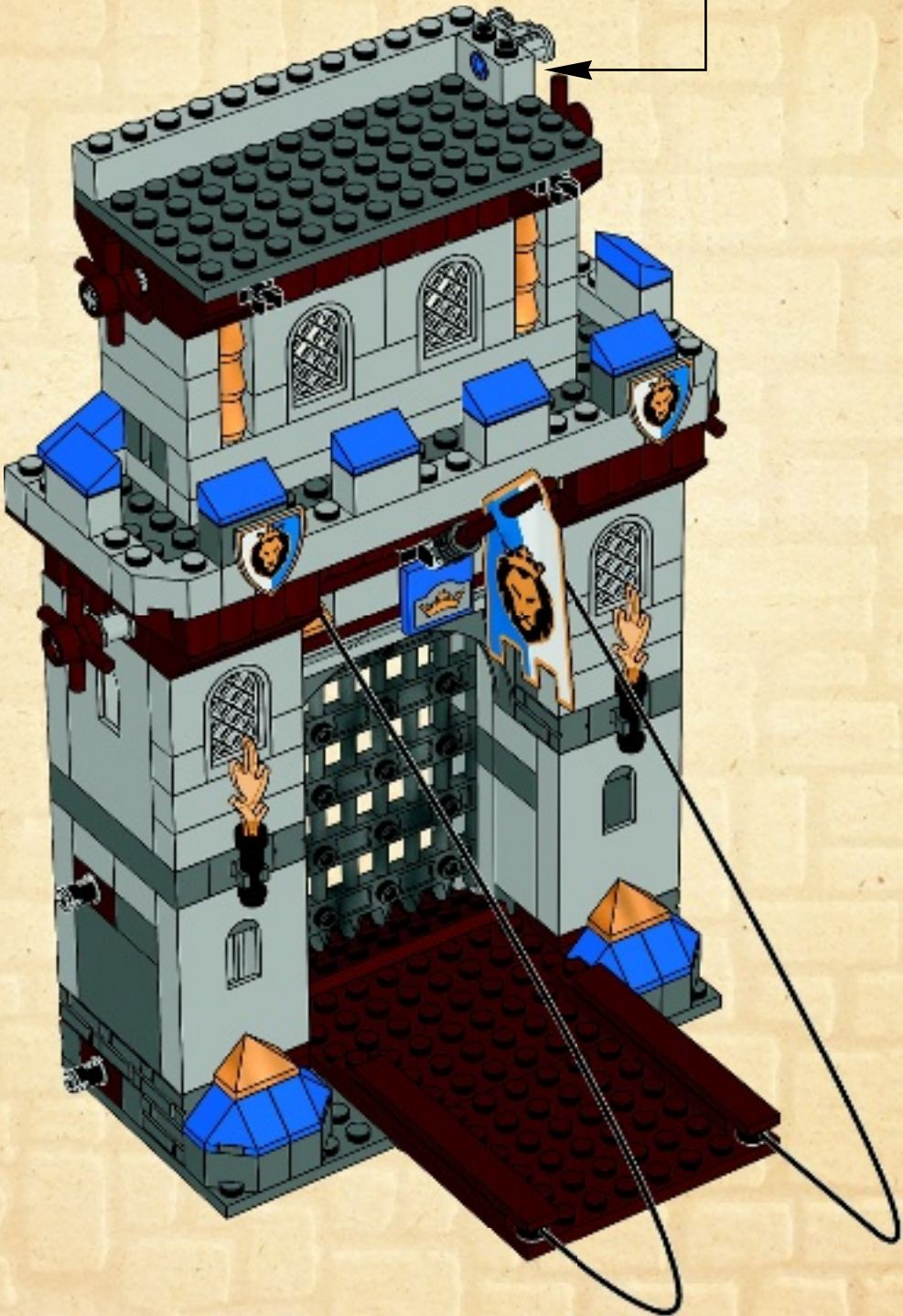



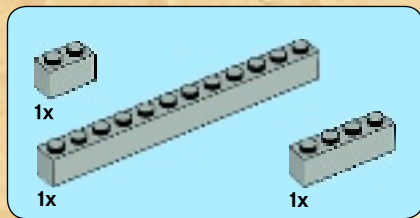

58

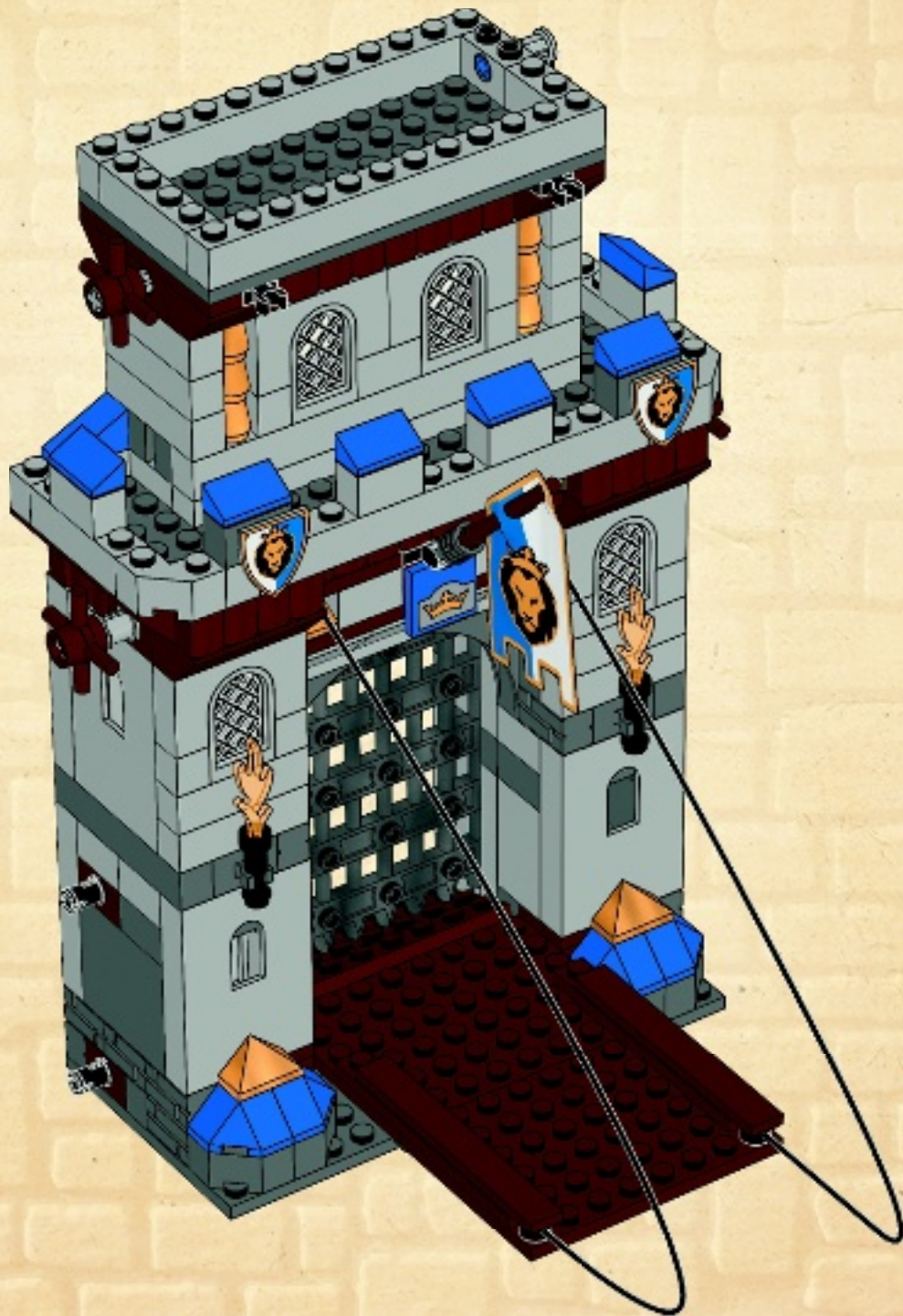



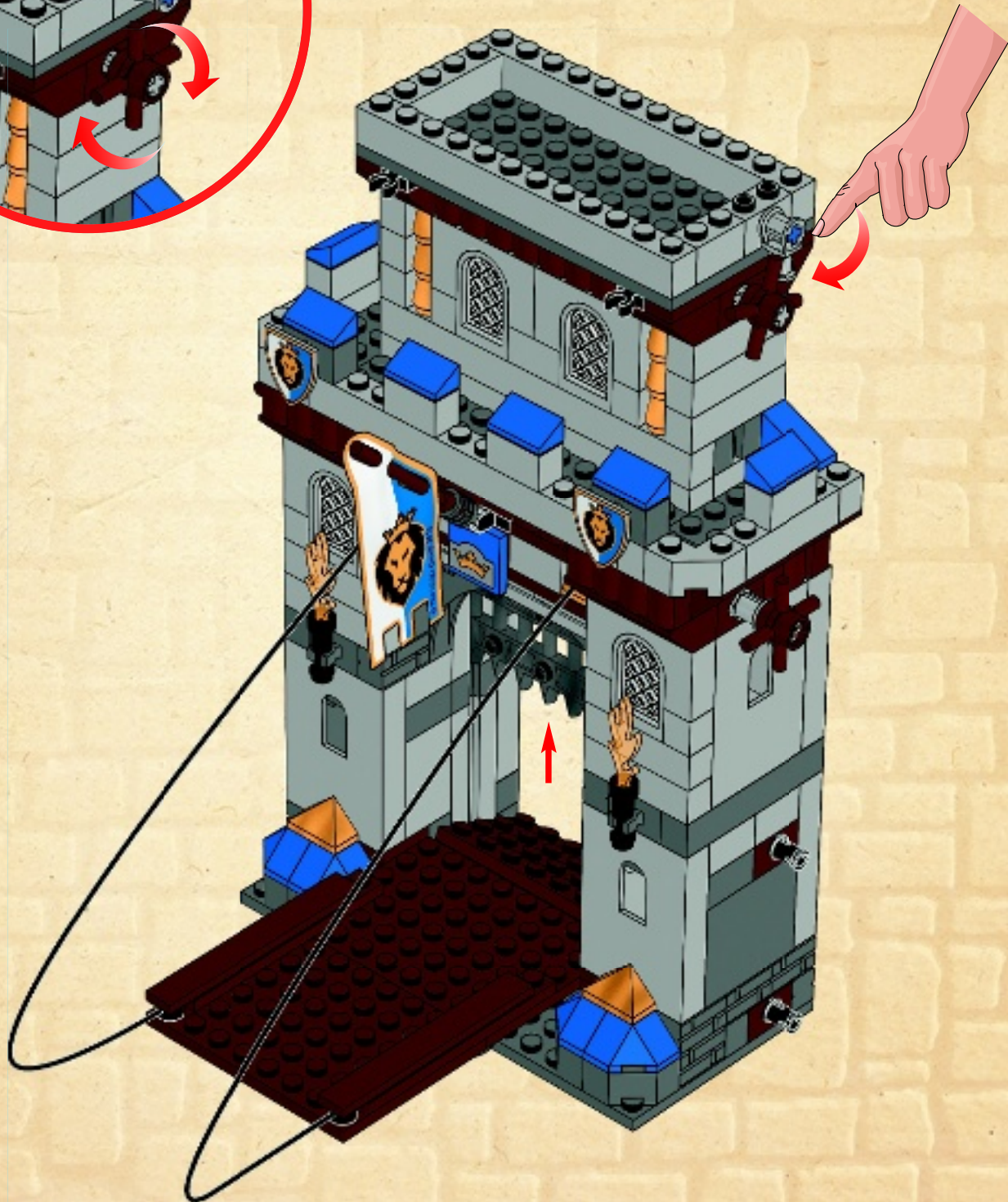
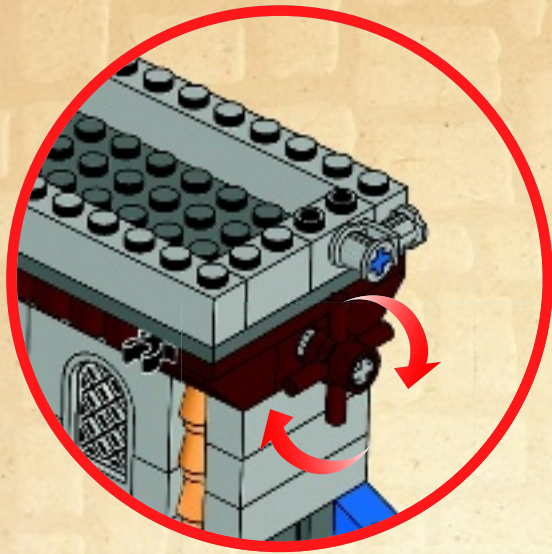





1x



6x

# 59

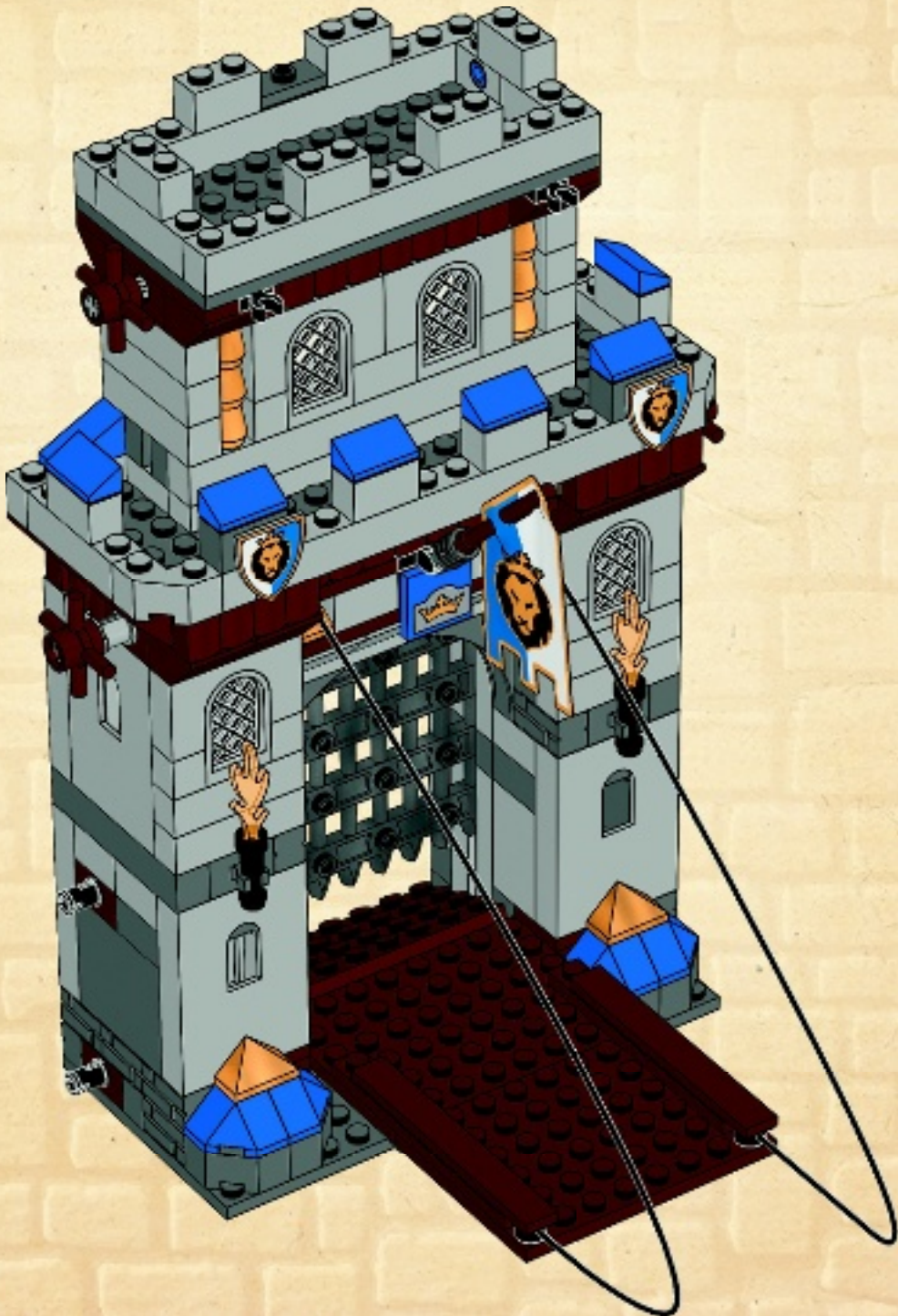



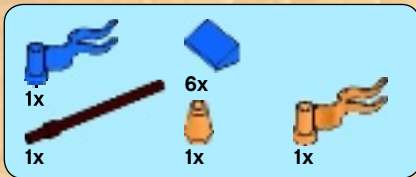

60

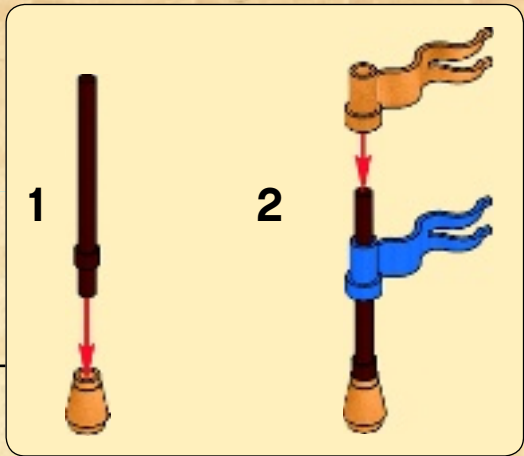
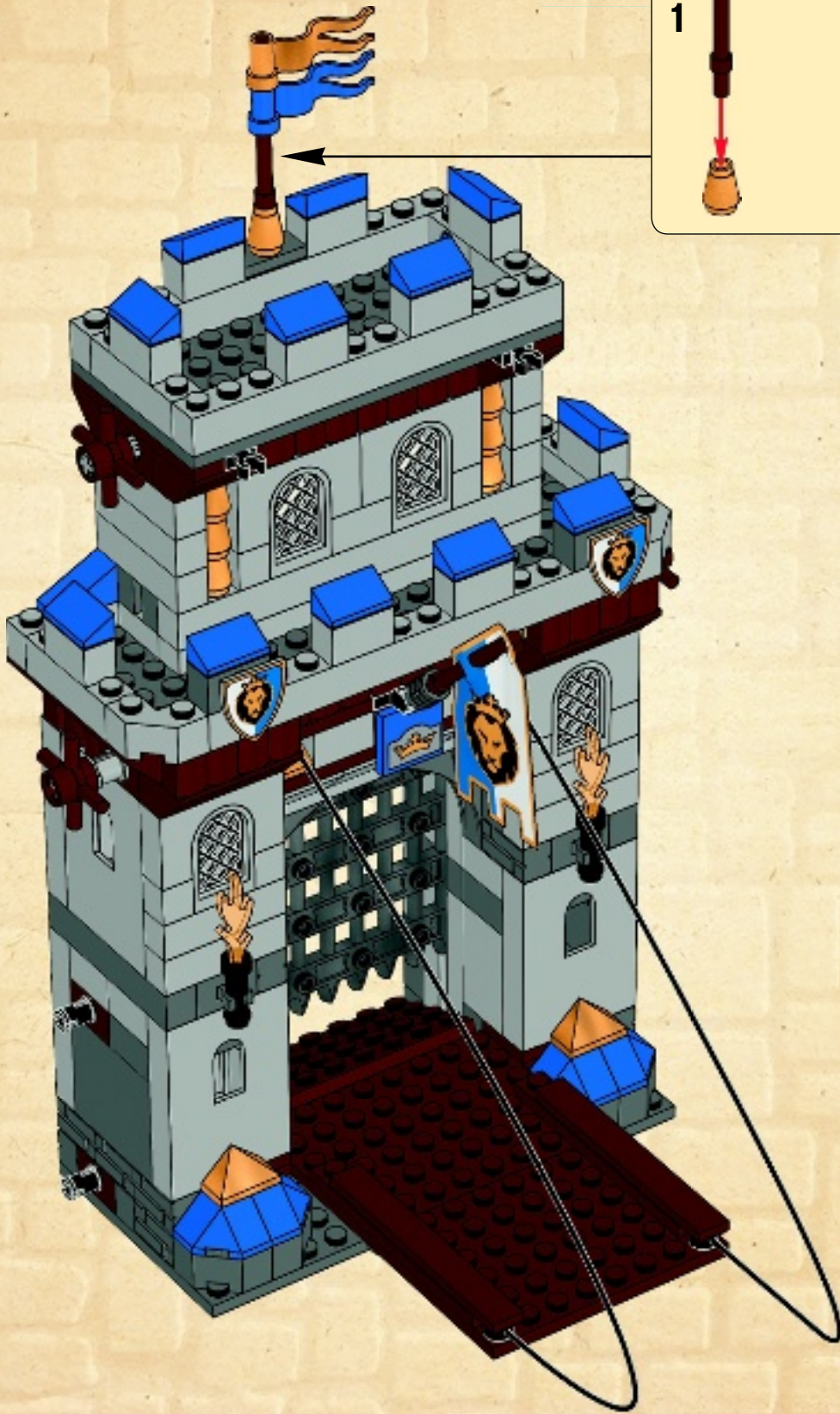



2x      2x

# 61

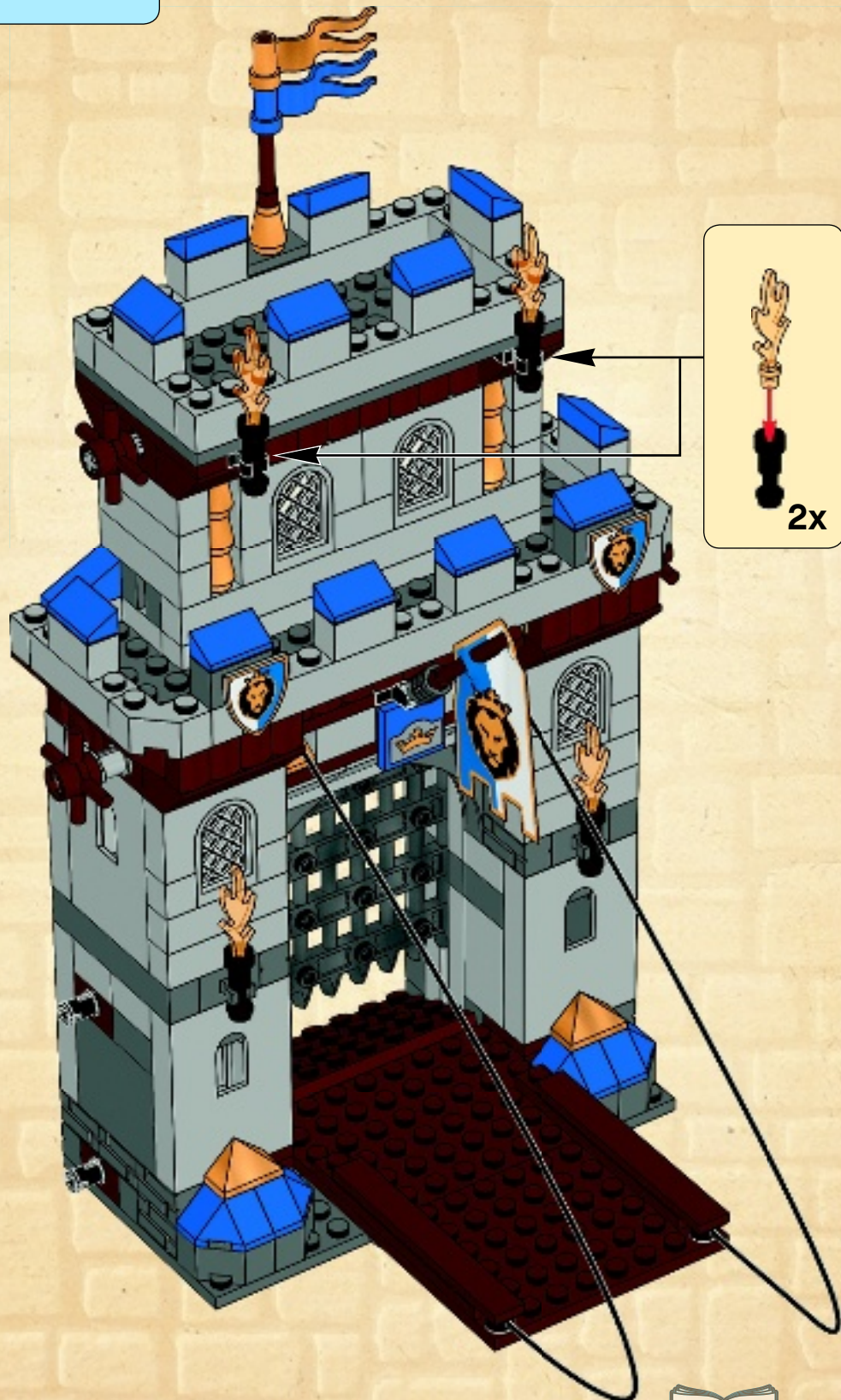

2x

1 → 2









[LEGO.com/castle](http://LEGO.com/castle)





# Castle



70404







1



2







3

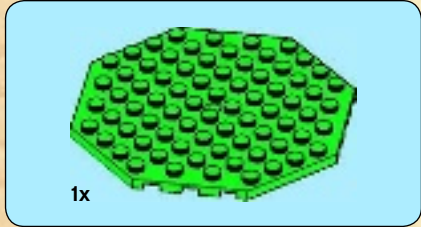
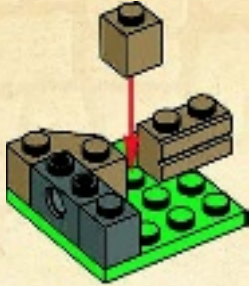

4

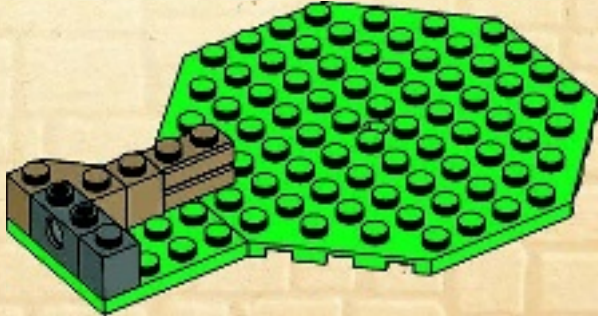





5

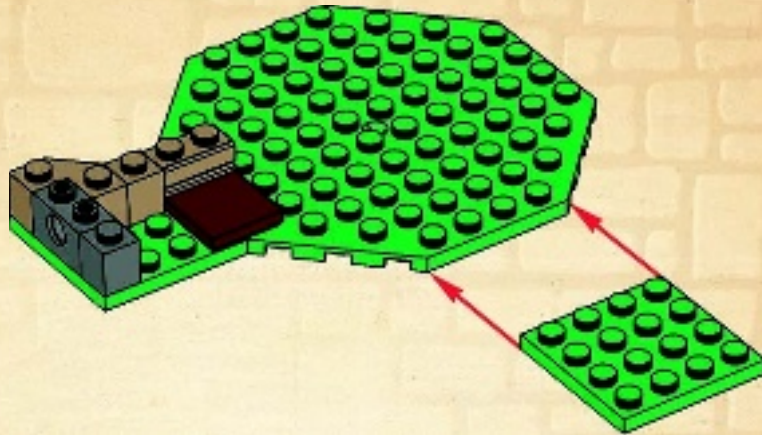

6







1x



1x

7

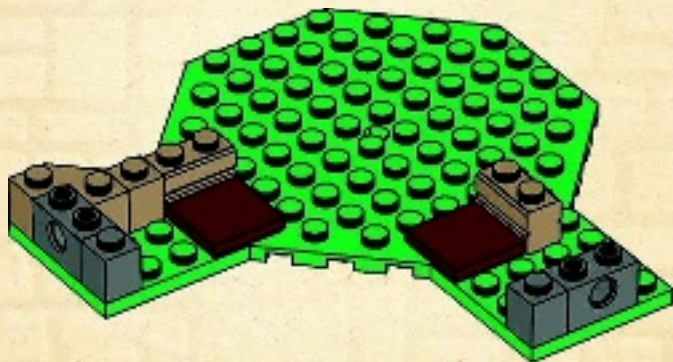





1x



1x

8

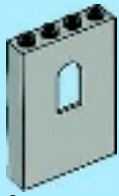

2x

9

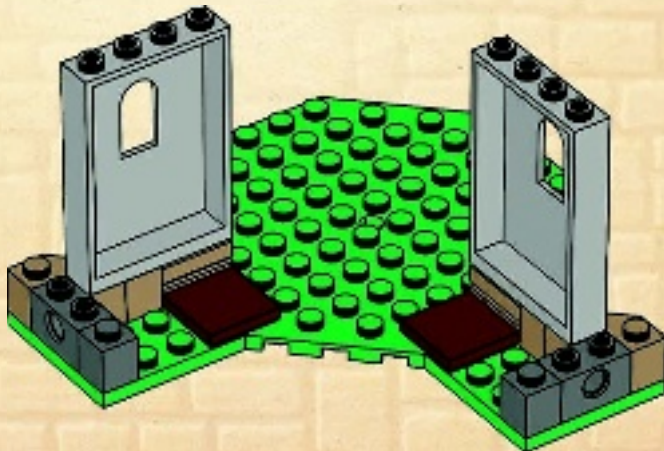





10

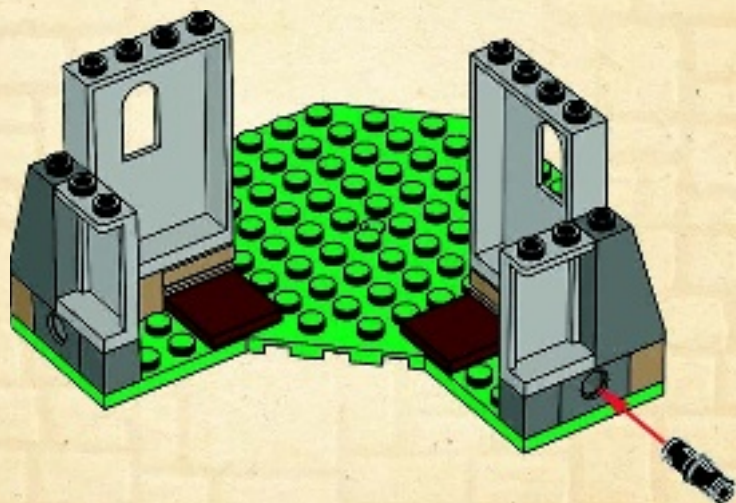





2x

11

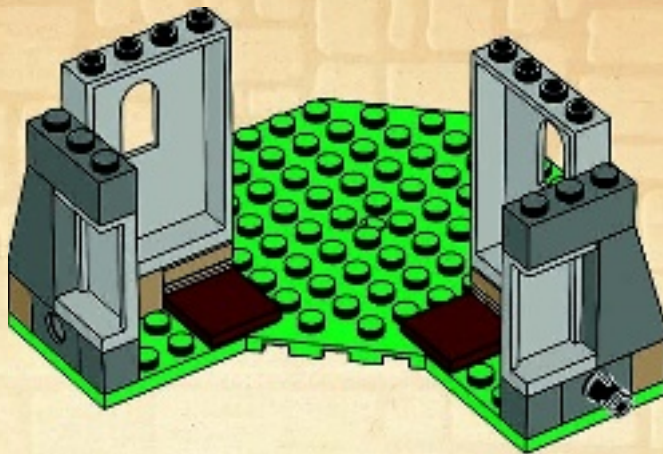

2x



2x

12

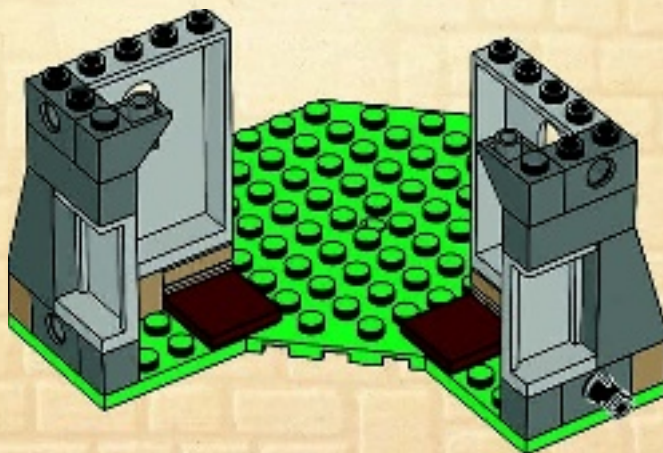





13

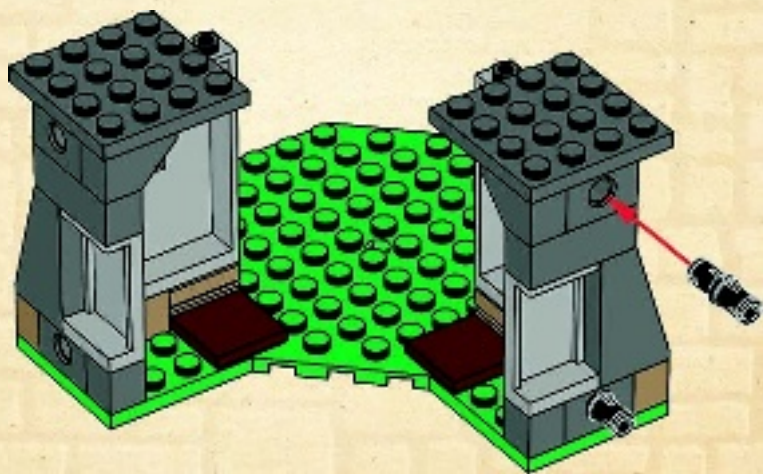



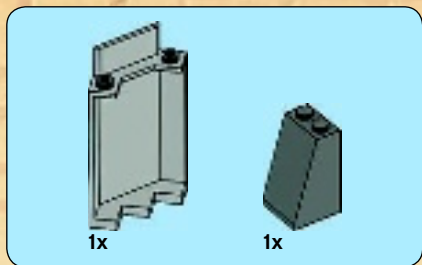

14

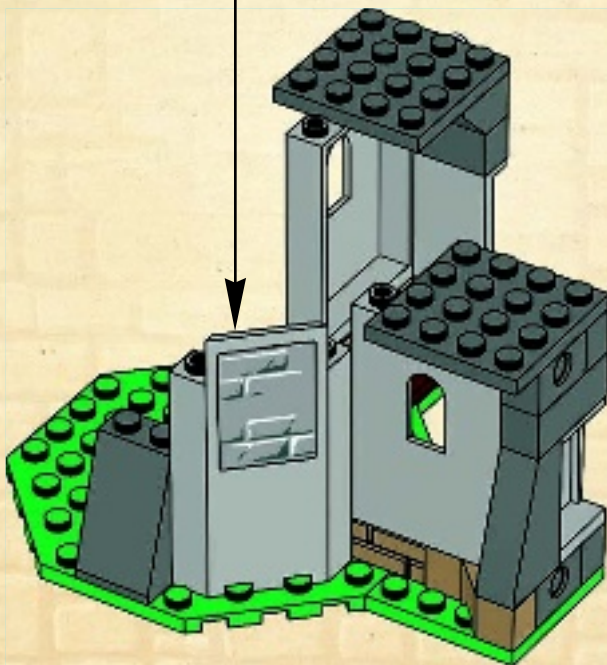
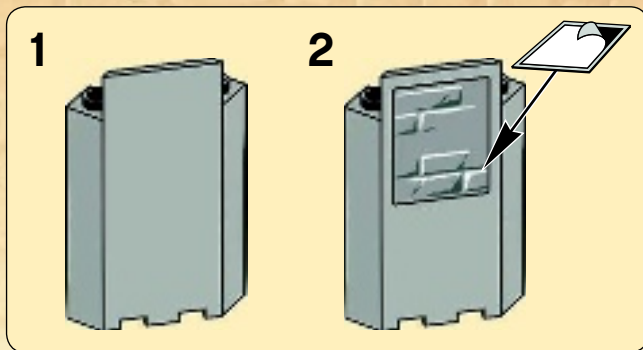
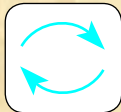



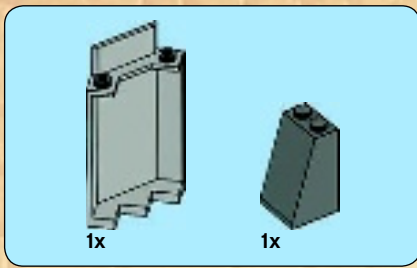

15

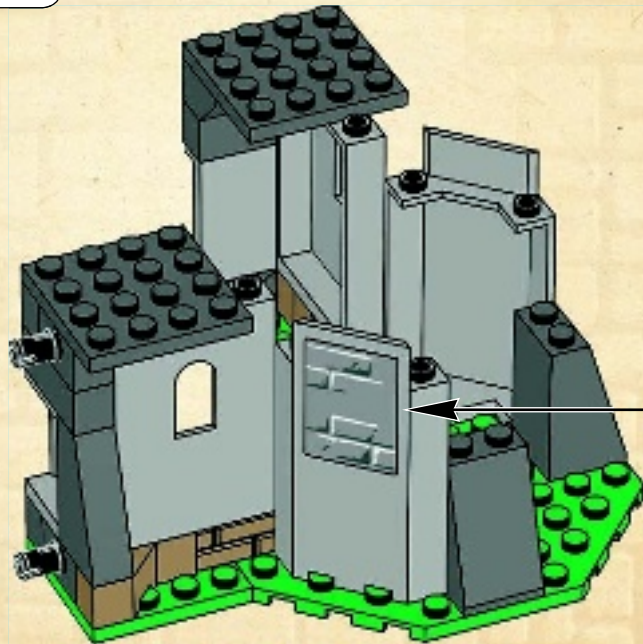
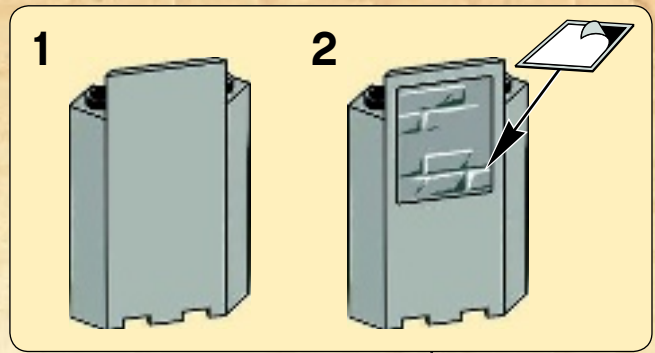



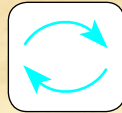
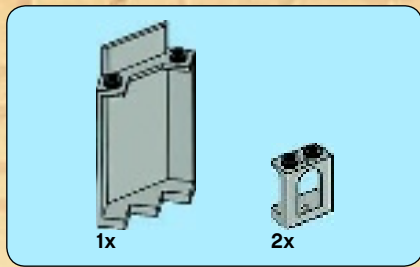

16

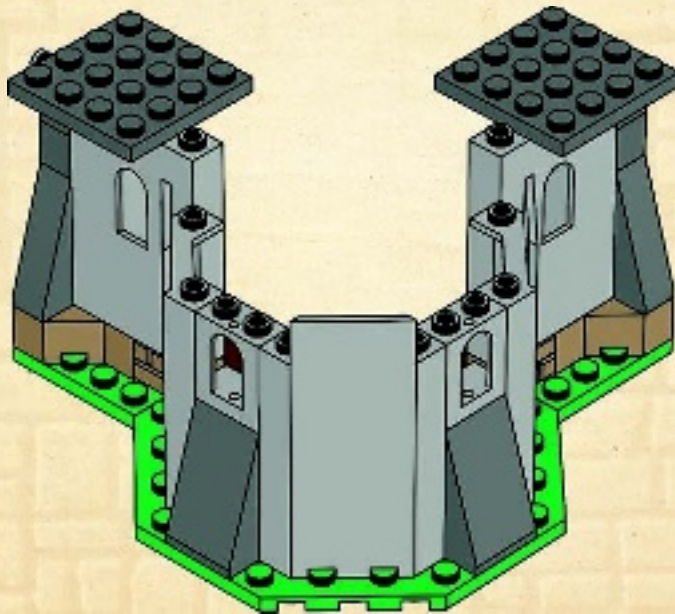





2x



2x

17

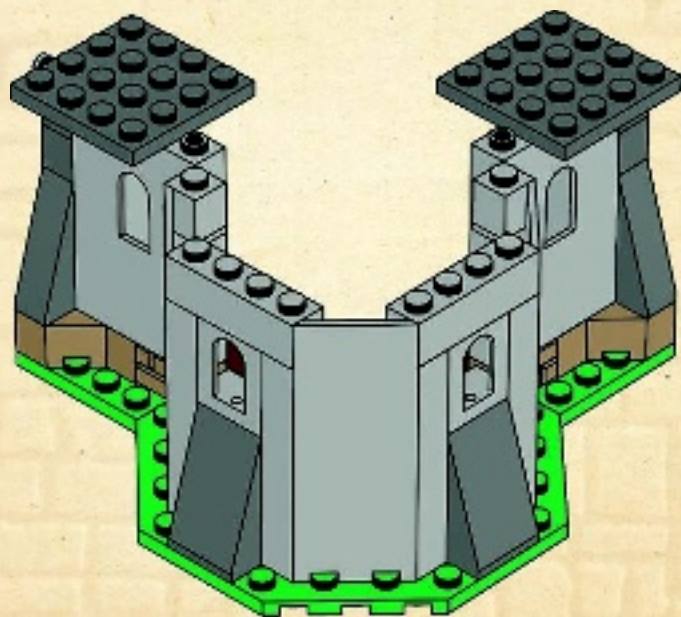





18

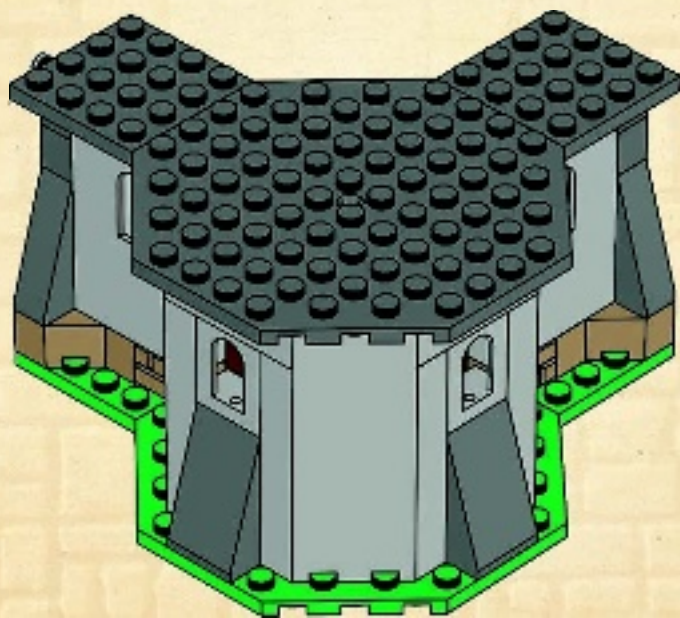



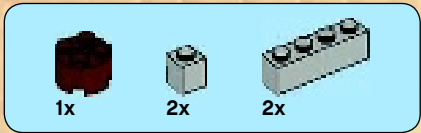

19

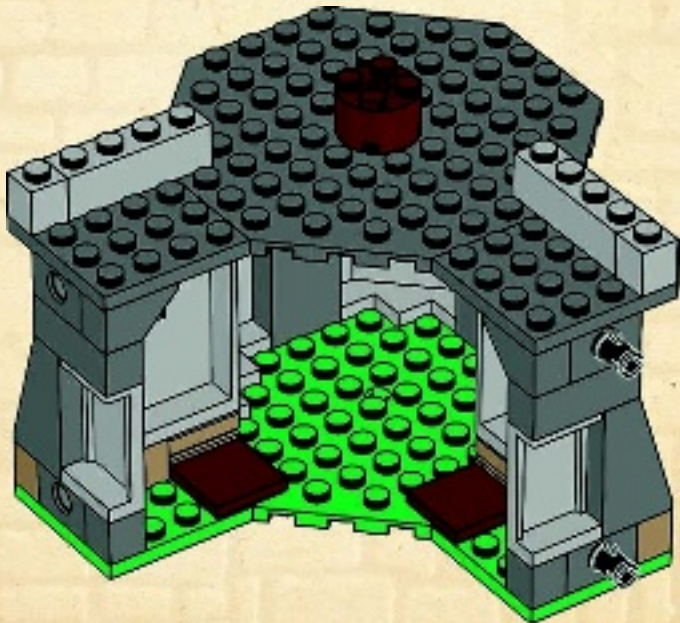





2x



1x

20

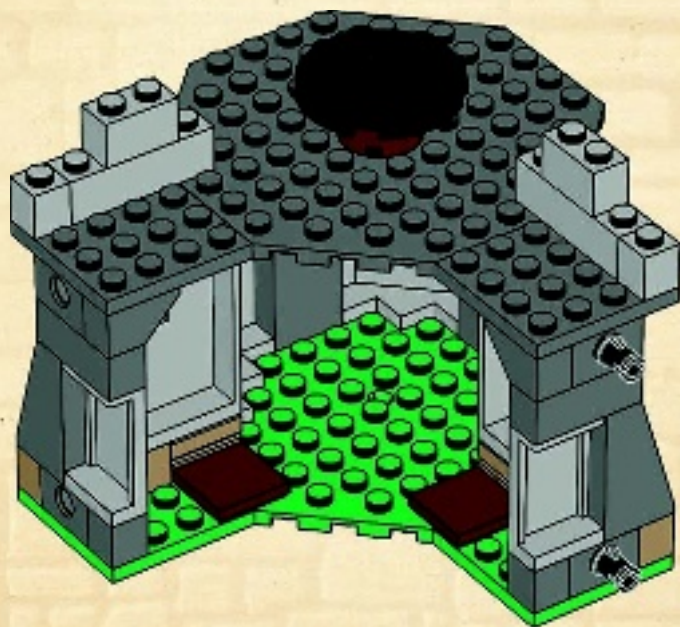





21

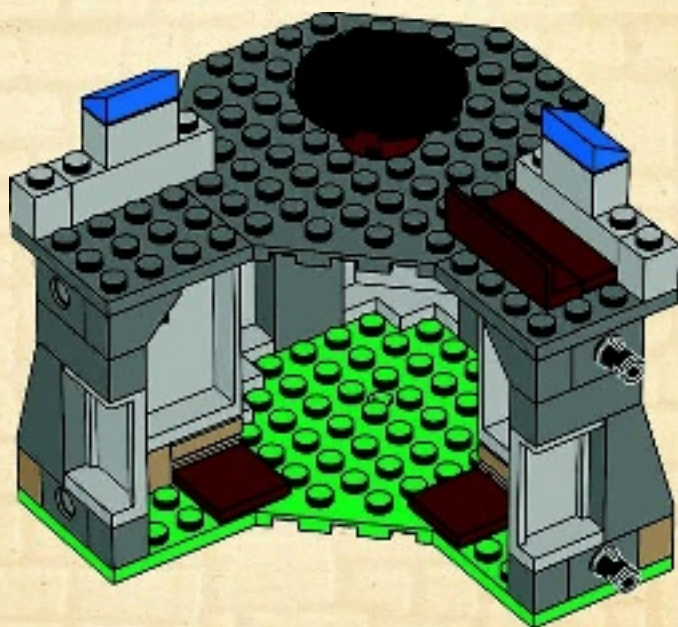



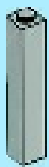

2x

22

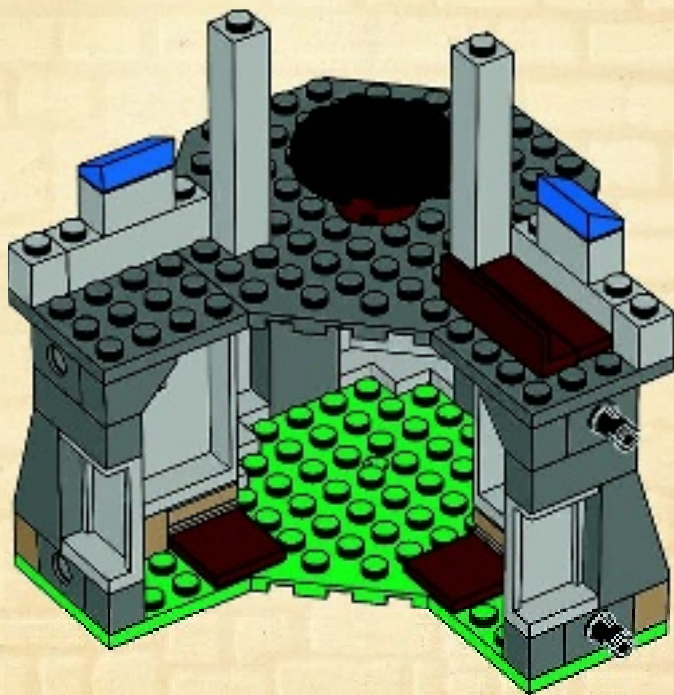



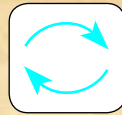
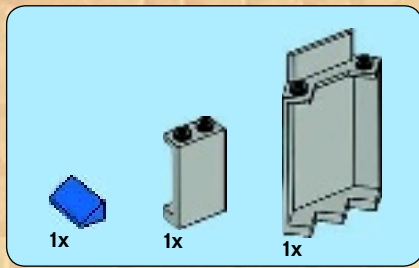

23

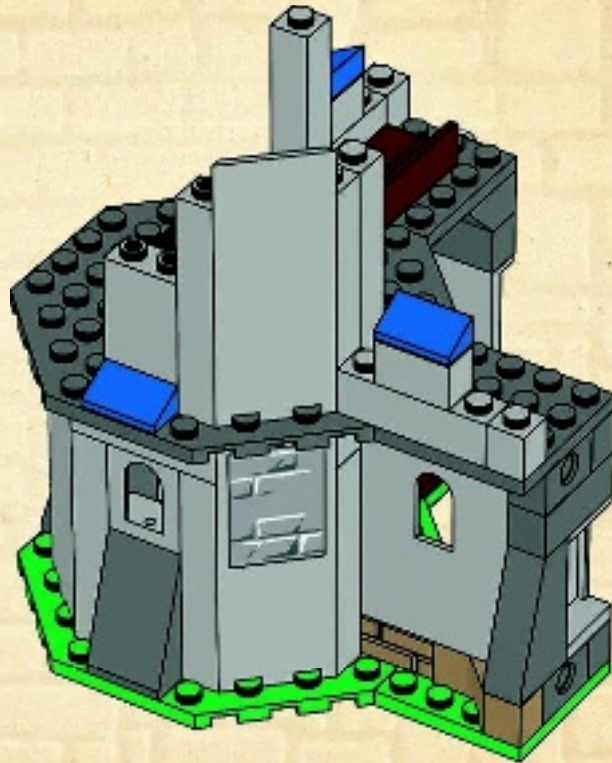



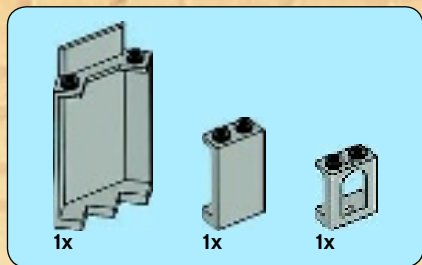

24

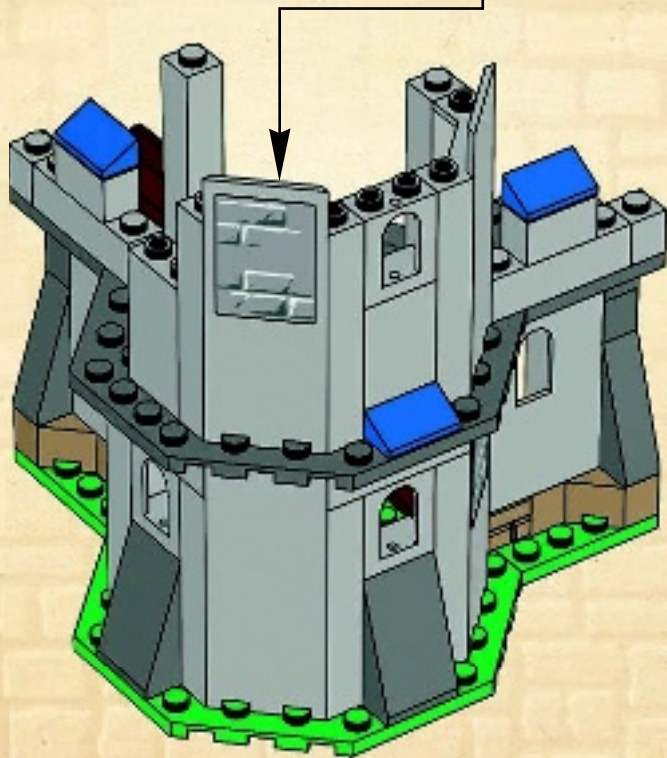
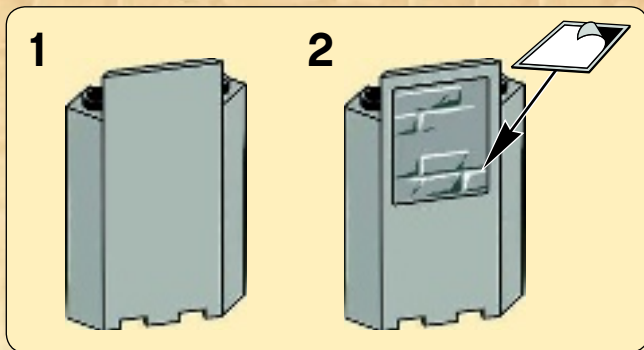



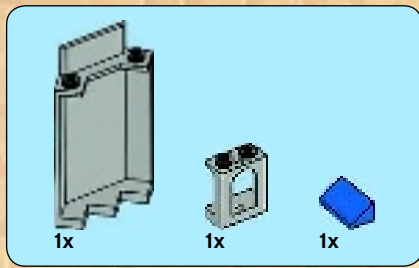

25

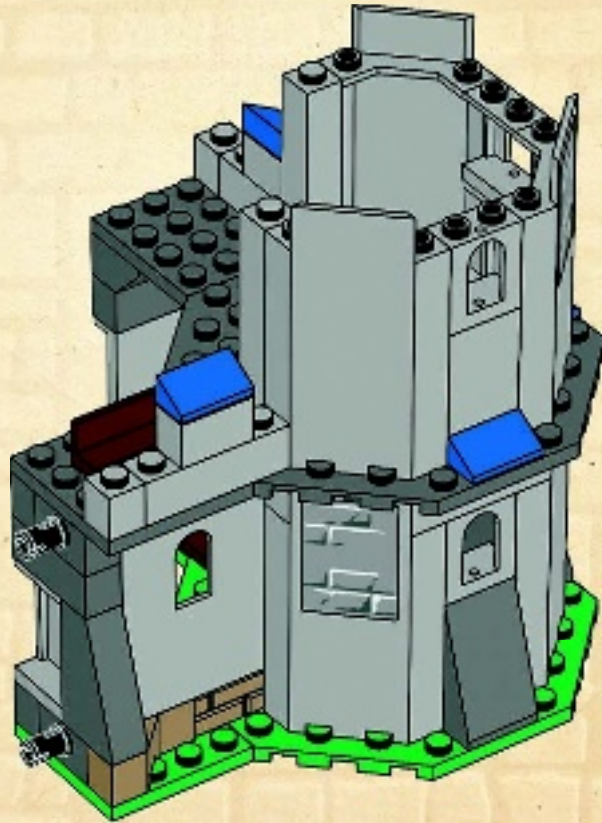
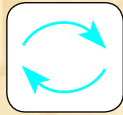





6x

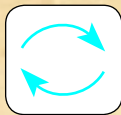

26

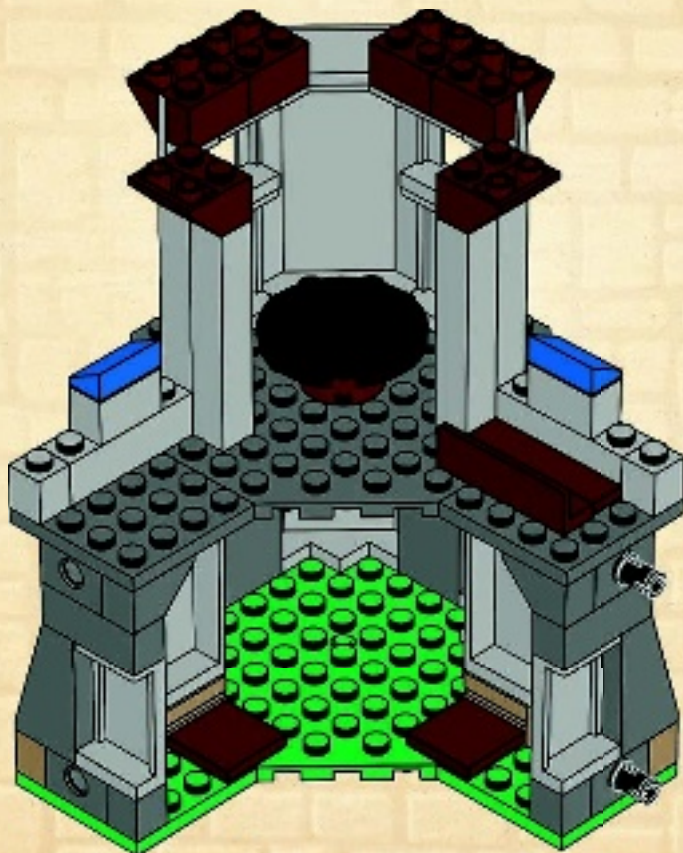



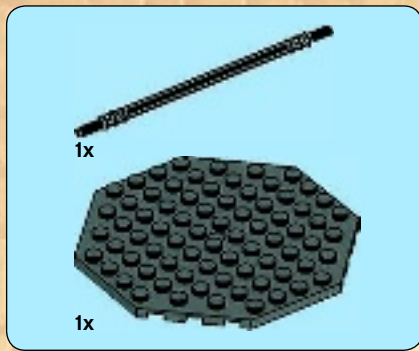

27

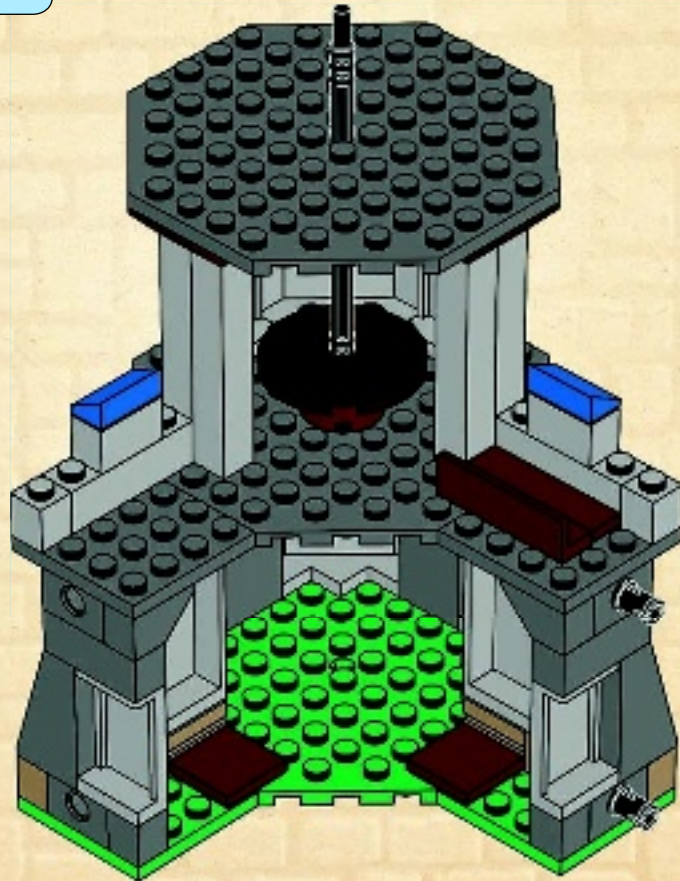



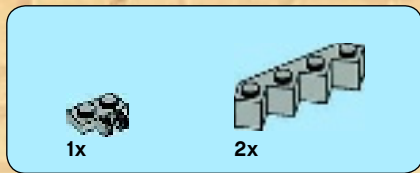

28

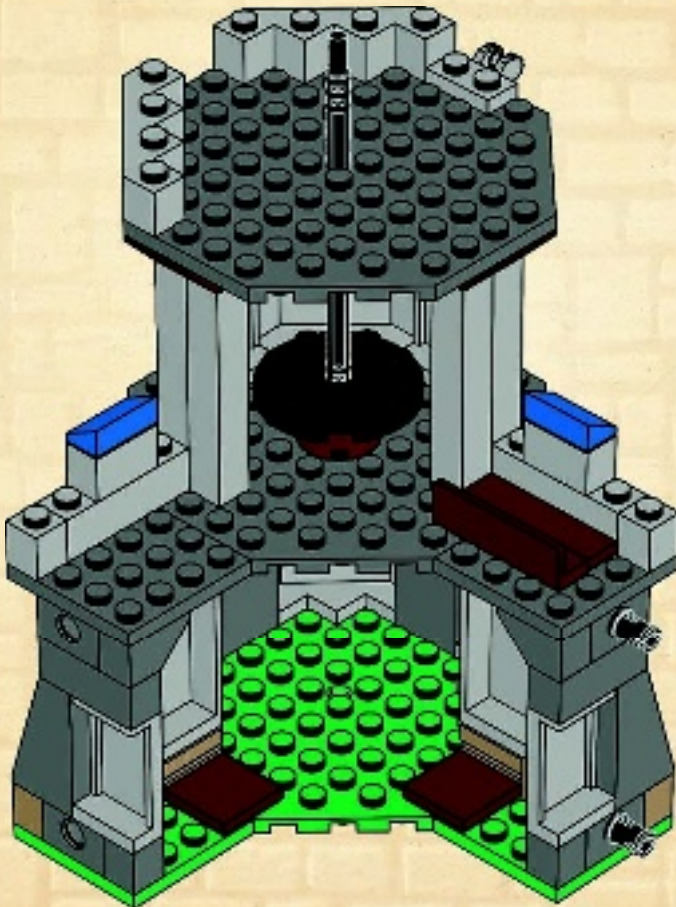





1x



2x



2x

29

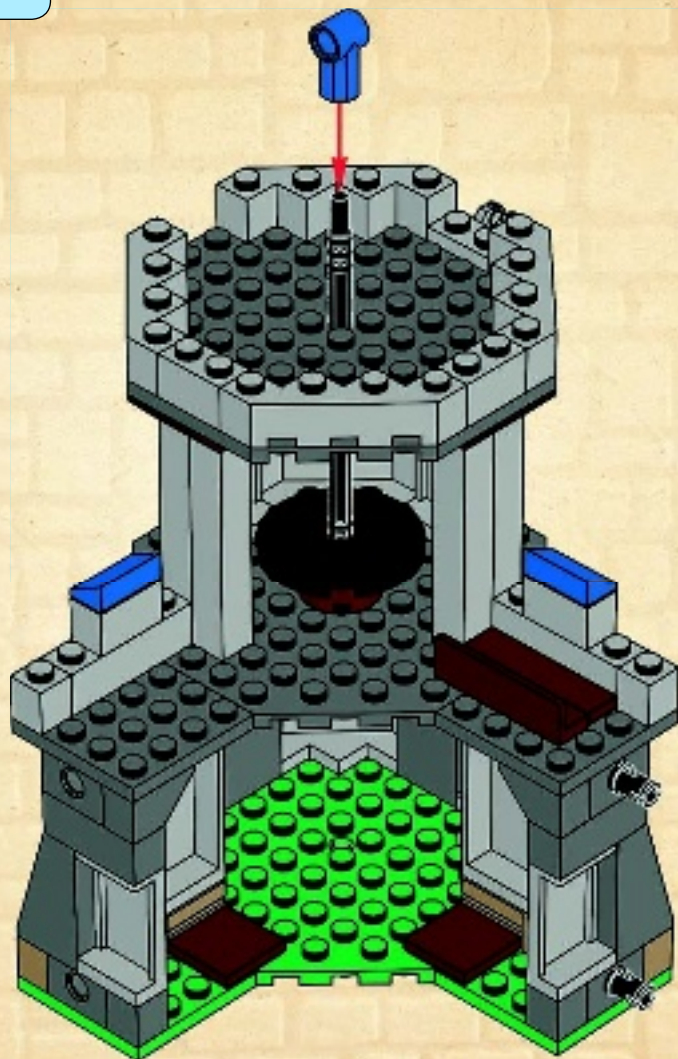



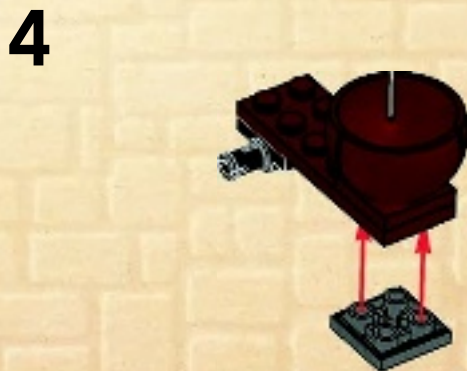
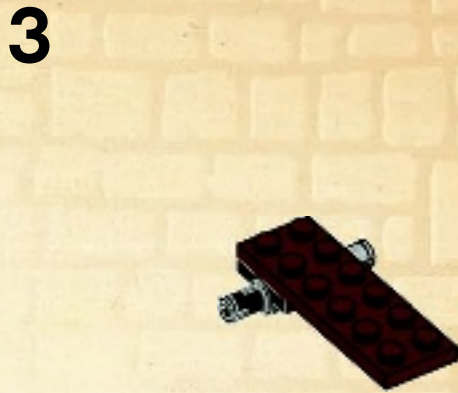
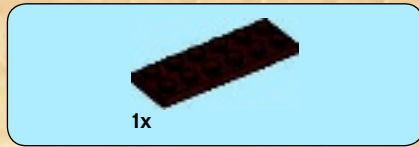
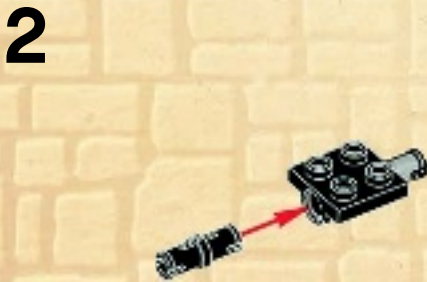





5

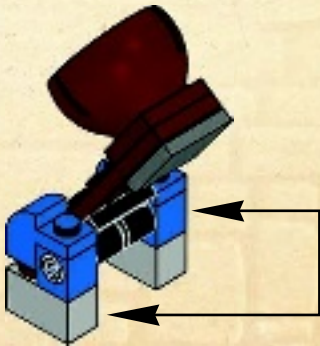
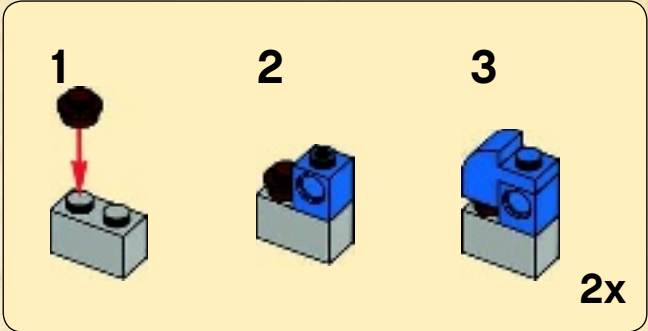





30

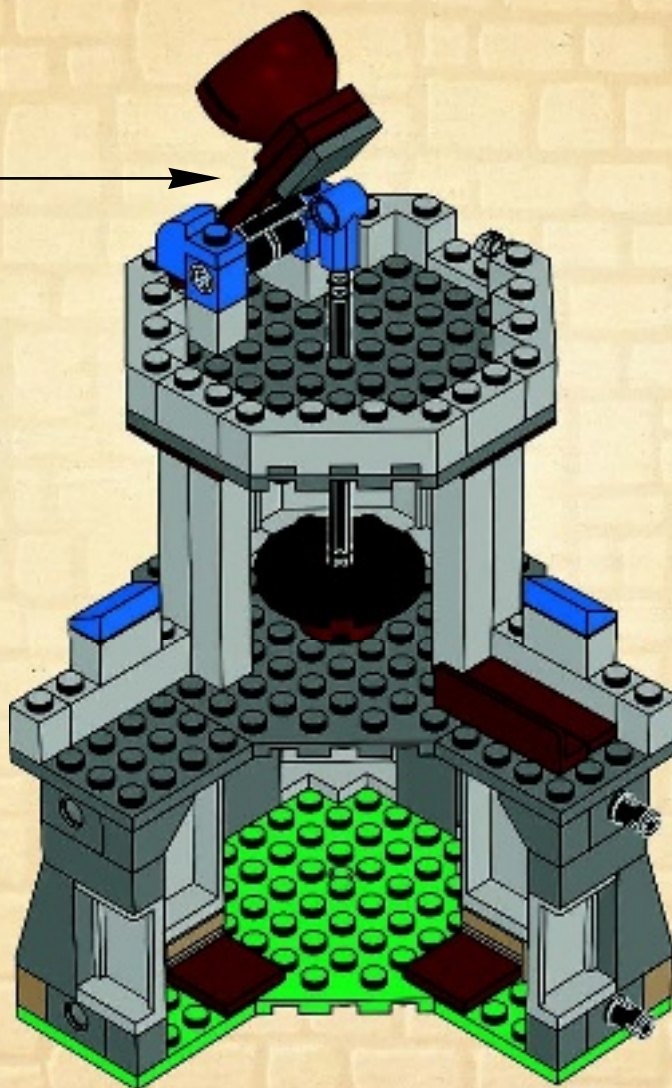





3x

31

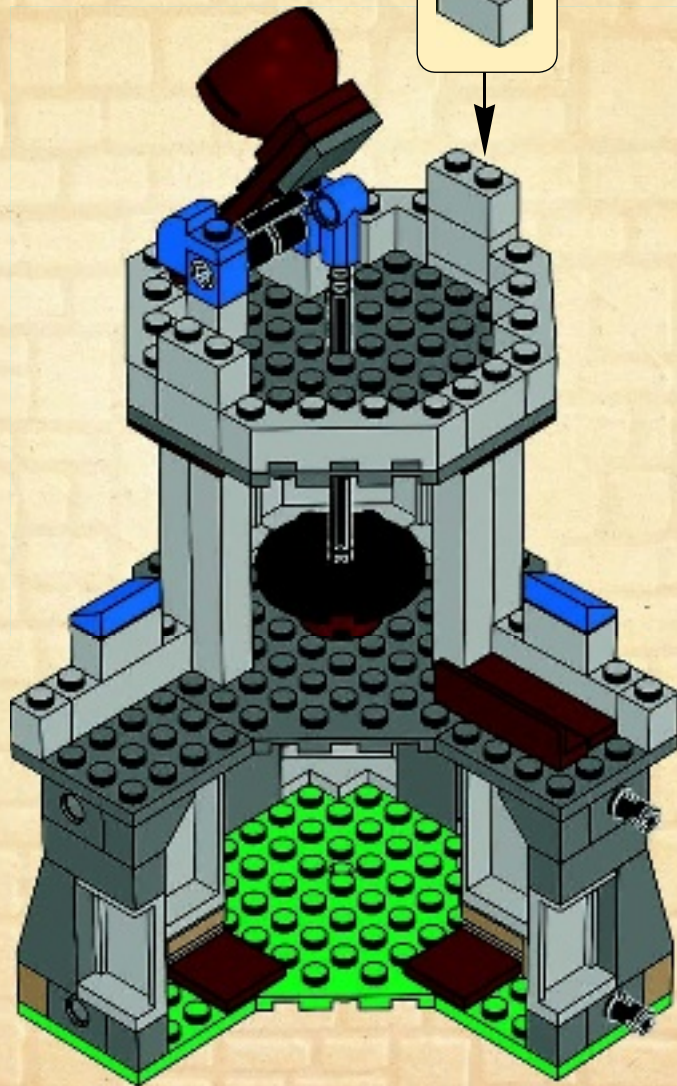
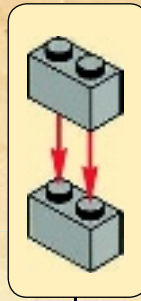



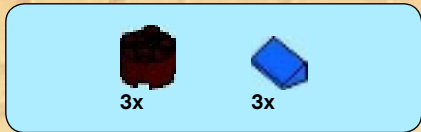

32

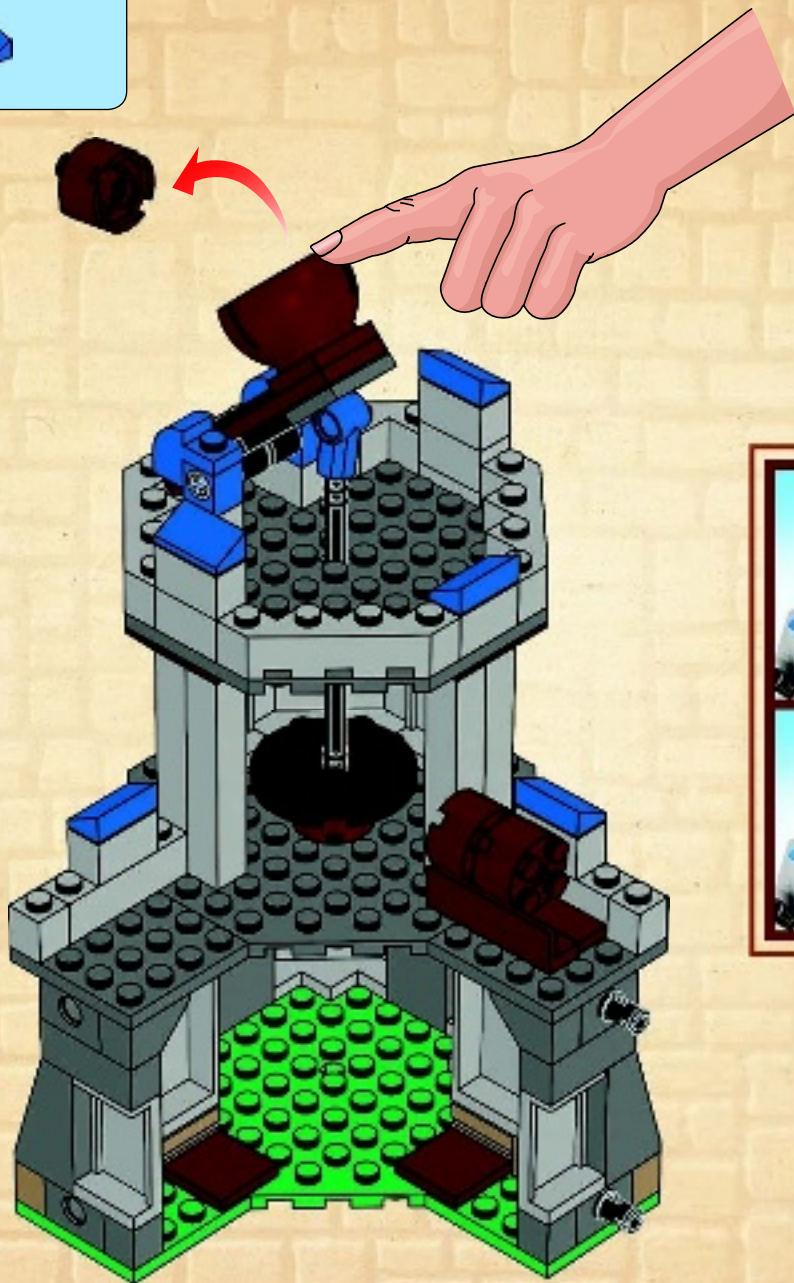





33

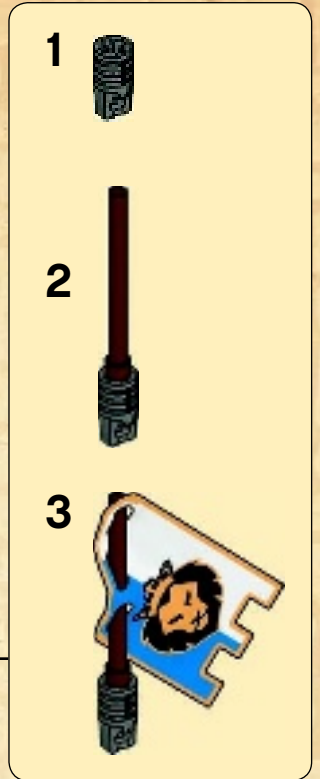
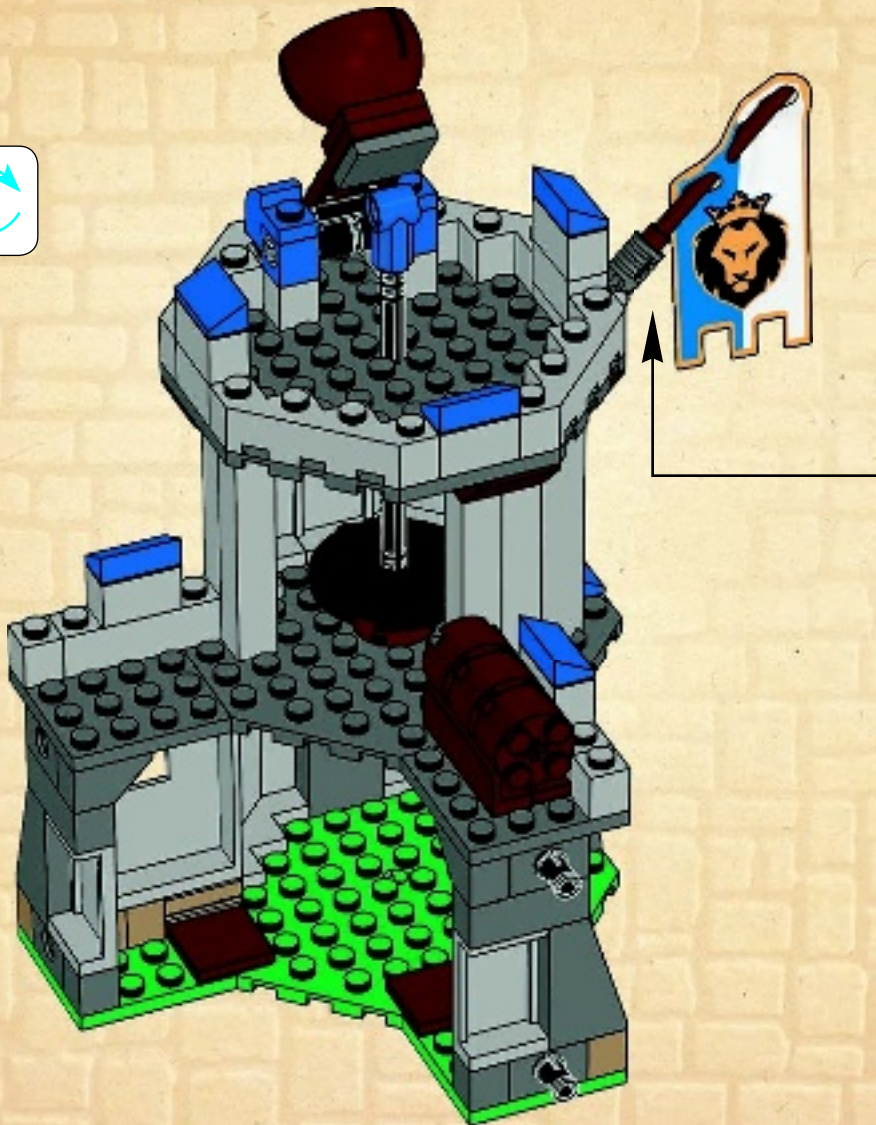



34

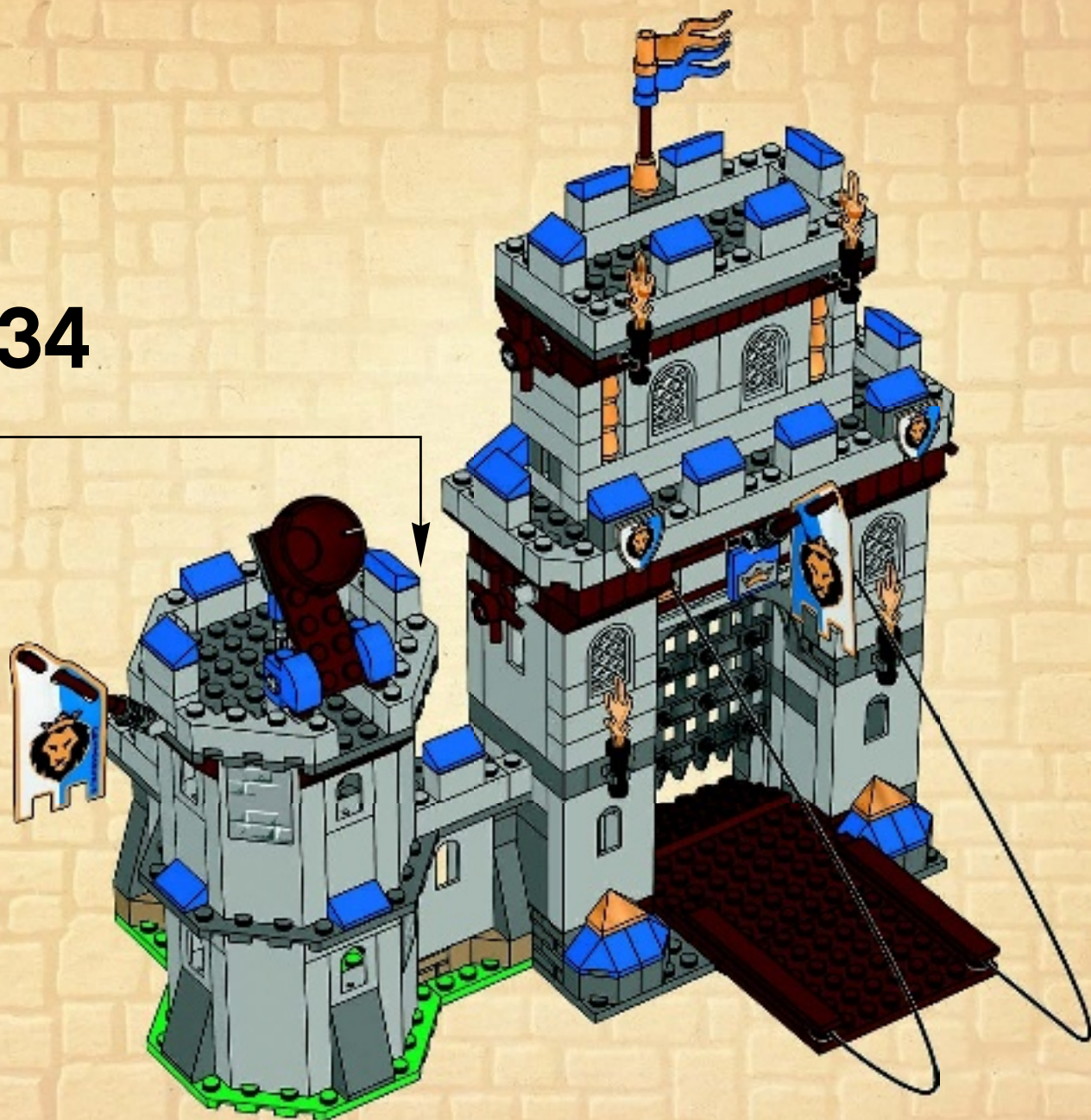





6



1x



1x

1



2x

2



1x



2x

3







2x

4



1x

5





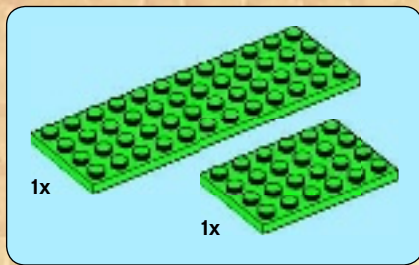

6

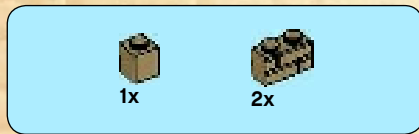
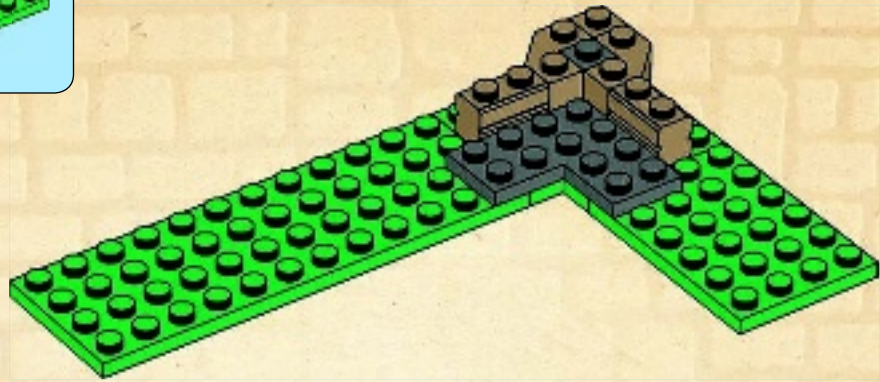

7

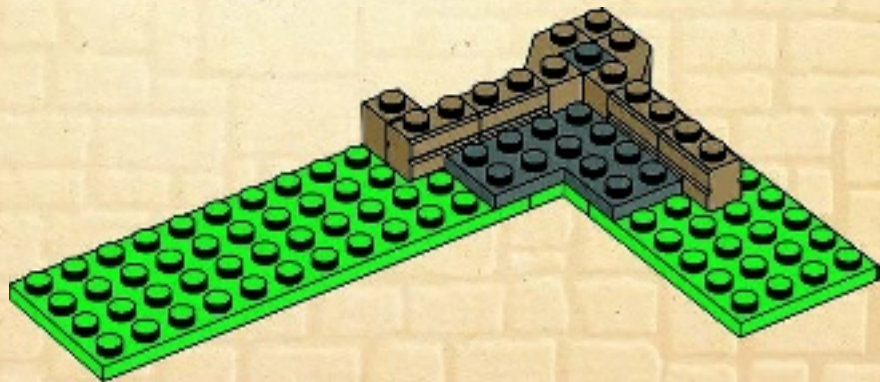





1x



5x

8

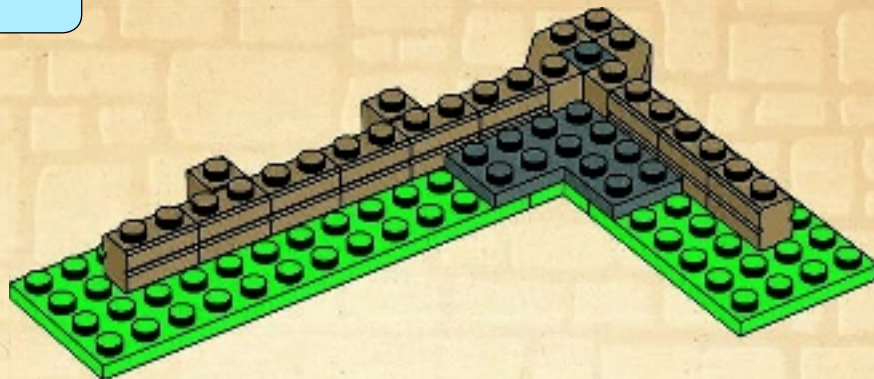

1x



2x



2x



2x

9

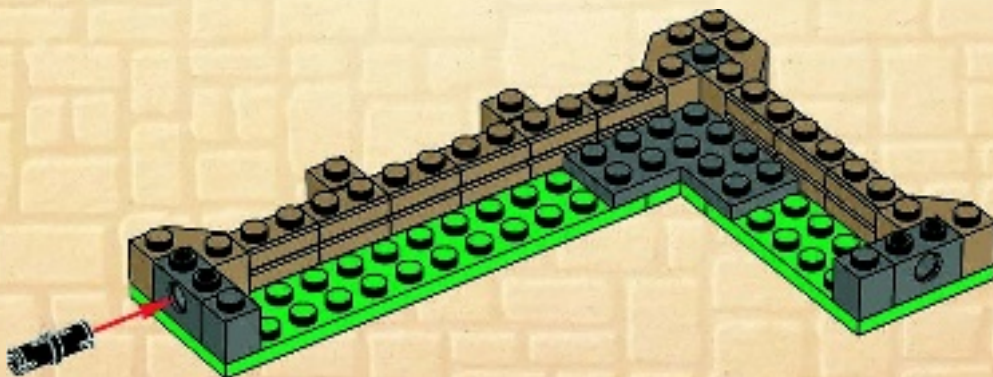





10

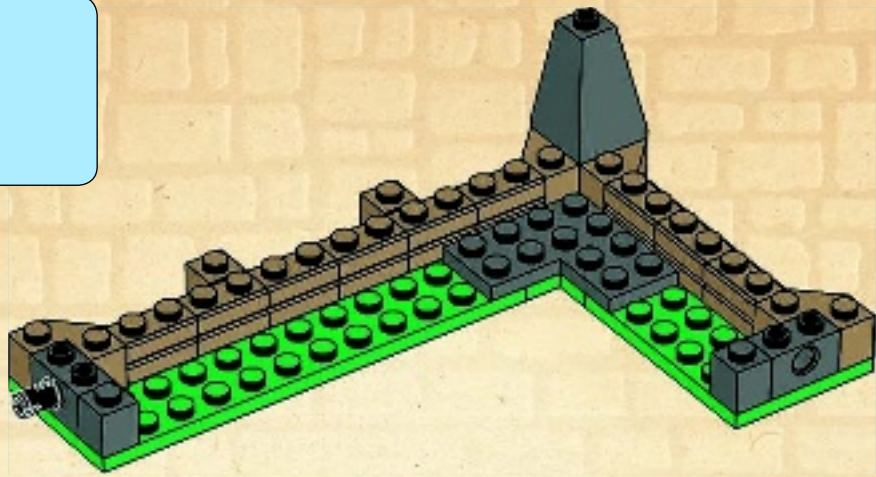

11

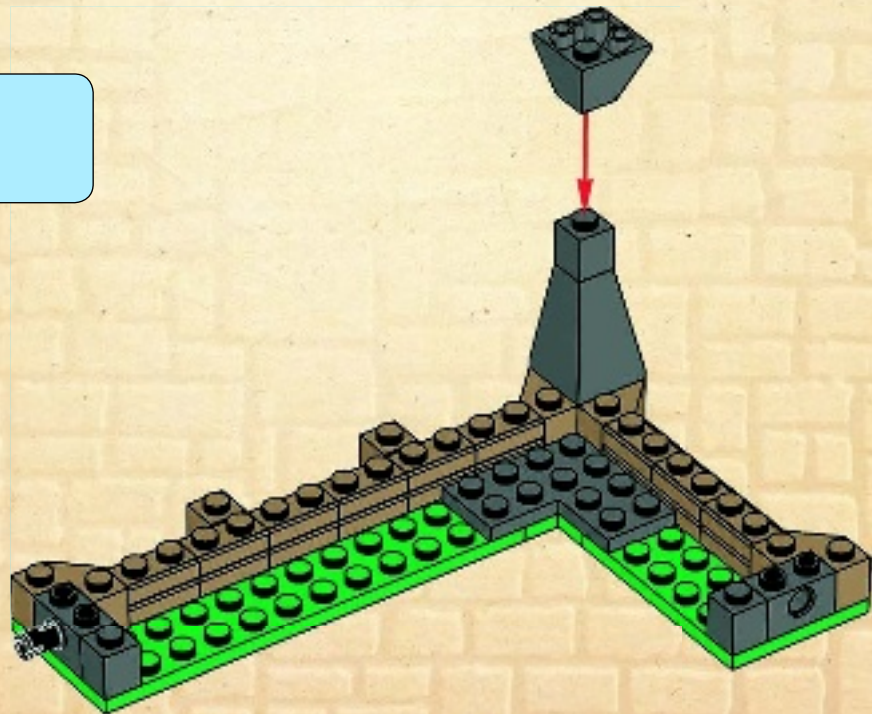



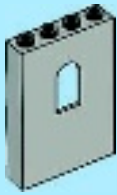

3x

12

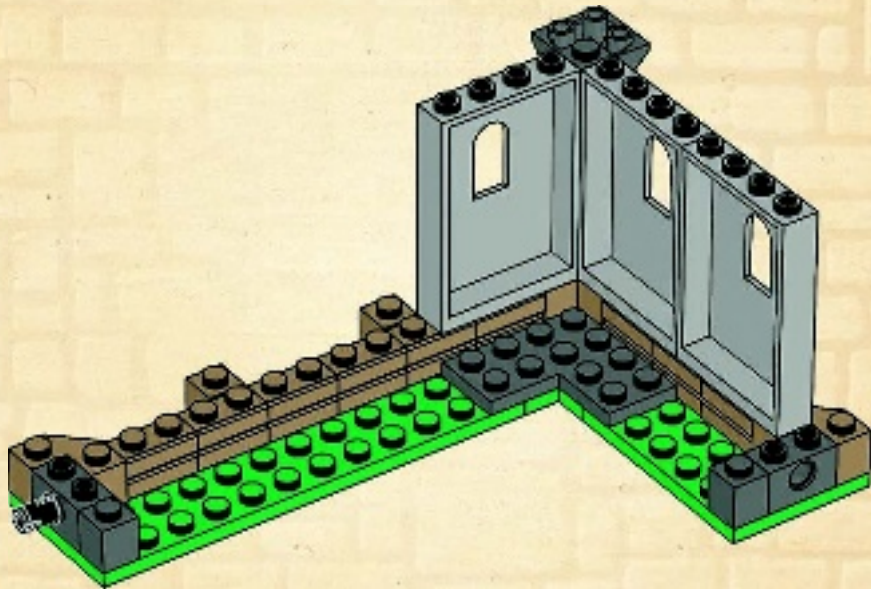



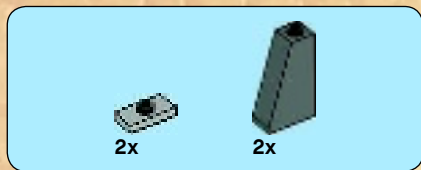

13

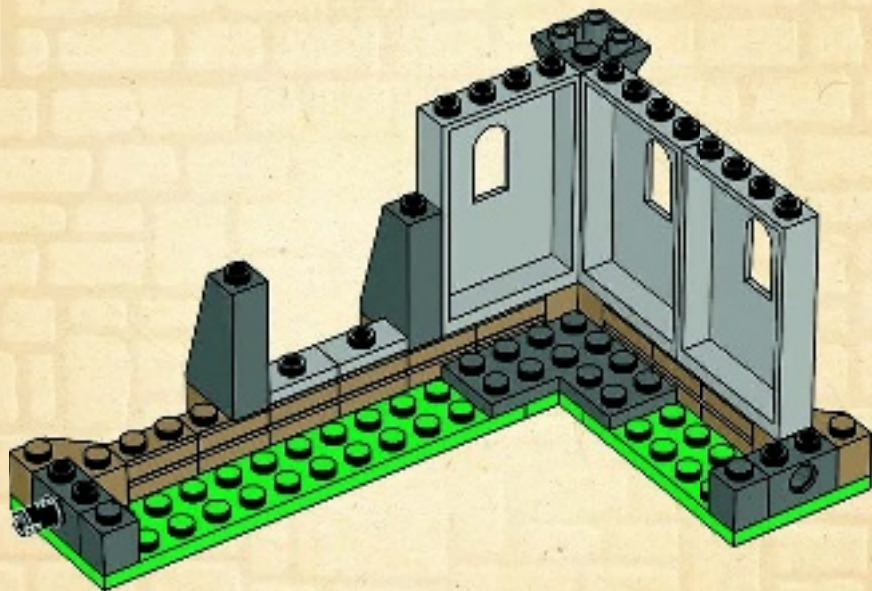





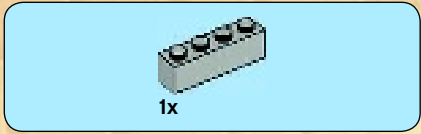
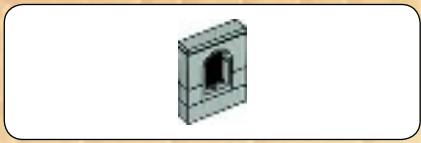

1

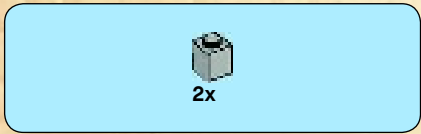
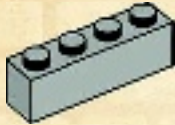

2

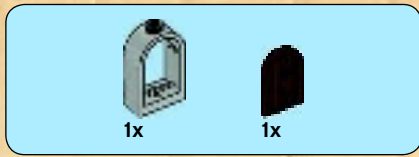
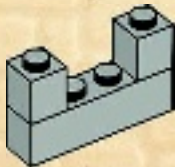

3

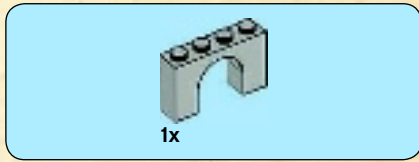
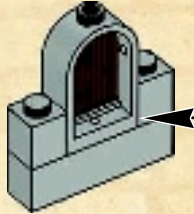

4







1x

5



15

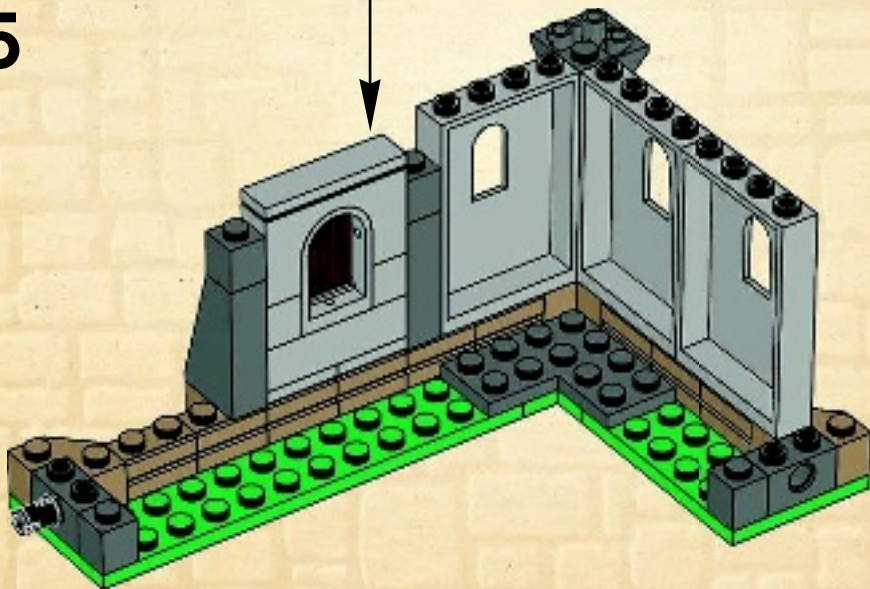

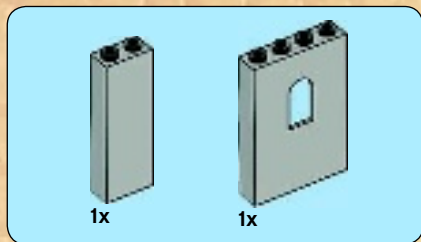

16

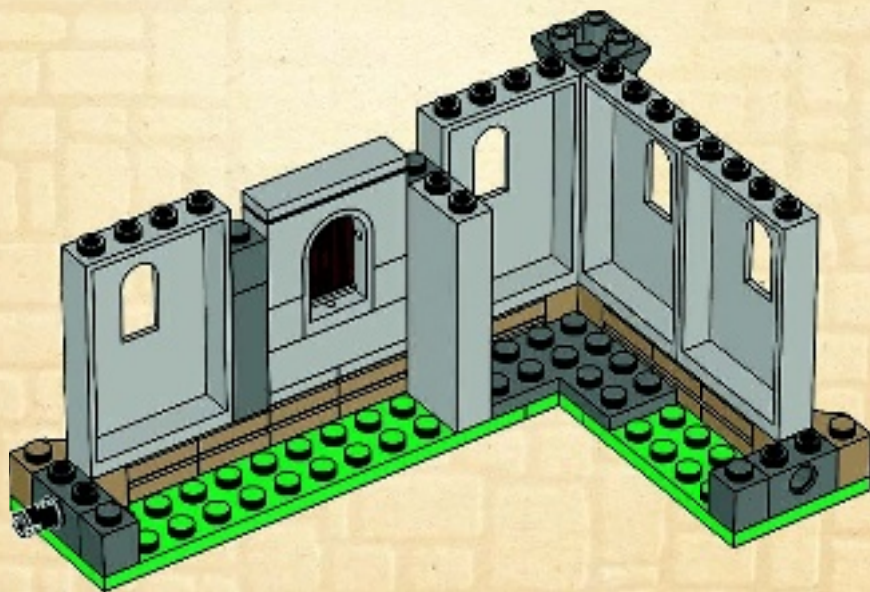





1x



1x



1x

17

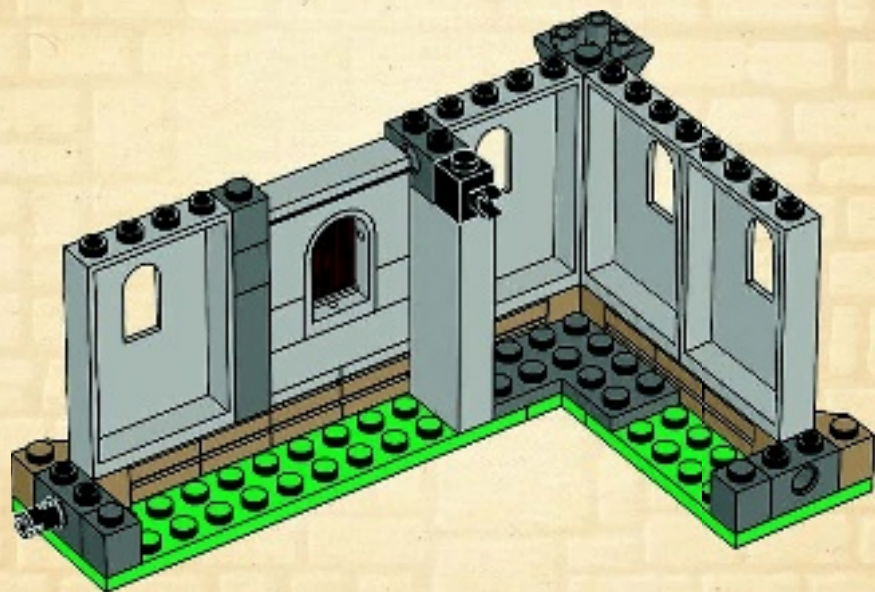



2x



2x

18

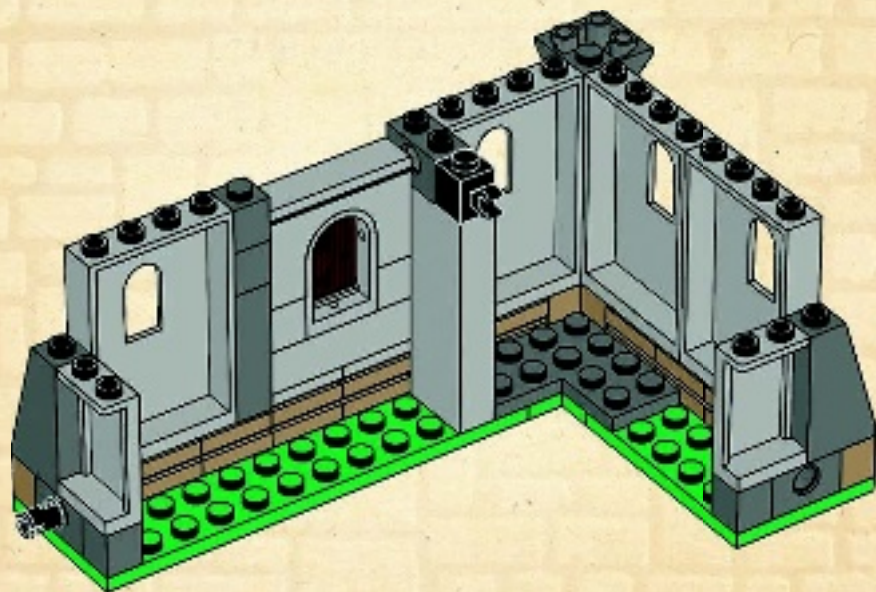





2x

19

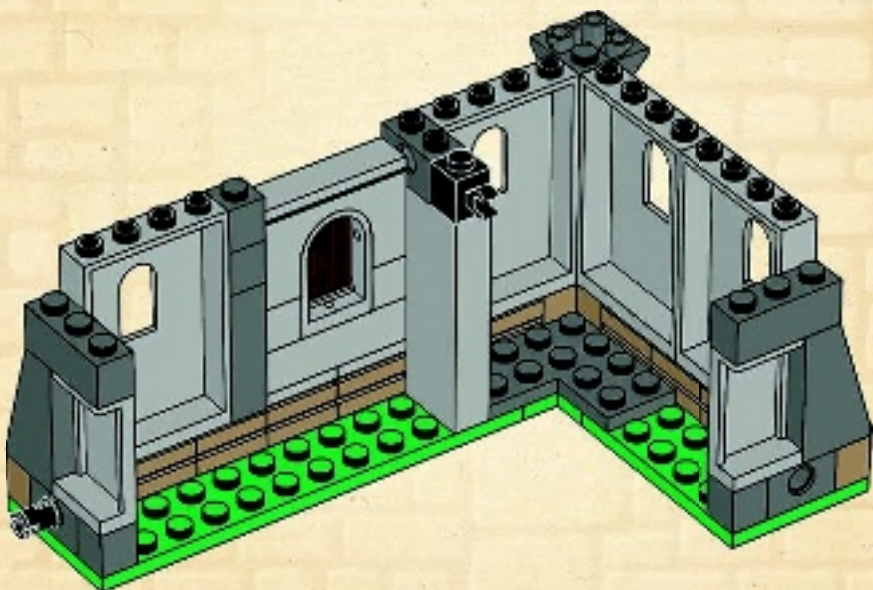



1x



2x



2x

20

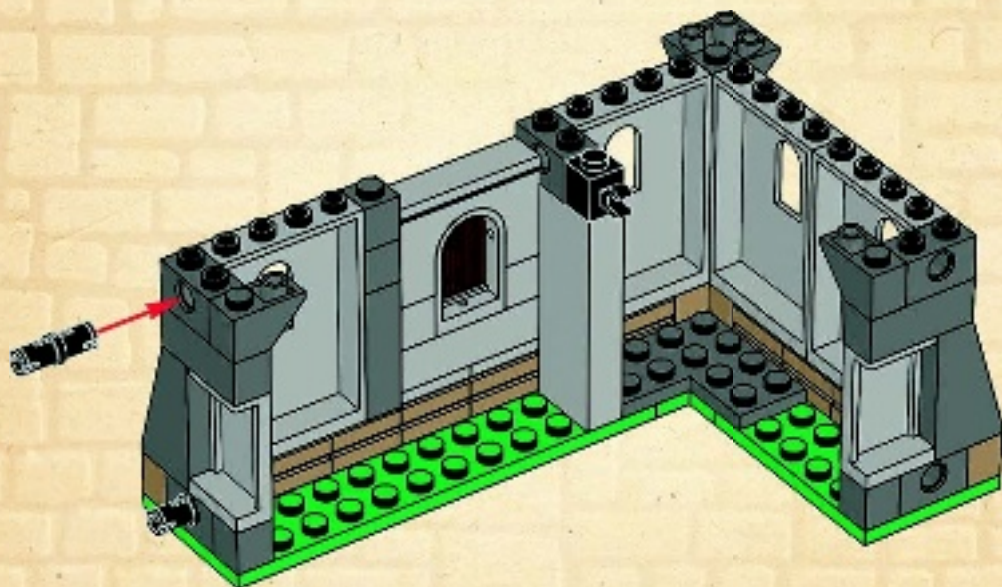



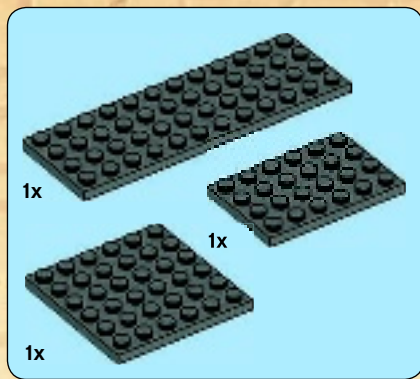

21

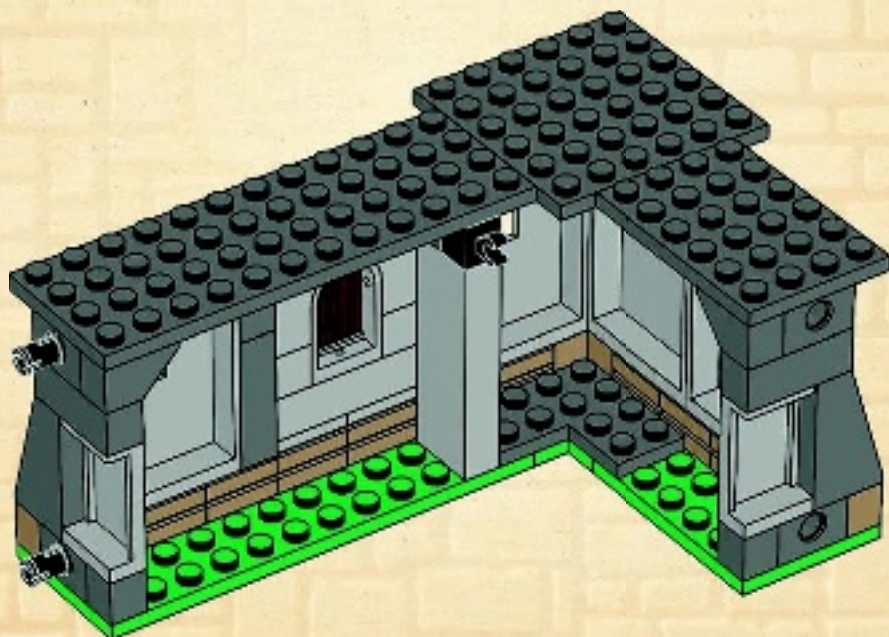



1x



2x

22

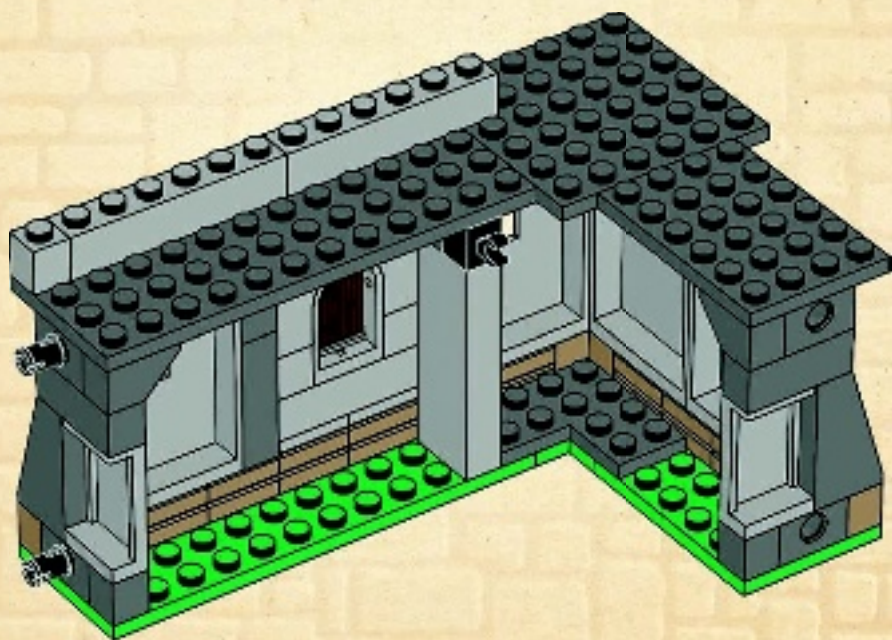





1x



2x

23

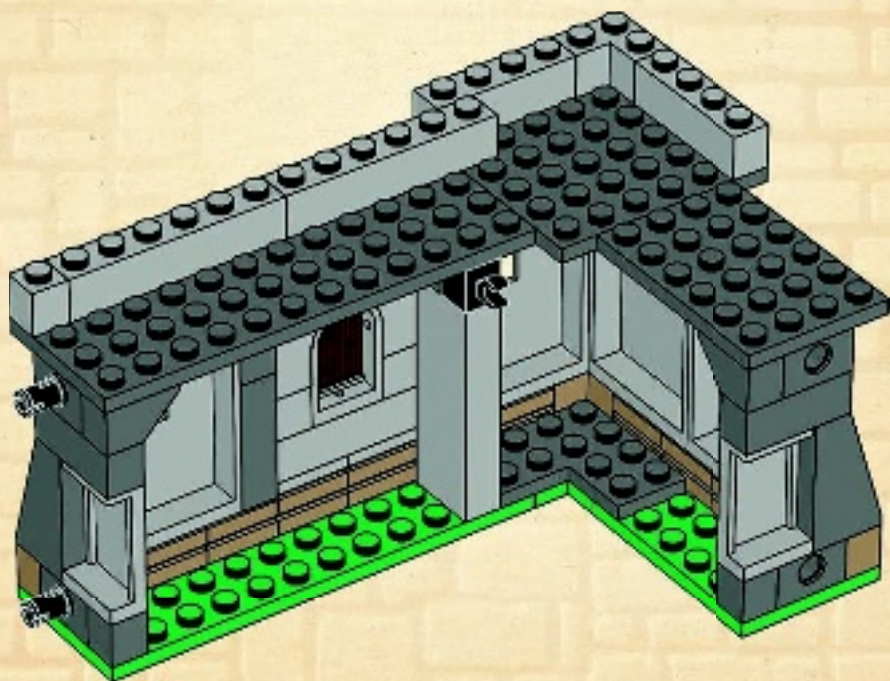



1x



1x

24

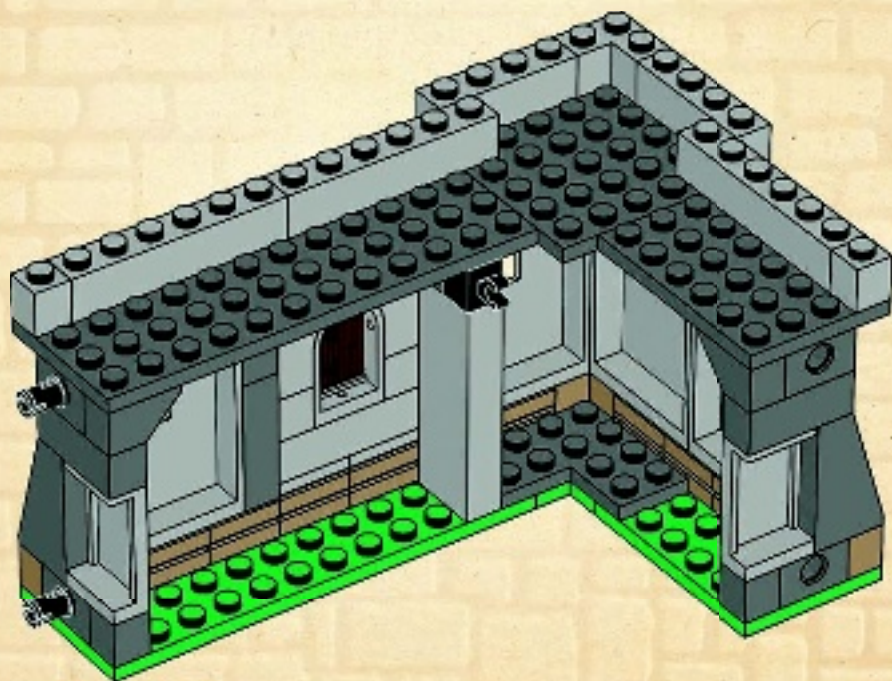





6x



2x

25

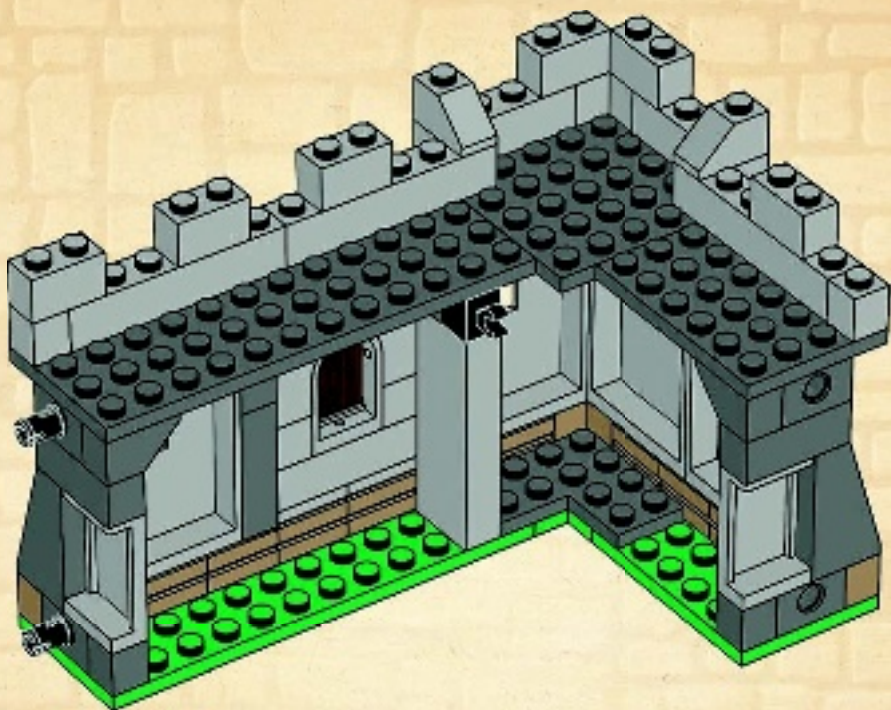



2x



6x

26

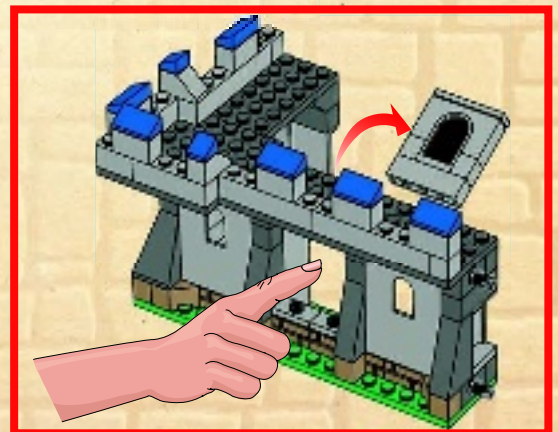
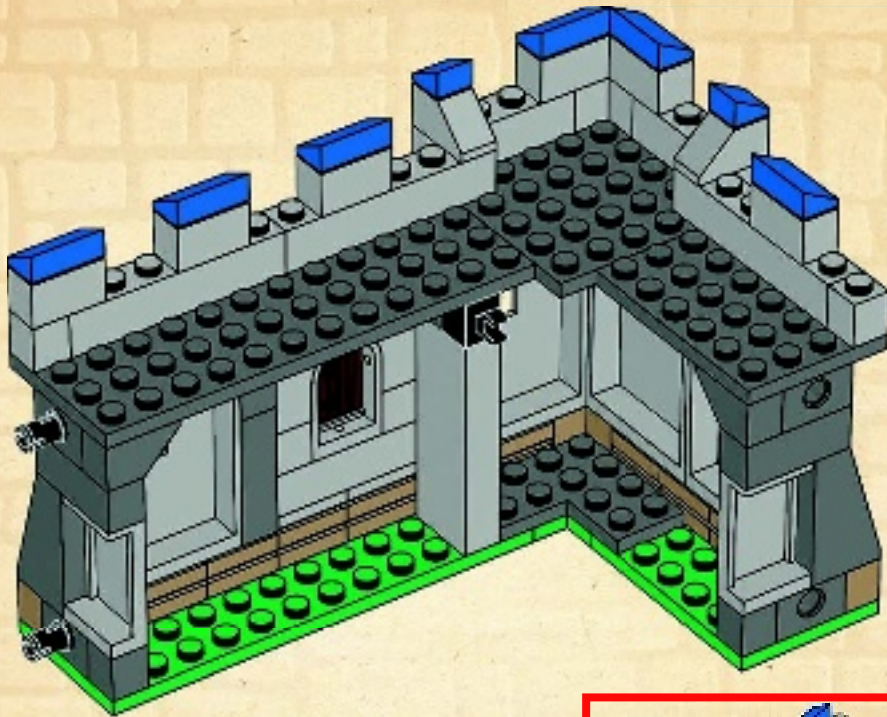



27

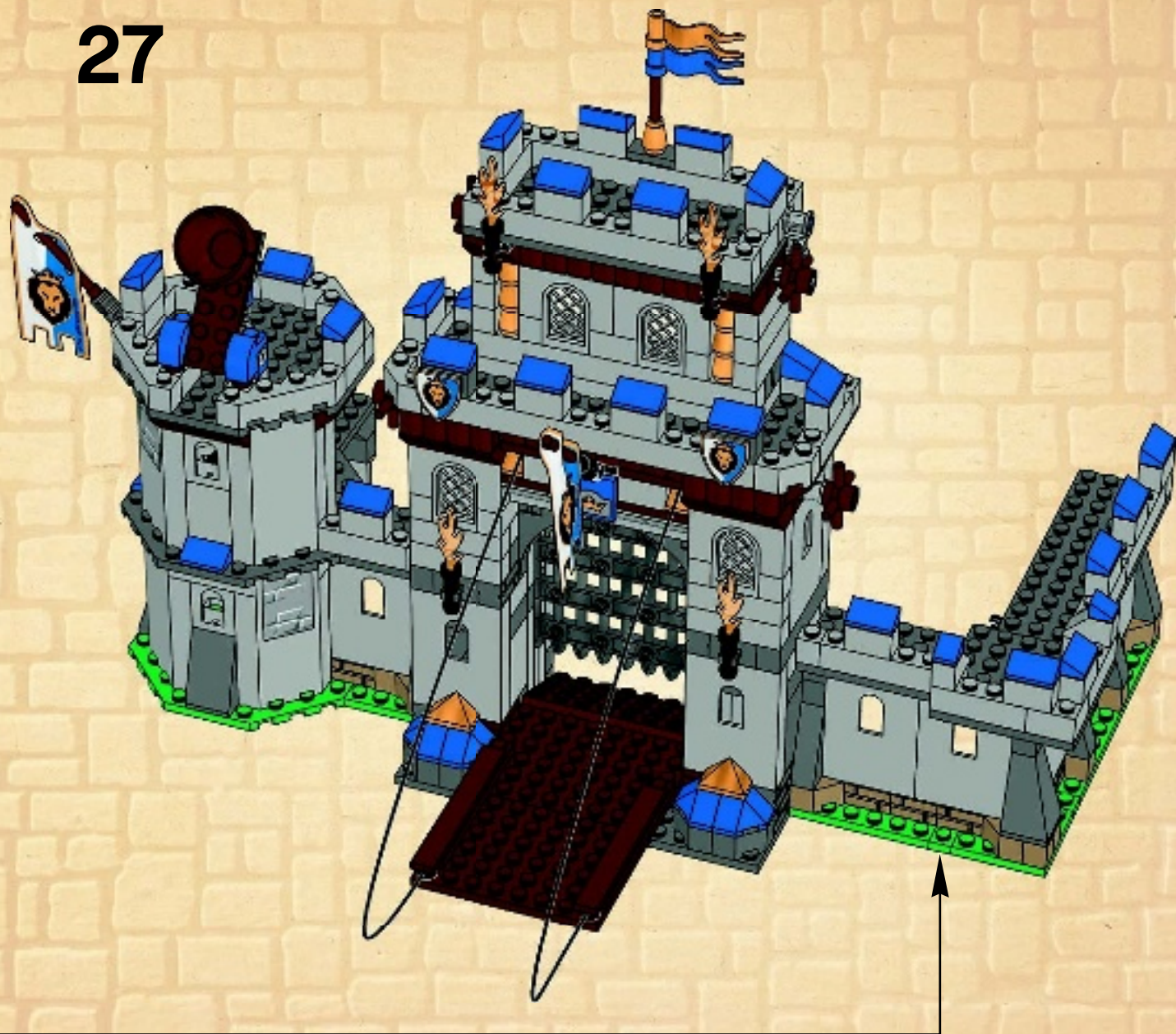

7

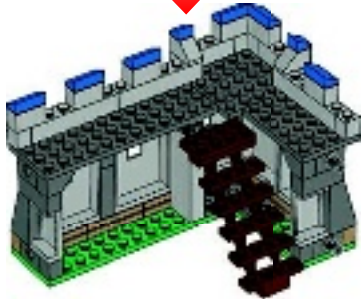

1x



1x

1



2x

2



1x



2x

3







2x

4



1x

5



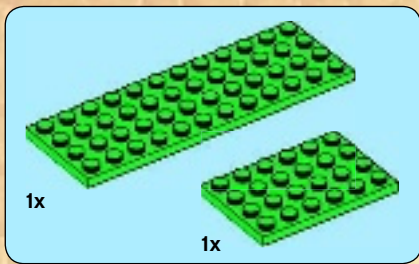

6

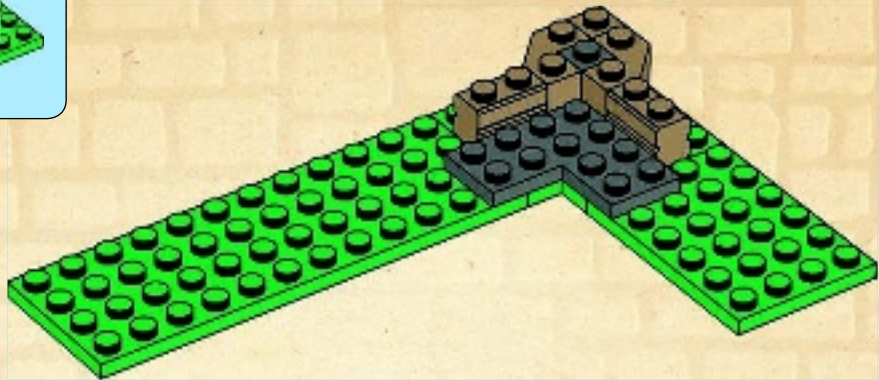

7

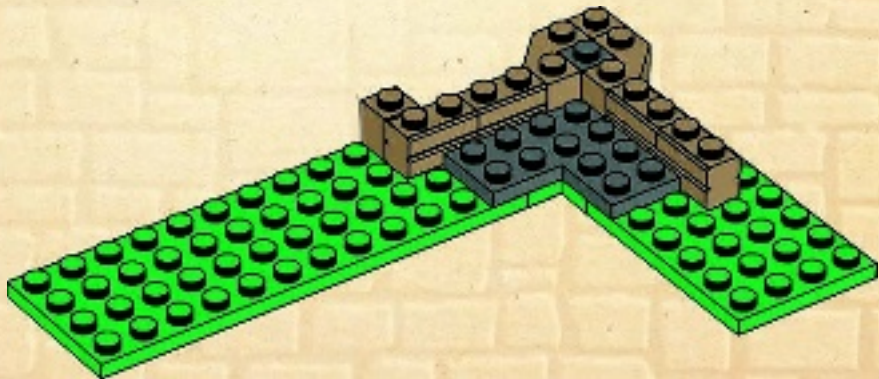





5x



1x

8

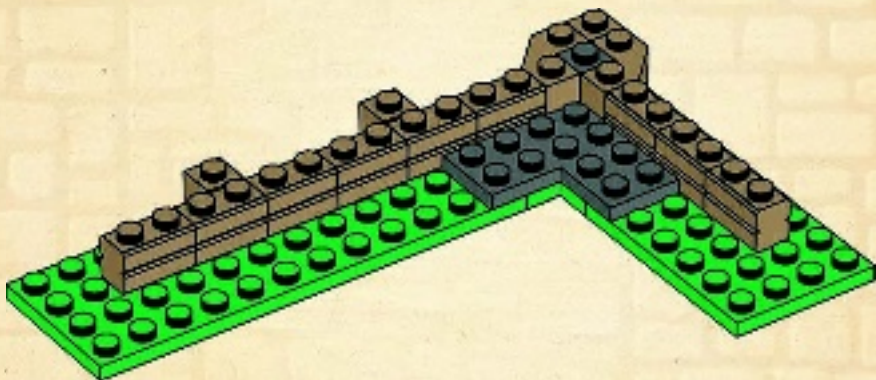

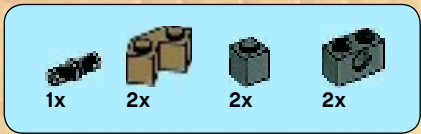

9

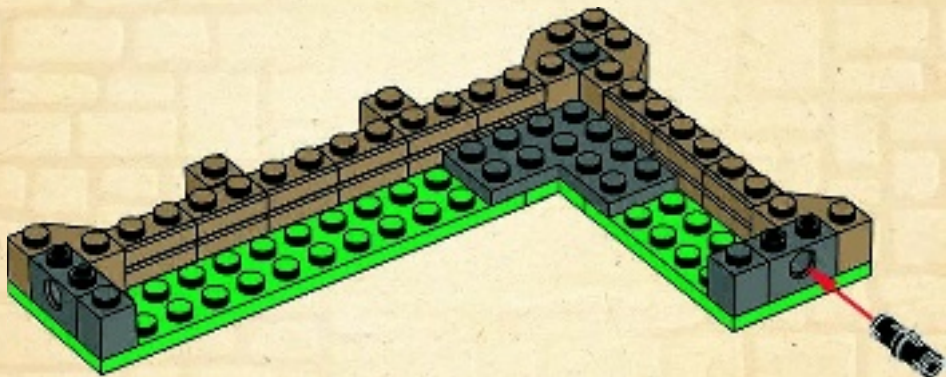





1x

10

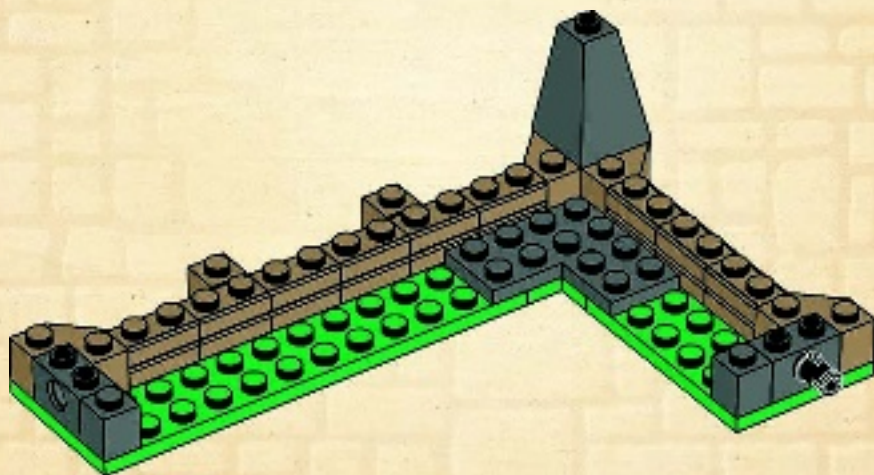



1x



1x

11

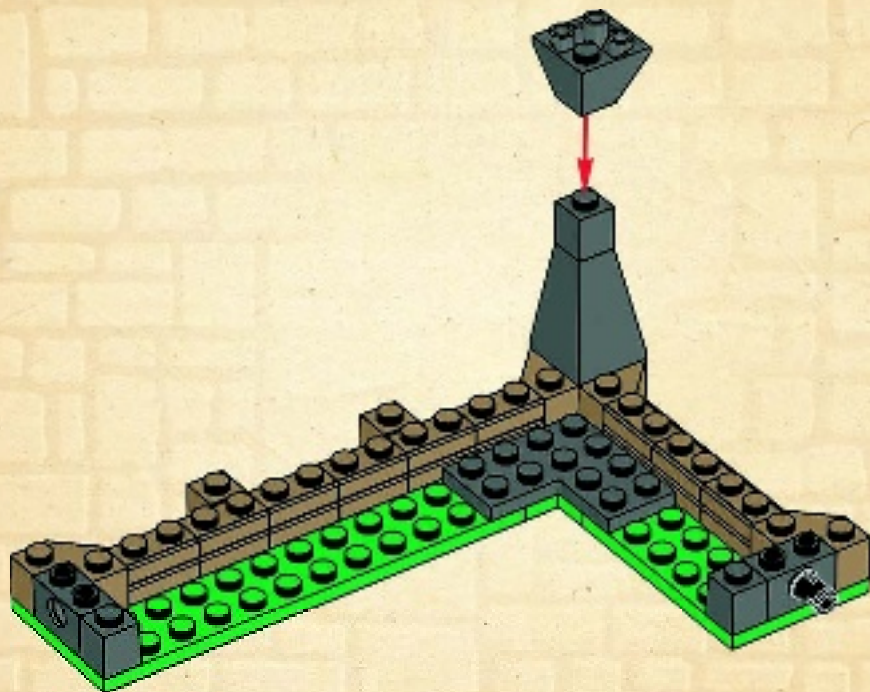





3x

12

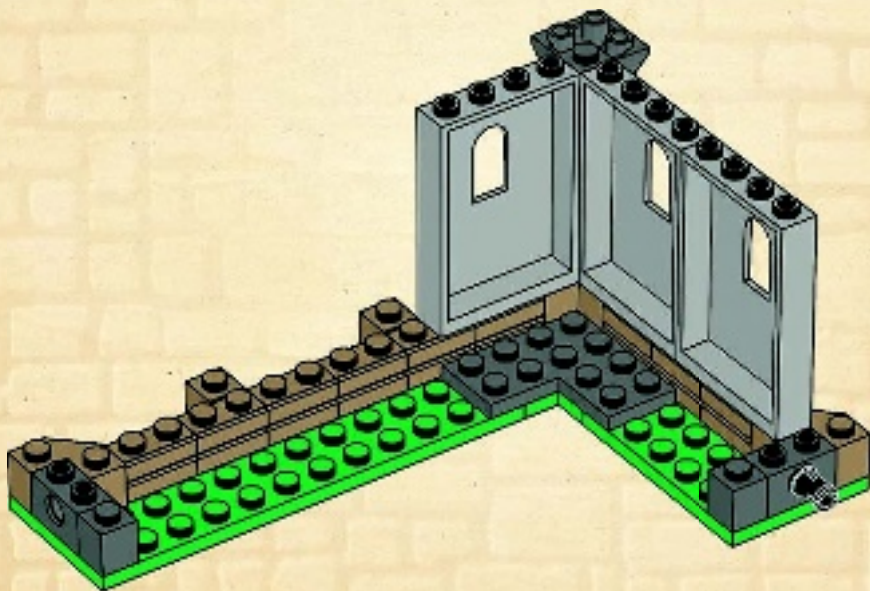

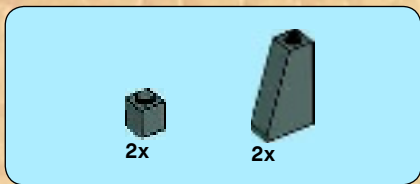

13

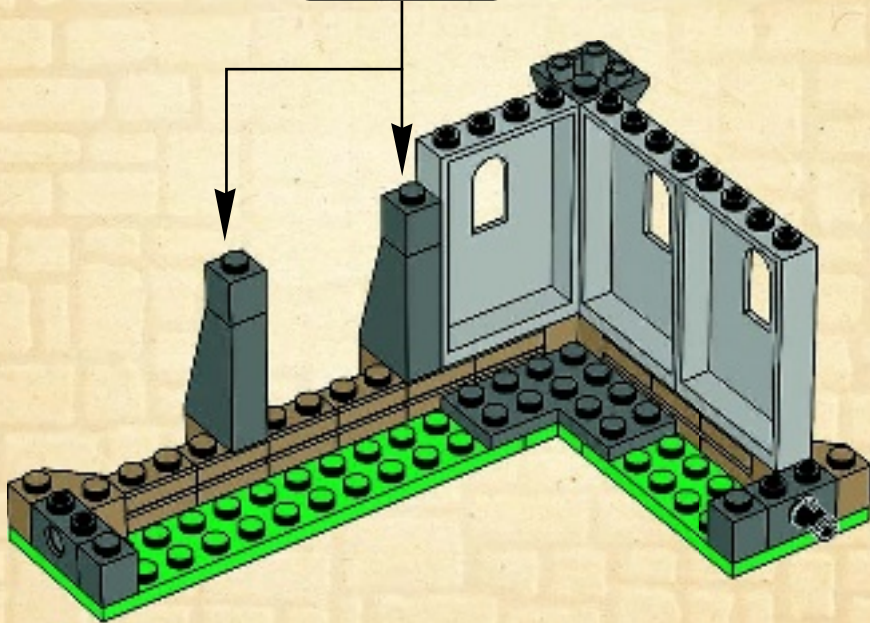
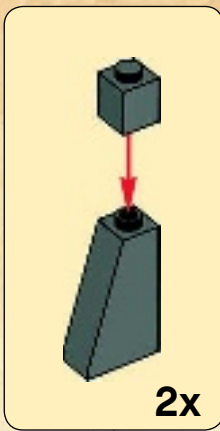



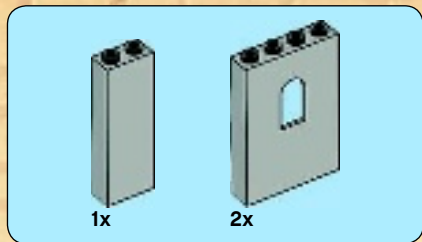

14

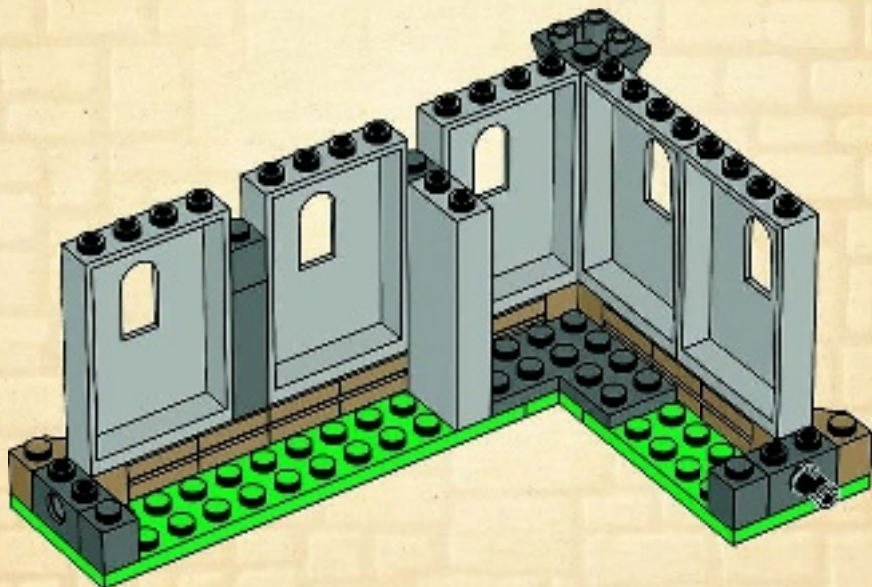



1x



1x



1x

15

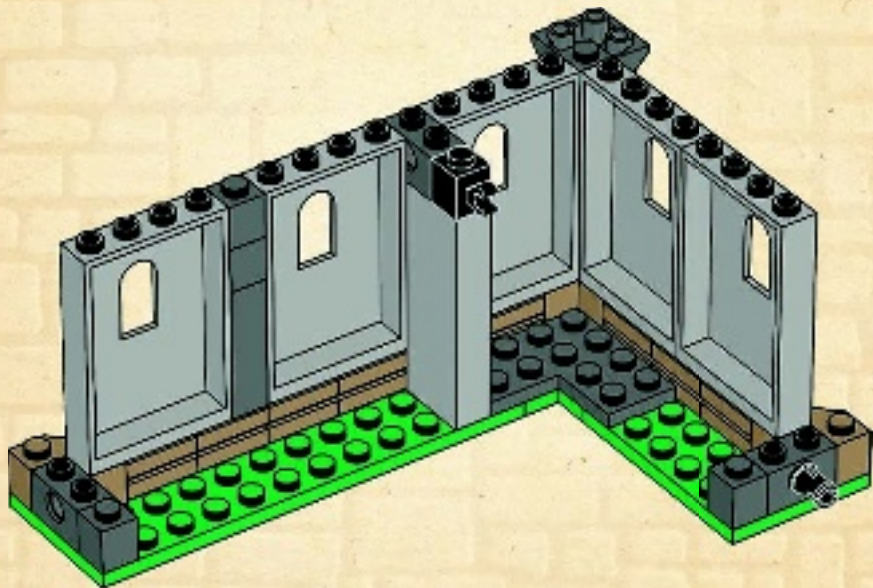



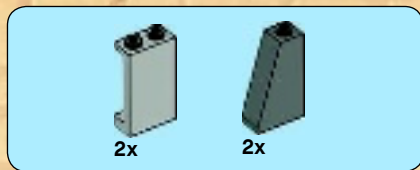

16

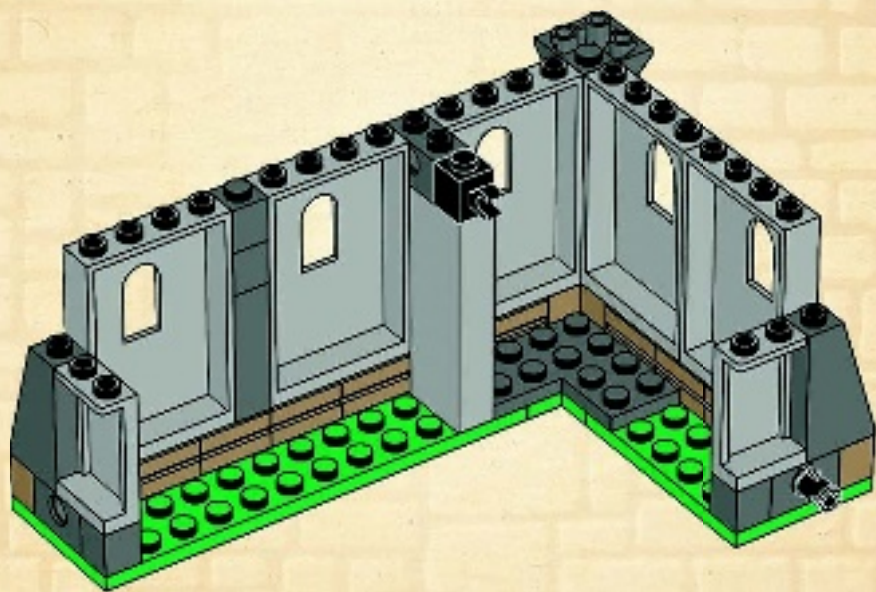



2x

17

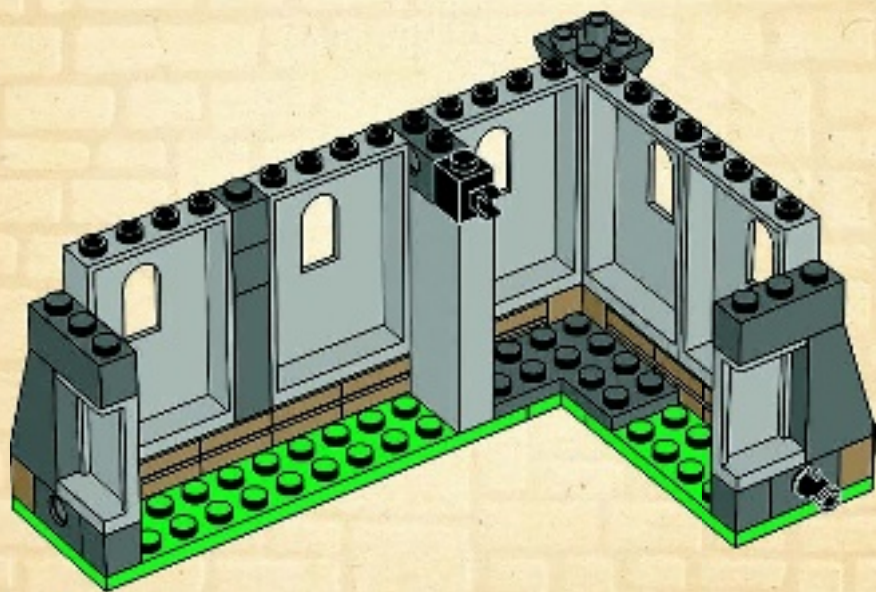





2x



2x

18

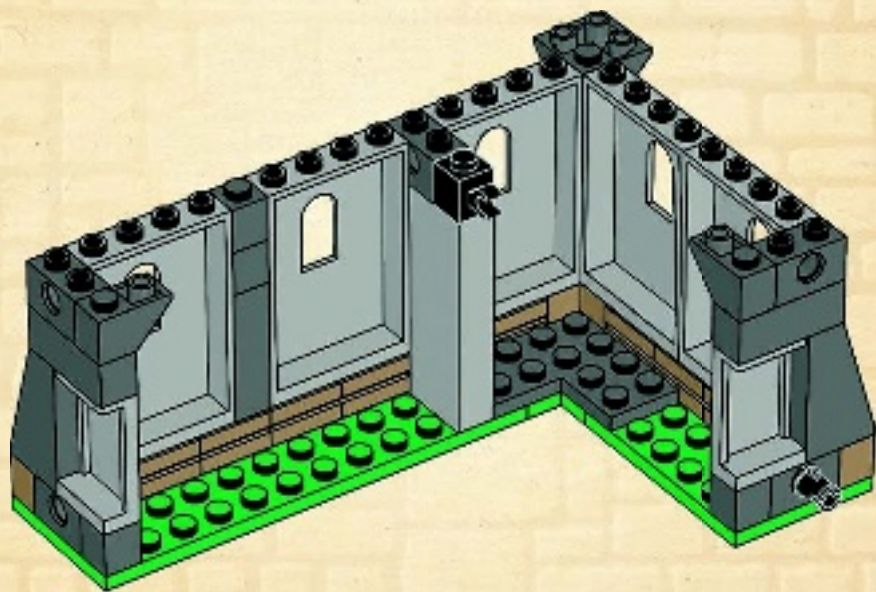

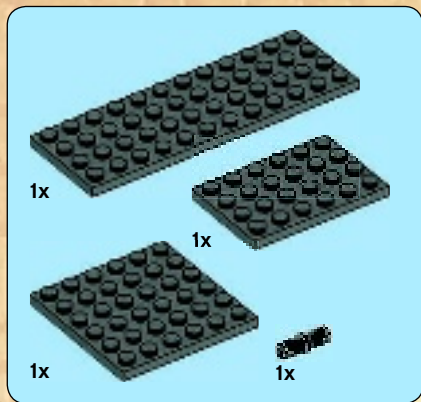

19

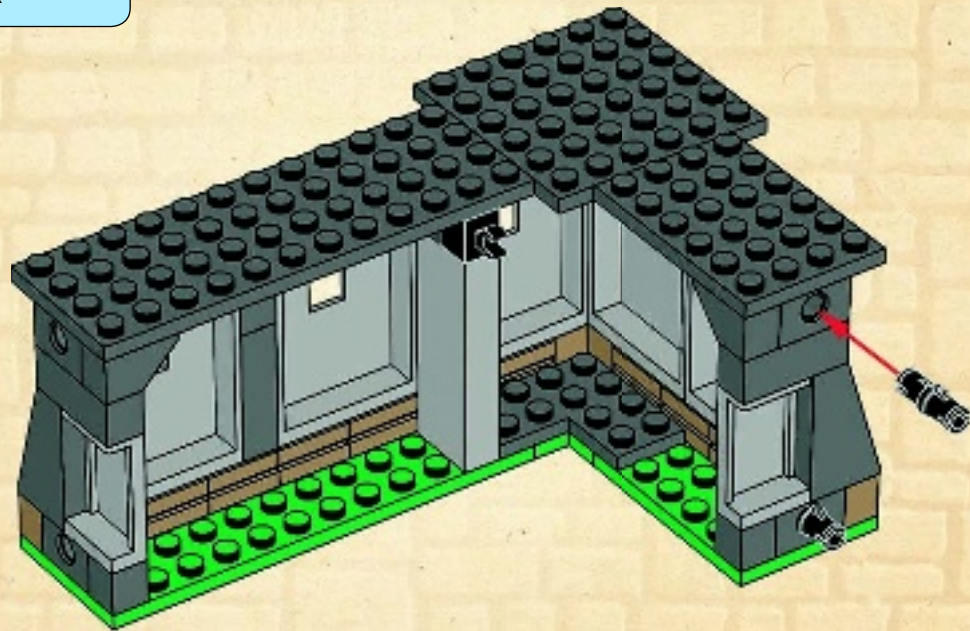



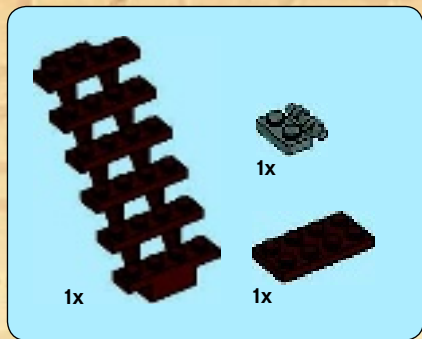

20

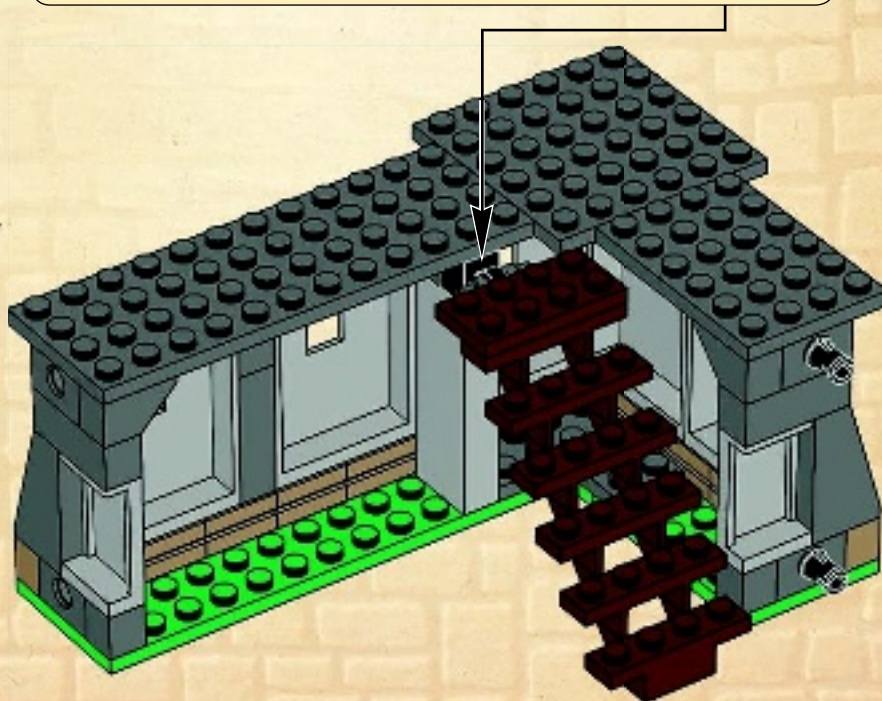
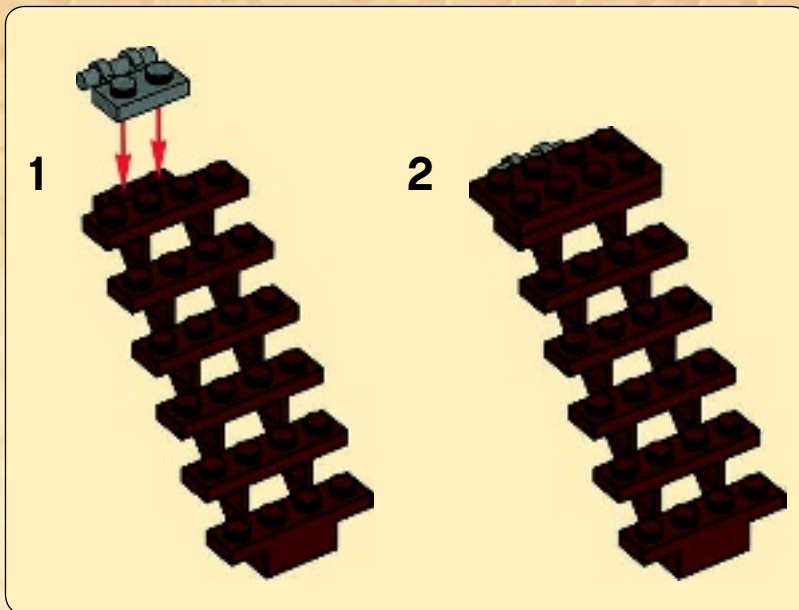



1x



2x

21

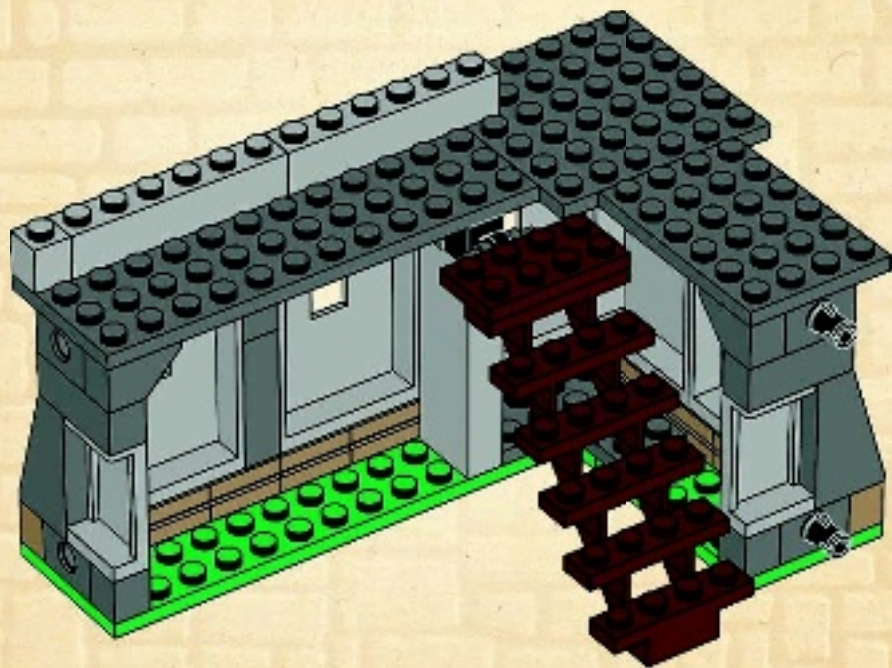



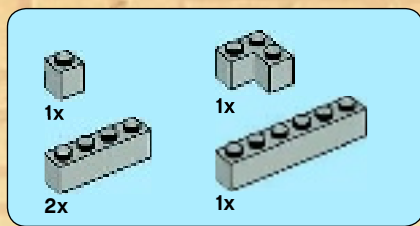

22

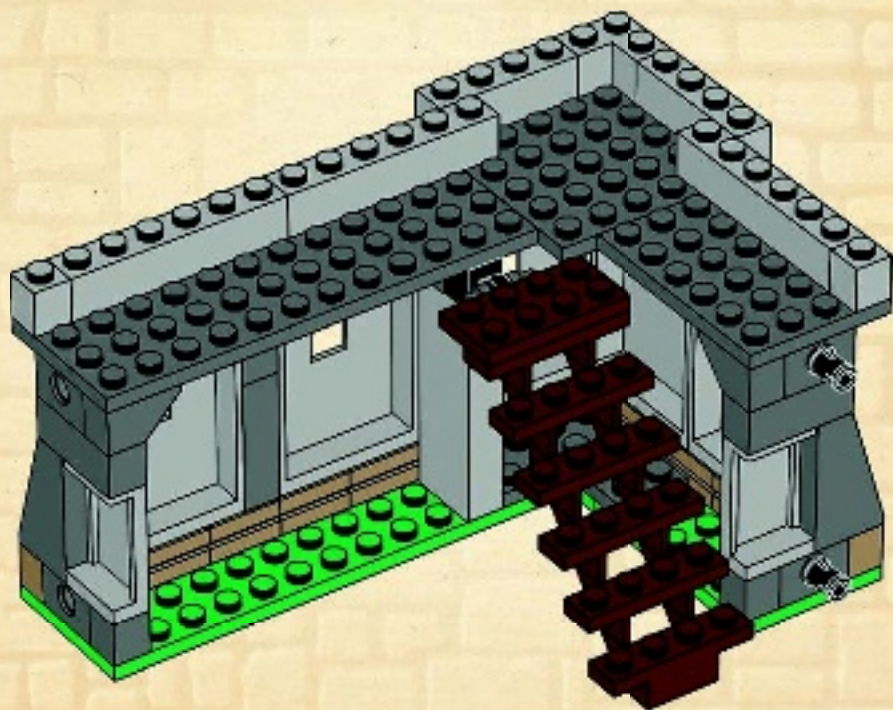



6x



2x

23

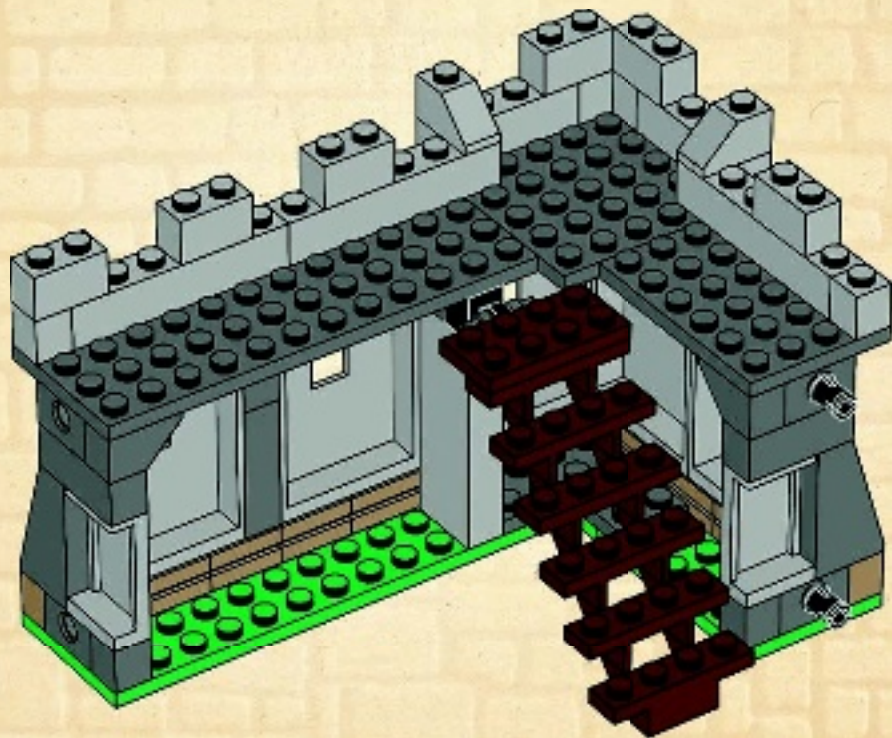





2x



6x

24

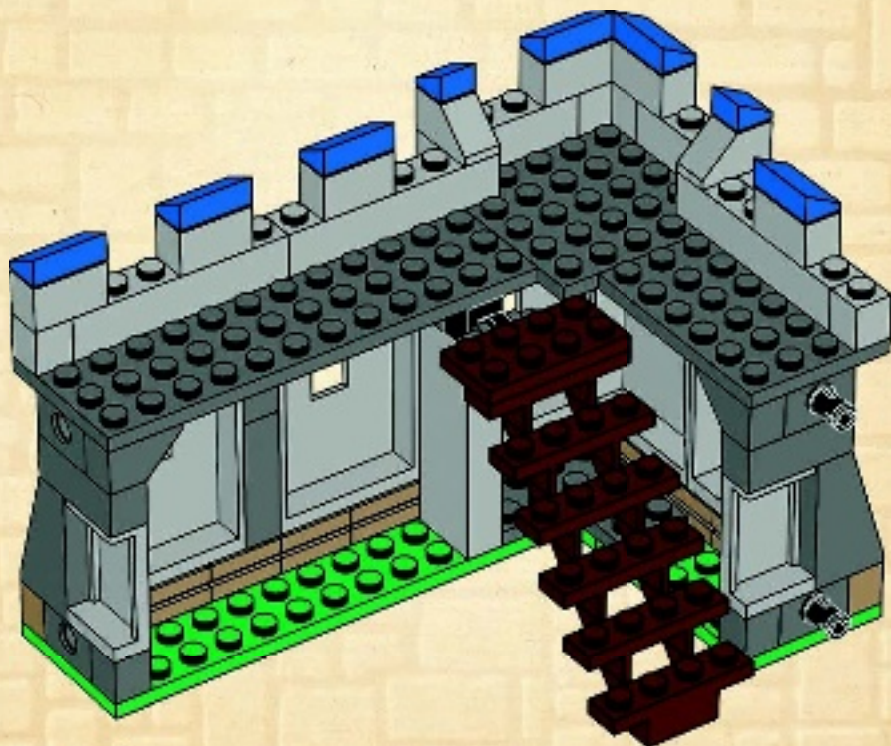

25

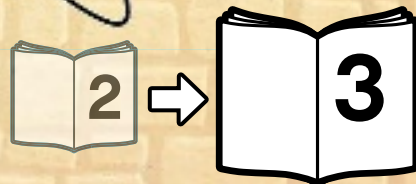
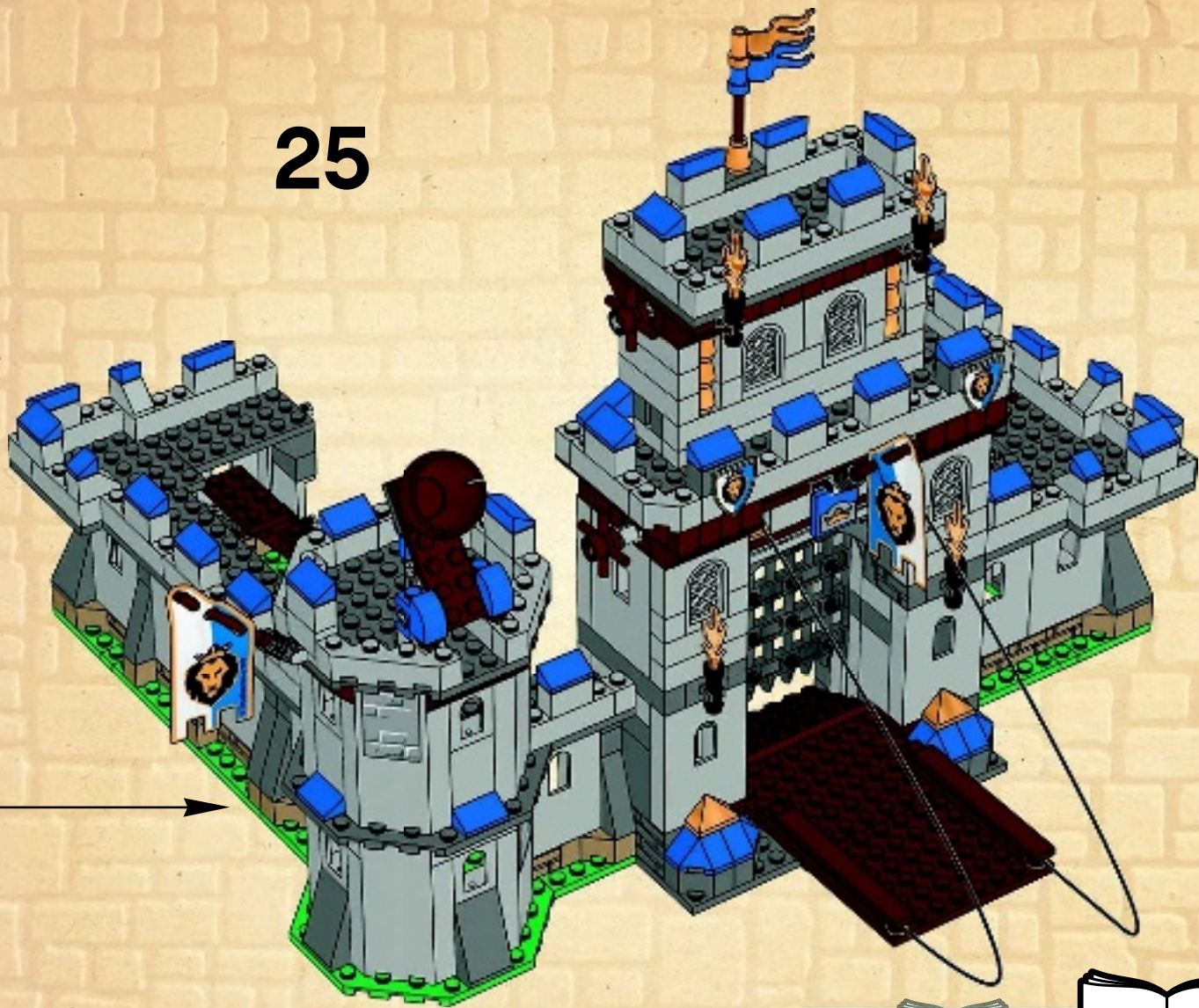





LEGO and the LEGO logo are trademarks of their/son/ des marques de commerce del/son  
marcas registradas de LEGO Group. ©2013 The LEGO Group.

6062526 / 6062524



70404



70402



70400



70403



70401





# Castle



70404







+



+



1x

1



1x



1x

2



1x



1x



1x

3

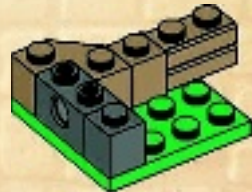

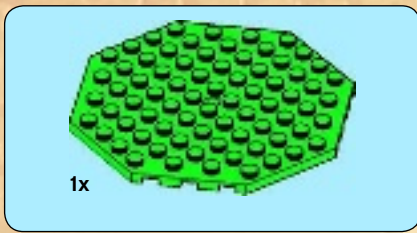

4

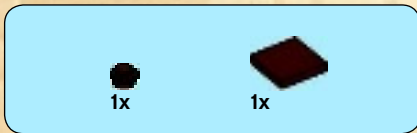
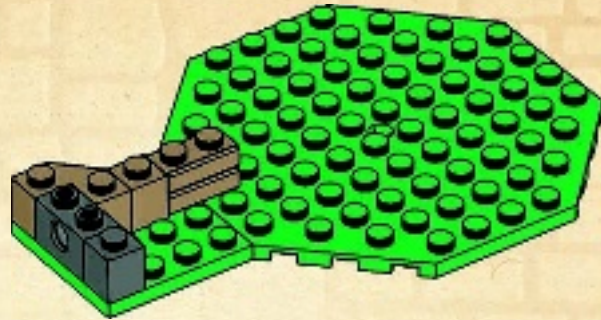

5

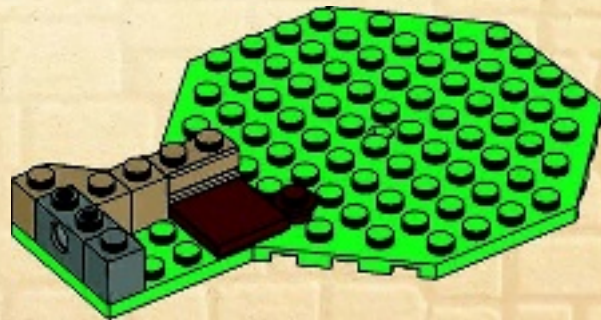





1x

6

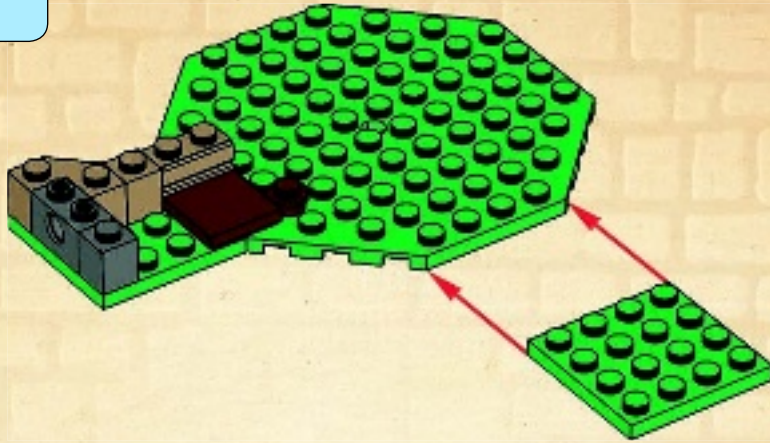

1x



1x



1x

7

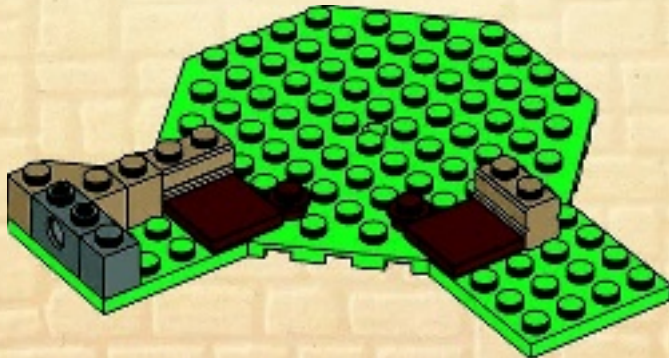



8

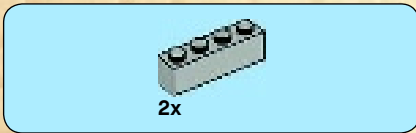
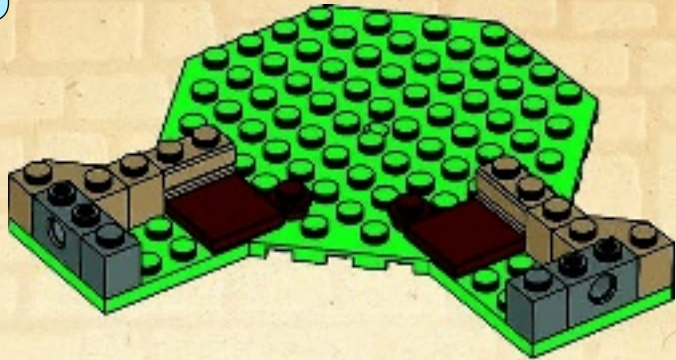

9







6x

10



2x

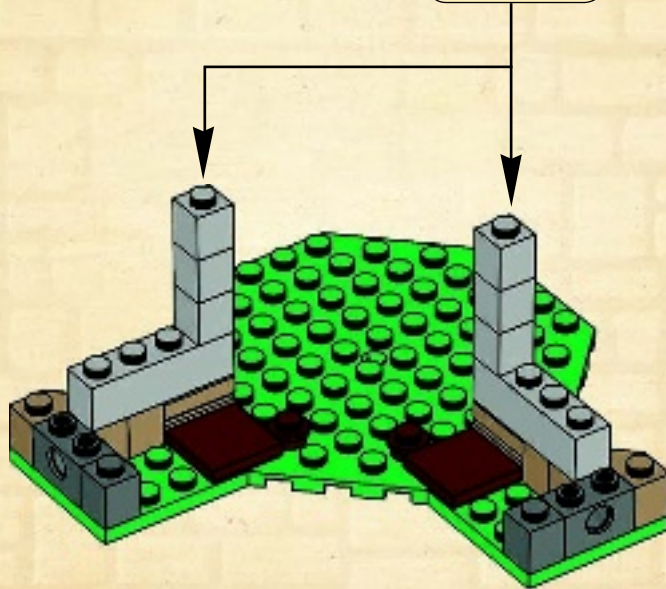



2x

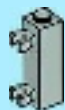

2x

11

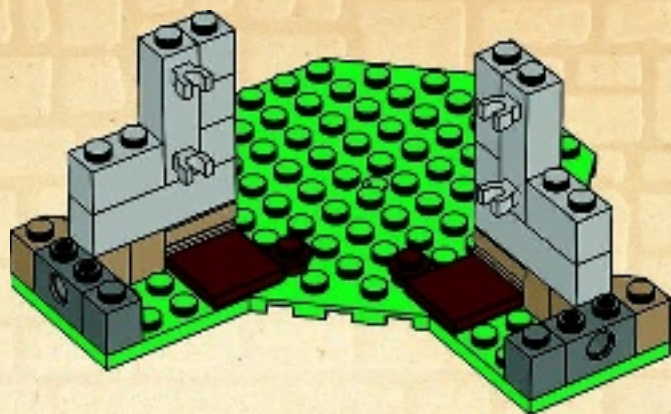

2x



2x

12

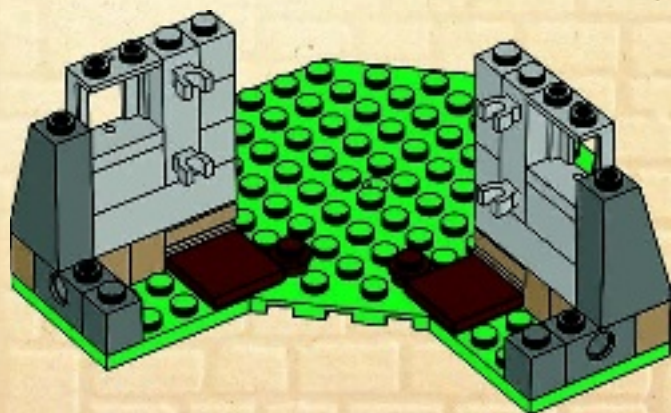





2x

13

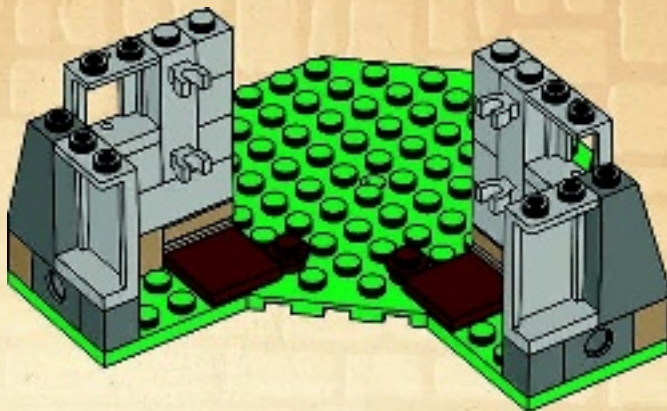

2x

14

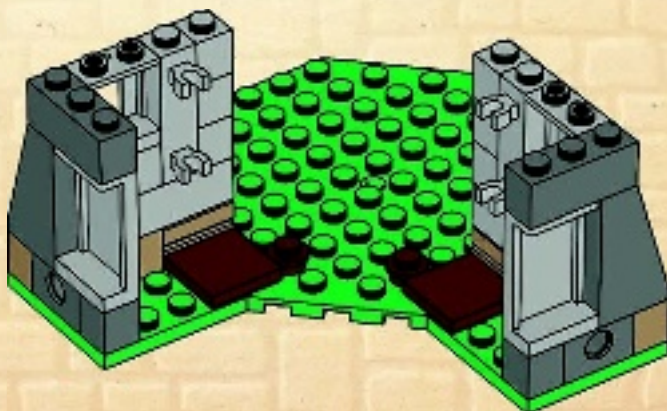



2x



2x

15

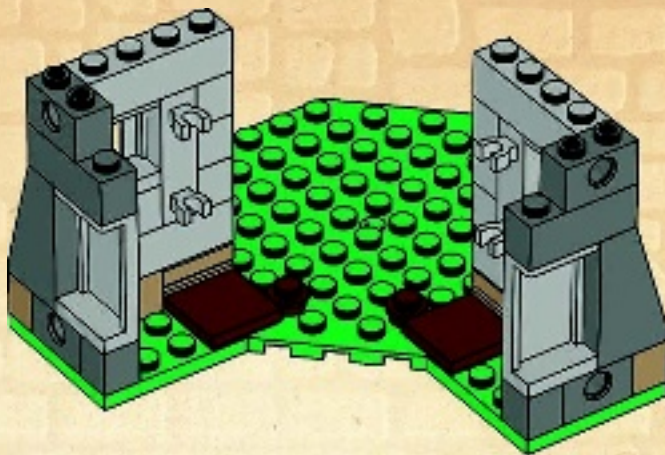

2x

16

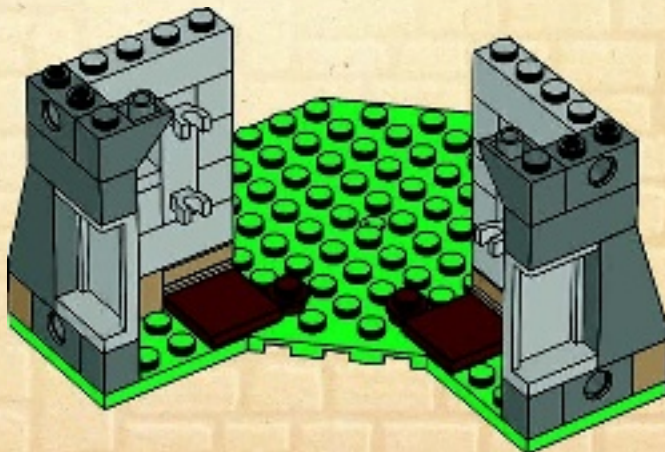





2x

17

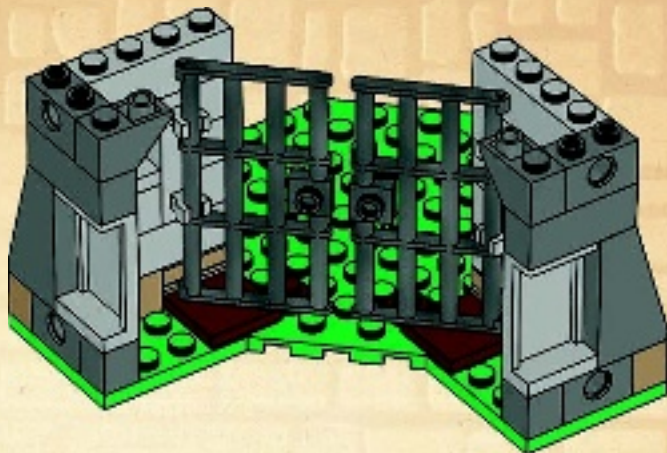

1x

18

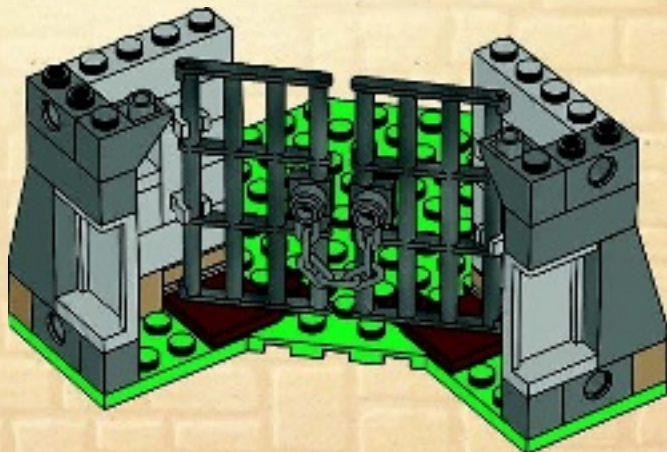



19

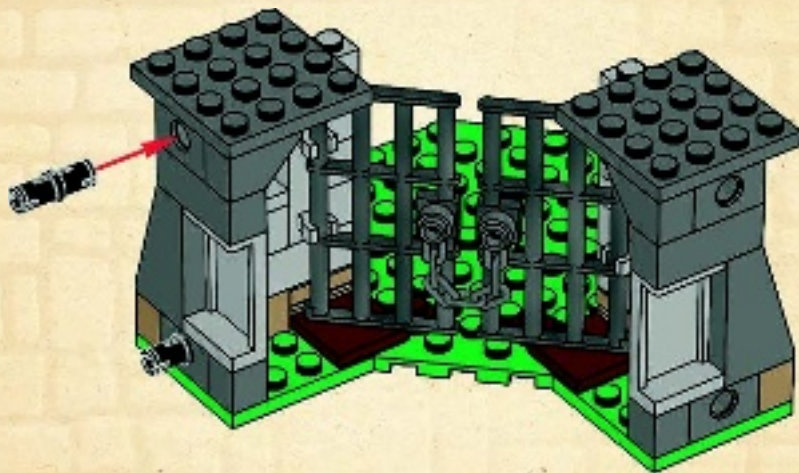



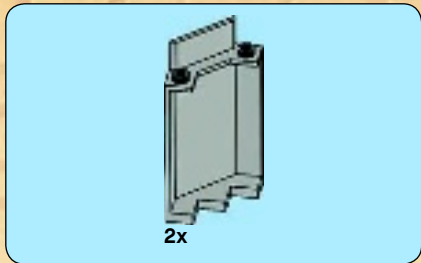

20

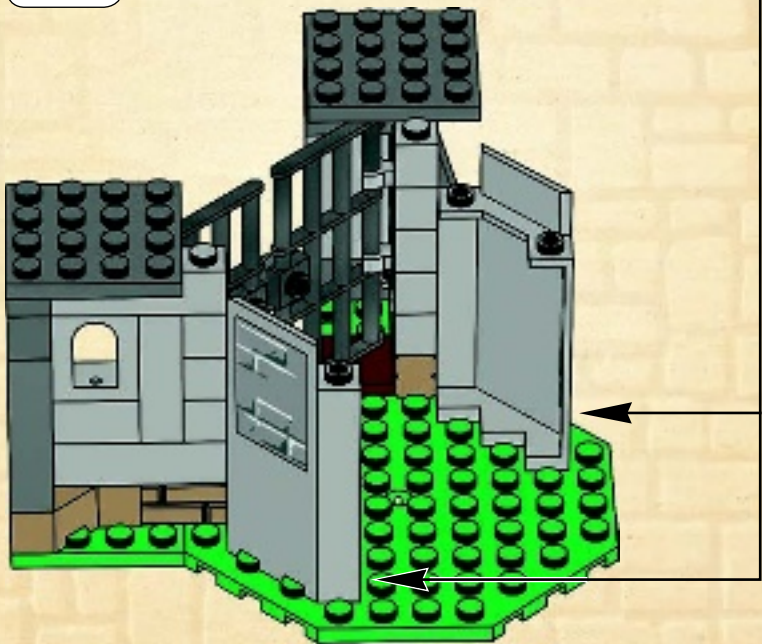
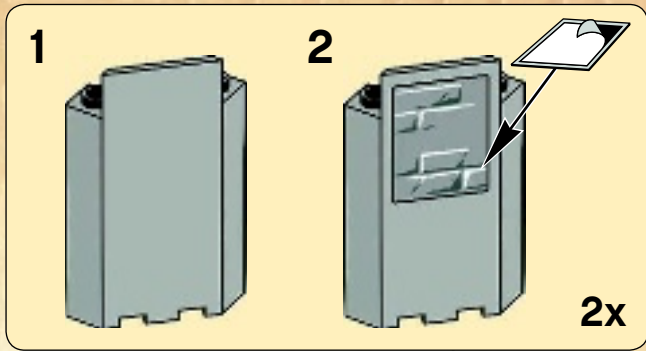
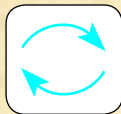



2x

21

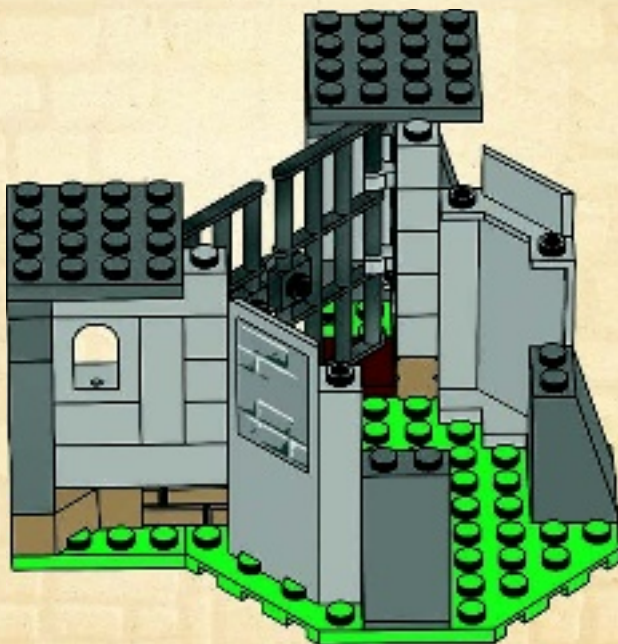



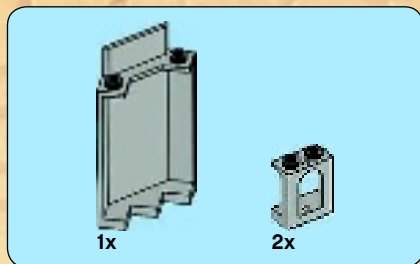

22

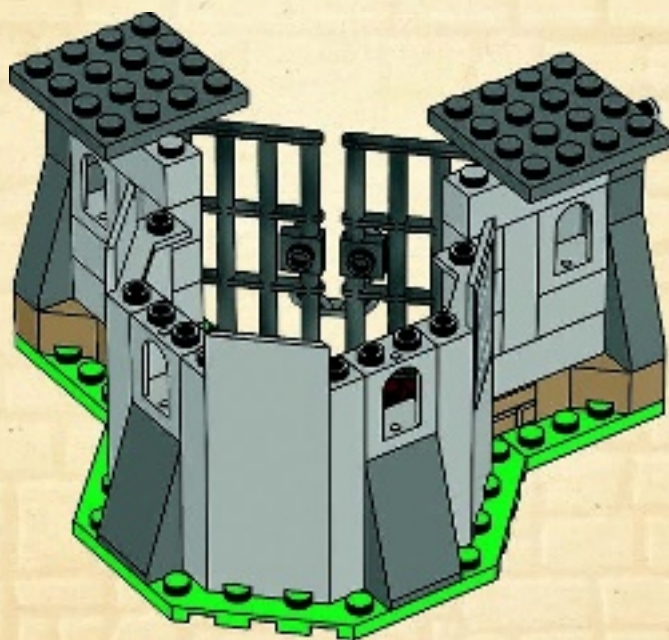



2x



2x

# 23

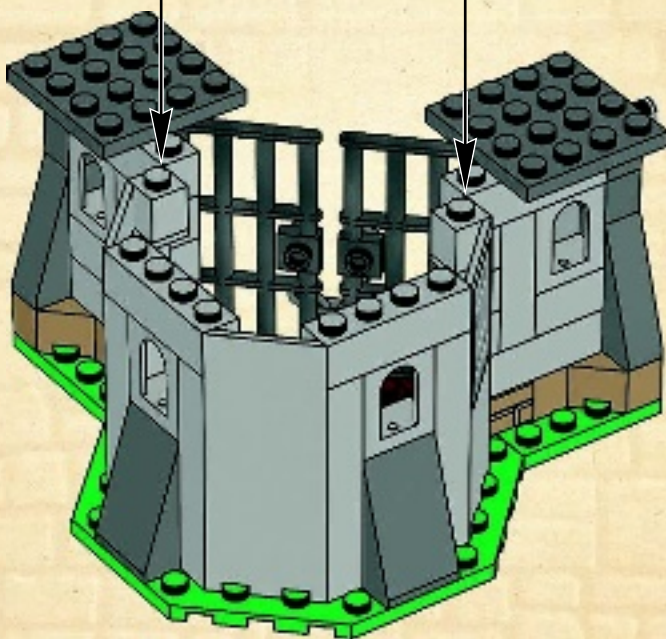



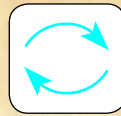
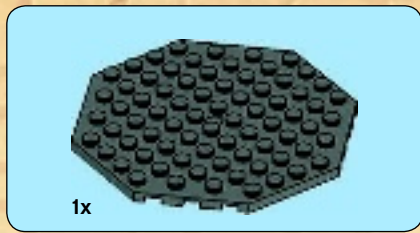

24

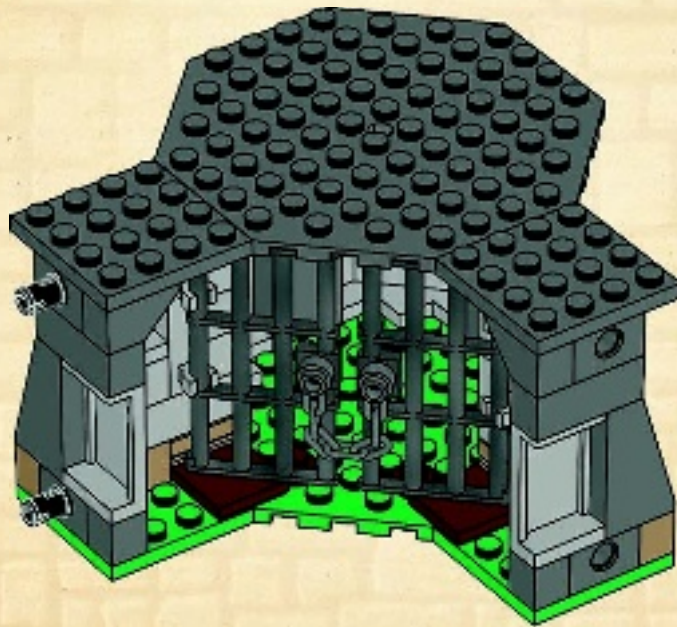



2x



2x

25

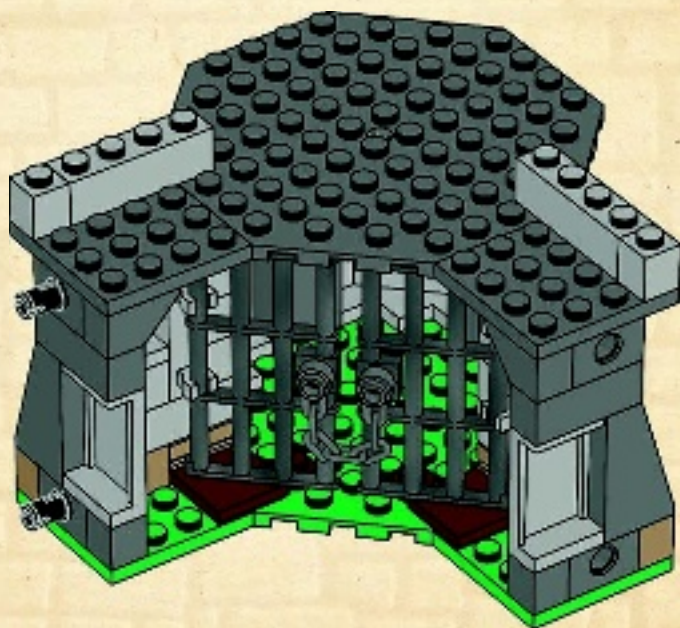





2x

26

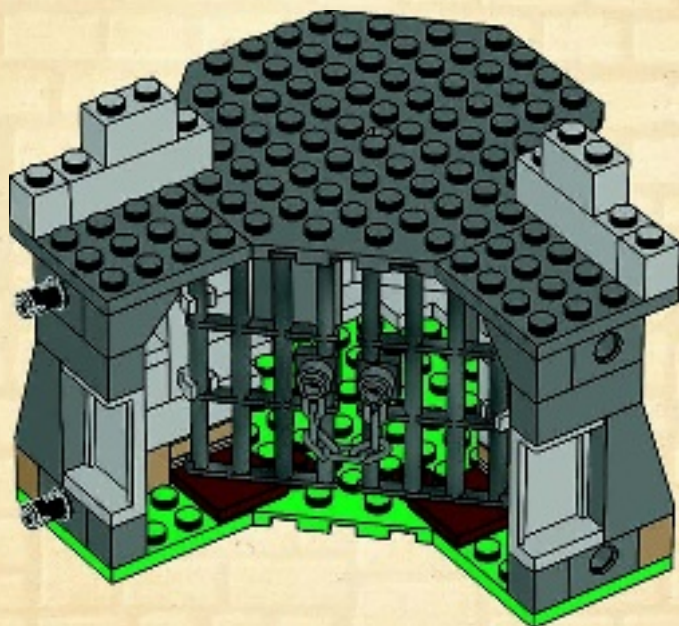

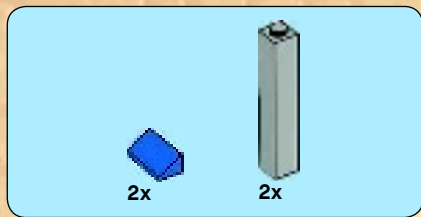

27

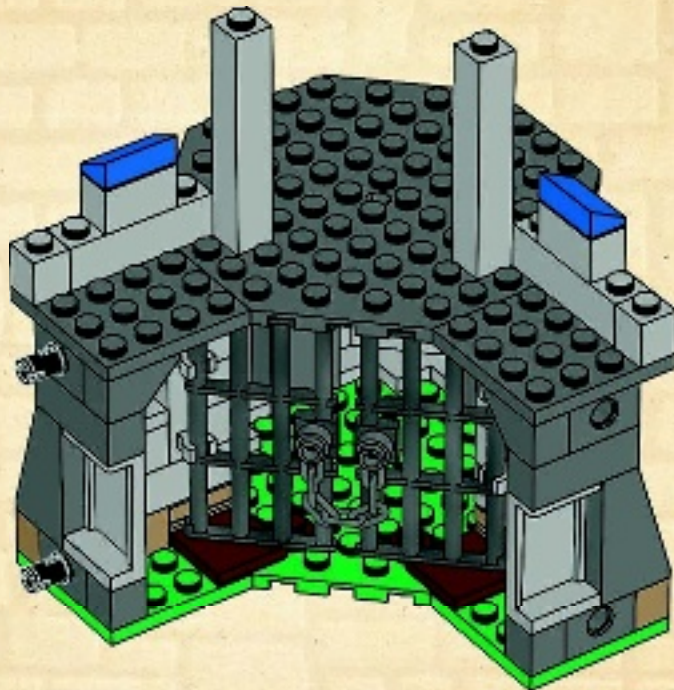



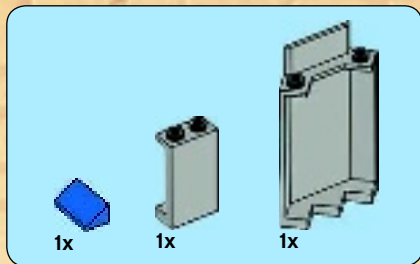

28

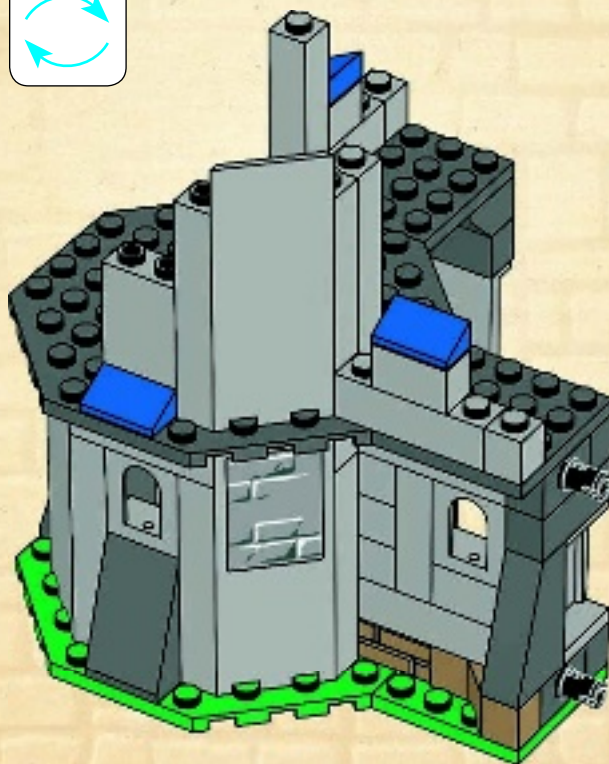
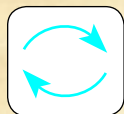

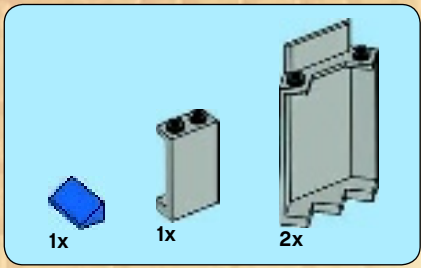

29

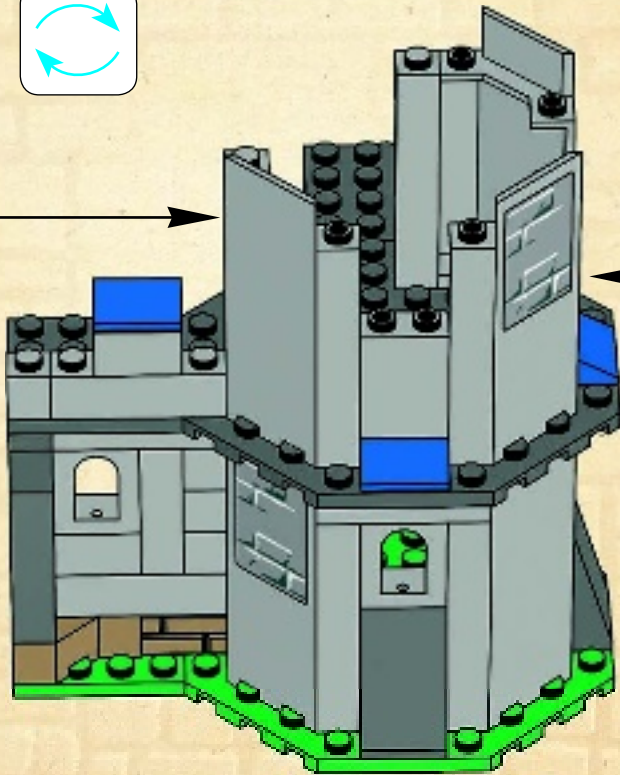
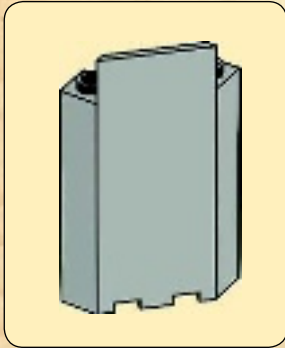
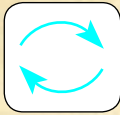
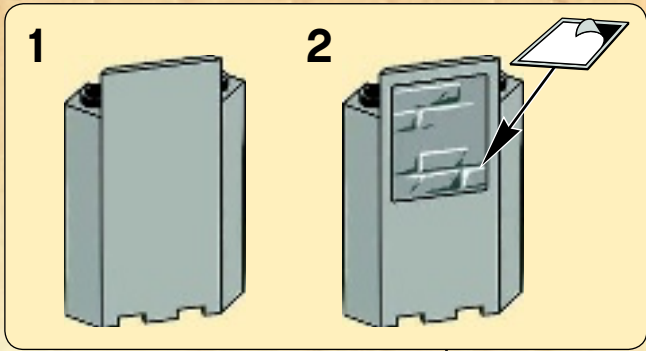





2x

30

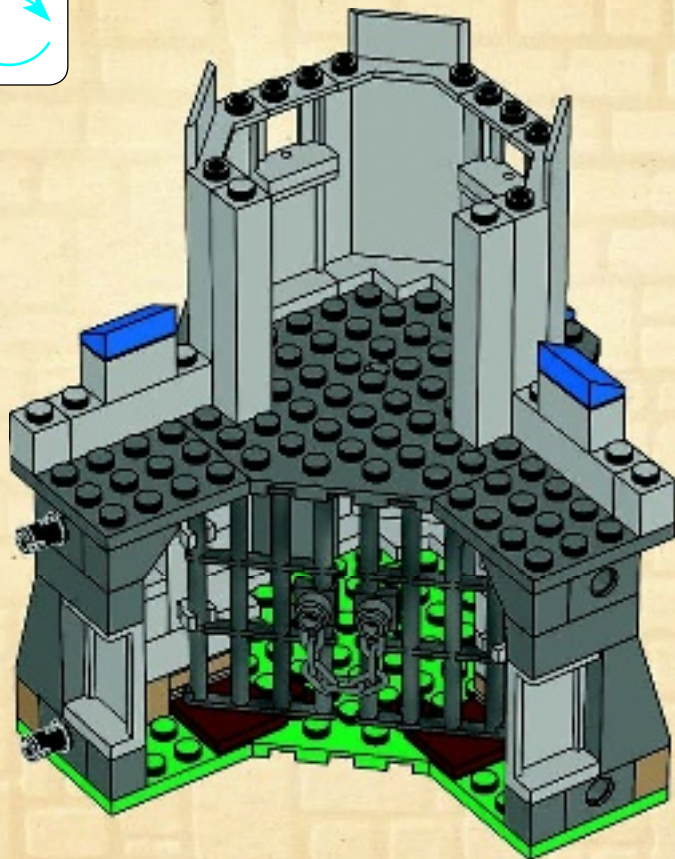
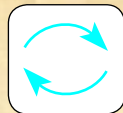



6x

31

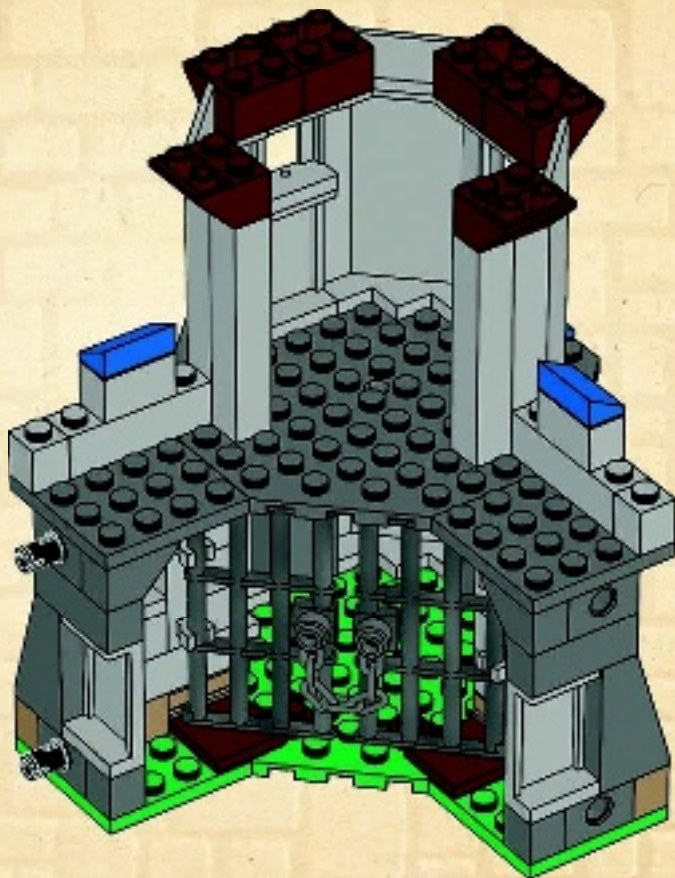



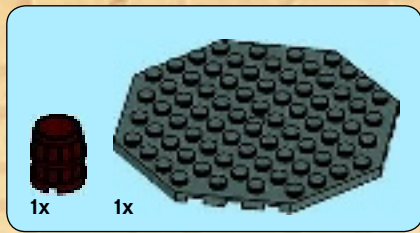

32

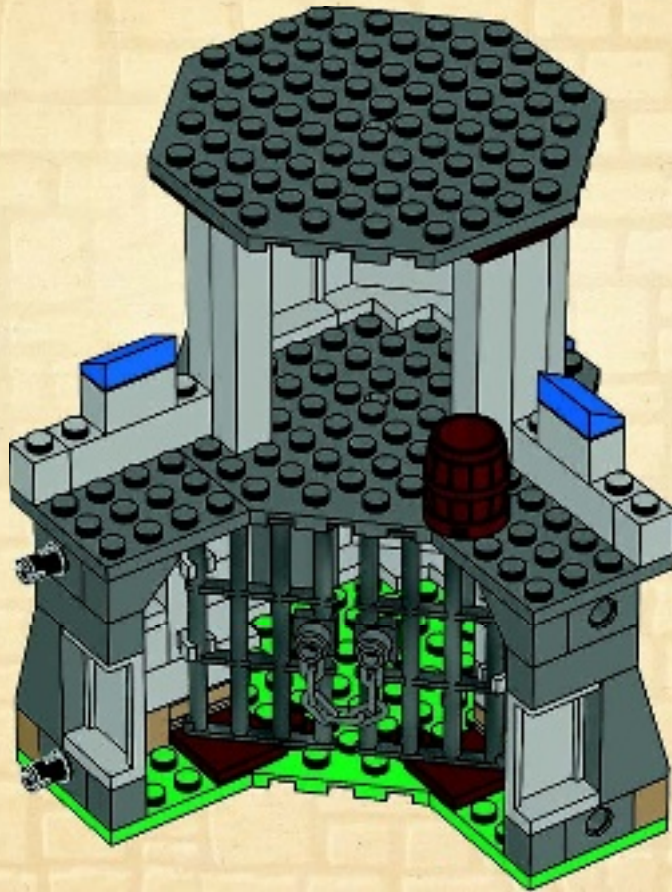

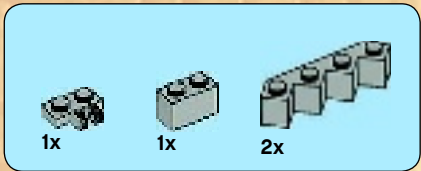

33

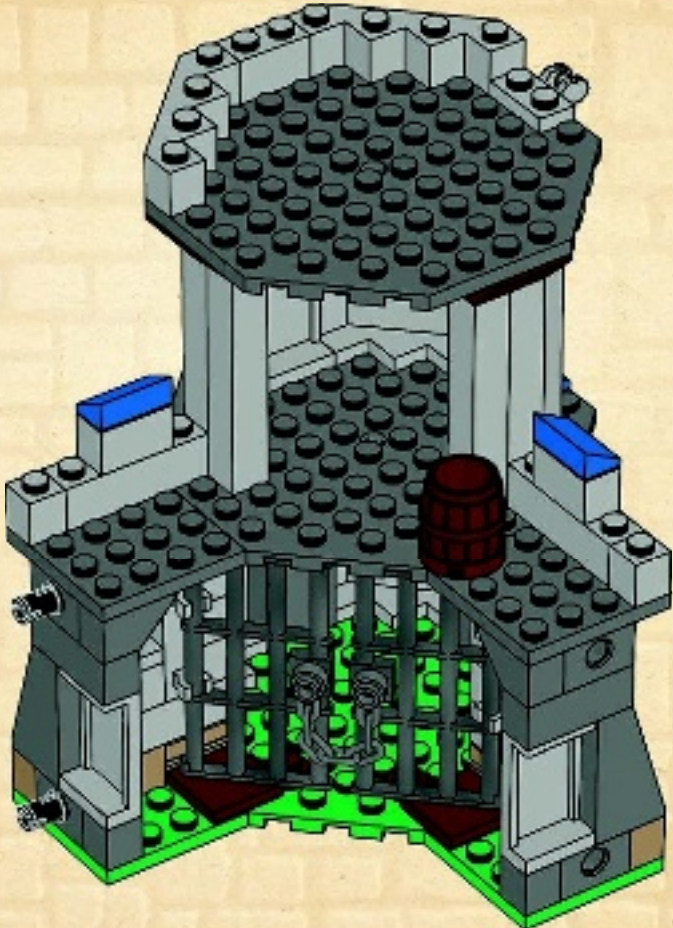





3x



2x

# 34

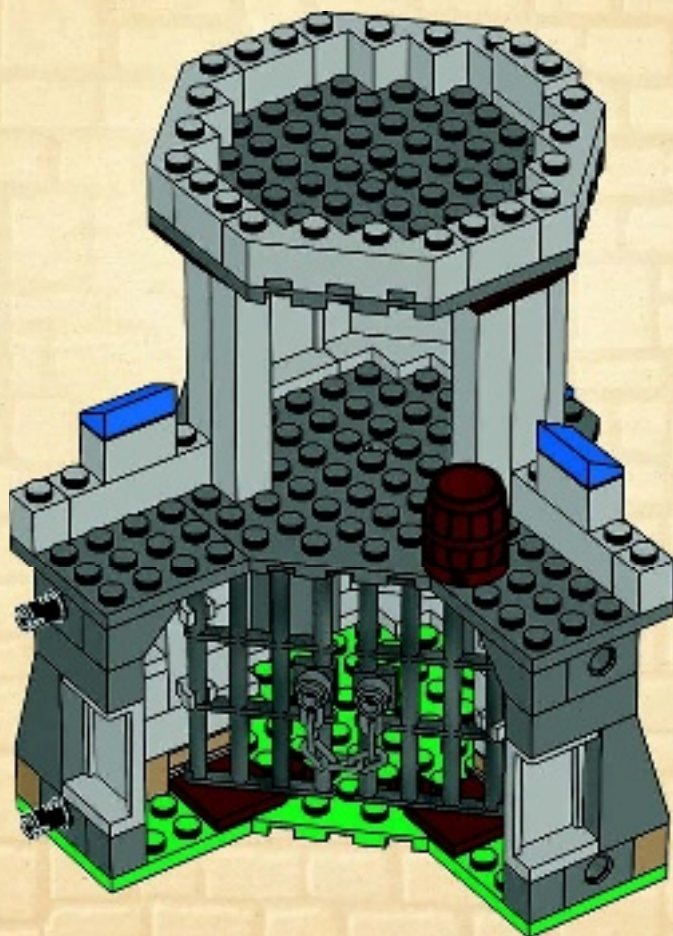



4x



1x

35

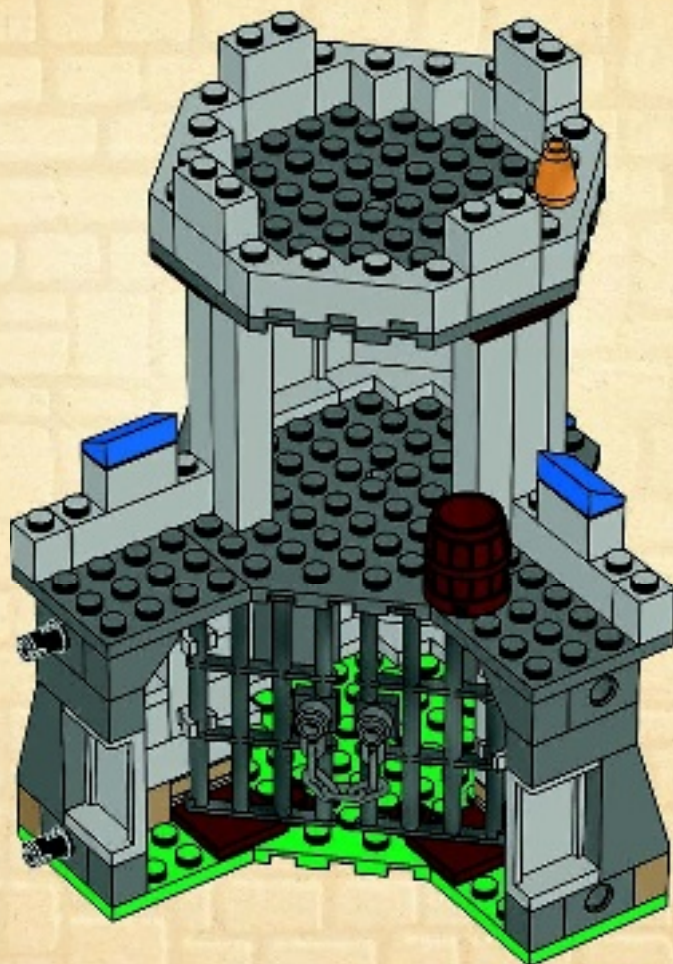





1x



4x

36

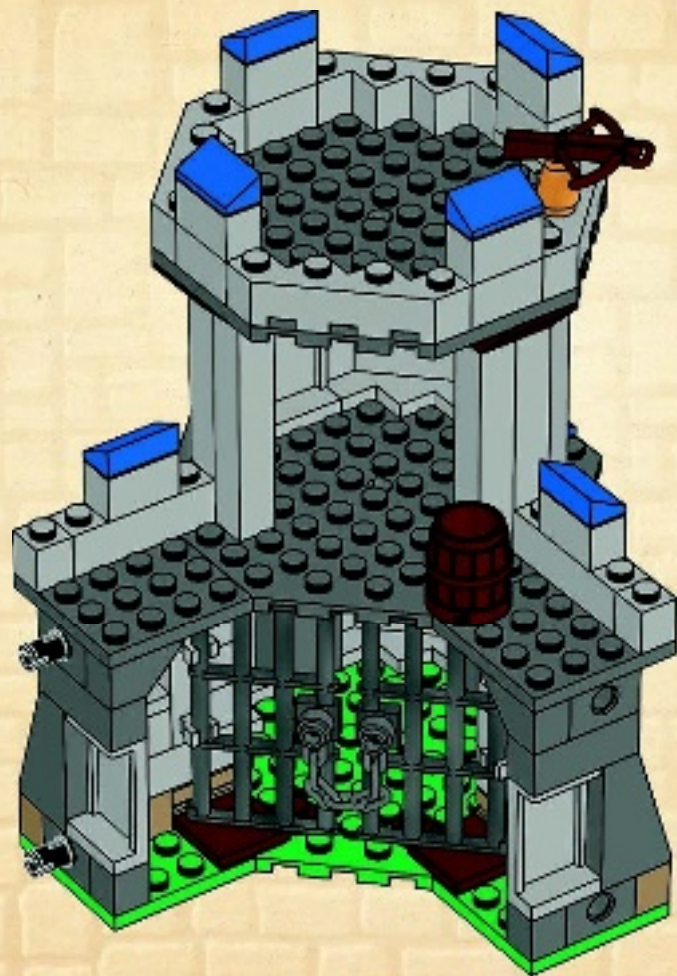



37

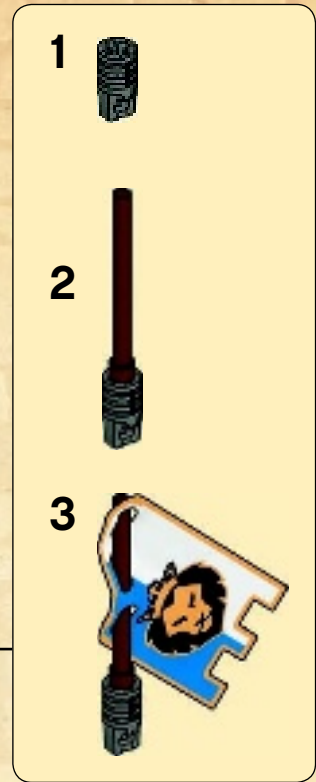
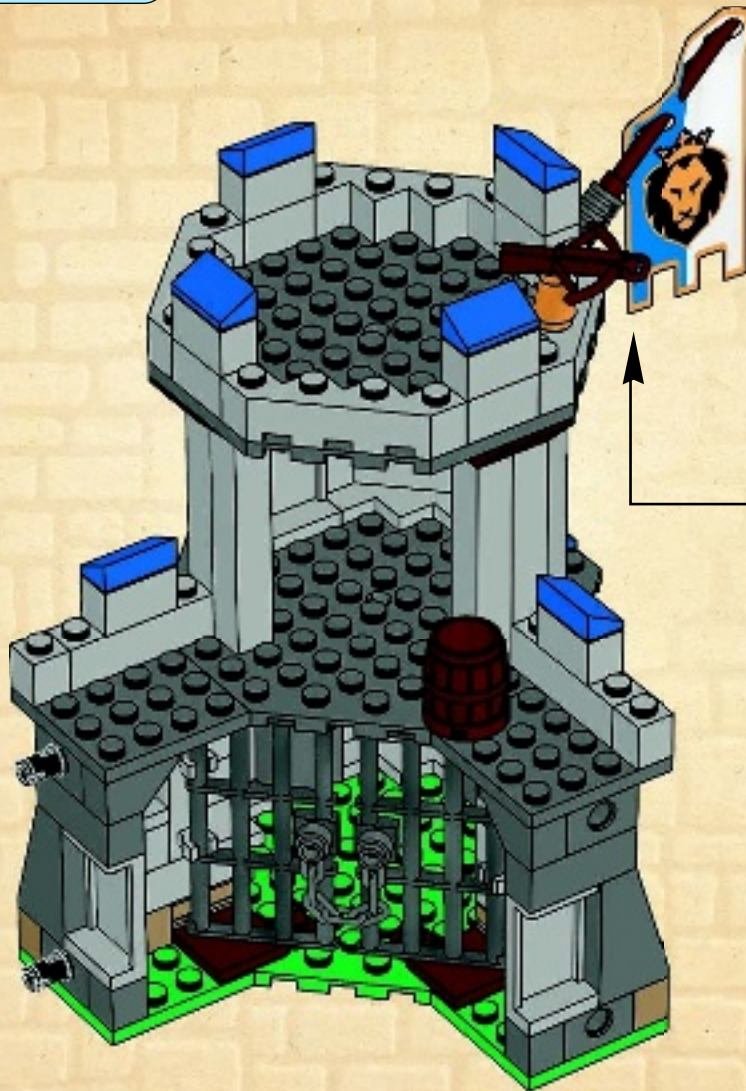



38

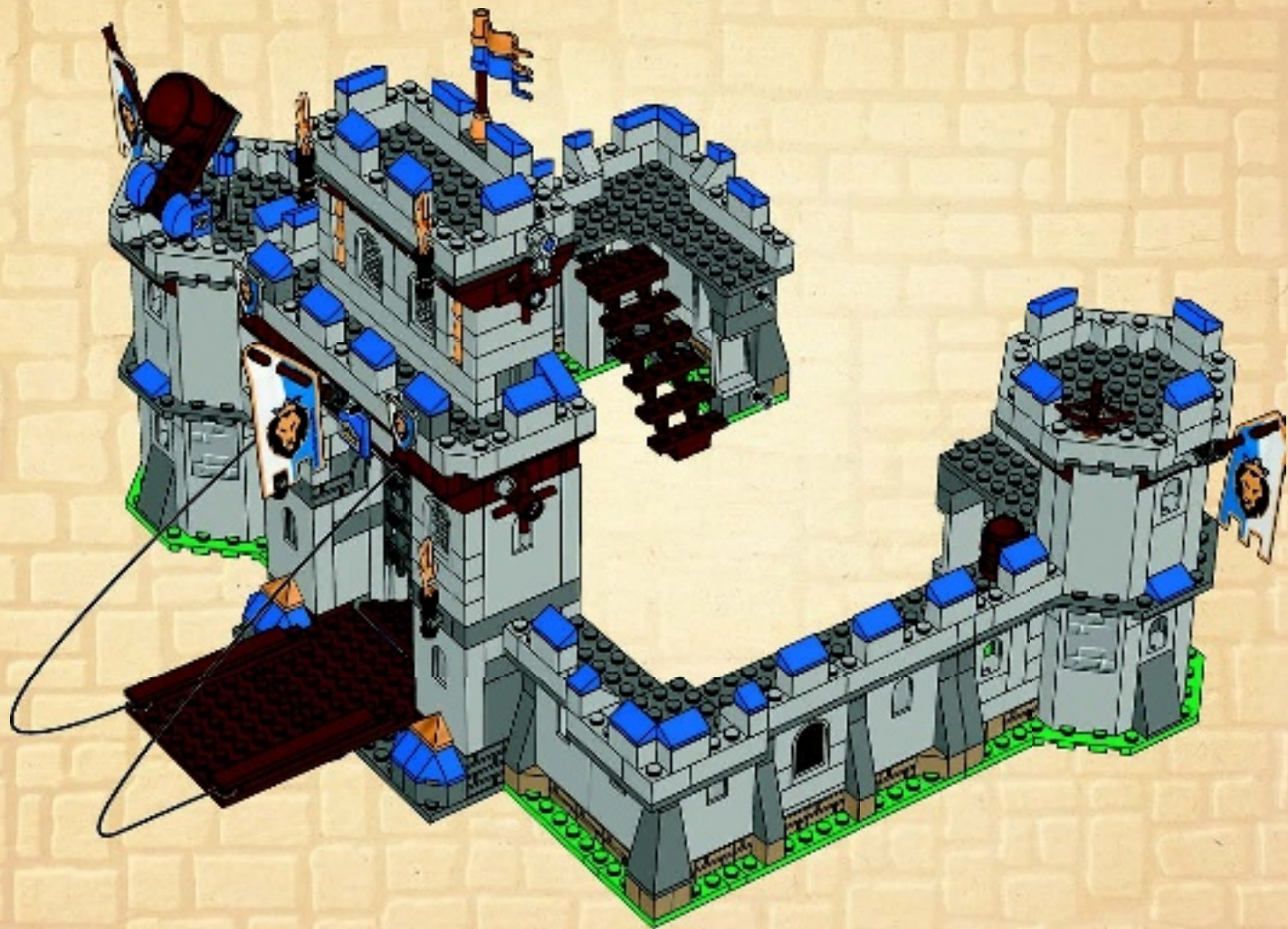

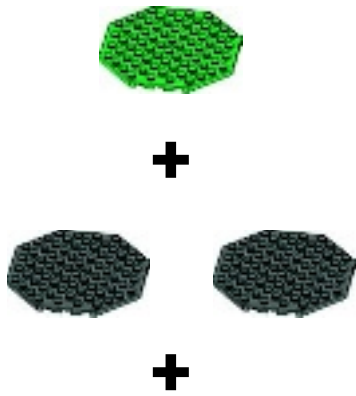

1



2

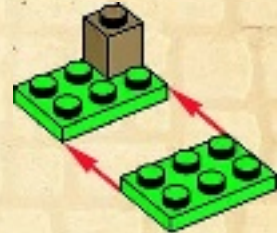

3





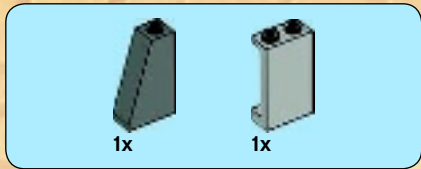

4

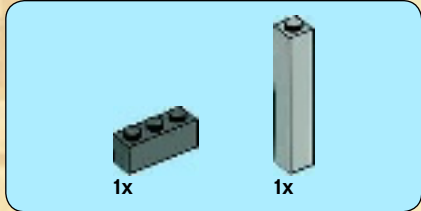

5



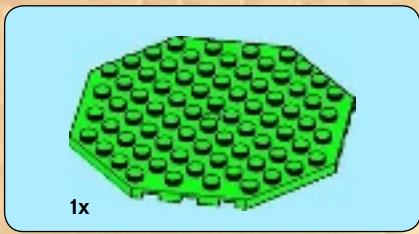

6

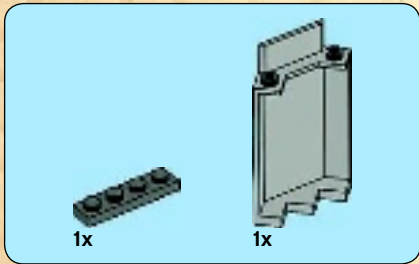
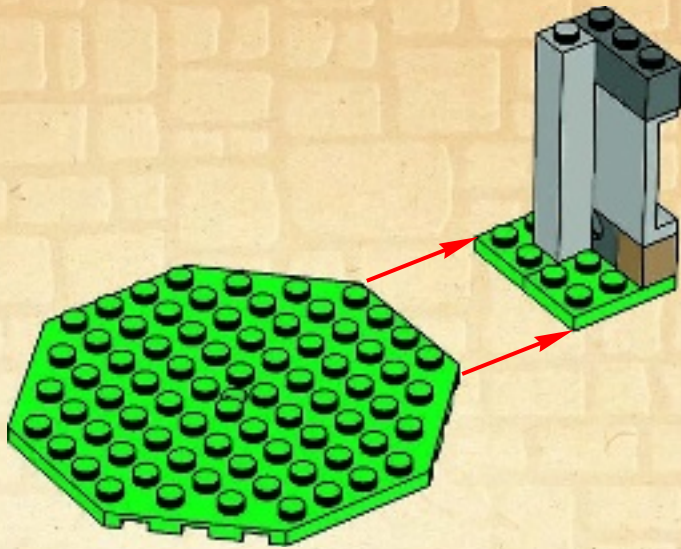

7

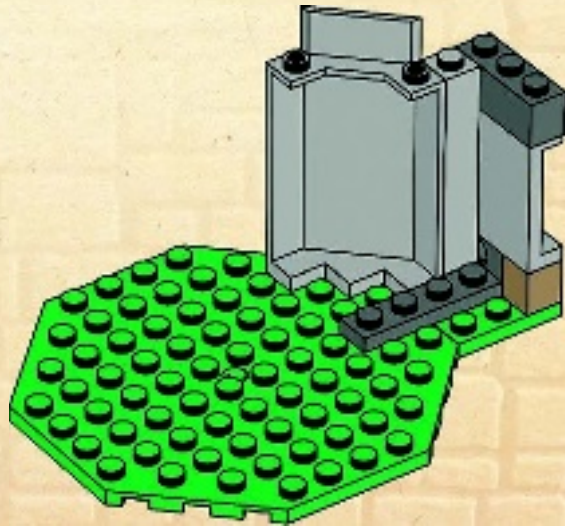



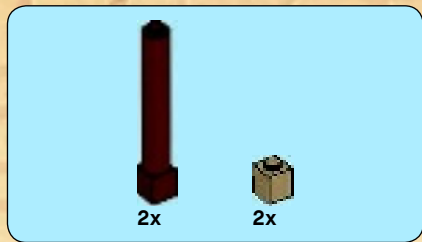

8

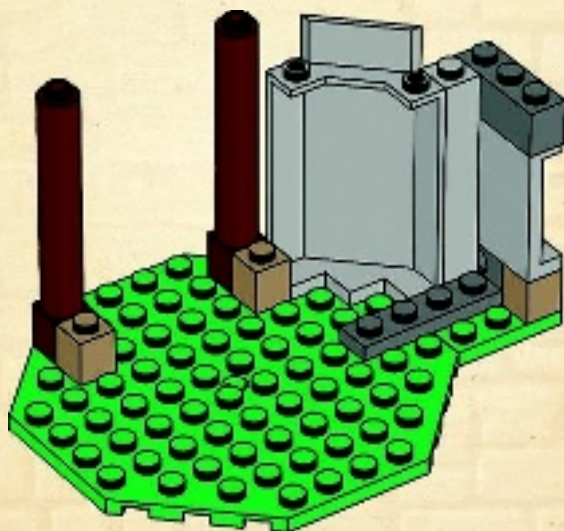

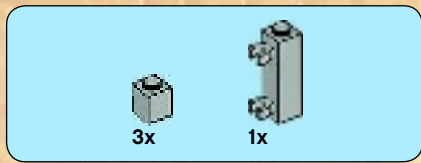

9

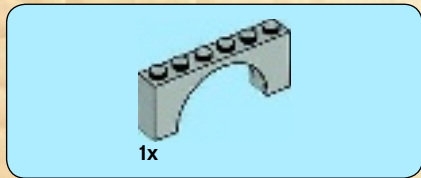
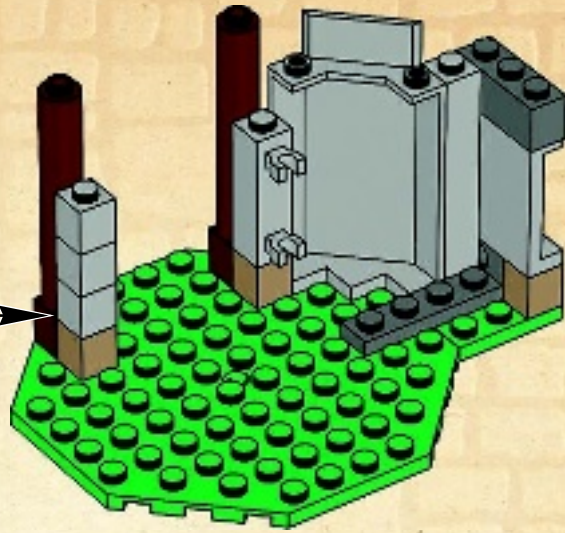
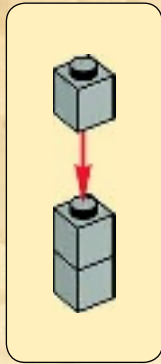

10

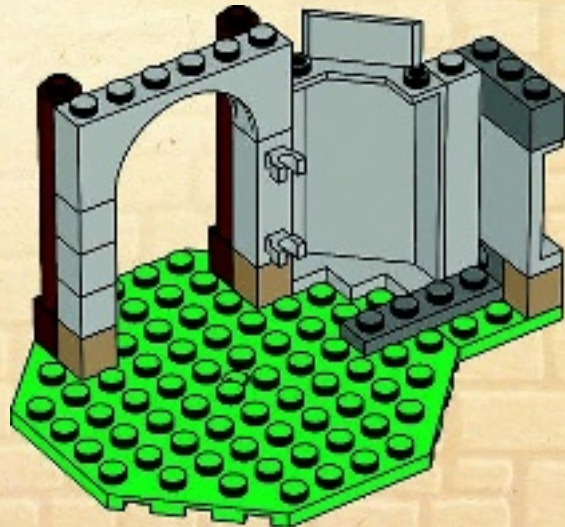





11

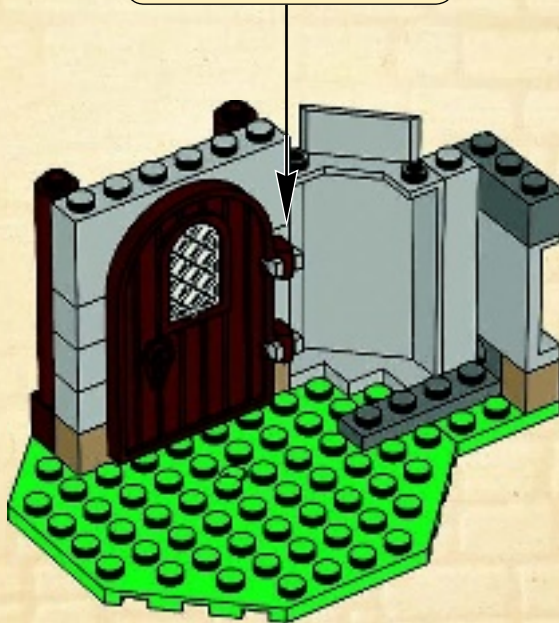
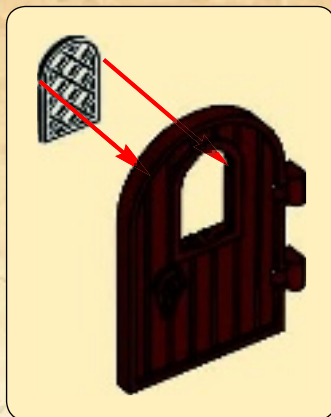



1x

12

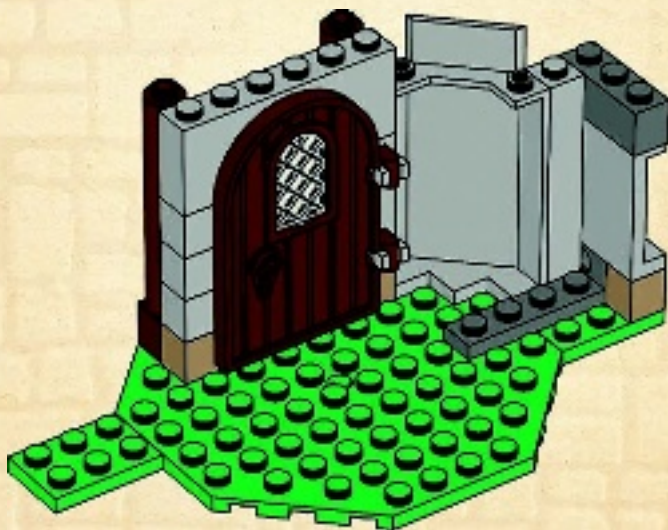



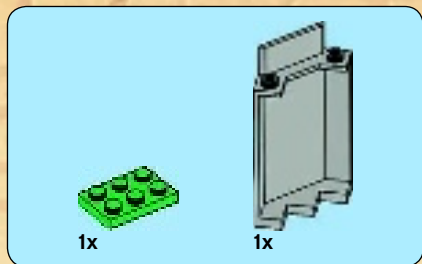

13

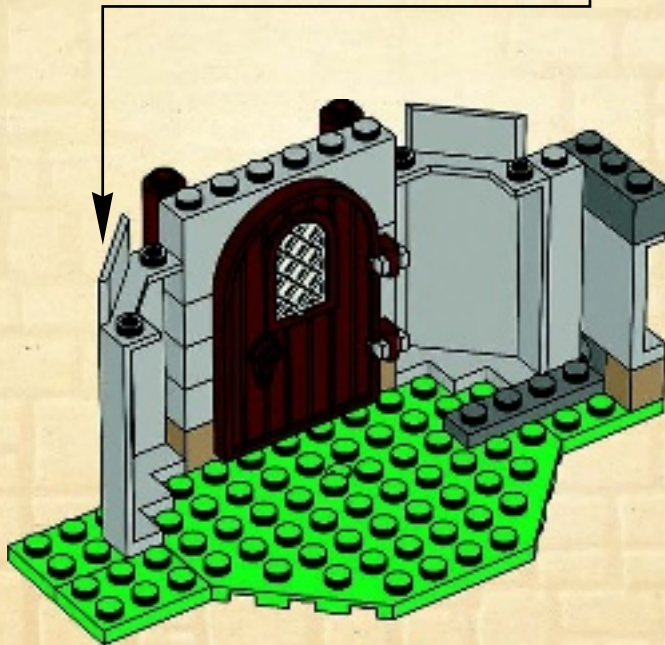
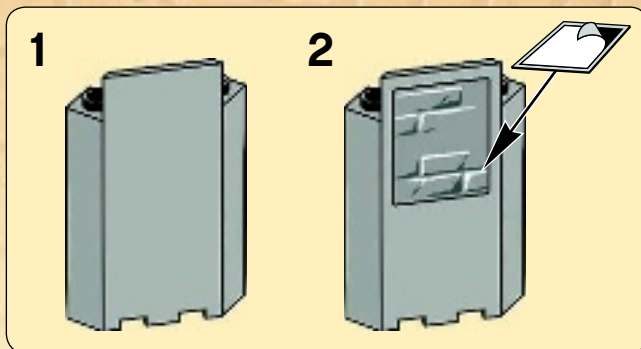

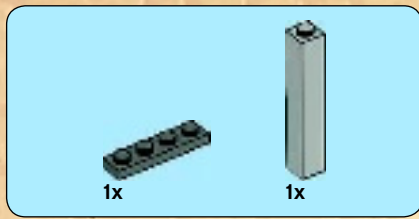

14

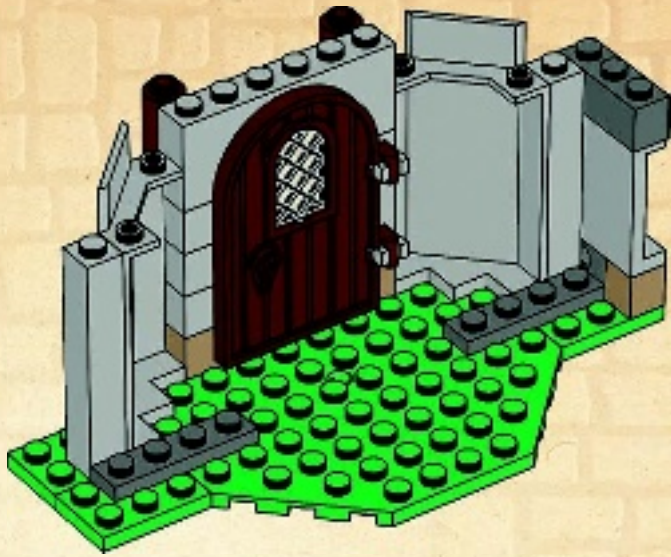

15

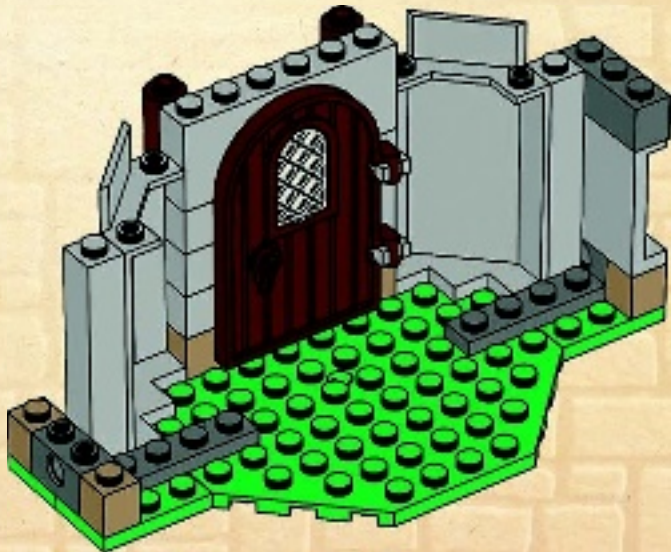



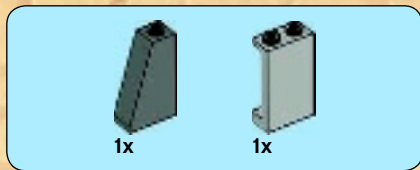

16

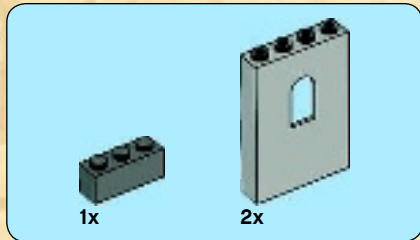
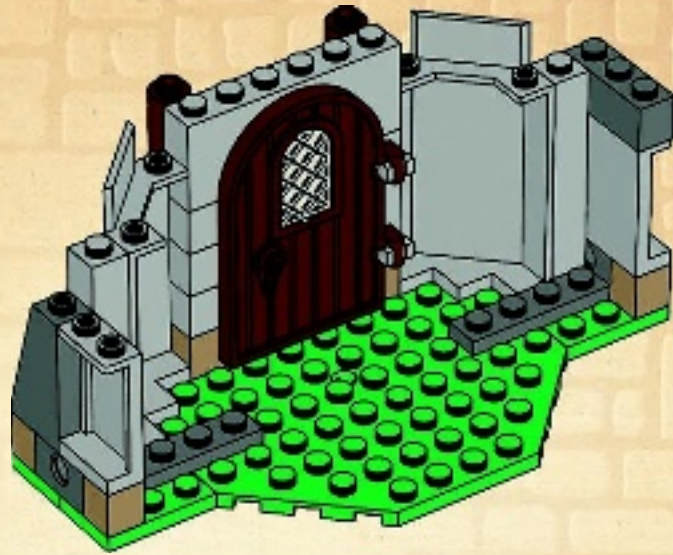

17

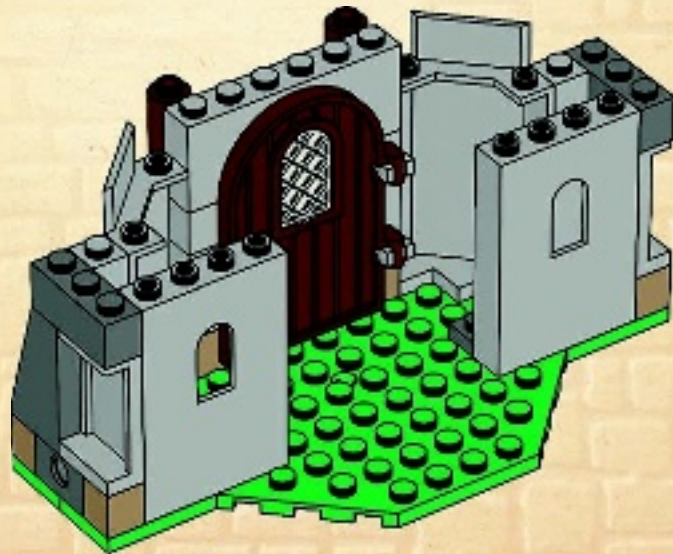



2x



2x

18

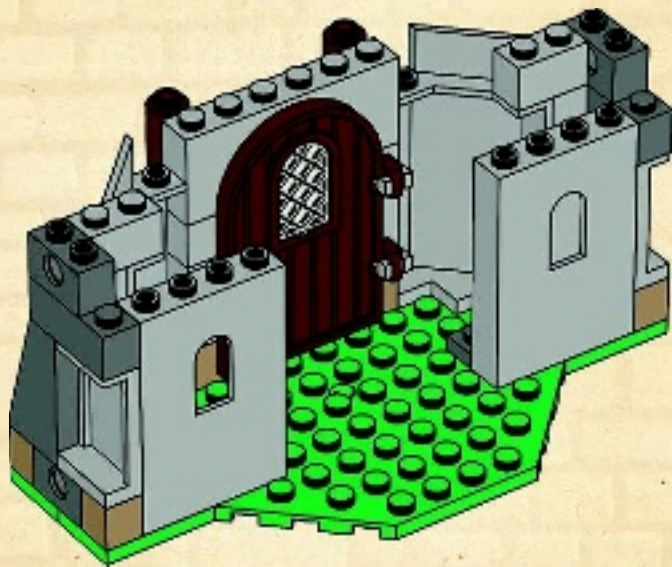





2x



2x

# 19



4x



2x

# 20

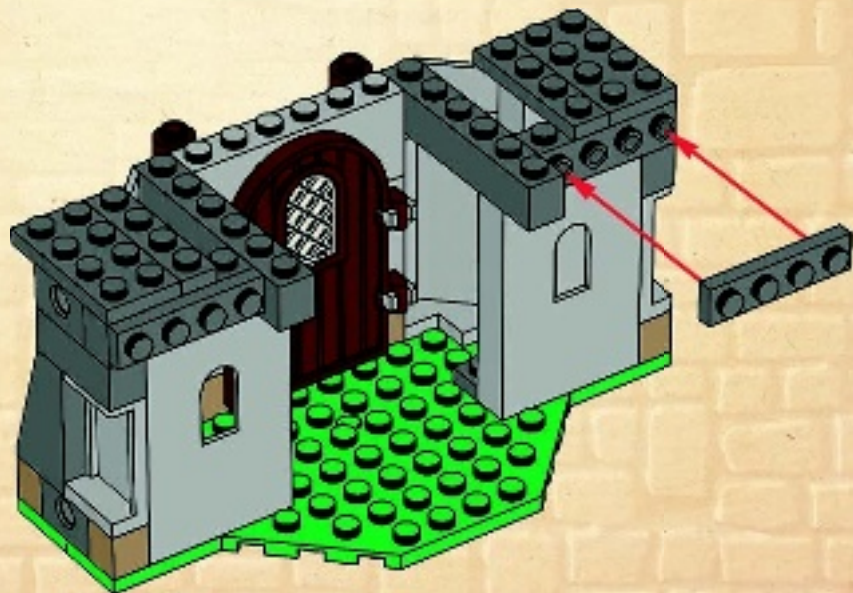

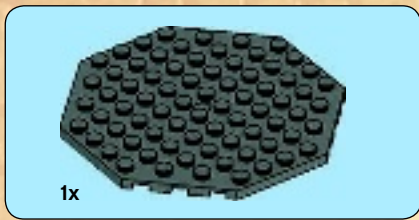

21

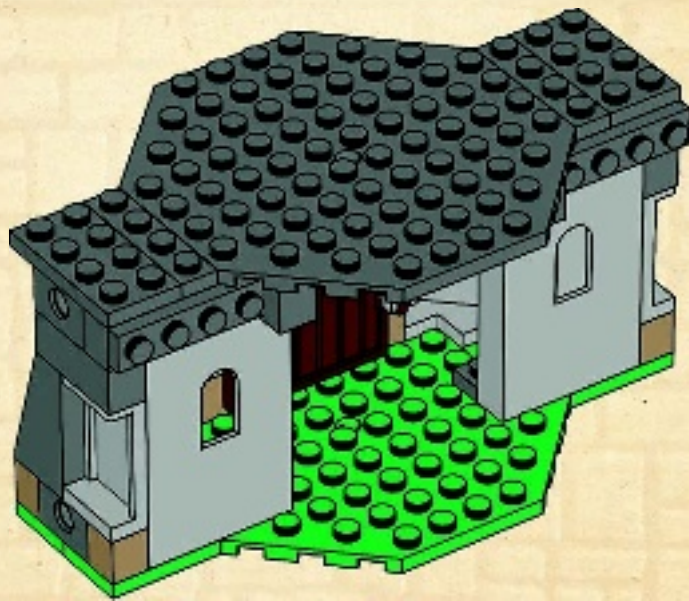





2x



1x

22

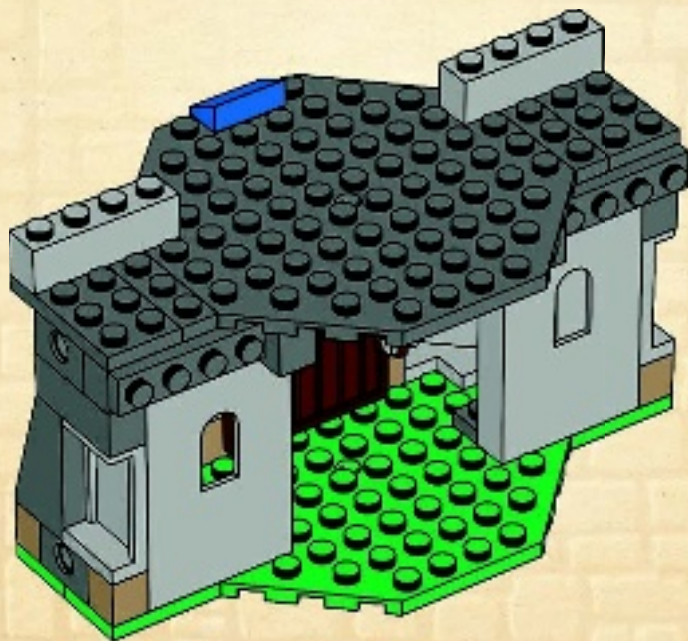



2x



2x

# 23



2x

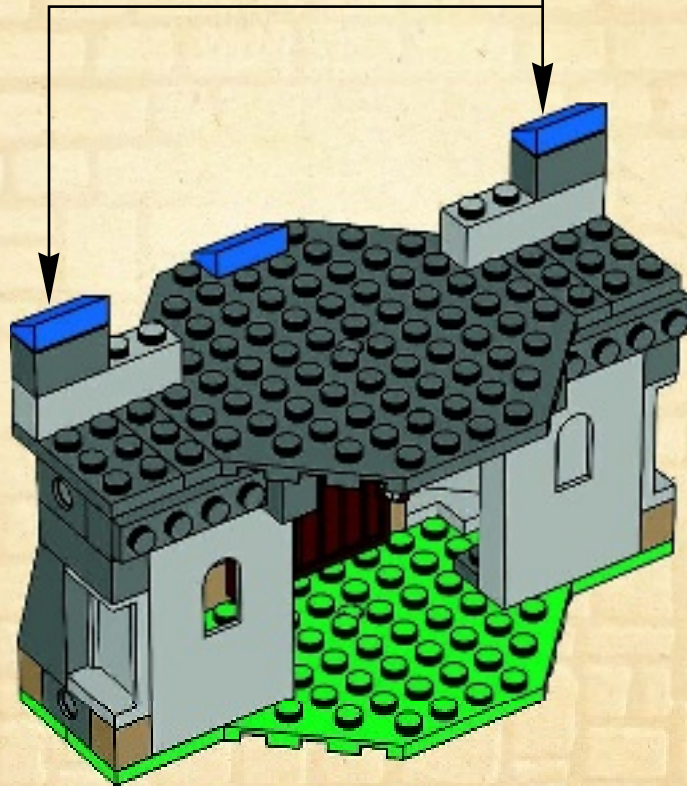





2x



2x

# 24

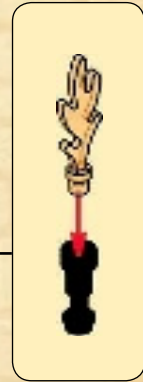
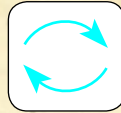

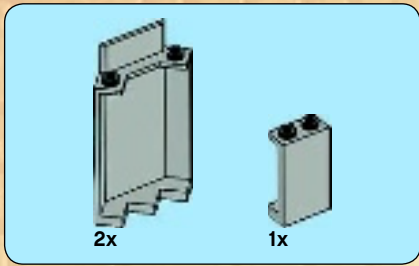

25

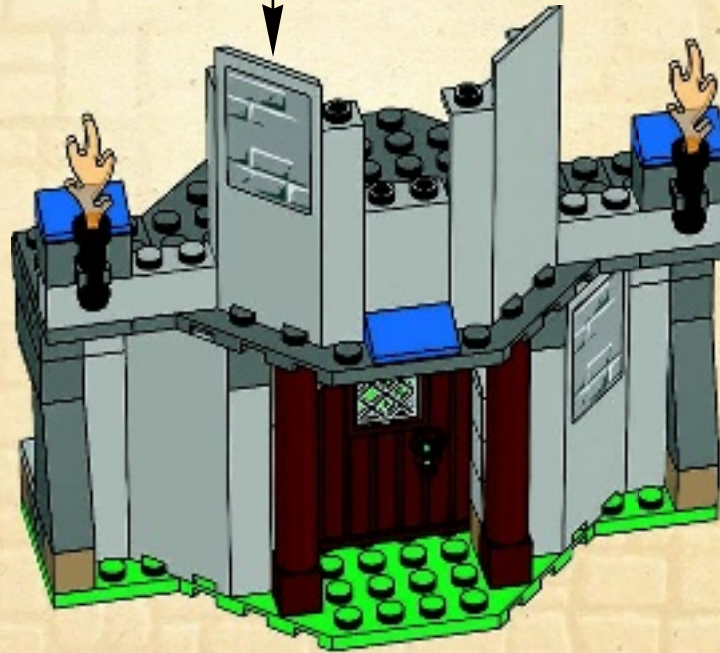
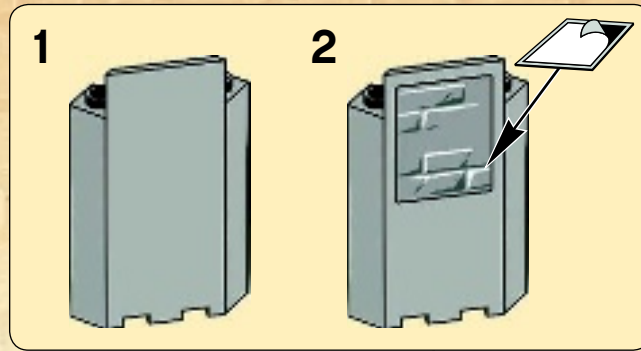



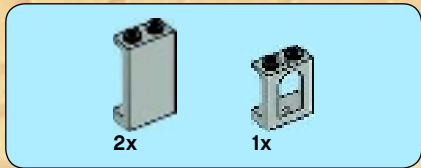

26

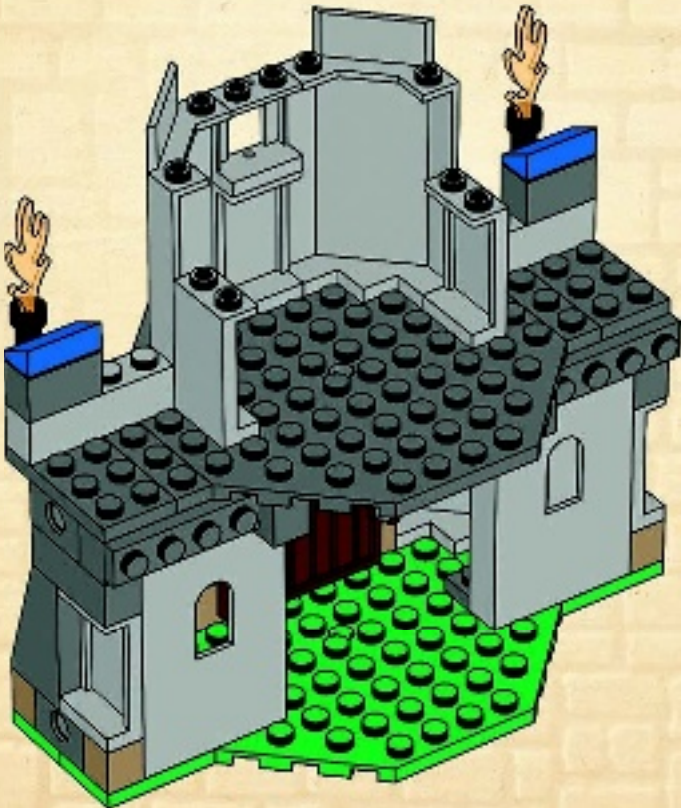



2x



2x

27







6x

28



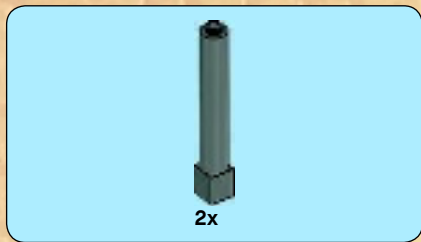

29







1x

1



4x

2



2x



2x

3

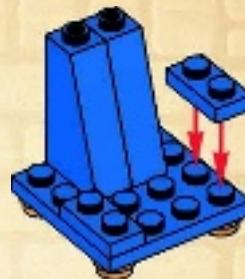
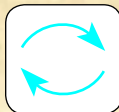

1x



2x



2x

4



30

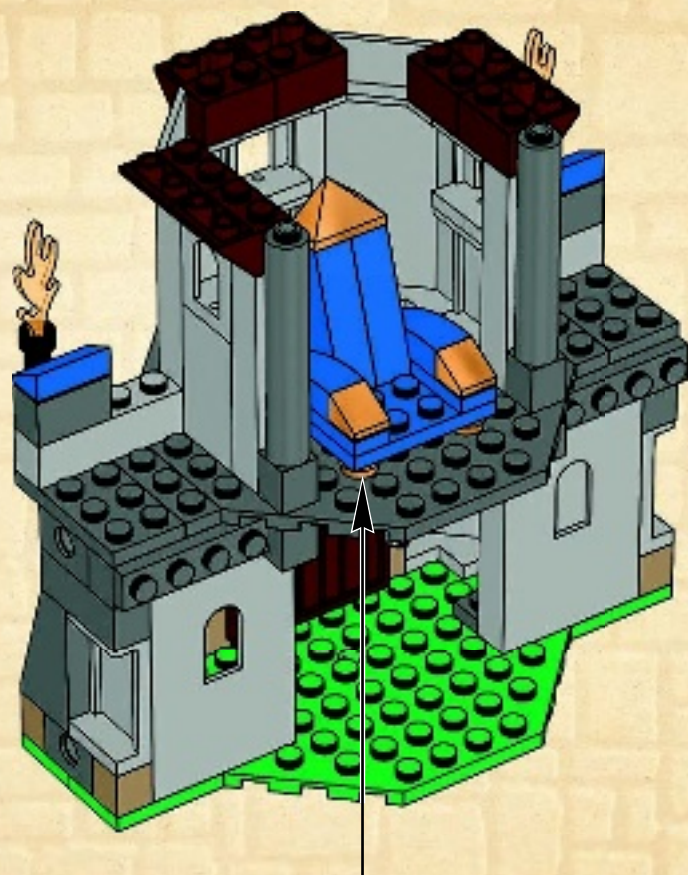





31



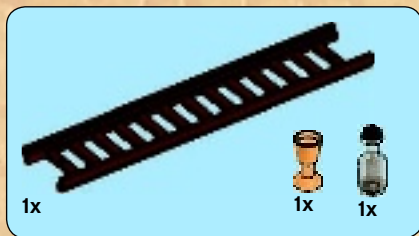

32







+



1x

33



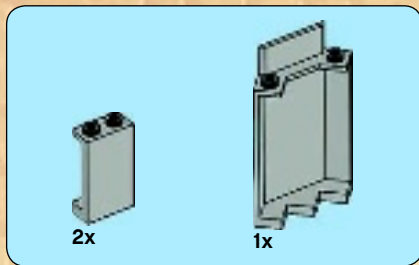

34





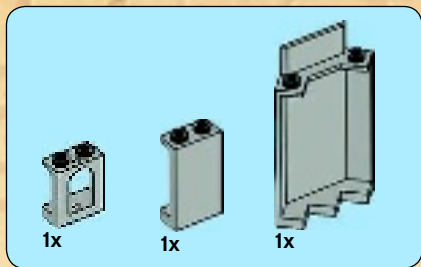

35

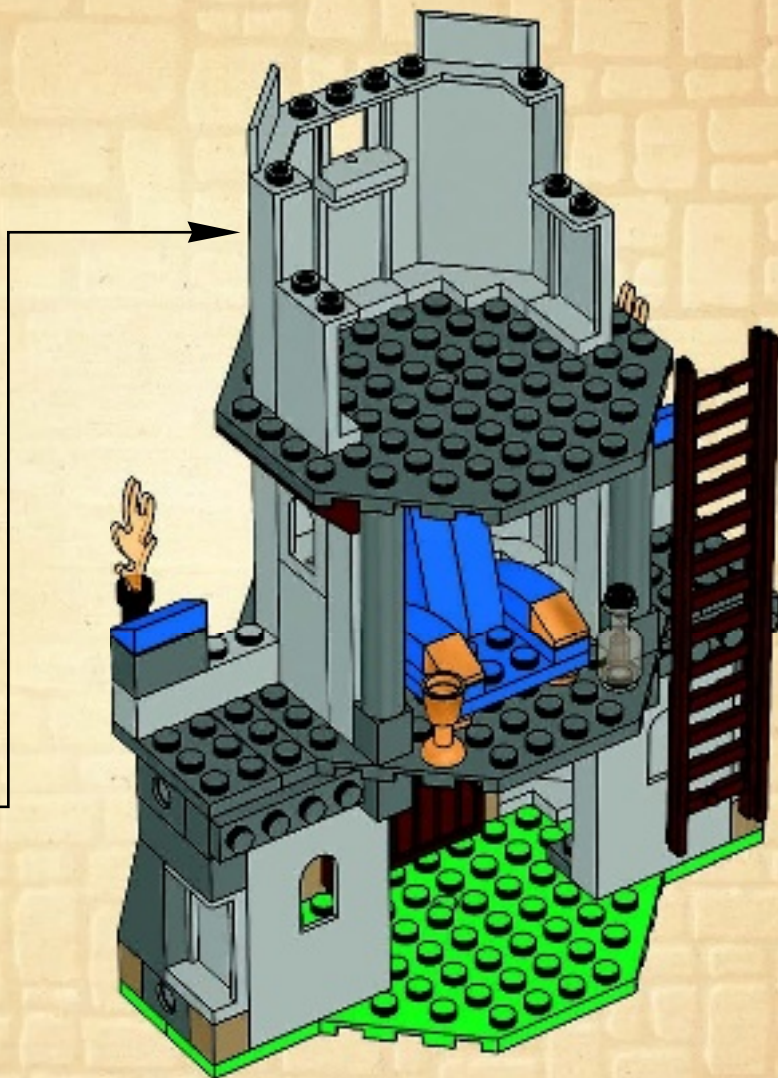
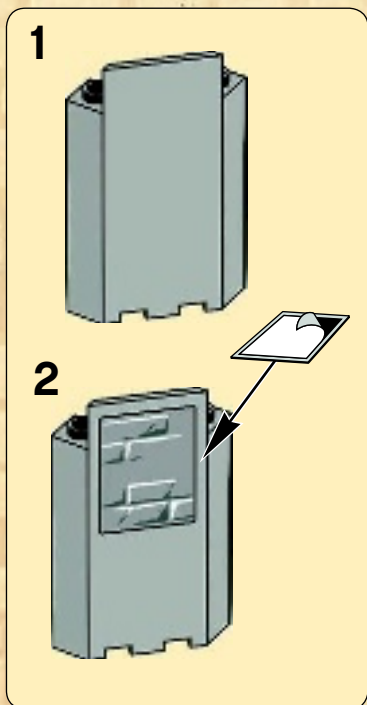



2x

36

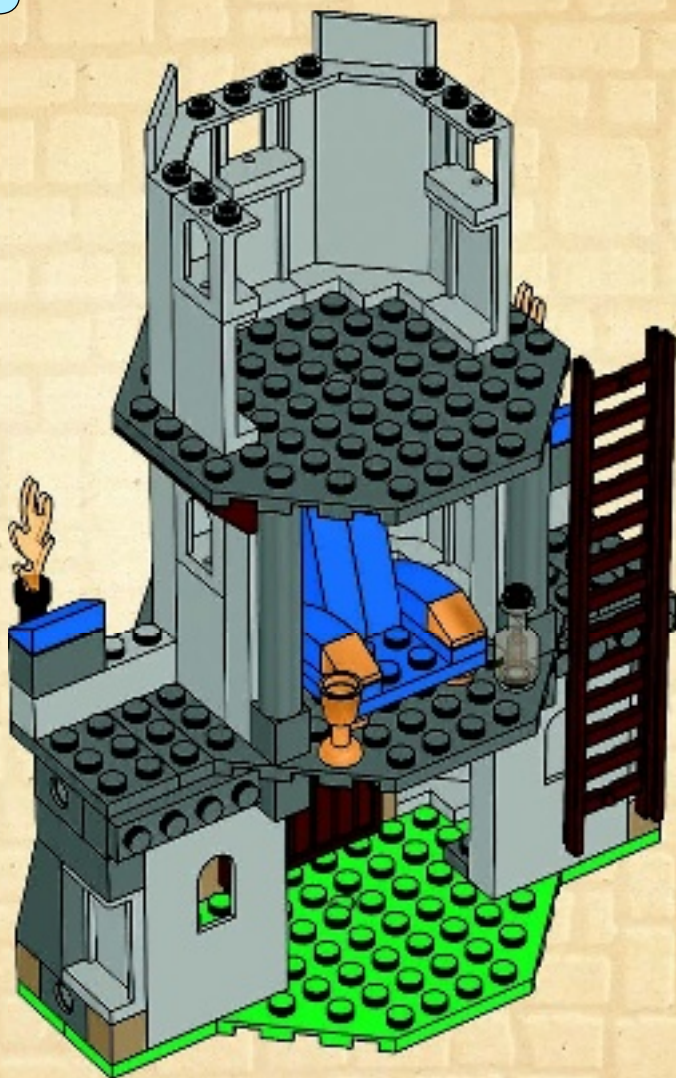



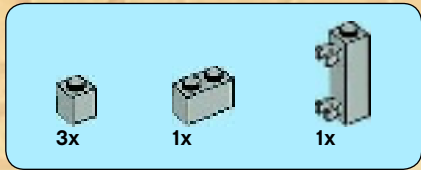

37

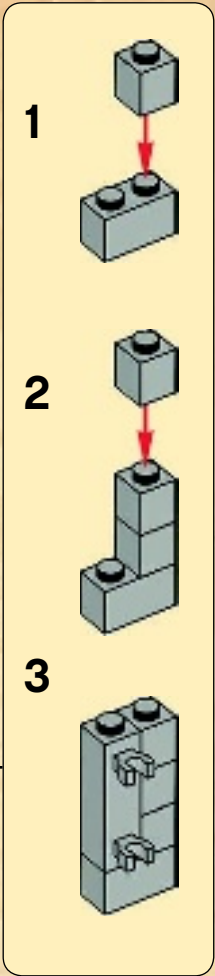
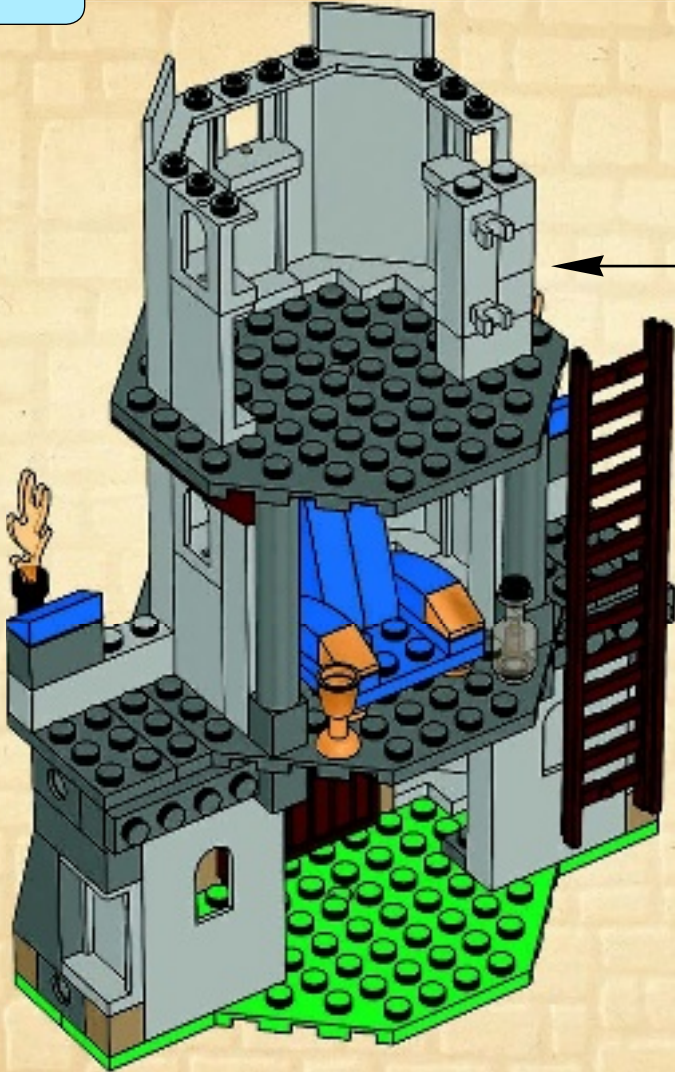



4x

38

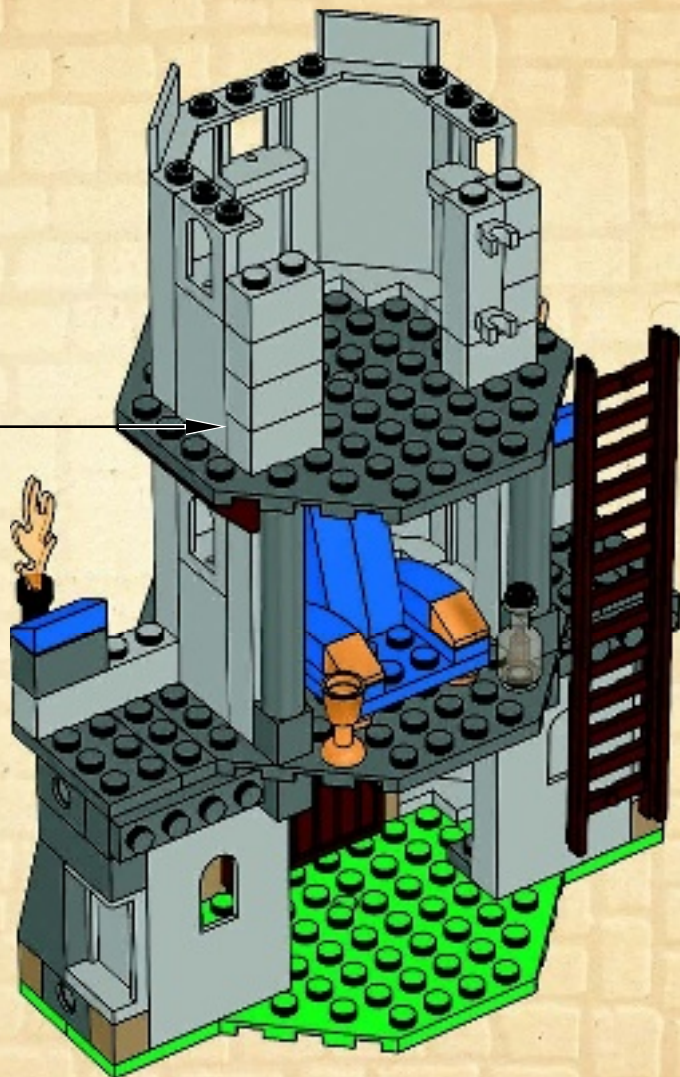
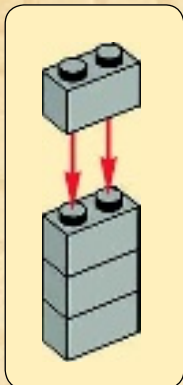





2x



1x

39

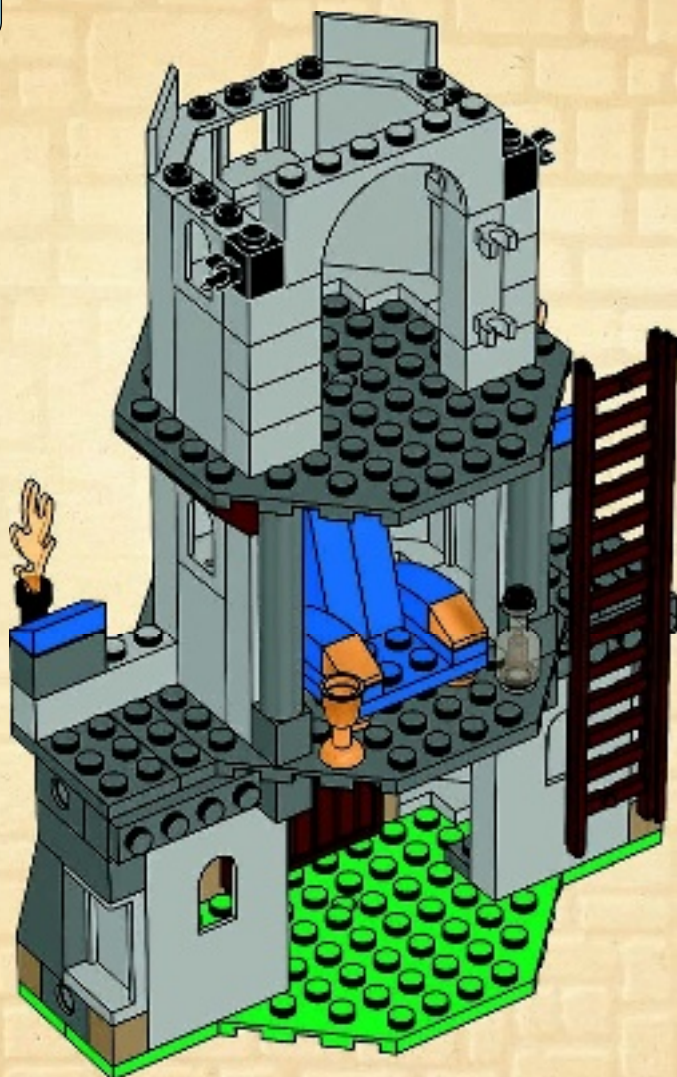



6x

40

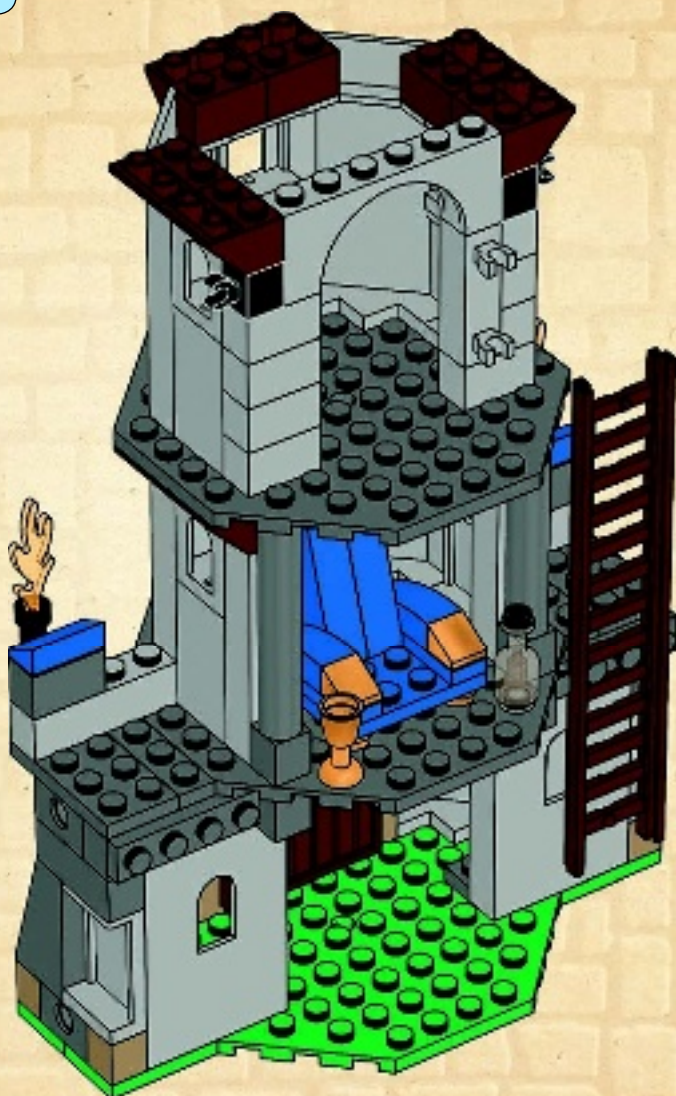





2x

41

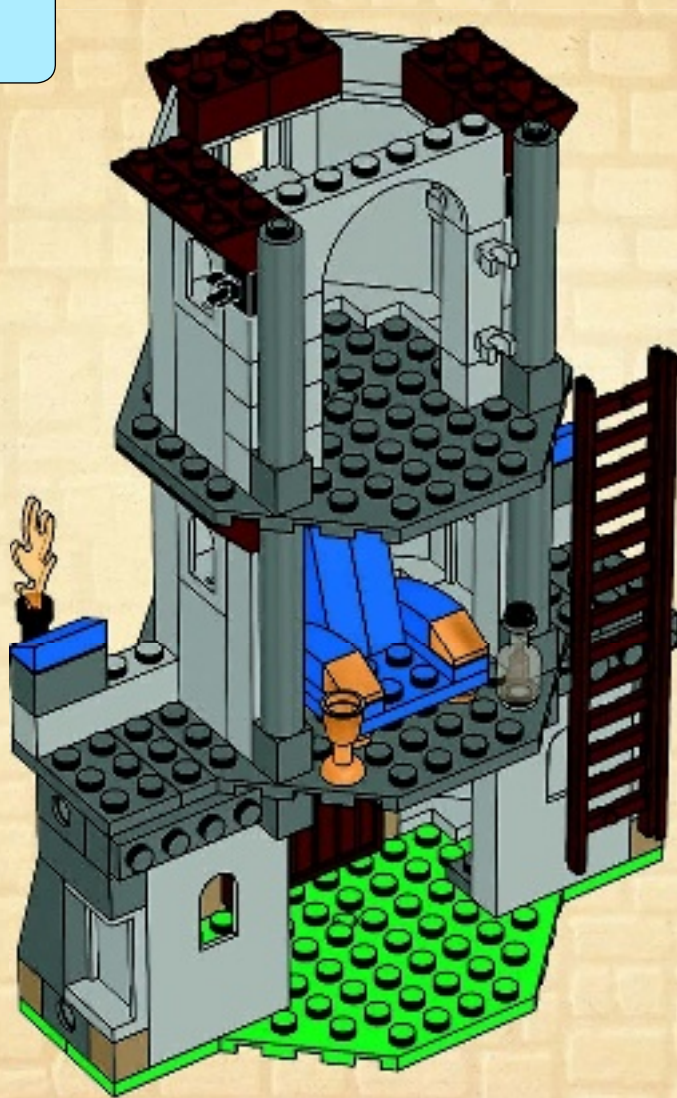



42

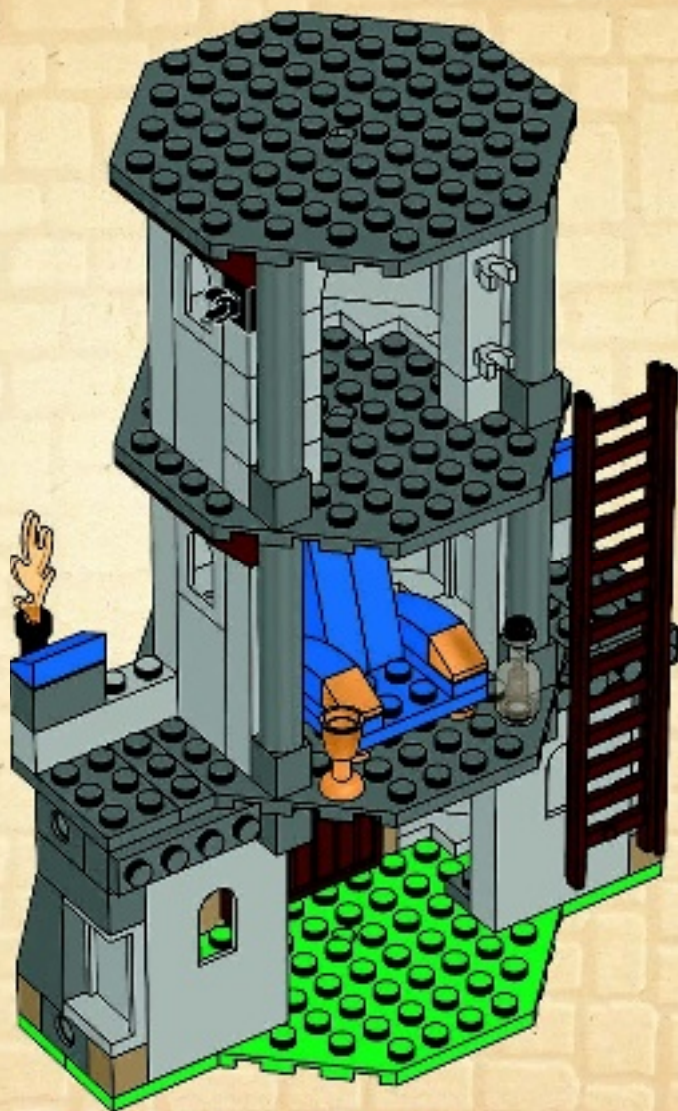





43

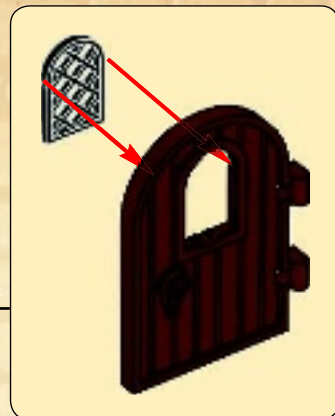
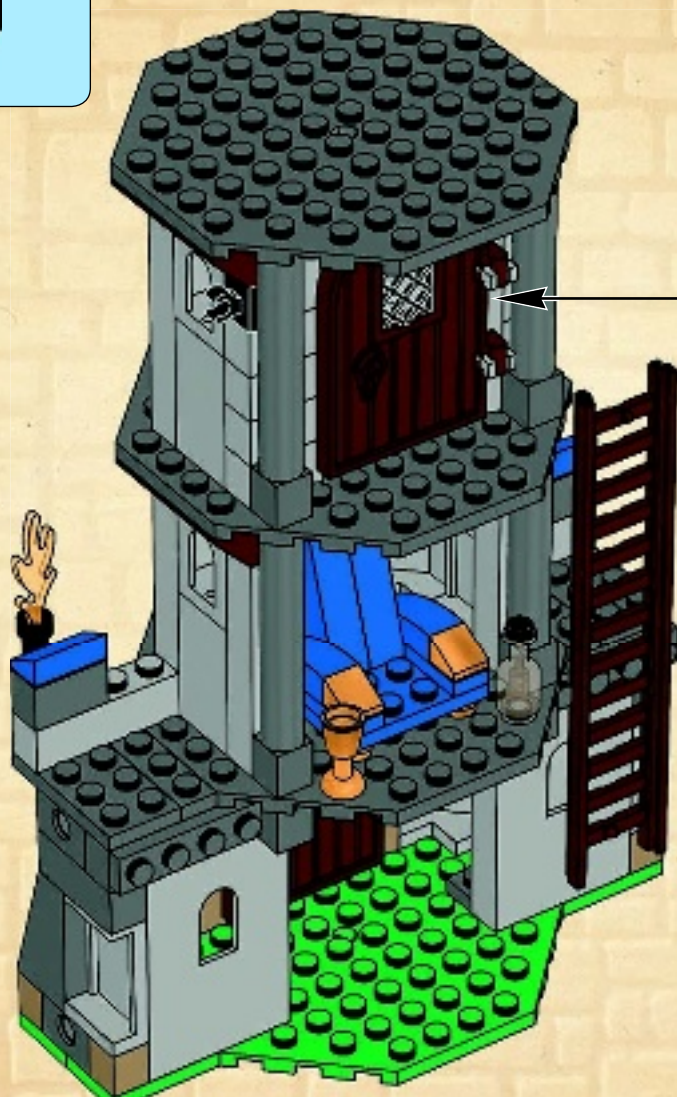



1x



2x

44

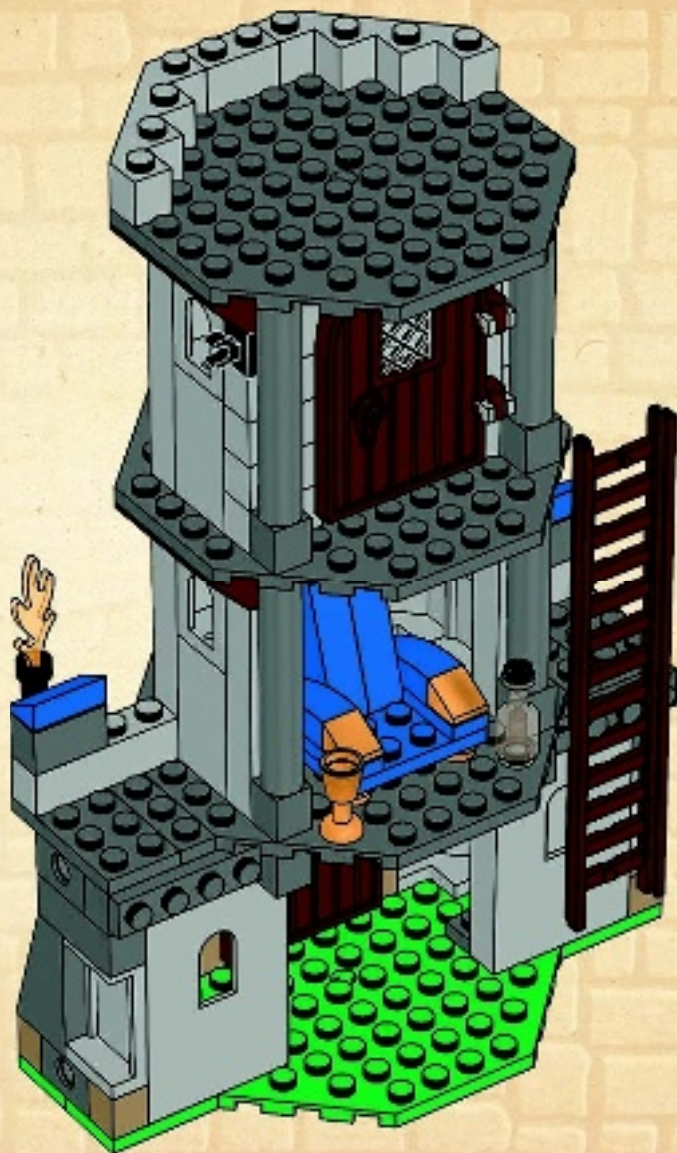





3x



2x

45

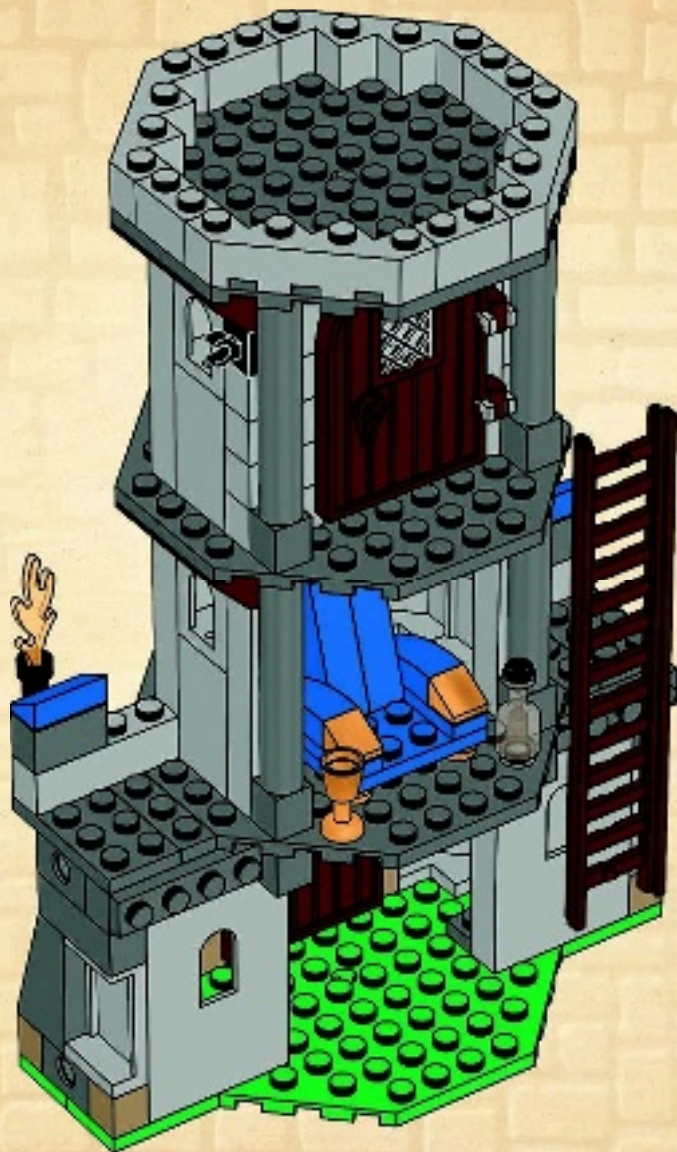



8x

46

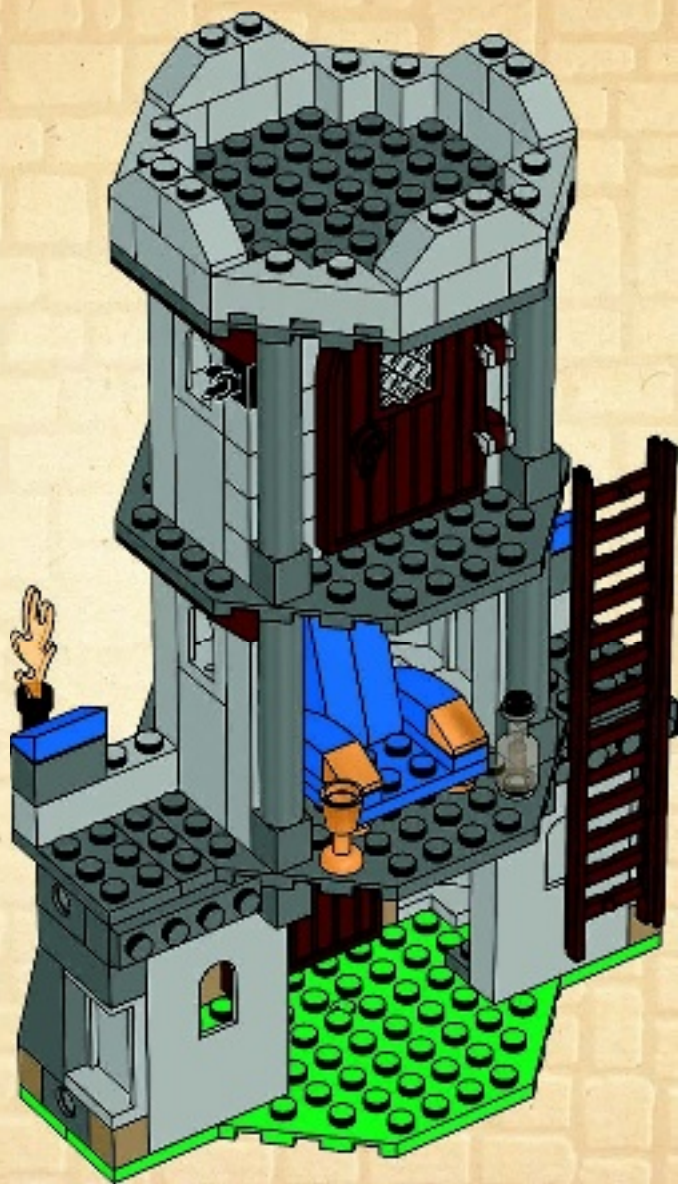





4x

47

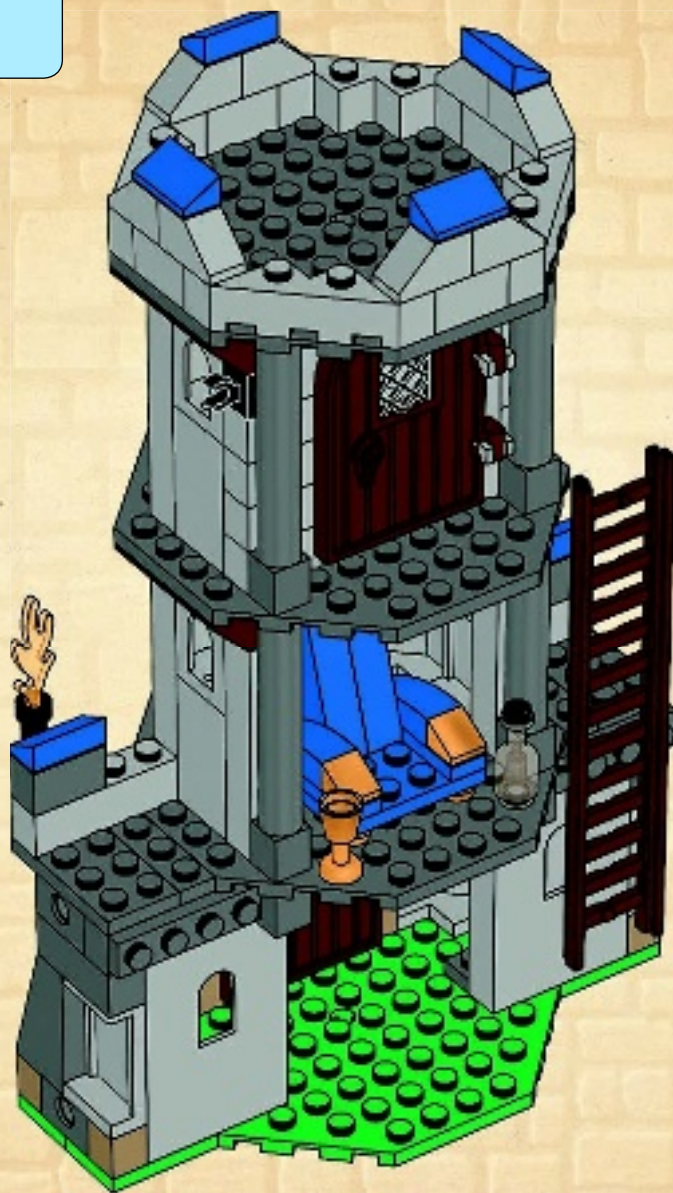



48

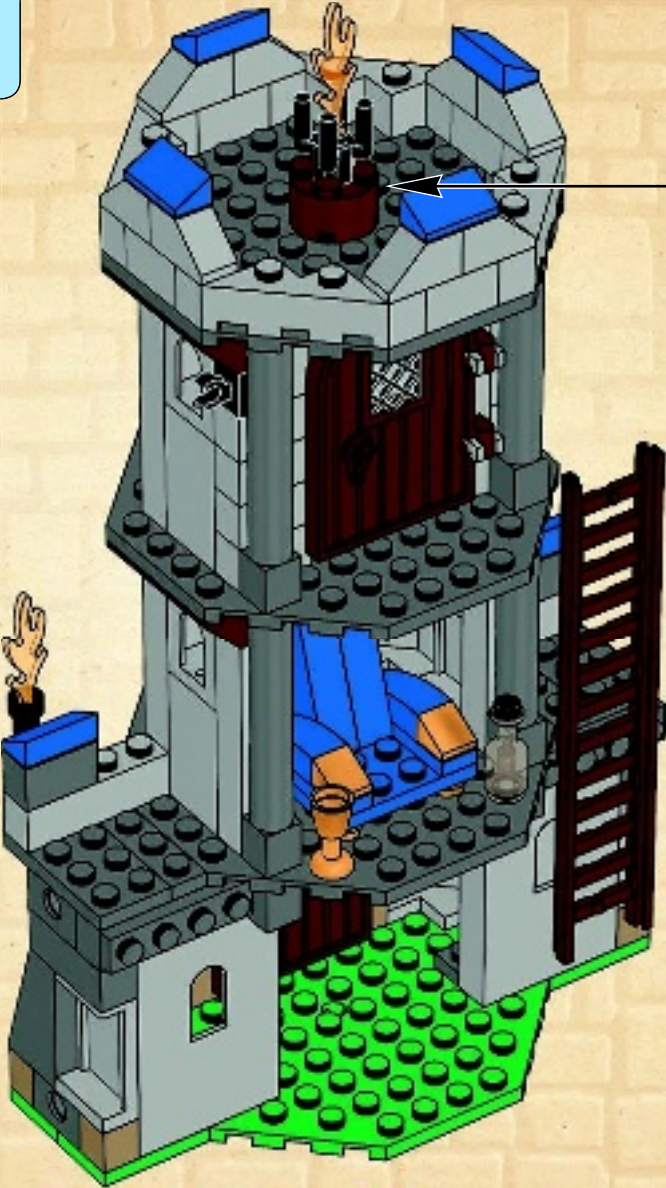





1x

49

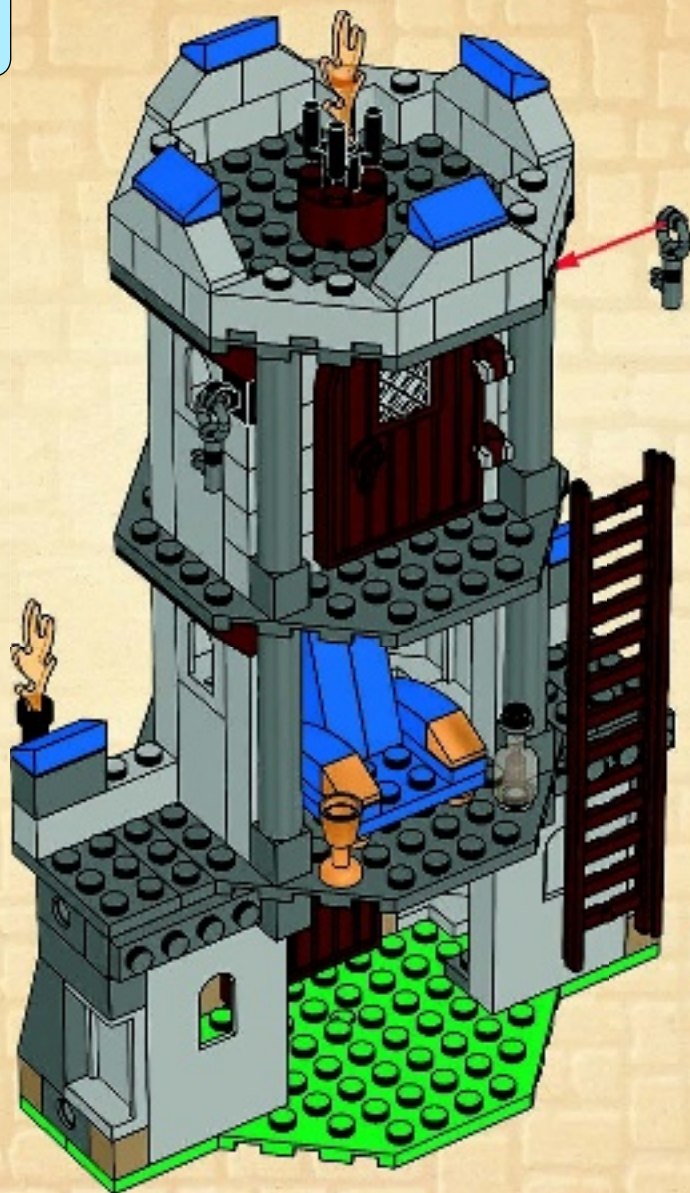

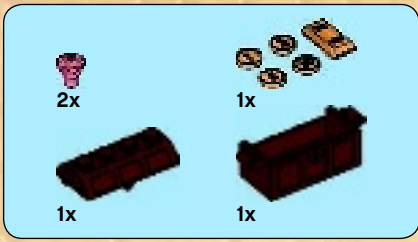

50

1

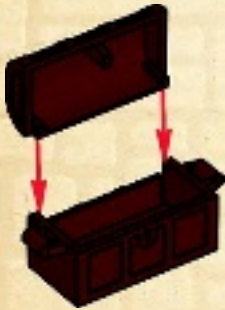

2



3





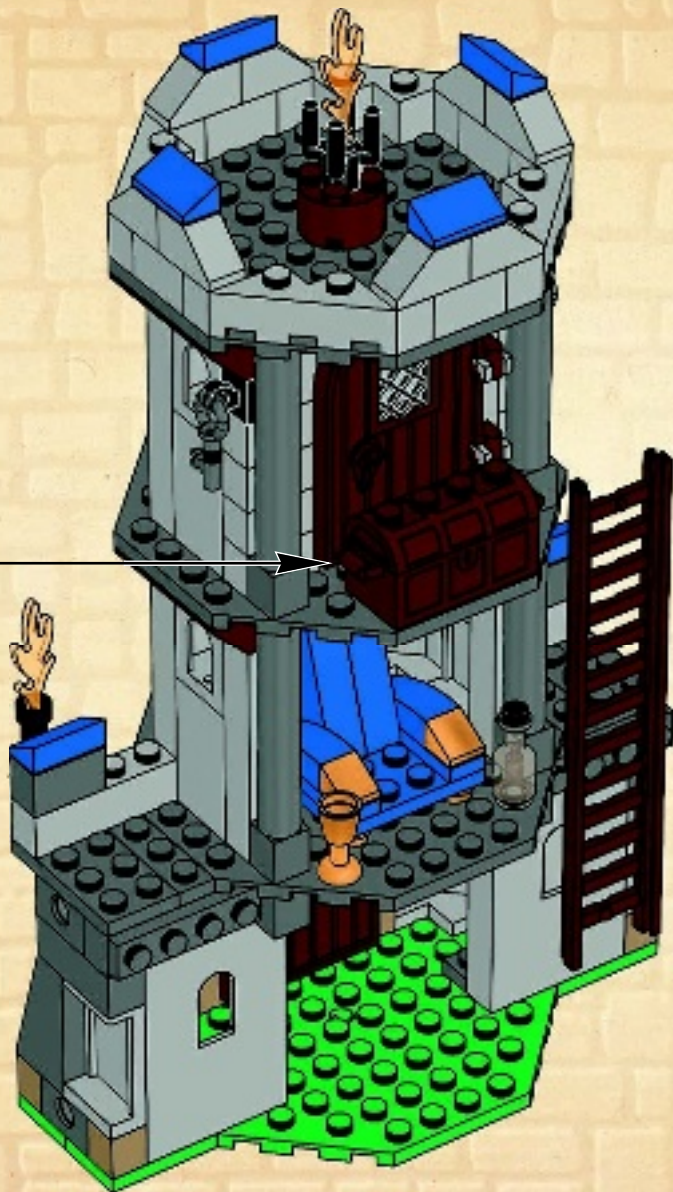



51

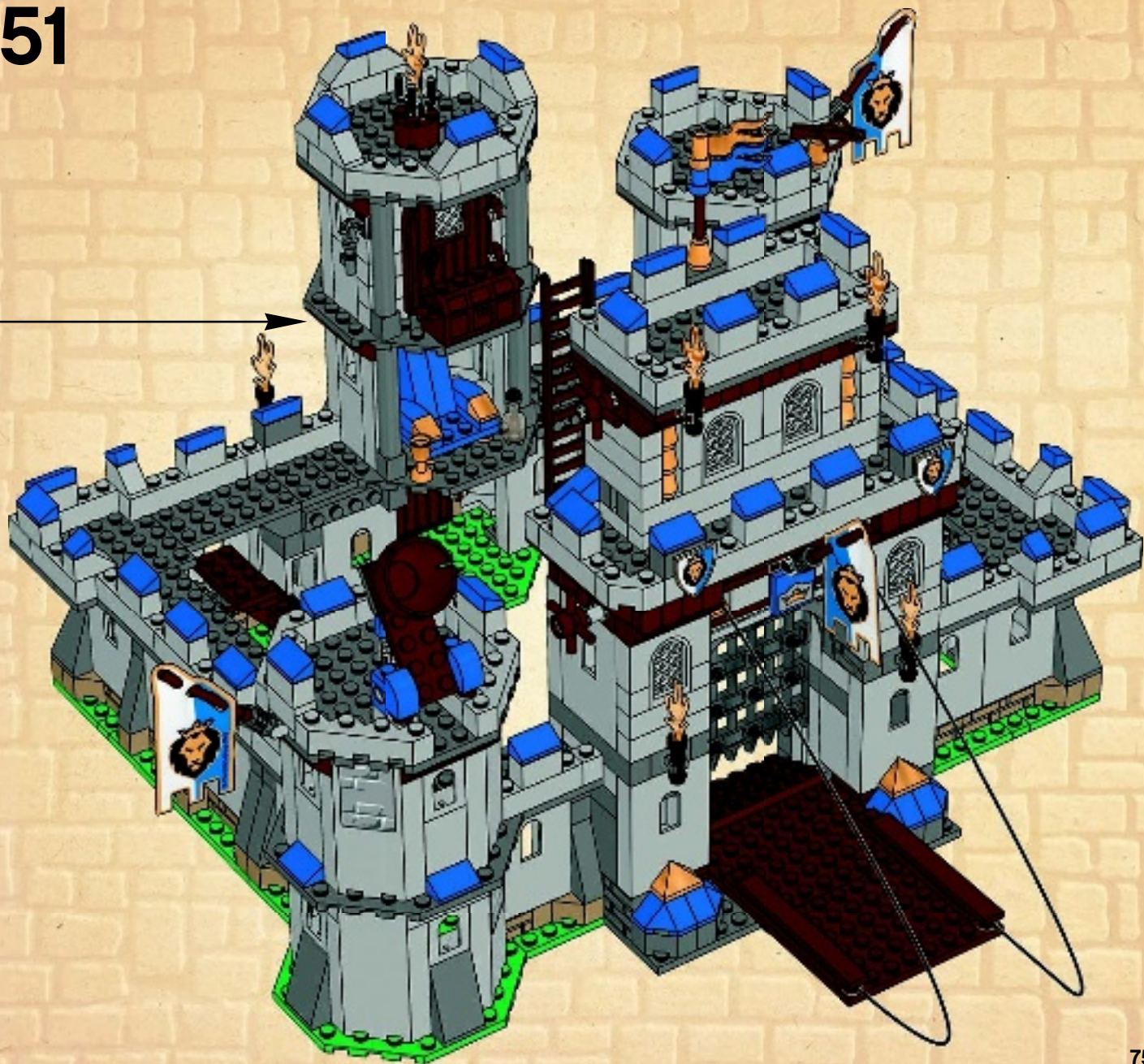







Disney THE  
**LONE RANGER**



**LEGO.com/TheLoneRanger**





**LEGO**

DC UNIVERSE

# SUPERHEROES



POI

[LEGO.COM/SUPERHEROES](http://LEGO.COM/SUPERHEROES)

WB SHIELD: TM & © Warner Bros. Entertainment Inc.  
(s13)

DC Comics: TM & © DC Comics.











# club™

## Free\*! Gratuit!

\* Paid subscription in Australia and New Zealand.  
Abonnement payant en Australie et Nouvelle-Zélande



© 2013 The LEGO Group.



# LEGO.com/club



1x  
4631857



1x  
300401



1x  
302301



4x  
614101



1x  
6036454



3x  
4125554



2x  
4114306



2x  
4162465



2x  
4205105



1x  
6039694



1x  
4666579



1x  
300321



3x  
6019155



8x  
4504379



2x  
4603263



1x  
4613174



1x  
302221



1x  
303421

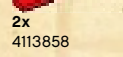

2x  
4113858



4x  
403221



1x  
449521



1x  
4540552



2x  
613421



1x  
4186678



2x  
4189131



2x  
4119014



4x  
4504380



47x  
4651236



2x  
4121925



2x  
428623



4x  
6035354



2x  
4189123



2x  
4543998



2x  
302323

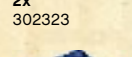

1x  
4243815



4x  
306823



1x  
416223



1x  
4593757



1x  
6034719



1x  
6039833



2x  
4496366



2x  
393723



1x  
4107797



2x  
4206482



1x  
6039681



1x  
4261572



1x  
6038470



1x  
6038471



1x  
6038472



1x  
4651218



1x  
4610938



2x  
4519010



4x  
4535765



3x  
4233487



1x  
4118624



2x  
265326

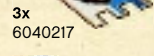

3x  
6040217



4x  
4121966



2x  
302326



1x  
302126



2x  
4550017



1x  
4515340



1x  
281726



2x  
4183060



1x  
4180087



6x  
3004626

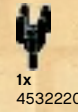

1x  
4532220



1x  
4636201



1x  
4140303



2x  
6039766



1x  
9339



2x  
6039761



1x  
6039762



1x  
4650900



1x  
4226000



1x  
6037506



1x  
6039890



13x  
4121715



3x  
370526



1x  
4600437



2x  
6037557



1x  
4297719



1x  
384926



1x  
4234438



1x  
6023257



4x  
302128



4x  
371028



6x  
4243821



2x  
4116671



3x  
4583684



2x  
4279059



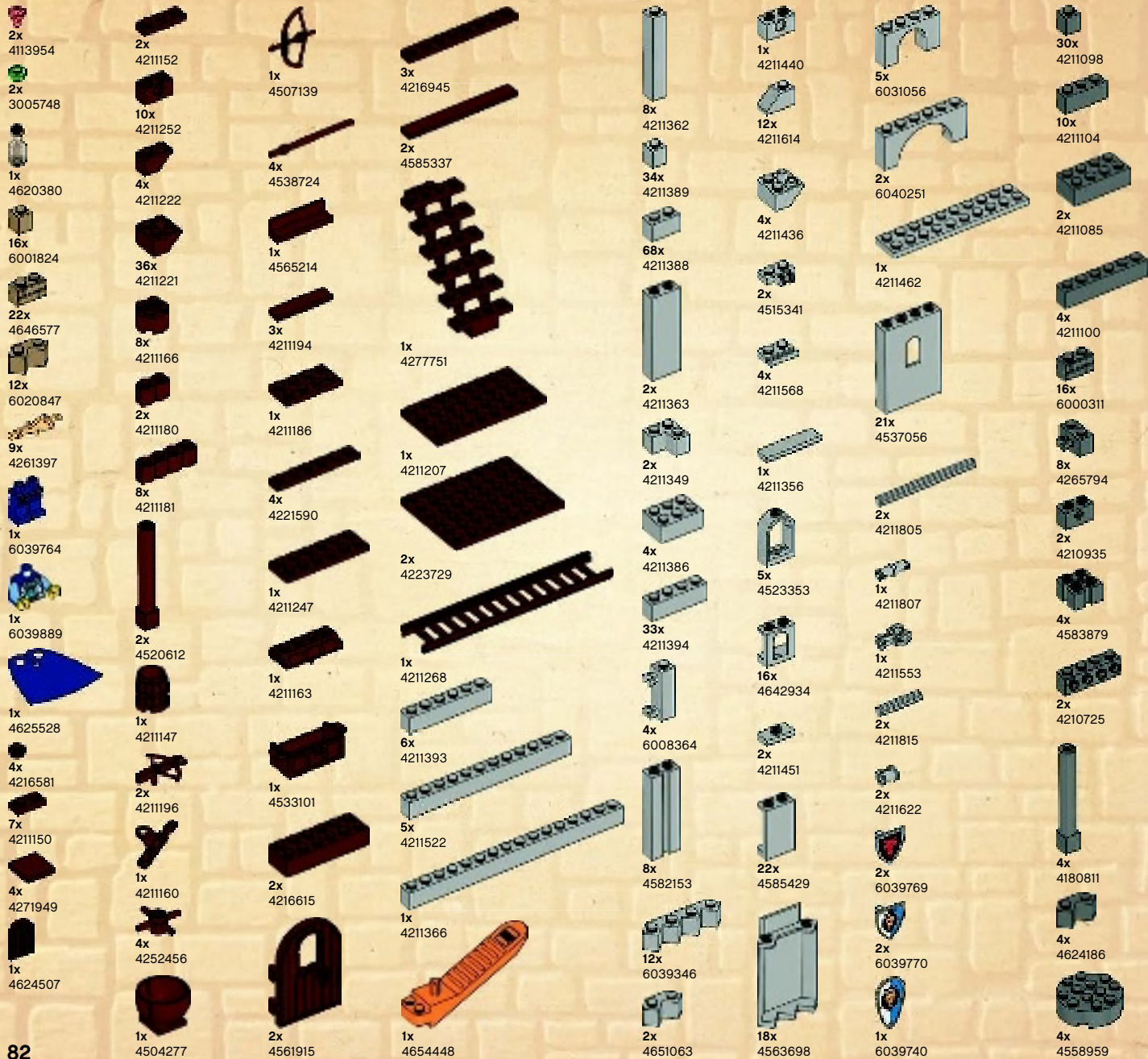





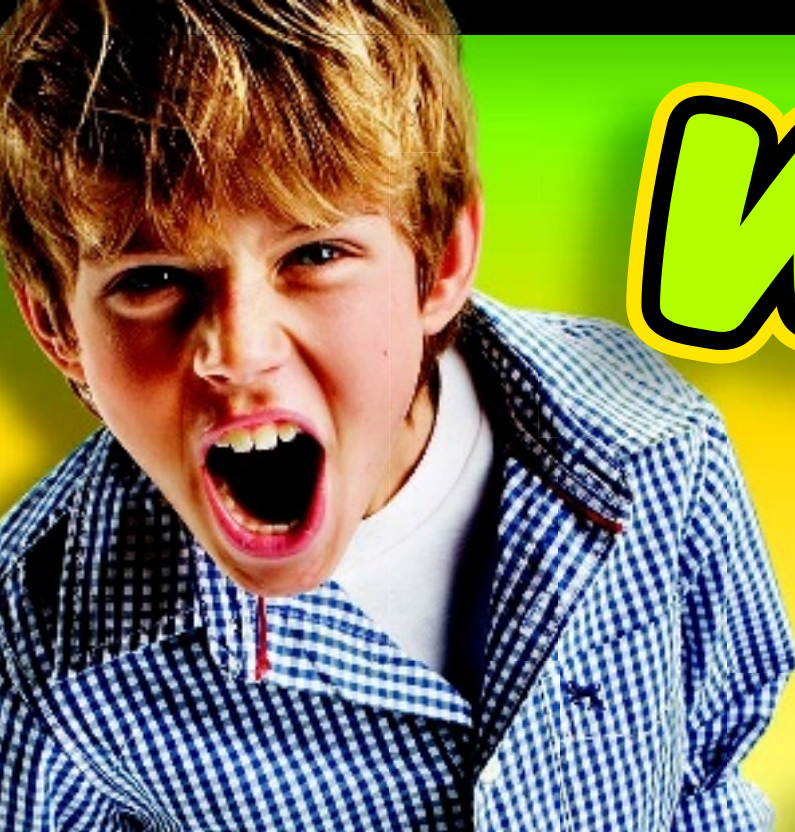

# WIN!

Go to [www.LEGOsurvey.com/product](http://www.LEGOsurvey.com/product) to fill out a survey for a chance to win a cool LEGO® Product.

No purchase necessary.

Open to all residents where not prohibited.



LEGO.com



## [www.LEGOsurvey.com/product](http://www.LEGOsurvey.com/product)

### GEWINNE! WIN!

Nimm an der Umfrage auf [www.LEGOsurvey.com/product](http://www.LEGOsurvey.com/product) teil und hab die Chance ein cooles LEGO® Produkt zu gewinnen!

Die Teilnahme am Gewinnspiel führt zu keinerlei Kaufverpflichtungen. Teilnahme in allen nicht ausgeschlossenen Ländern möglich.

Ga naar [www.LEGOsurvey.com/product](http://www.LEGOsurvey.com/product), vul een enquêteformulier in en maak kans op een cool LEGO® product.

Geen aankoopverplichting. Iedereen mag deelnemen, uitgezonderd ingezetenden van landen waar een enquêteverbod geldt.

### GAGNE! 当てよう!

Visite [www.LEGOsurvey.com/product](http://www.LEGOsurvey.com/product) pour répondre à un questionnaire et avoir une chance de gagner un produit LEGO® très cool!

Aucune obligation d'achat. Ouvert à tous les résidents des pays autorisés.

[www.LEGOsurvey.com/product](http://www.LEGOsurvey.com/product) にアクセスして、アンケートにご記入ください。当選者にはレゴ®製品を差し上げます。

お買い上げの必要はありません。

禁止されていない限り、すべての皆様にご利用いただけます。