



Castle



70402





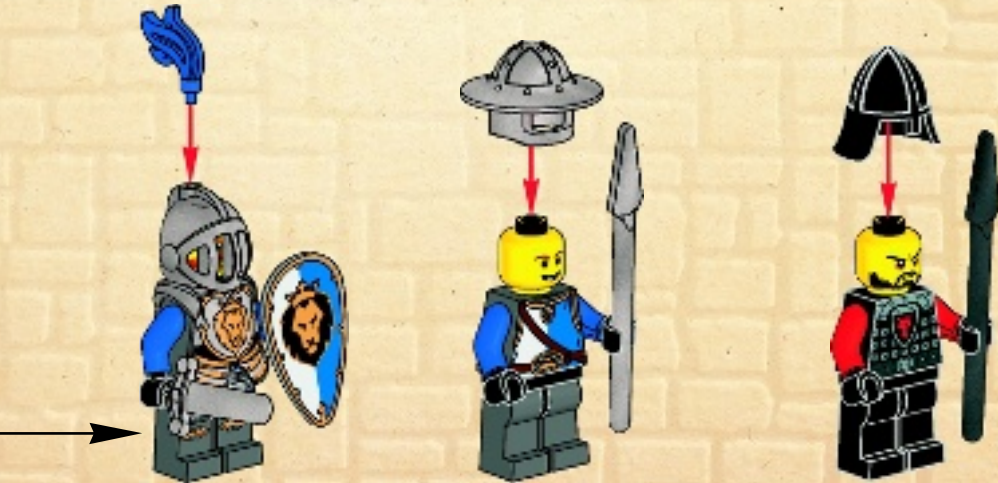
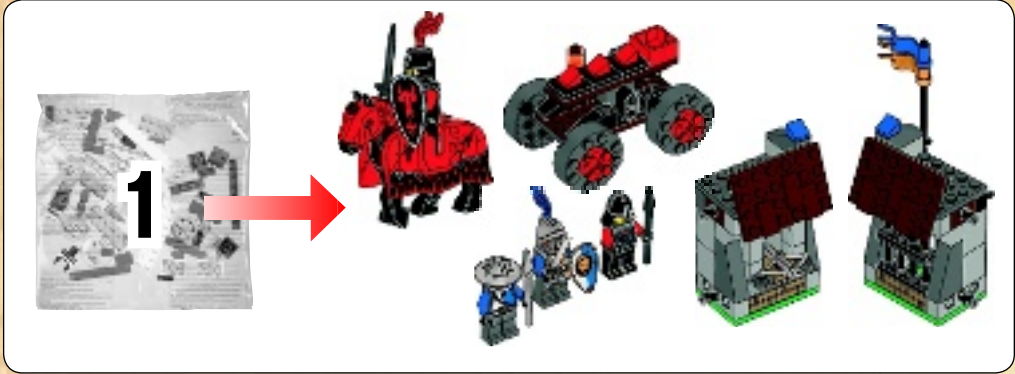

1



2



4

1



2



3



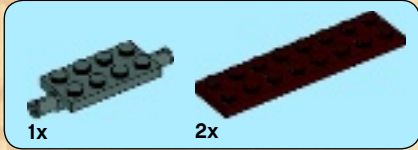
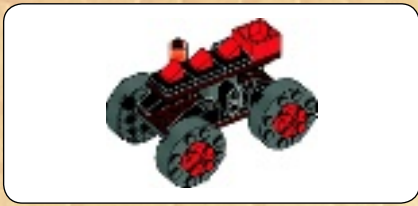

1

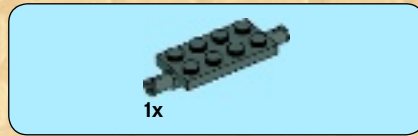
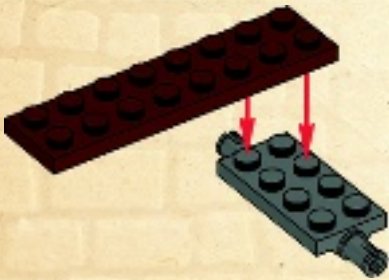

2

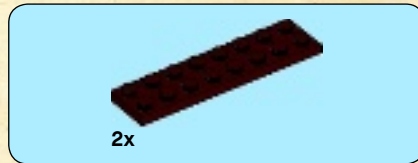
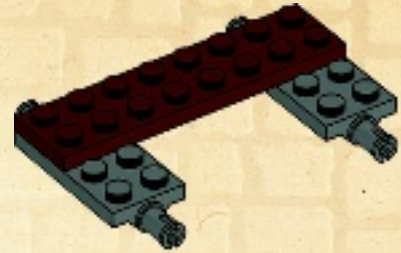

3





4x

4

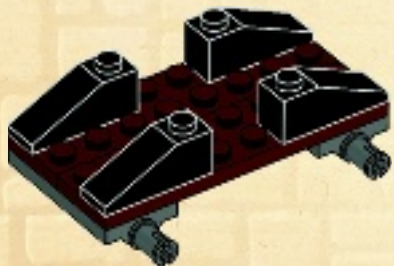

2x

5

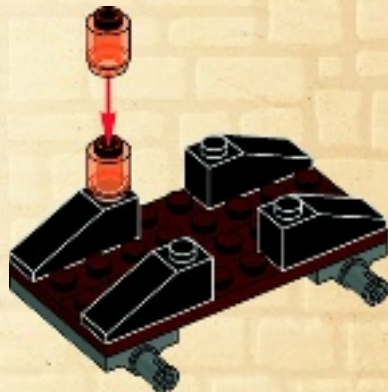

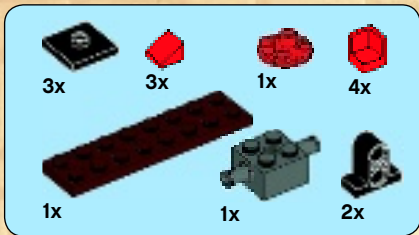

6

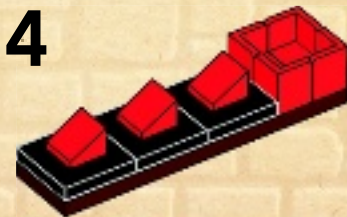
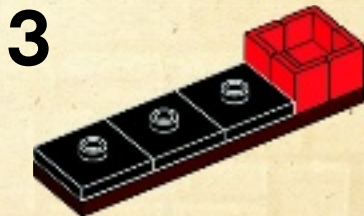
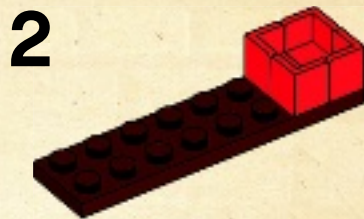

5



6

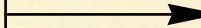
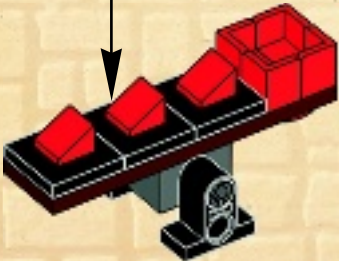

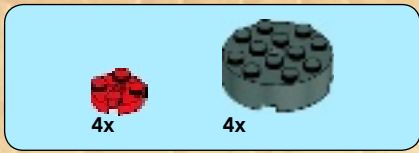

7

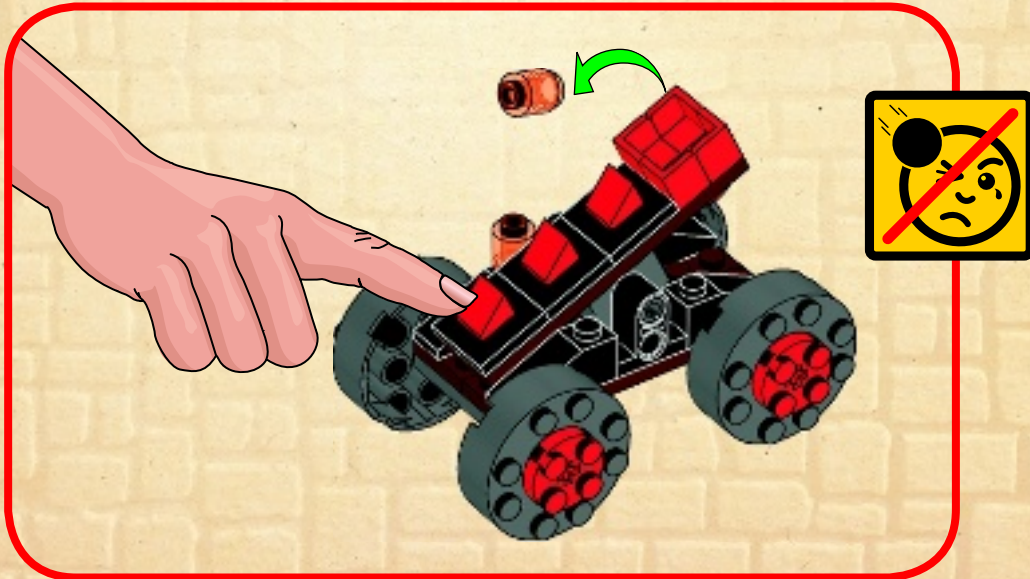
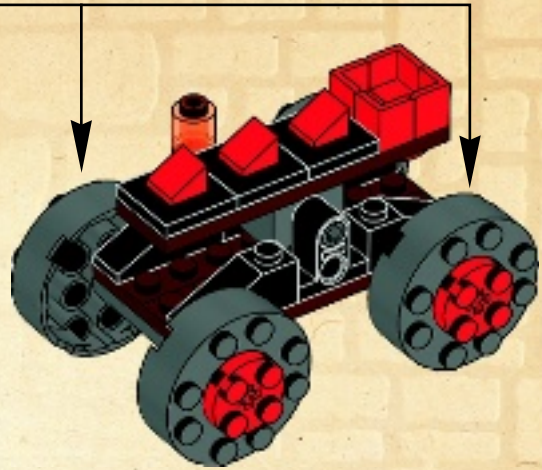
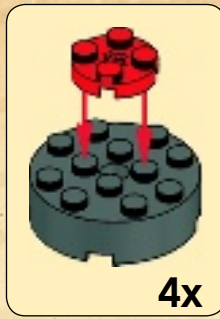

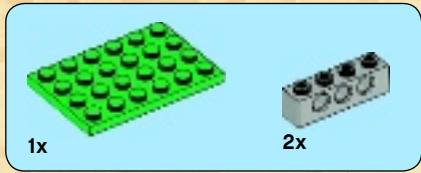
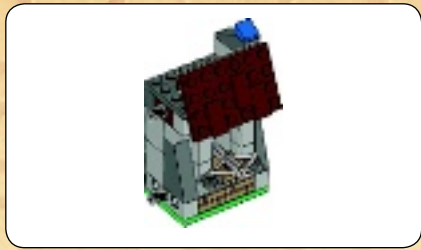

1

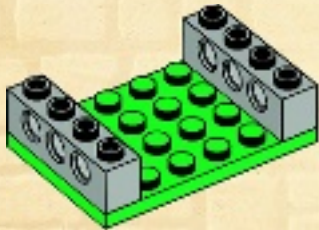

2

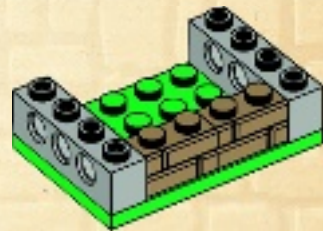



2x



2x

3

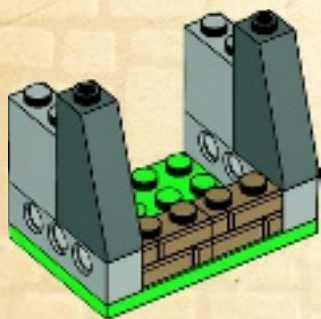

2x

4

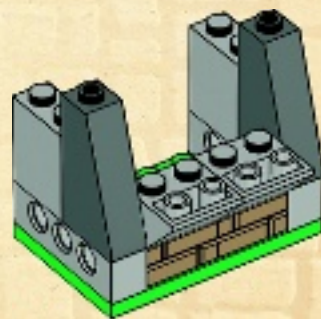



2x

5

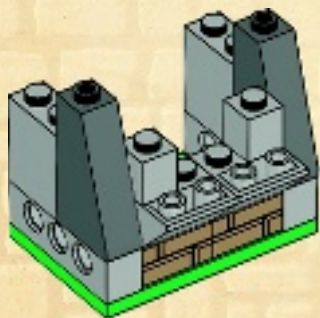

2x

6

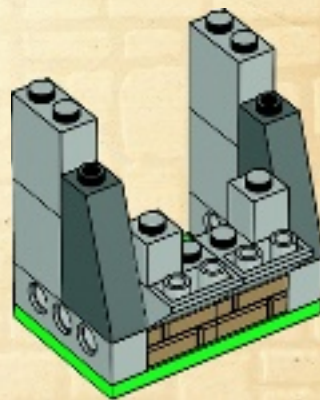

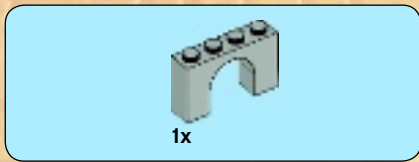

7

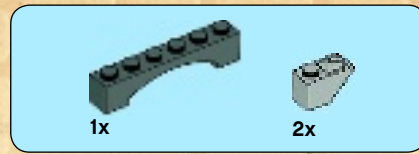
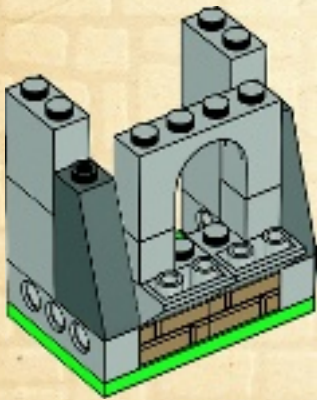

8

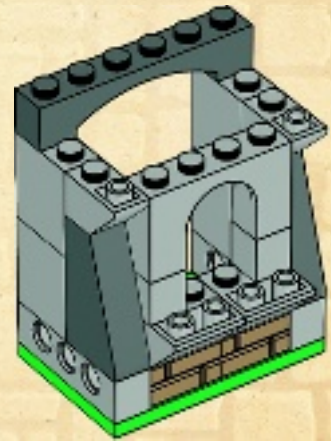



2x

9

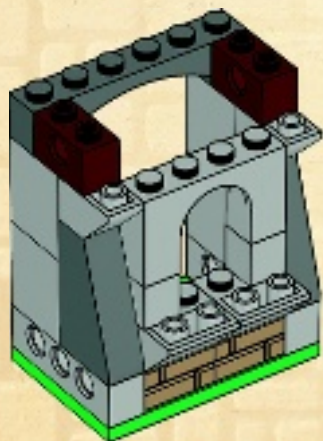

1x

10

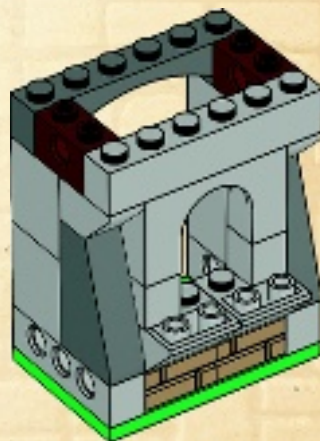

2x



1x

11

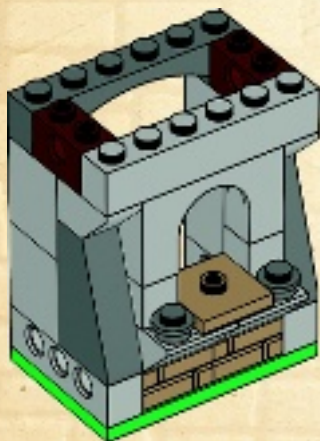

1x



1x



12

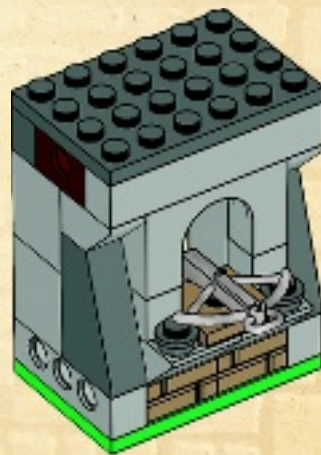



2x



1x



1x

13

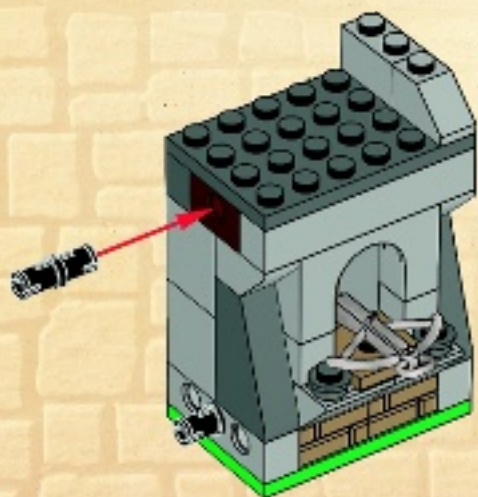

1x



1x



1x

14

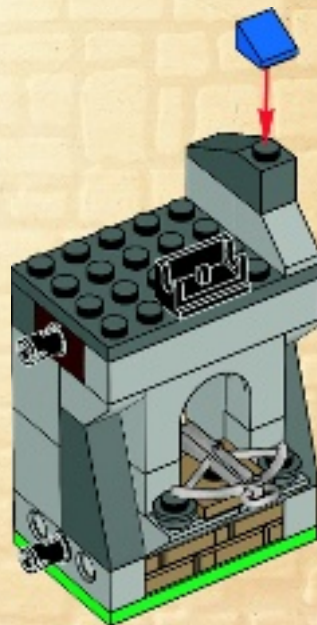

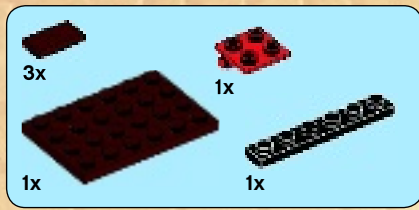

15

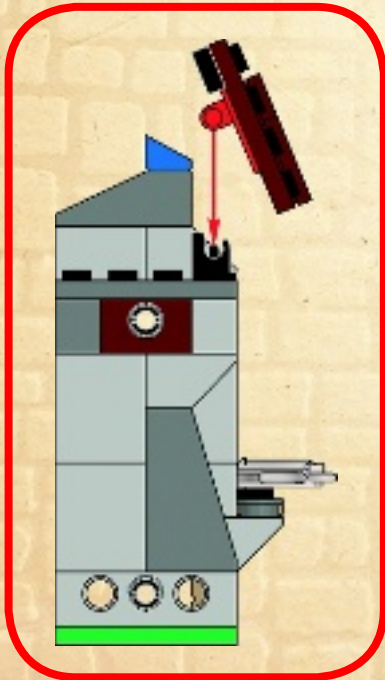

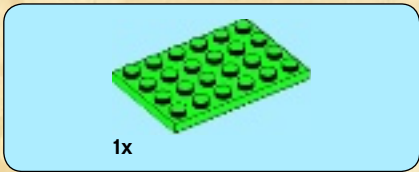
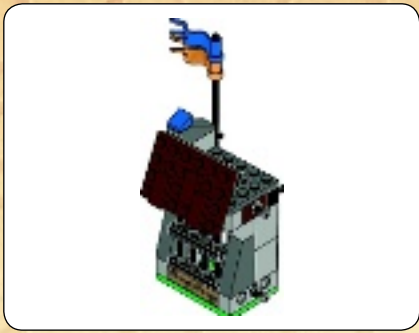

1

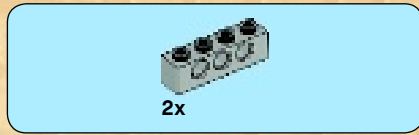

2

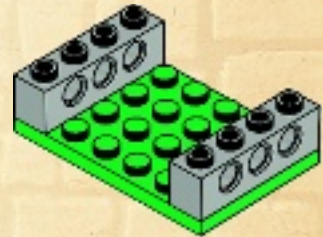

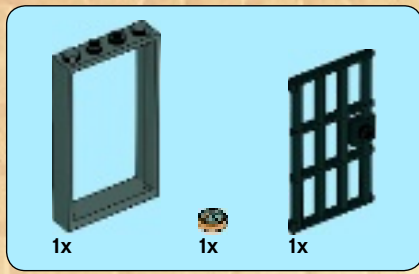

3

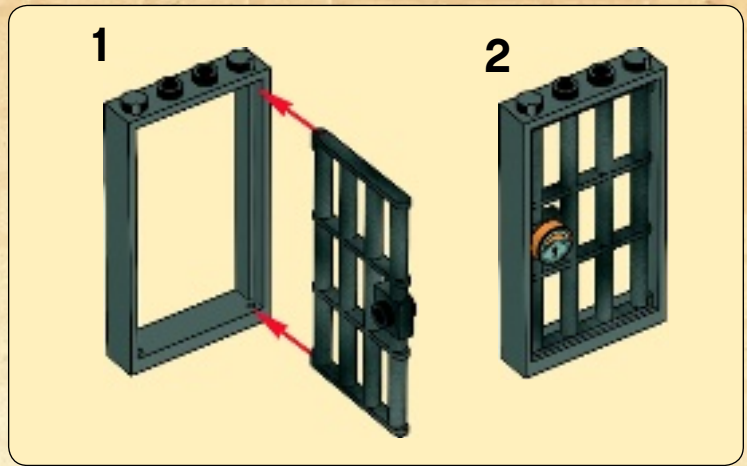



2x

4



2x

5





6

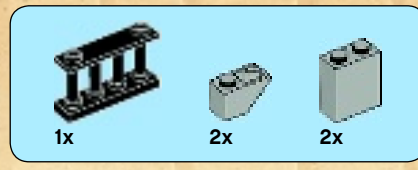
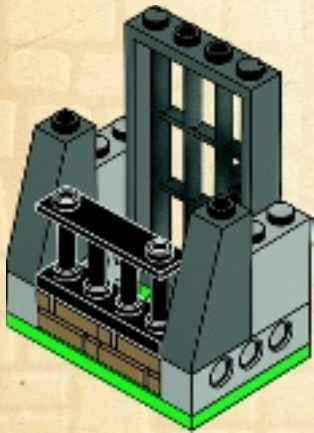

7





2x

8

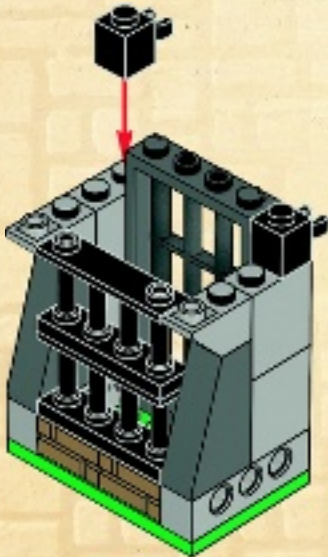

2x



1x

9

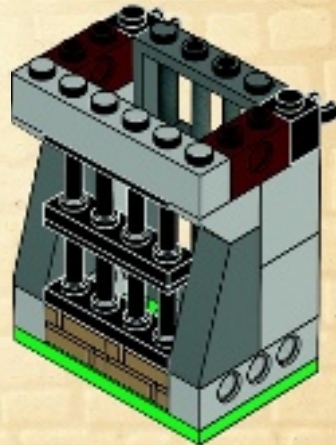



10

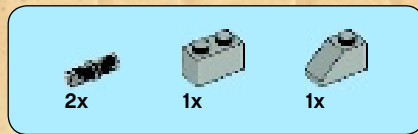
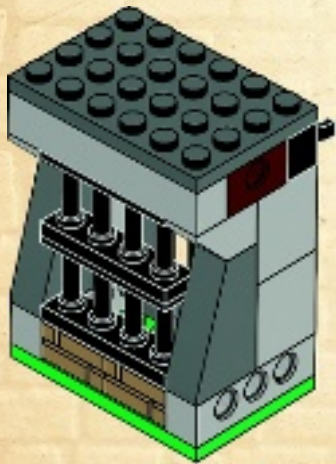

11

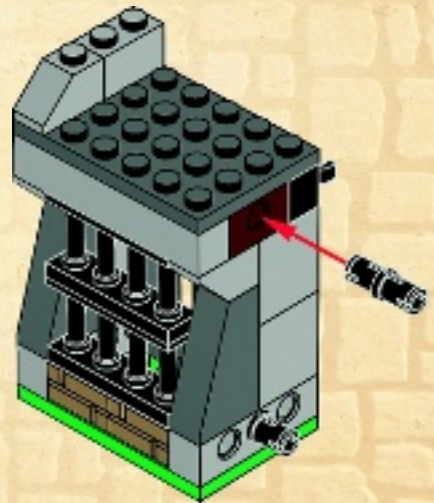



1x



1x



1x

12

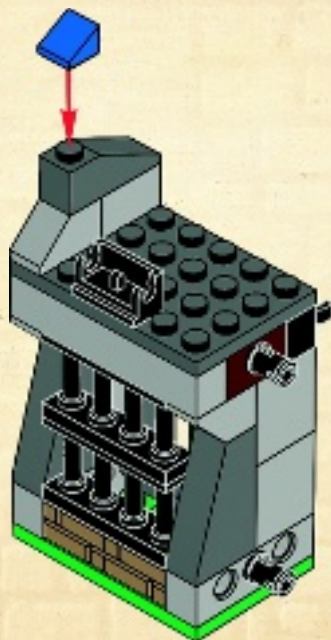

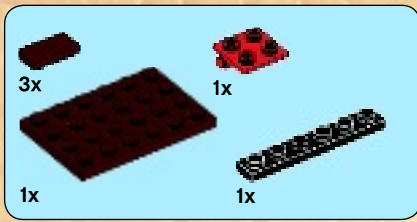

13

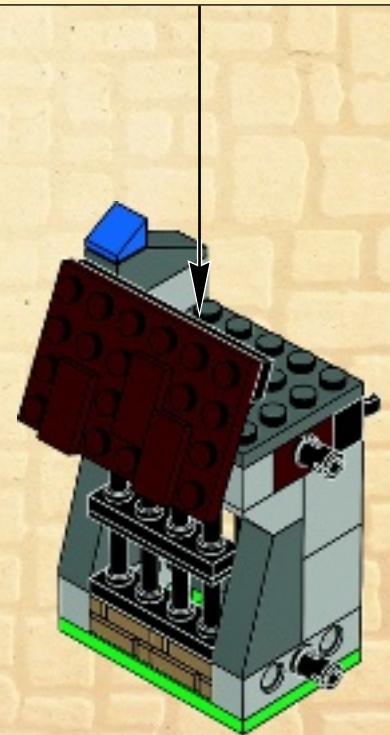
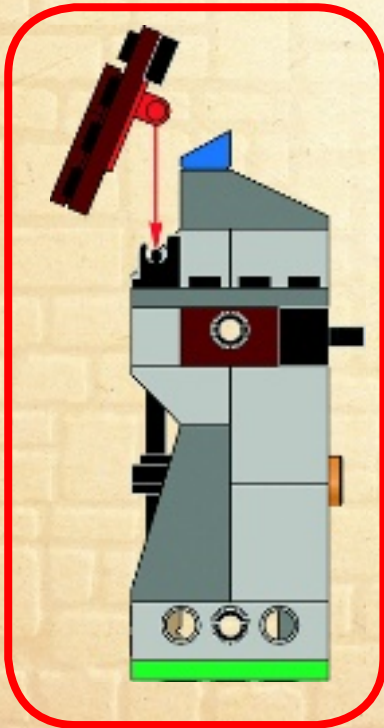
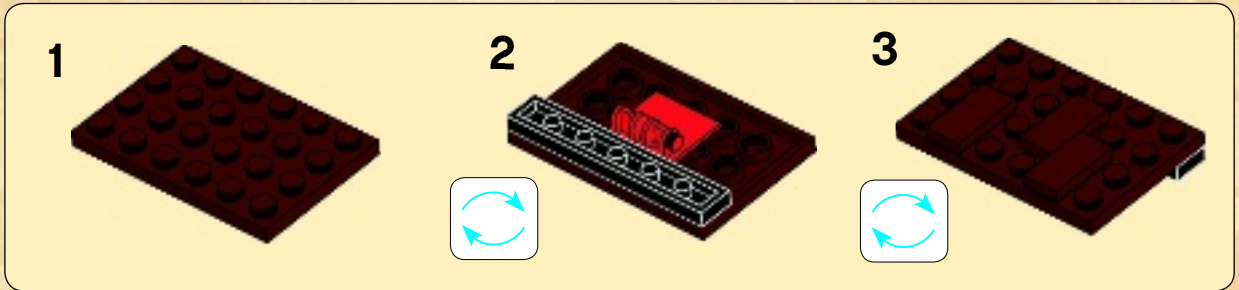

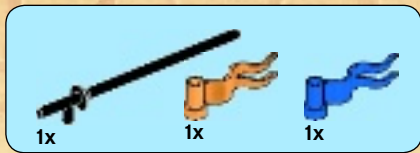

14

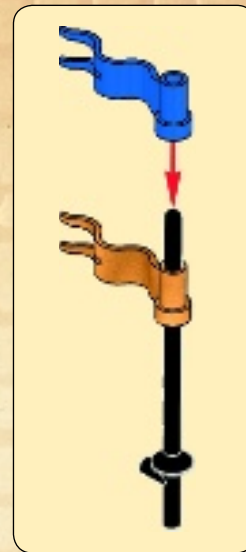
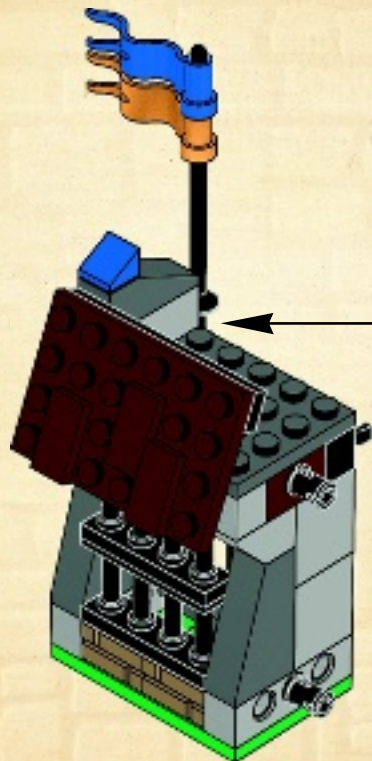

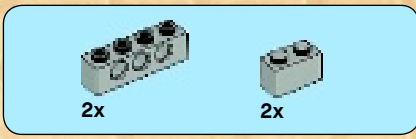
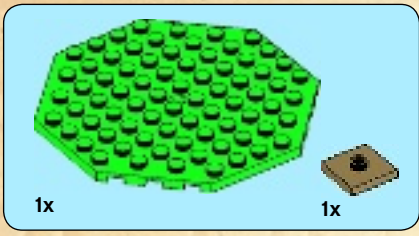
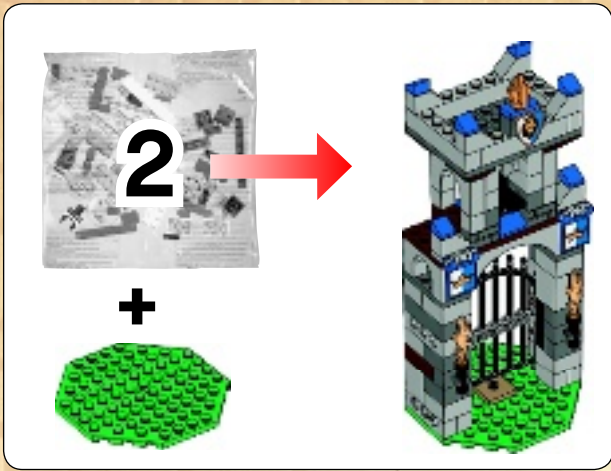

2





2x



2x

3

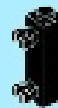
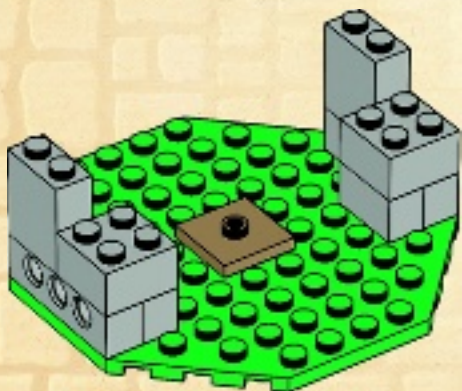

2x

4

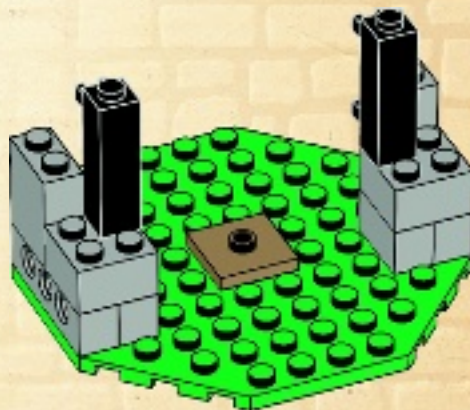



2x

5

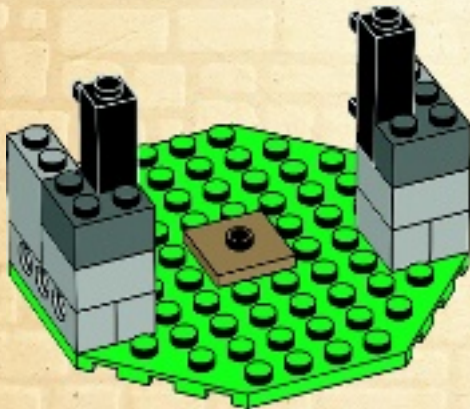

2x



2x

6

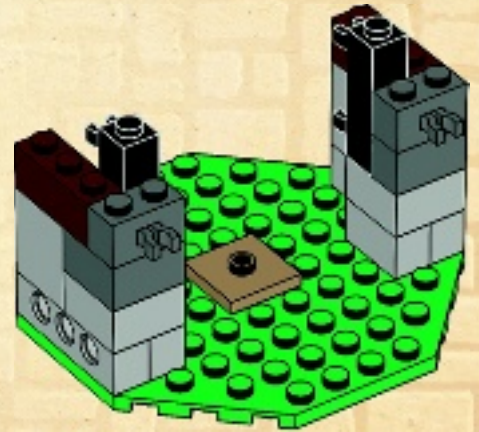



2x



2x

7

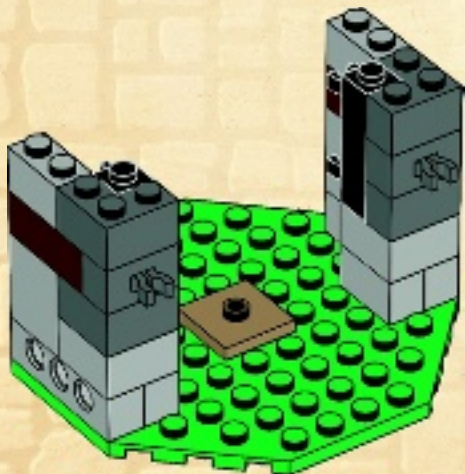

2x

8

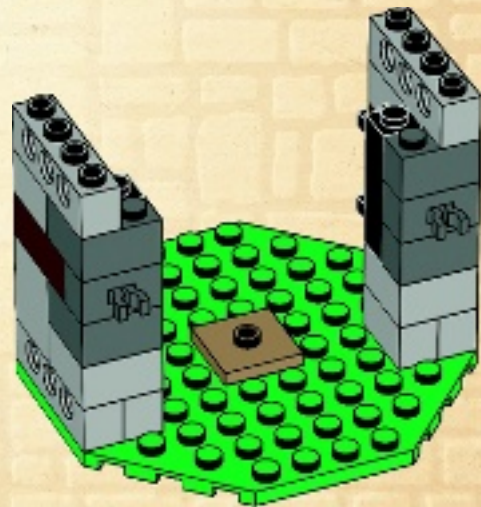



9

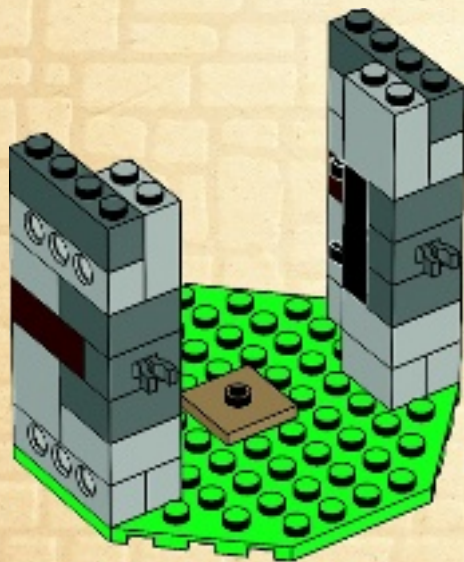

10

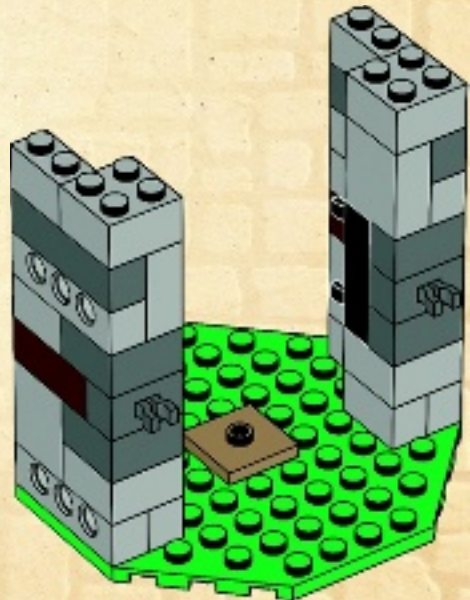



2x

11

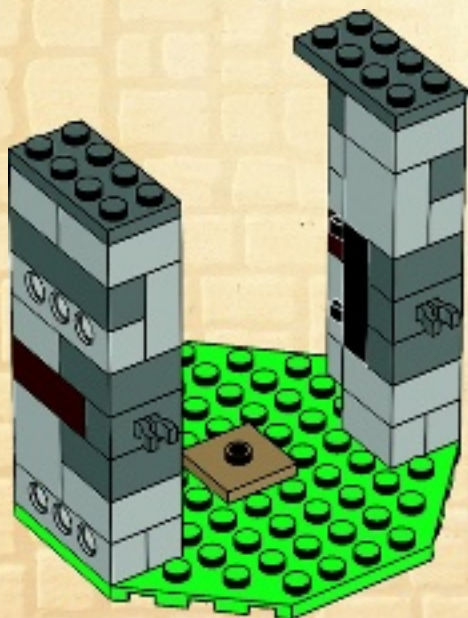

1x

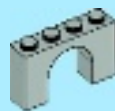

2x

12

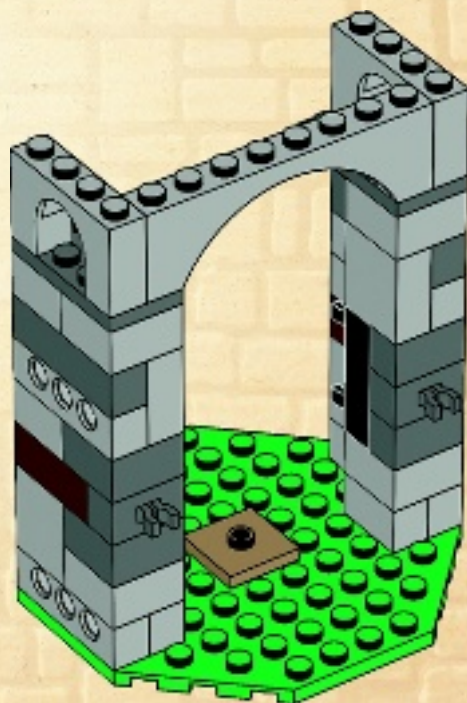



2x



2x

13

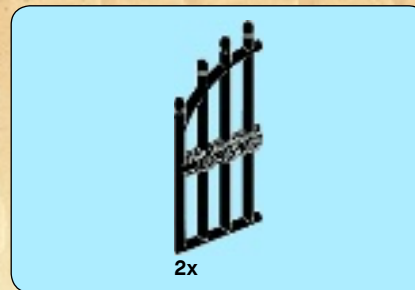
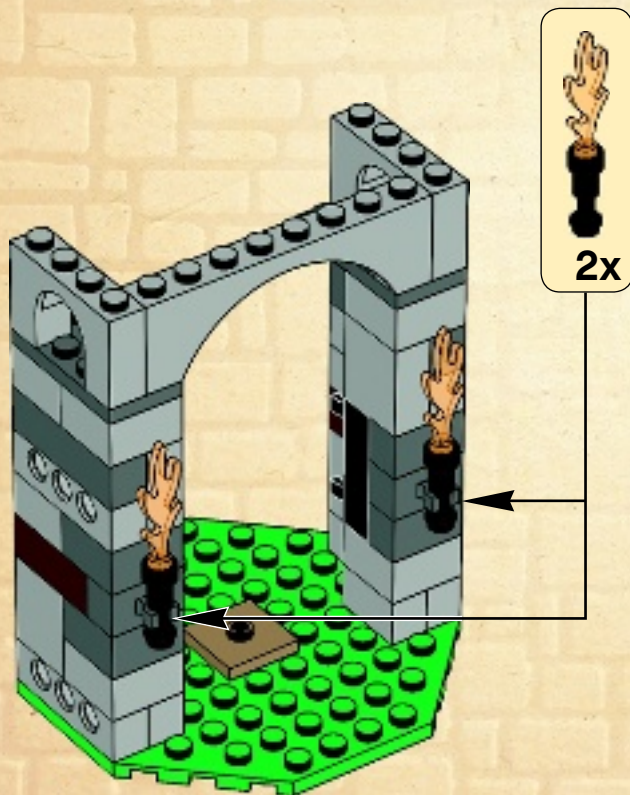

14

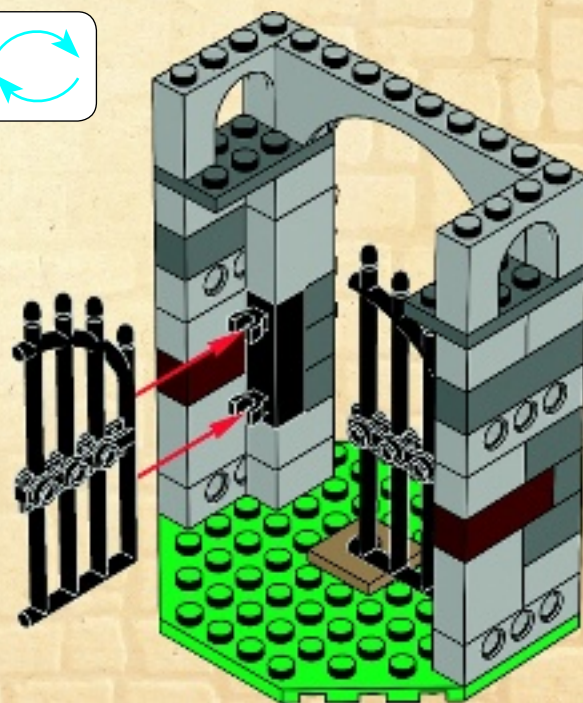
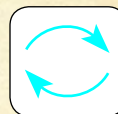

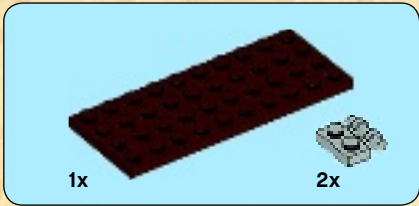
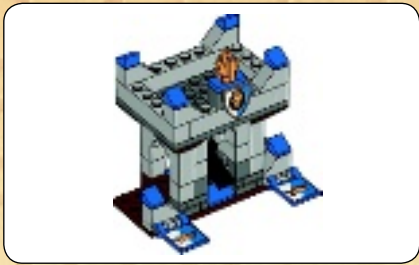

1x

2x

1



1x

2x

2

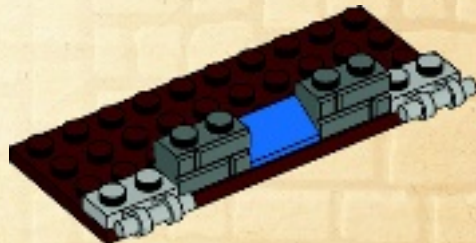



2x



2x

3

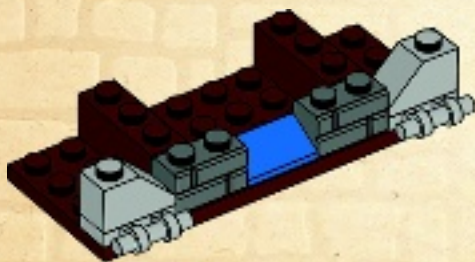

2x



2x

4

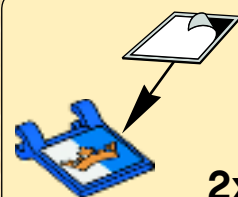
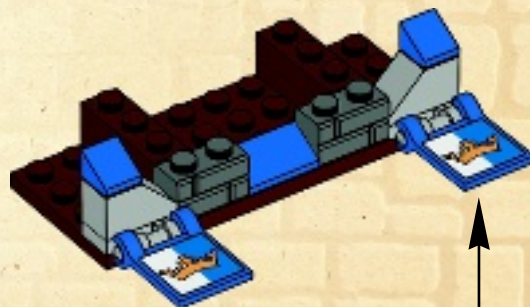

2x

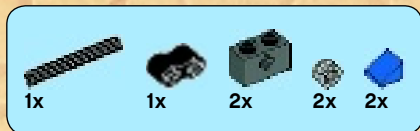

5

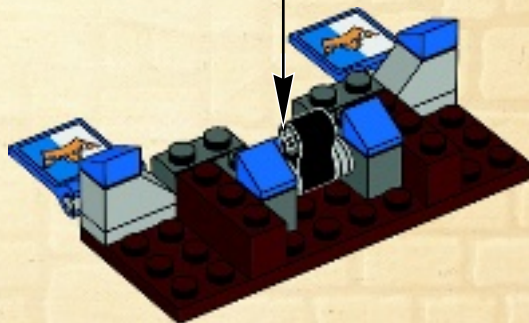
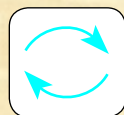
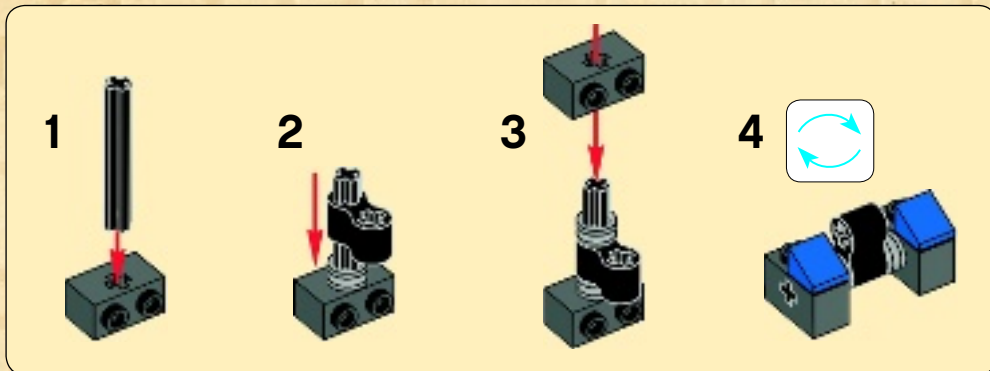



3x

6

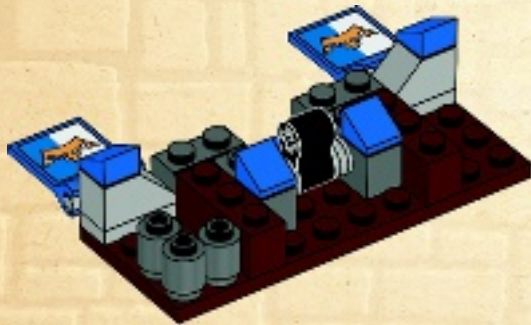

4x

7

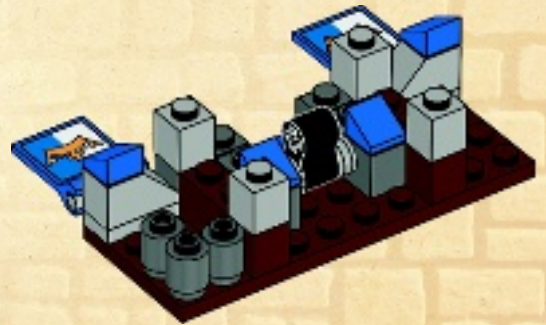



8

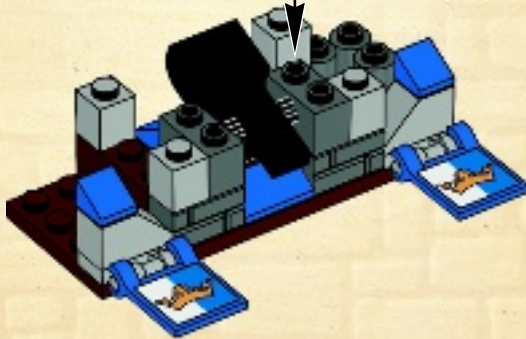
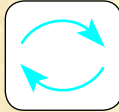
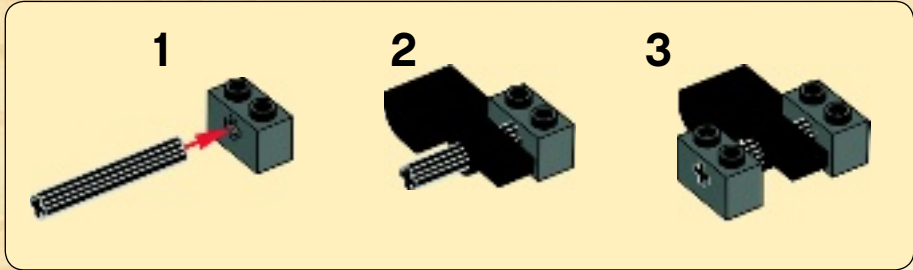



2x

9

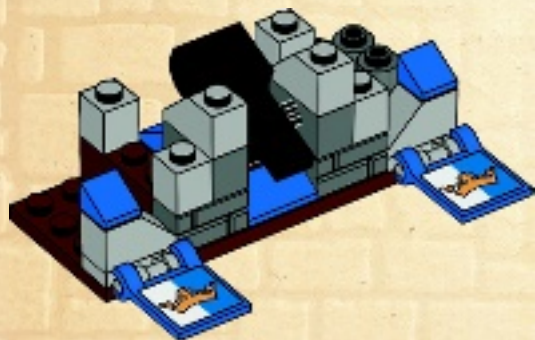

2x

10

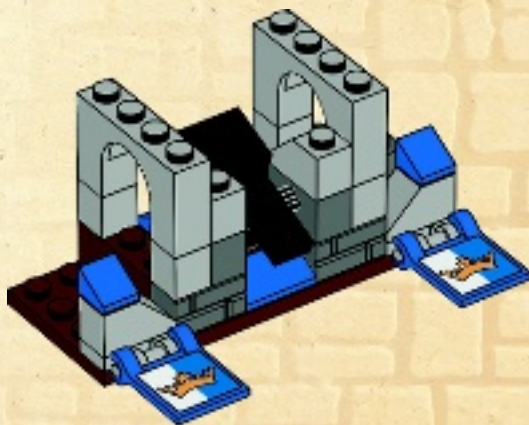

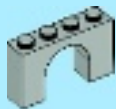

1x

11

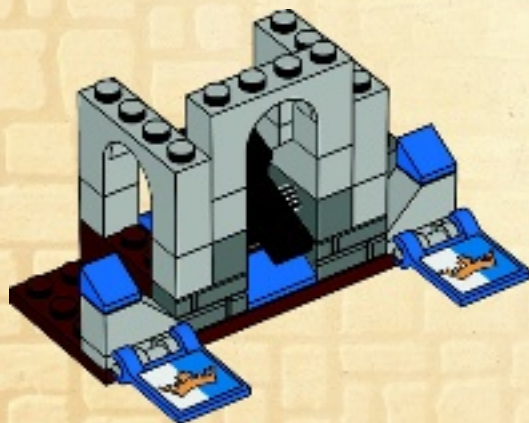

4x

12

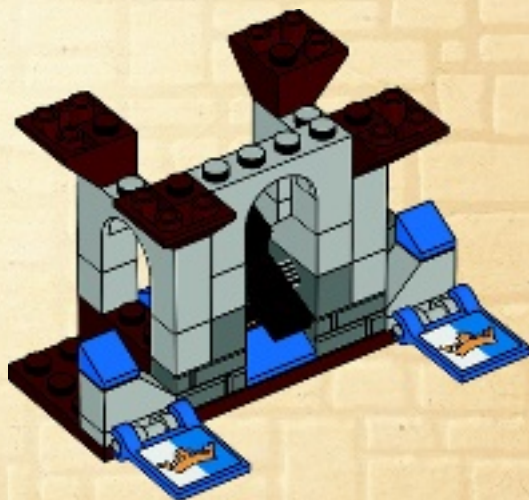



2x

13

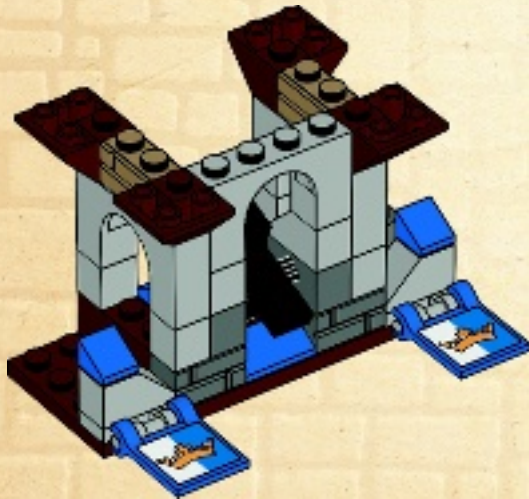

2x

14





4x

15

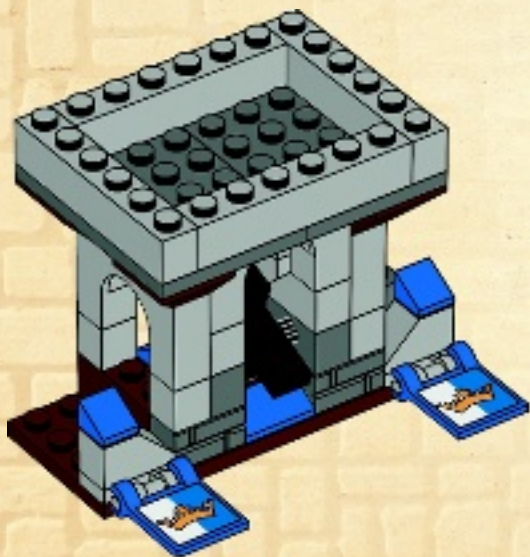

1x



4x

16

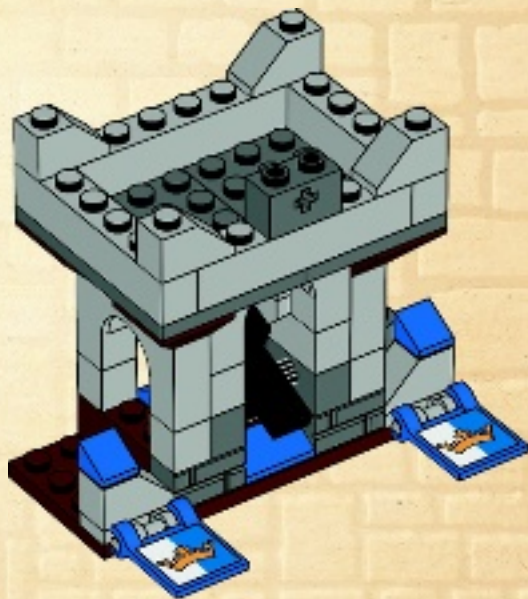



1x



4x

17

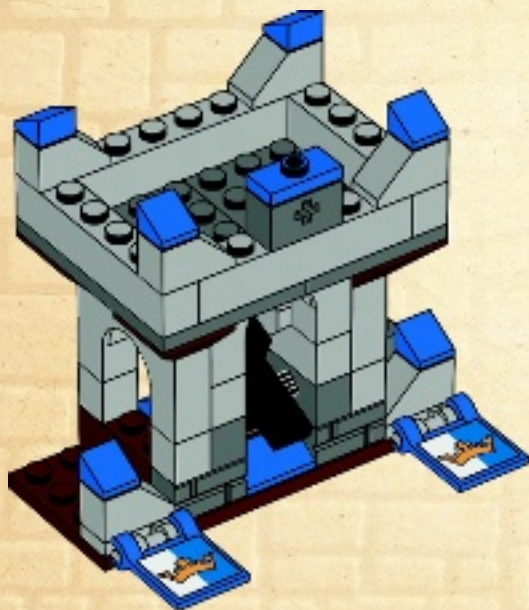

1x



1x

18

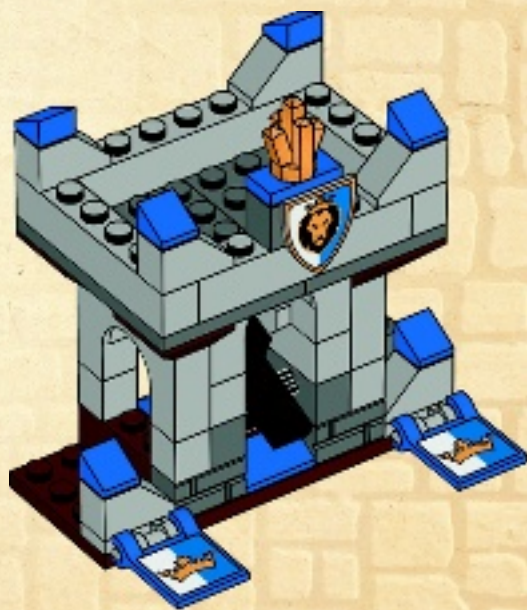

15

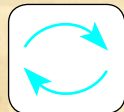
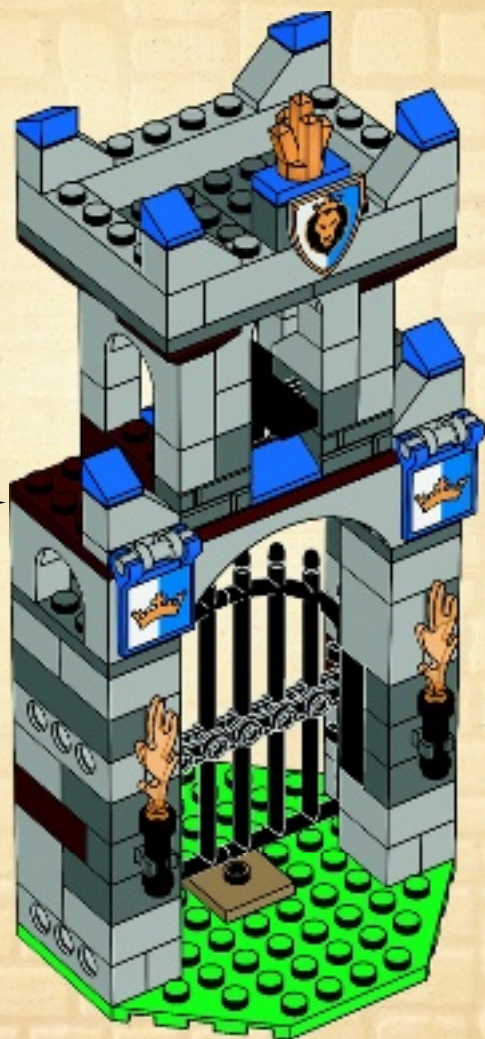

16

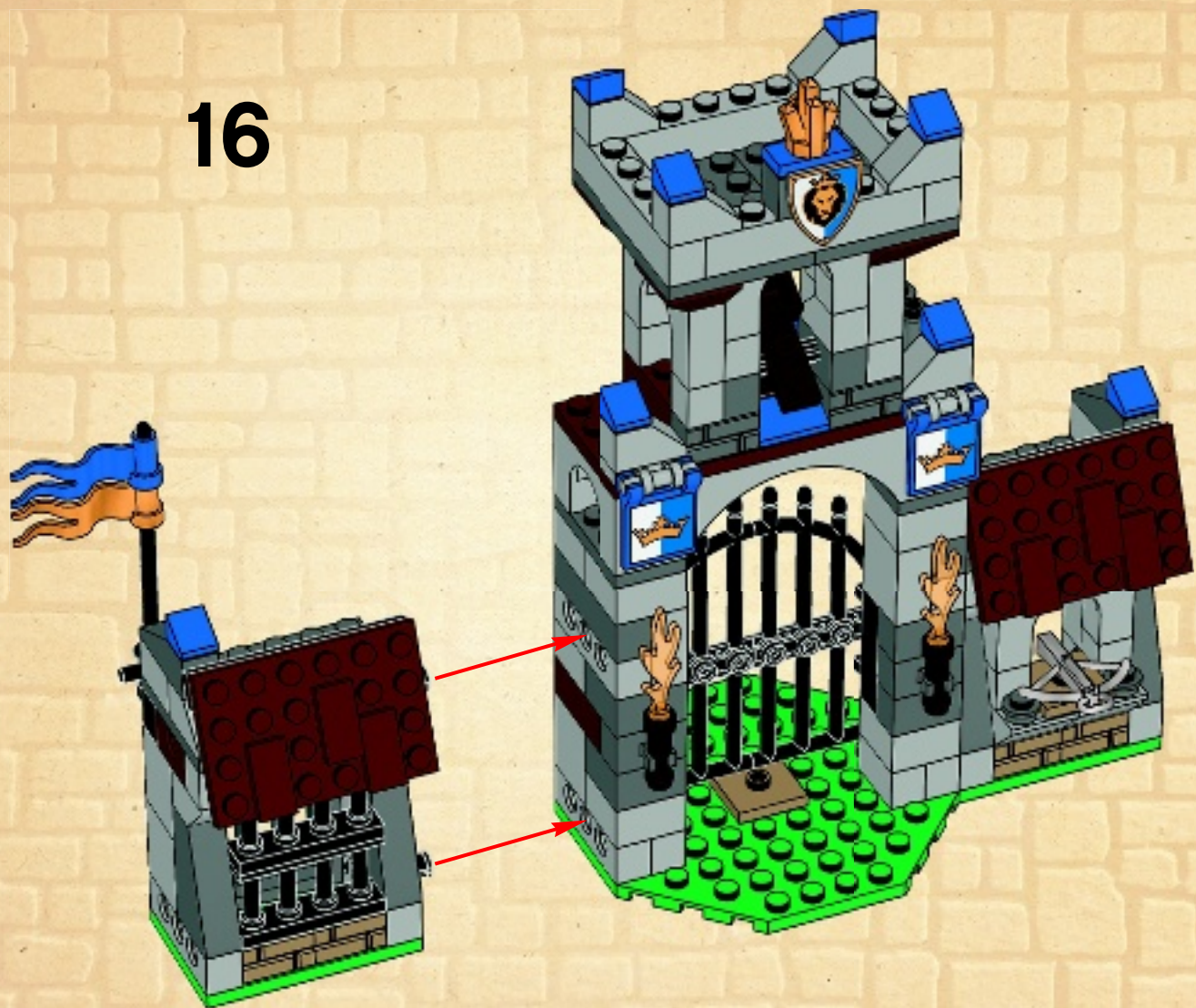







70404



70402



70400



70403



70401



LEGO.com/castle



club™

Free*! Gratuit!

* Paid subscription in Australia and New Zealand.
Abonnement payant en Australie et Nouvelle-Zélande



© 2013 The LEGO Group.



LEGO.com/club



Customer Service

Kundenservice

Service Consommateurs

Servicio Al Consumidor

LEGO.com/service or dial



: 00800 5346 5555

: 1-800-422-5346



WIN!

Go to www.LEGOsurvey.com/product to fill out a survey for a chance to win a cool LEGO® Product.

No purchase necessary.

Open to all residents where not prohibited.



LEGO.com



www.LEGOsurvey.com/product

GEWINNE! WIN!

Nimm an der Umfrage auf www.LEGOsurvey.com/product teil und hab die Chance ein cooles LEGO® Produkt zu gewinnen!

Die Teilnahme am Gewinnspiel führt zu keinerlei Kaufverpflichtungen. Teilnahme in allen nicht ausgeschlossenen Ländern möglich.

Ga naar www.LEGOsurvey.com/product, vul een enquêteformulier in en maak kans op een cool LEGO® product.

Geen aankoopverplichting. Iedereen mag deelnemen, uitgezonderd ingezetenden van landen waar een enquêteverbod geldt.

GAGNE! 当てよう!

Visite www.LEGOsurvey.com/product pour répondre à un questionnaire et avoir une chance de gagner un produit LEGO® très cool!

Aucune obligation d'achat. Ouvert à tous les résidents des pays autorisés.

www.LEGOsurvey.com/product にアクセスして、アンケートにご記入ください。当選者にはレゴ® 製品を差し上げます。

お買い上げの必要はありません。

禁止されていない限り、すべての皆様にご利用いただけます。