



Friends



41005



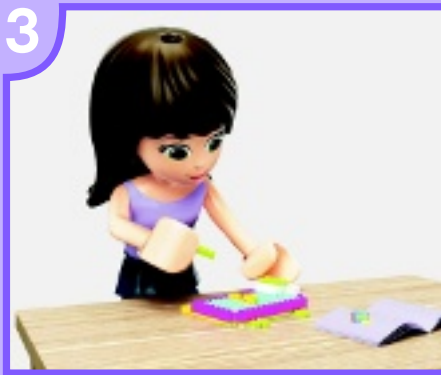
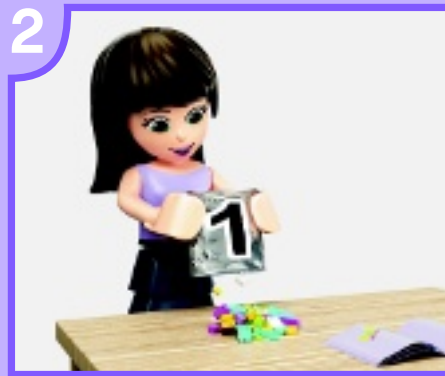

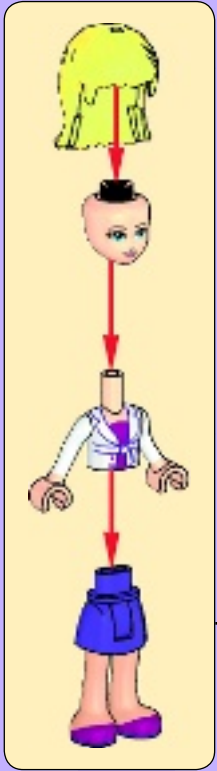
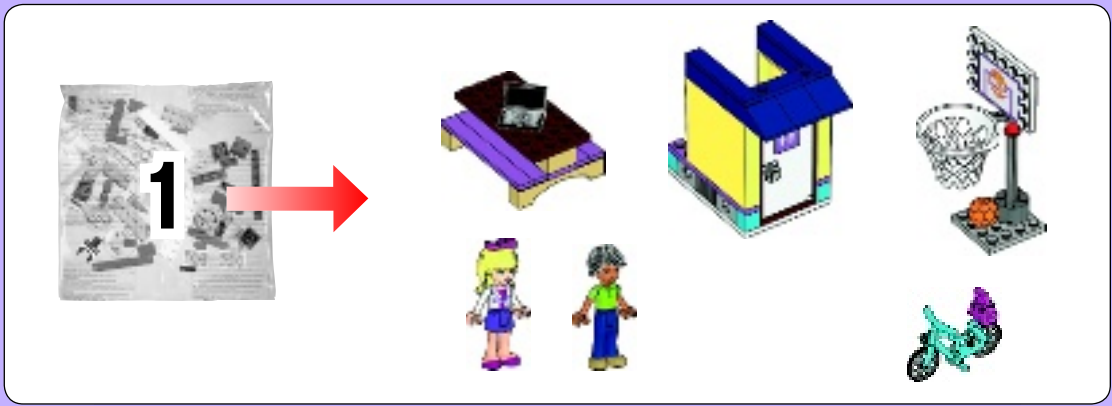

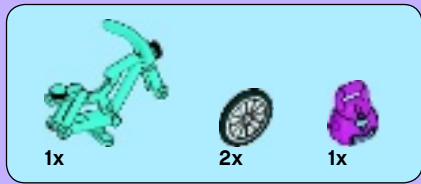

1

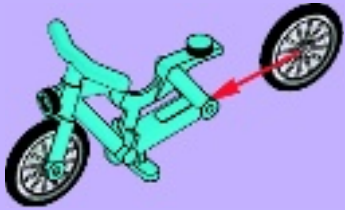

2



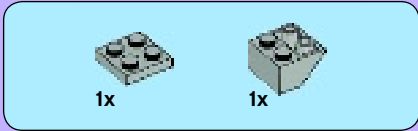

1

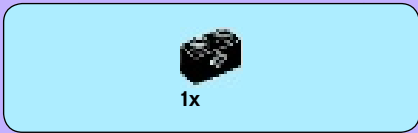
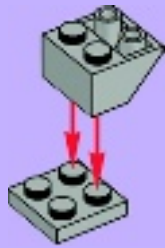

2

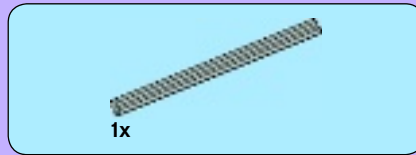

3

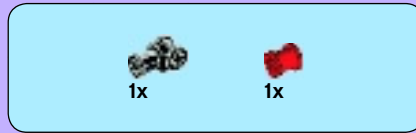
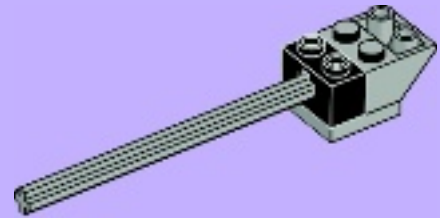

4

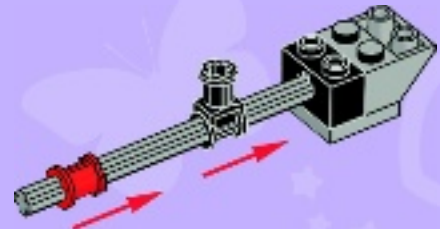

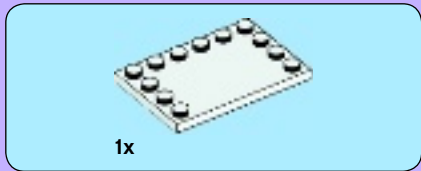

5

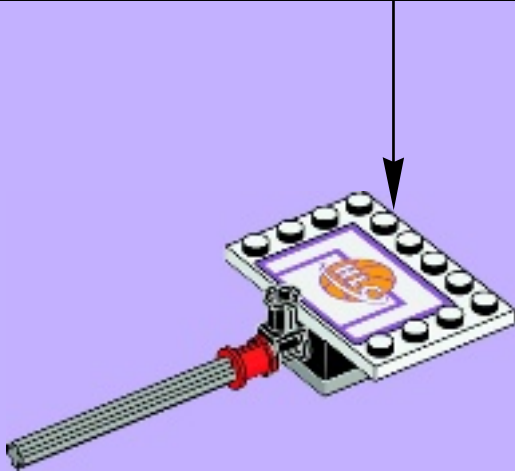
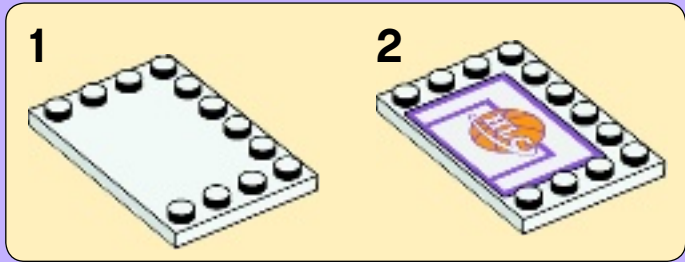

6

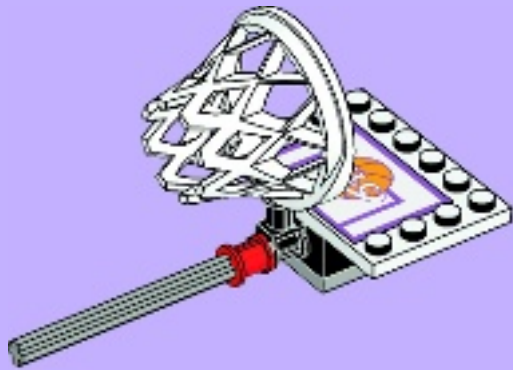



7

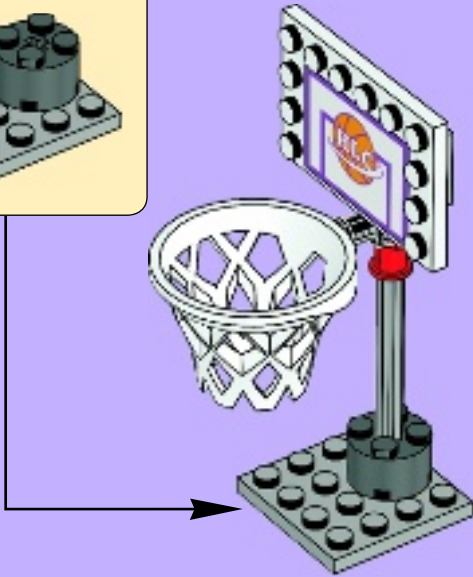
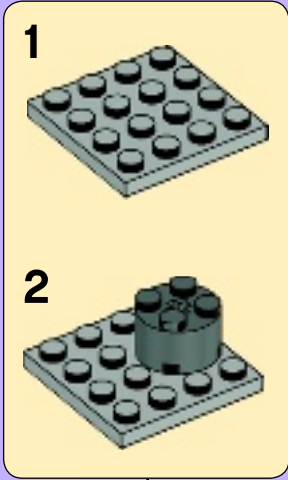

8



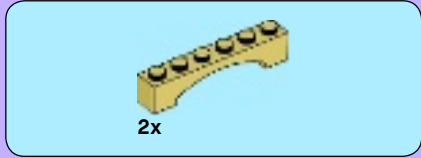

1

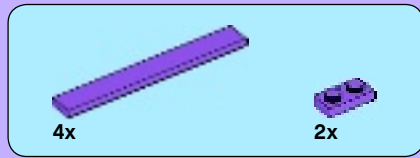
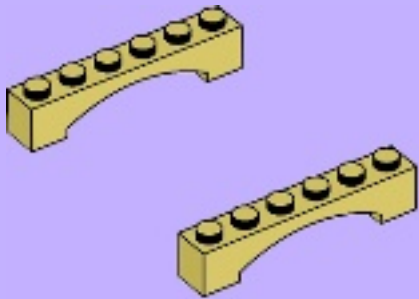

2

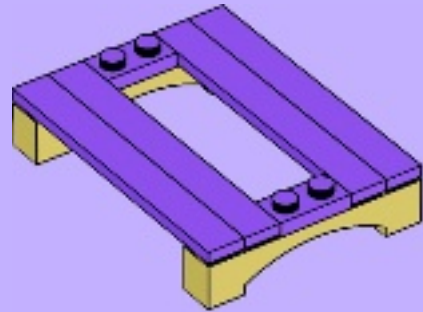



2x

3

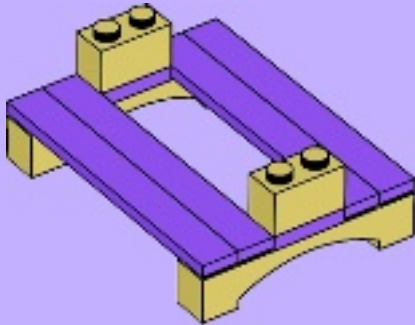

1x



1x

4



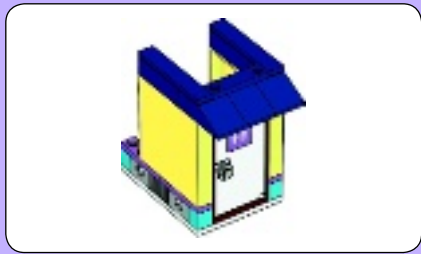

1

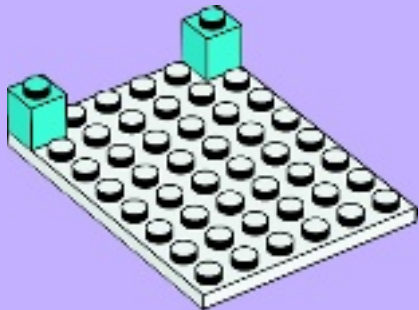

2

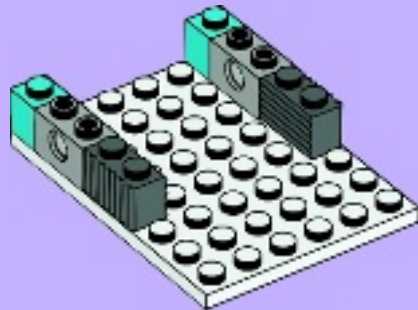



2x



2x

3

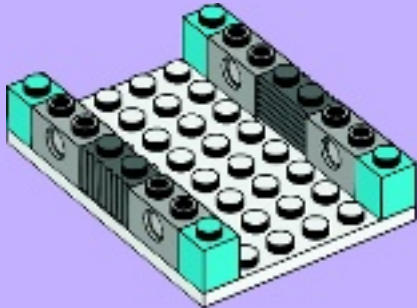

4x

4

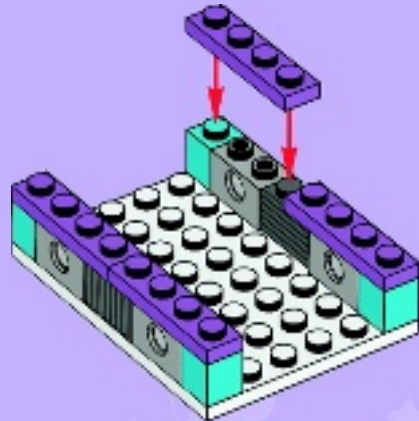

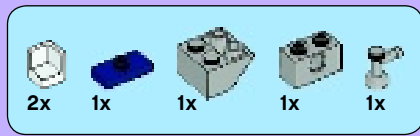

5

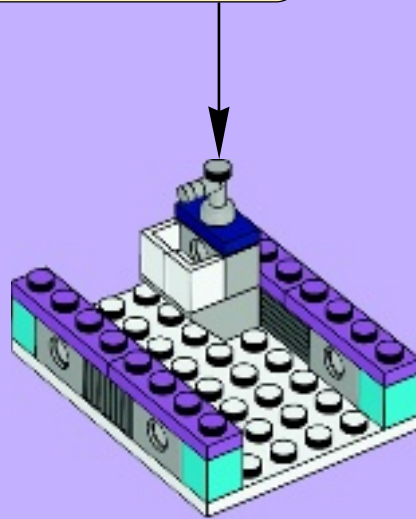
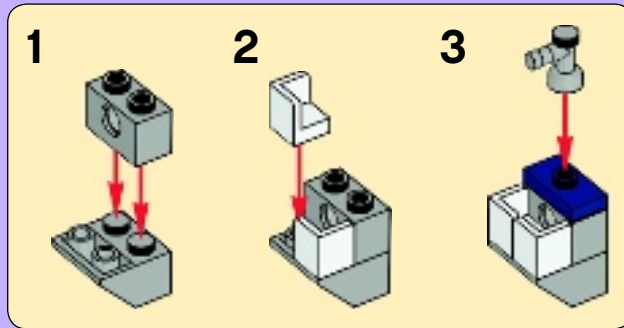

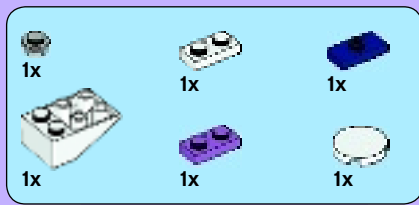

6

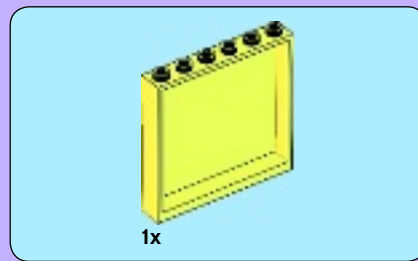
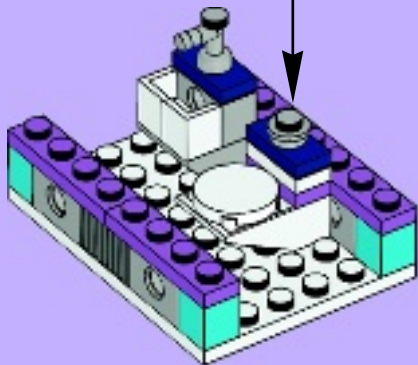

7

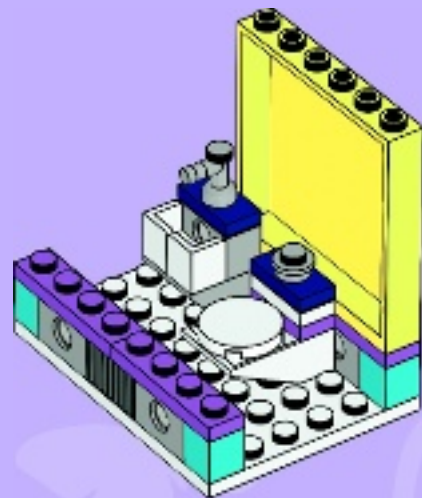

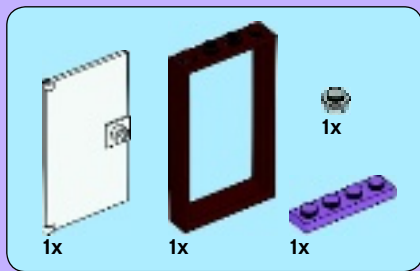

8

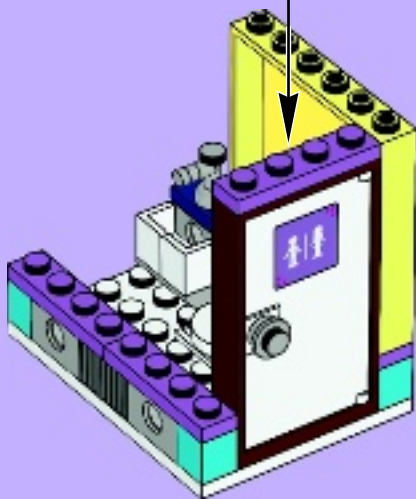
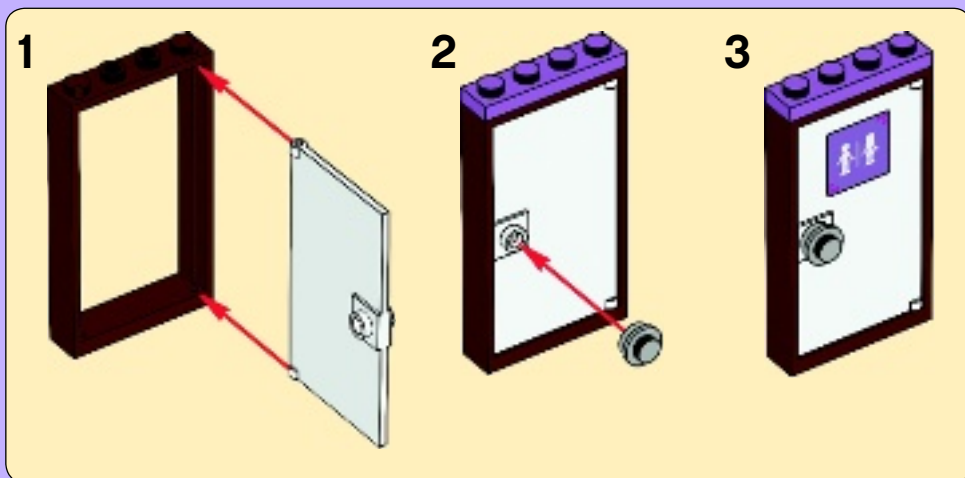

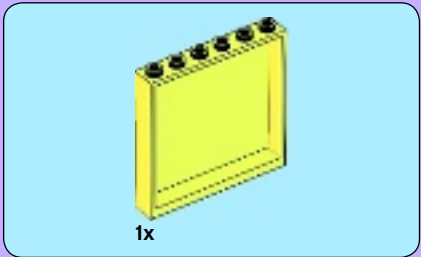

9

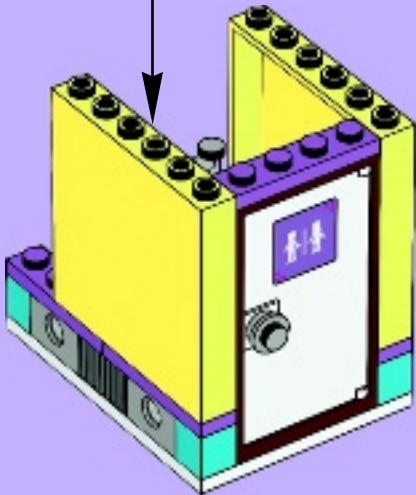
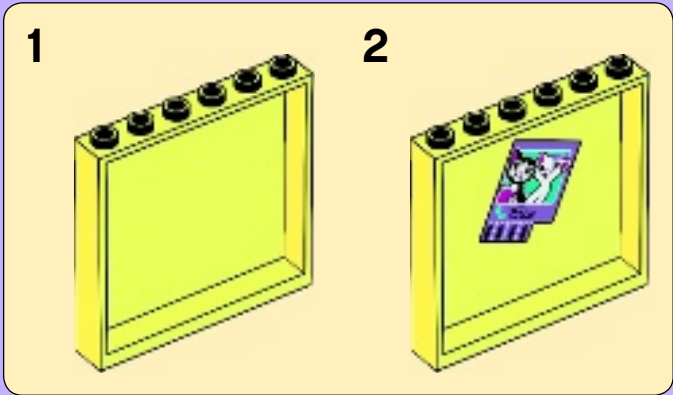



2x

10



2x

11

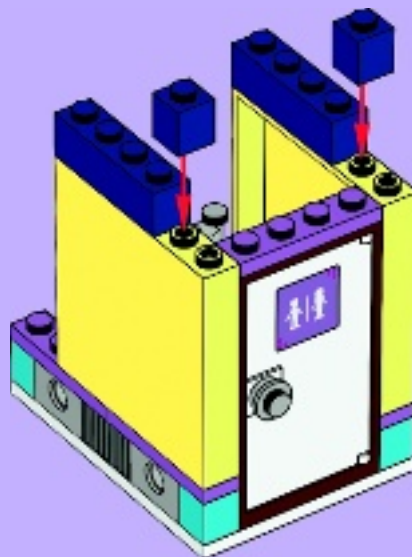



12

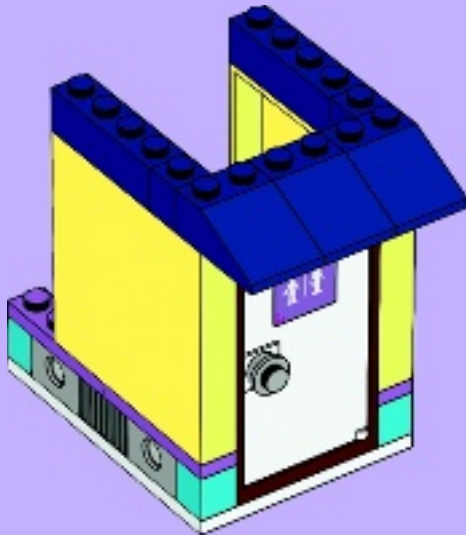

13

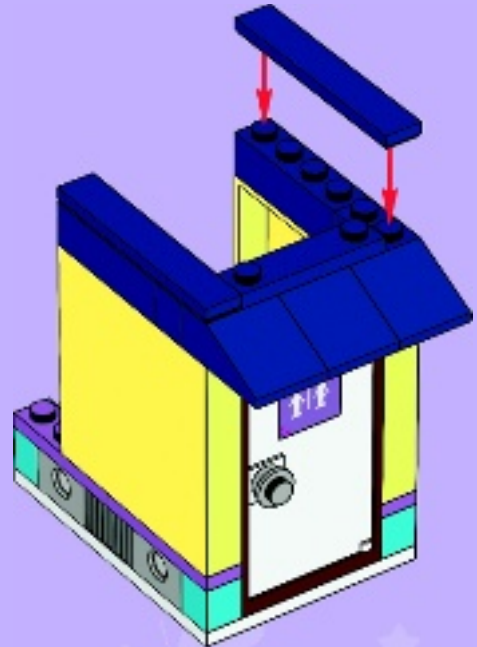

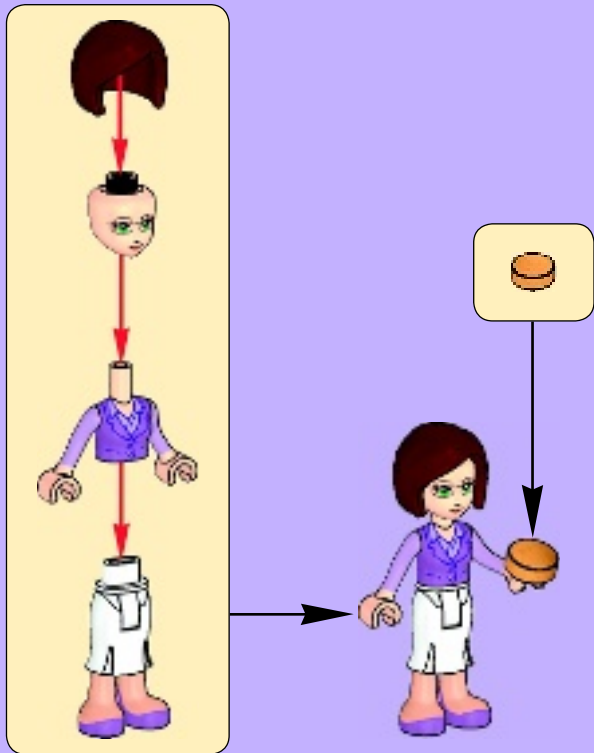
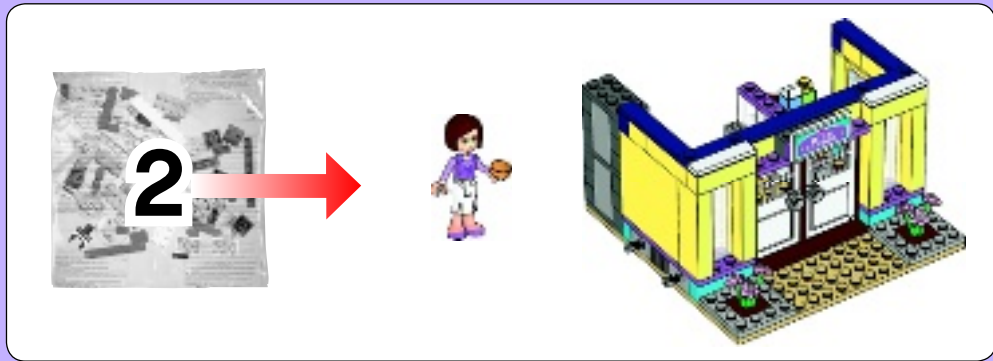

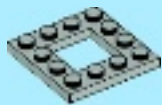

2x

1

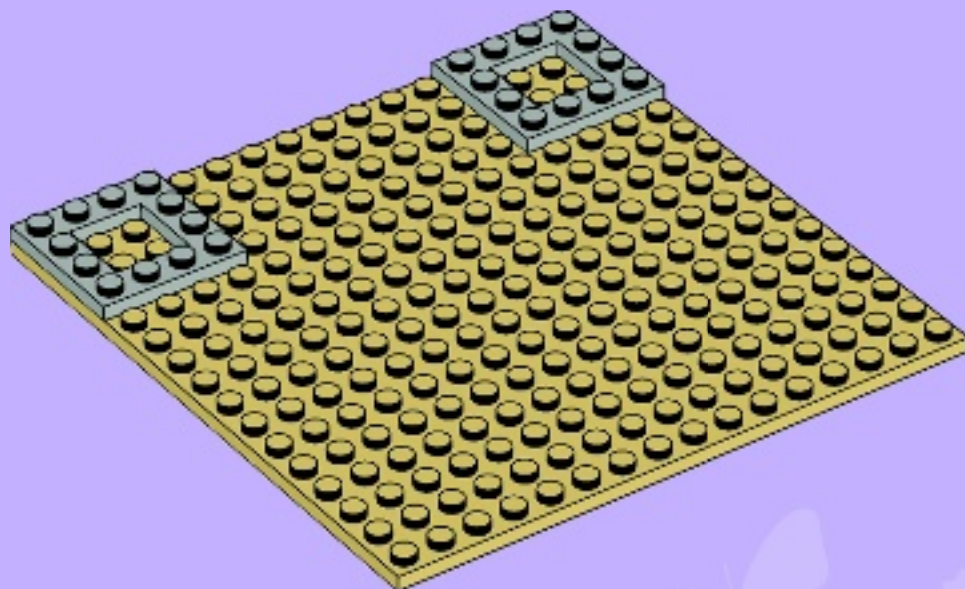



2x

2

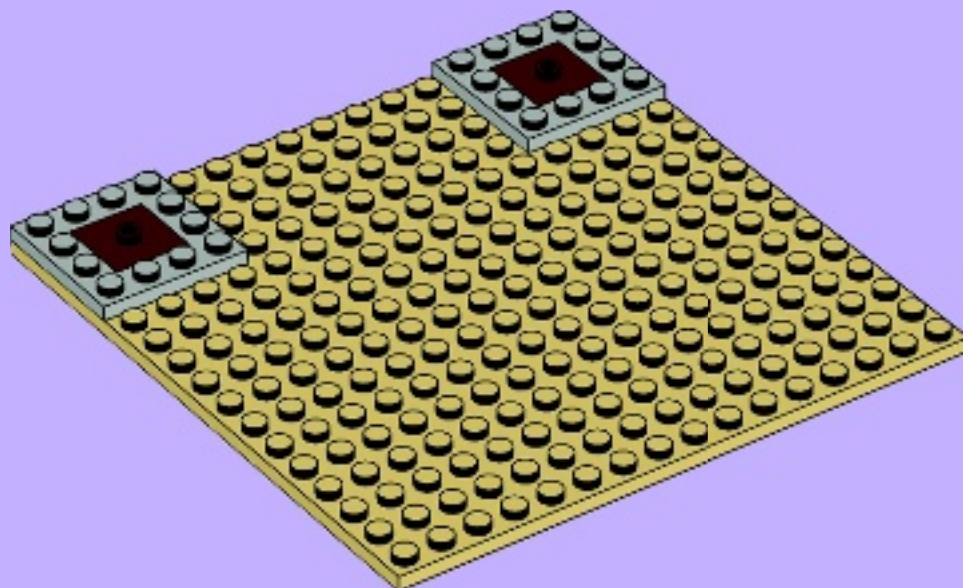



3

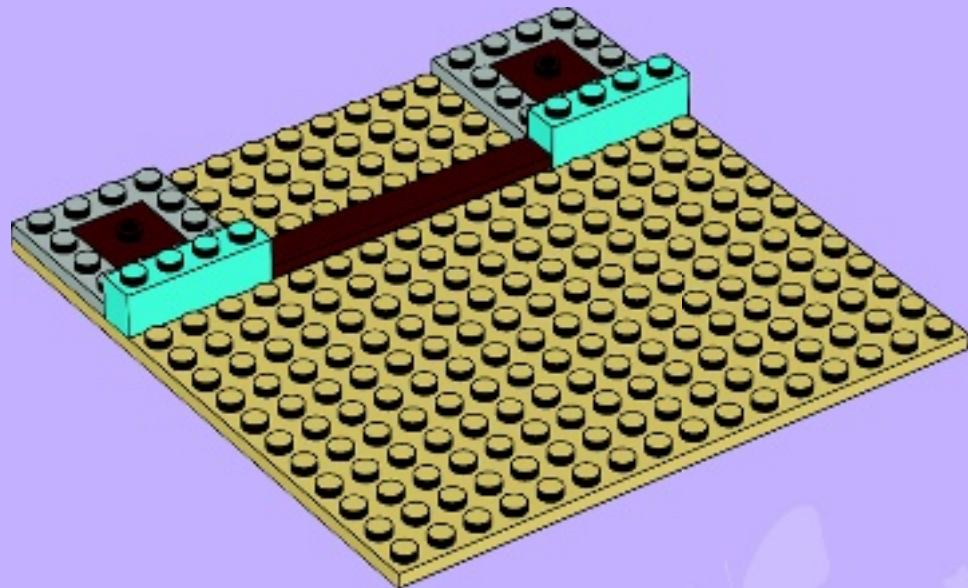



2x

4

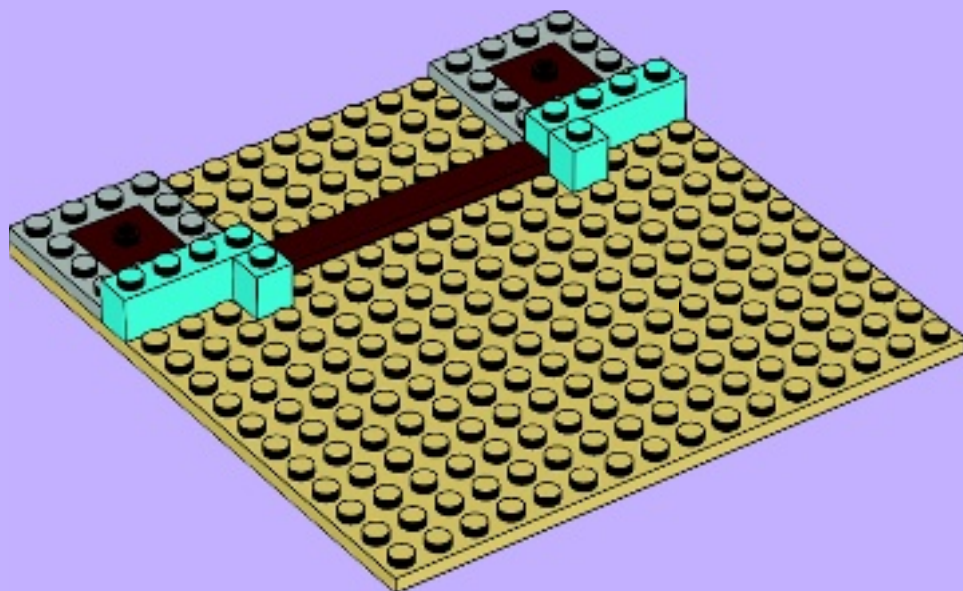



2x



4x



2x

5

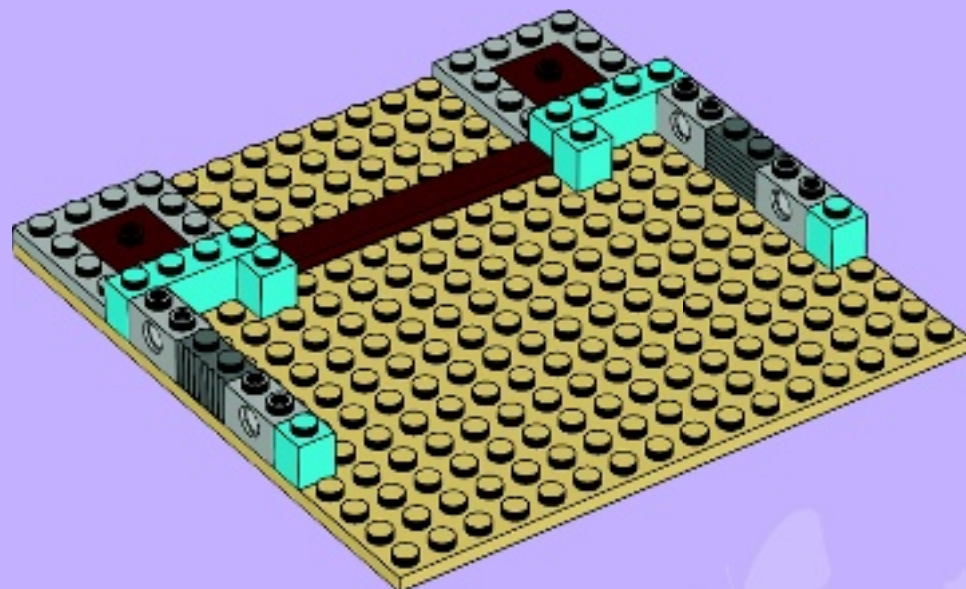



4x

6

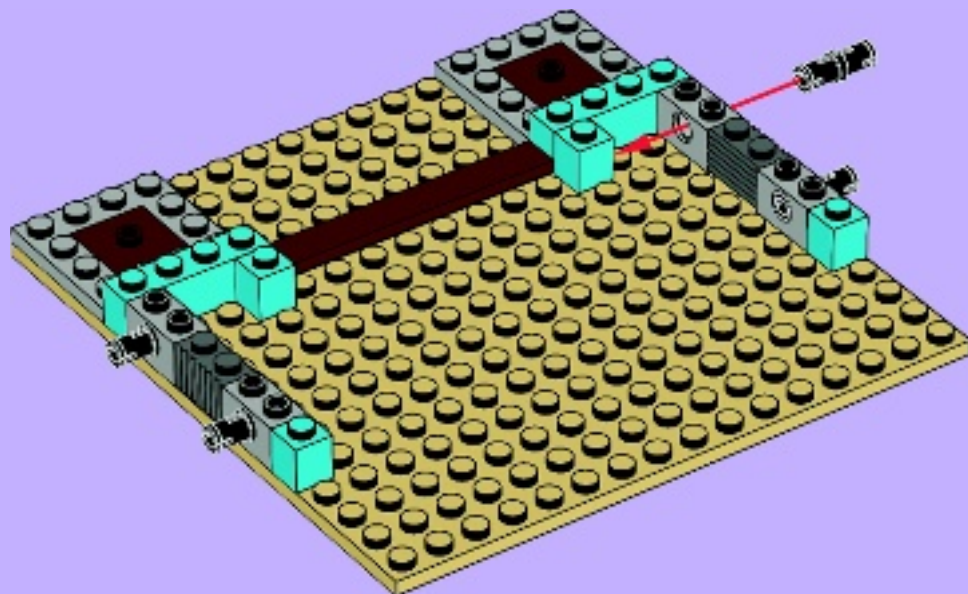

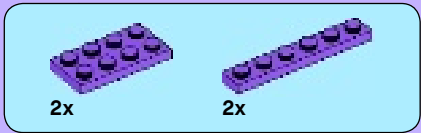

7

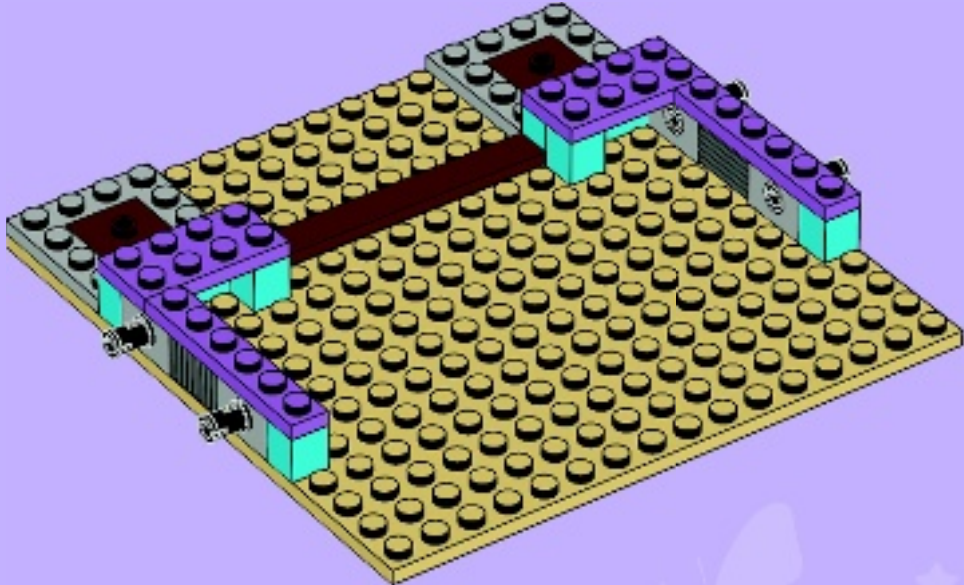



8

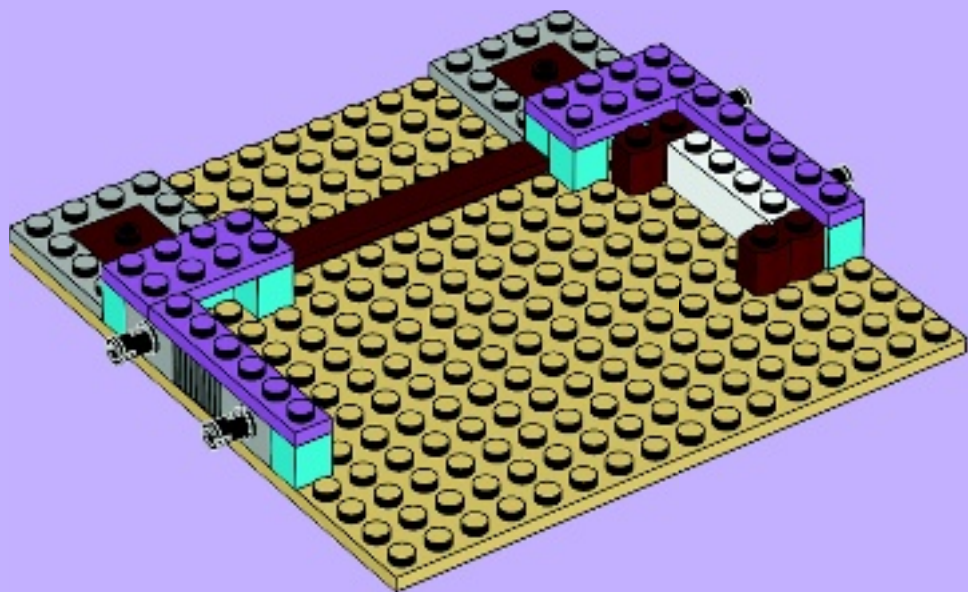



9

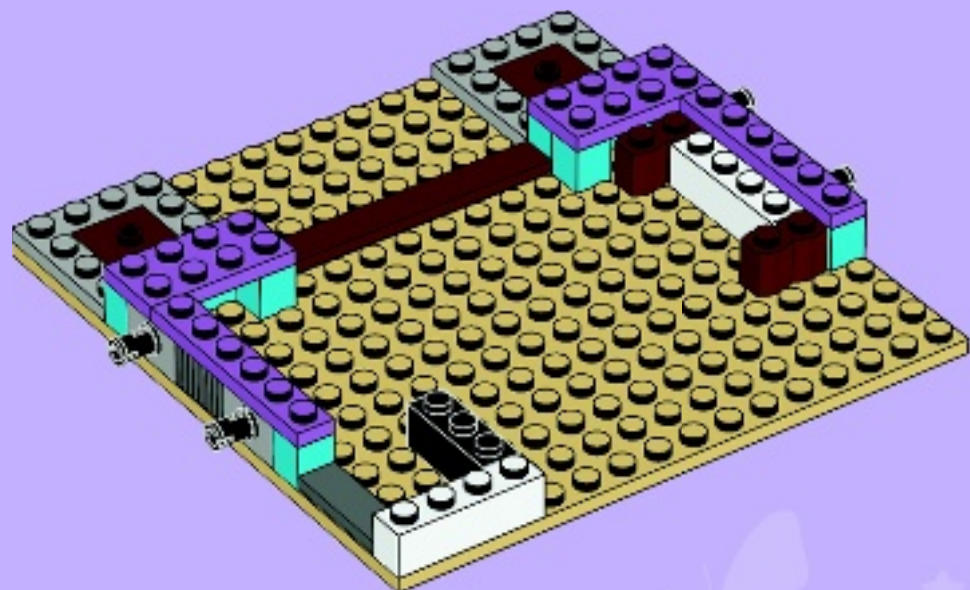



2x

10

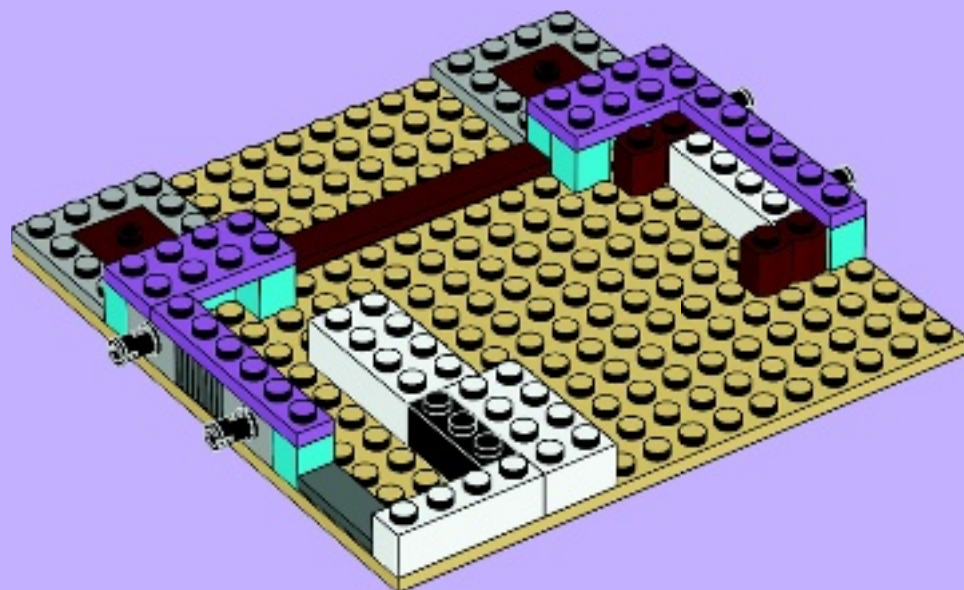



2x



2x

11

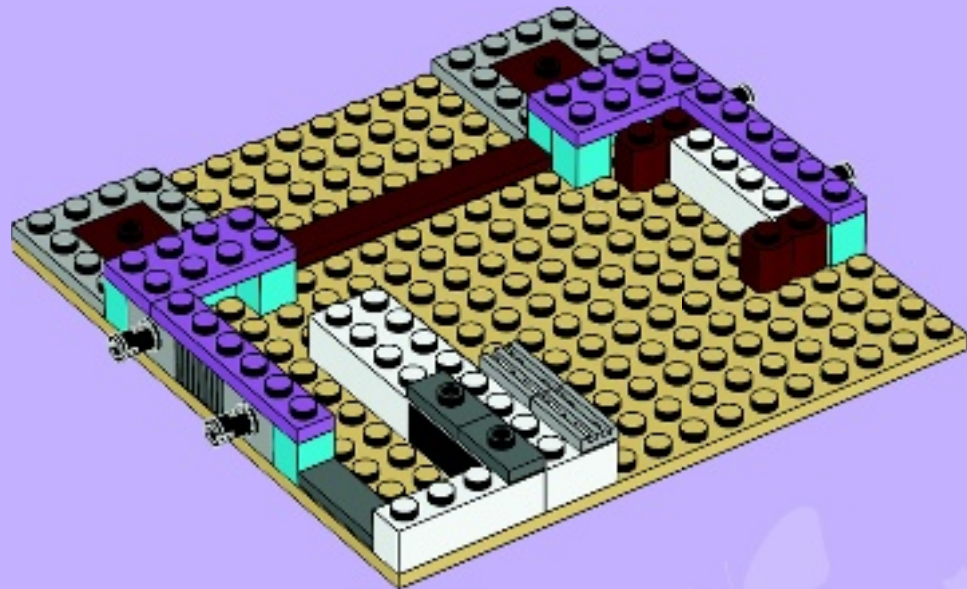



1x



2x

12

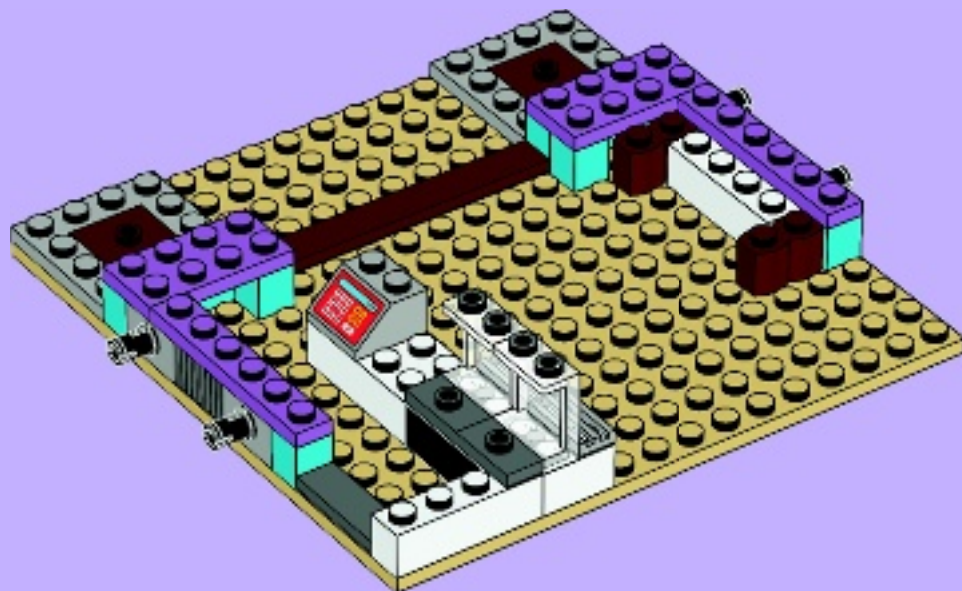

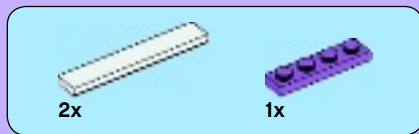



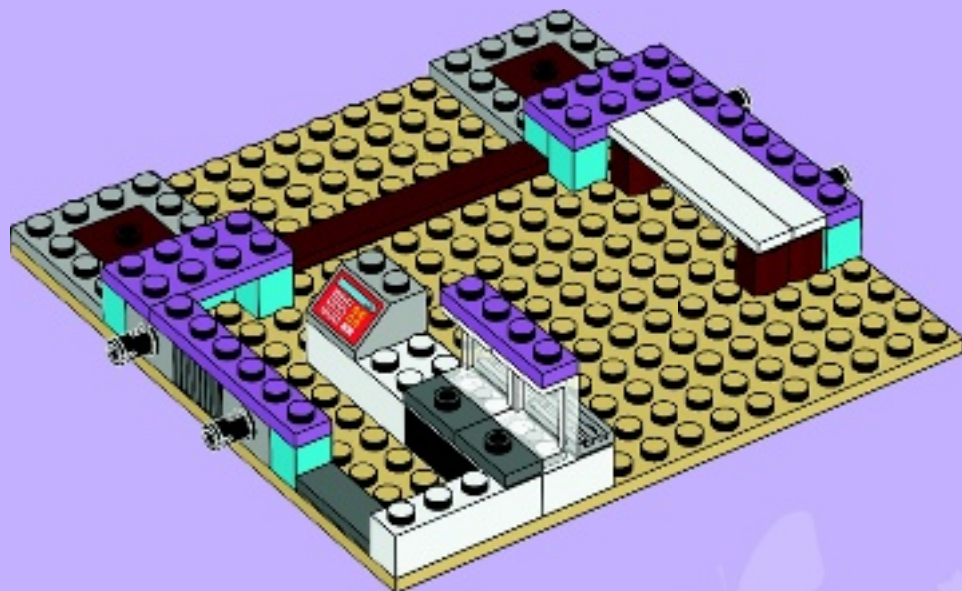

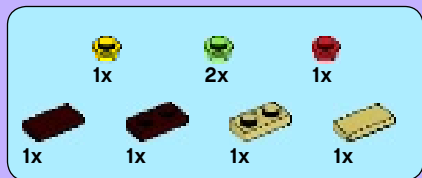
13



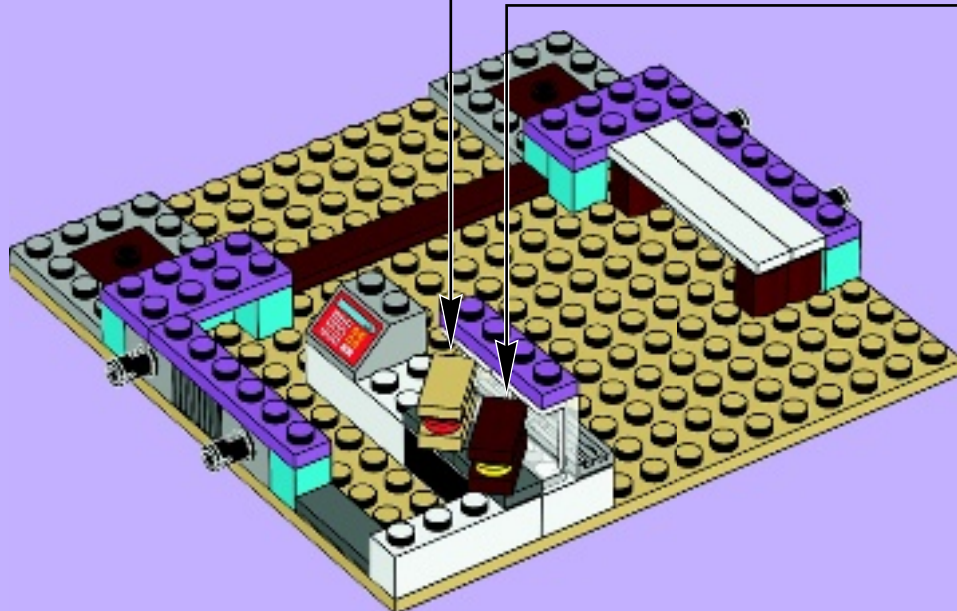
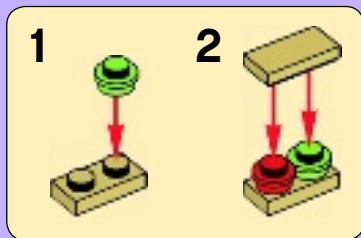

14



			
1x	1x	1x	1x

15

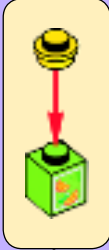

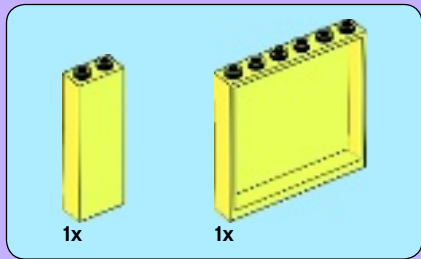

16

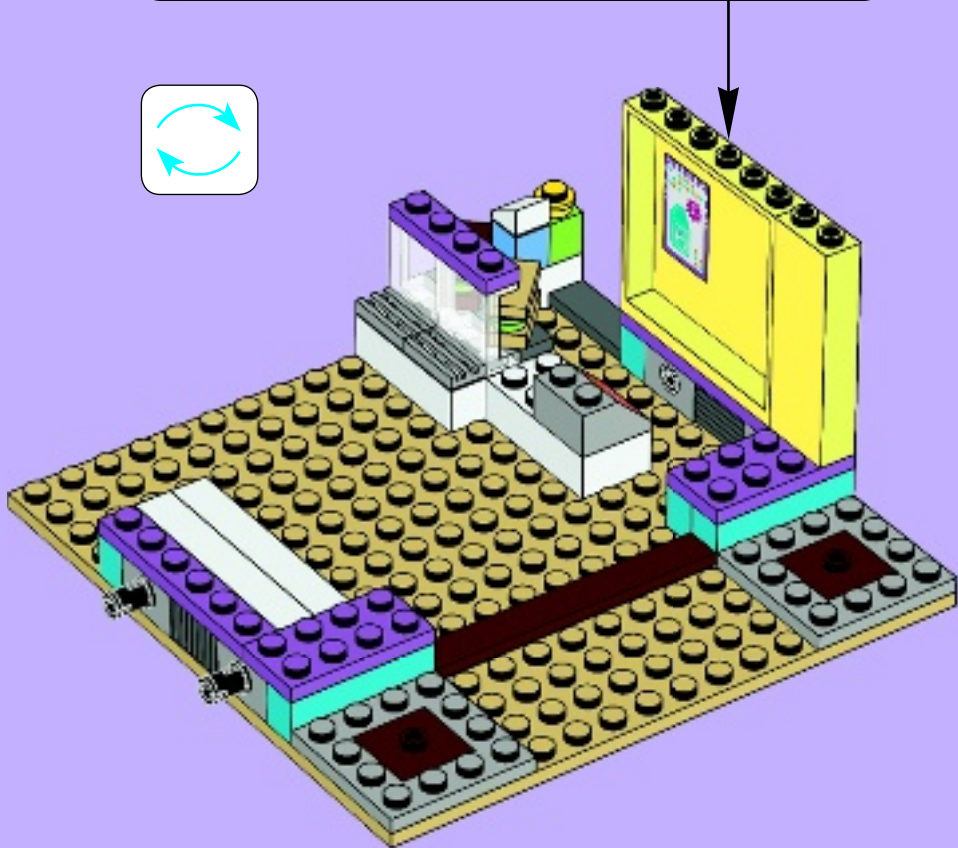
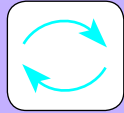
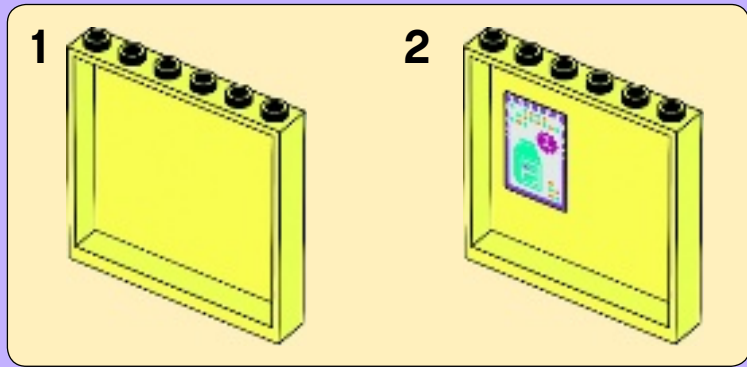

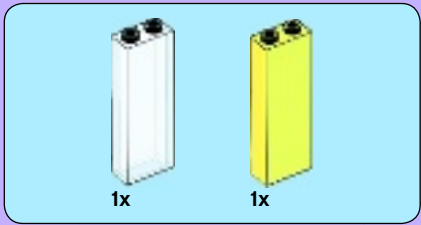

17

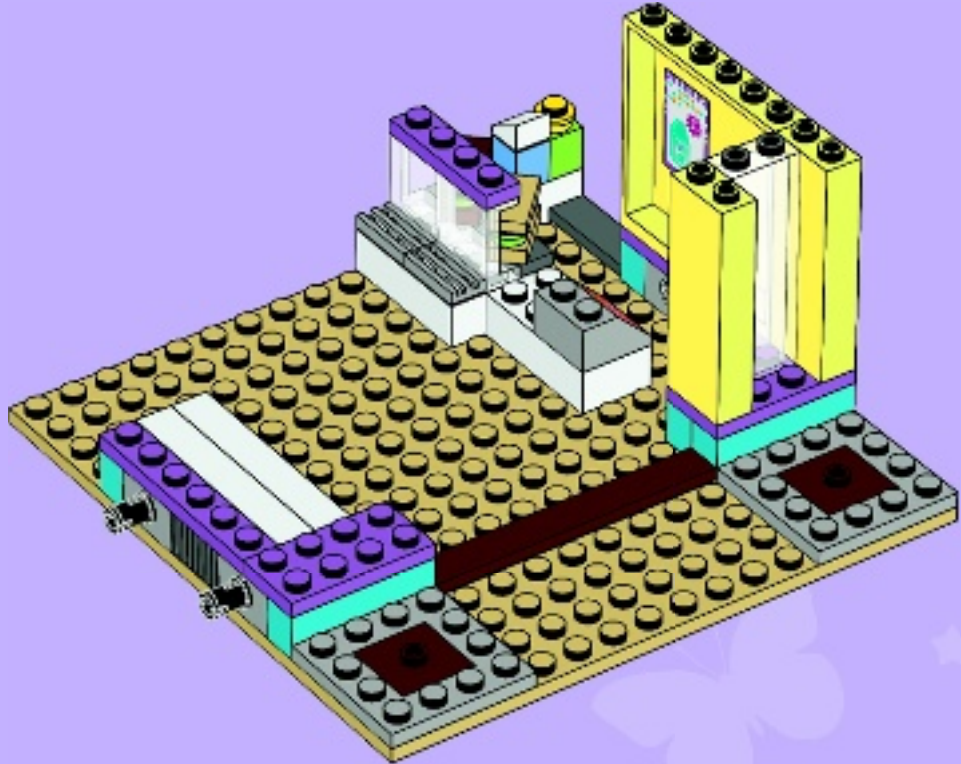

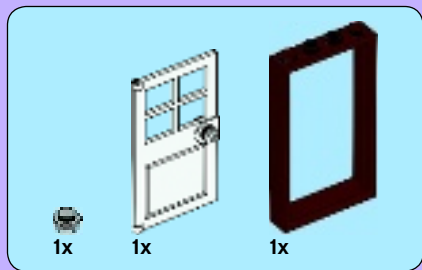

18

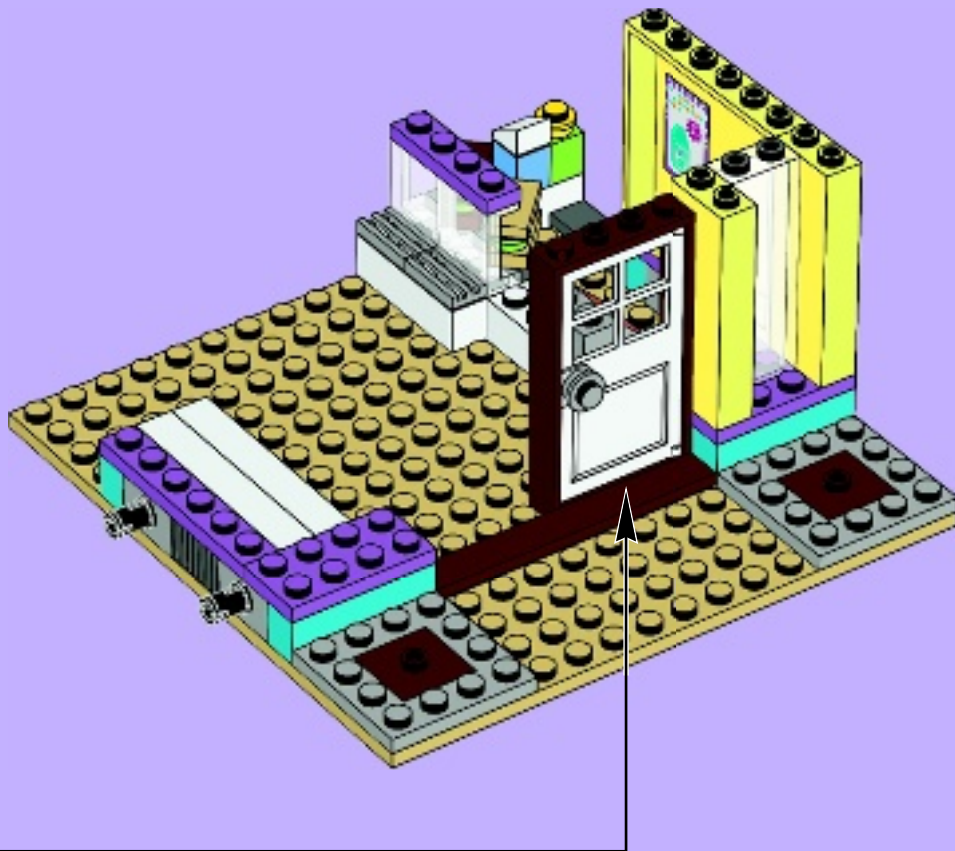
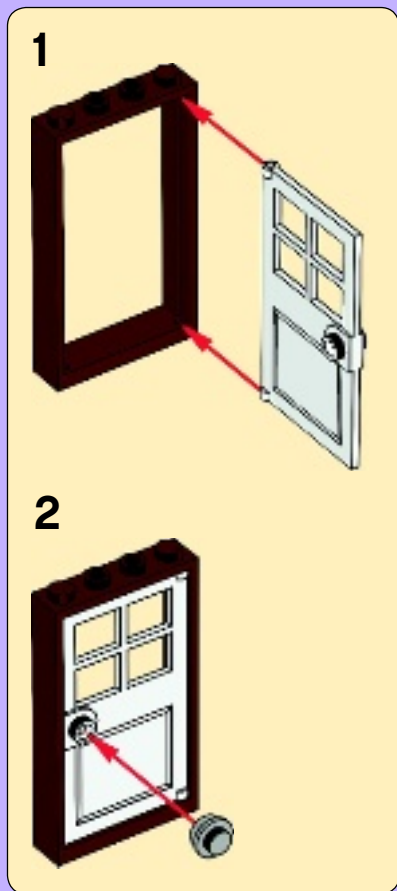

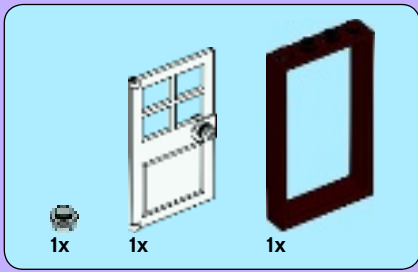

19

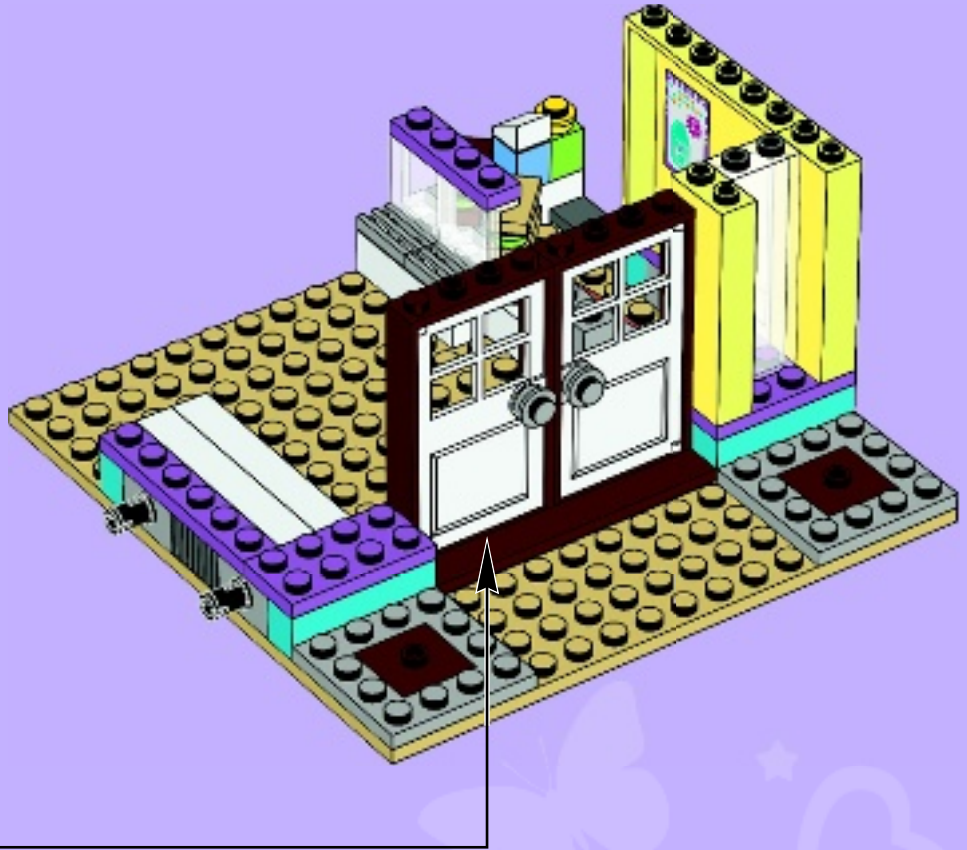
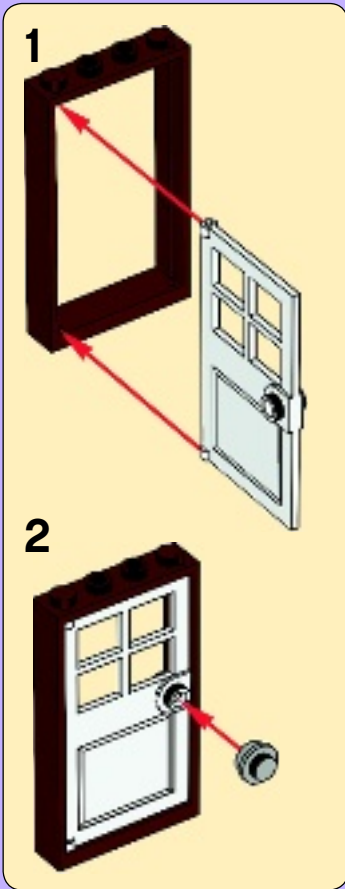



2x

20

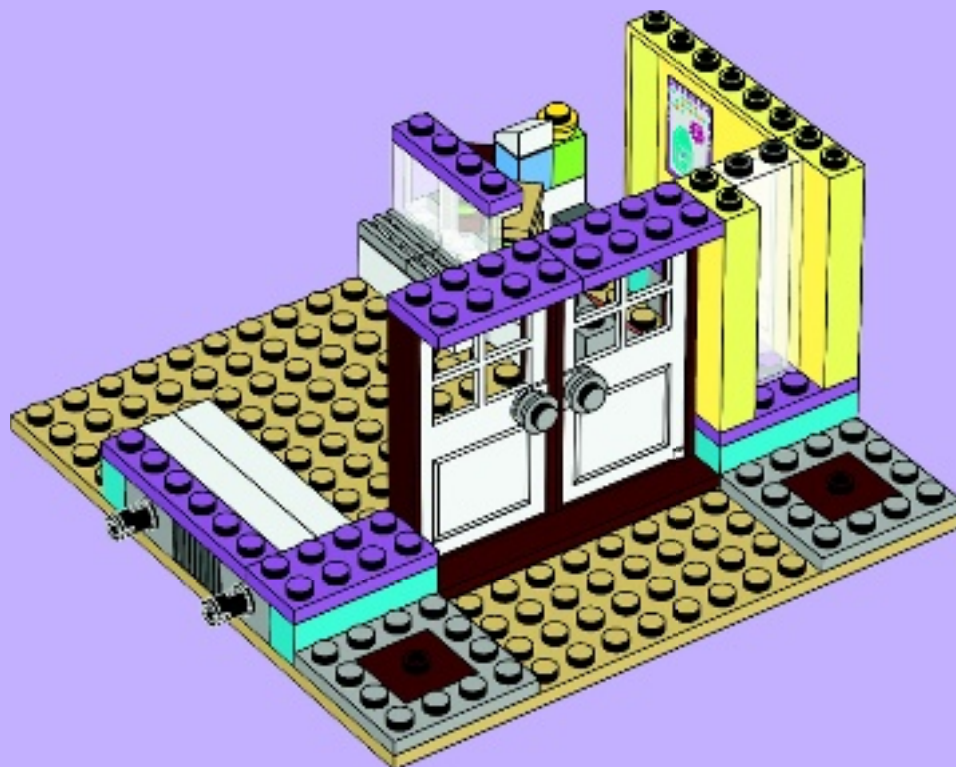

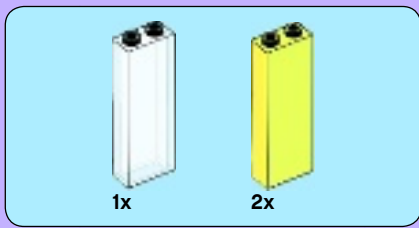

21

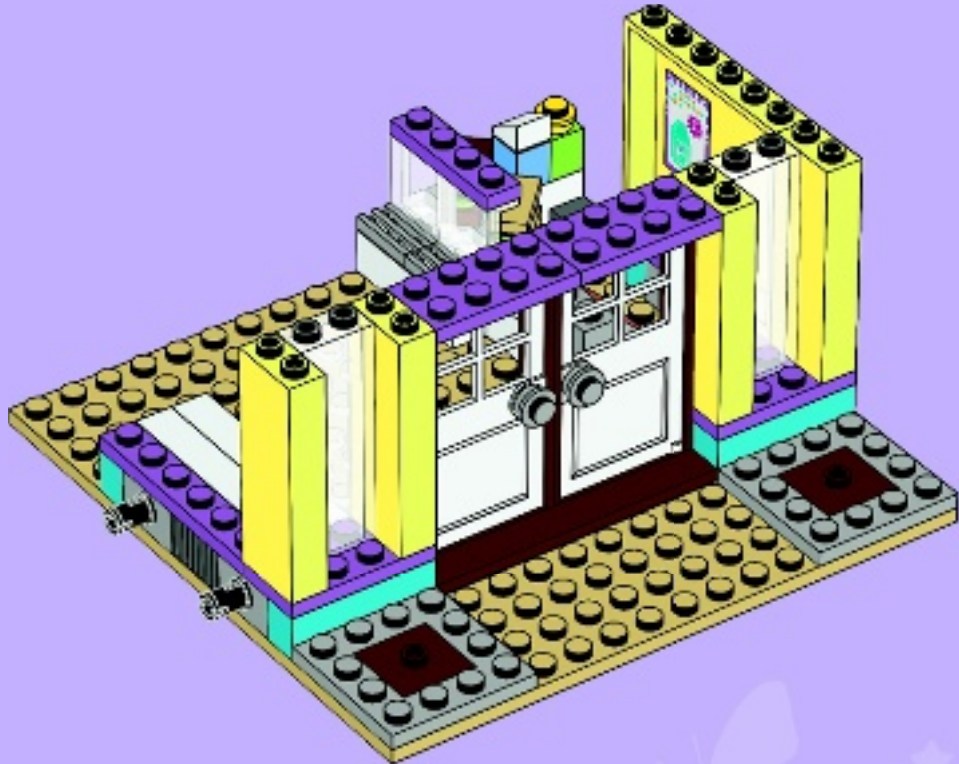

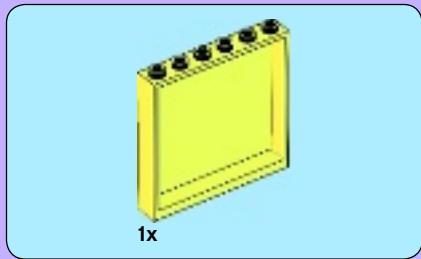

22

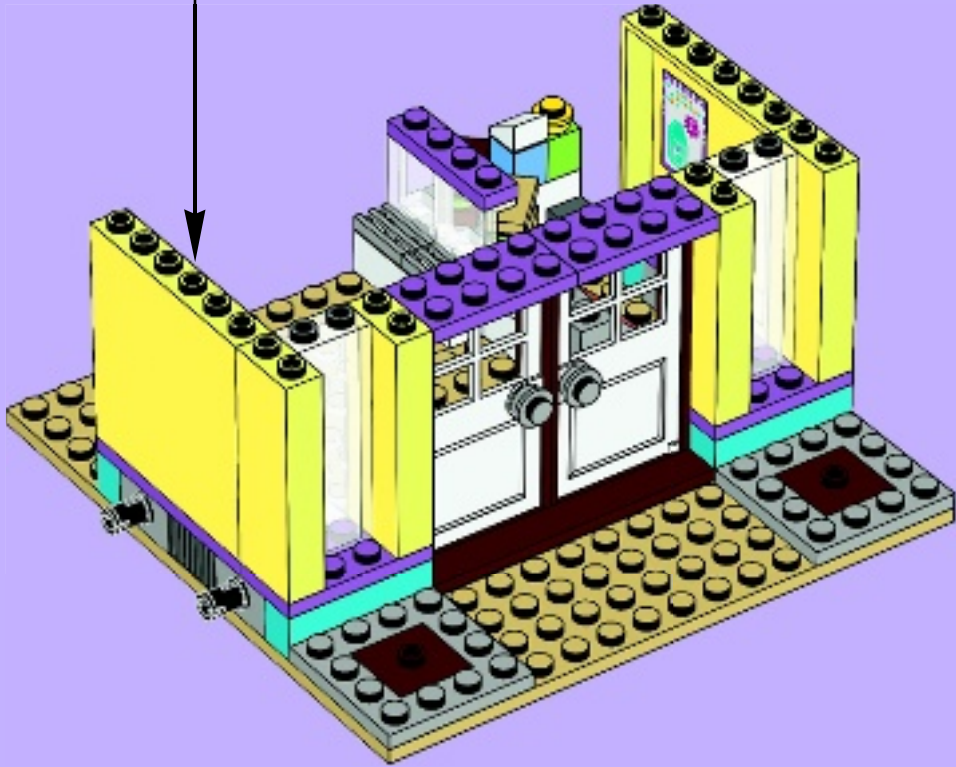
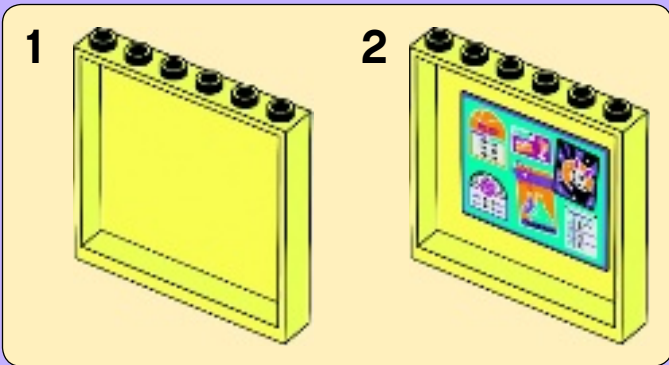



23

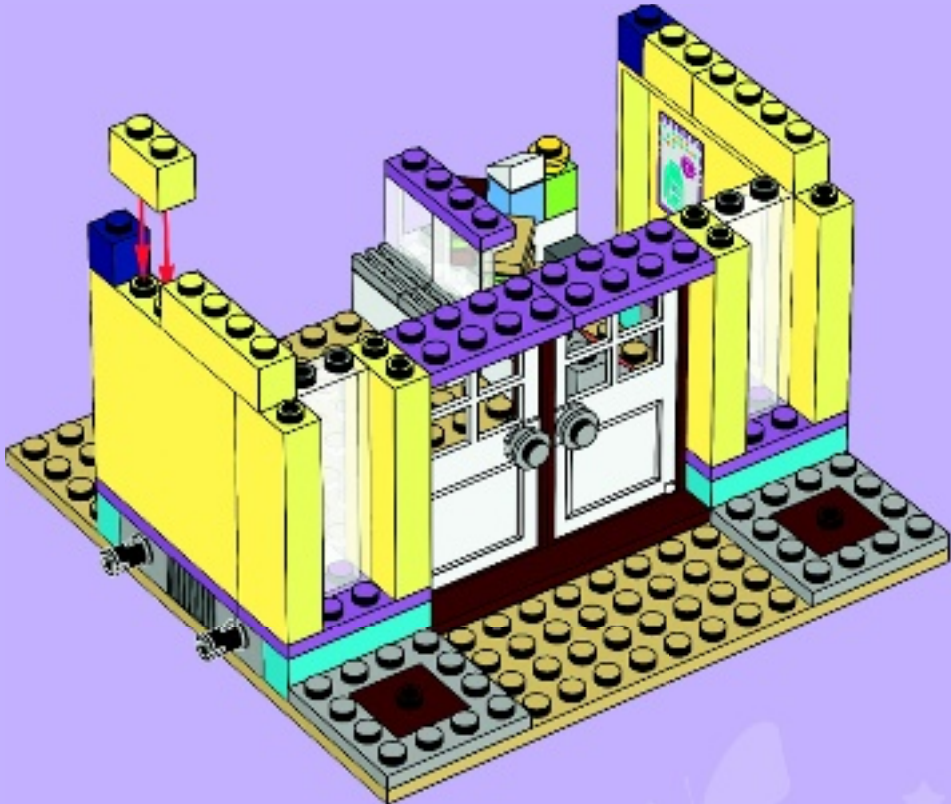



2x

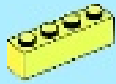

3x

24

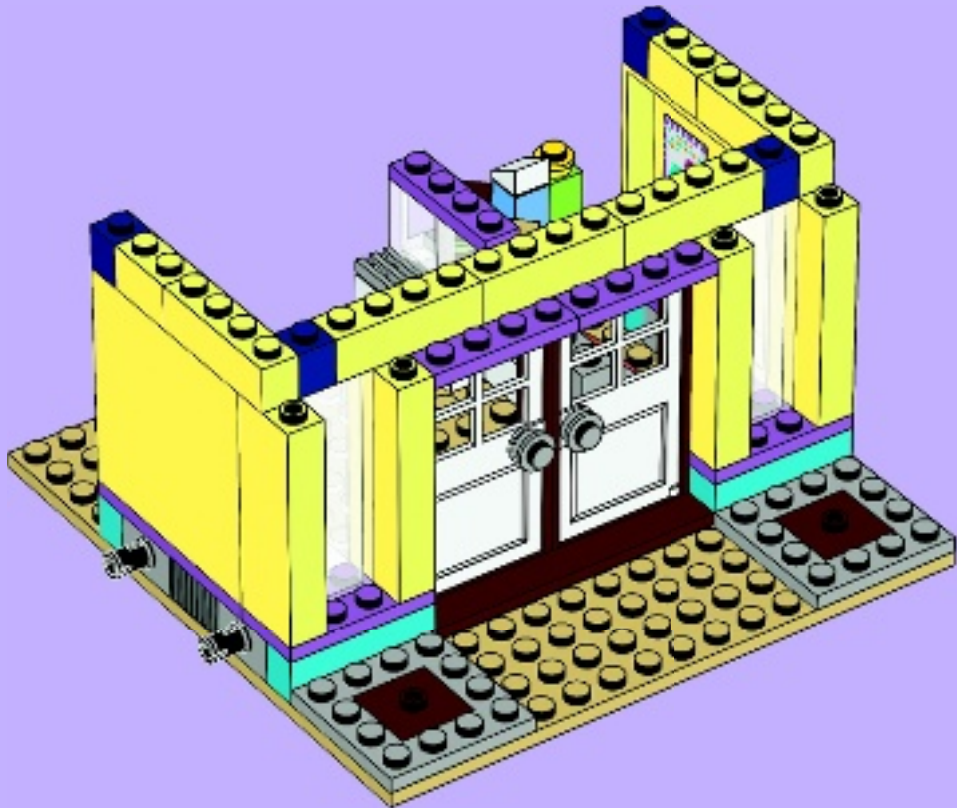

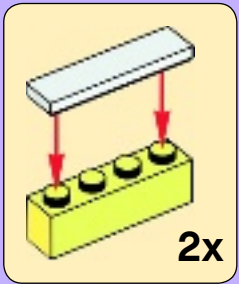

25

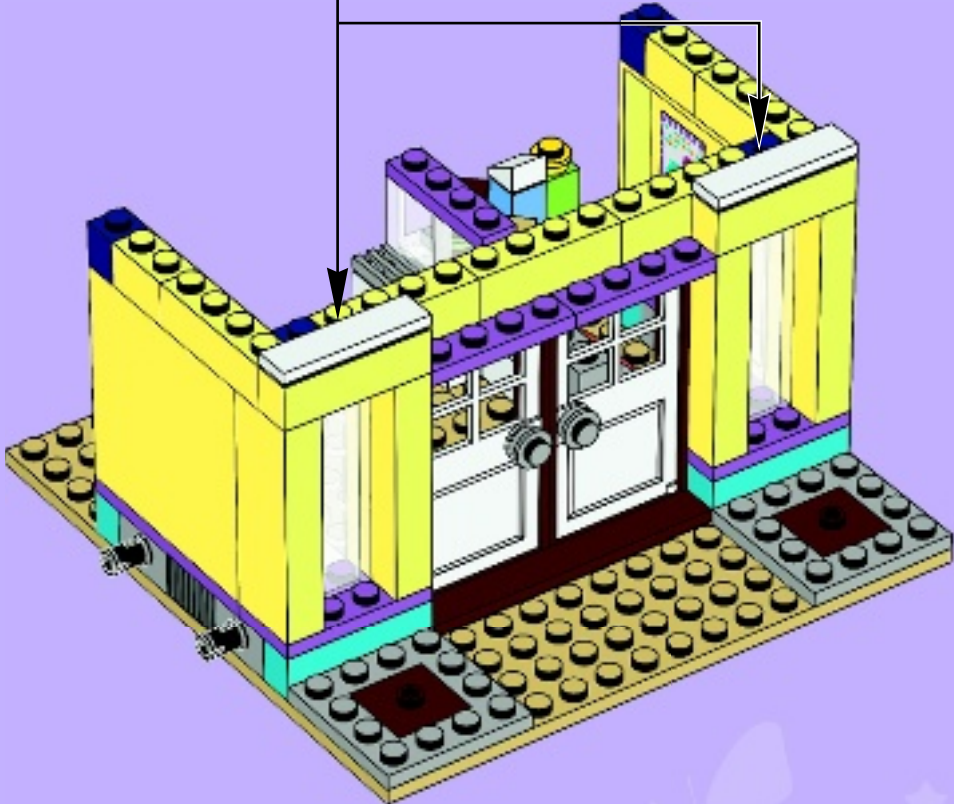



26

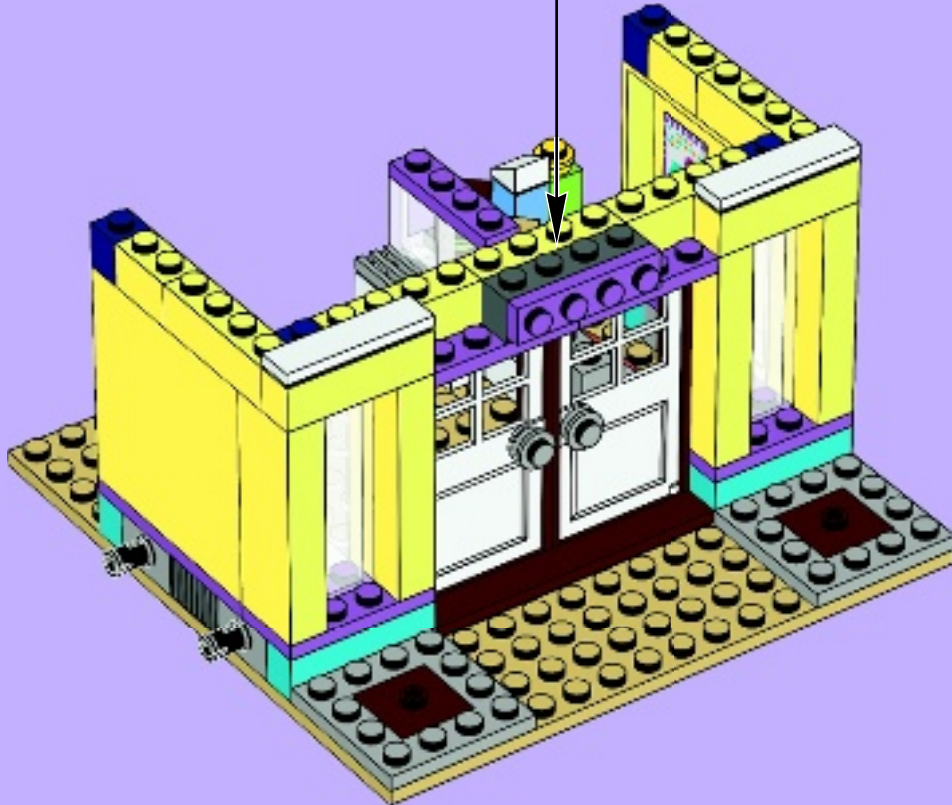
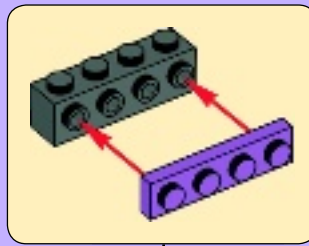

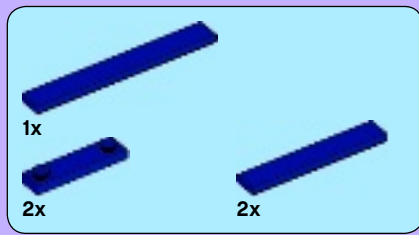

27

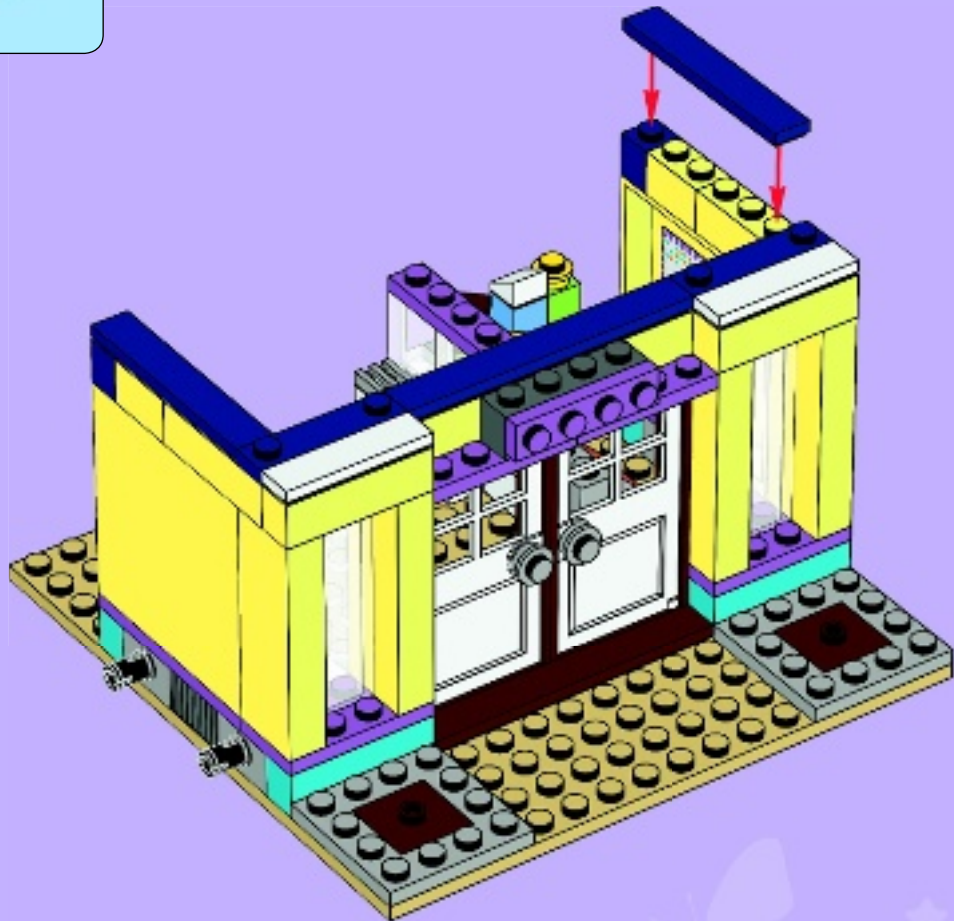

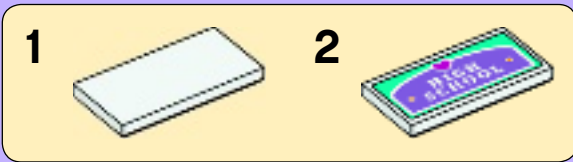
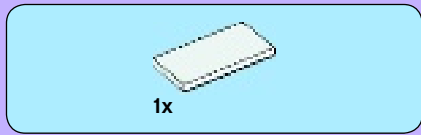

28





2x



2x

29



2x

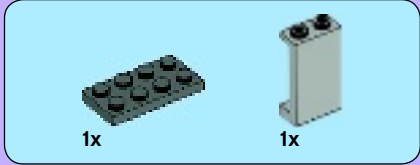
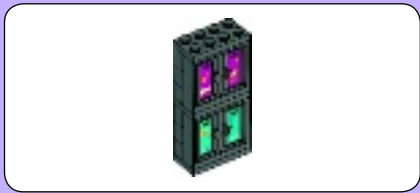

1



2

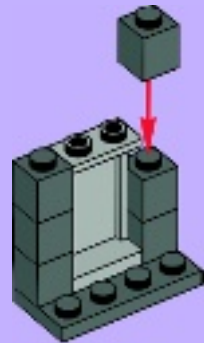

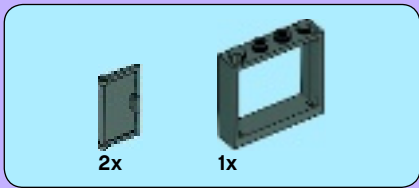

3

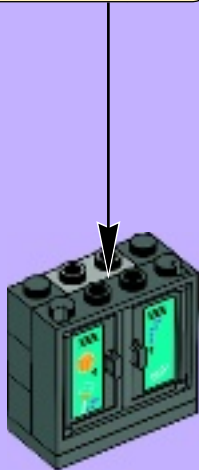
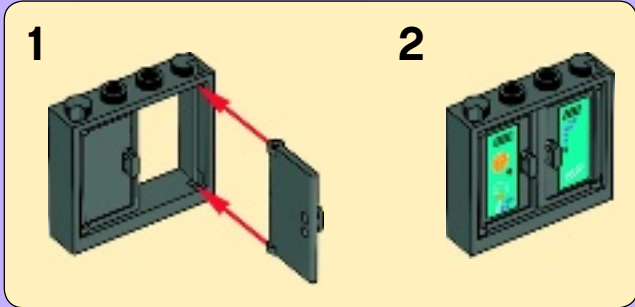

4





5



6



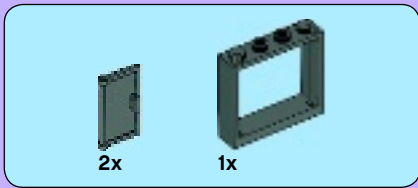

7

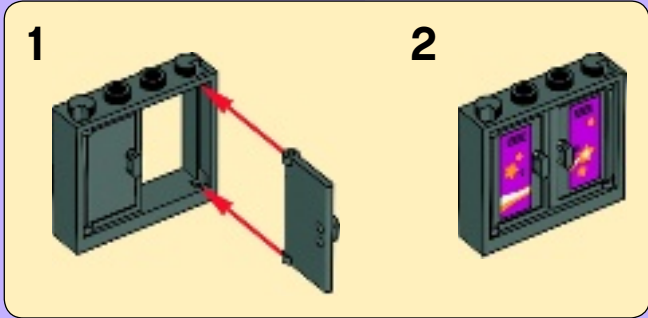

8



30

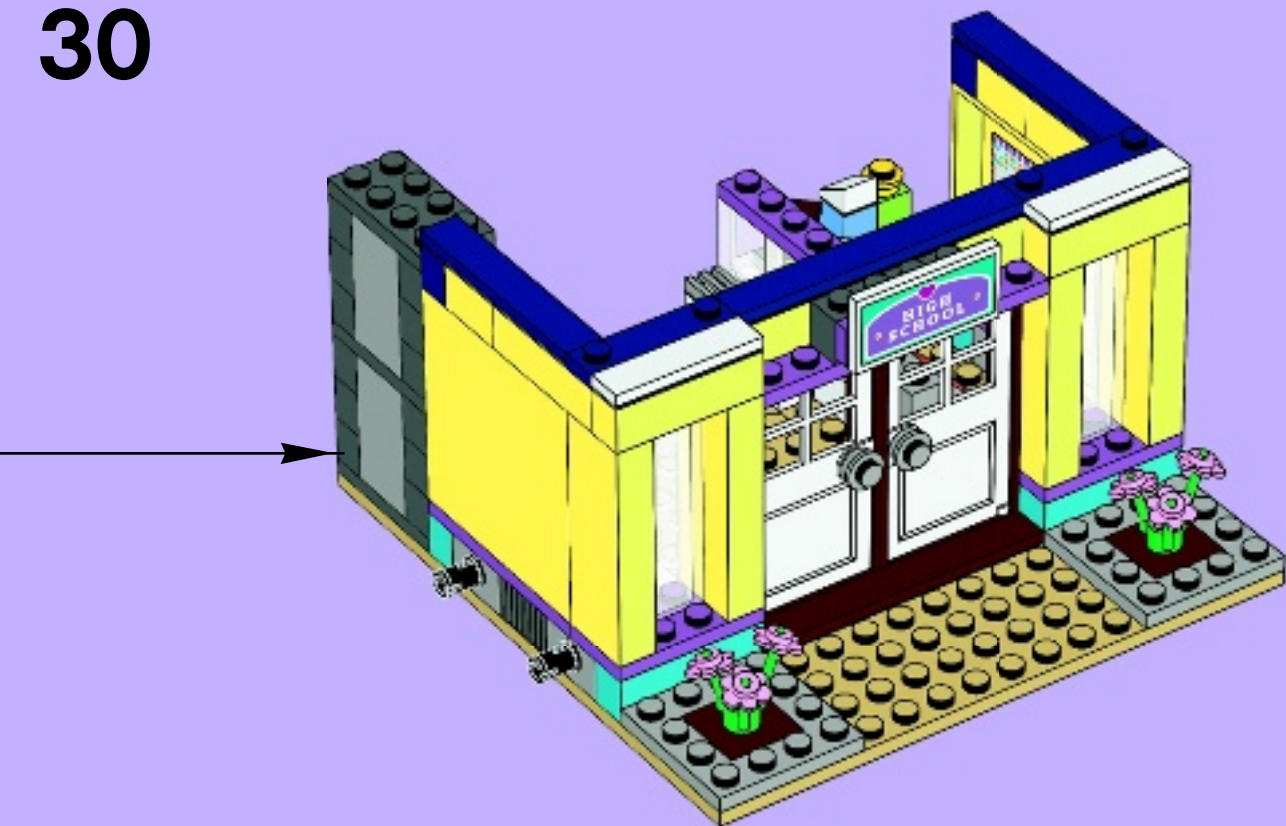

31

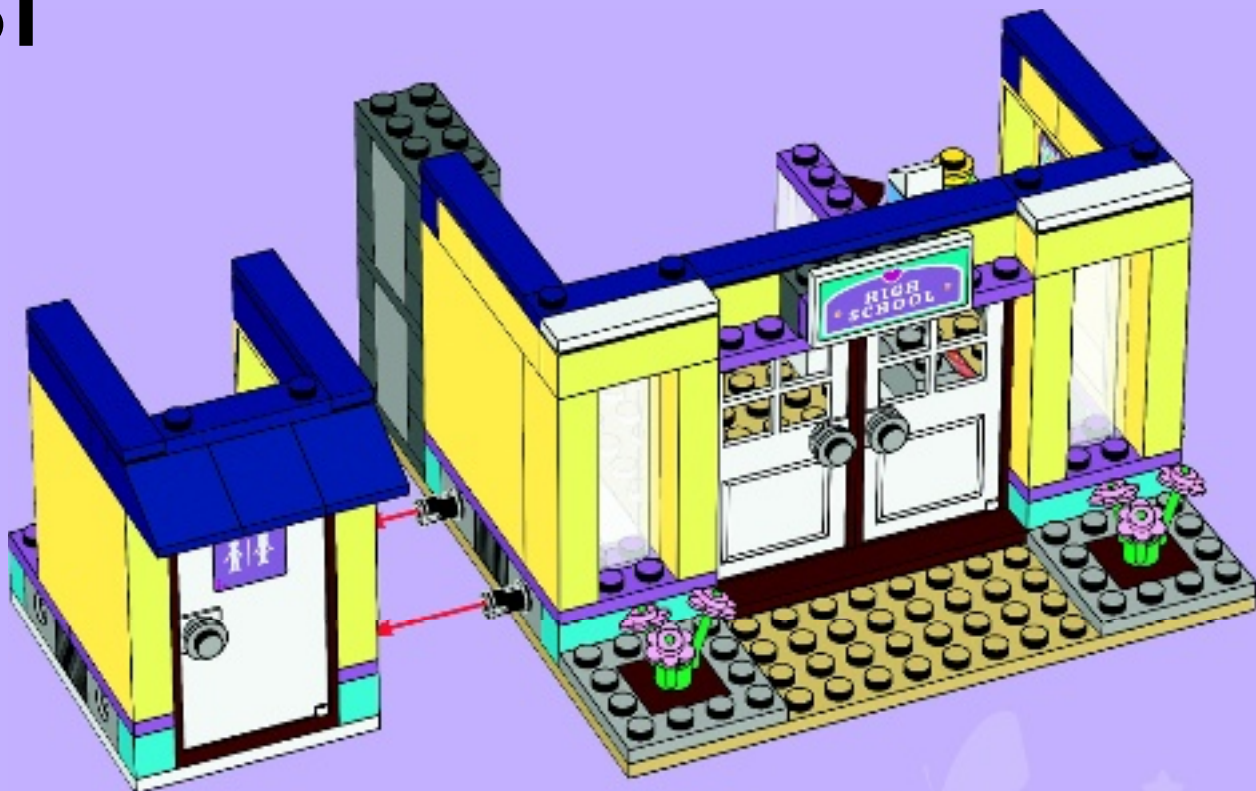



Andrea



Mia



Stephanie



Friends



Emma



Olivia



■ 41005



■ 41006



■ 41009



■ 41010



■ 41013



■ 41015



Friends





Friends



41005



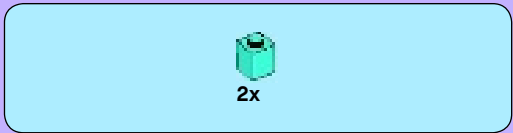
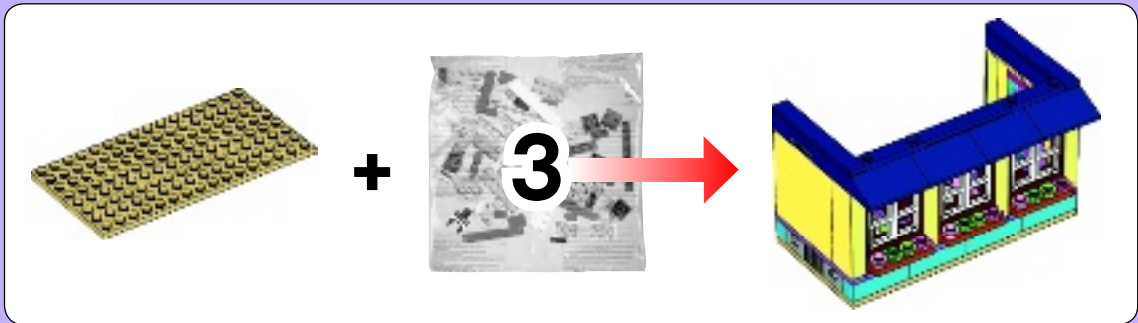

1

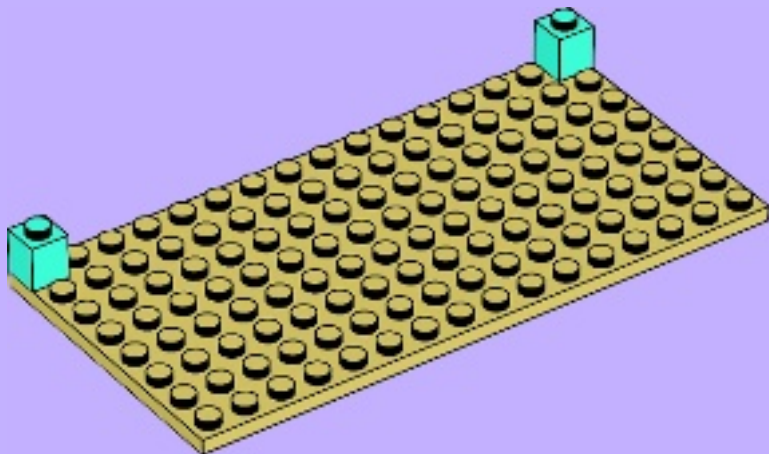



2x



4x

2

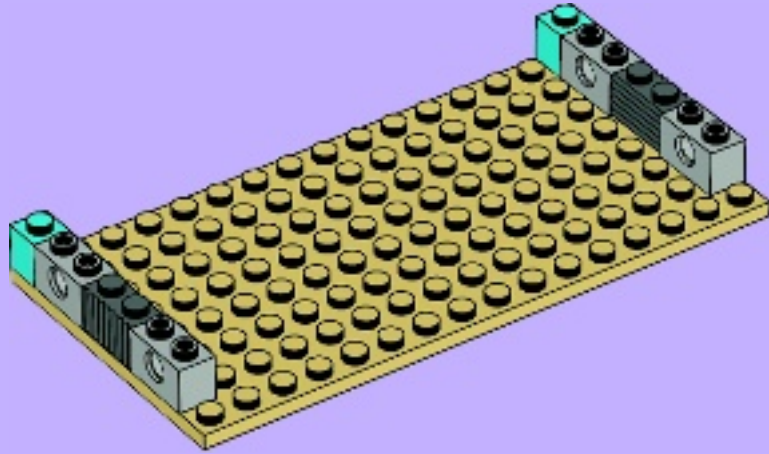

4x

3

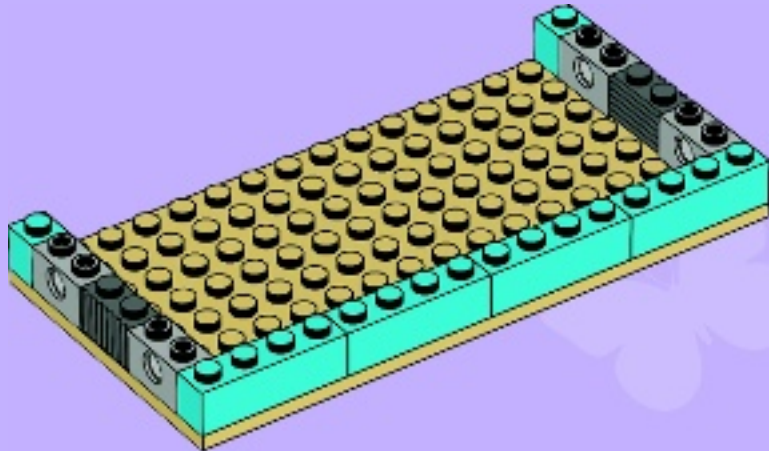

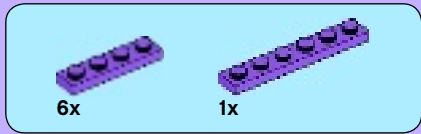

4

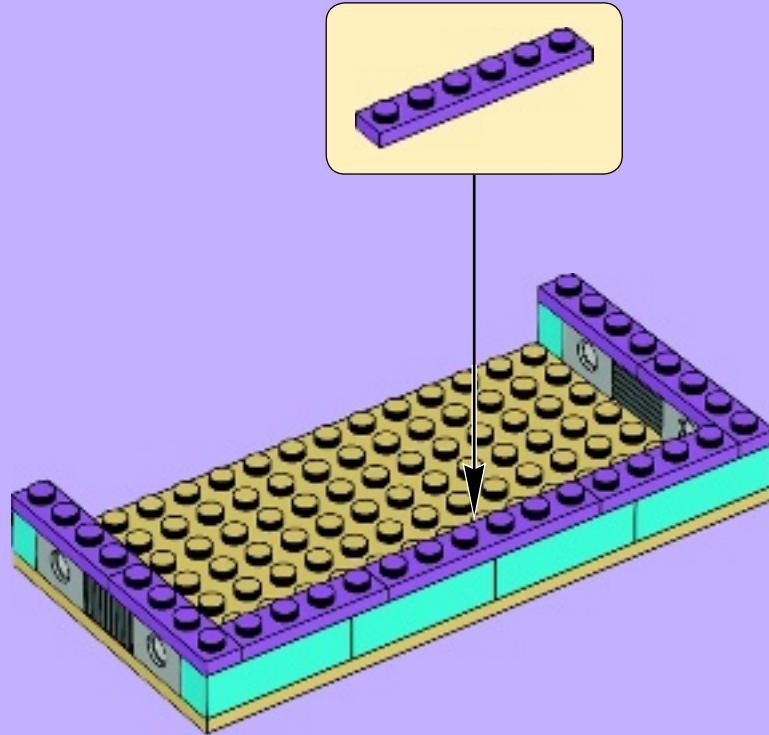

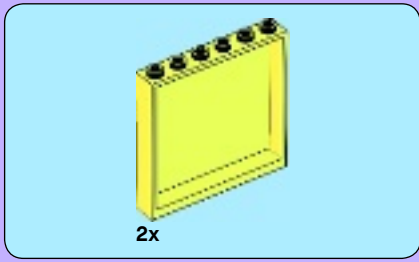

5

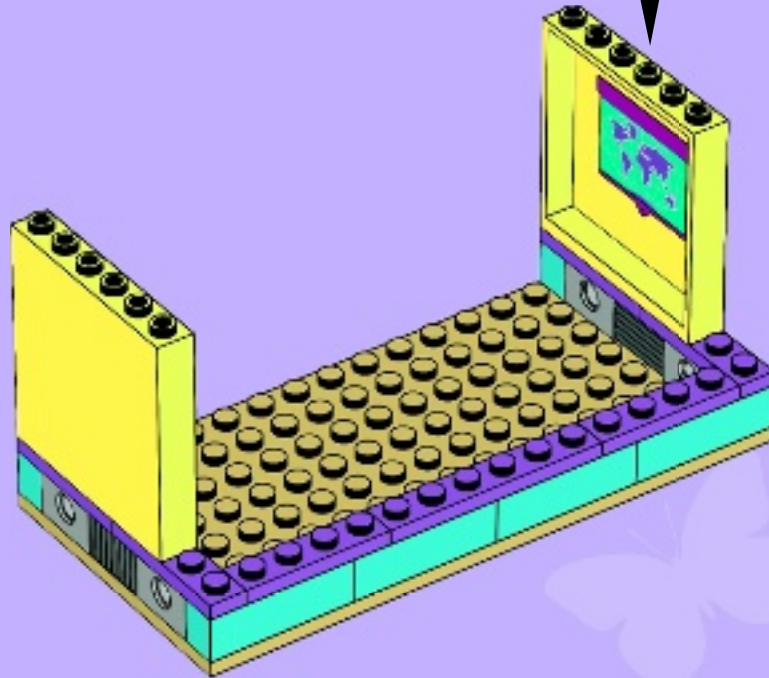
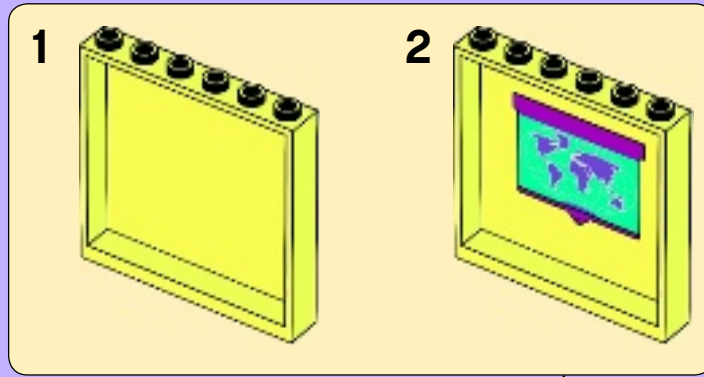

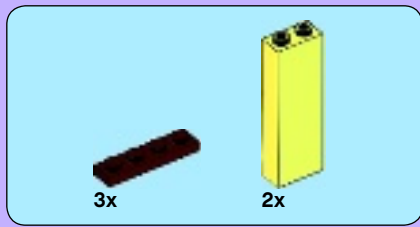

6

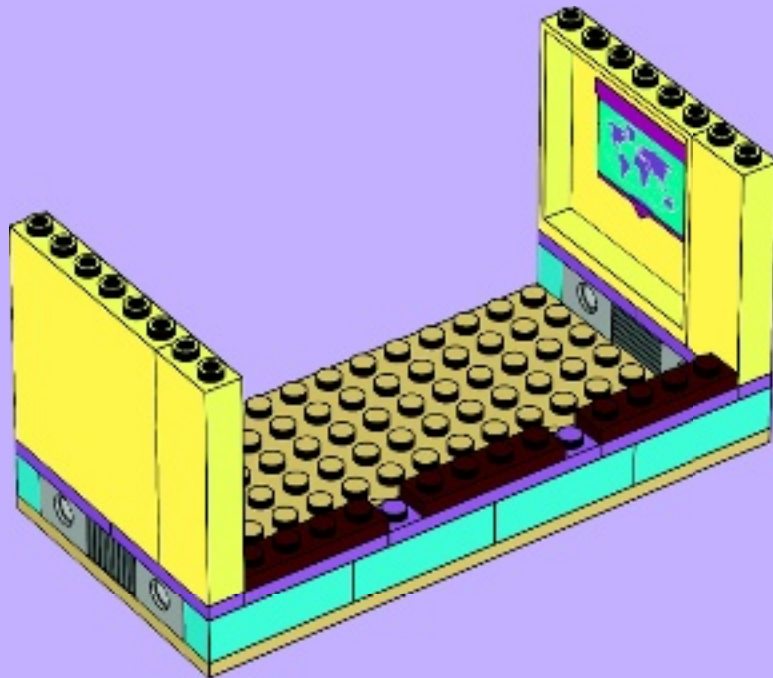

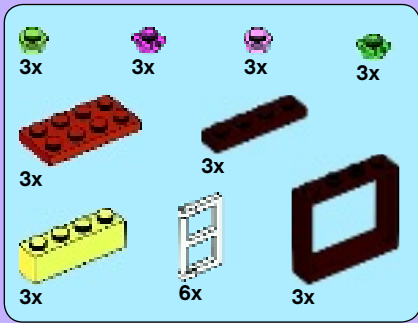

7

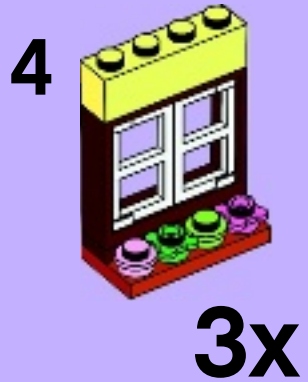
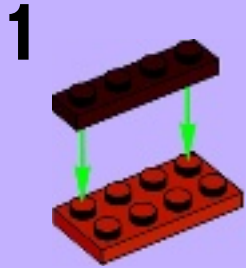
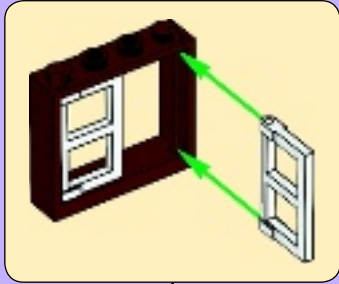

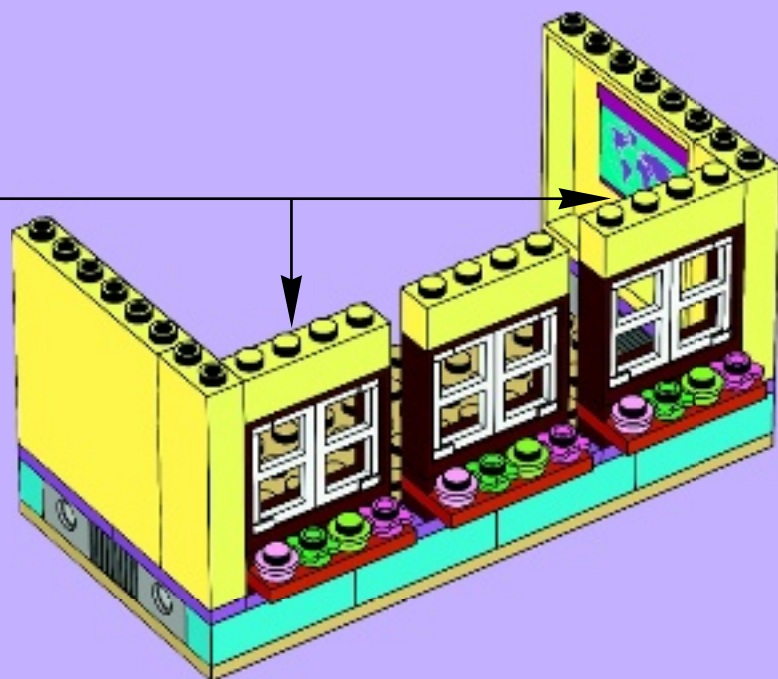

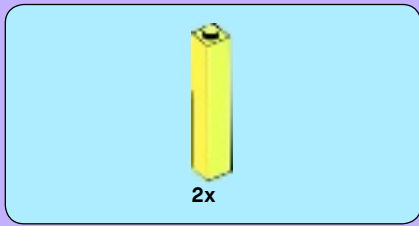

8





9

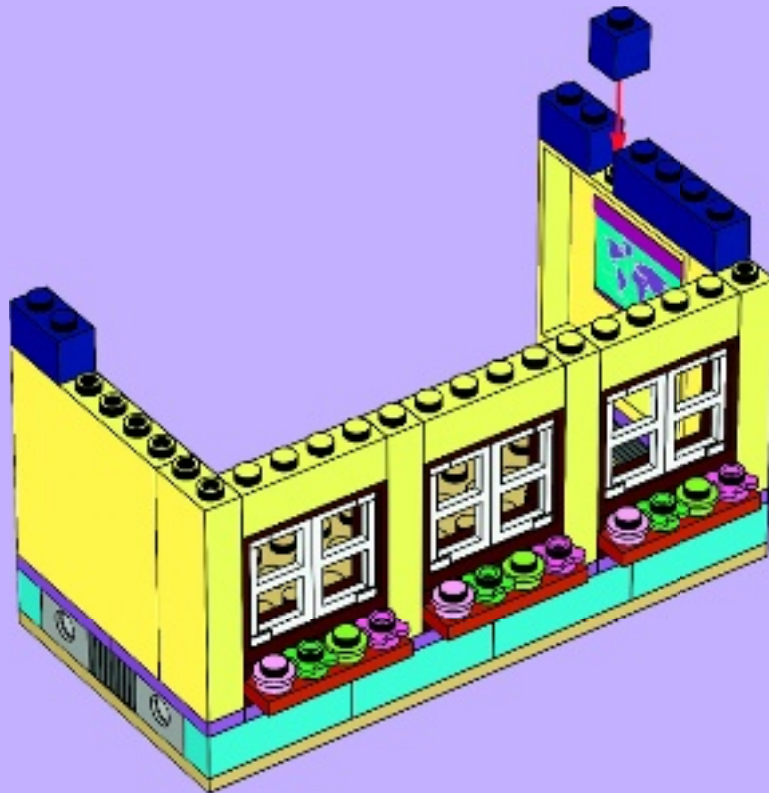



1x



2x

10

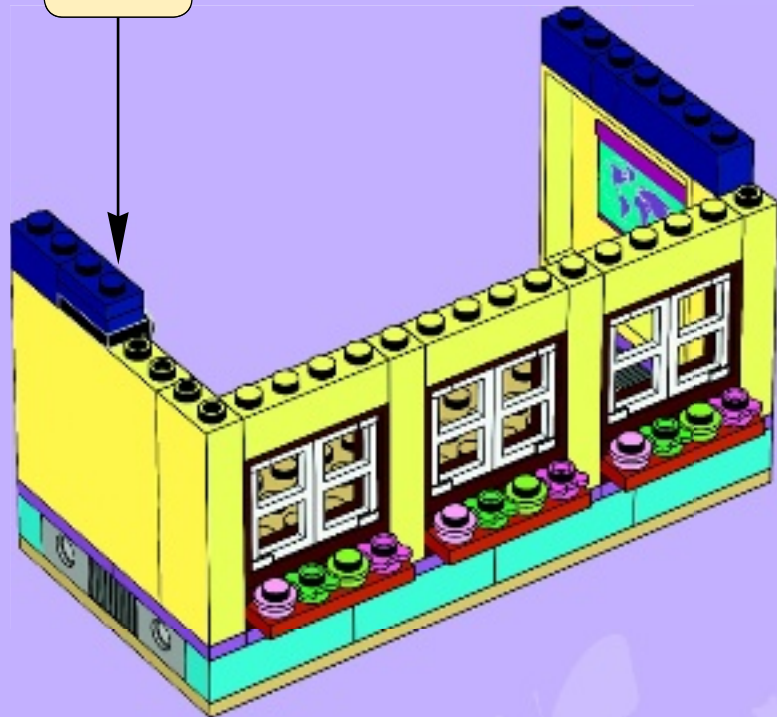
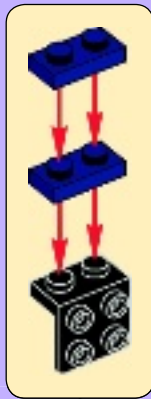



1x



1x

11

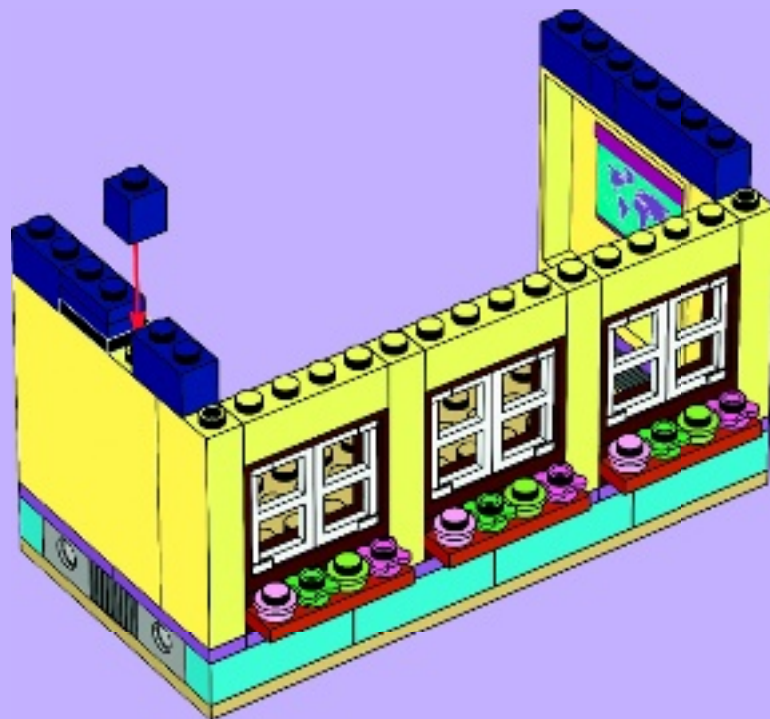



4x

12

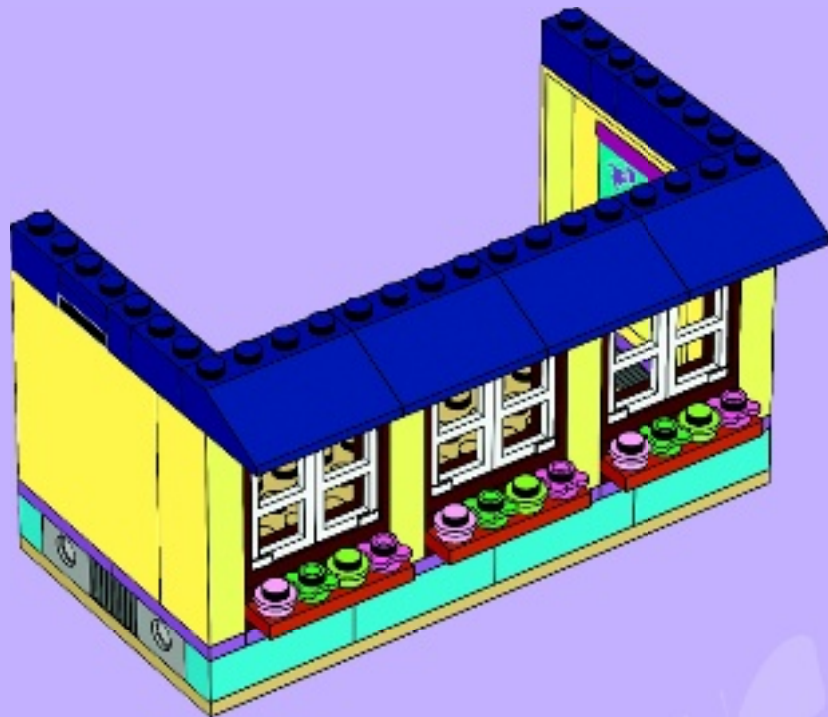

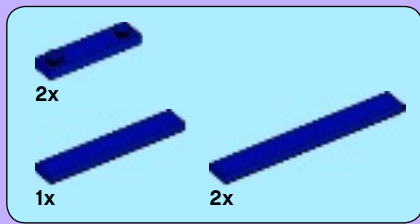

13

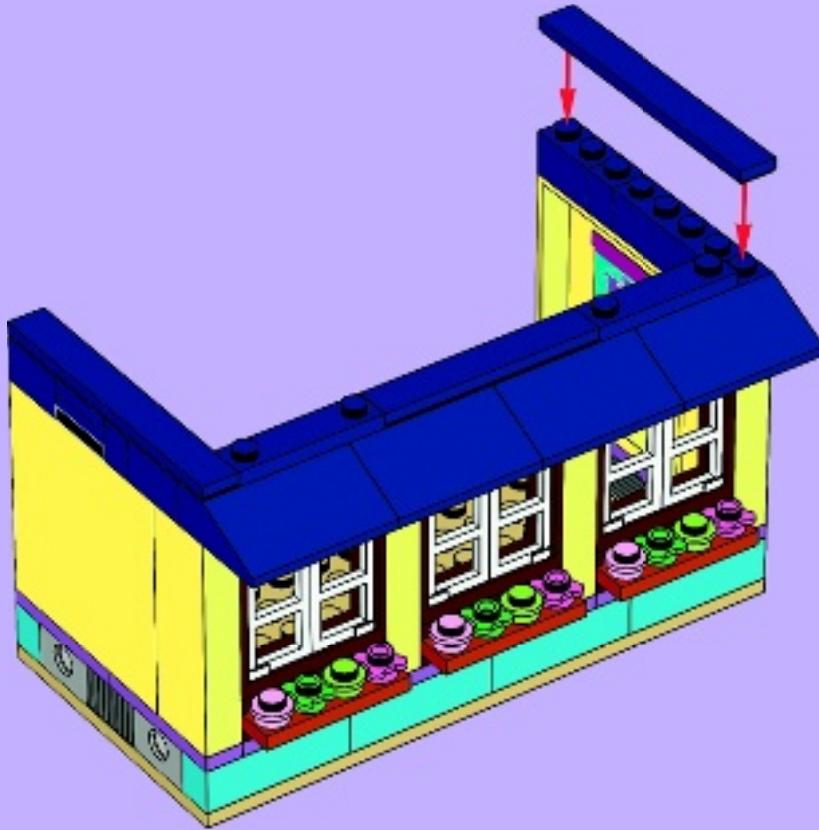

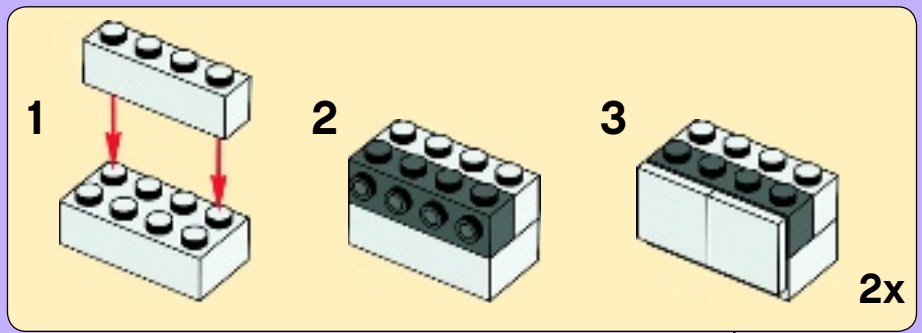
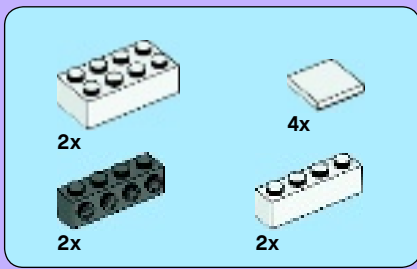

14

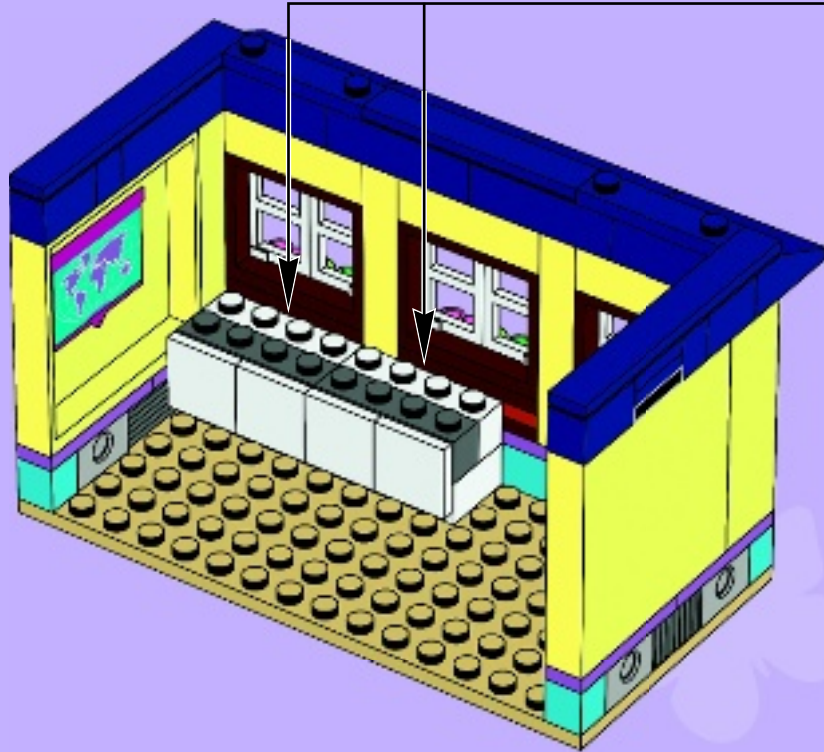
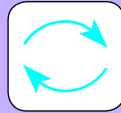



2x



3x

15

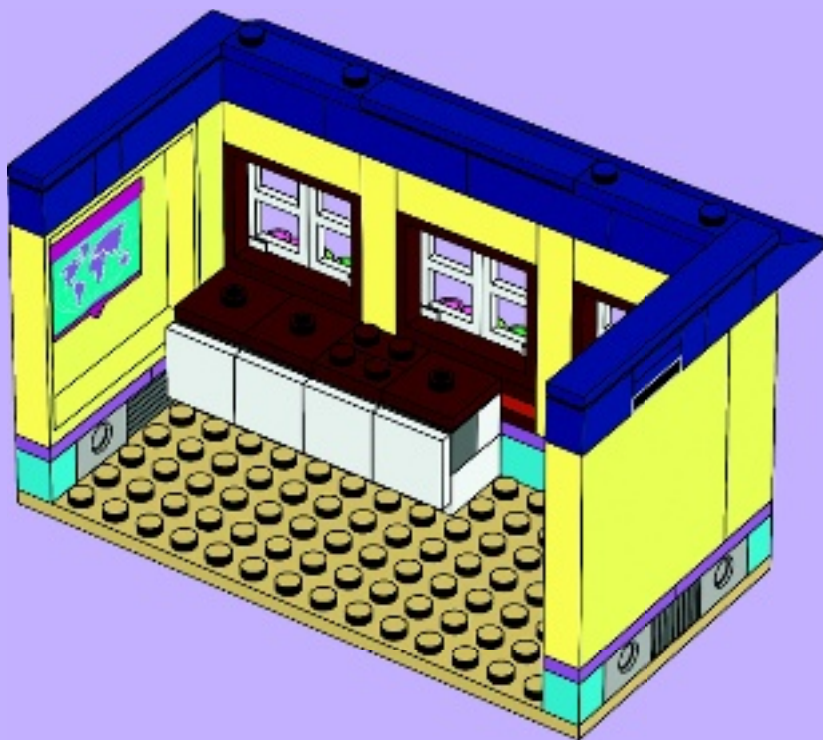



16

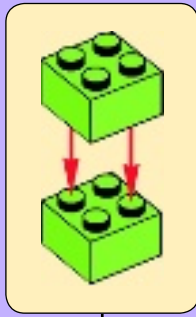



1x



1x

17

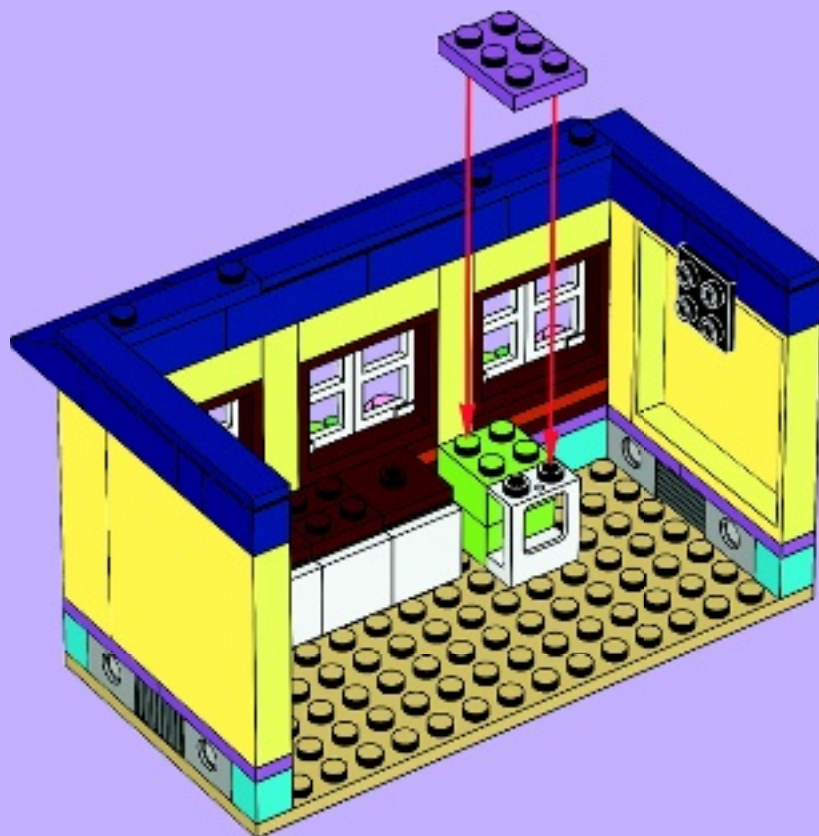

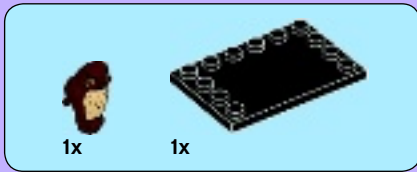

18

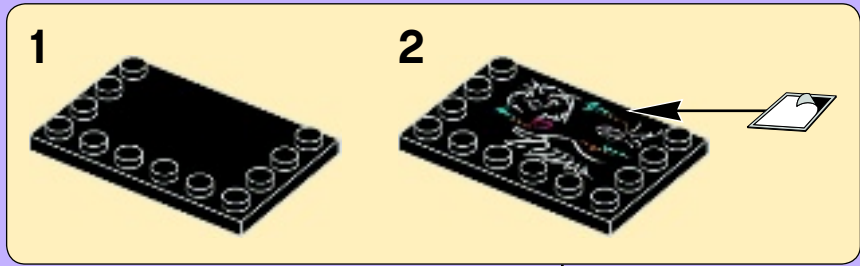



1x



1x

19

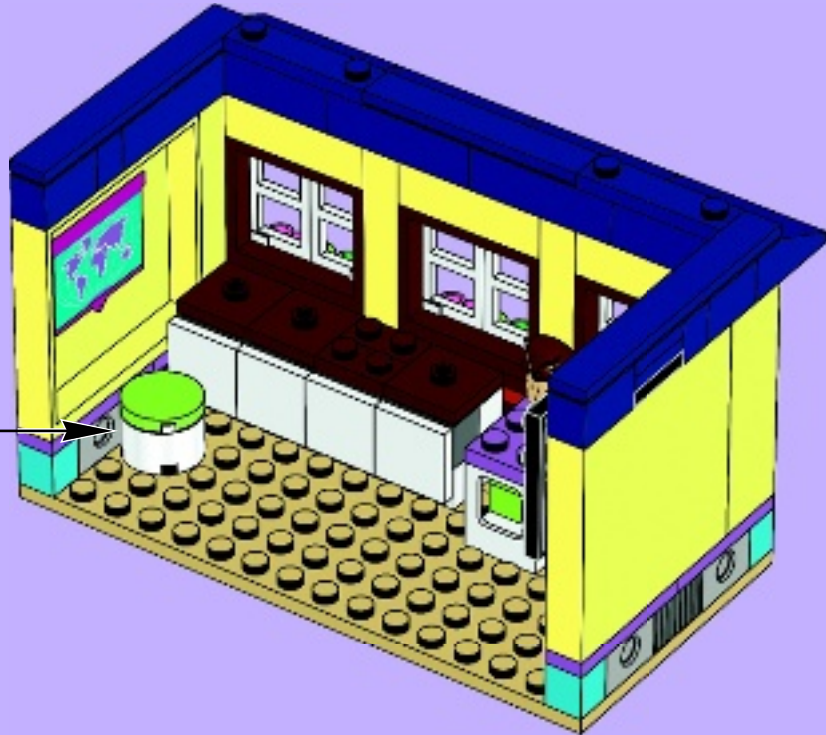
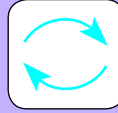

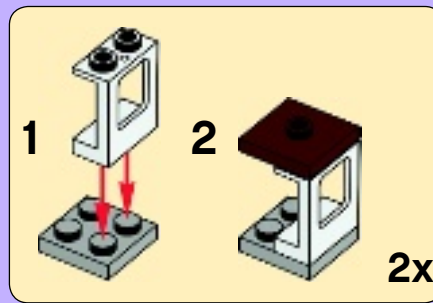
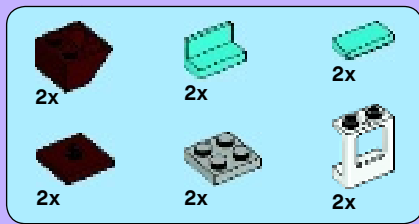

20

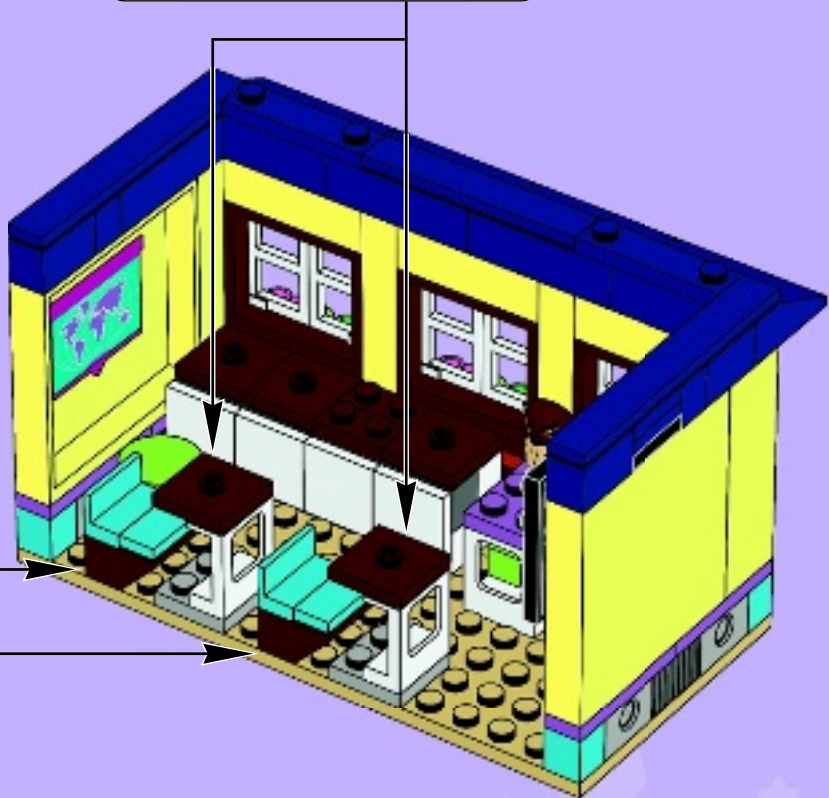
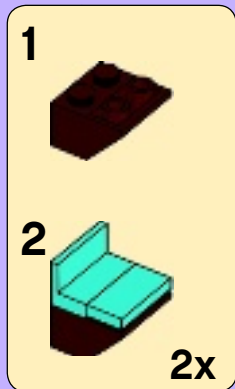

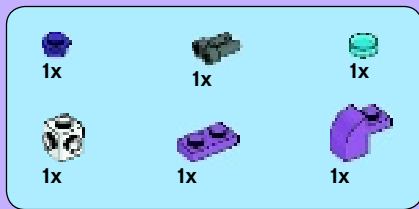





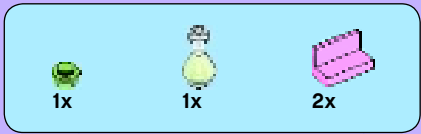

21

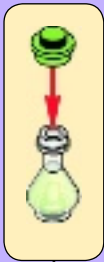



22



- 2x 
- 1x 
- 1x 
- 2x 
- 1x 

23

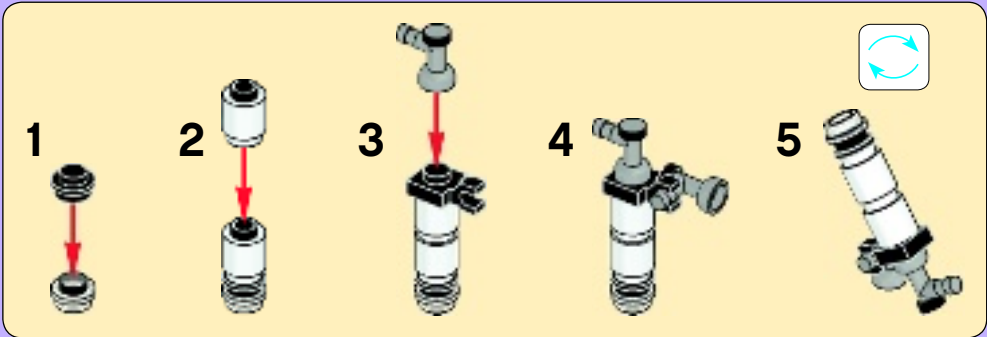

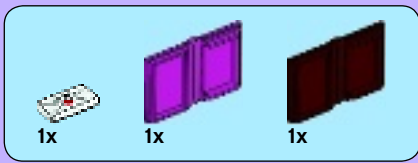

24



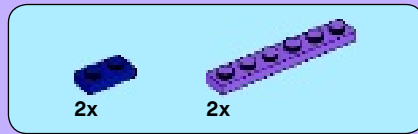
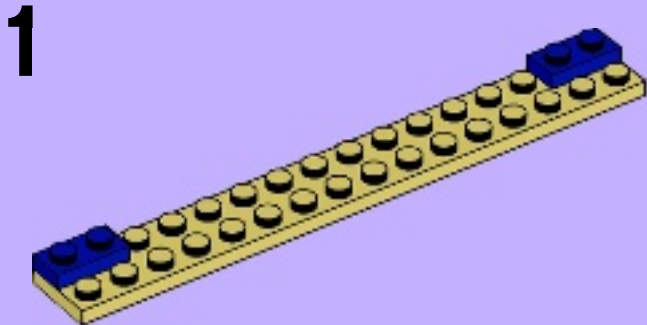
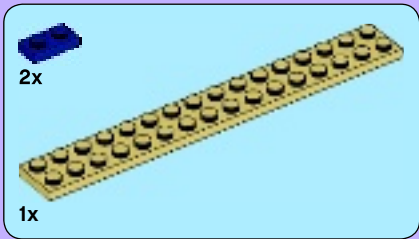
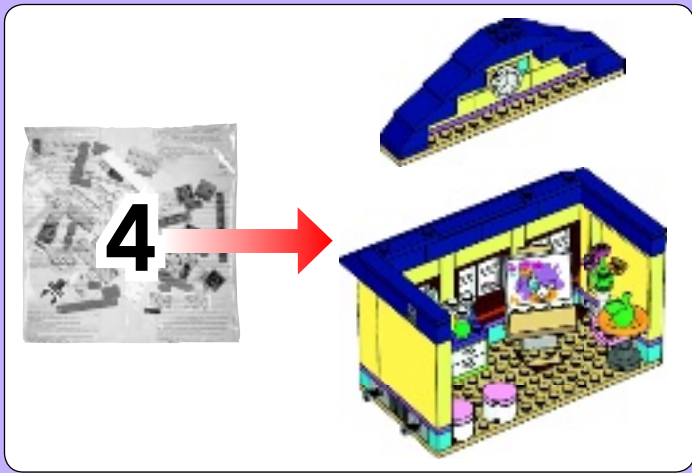

2

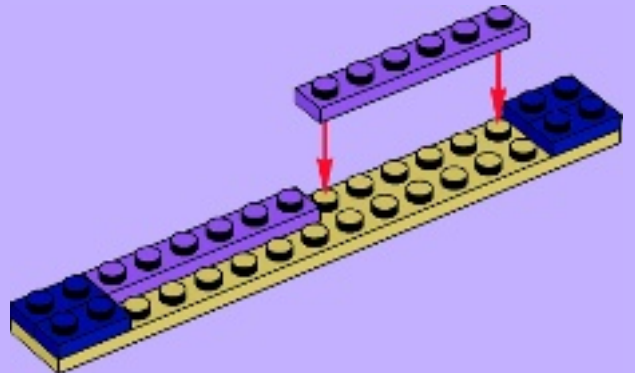



3

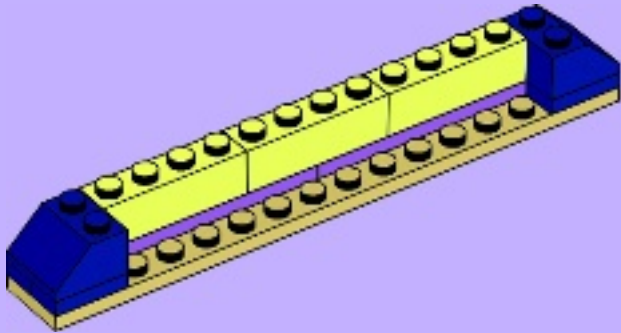

4

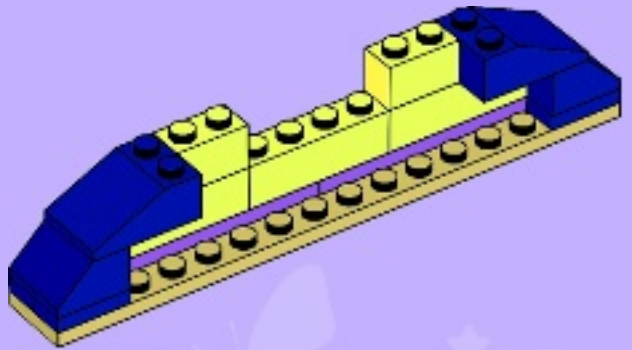



2x



1x

5

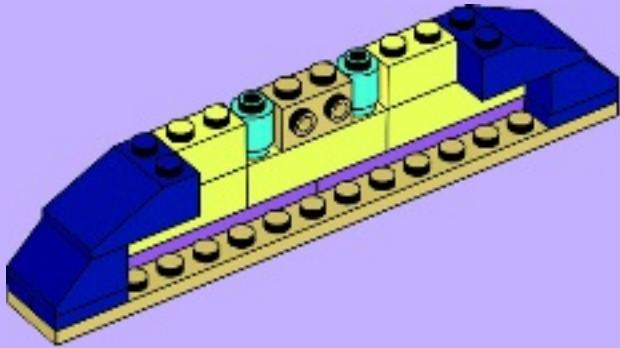

2x



1x

6

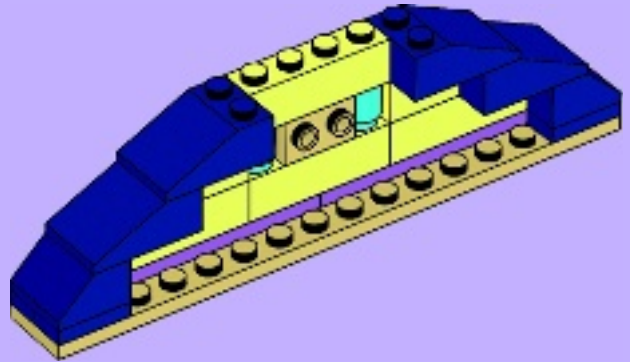



1x



2x

7

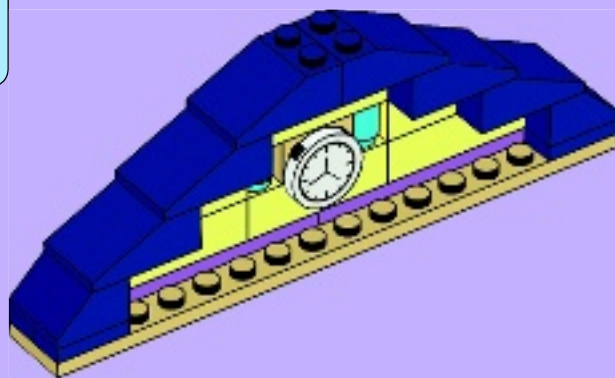

25



26





2x

1

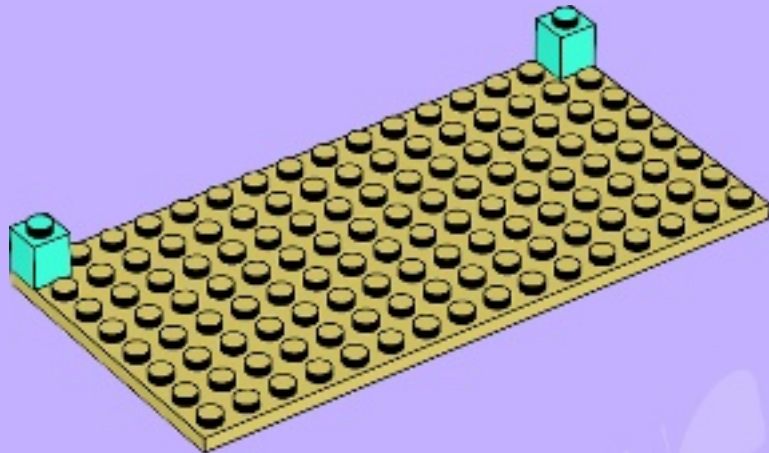

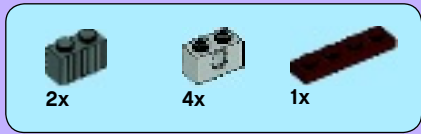

2

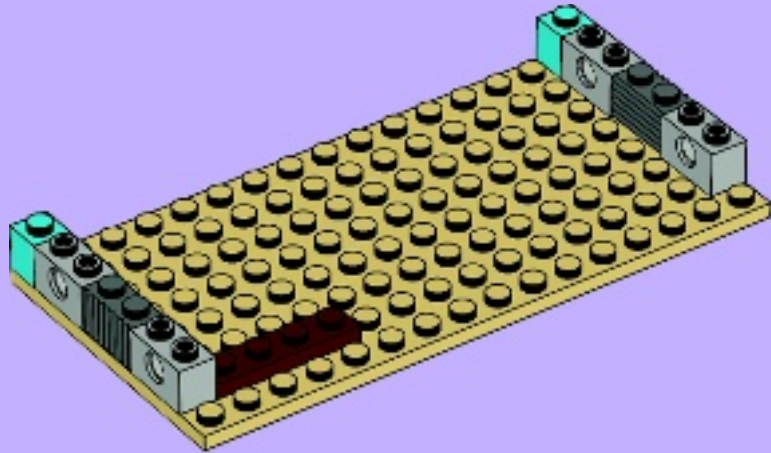



3

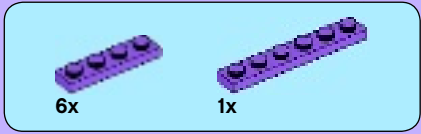
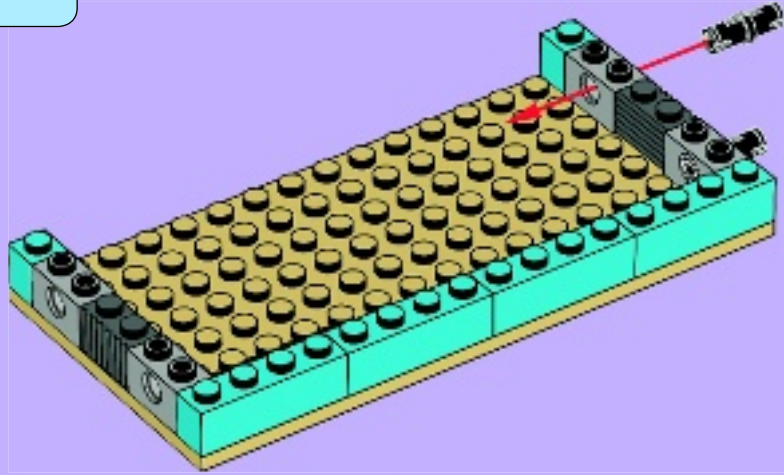

4

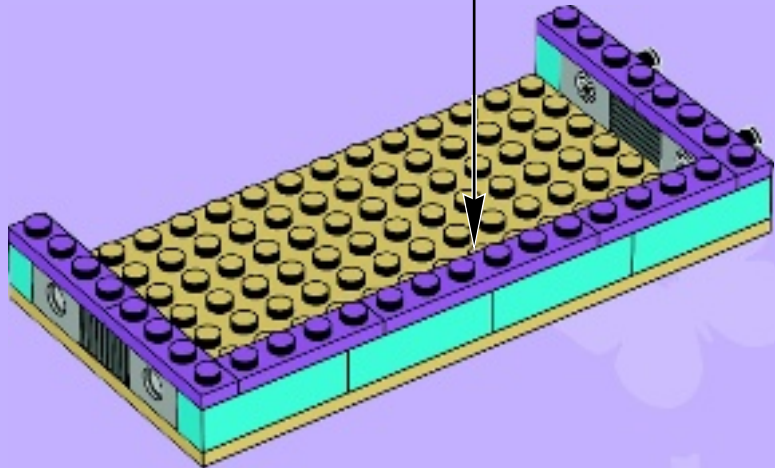
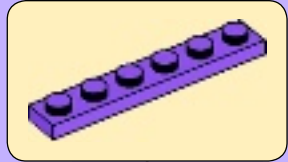

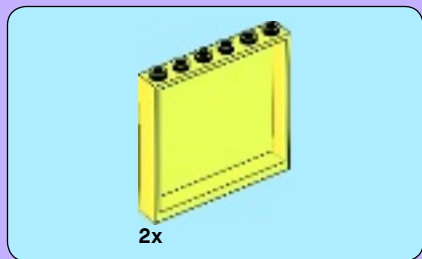

5

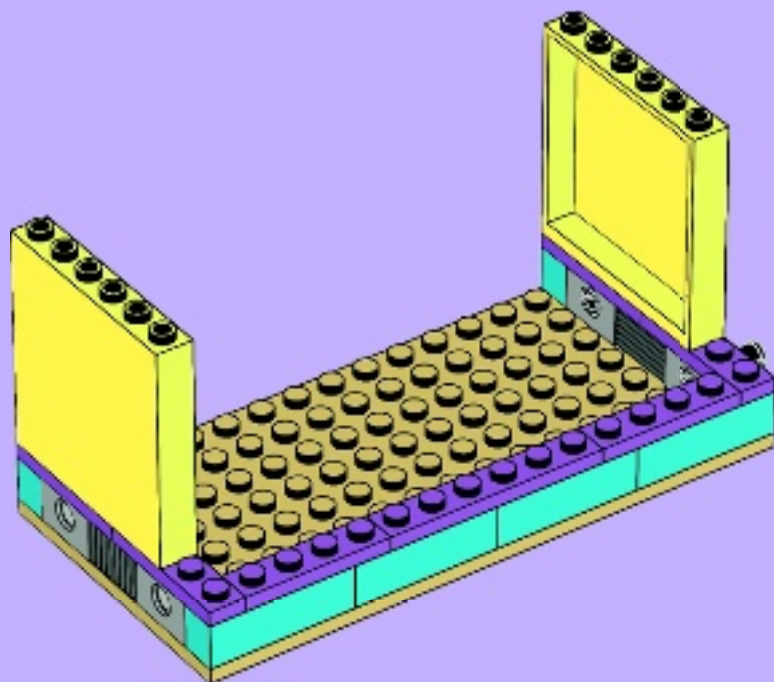

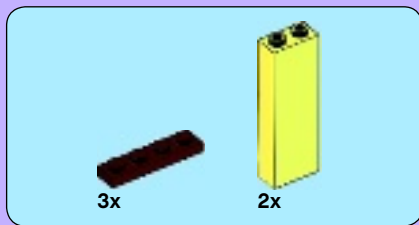

6

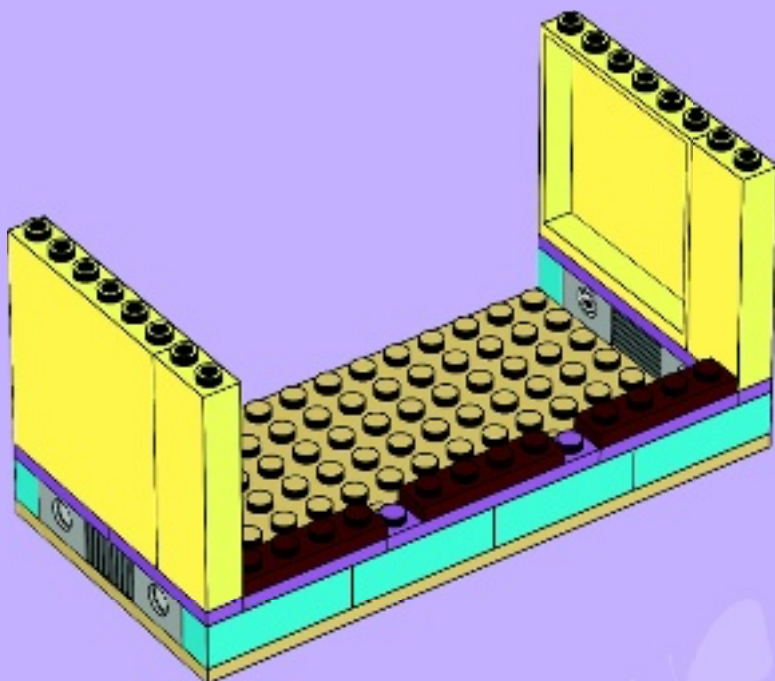

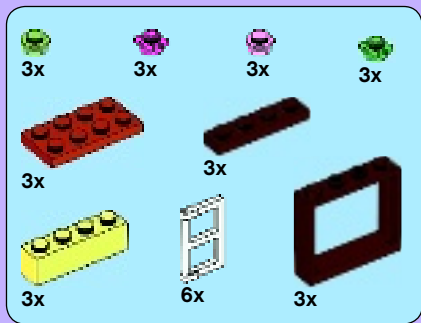

7

1



2



3

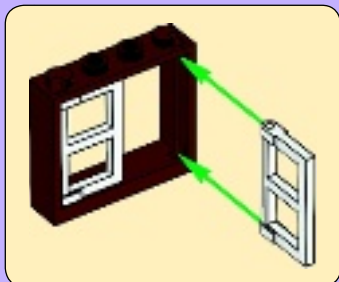

4



3x

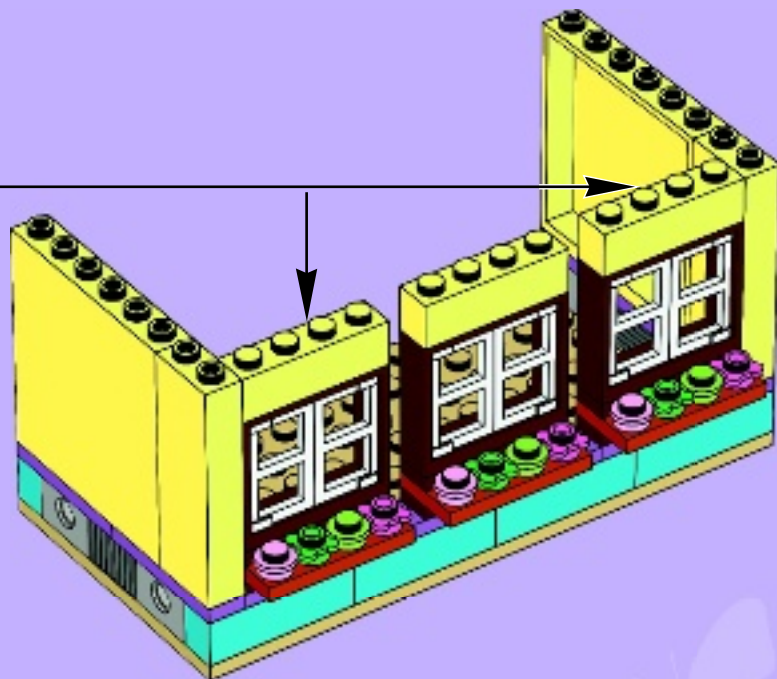



2x

8

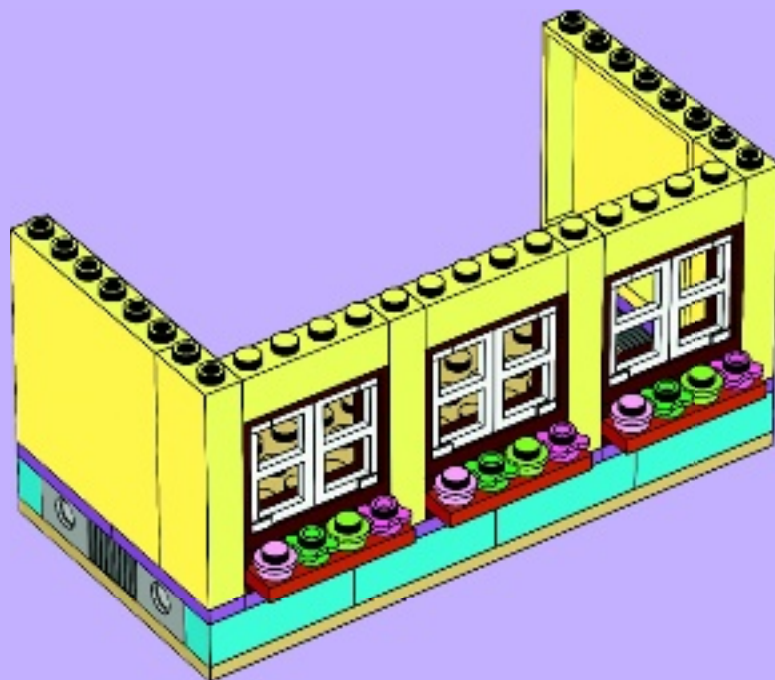



9

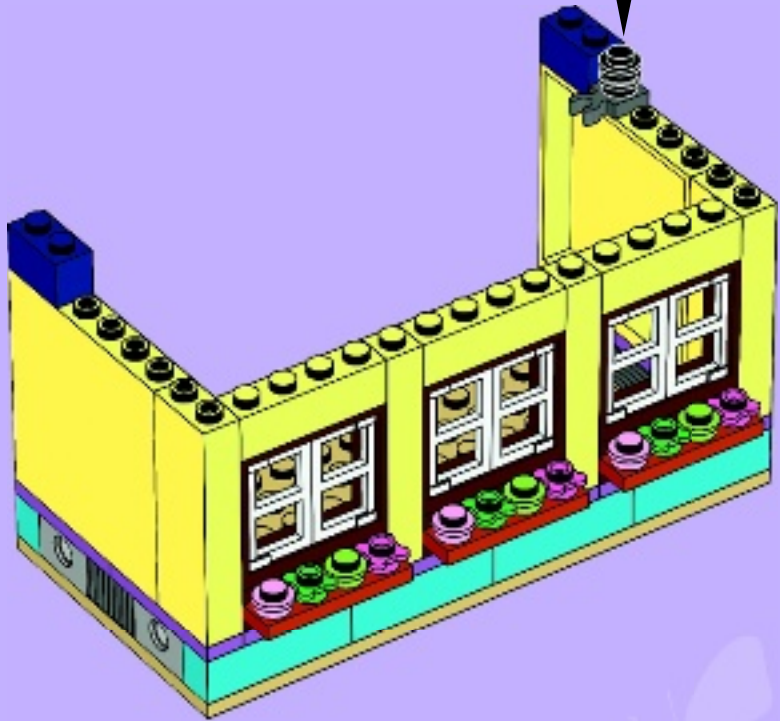



1x



2x

10

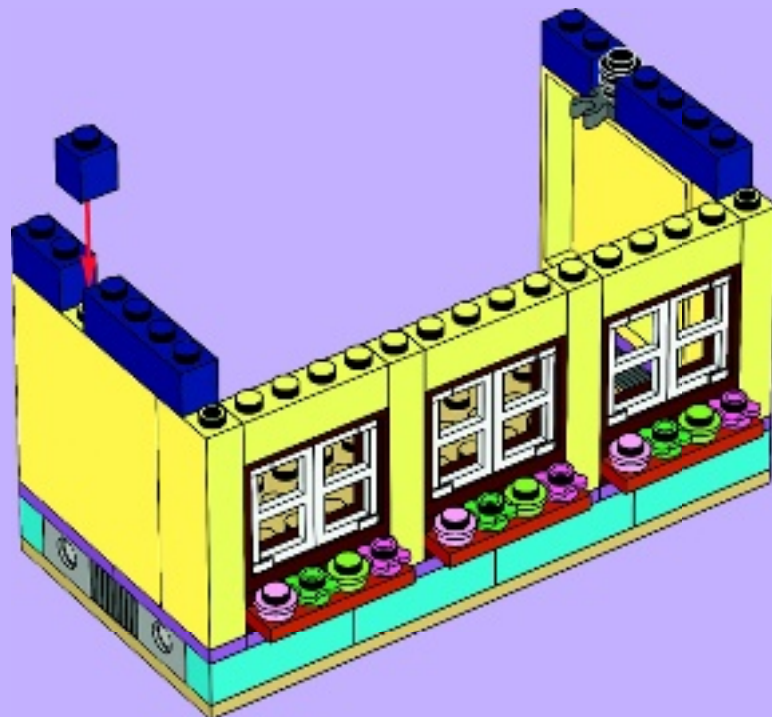



4x

11

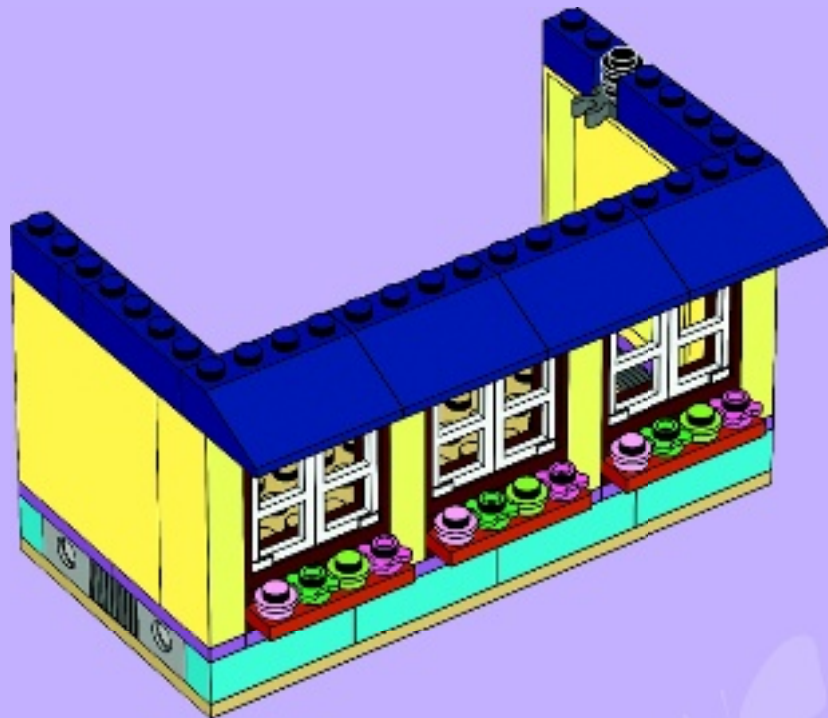

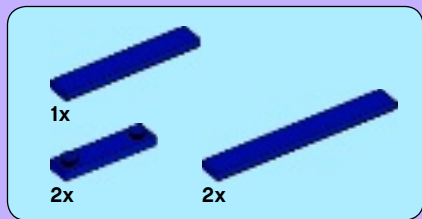

12



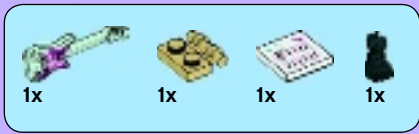

13

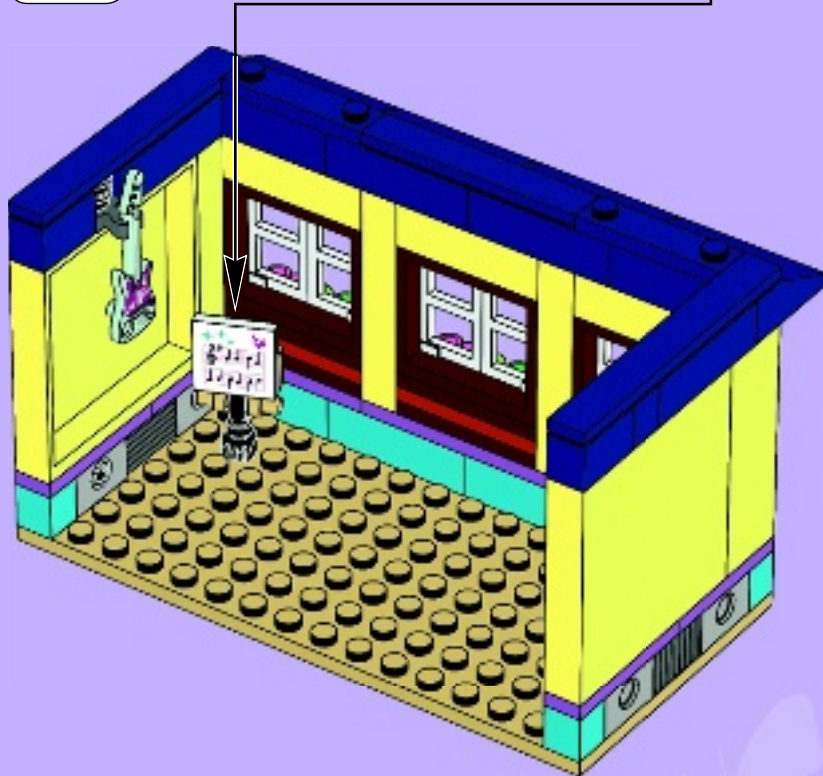
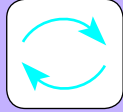



1

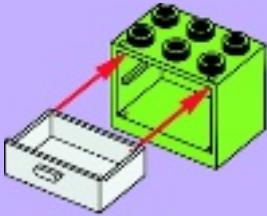

2

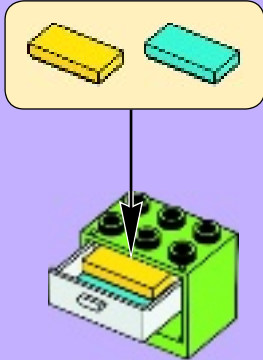



1x



1x

3



1x

4



1x



1x



1x



1x

5



4x

6



14

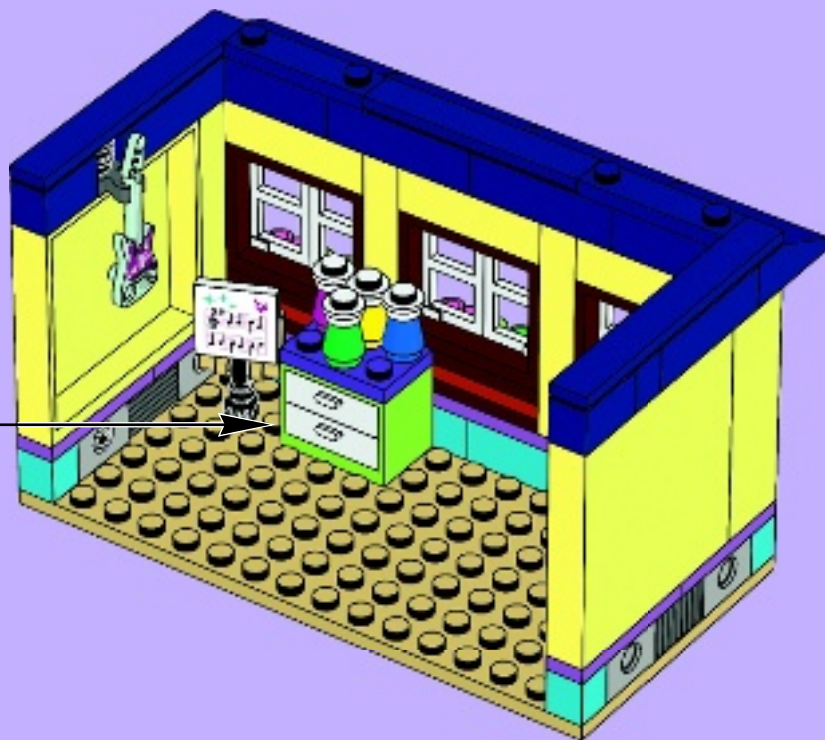



2x



2x

15

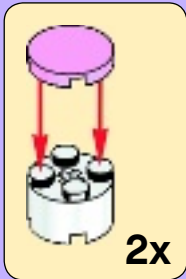

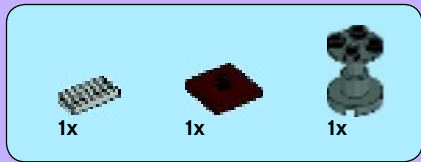

16

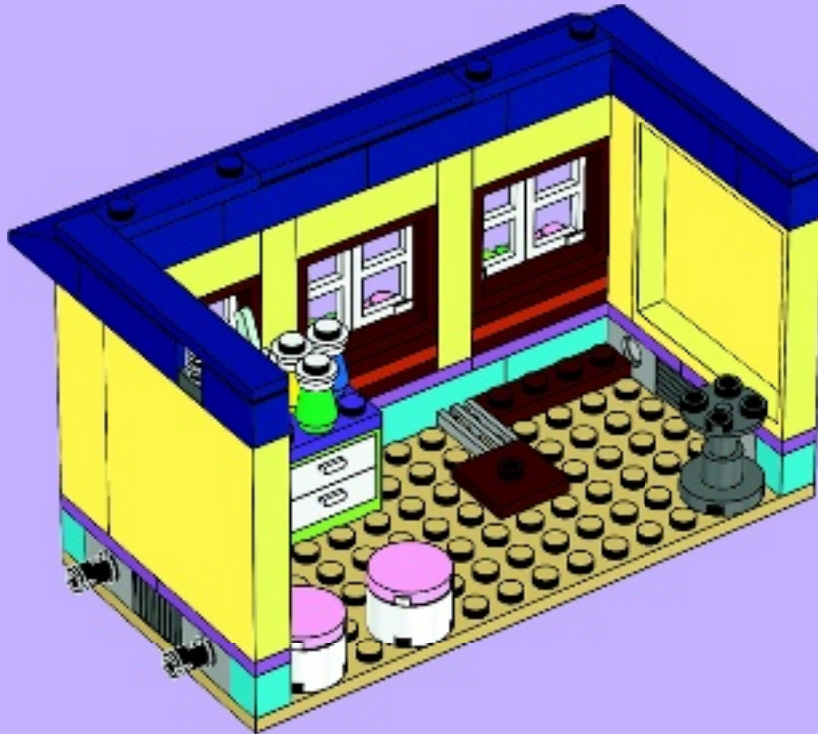
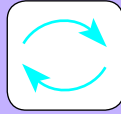

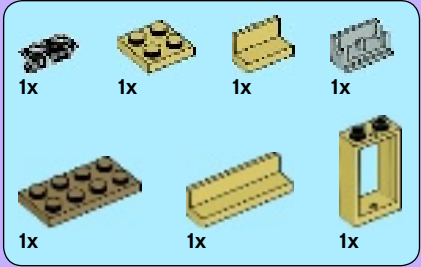
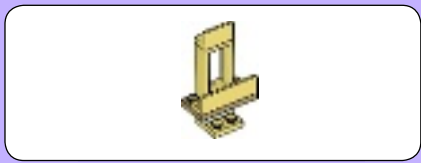

17

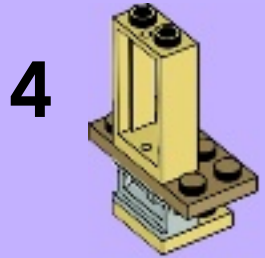
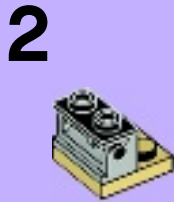
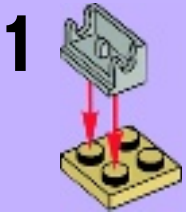

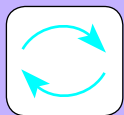

5

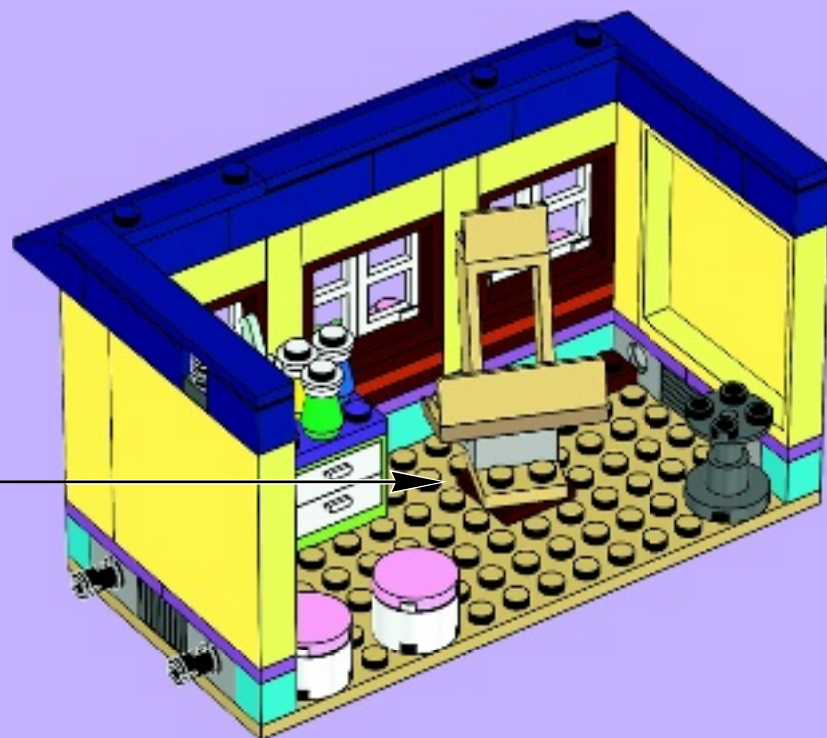
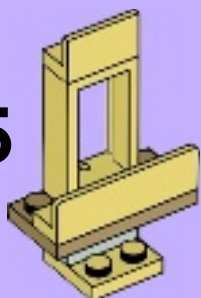

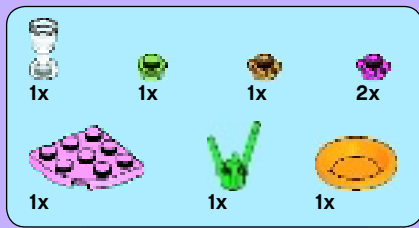

18



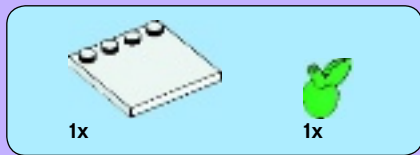

19

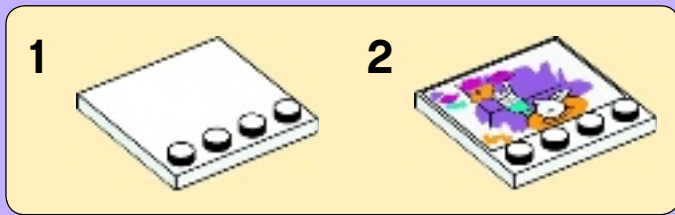





Friends



41006



41013



41010



Heartlake City





41009



41005



41015





Friends



Available on the App Store



Emma

Stephanie

Olivia

Andrea

Mia





4x
306801



1x
415001



1x
4507355



1x
4119410



1x
4111971



2x
306201



3x
614301



1x
4504369



1x
4500469



1x
302301



1x
6001512



4x
614101



2x
623101



12x
4520842



3x
4507685



58



4x
301001



4x
300101



2x
4521943



1x
4611164



1x
4560178



1x
617901



1x
6017011



1x
6017011



1x
6017011



1x
6017011



1x
6017011



2x
663601



1x
4163986



1x
4163986



1x
303601



1x
303601



2x
243101



2x
4520636



1x
6035195



1x
4529239



3x
374128



6x
4619599



1x
4107050



2x
4109995



1x
6024495



1x
4113917



1x
4114084



1x
4114026



1x
4140593



1x
4124460



1x
6034929



1x
6034929



1x
6034929



1x
4536667



1x
6030980



2x
4609726



1x
4611414



2x
4618876



2x
4618876



2x
4618876



2x
4624313



1x
3005740



2x
6000740



1x
3000240



1x
4618266



1x
4646861



1x
4620433



1x
4620433



1x
6018580



1x
4267874



1x
4619596



8x
4216479



1x
4649422



1x
614121



1x
4227155



1x
4529235



1x
4622047



2x
4220632



1x
4541957



10x
4183133



10x
4183133



1x
4625623



1x
4625623



6x
4535928



6x
4121715



1x
4107081



2x
4622574



1x
362226



1x
4233487



1x
4100378



1x
4517925



1x
4277932



3x
614126



1x
4569106



1x
6038453



1x
4527063



1x
393826



1x
393826

1x 6023209
 1x 4654448
 1x 4525464
 1x 306924
 2x 614124
 1x 6003007
 1x 6023827
 1x 6037413
 1x 4243784
 1x 4566522
 1x 6035171
 1x 6034812
 1x 6035549
 1x 4243920

1x 4624184
 9x 4255413
 5x 4249891
 5x 4264569
 2x 4153653
 9x 6025376
 8x 6036241
 2x 4186627
 6x 4528981
 7x 6036240
 6x 4252437
 5x 4507080
 1x 6019684
 1x 4598334

1x 6047551
 2x 4211180
 2x 4211221
 3x 4211150
 8x 4565394
 13x 4211190
 1x 4211151
 1x 4211207
 1x 4585337
 6x 4595889
 3x 4623513
 1x 4596335
 1x 6035188

4x 4211525
 1x 4535768
 17x 4211440
 1x 4622060
 2x 4211436
 3x 4211397
 2x 4612621
 1x 4243797
 3x 4211350
 2x 4585429
 3x 4211503
 1x 4211469
 2x 4551044

12x 4211098
 8x 4210636
 3x 4210725
 1x 4249139
 2x 4211119
 3x 4211065
 1x 4587212
 1x 4568734
 1x 4211110
 4x 4521386
 1x 4211051
 4x 6036239
 4x 6022083

1x 4596240
 8x 6036236
 17x 6036232
 8x 6036235
 2x 4654127
 6x 4517996
 1x 4620318
 2x 4619591
 2x 6000294

1x 6017021
 1x 6035189
 1x 6038791
 1x 6049694
 1x 4625616
 4x 4619512
 1x 4619640
 19x 4619524
 4x 4619516
 6x 4649745
 4x 6039270

Customer Service
 Kundenservice
 Service Consommateurs
 Servicio Al Consumidor
 LEGO.com/service or dial



: 00800 5346 5555
 : 1-800-422-5346





Win!

Go to www.LEGOsurvey.com/product to fill out a survey for a chance to win a cool LEGO® Product.

No purchase necessary.
Open to all residents where not prohibited.



www.LEGOsurvey.com/product

Gewinne!

Nimm an der Umfrage auf www.LEGOsurvey.com/product teil und hab die Chance ein cooles LEGO® Produkt zu gewinnen!
Die Teilnahme am Gewinnspiel führt zu keinerlei Kaufverpflichtungen. Teilnahme in allen nicht ausgeschlossenen Ländern möglich.

Win!

Ga naar www.LEGOsurvey.com/product product, vul een enquêteformulier in en maak kans op een cool LEGO® product.
Geen aankoopverplichting. Iedereen mag deelnemen, uitgezonderd ingezetenden van landen waar een enquêteverbod geldt.

Gagne!

Visite www.LEGOsurvey.com/product pour répondre à un questionnaire et avoir une chance de gagner un produit LEGO® très cool!
Aucune obligation d'achat. Ouvert à tous les résidents des pays autorisés.

当てよう!

www.LEGOsurvey.com/product にアクセスして、アンケートにご記入ください。当選者にはレゴ®製品を差し上げます。
お買い上げの必要はありません。
禁止されていない限り、すべての皆様にご利用いただけます。