

nickelodeon

LEGO

# NINJA TURTLES



79117





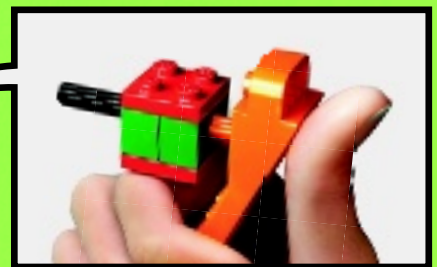
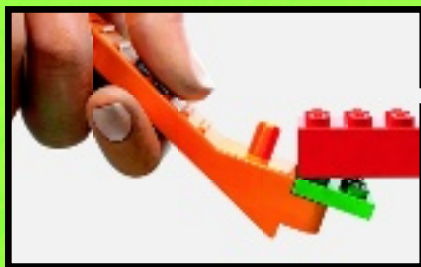

[LEGO.com/brickseparator](http://LEGO.com/brickseparator)

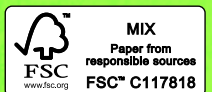



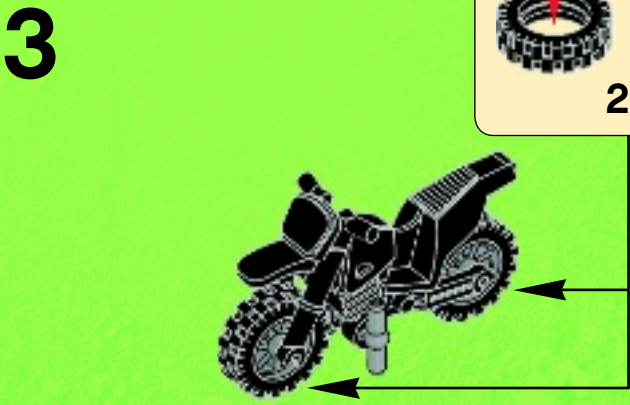
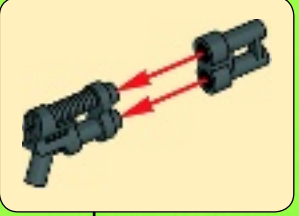
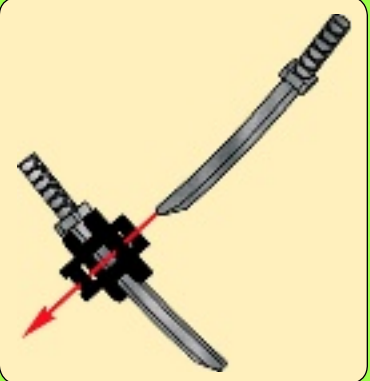
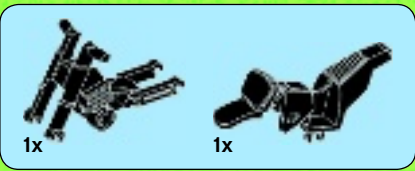
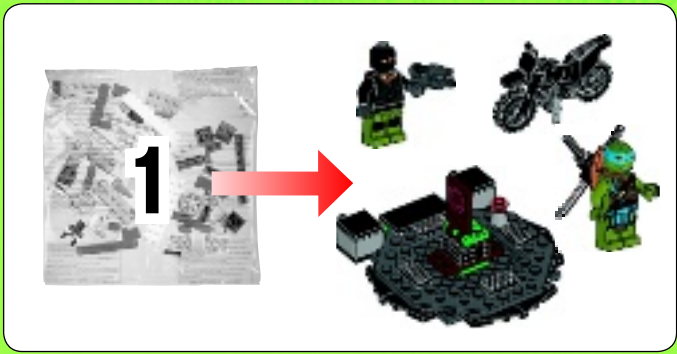



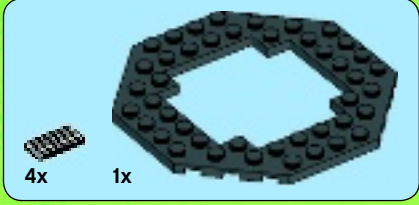
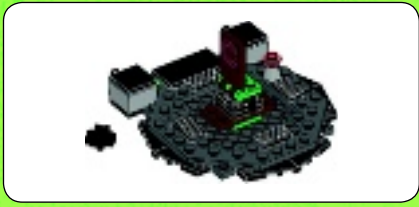

1

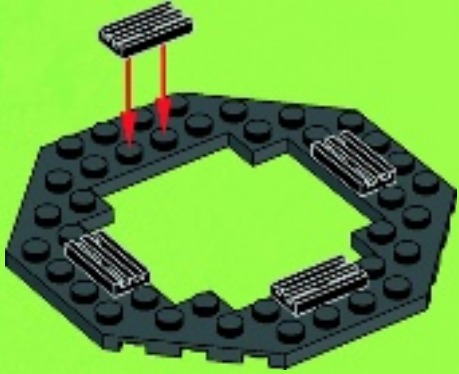

2



3

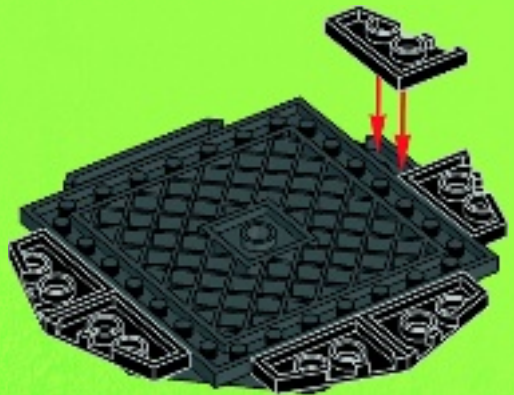



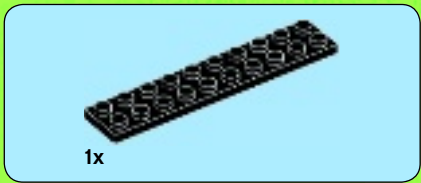

4

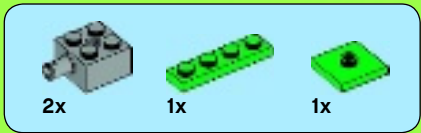

5

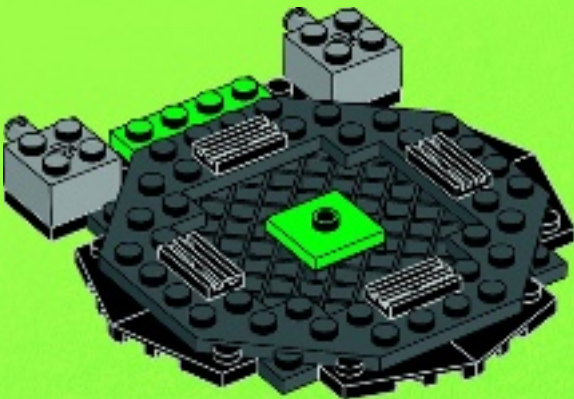

6

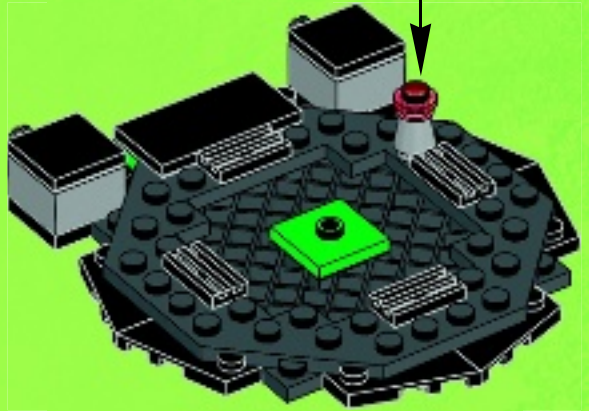



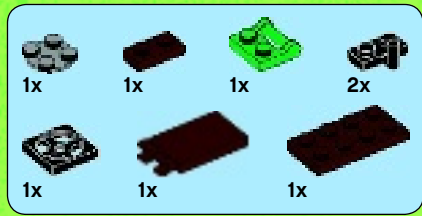

# 7

1



2



3



4

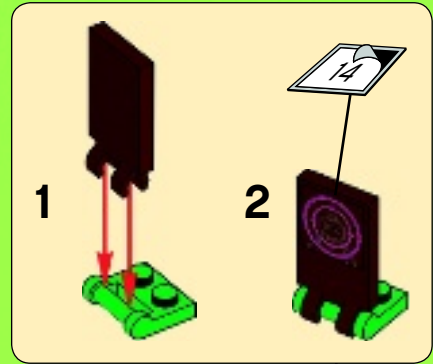

5

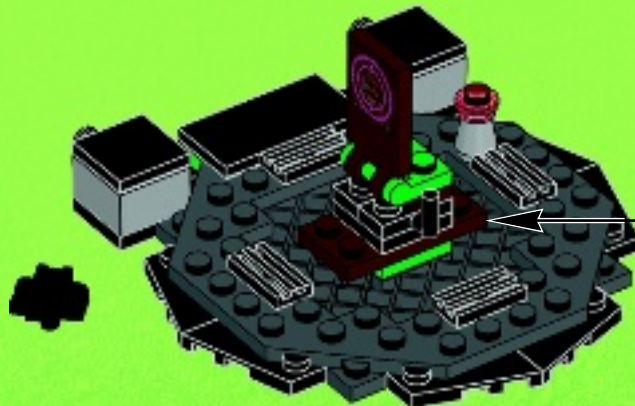



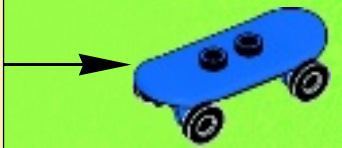
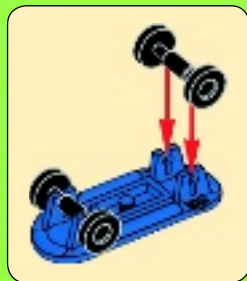
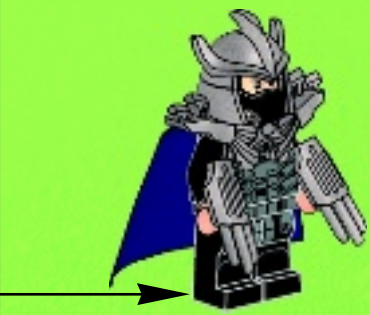
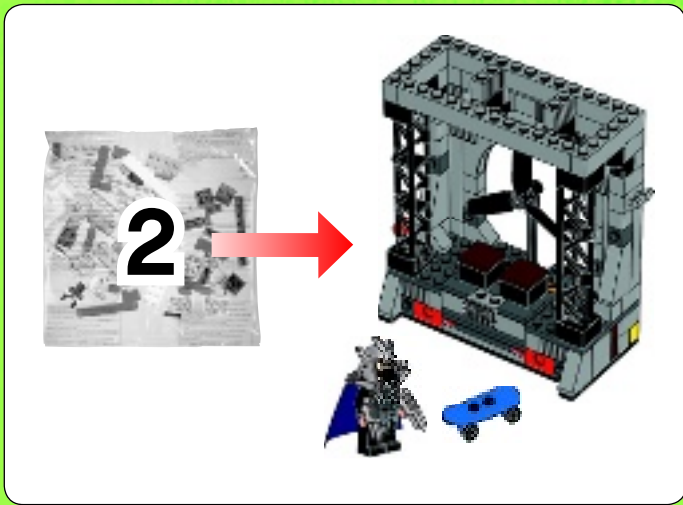



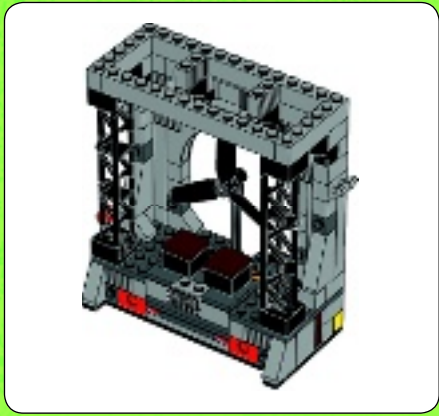

1

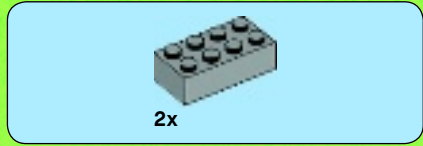

2

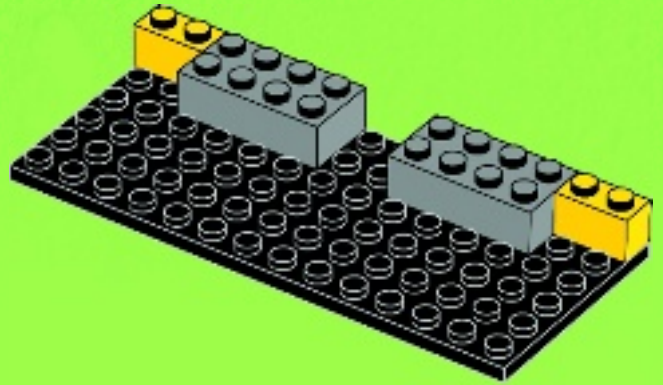

3

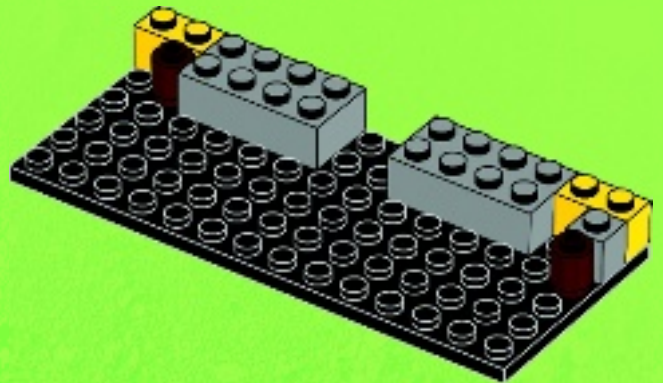



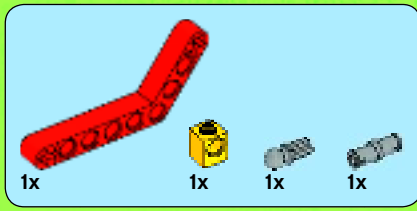

4

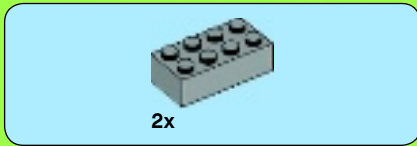
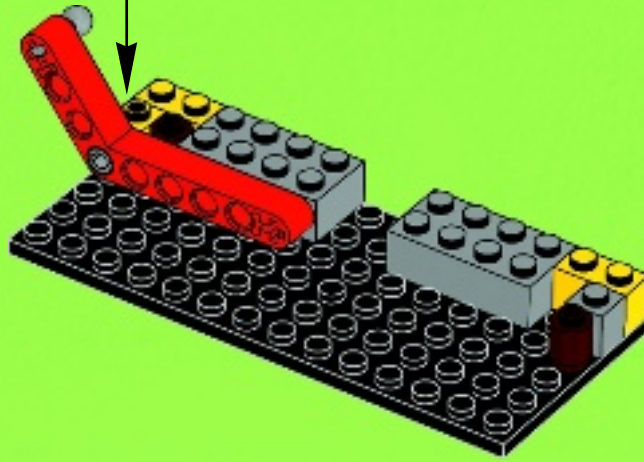
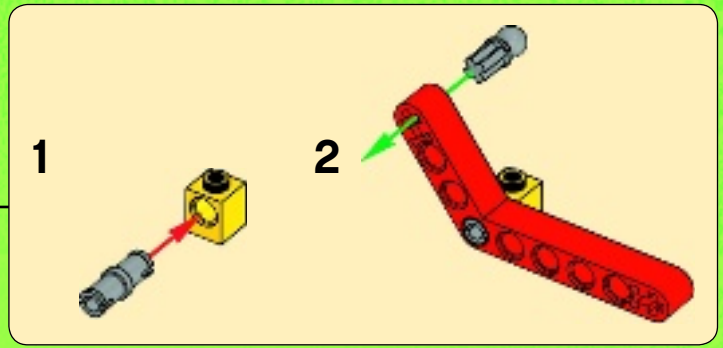

5

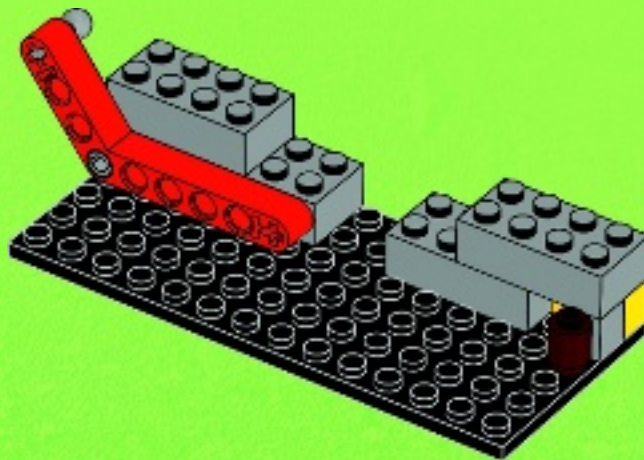





2x



1x

# 6

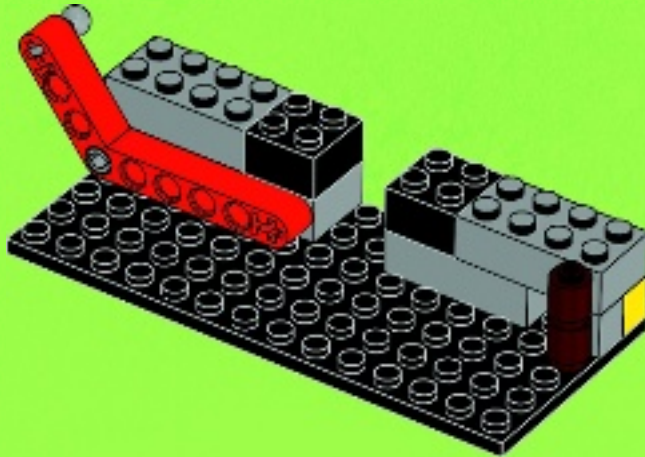

2x

# 7

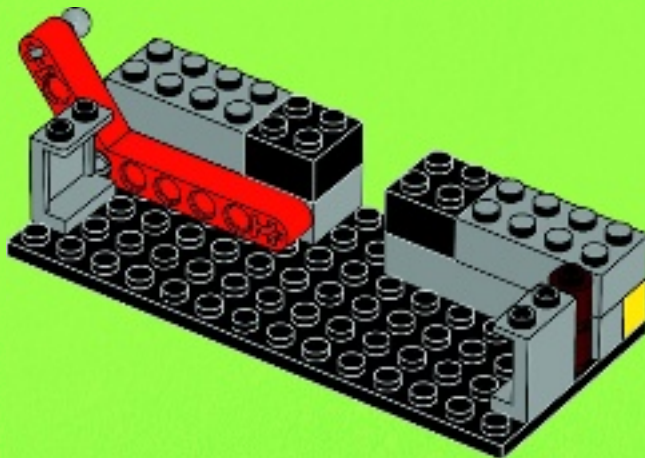



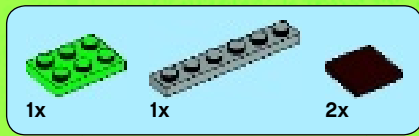

8

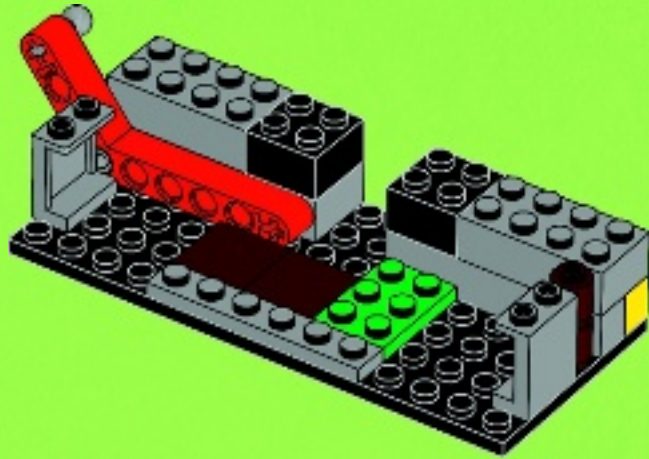

9

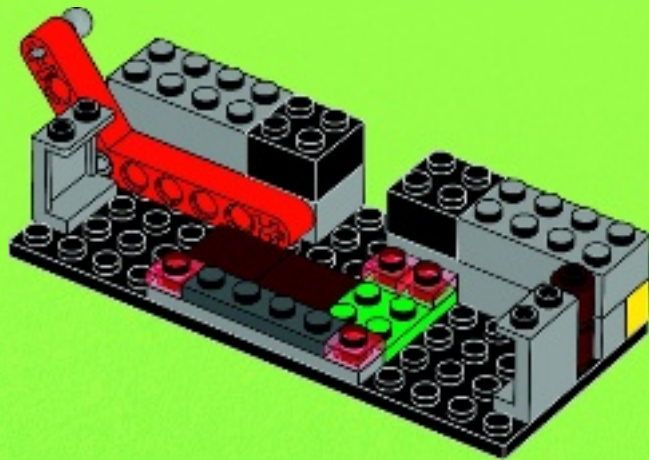





# 10

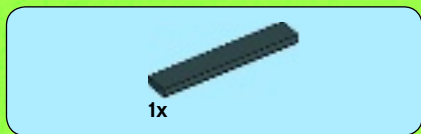
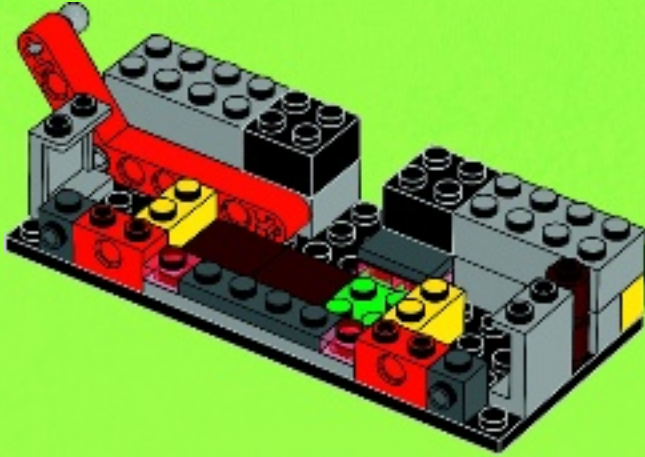

# 11

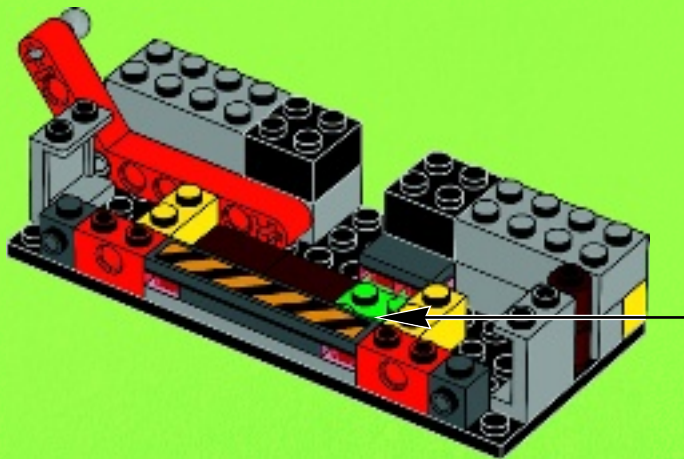





2x



2x

# 12

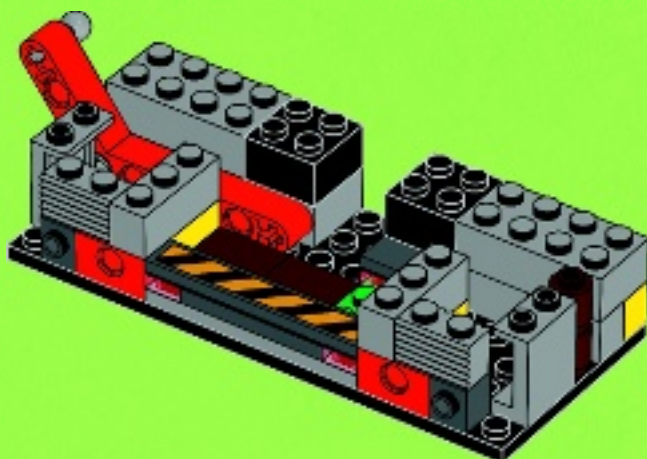

2x



2x

# 13

1



2



1:1

2x

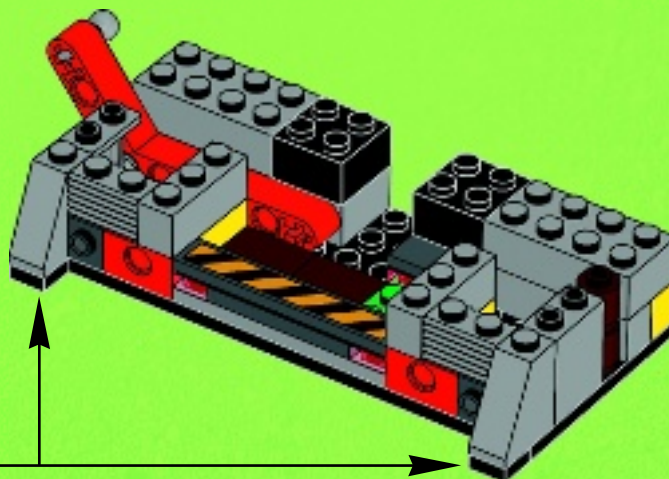





# 14

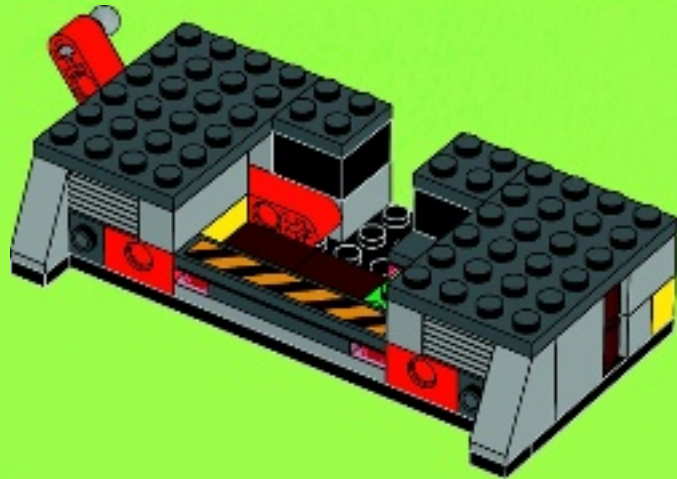

# 15

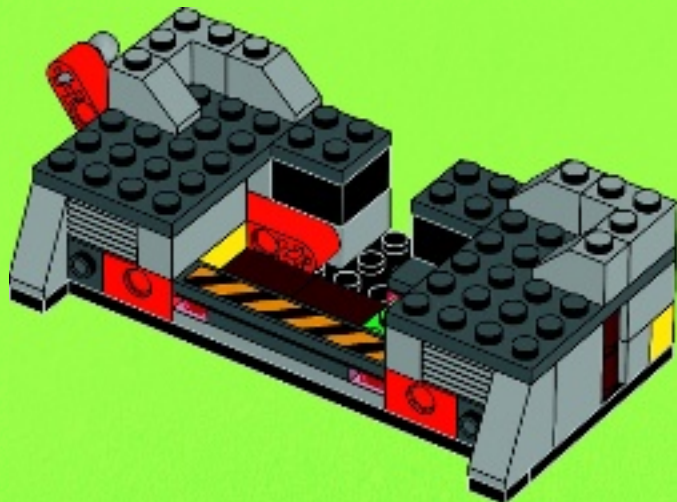



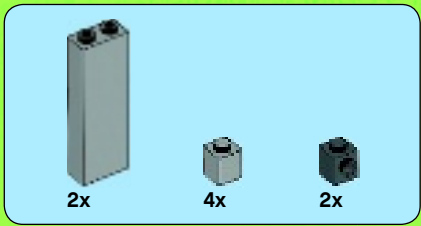

16

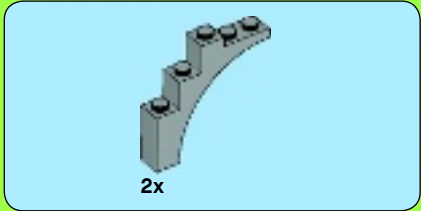
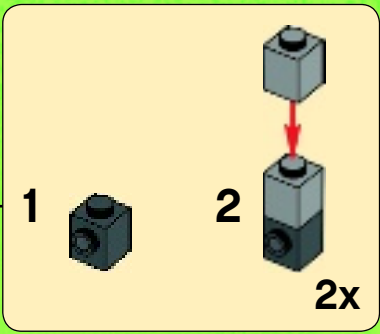
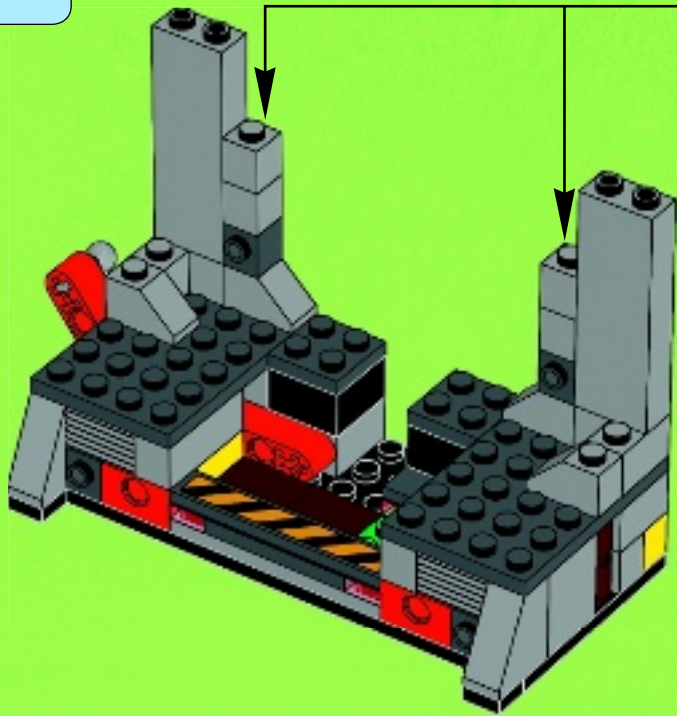

17

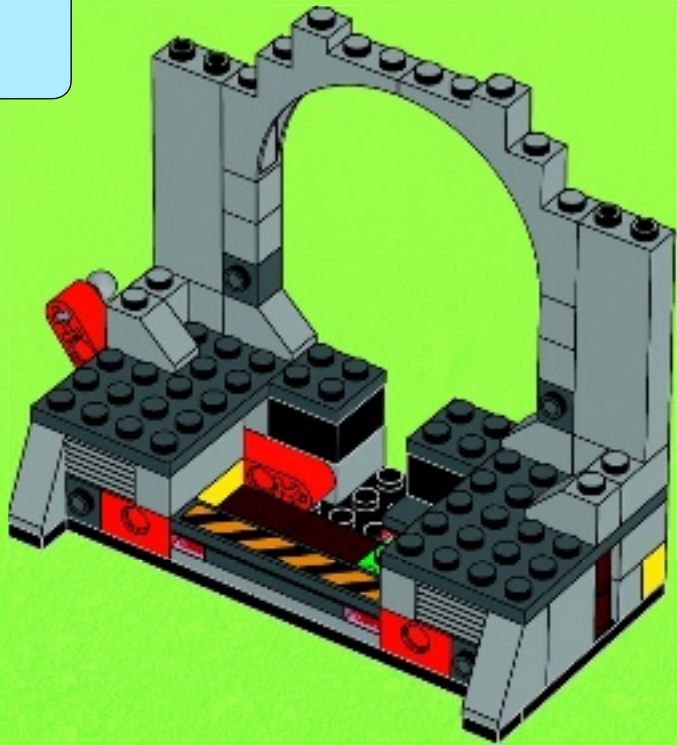



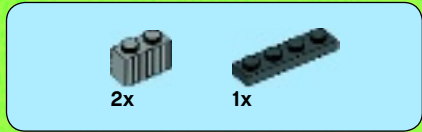

# 18

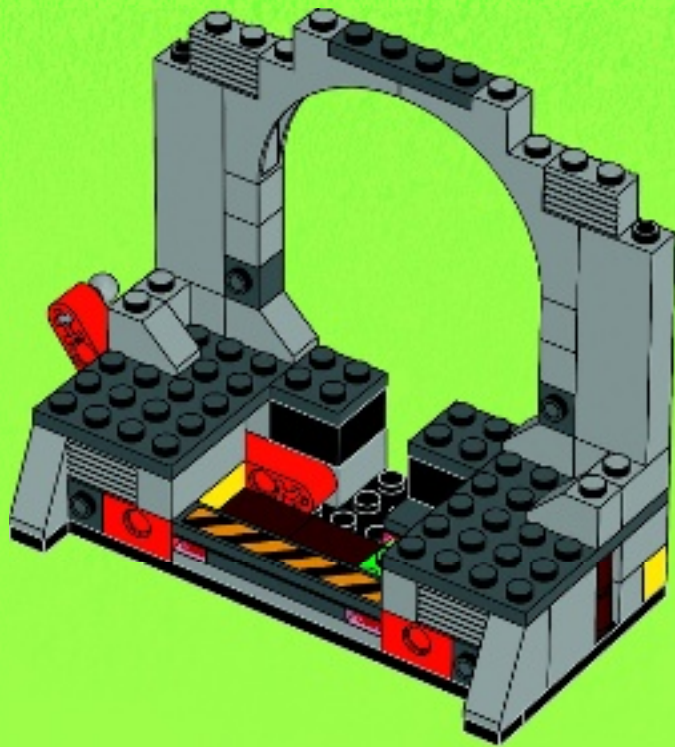

# 19

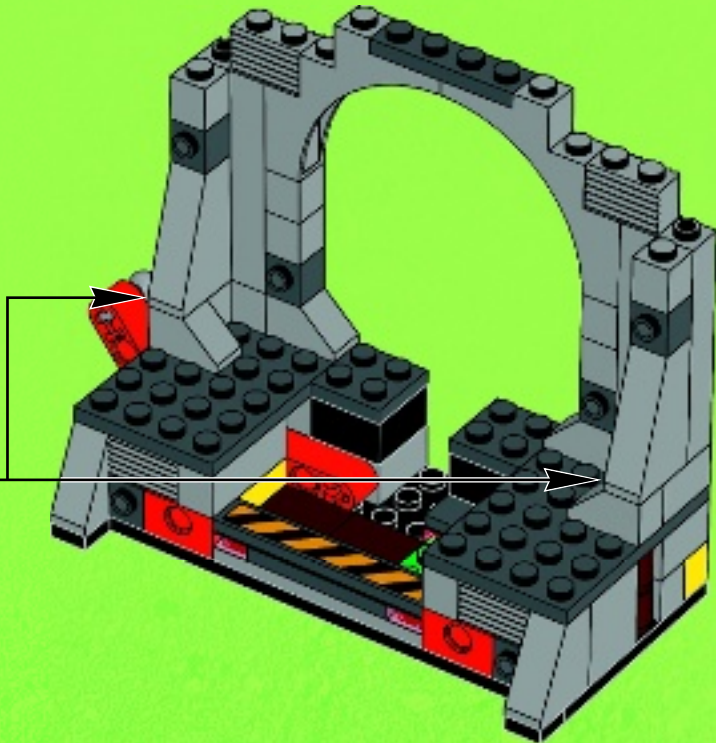
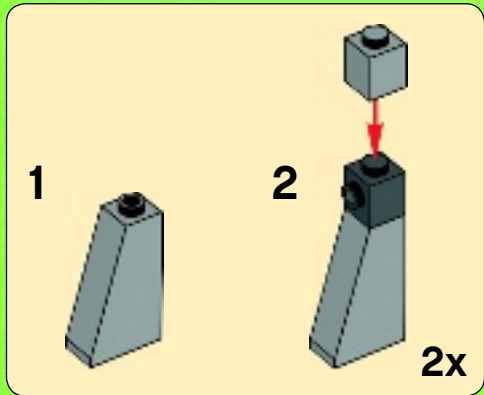





2x

# 20

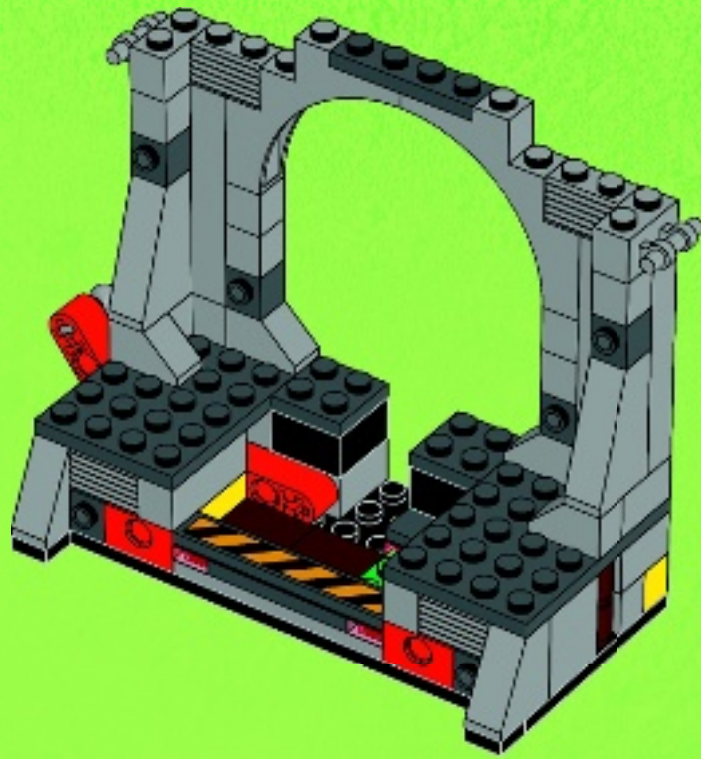

2x



2x

# 21

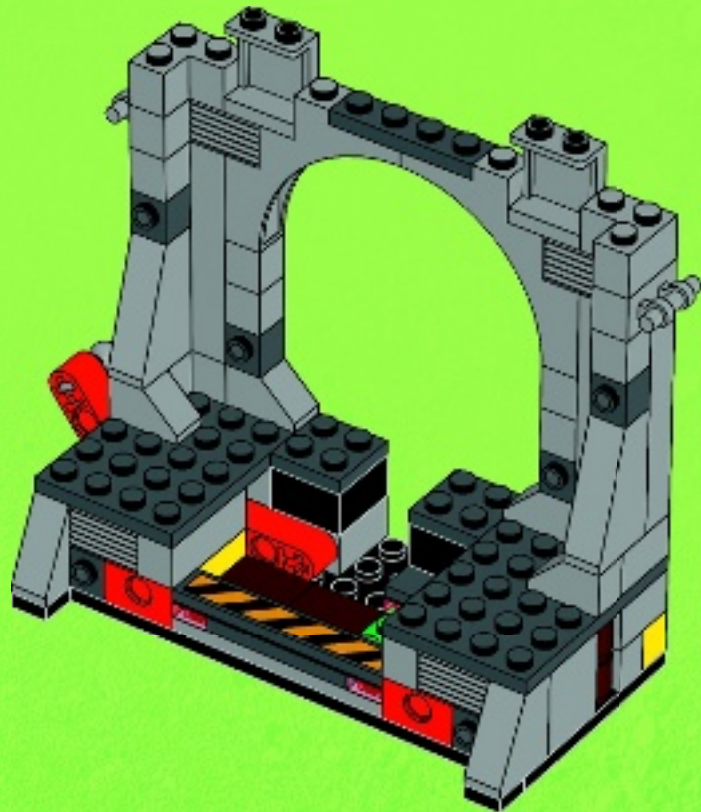





2x



2x

# 22

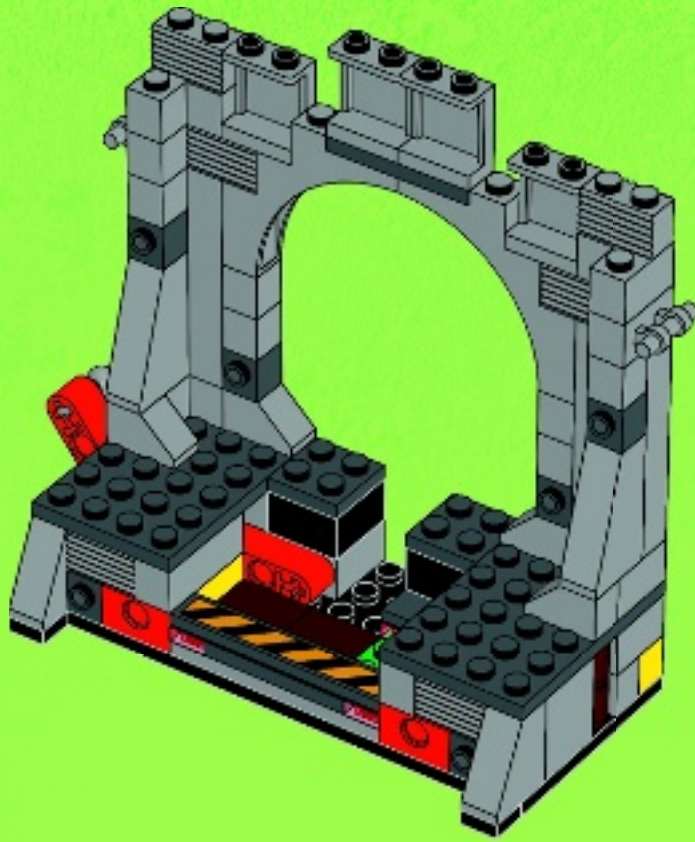

4x

# 23

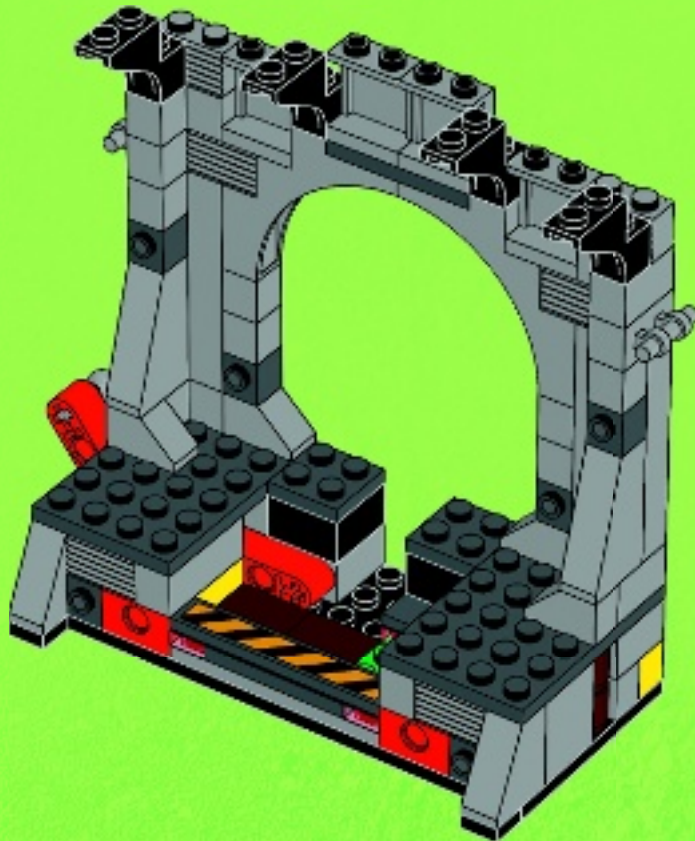





2x



2x

# 24

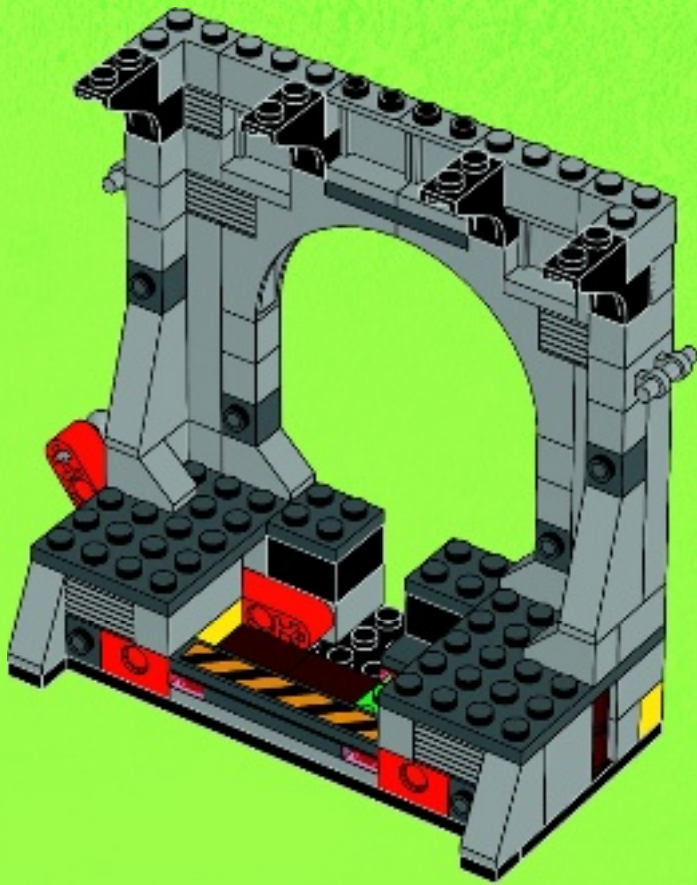

2x

# 25

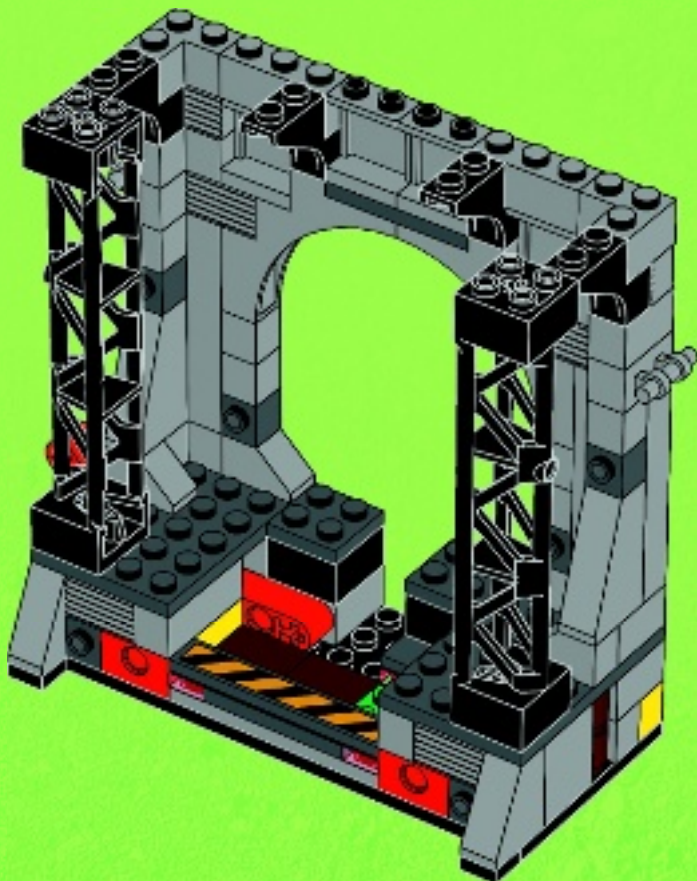



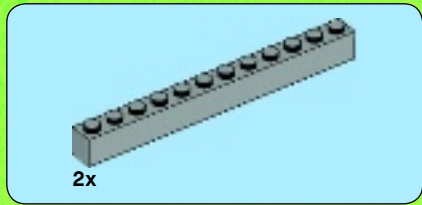

26

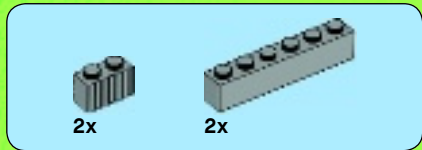
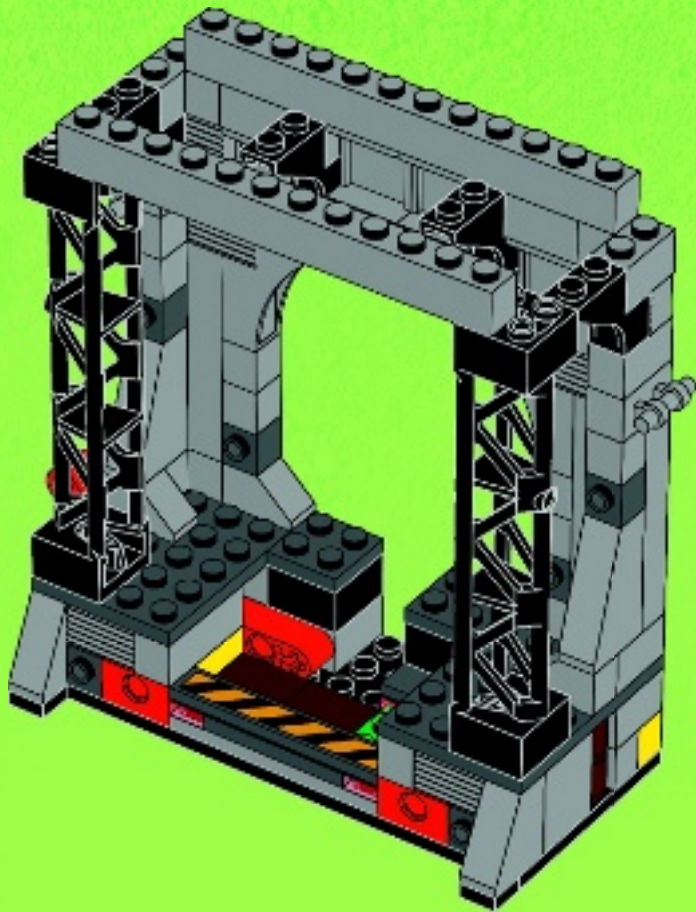

27

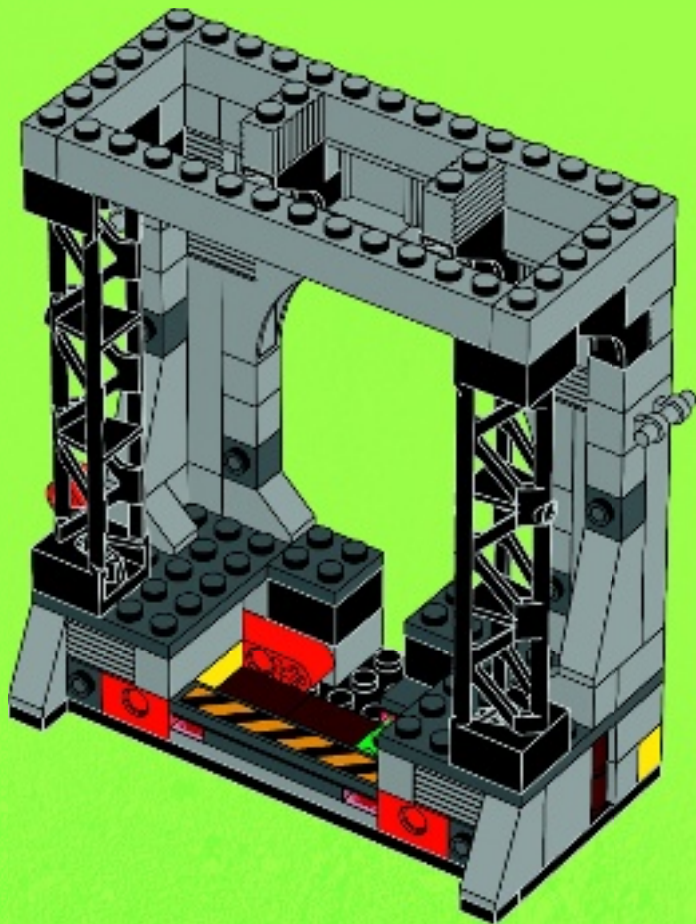



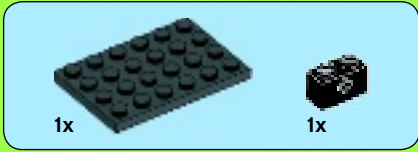

1

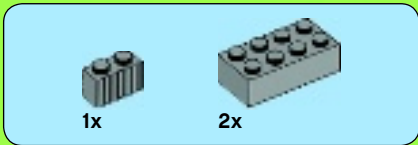

2

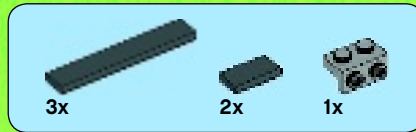

3

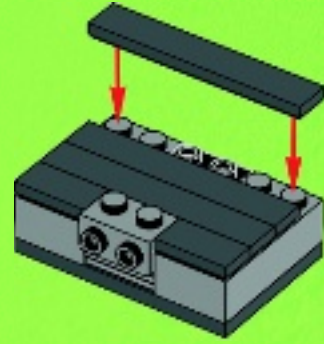

4

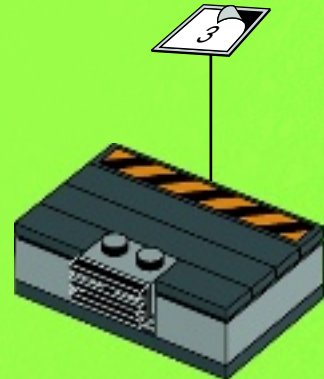



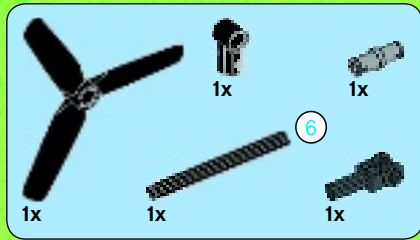

5

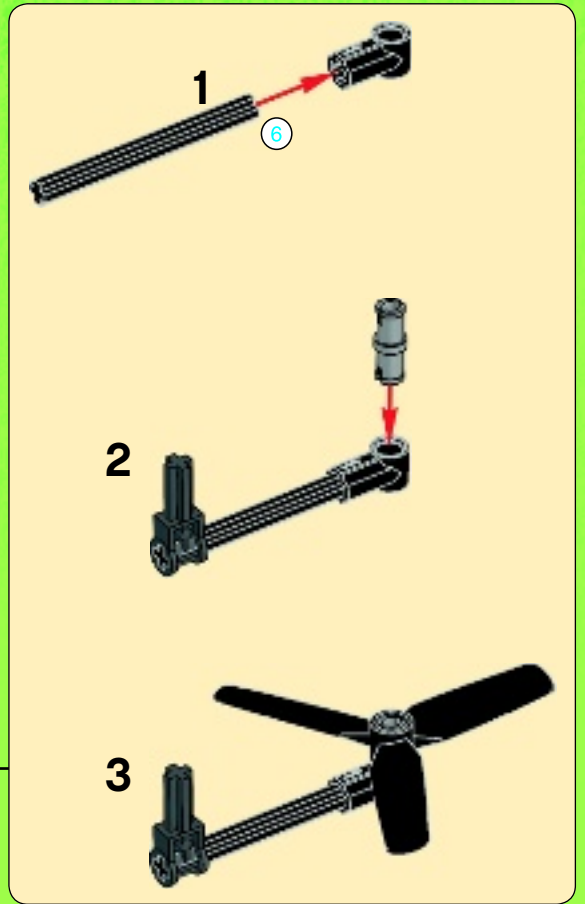
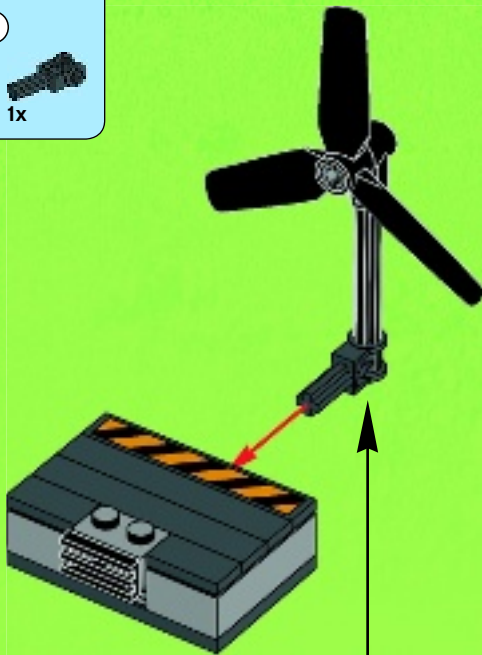

28

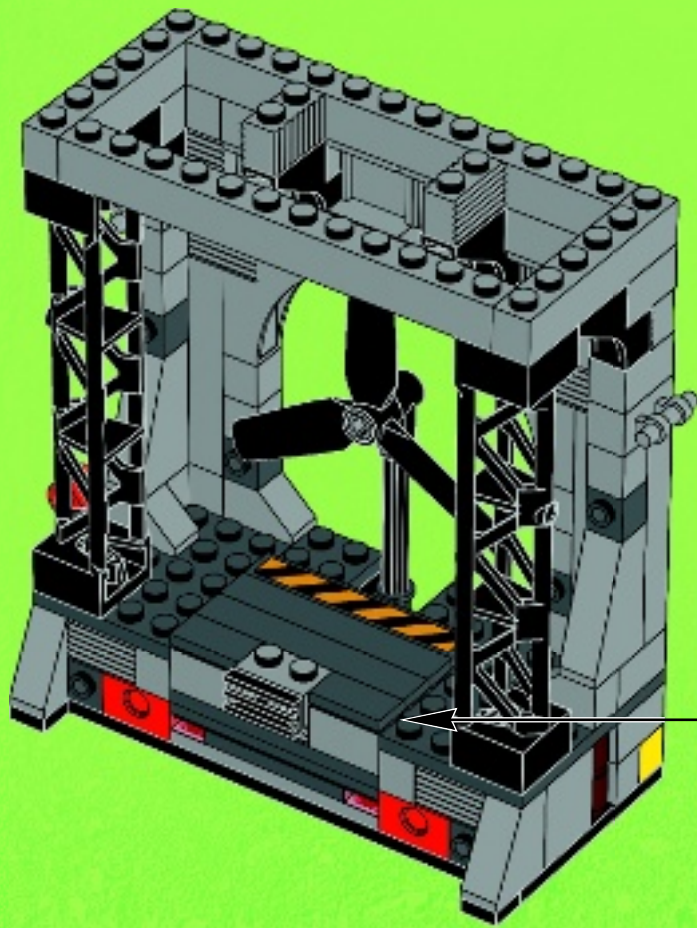



2x



2x

# 29

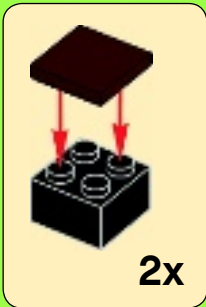
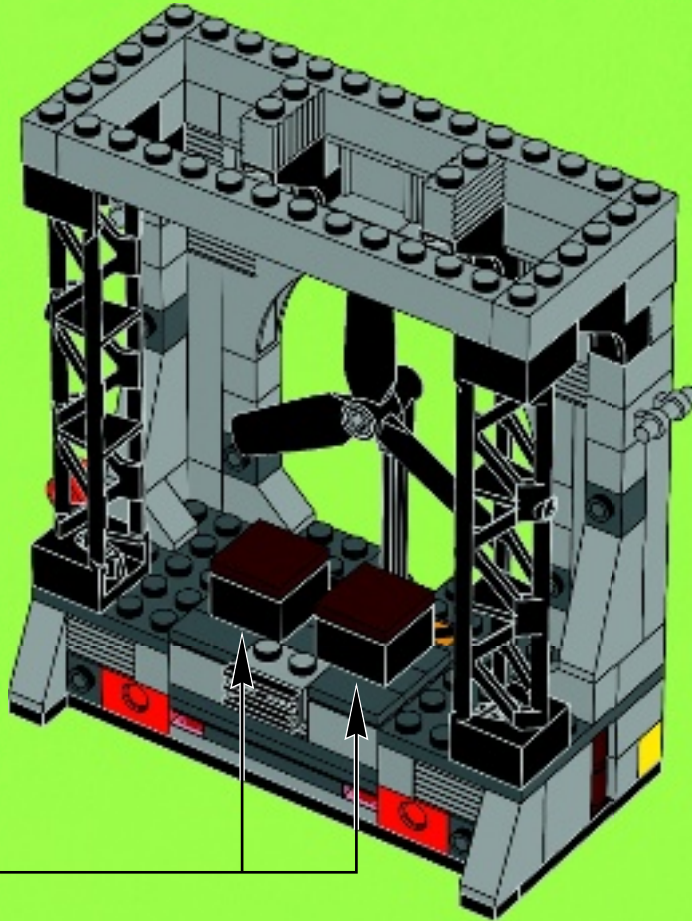

2x



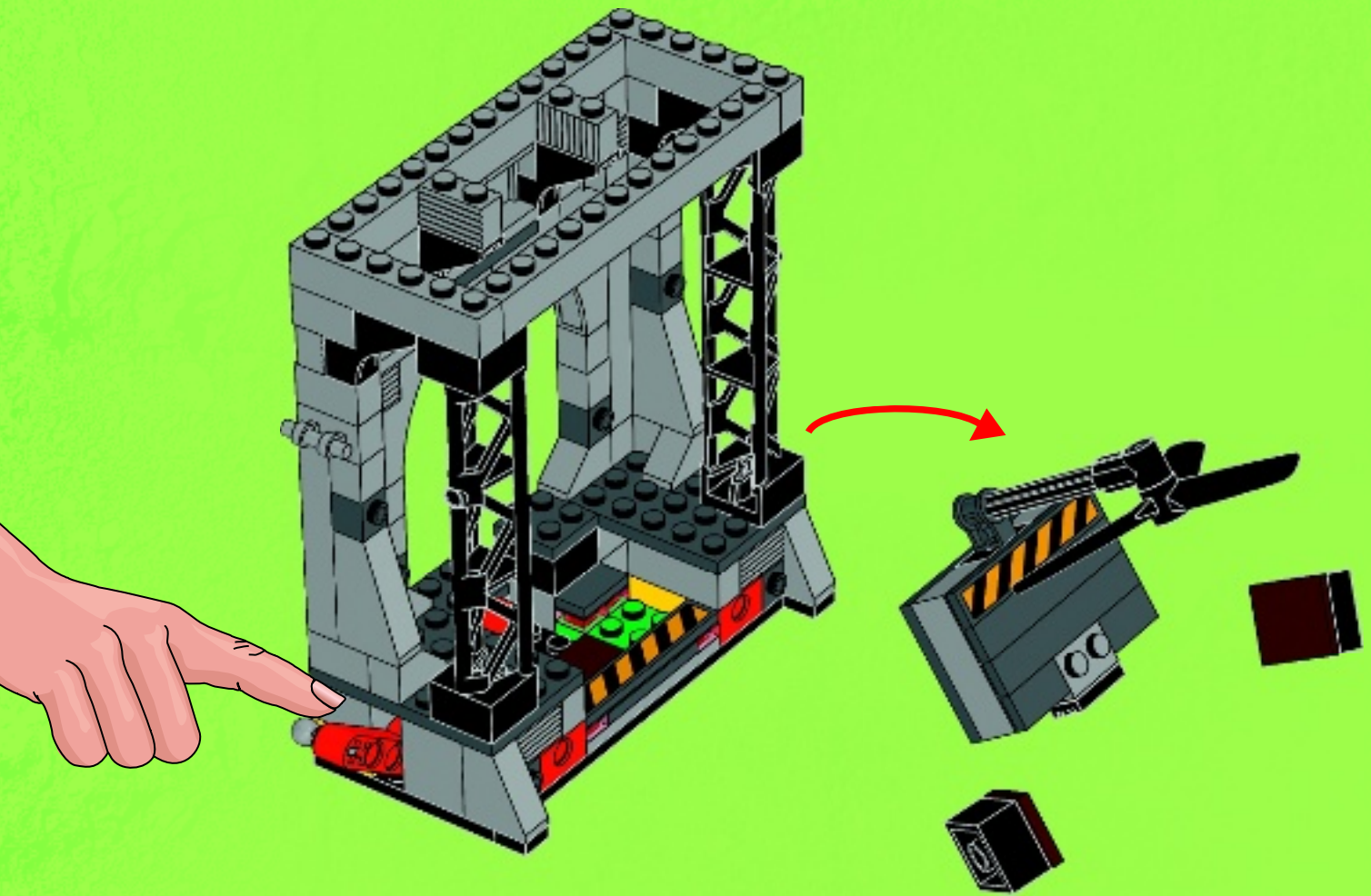





3

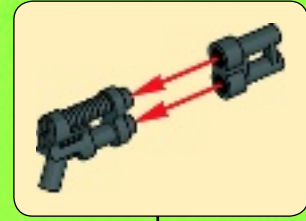
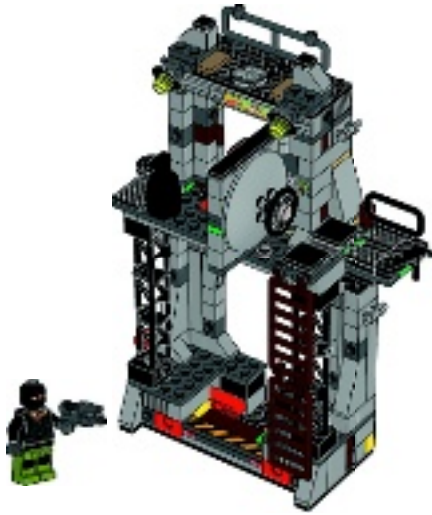

2x



2x

30

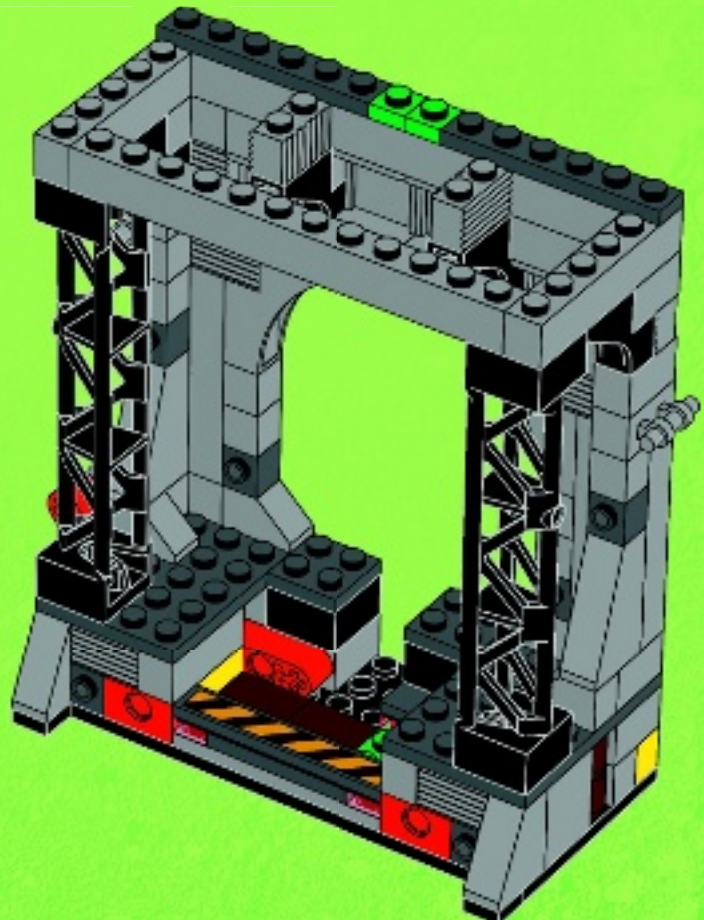



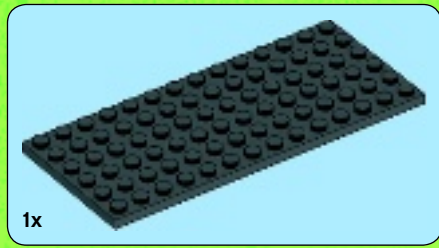

31

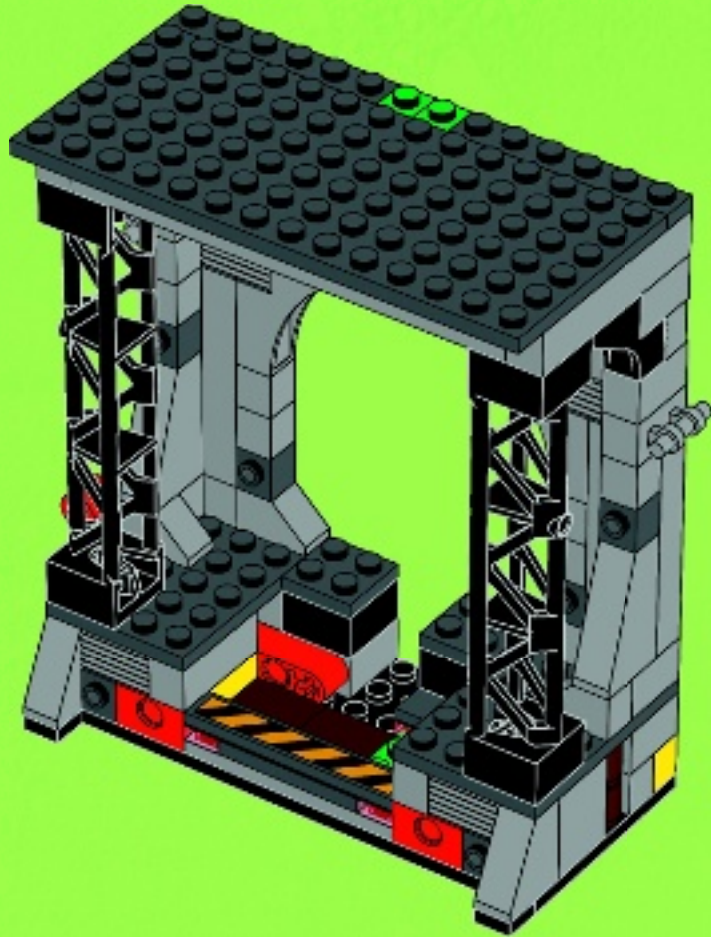





2x



2x



2x

# 32

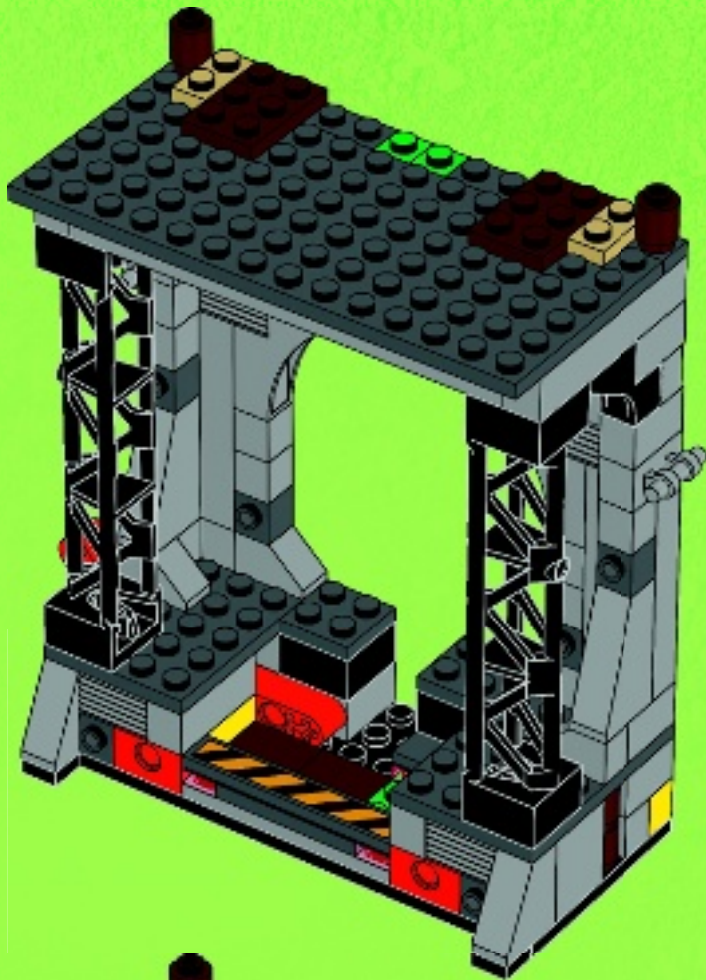

1x



2x

# 33

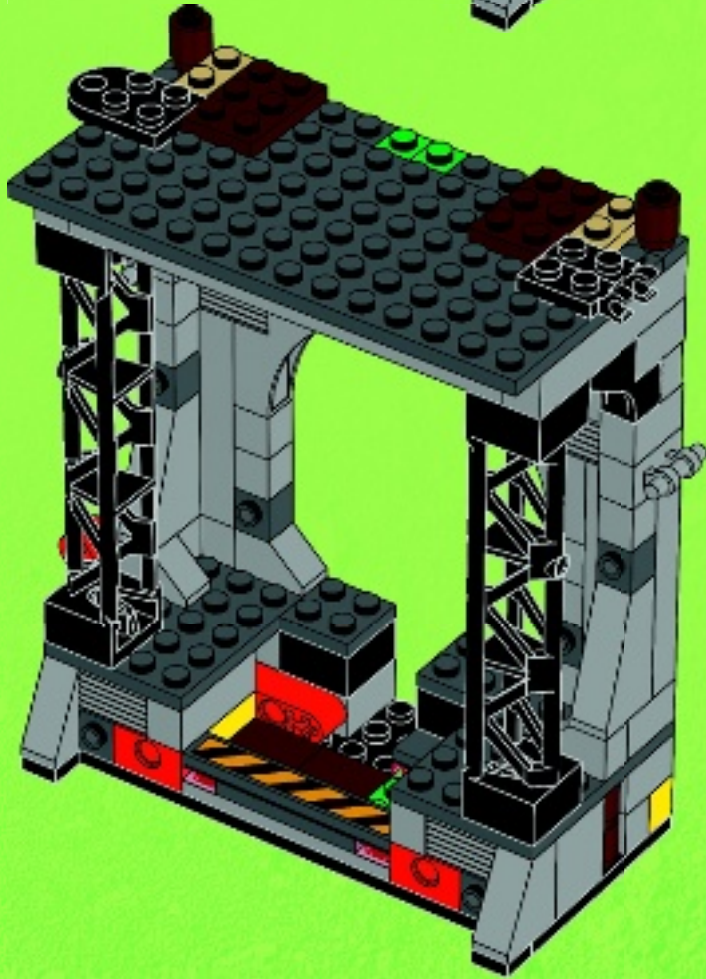





34

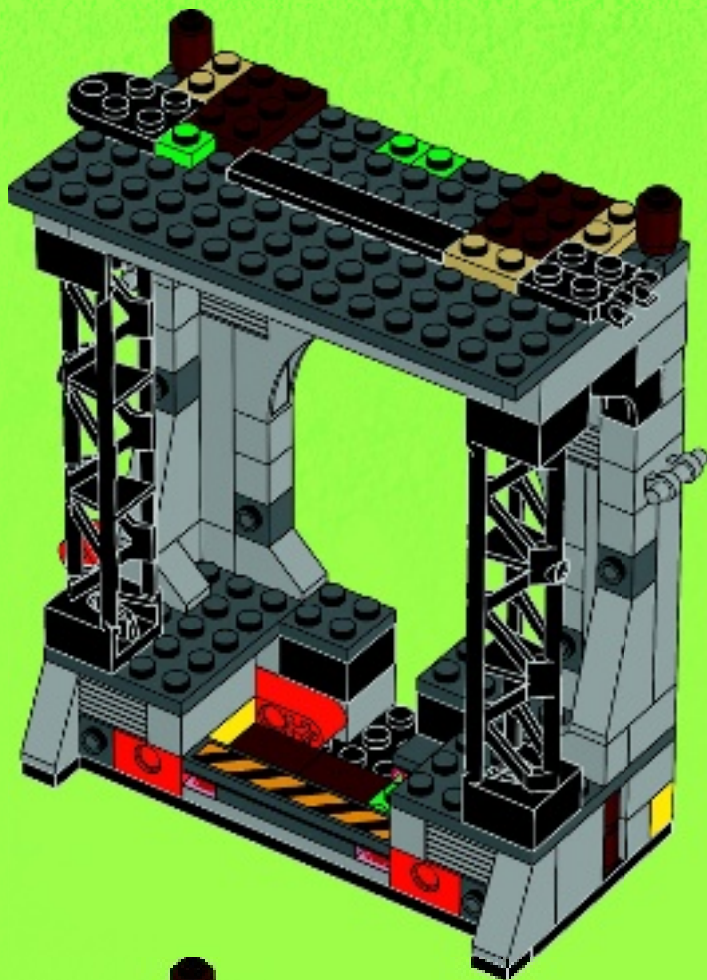

35

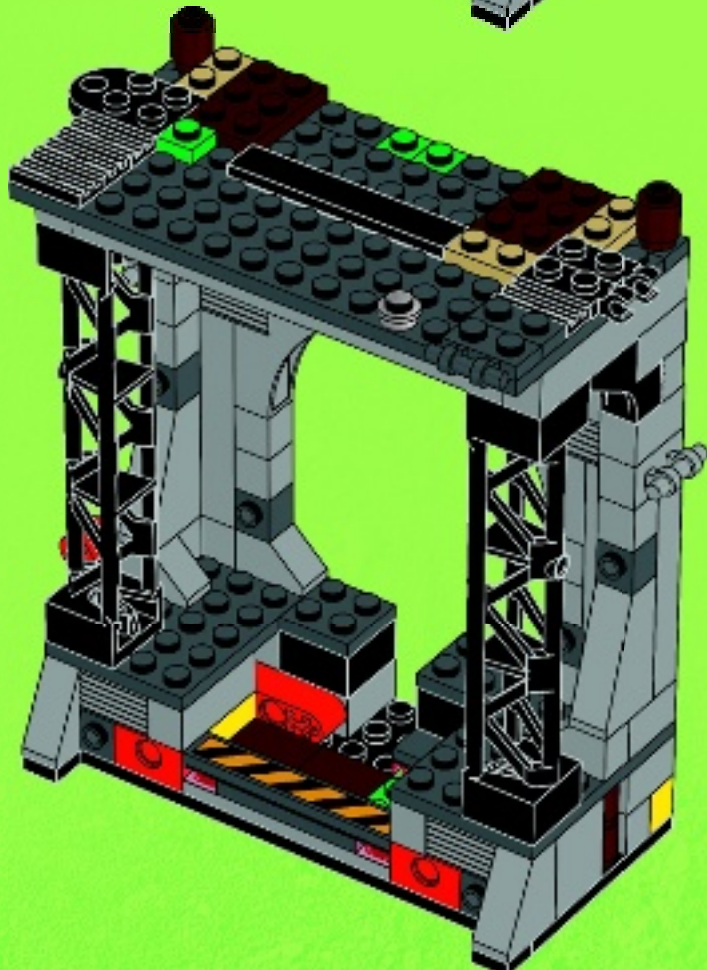



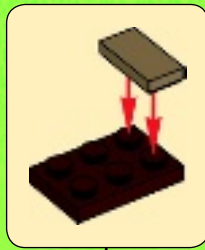
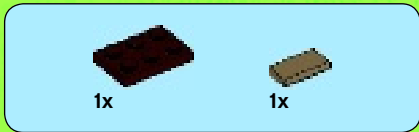

36

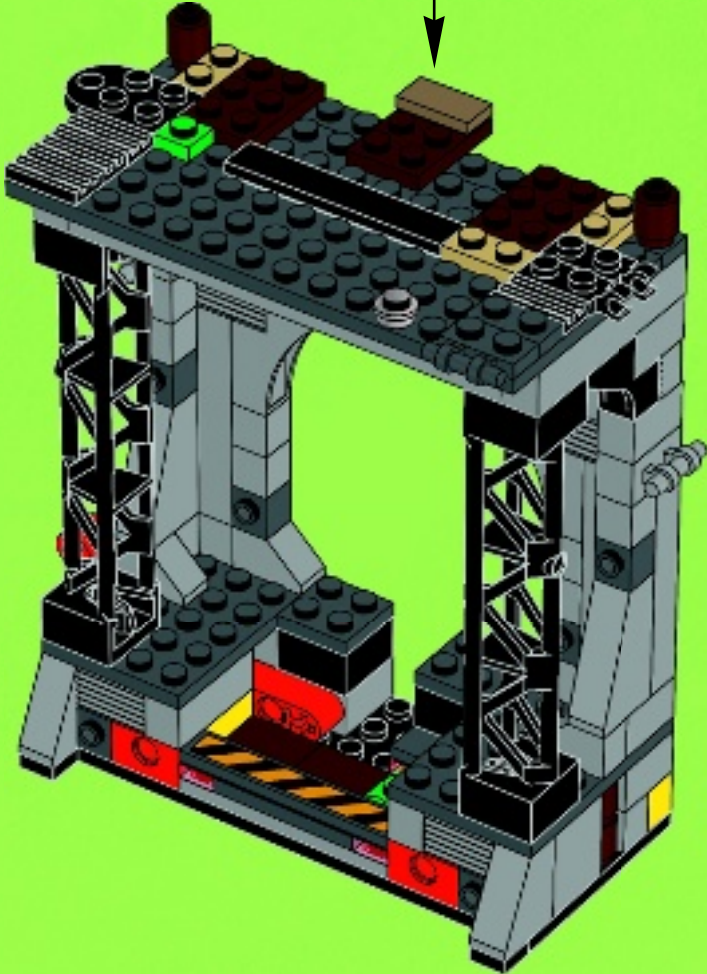





1x



1x

# 1

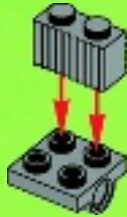

1x



1x

# 2

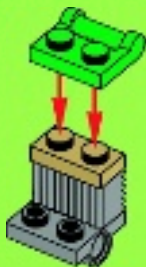

1x



2x



2x

# 3

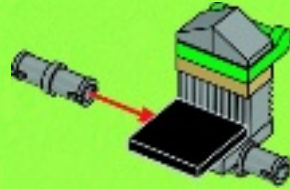

2x



2x



2x



2x



2x

# 4

1  2  3 

2x

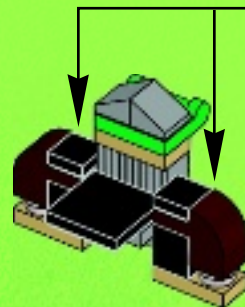



37

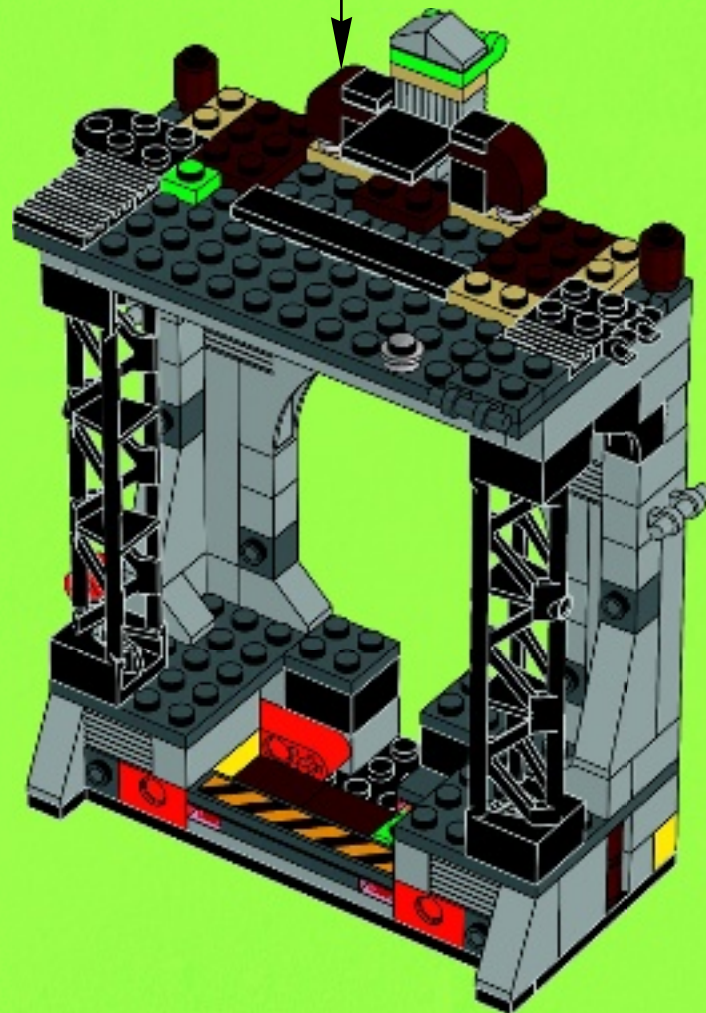





2x

# 38

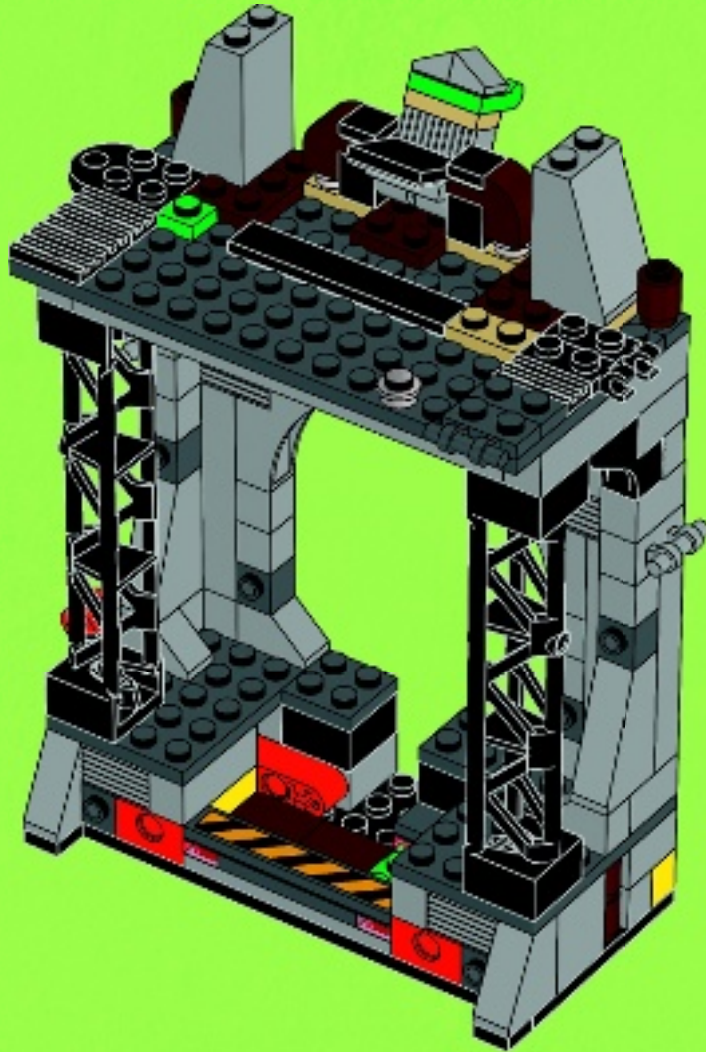





# 39

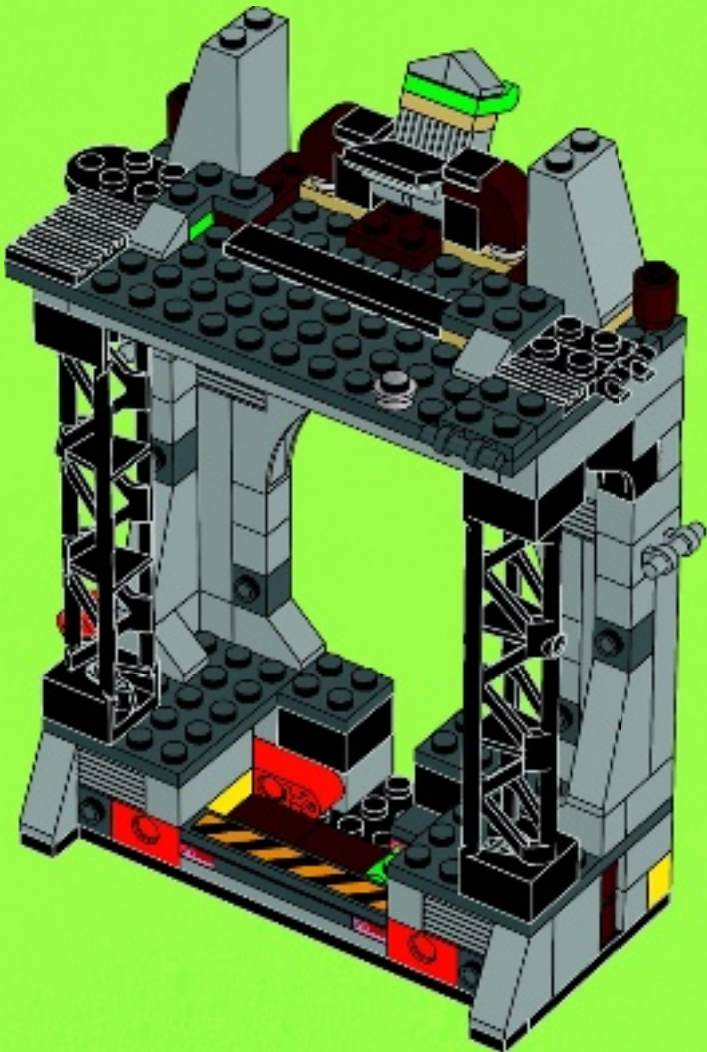





3x



2x

# 40

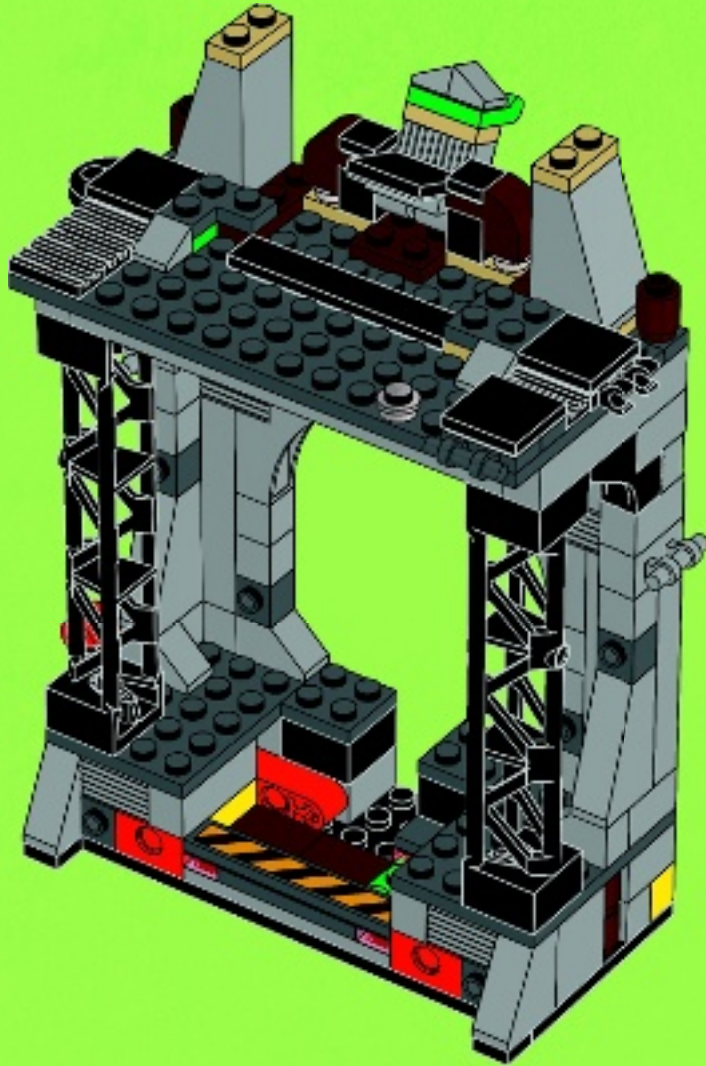





1x



2x

# 41

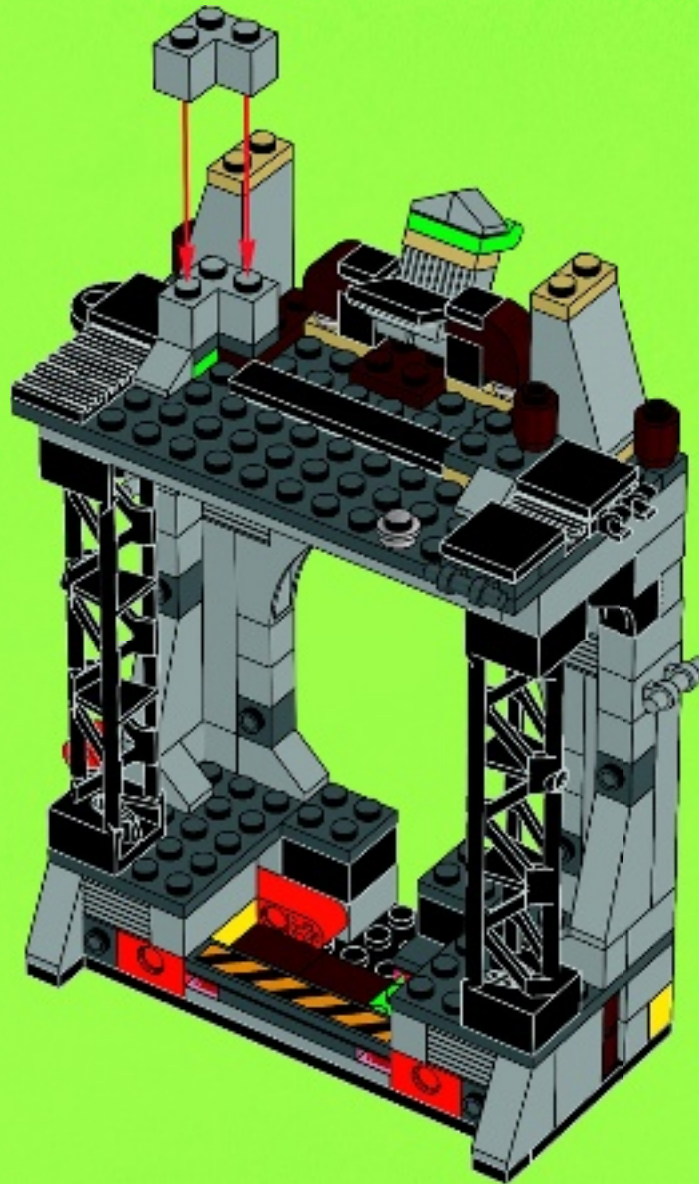





2x



1x

# 42

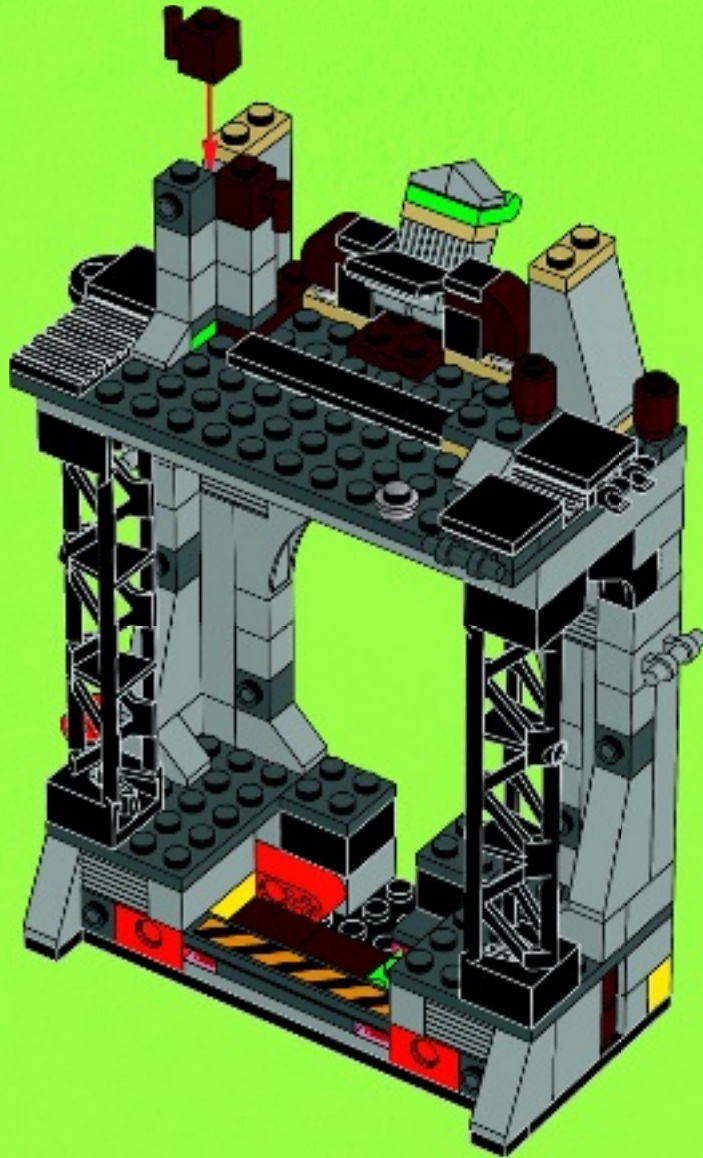





1x



1x

# 43

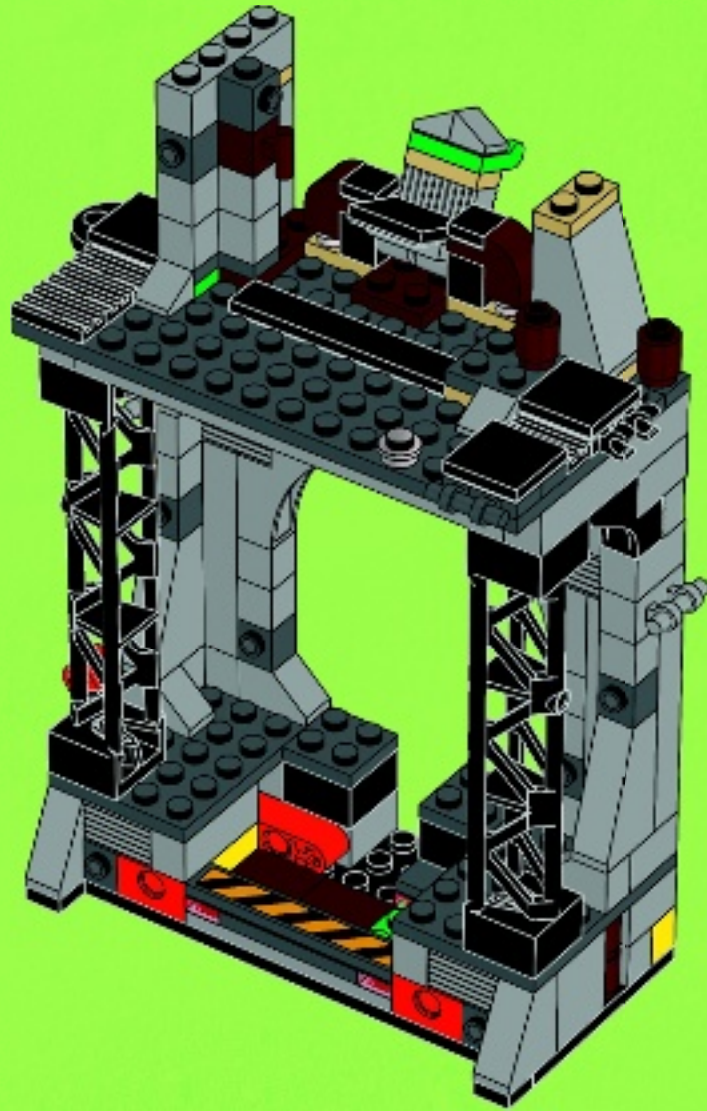





1x



1x

# 44

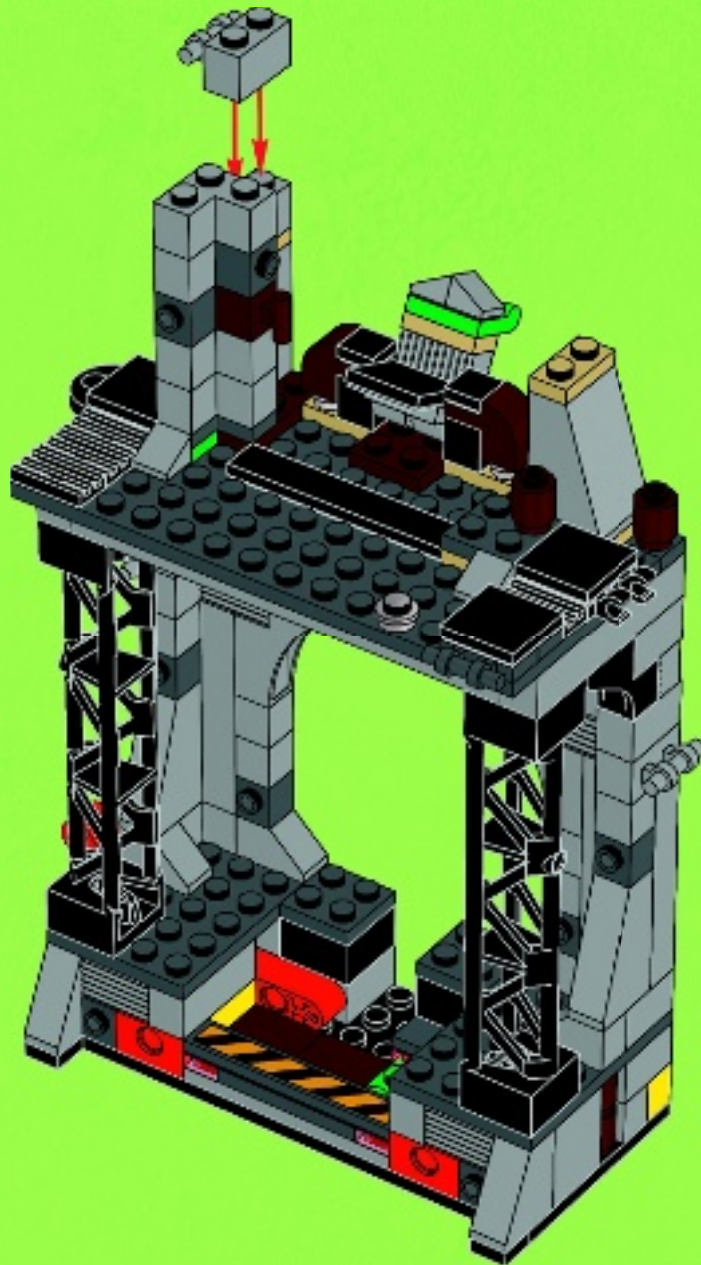





1x

1

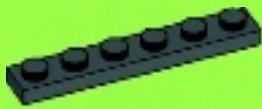

1x



1x



1x

2

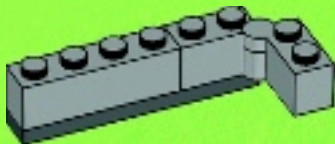
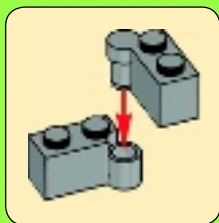

1x

3

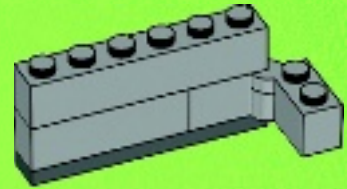

1x



1x

4

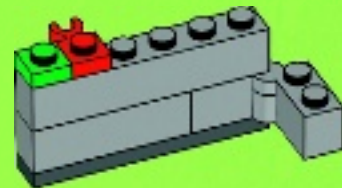

1x



1x



2x

5

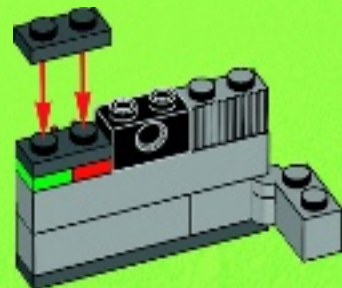



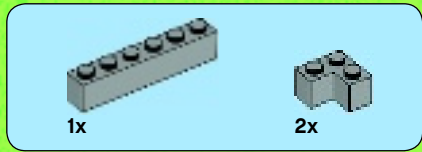

6

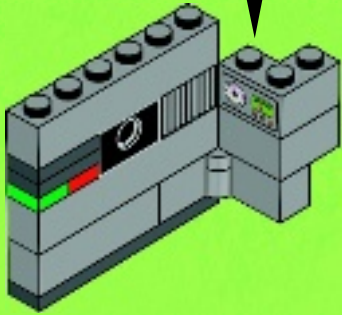
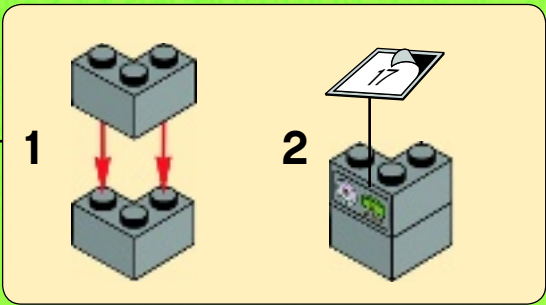

45

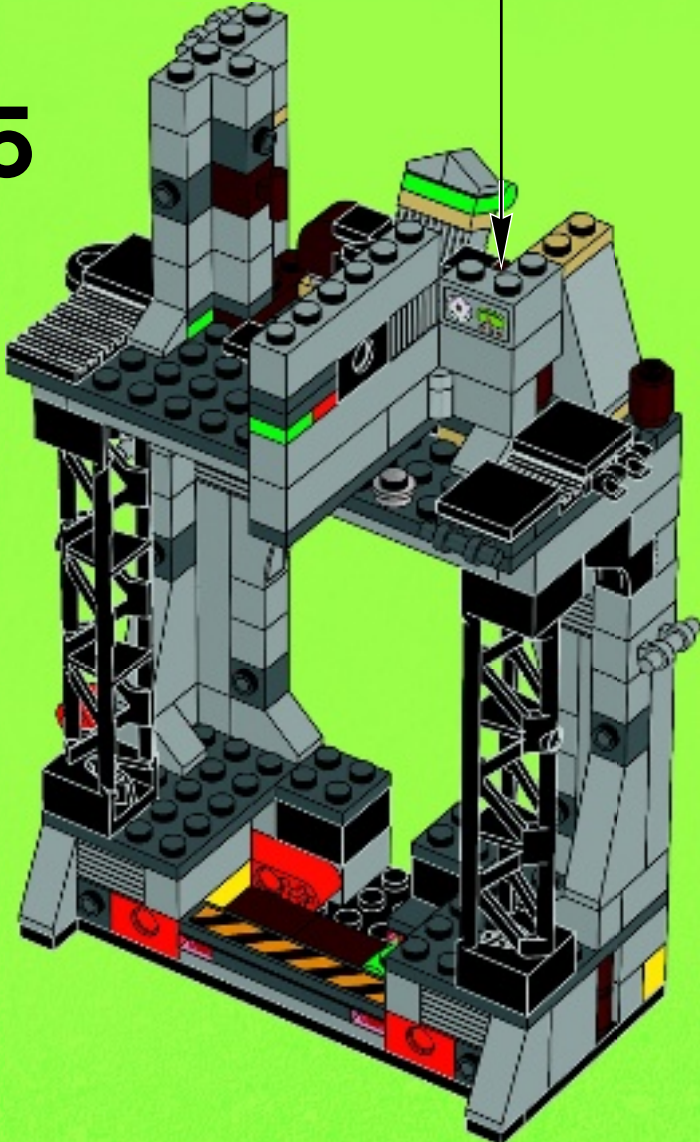





1x



1x

# 46

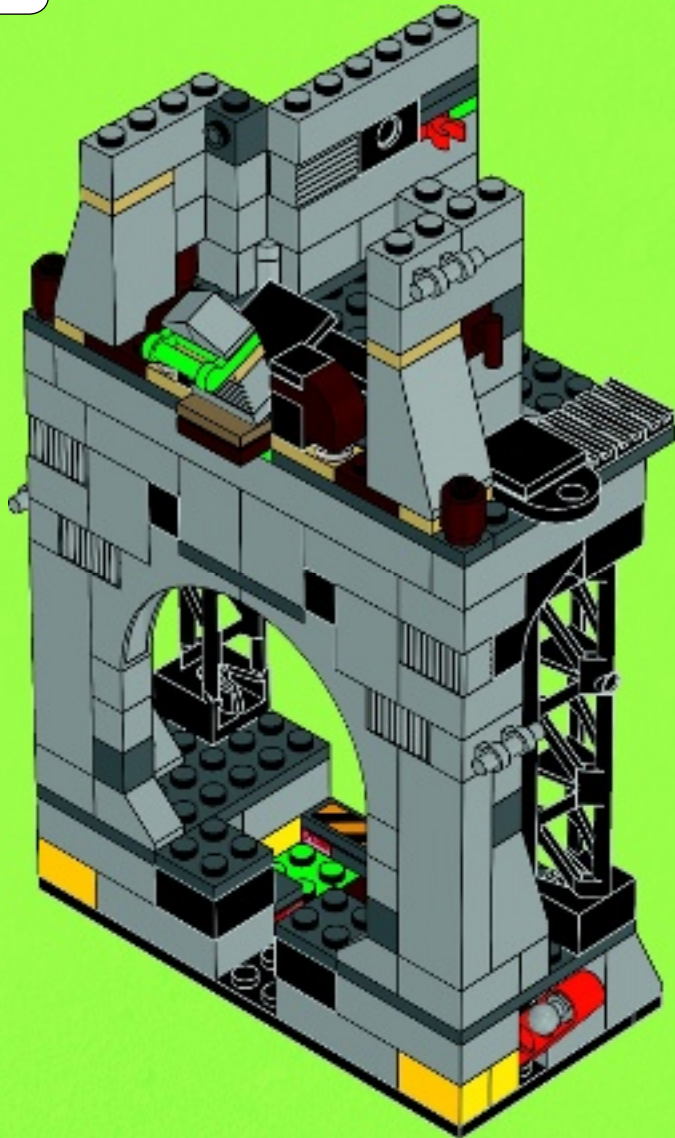





1x



1x

47

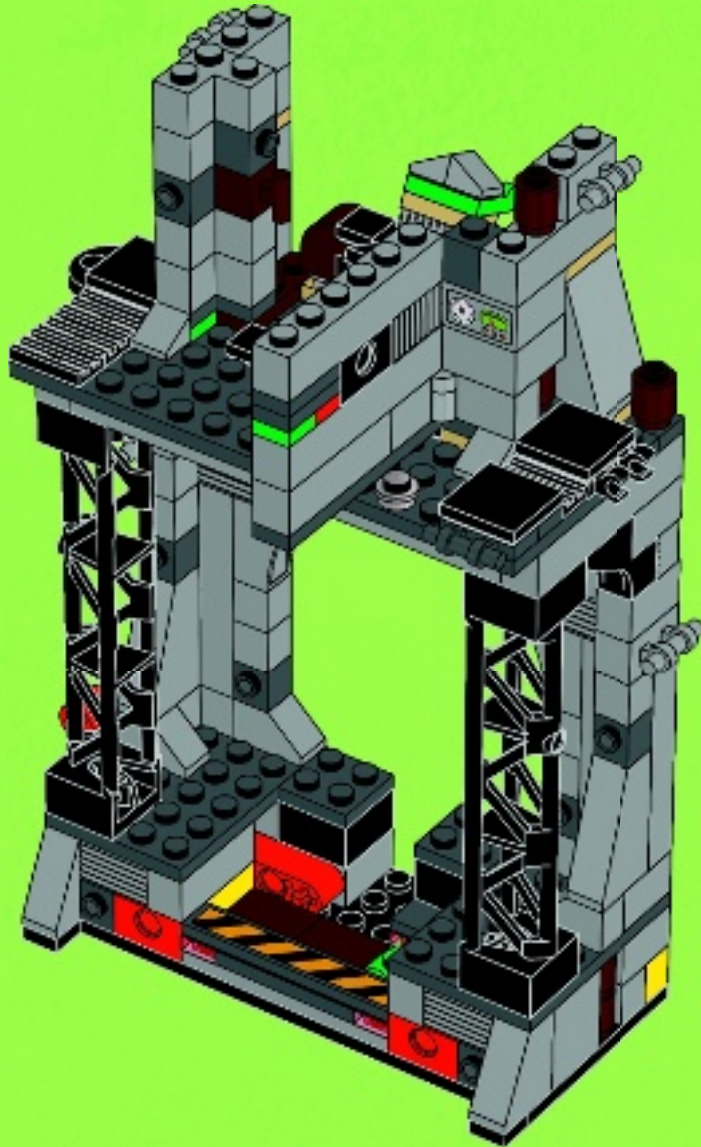



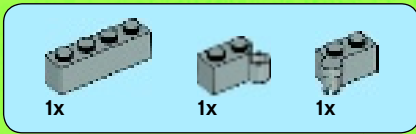

48

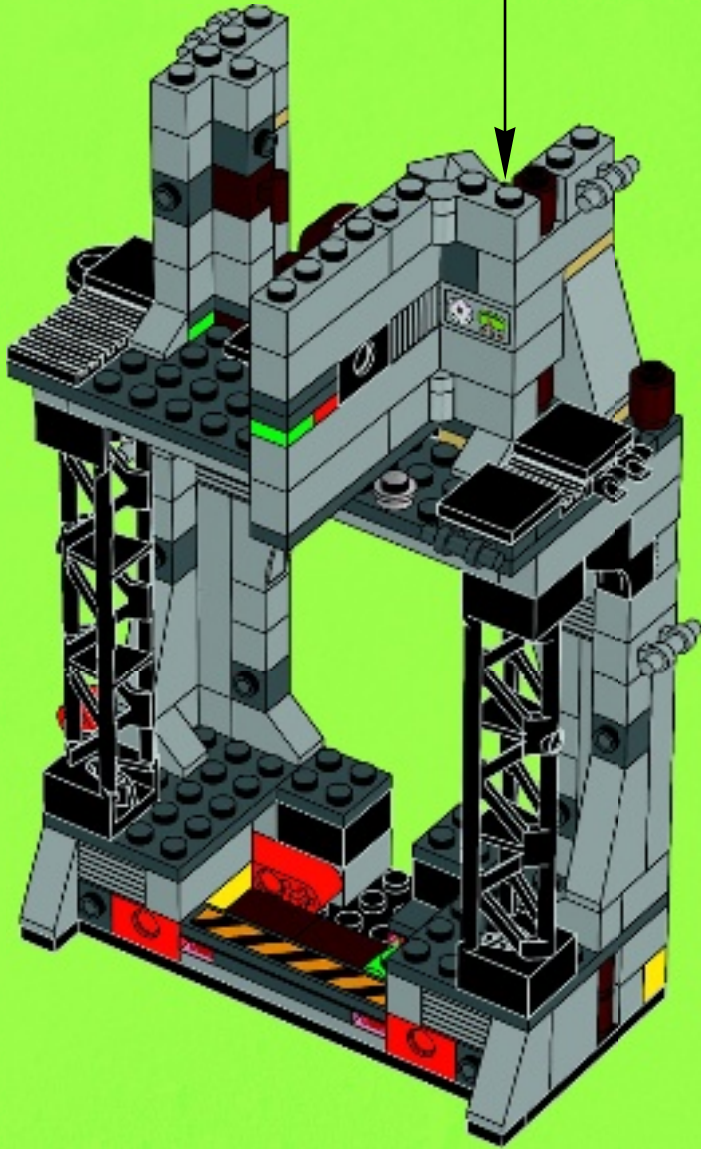
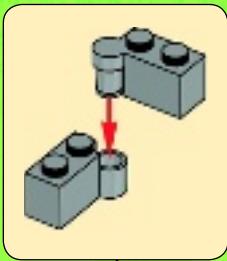





1x



2x

# 49

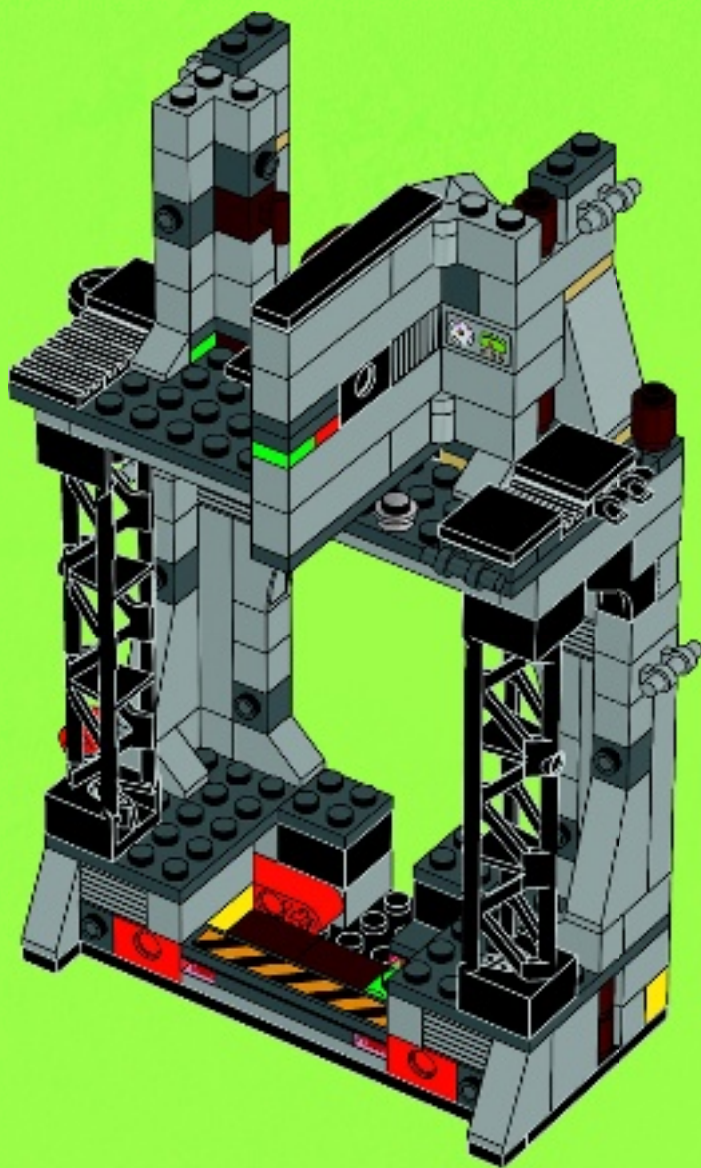





2x

# 50

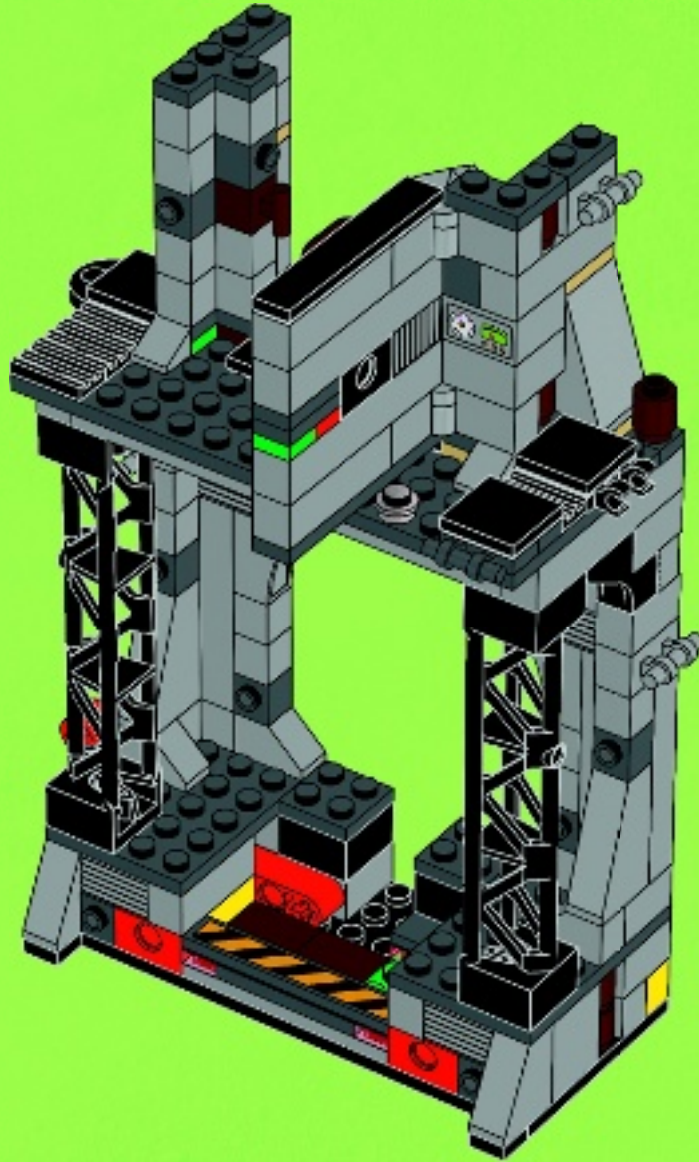





2x



2x

# 51

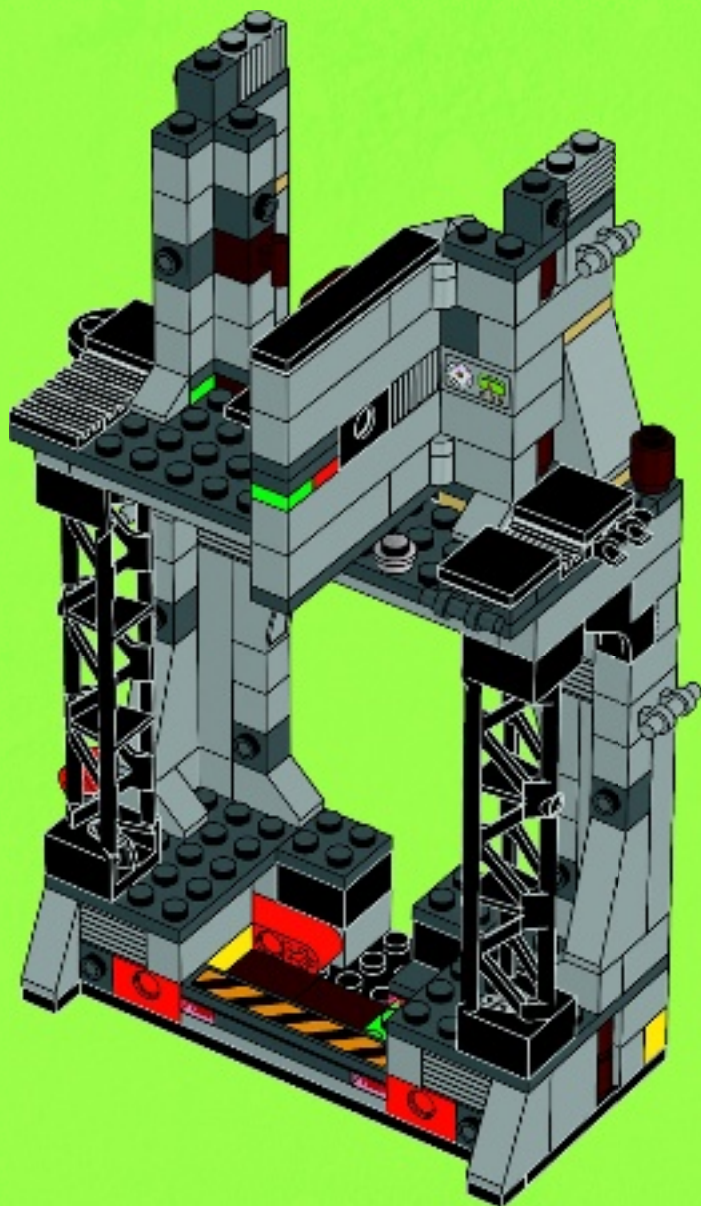



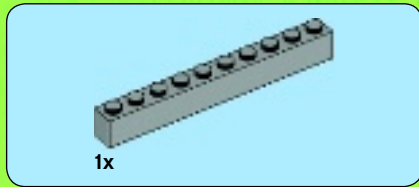

52

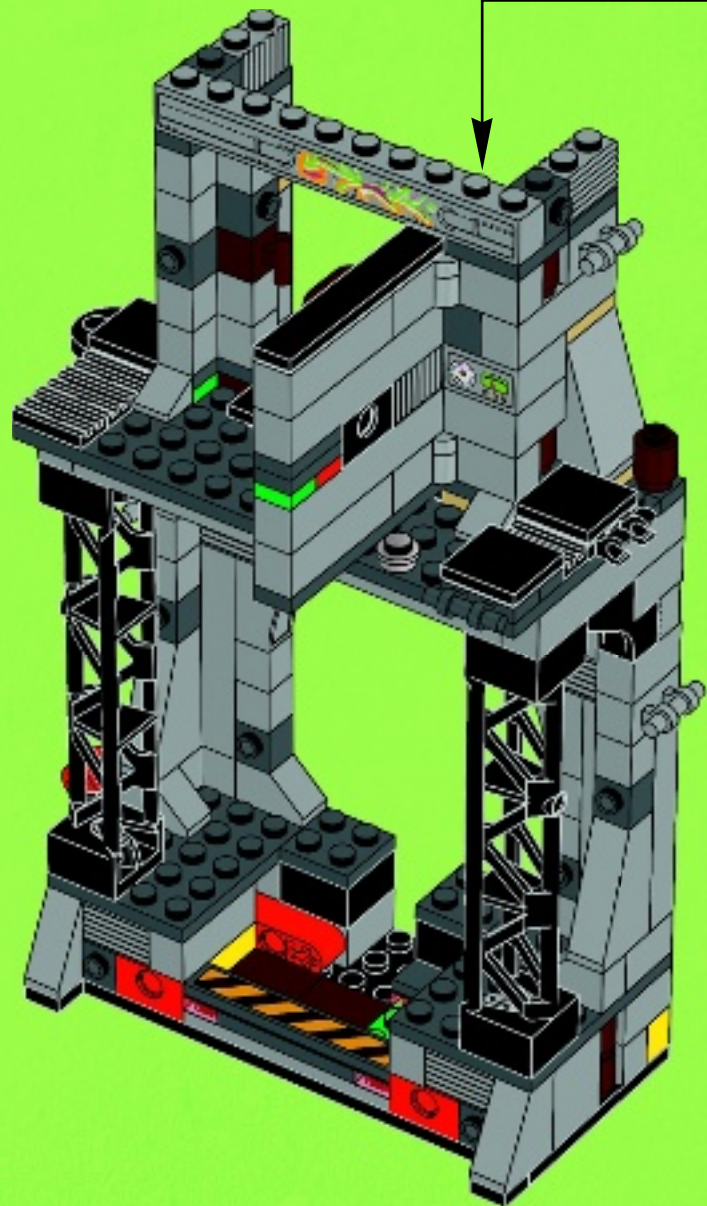
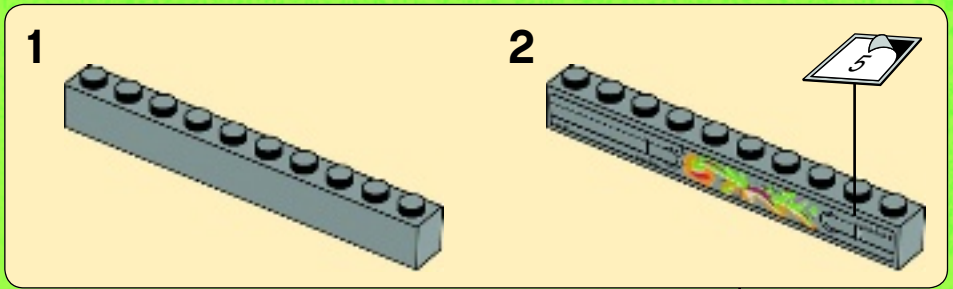





# 53

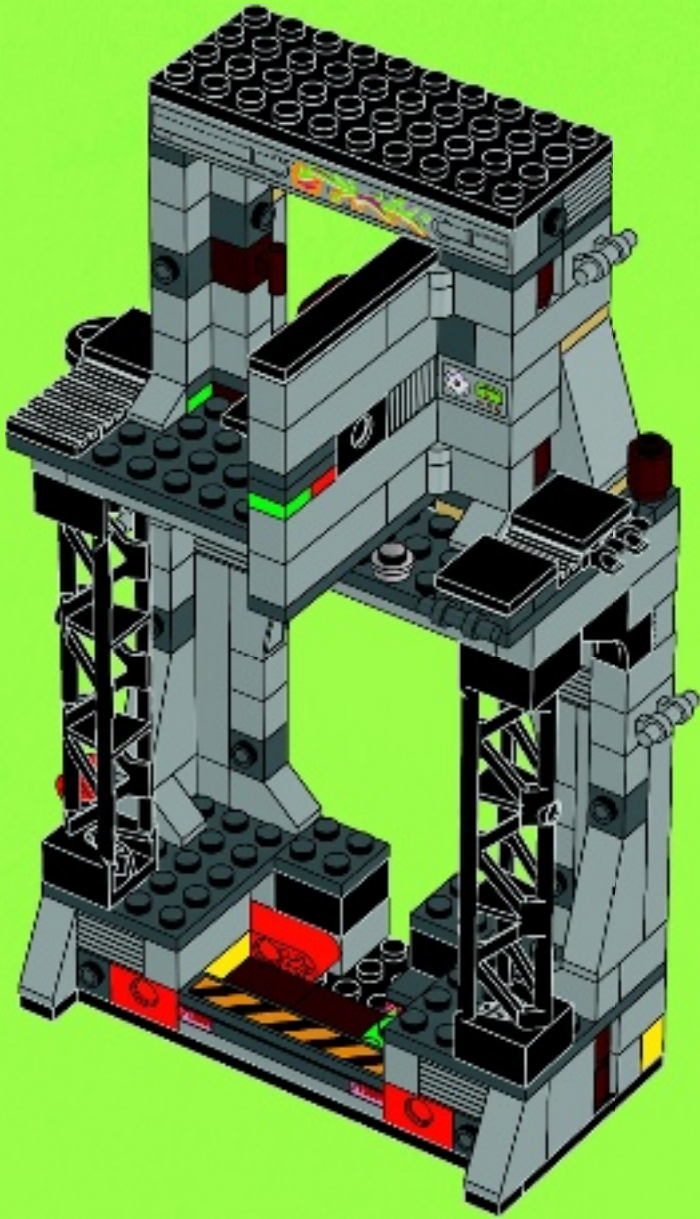



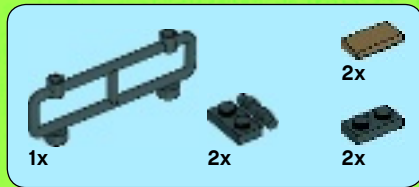

54

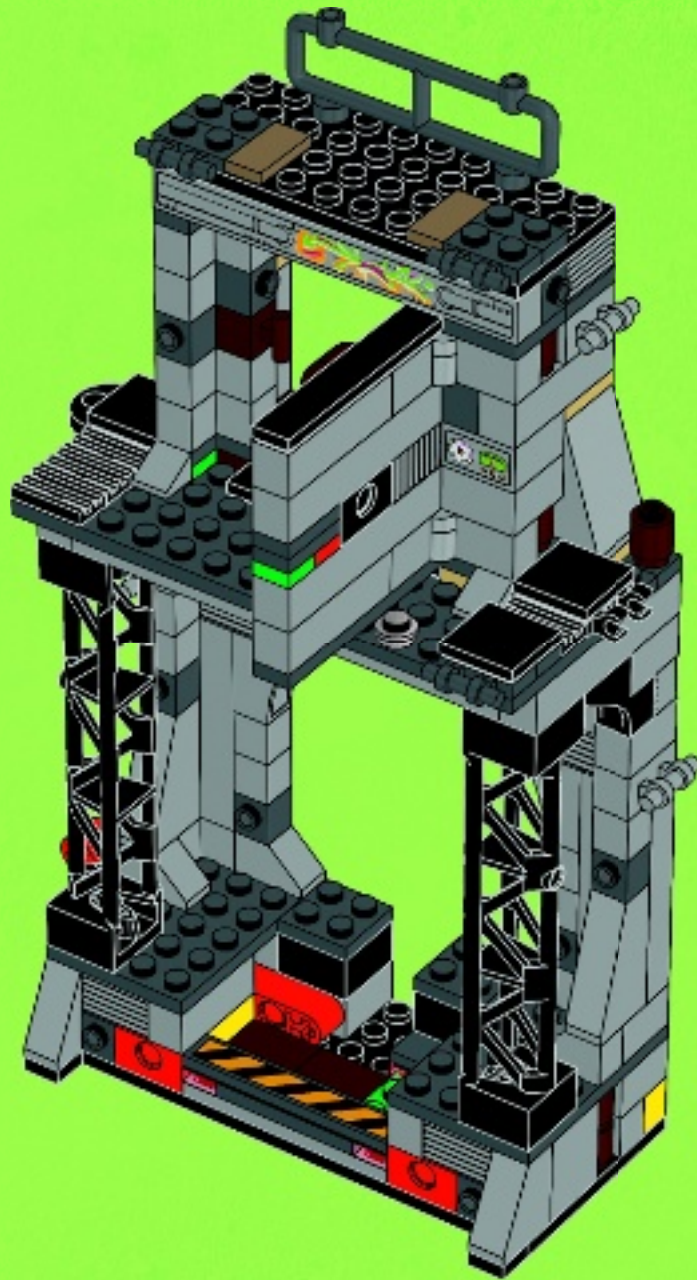





2x



1x

# 55

1



2

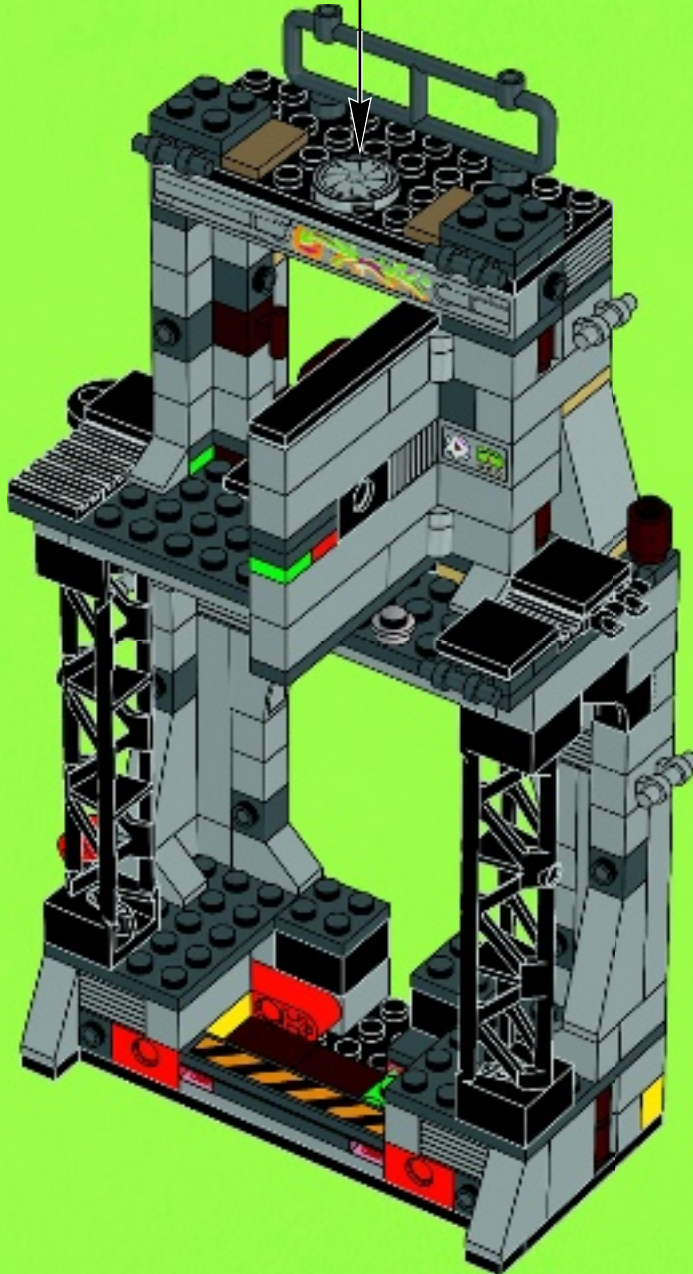
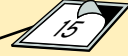





2x 4x 2x

# 56

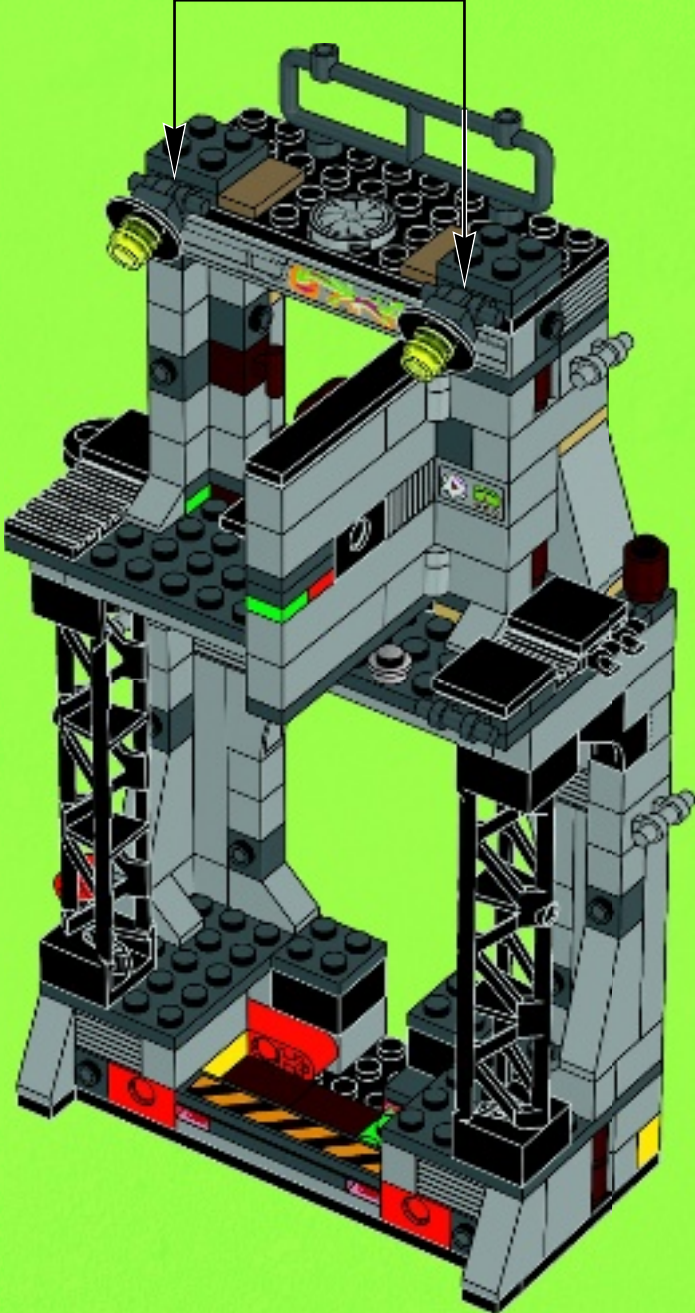
1 2 2x





2x  2x 

 2x

57

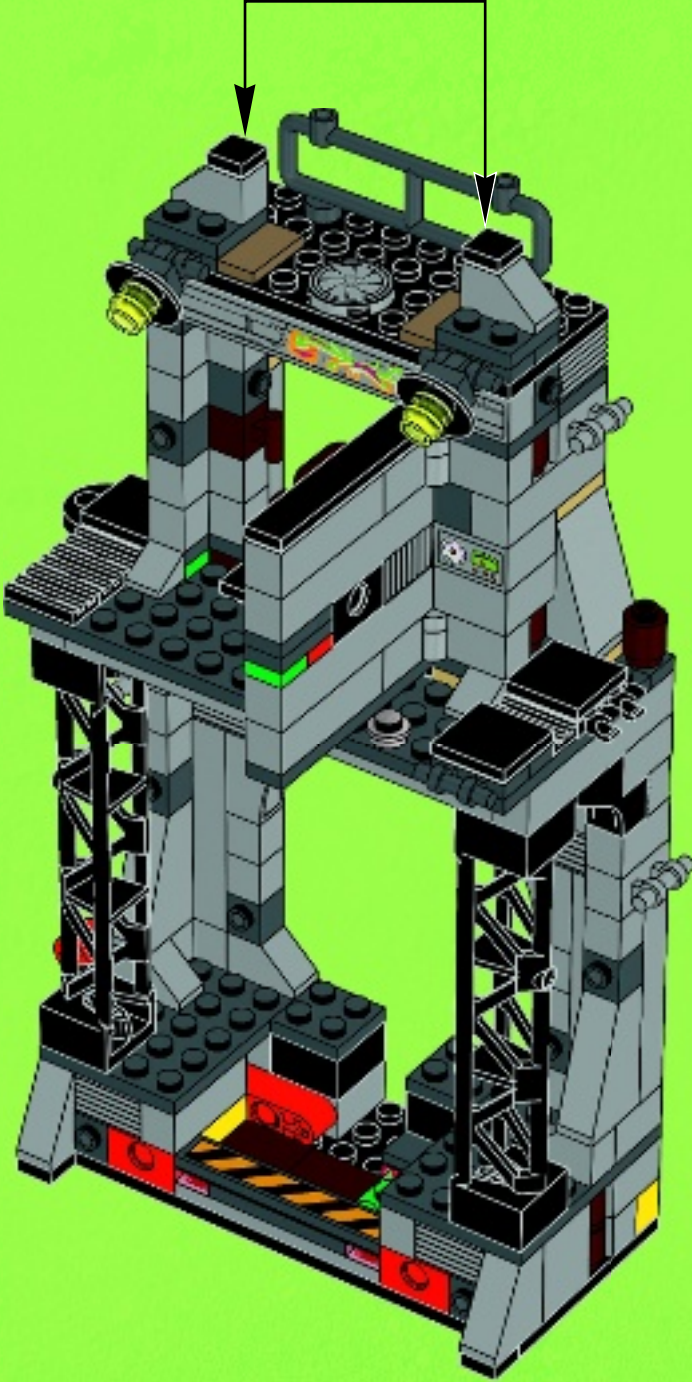



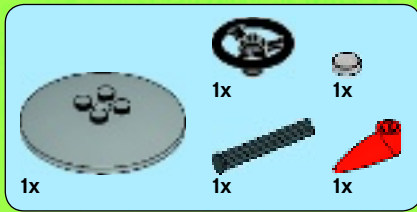

58

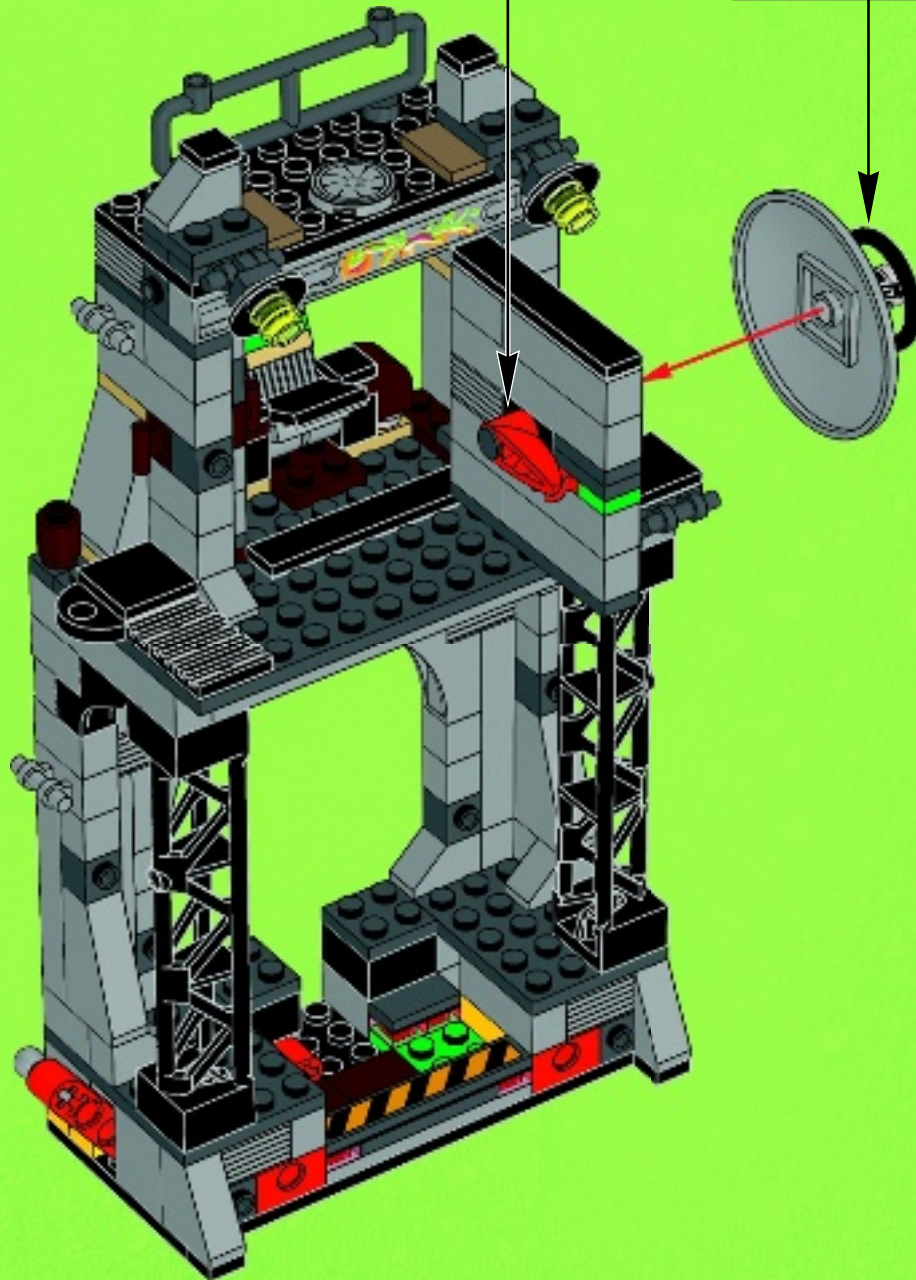
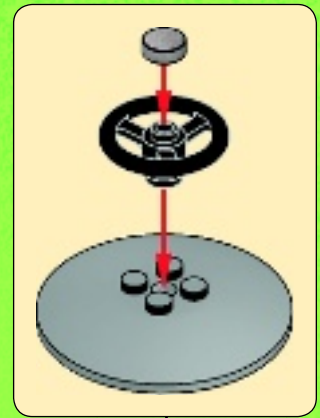
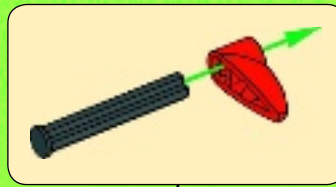



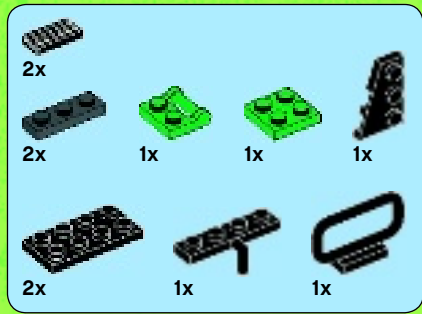

# 59

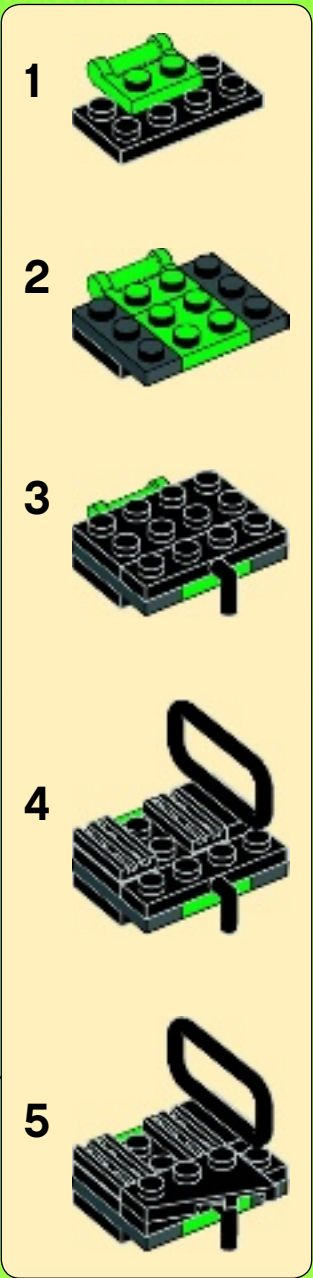
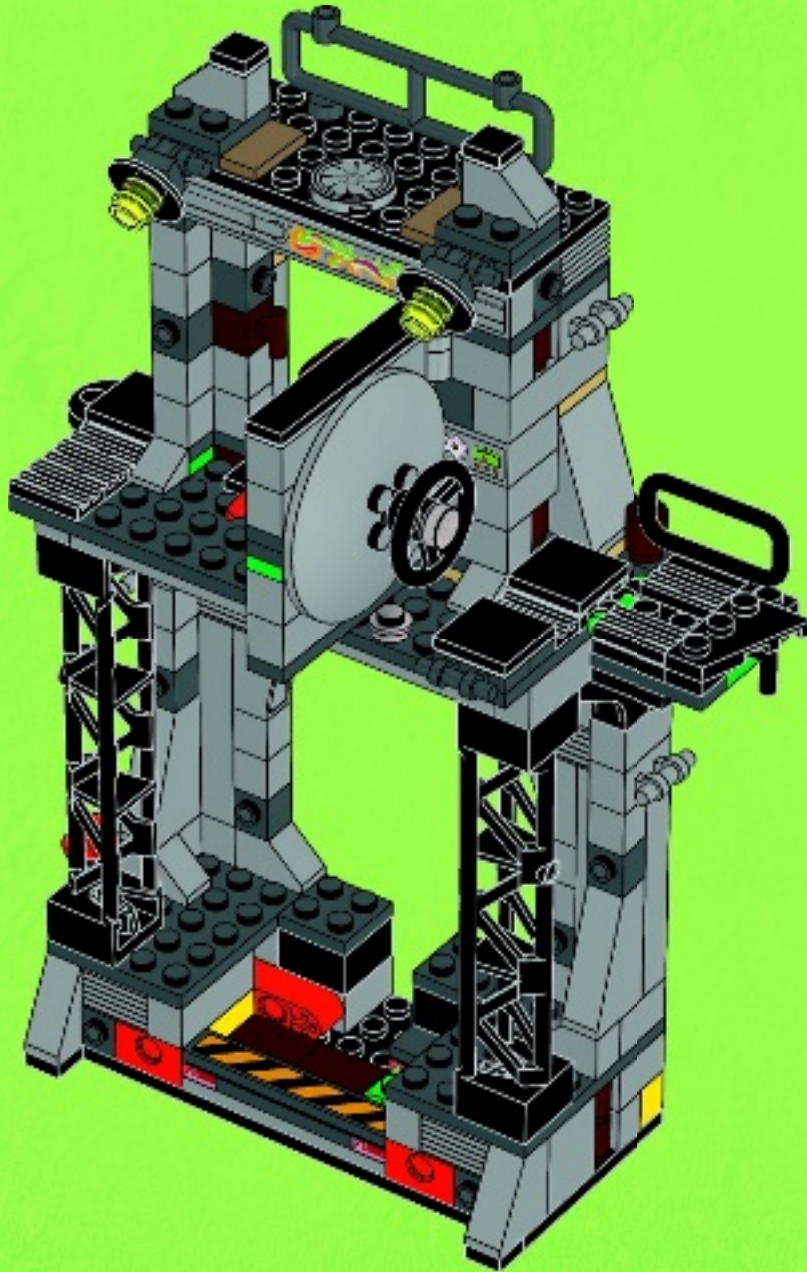



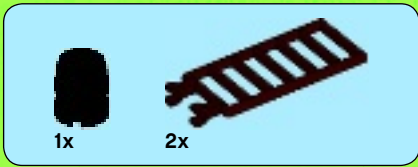

60

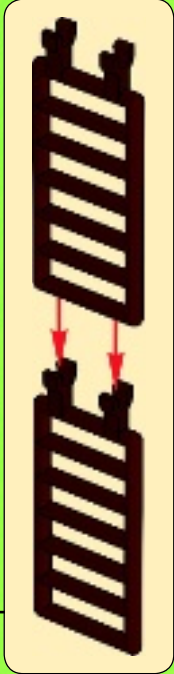
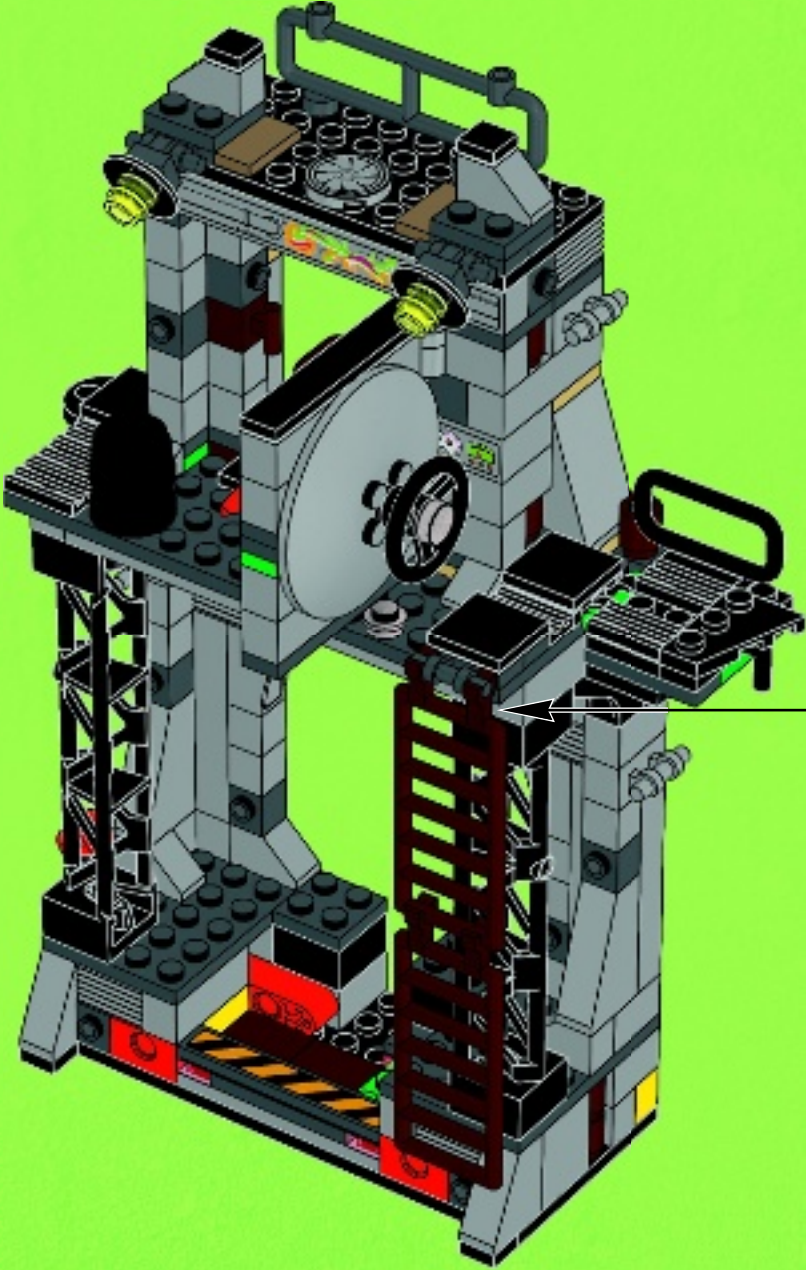





1x

# 61

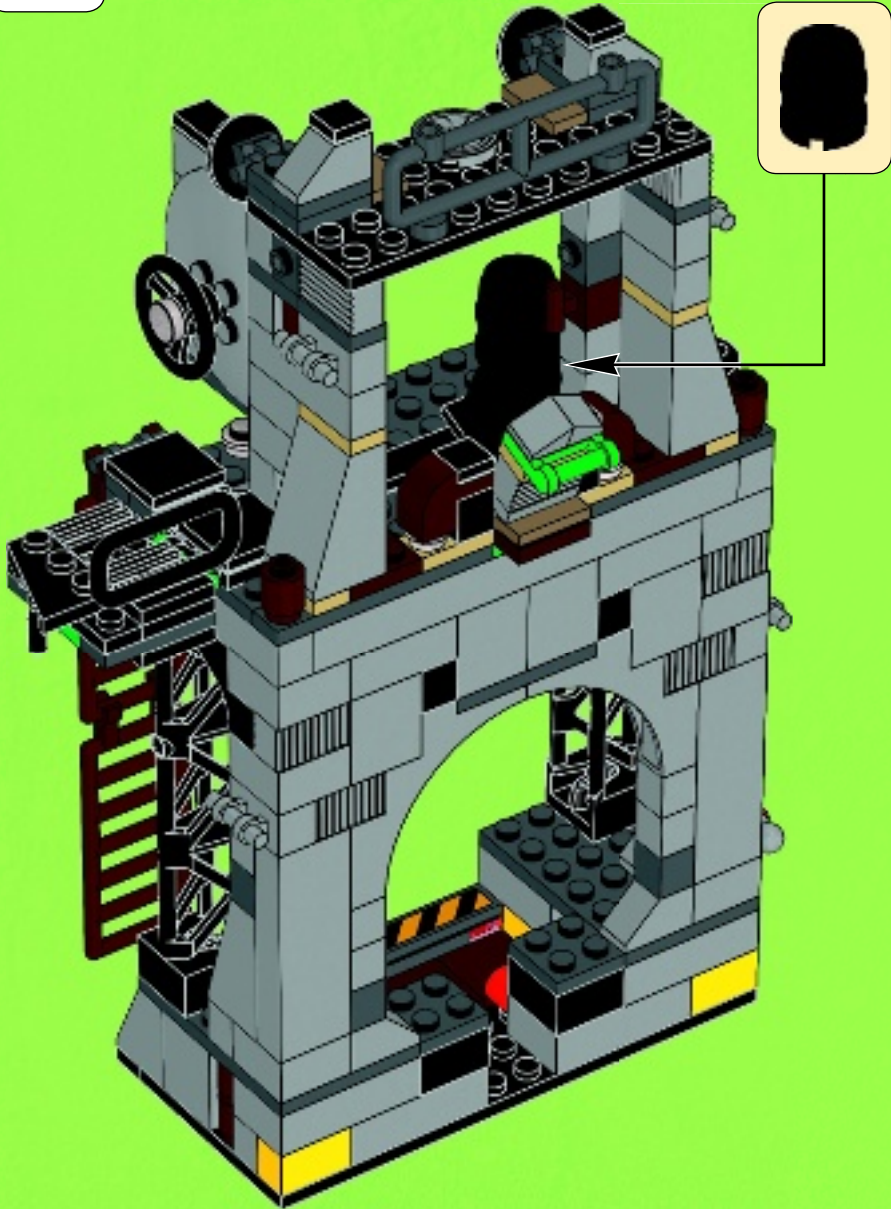



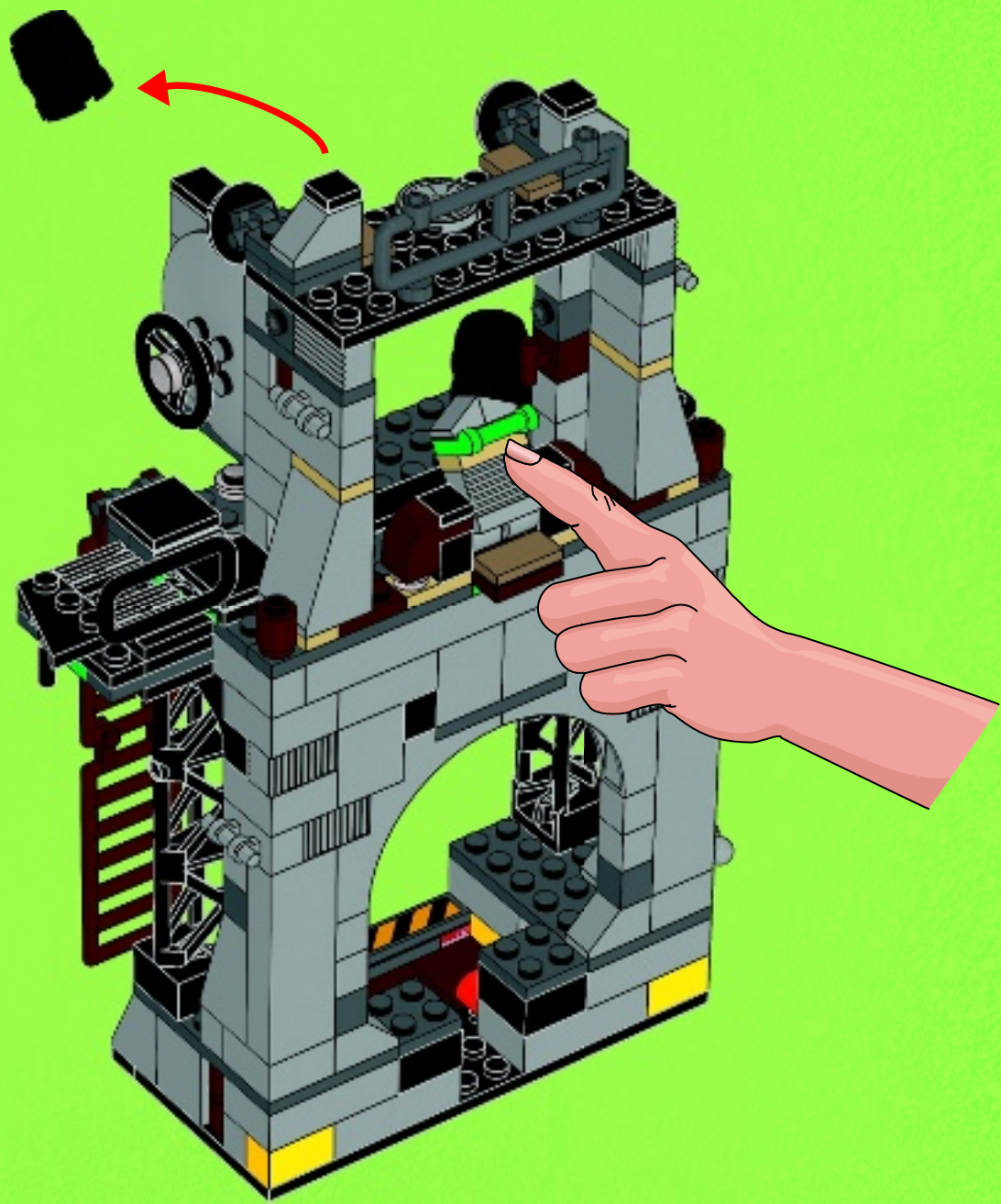



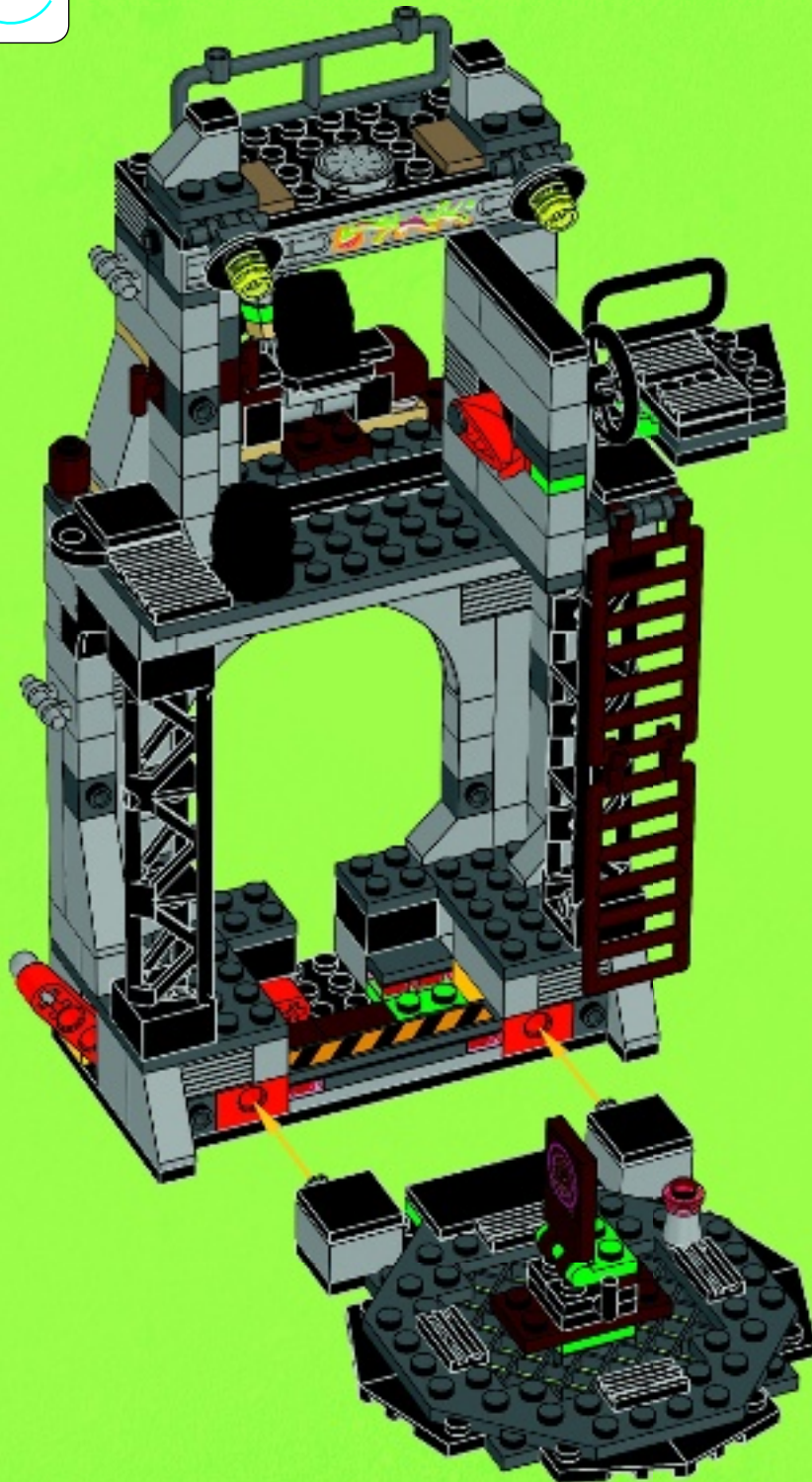



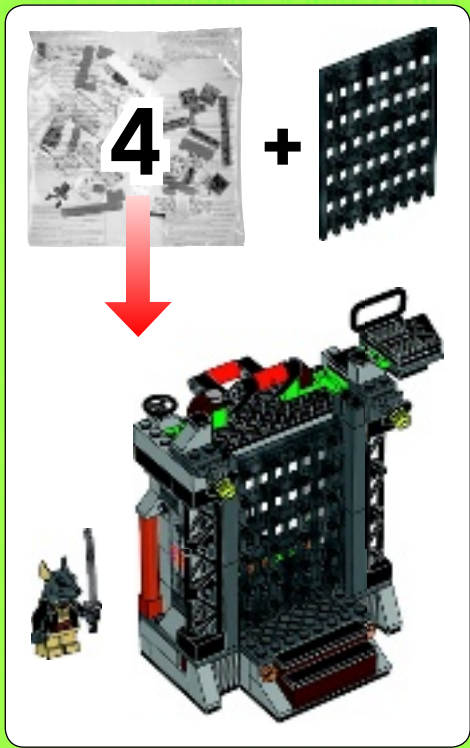

1

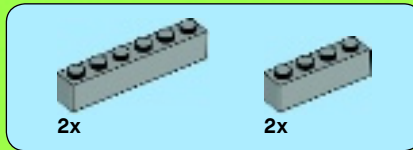

2

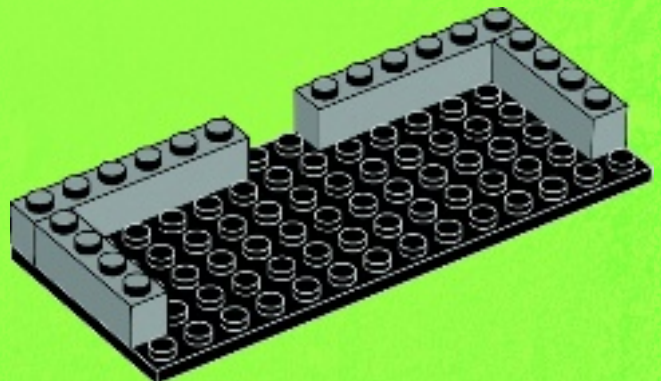



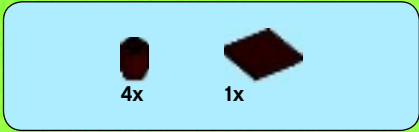

3

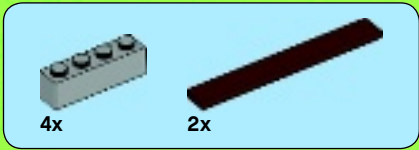
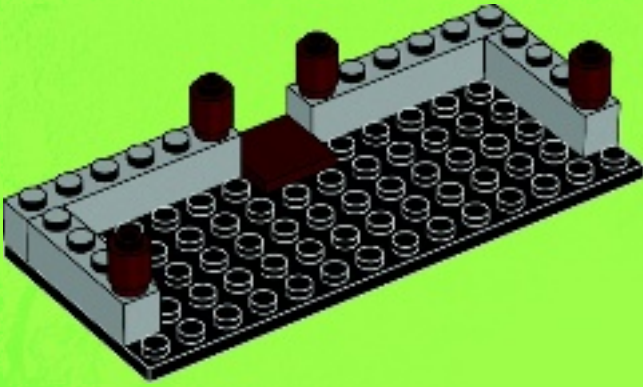

4

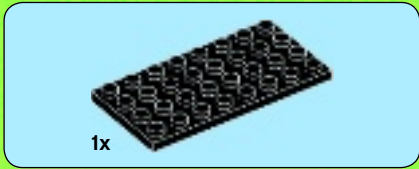
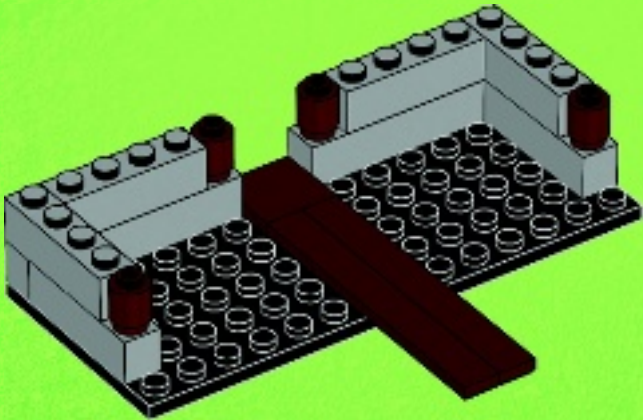

5

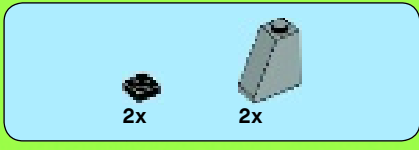
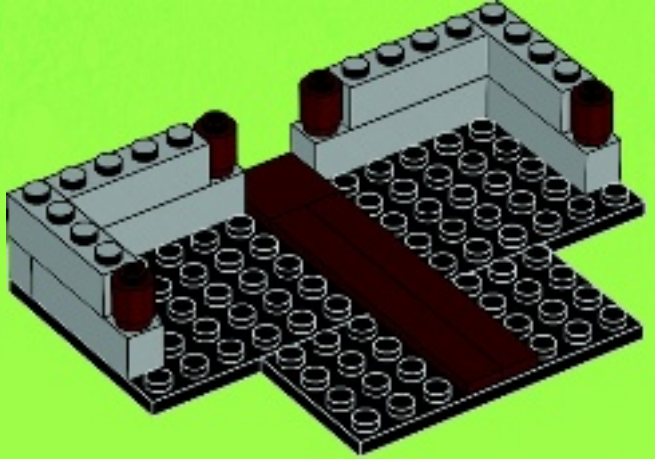

6

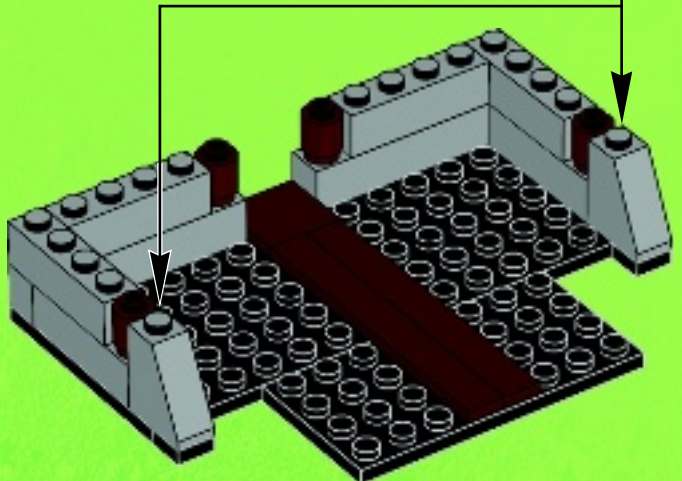
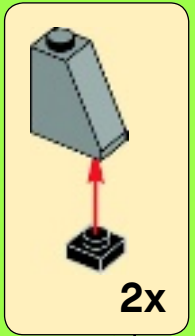



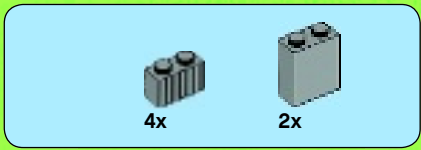

7

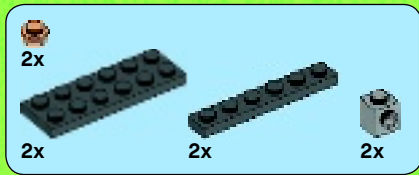
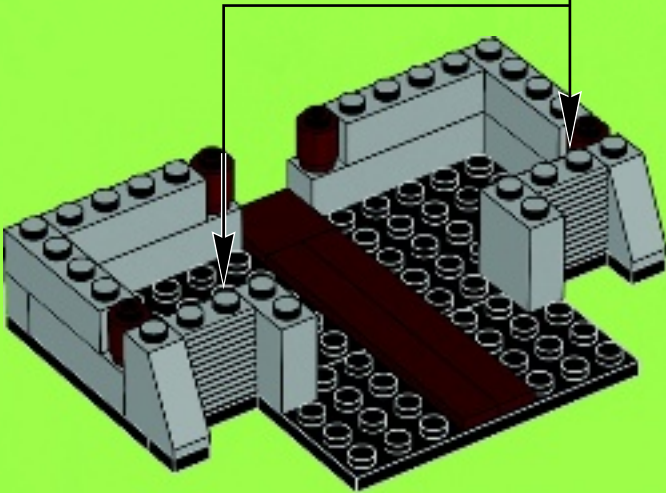
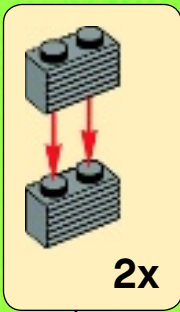

9

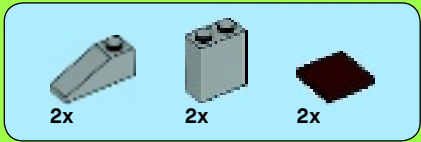
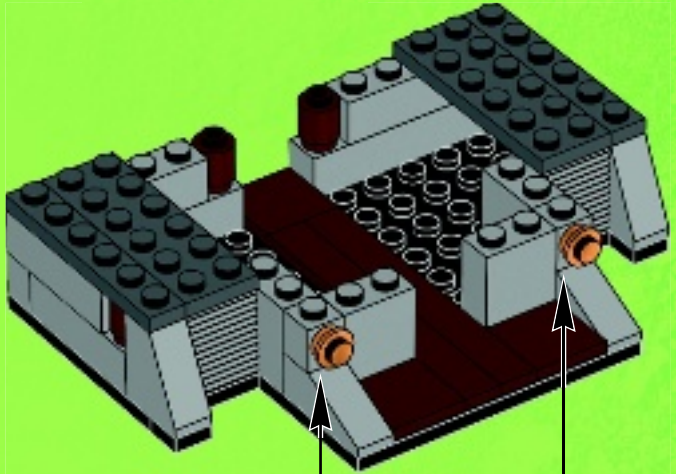

8

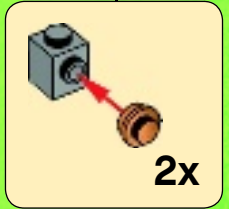
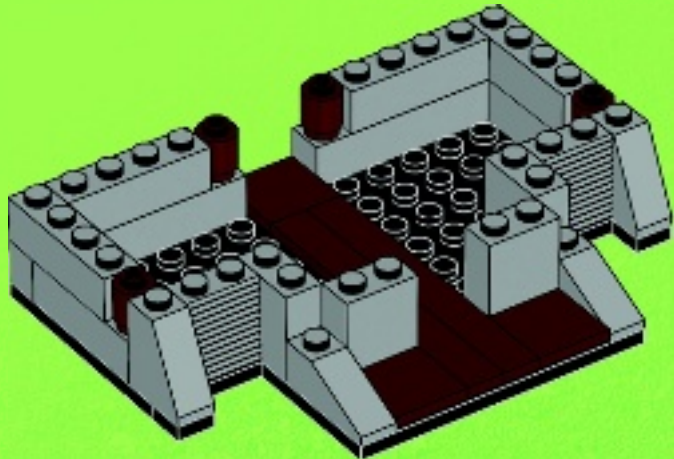



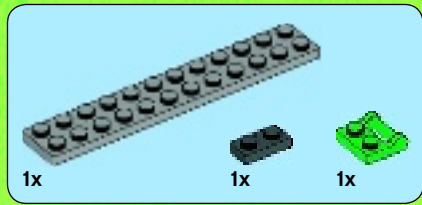

1

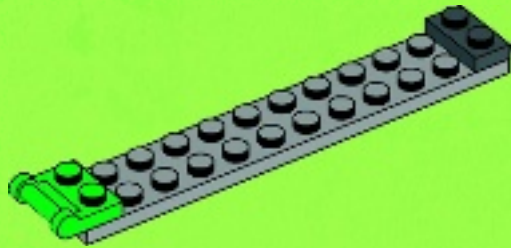

2

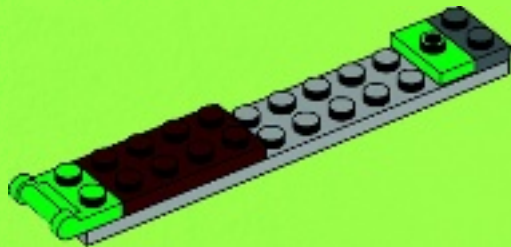

3

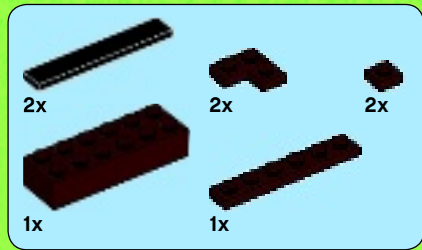
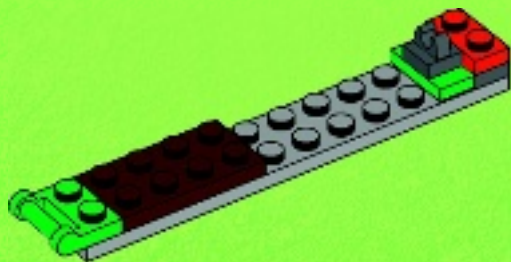

4

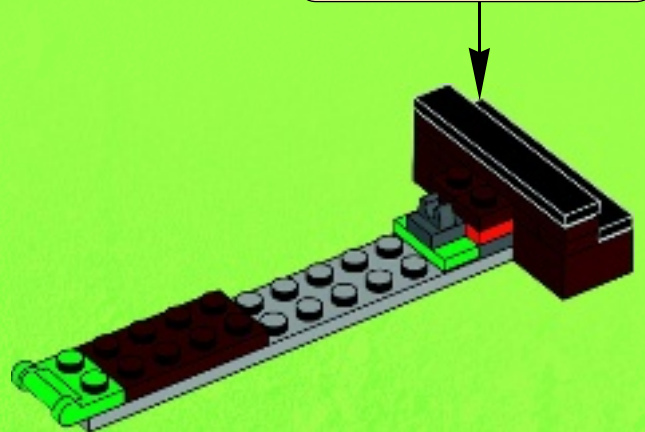
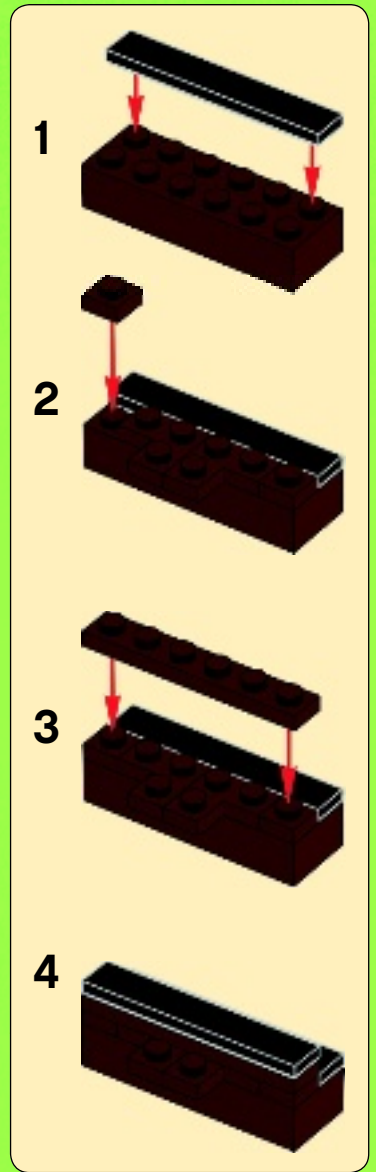



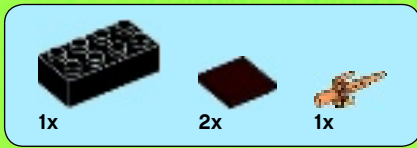

5

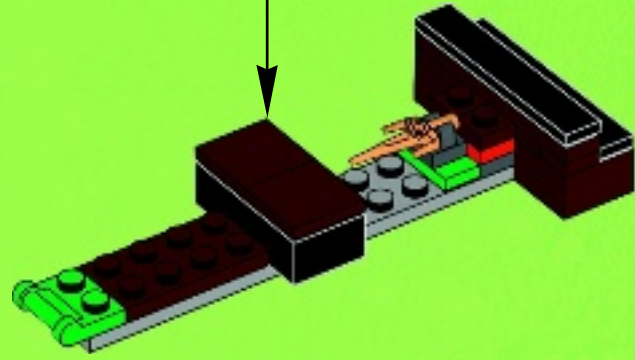
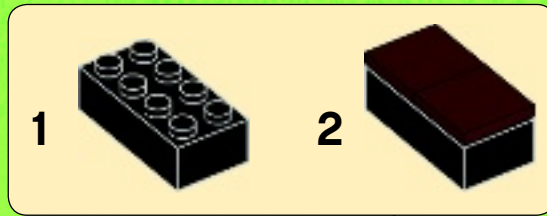

10

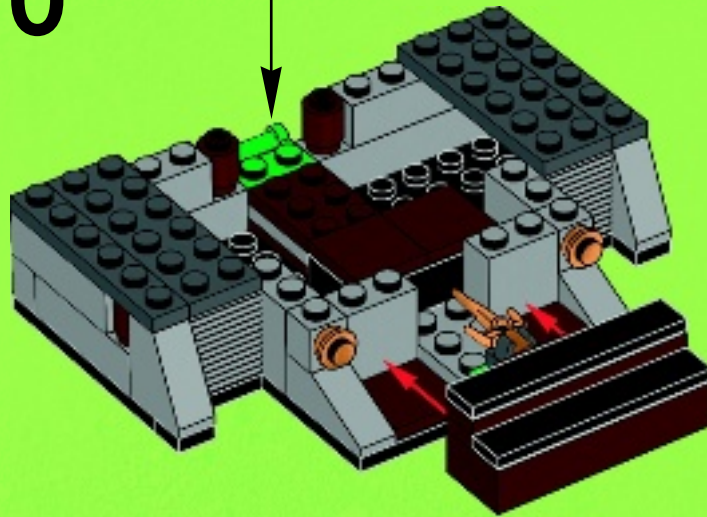





1x

# 11

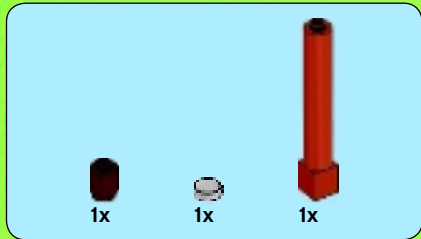
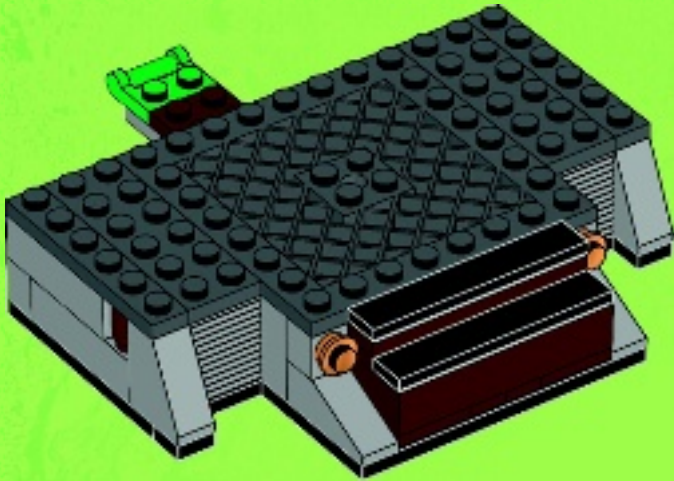

1x

1x

1x

# 12

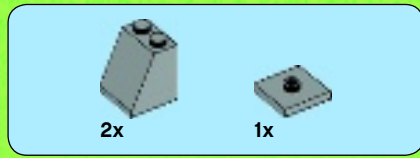
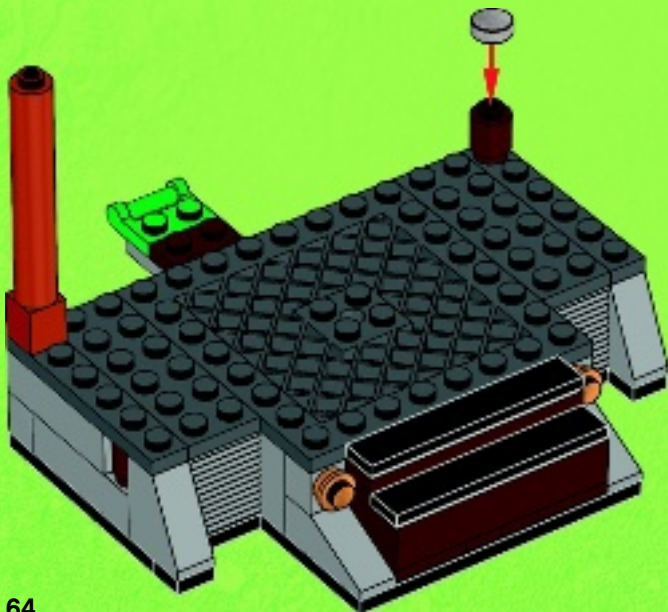

2x

1x

# 13

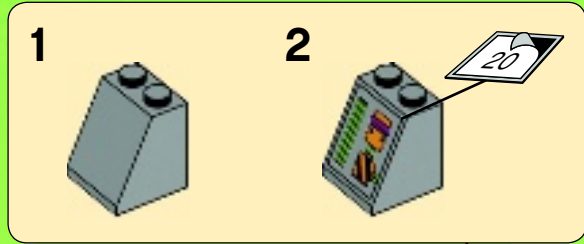

1

2

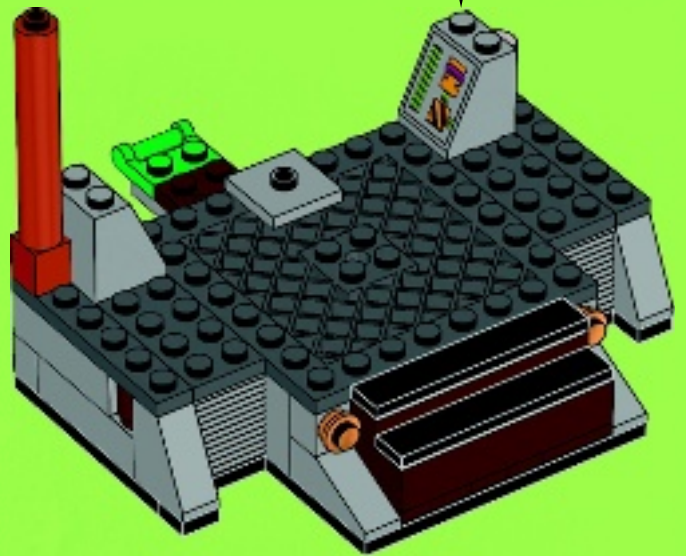





2x

# 14

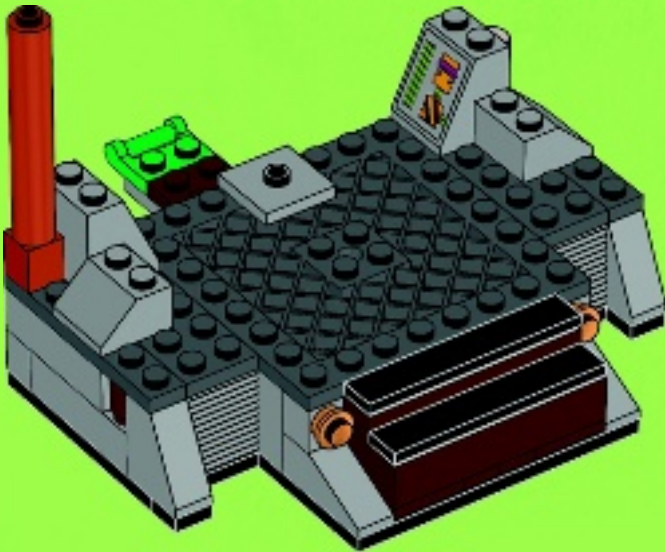

2x



2x

# 15

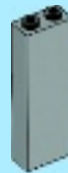

3x



1x



1x

# 16

1



2

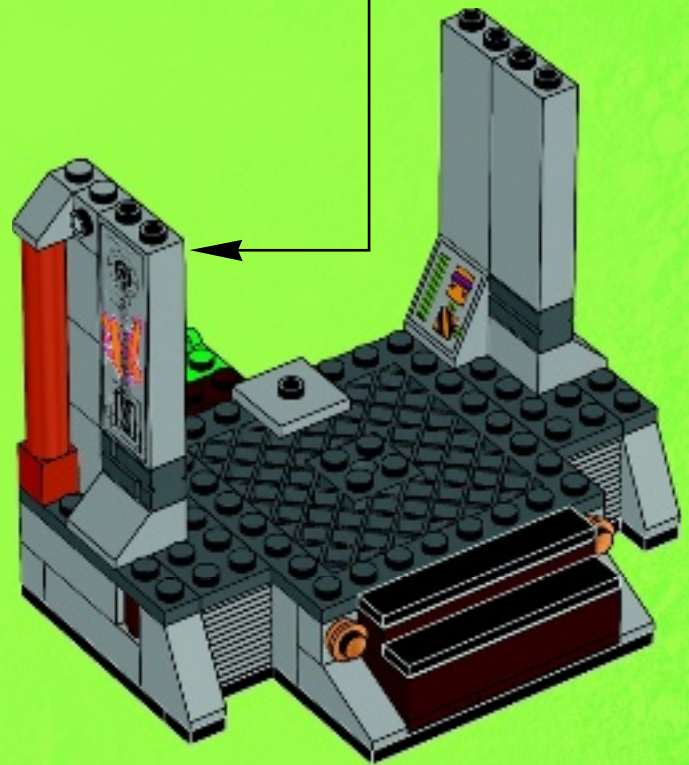



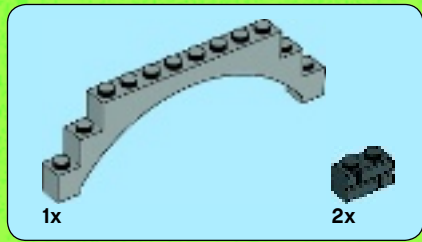

17

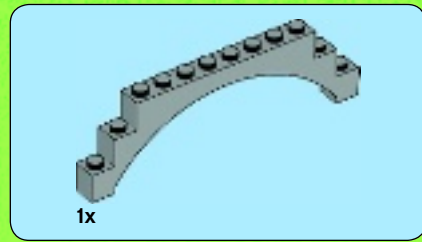
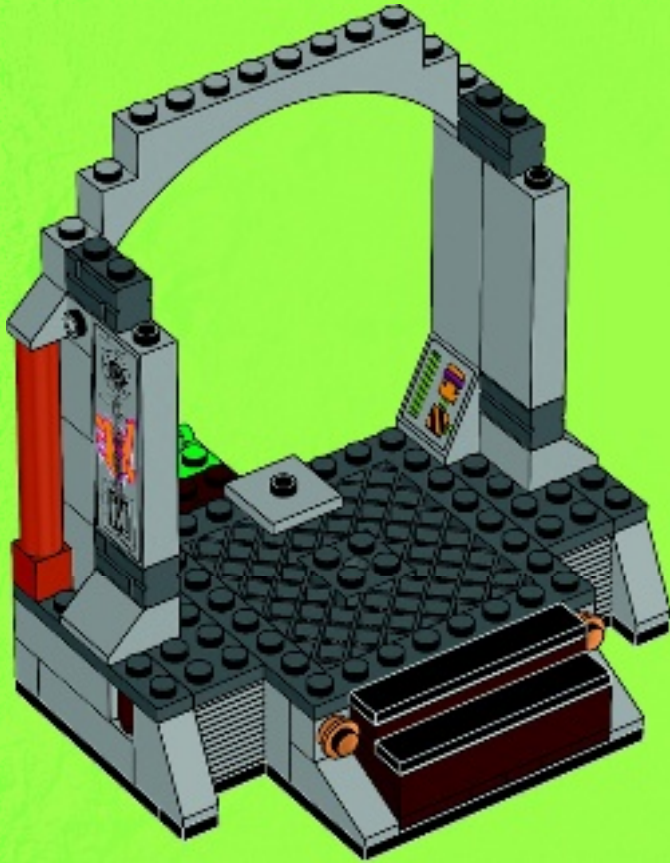

18

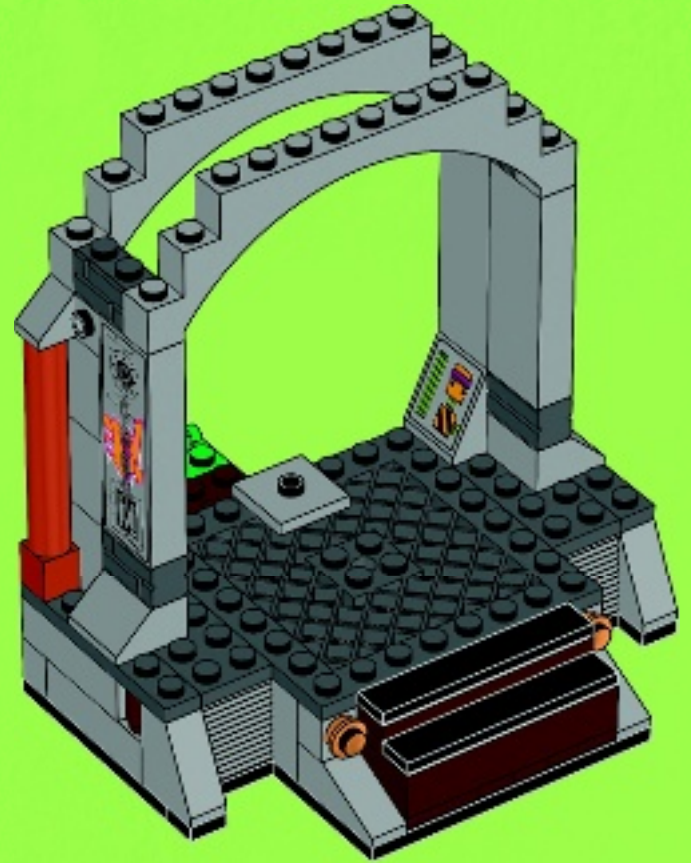





2x



4x

# 19

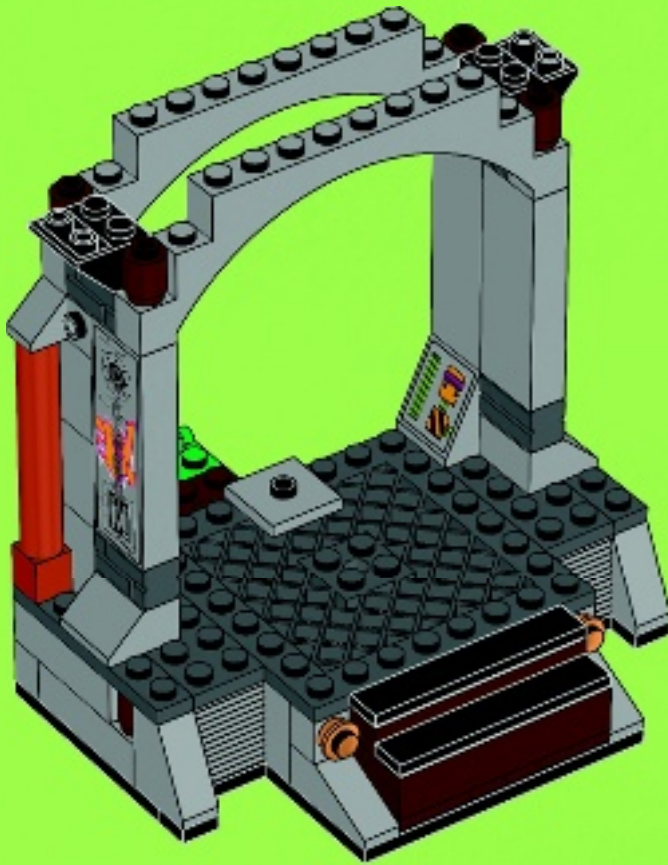

2x



2x

# 20

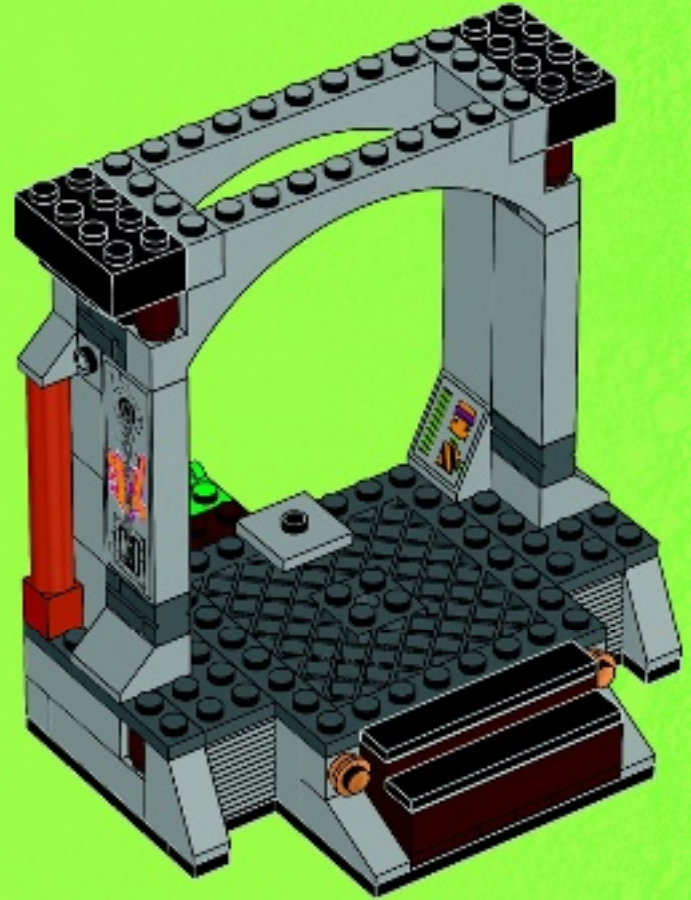



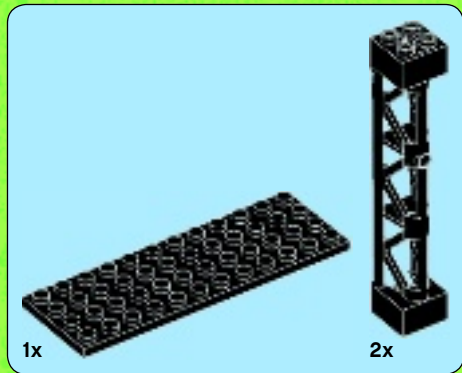

21

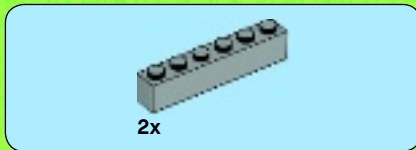
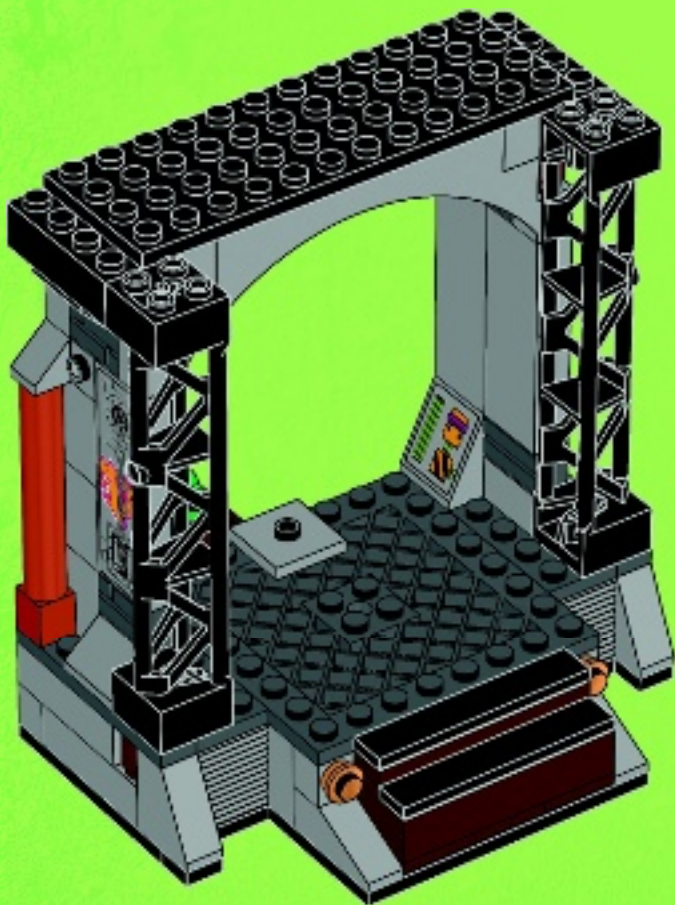

22

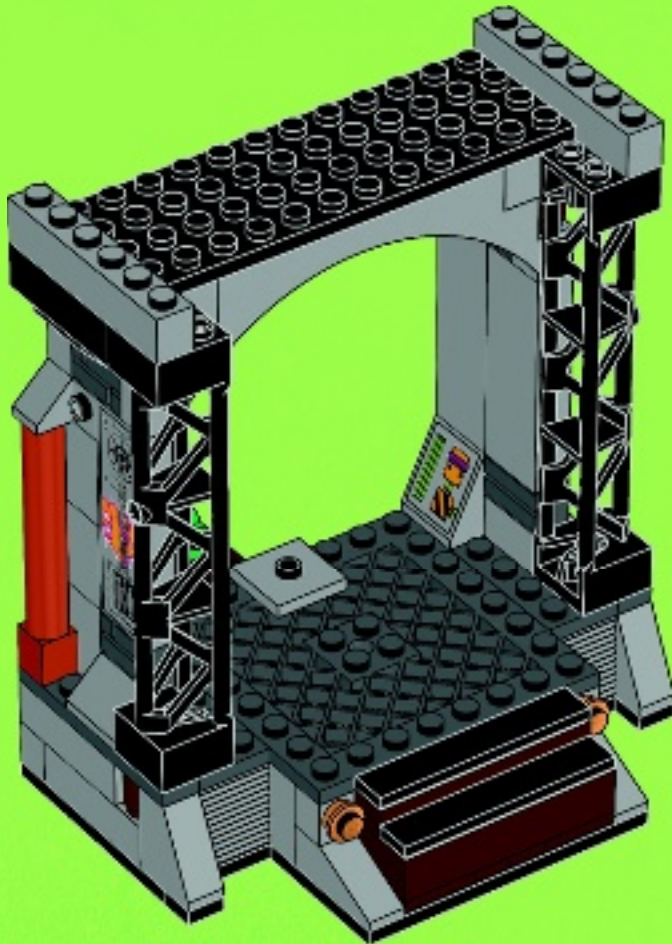





# 23

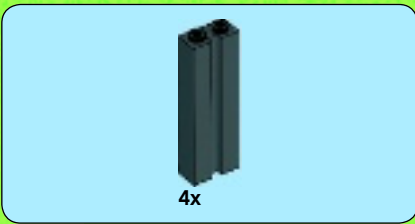
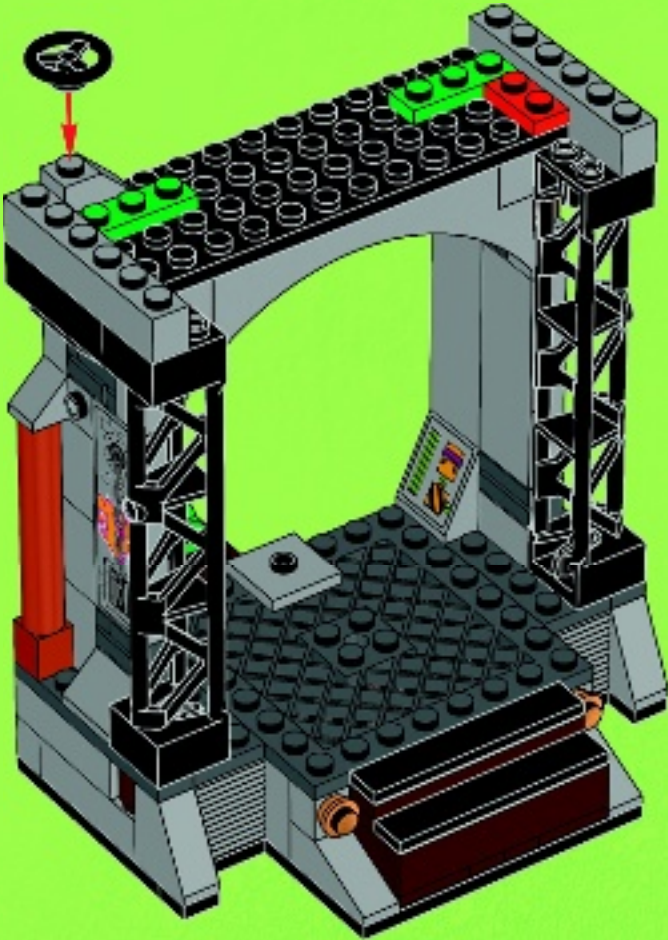

# 24

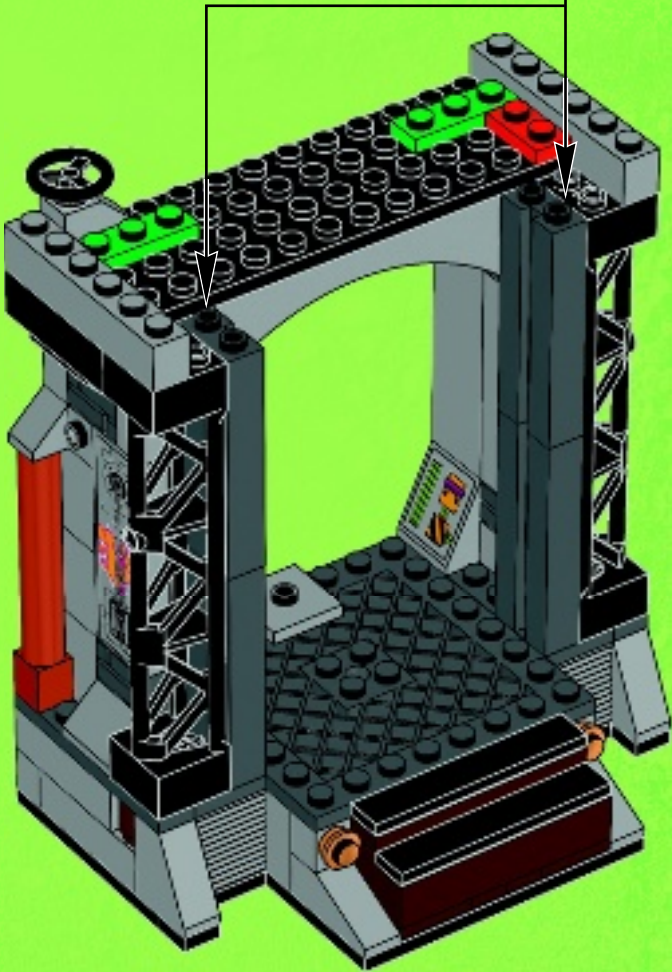
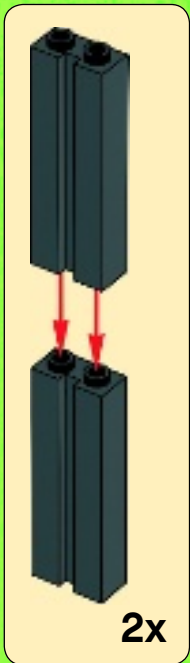



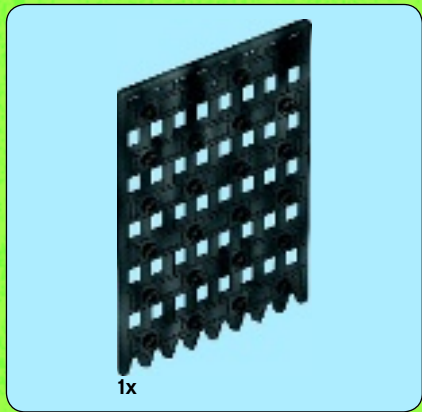

25

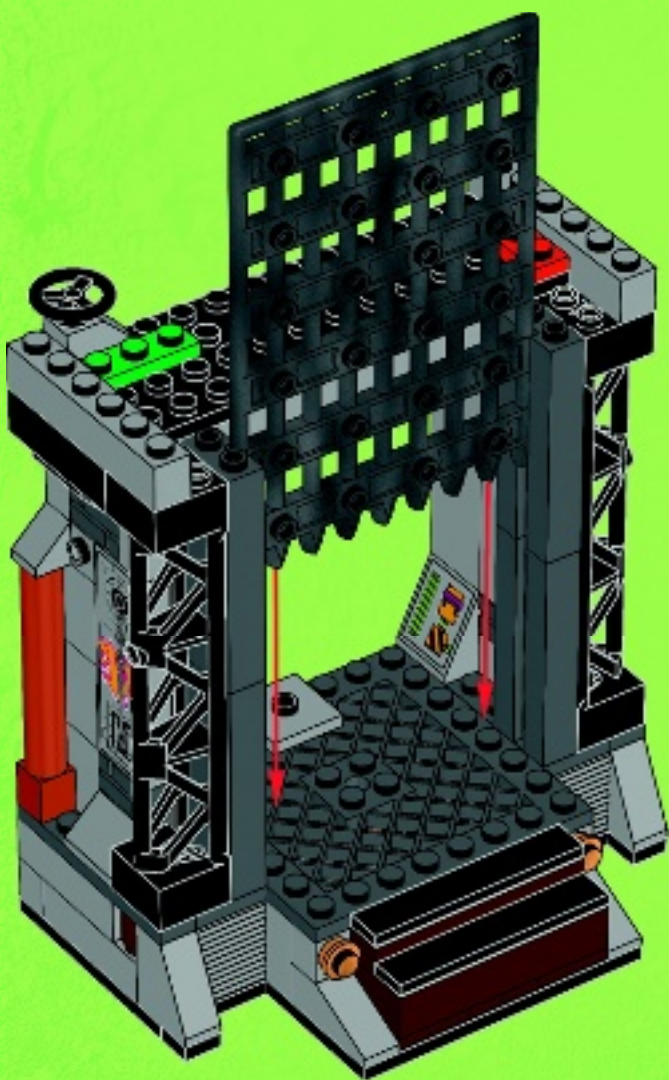

26

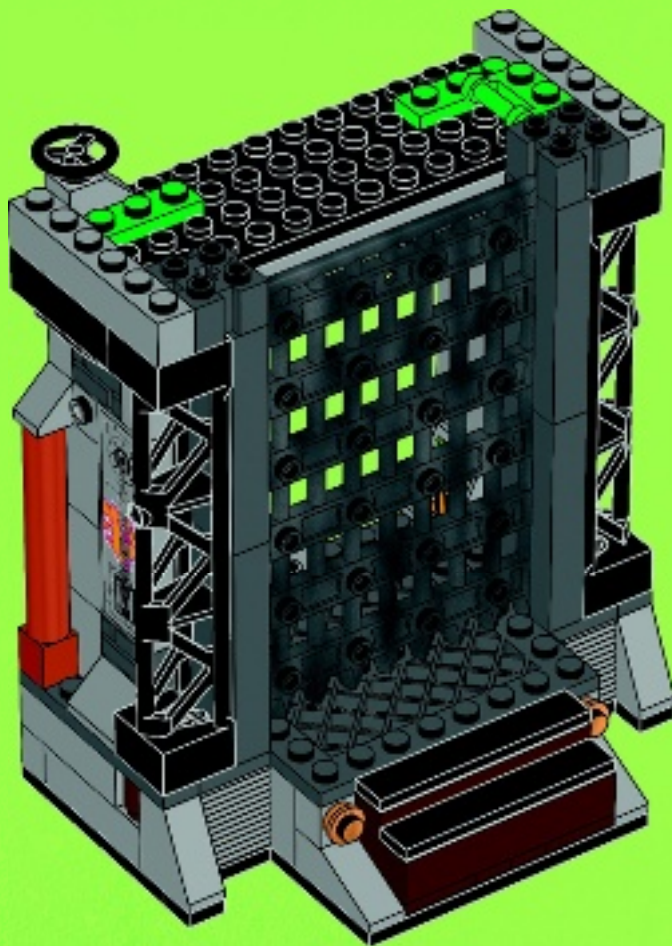



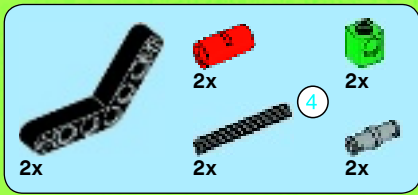

# 27

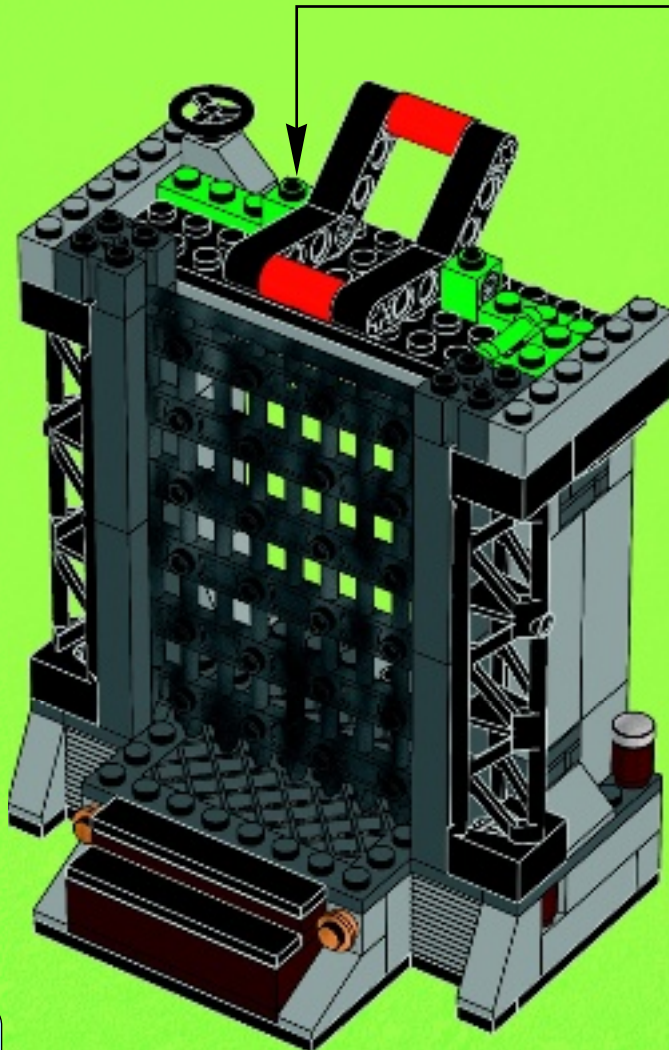
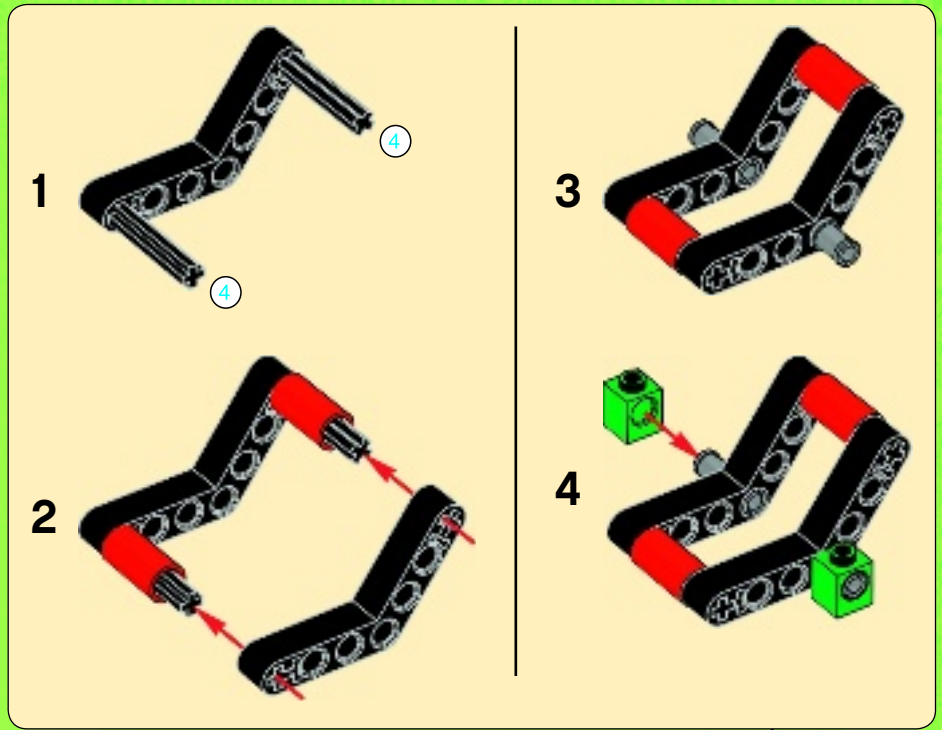



2x

2x

# 28

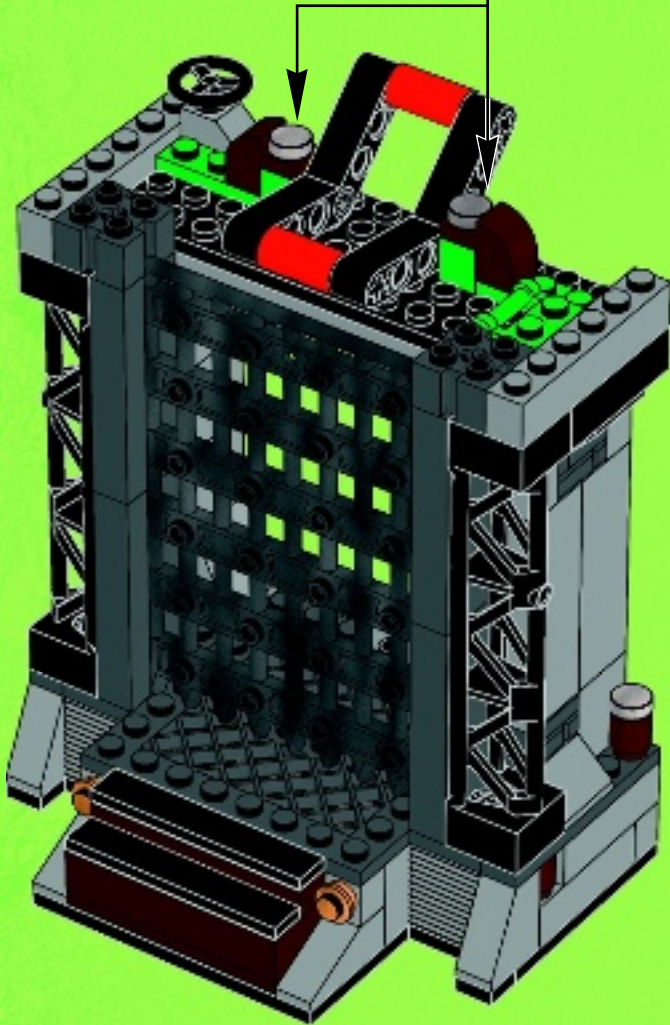

1x

2x

2x

# 29

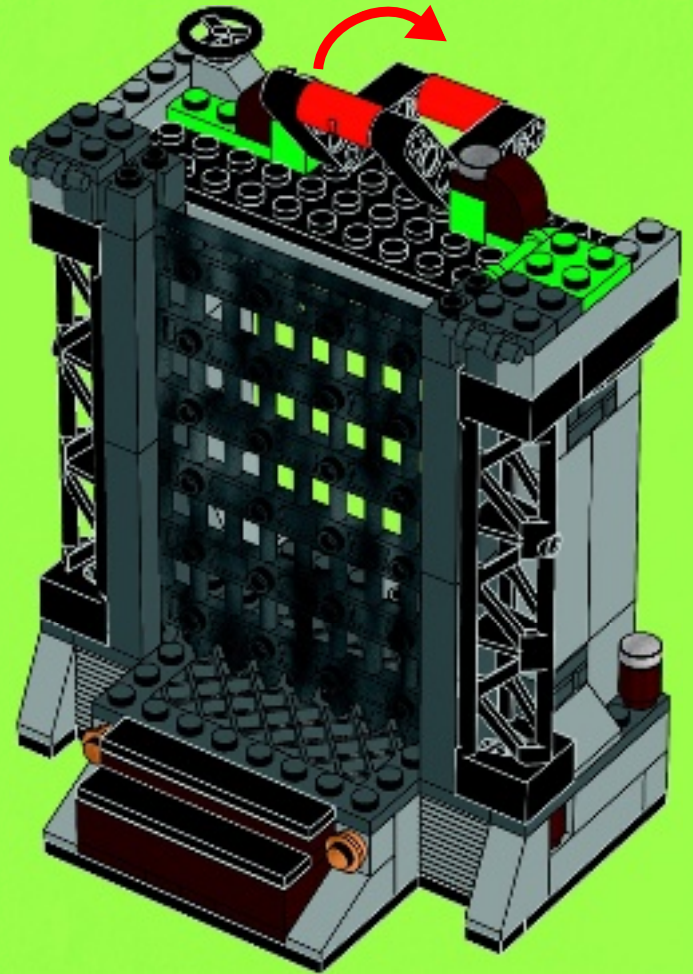





2x



2x

# 30

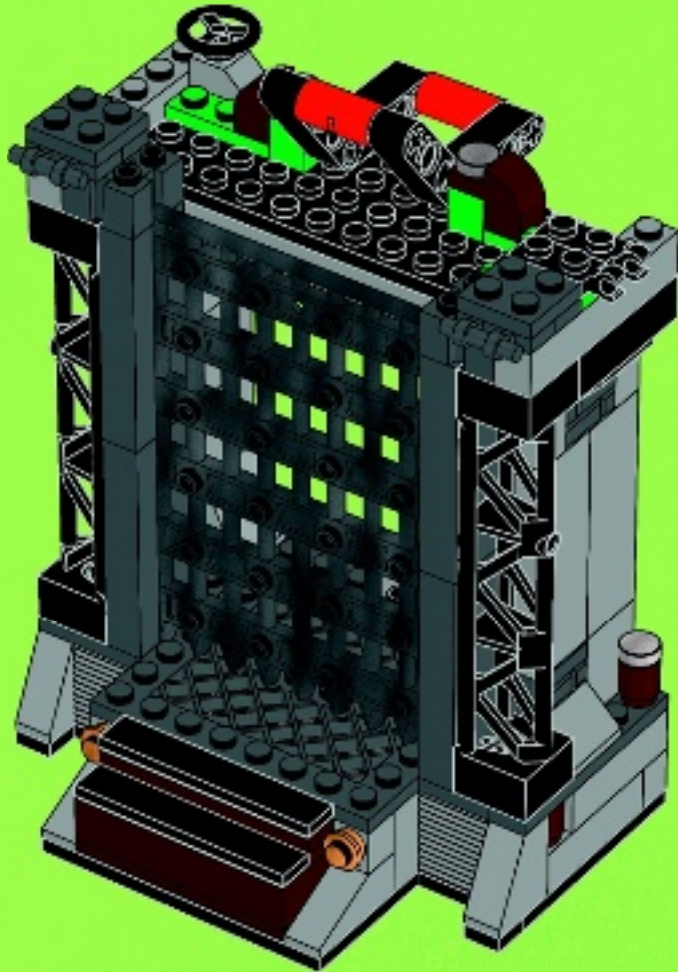

1x



2x



4x



2x

# 31

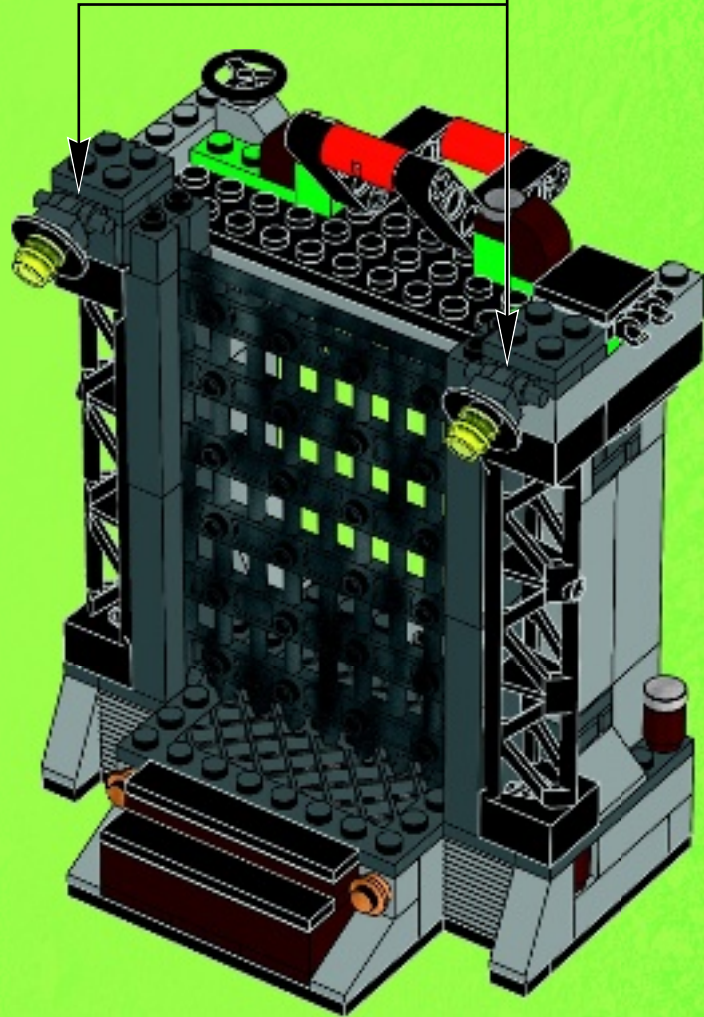
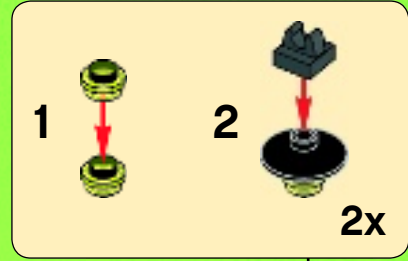





2x



2x

# 32

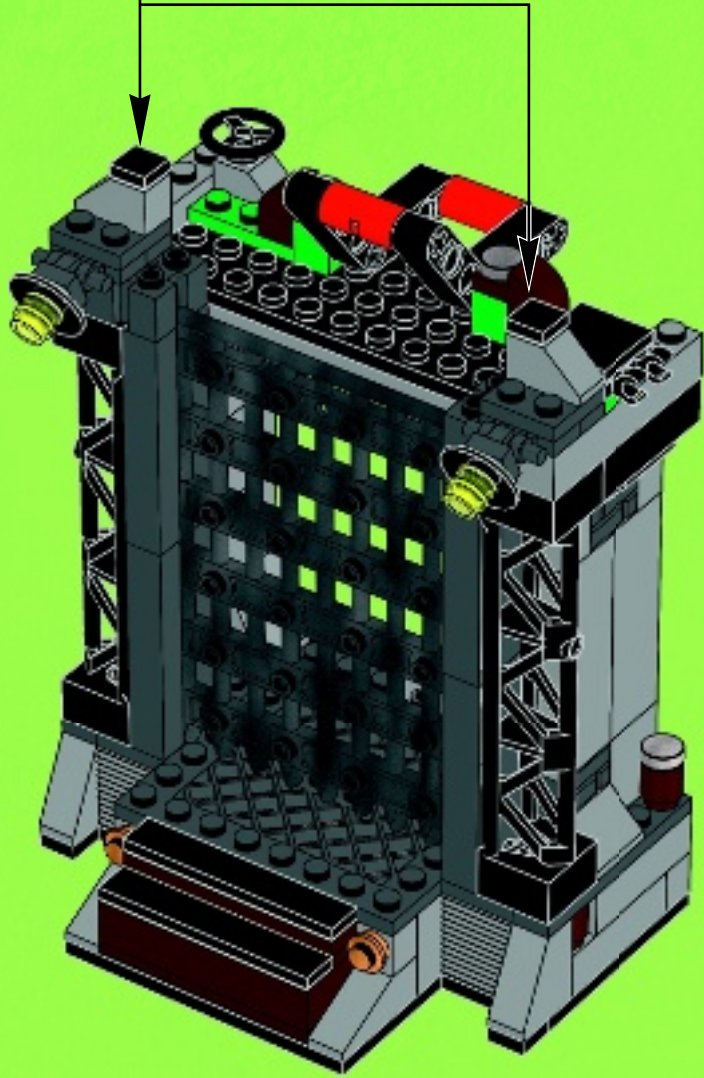
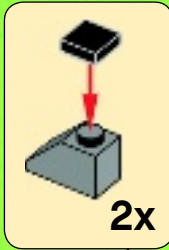



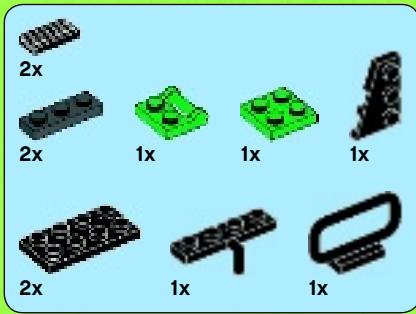

# 33

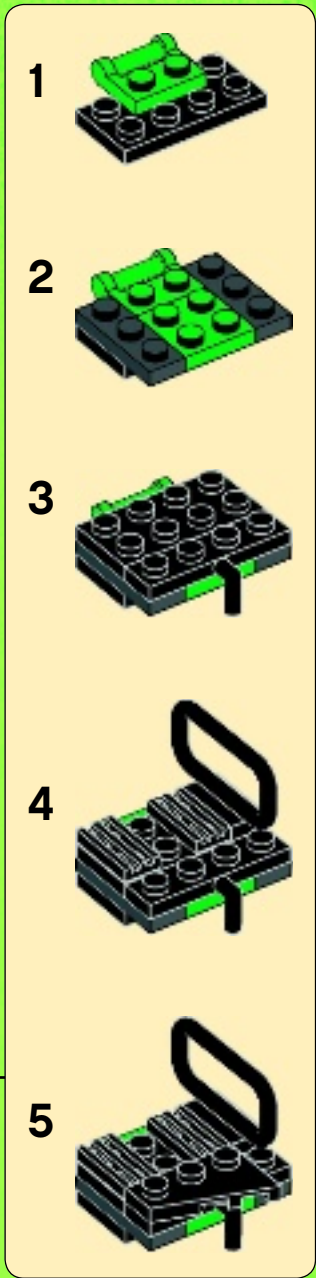
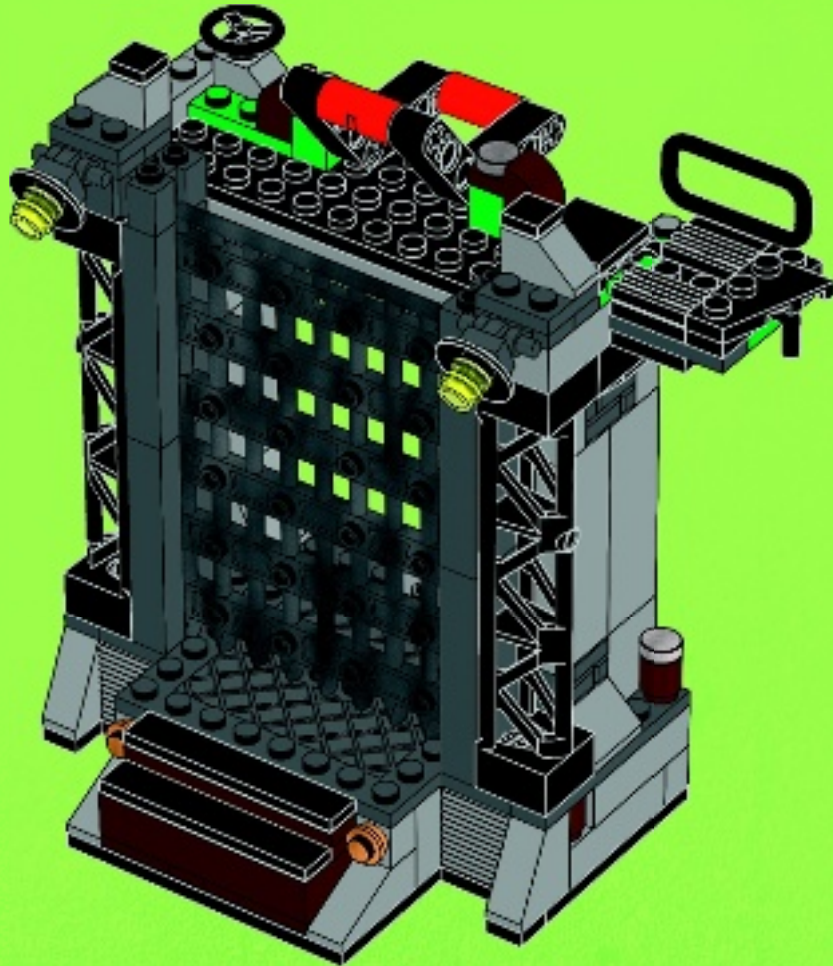



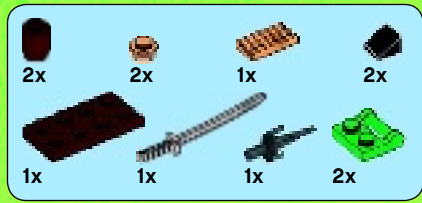

# 34

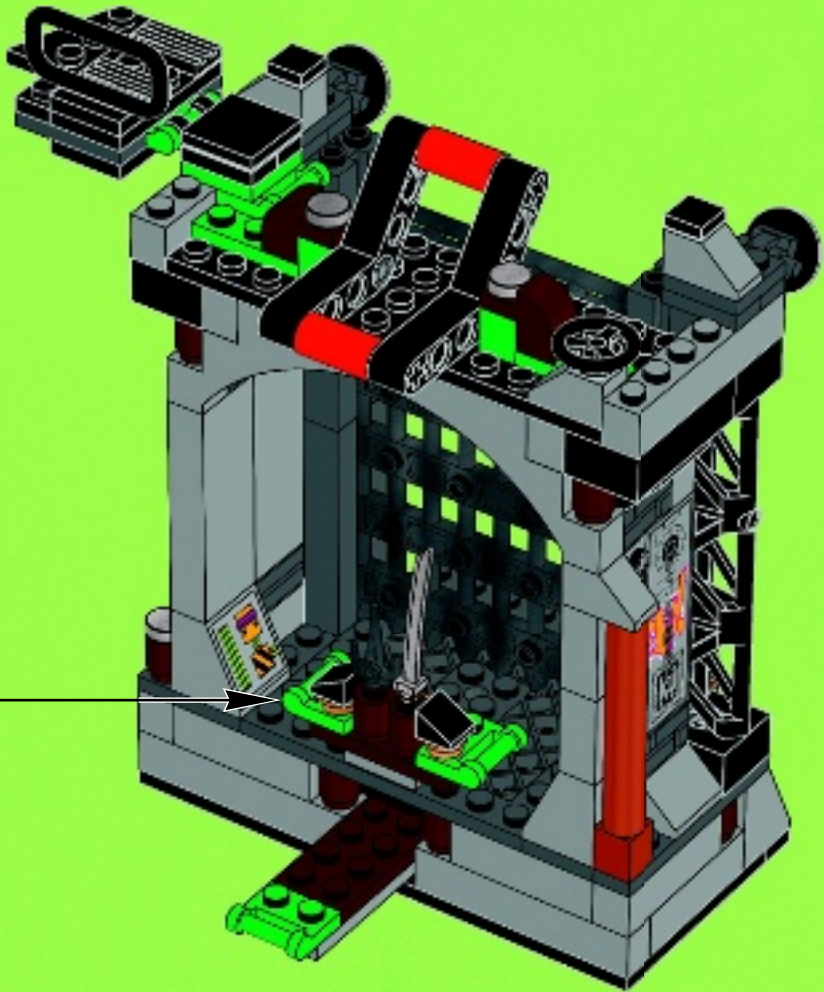
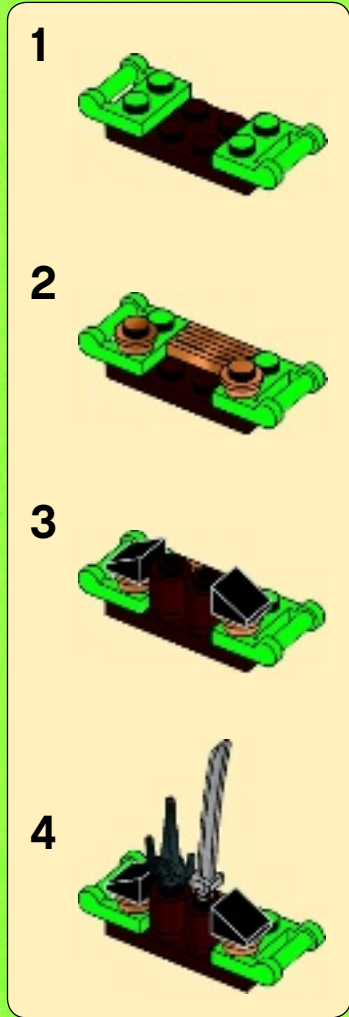







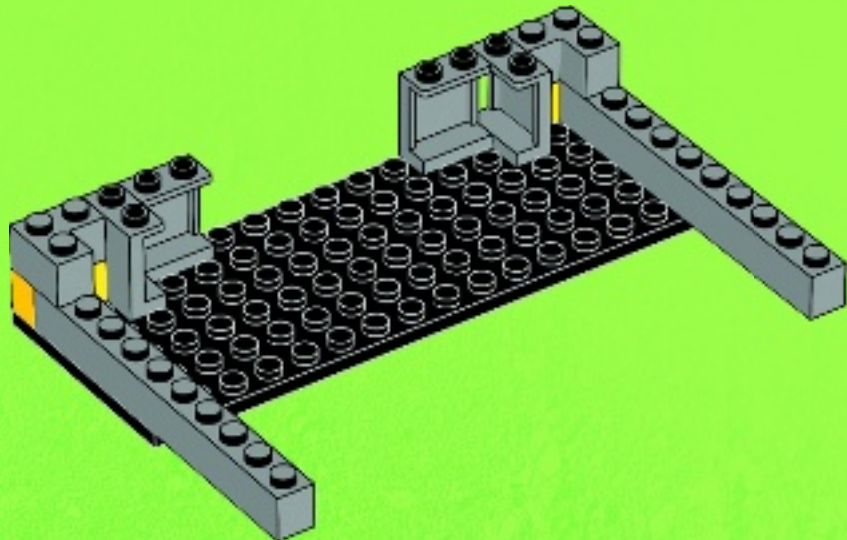
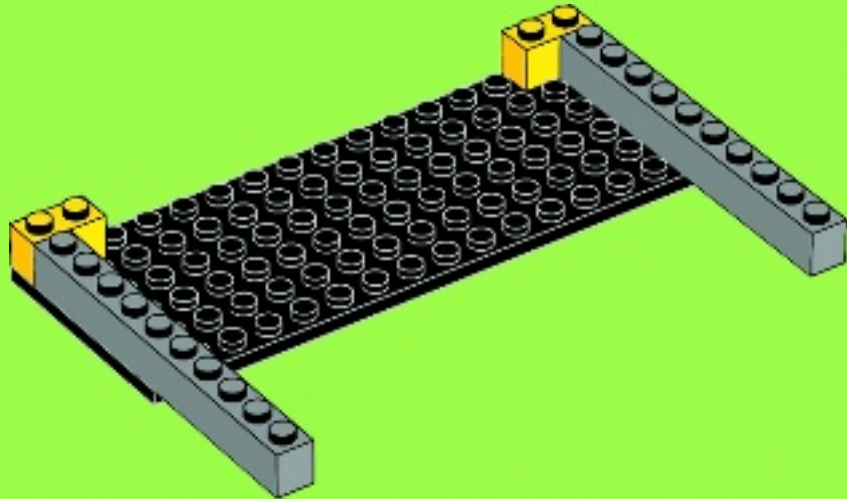
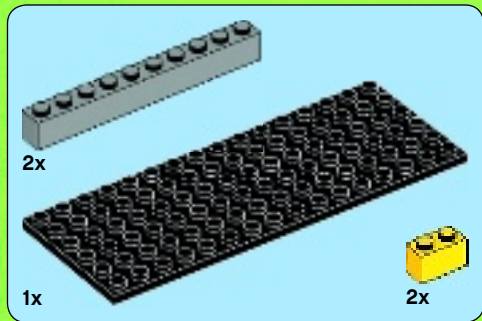
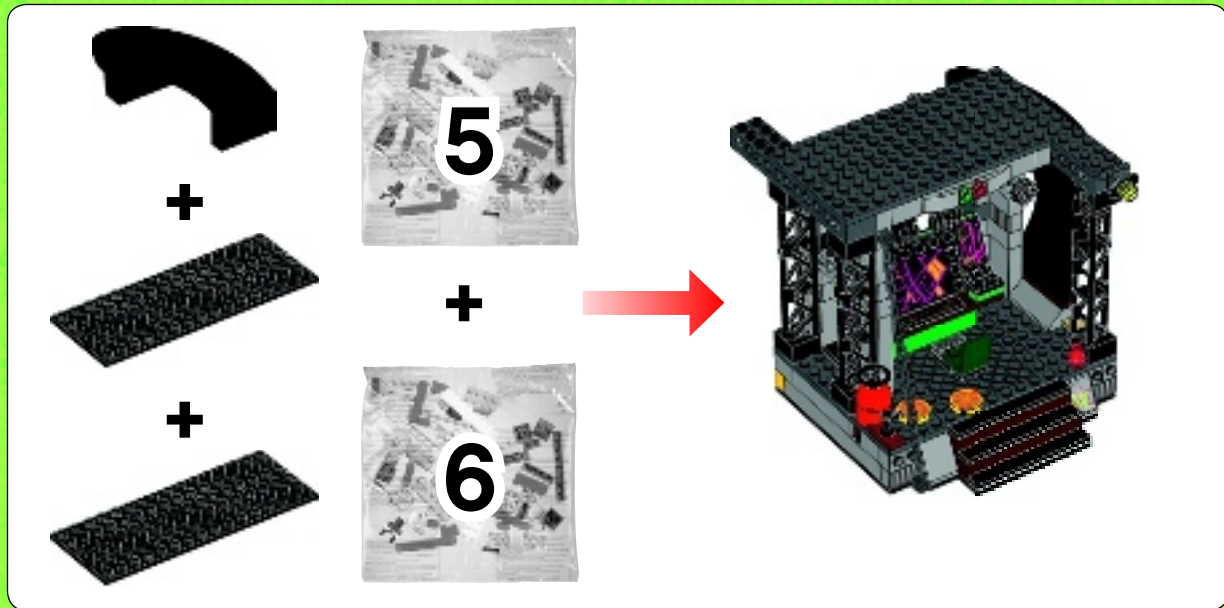



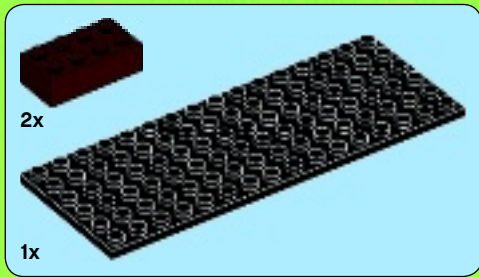

3

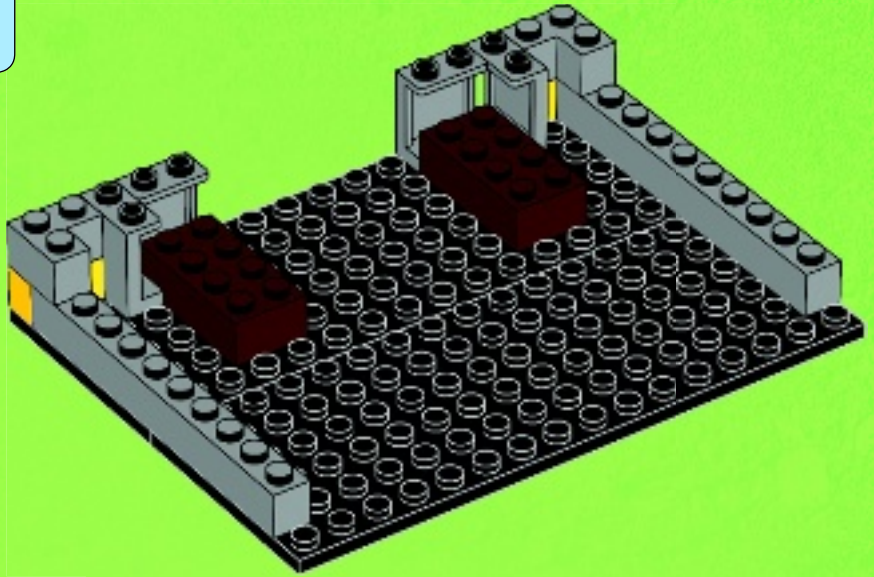

4

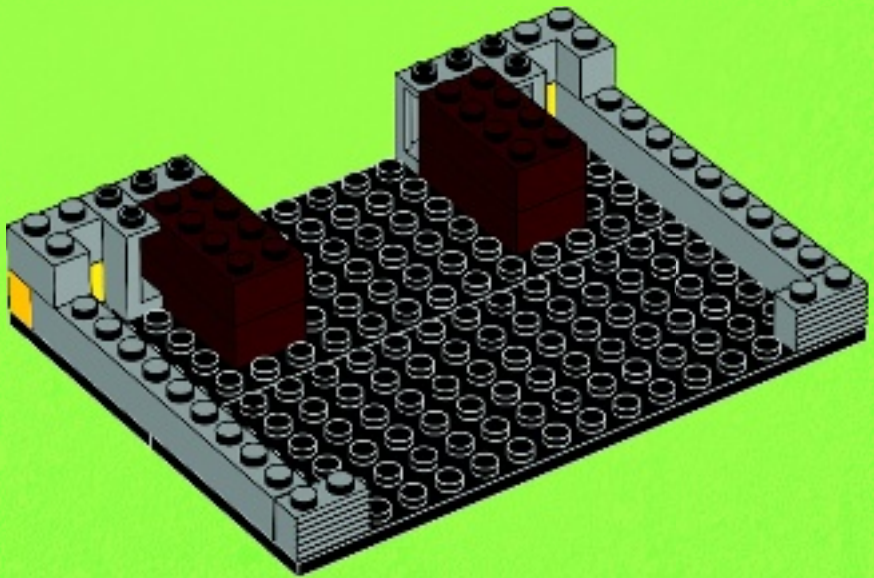





5

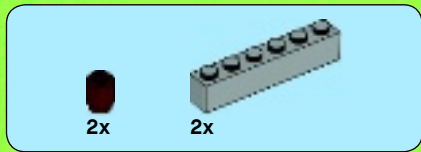
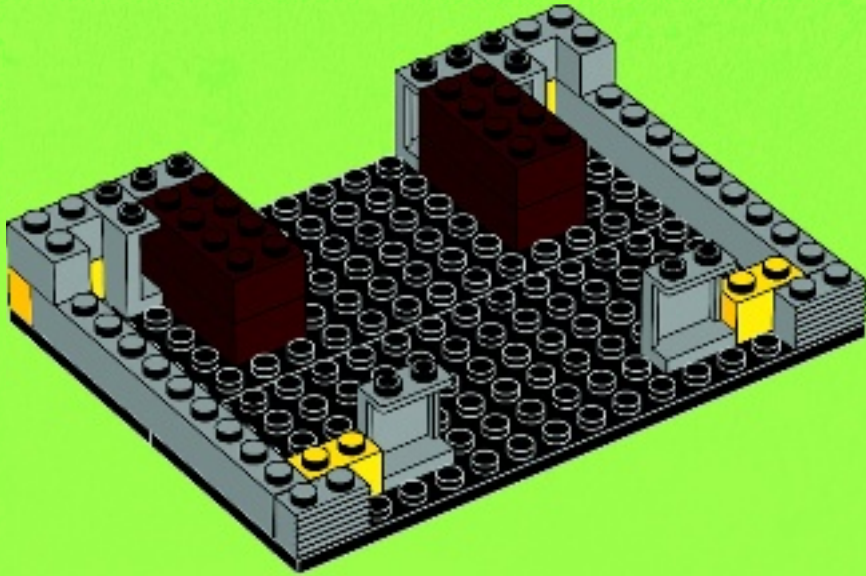

6

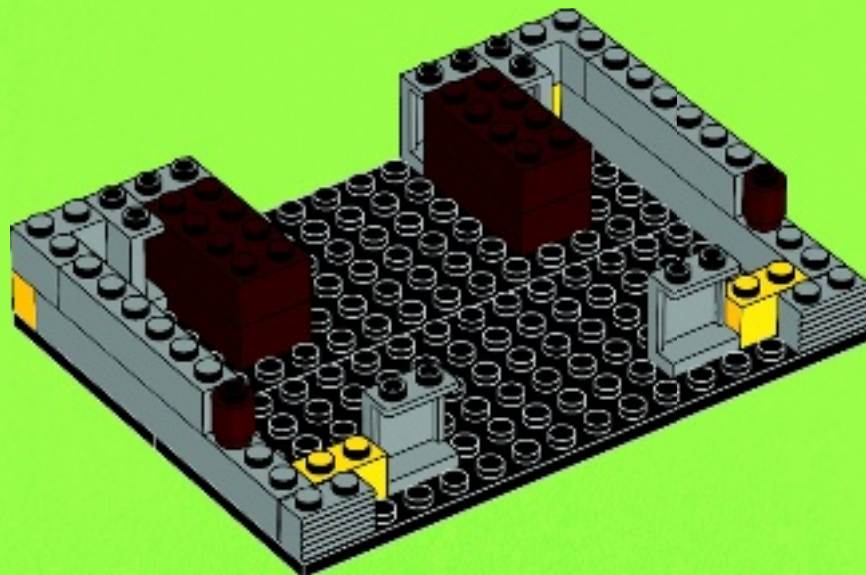





2x



4x

# 7

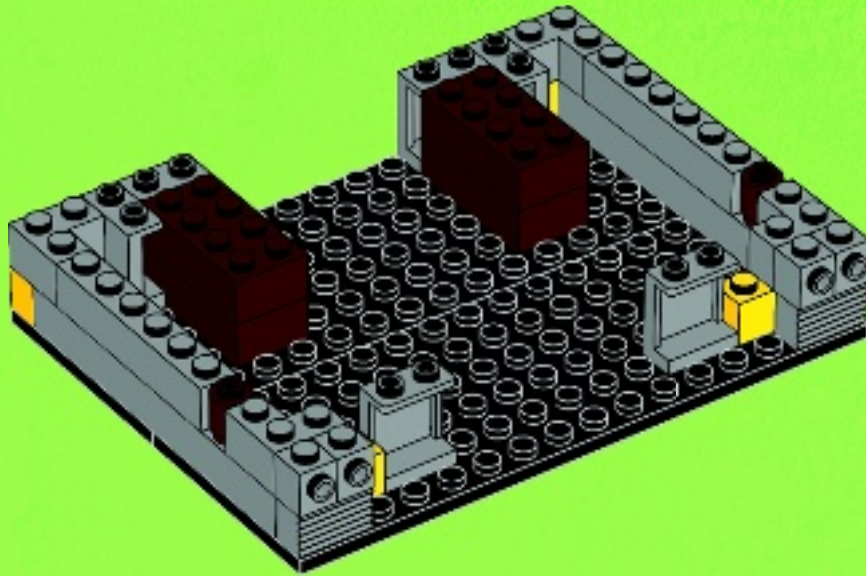

1x



2x

# 8

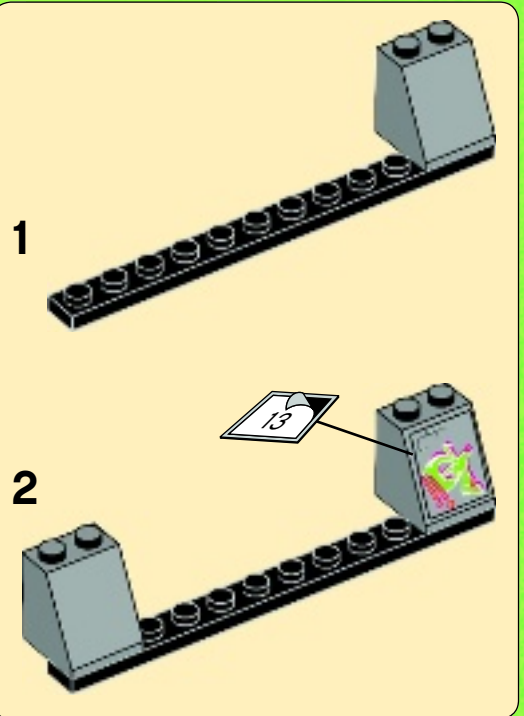
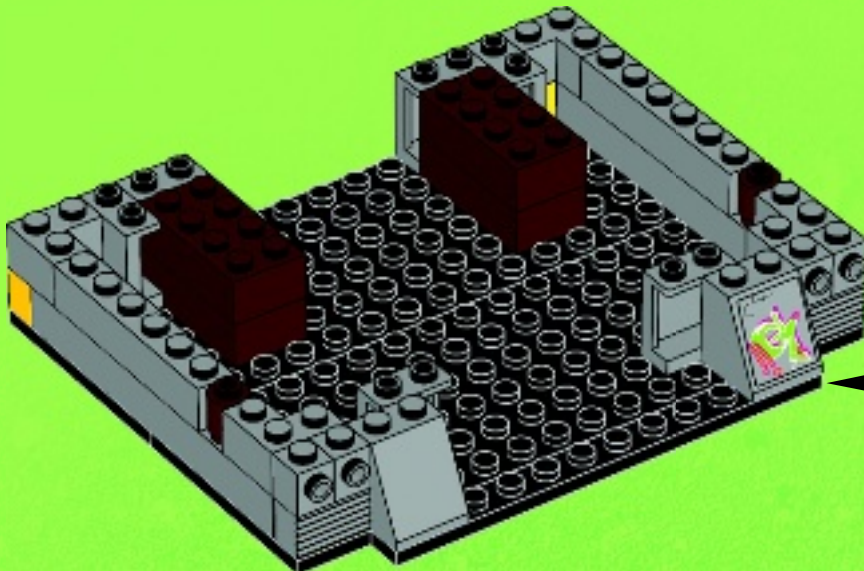



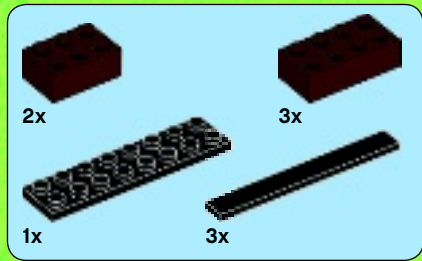

9

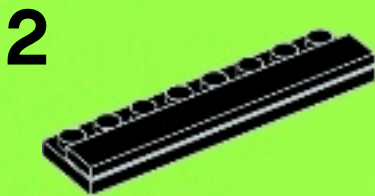

3

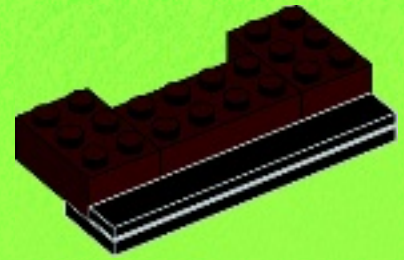

4

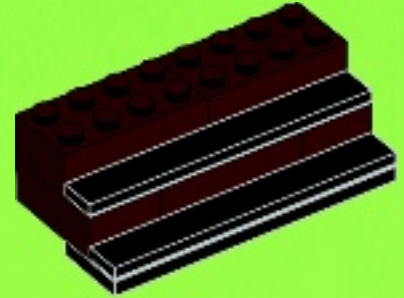

5

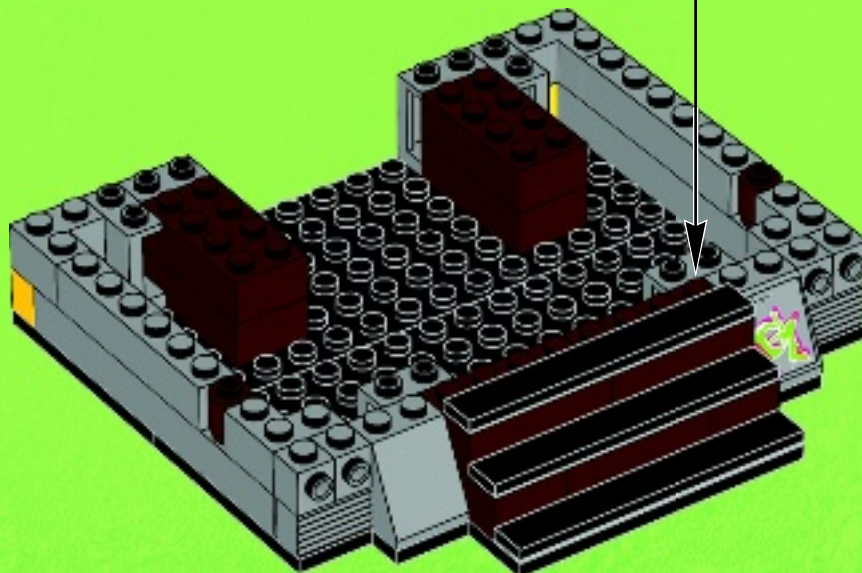
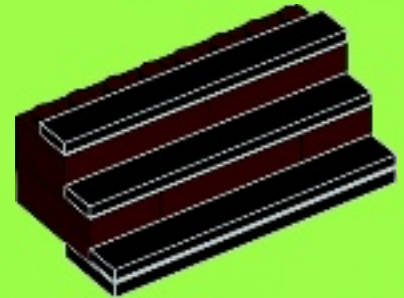



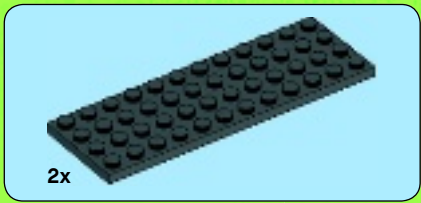

10

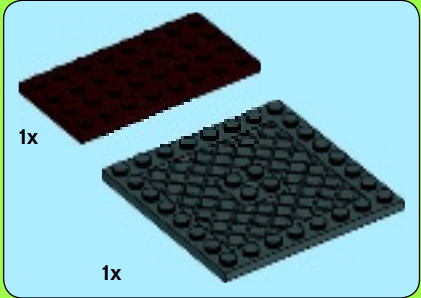
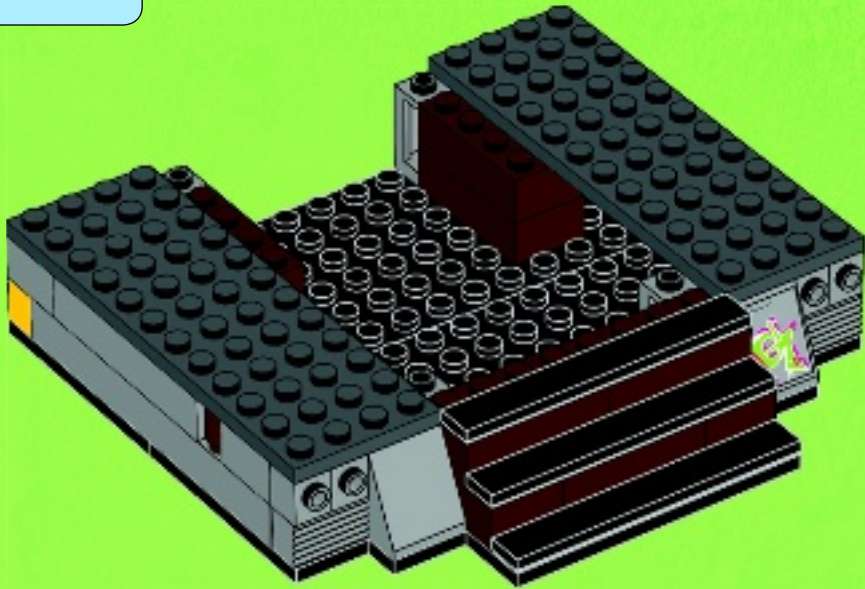

11

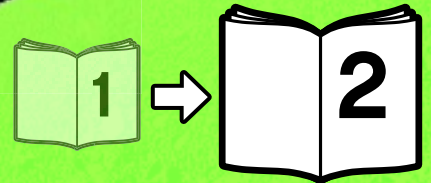
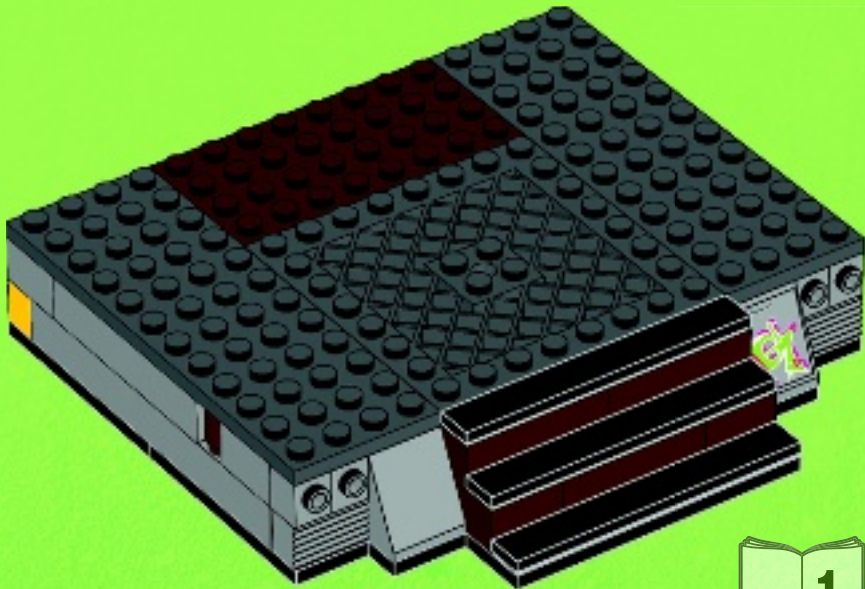





# WIN!

Go to [LEGO.com/productfeedback](http://LEGO.com/productfeedback) to fill out a survey for a chance to win a cool LEGO® Product.

No purchase necessary.

Open to all residents where not prohibited.



## LEGO.com/productfeedback

### GEWINNE!

Nimm an der Umfrage auf [LEGO.com/productfeedback](http://LEGO.com/productfeedback) teil und hab die Chance ein cooles LEGO® Produkt zu gewinnen!

Die Teilnahme am Gewinnspiel führt zu keinerlei Kaufverpflichtungen. Teilnahme in allen nicht ausgeschlossenen Ländern möglich.

### WIN!

Ga naar [LEGO.com/productfeedback](http://LEGO.com/productfeedback), vul een enquêteformulier in en maak kans op een cool LEGO® product.

Geen aankoopverplichting.  
Ledereen mag deelnemen, uitgezonderd ingezetenden van landen waar een enquêteverbod geldt.

### GAGNE!

Visite [LEGO.com/productfeedback](http://LEGO.com/productfeedback) pour répondre à un questionnaire et avoir une chance de gagner un produit LEGO® très cool!

Aucune obligation d'achat.  
Ouvert à tous les résidents des pays autorisés.

### 当てよう!

[LEGO.com/productfeedback](http://LEGO.com/productfeedback)にアクセスして、アンケートにご記入ください。当選者にはレゴ®製品を差し上げます。

お買い上げの必要はありません。  
禁止されていない限り、すべての皆様にご利用いただけます。



[LEGO.com](http://LEGO.com)



**LEGO**

# NINJA TURTLES



79117







12

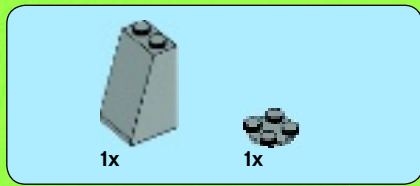
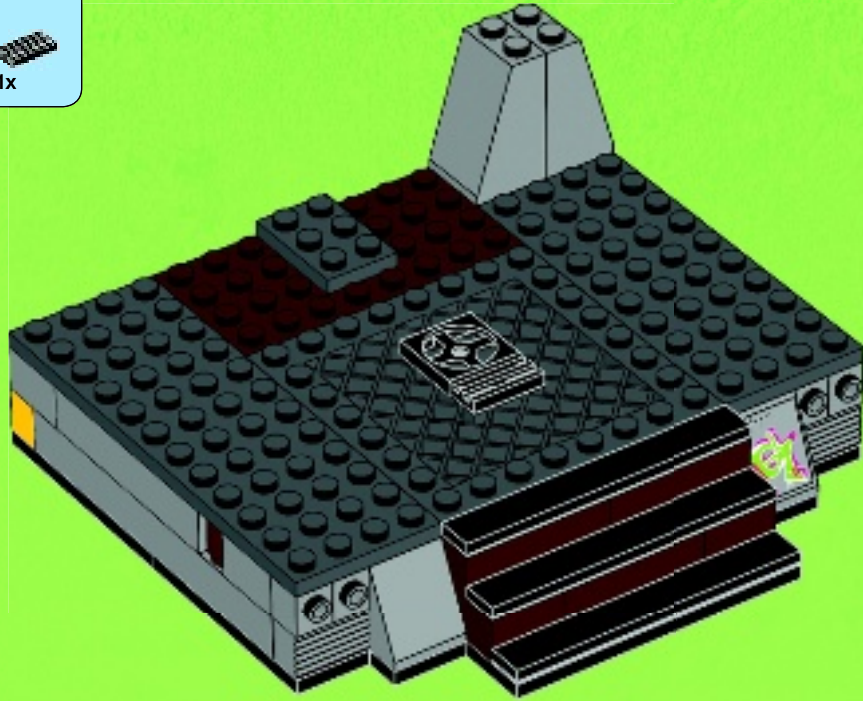

13

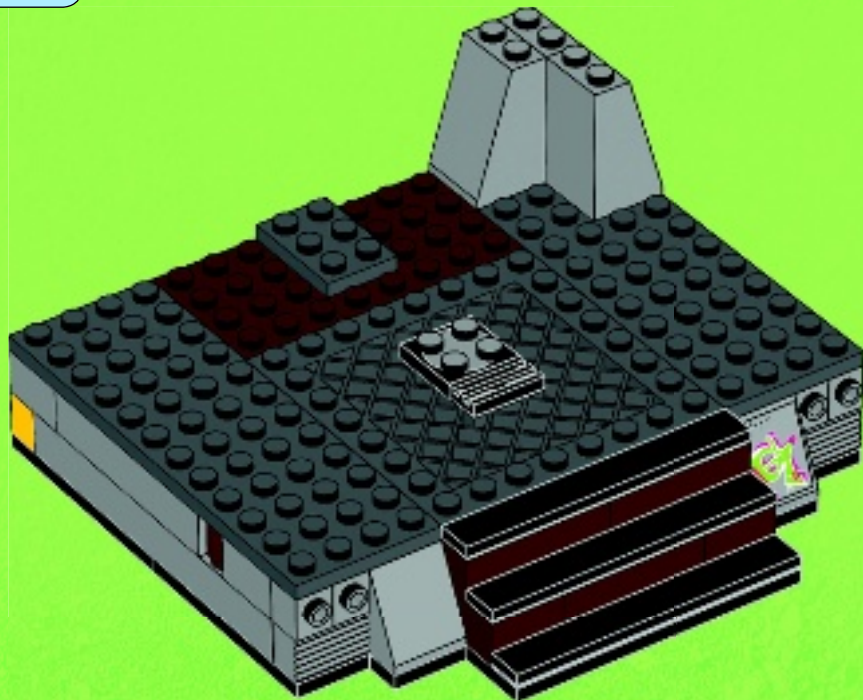



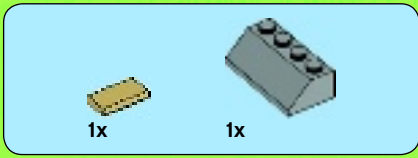

14

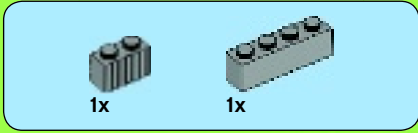
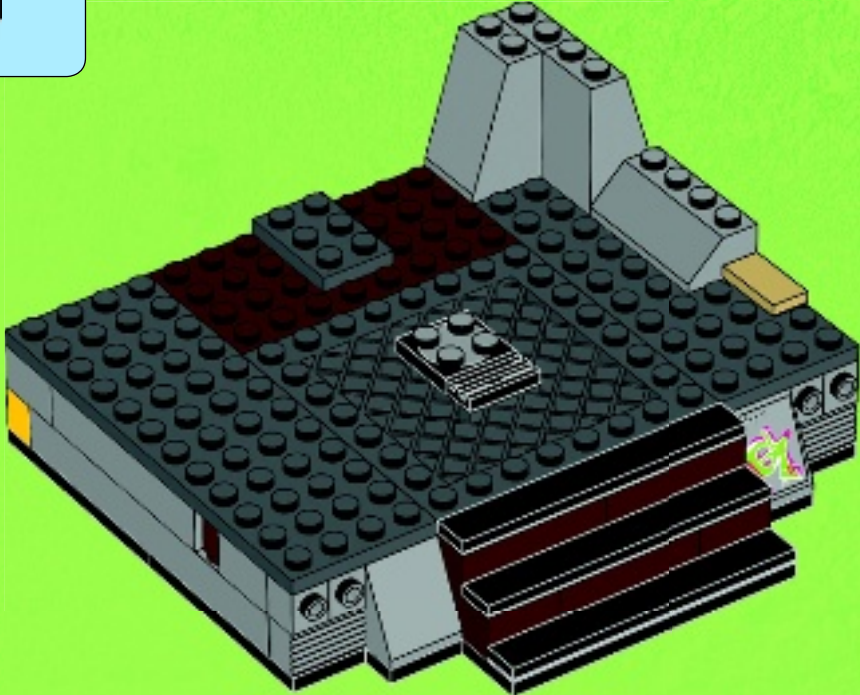

15

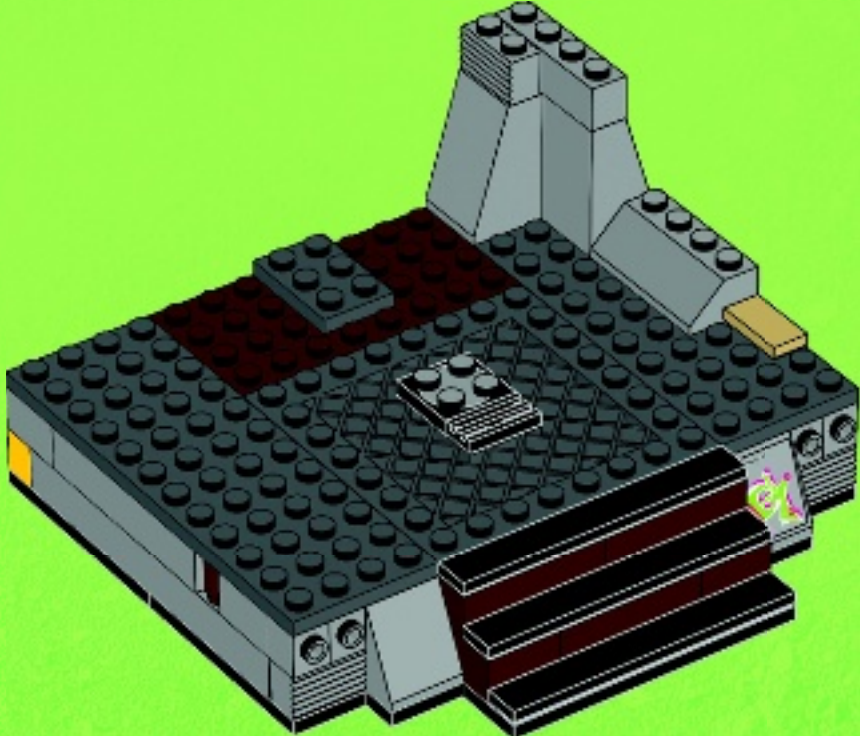







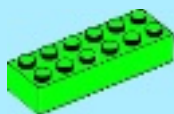

1x

# 18

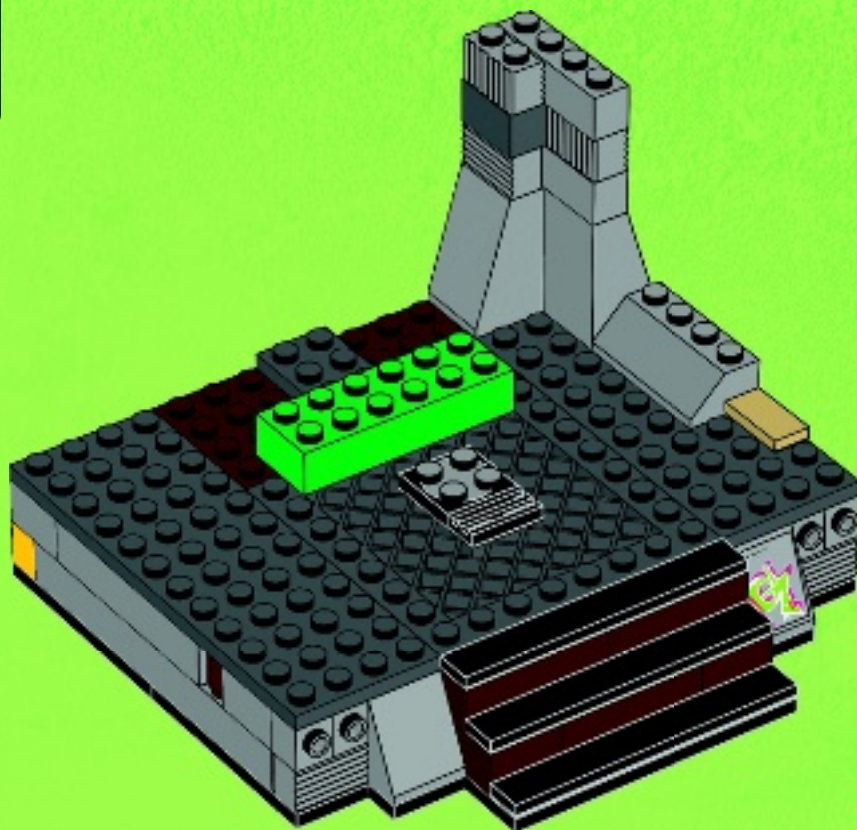

1x



1x

# 19

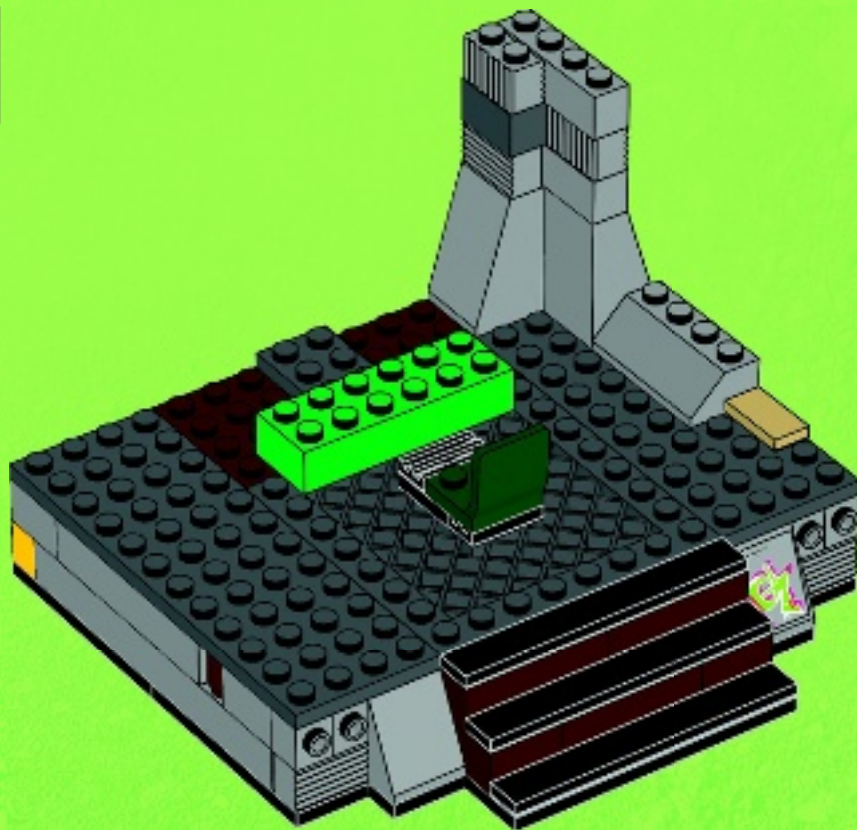



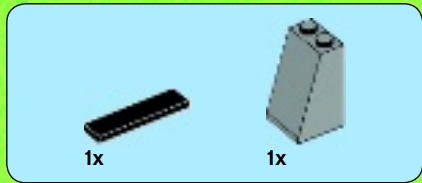

# 20

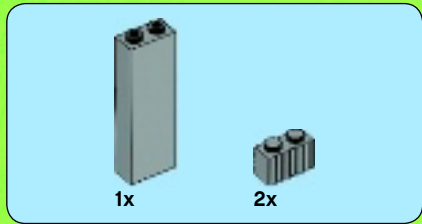
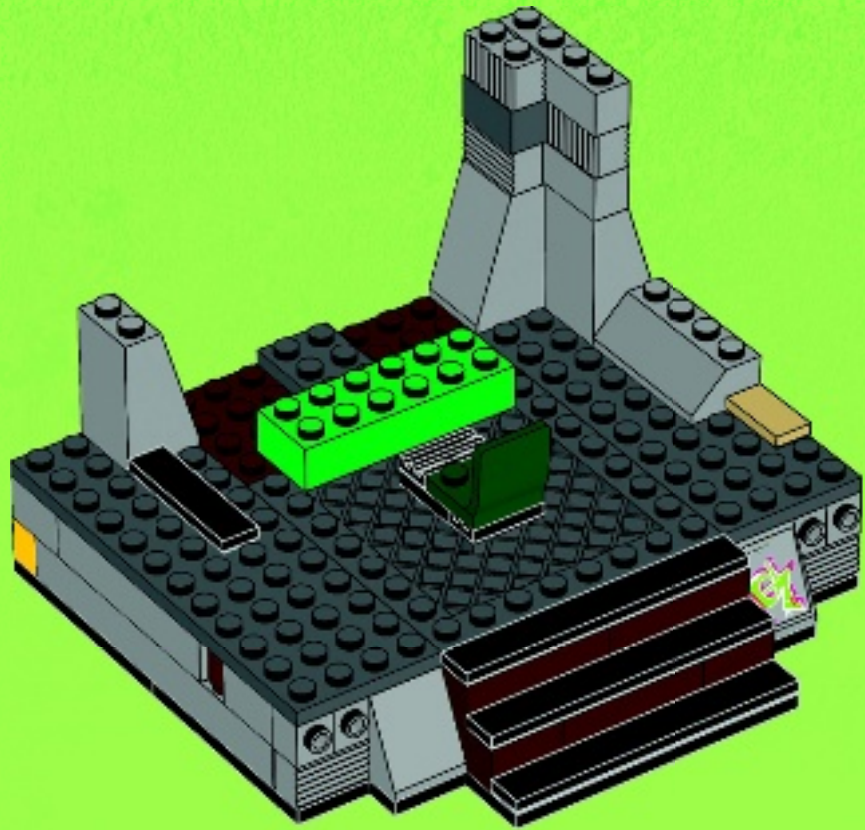

# 21

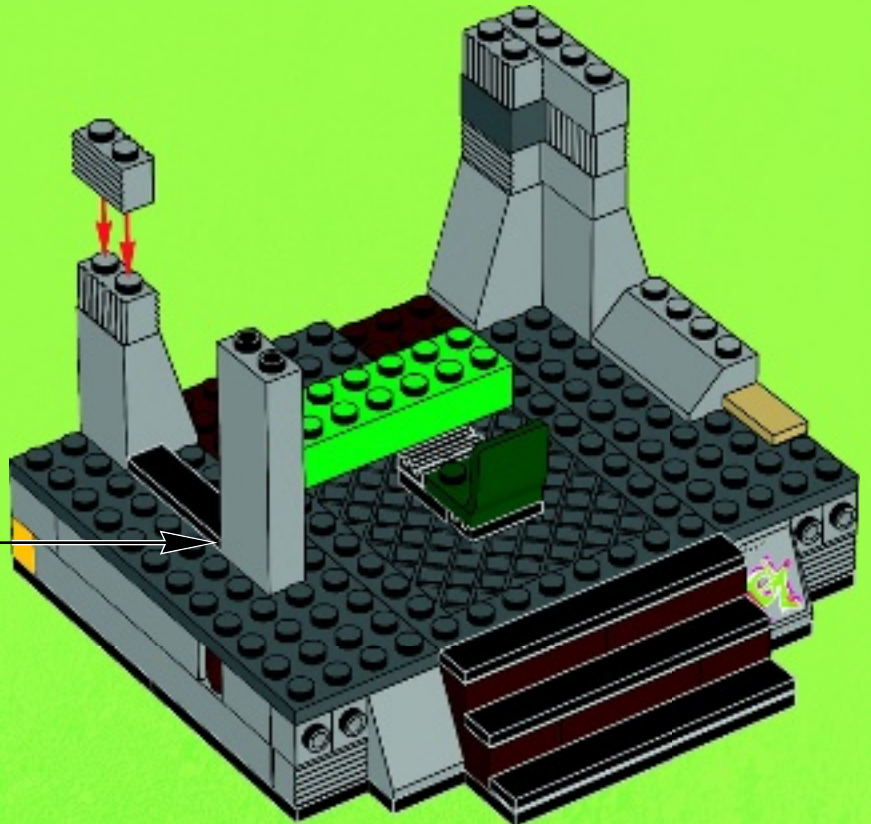
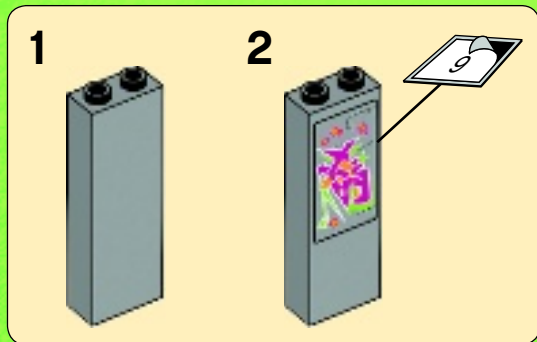





2x

# 22

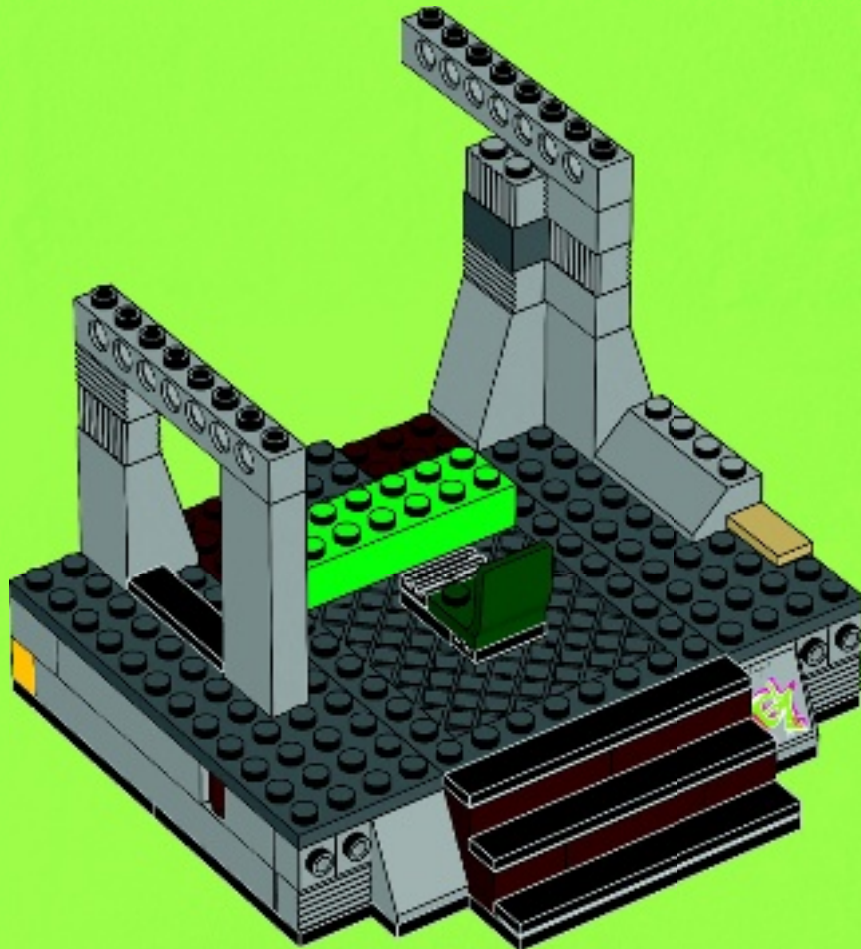



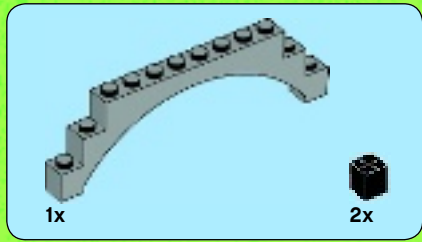

23

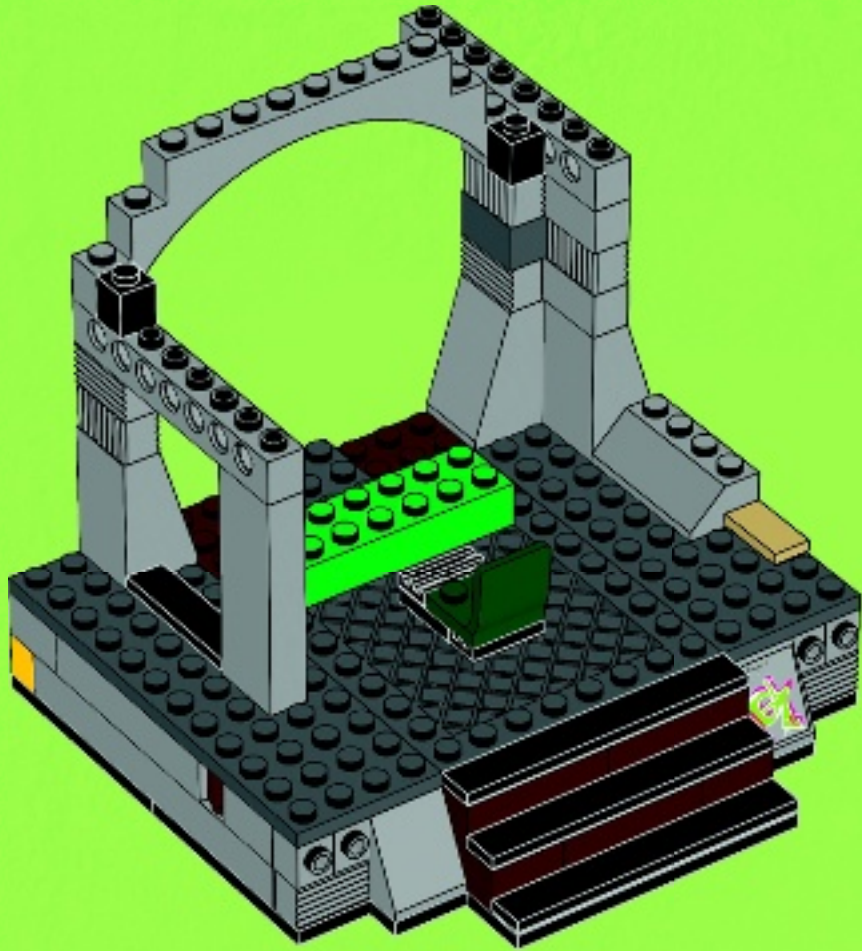





1x



2x

# 24

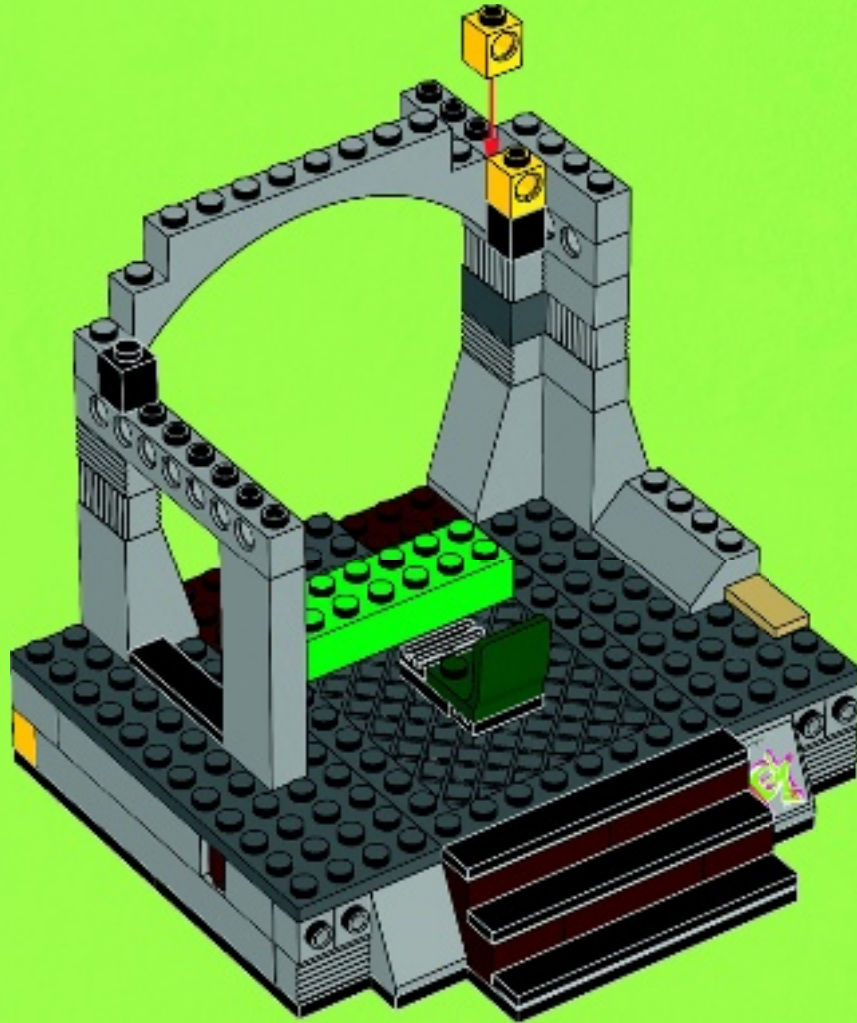





1x



1x



3x

# 25

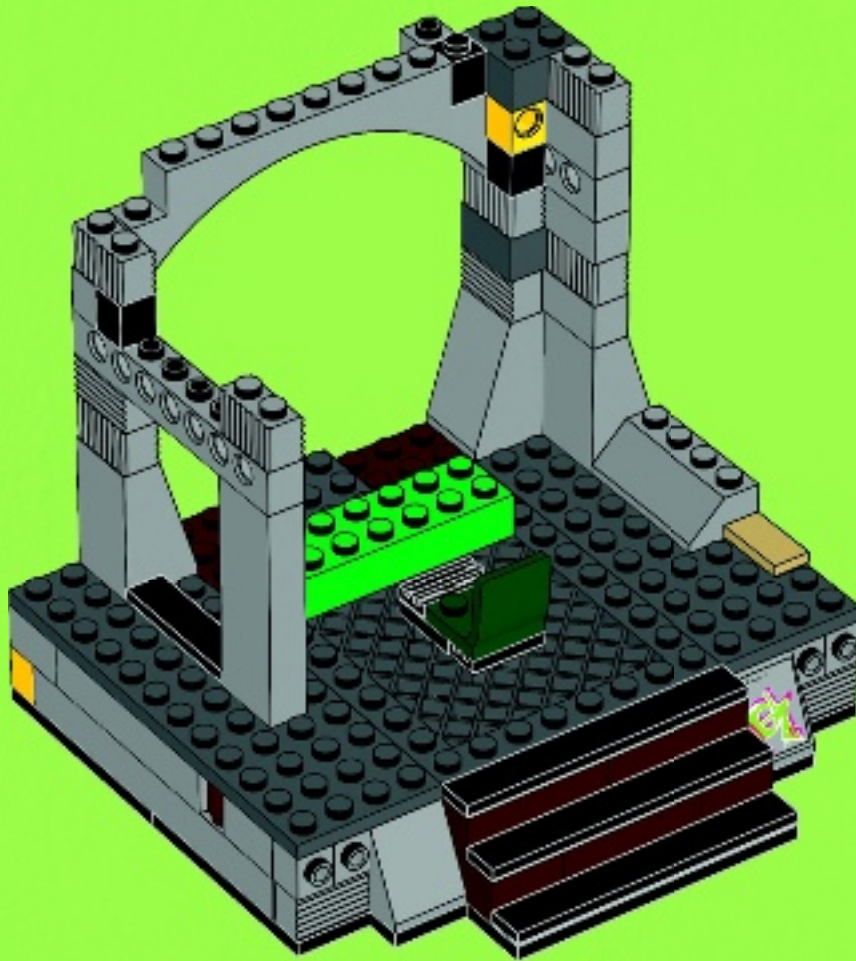



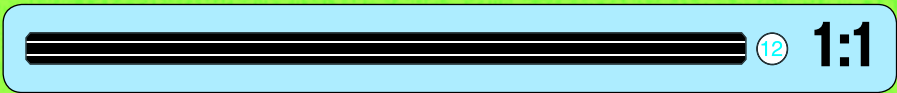
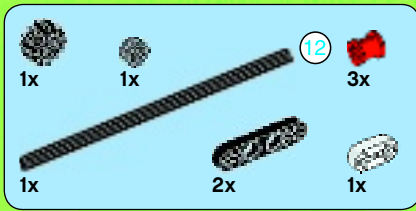

# 26

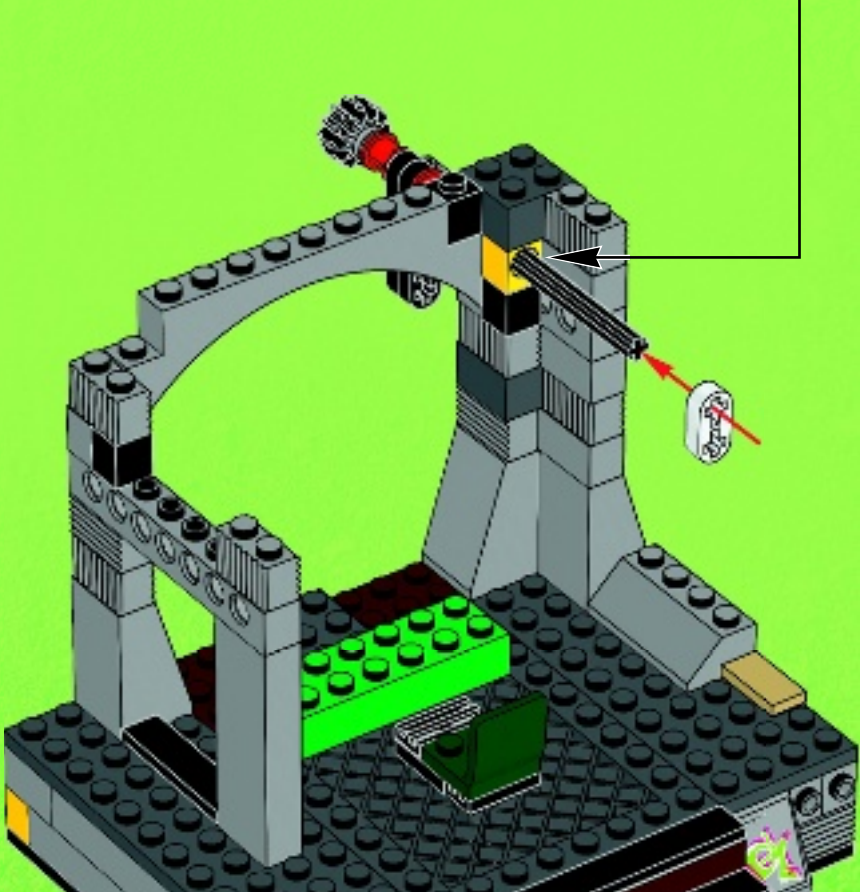
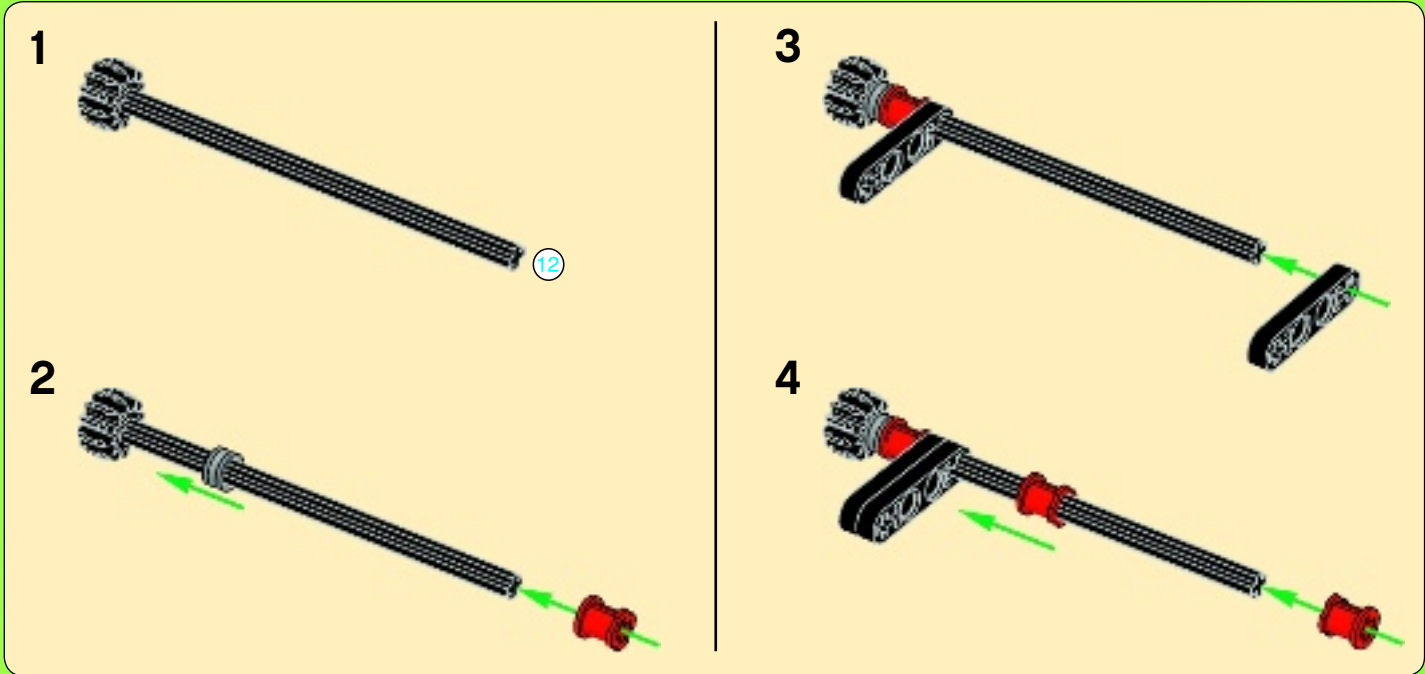







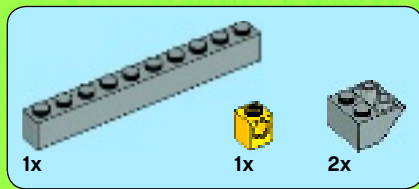

28

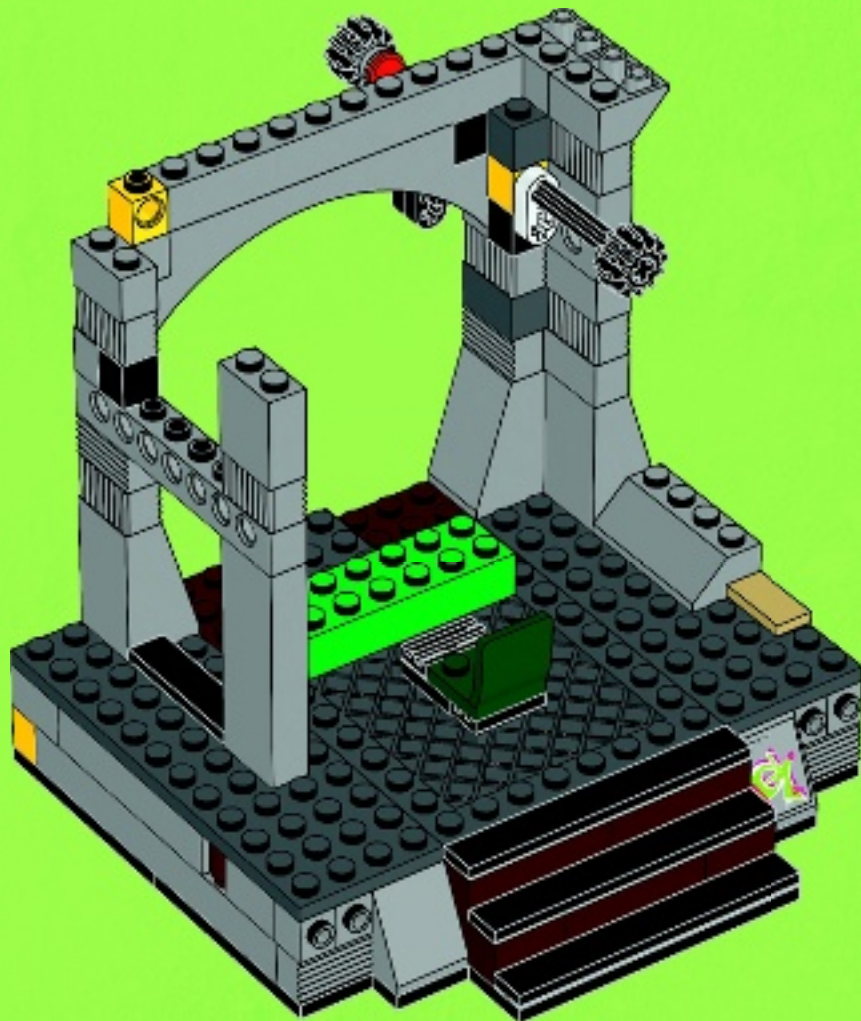







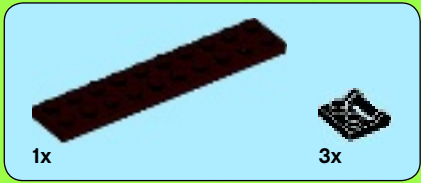

1

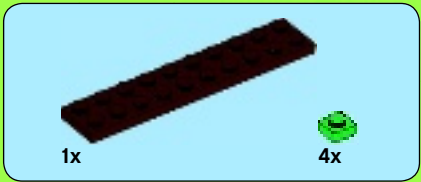
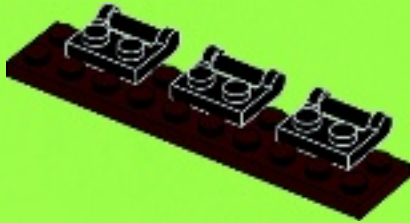

2

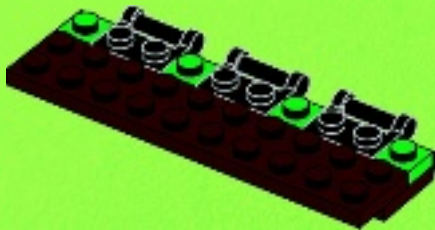

3

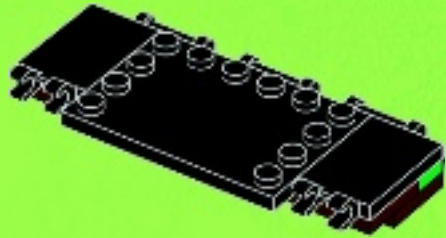

4

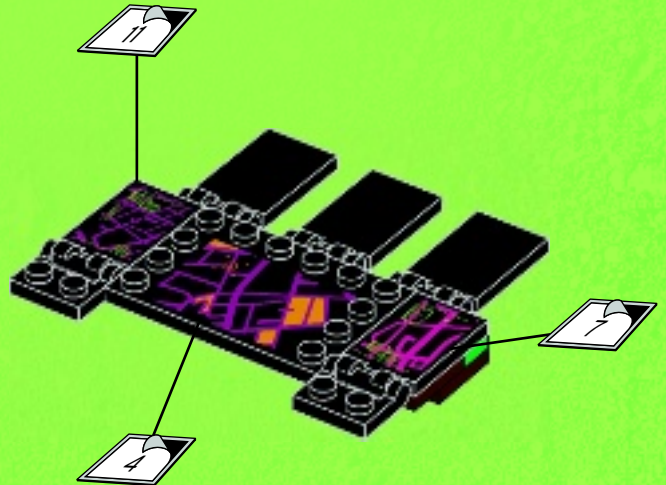



# 5

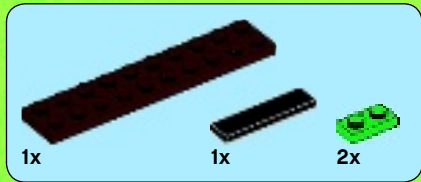
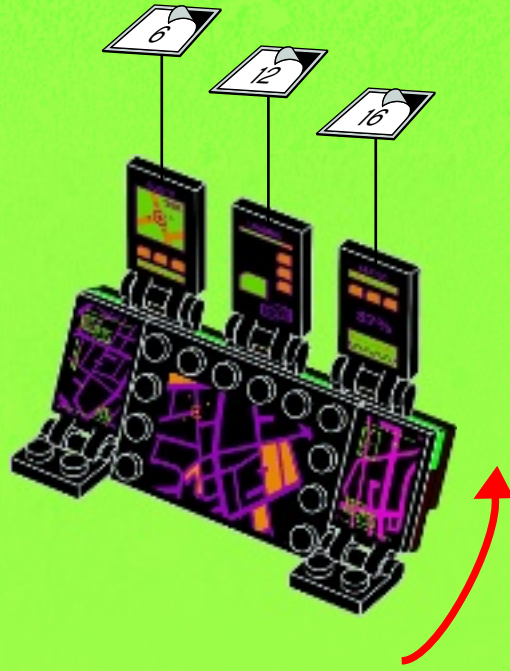

# 6

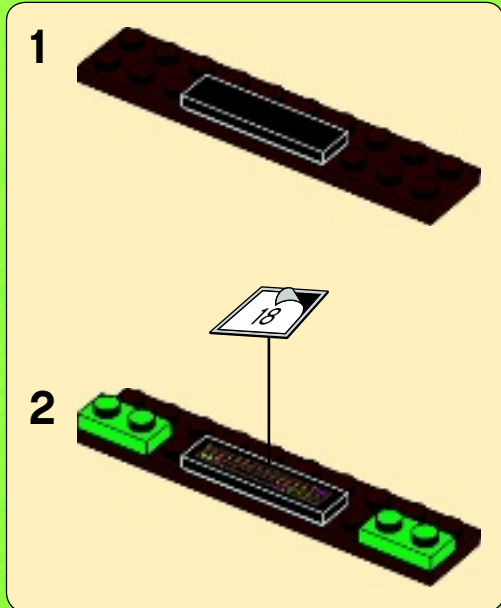



30

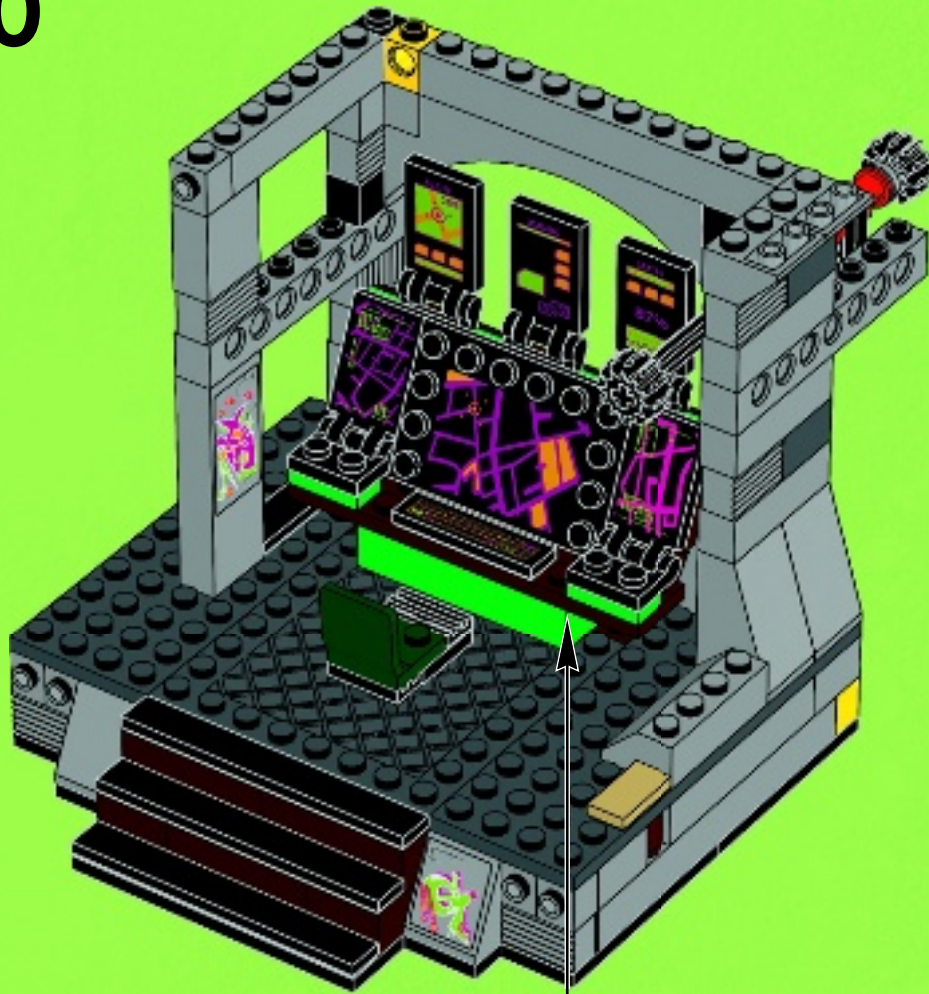



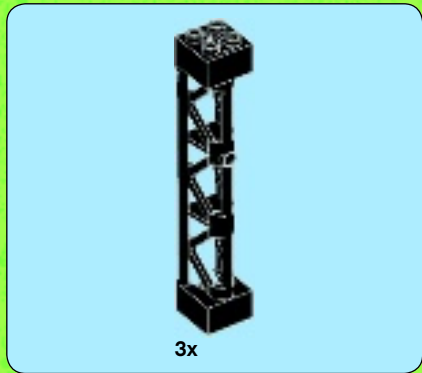

# 31

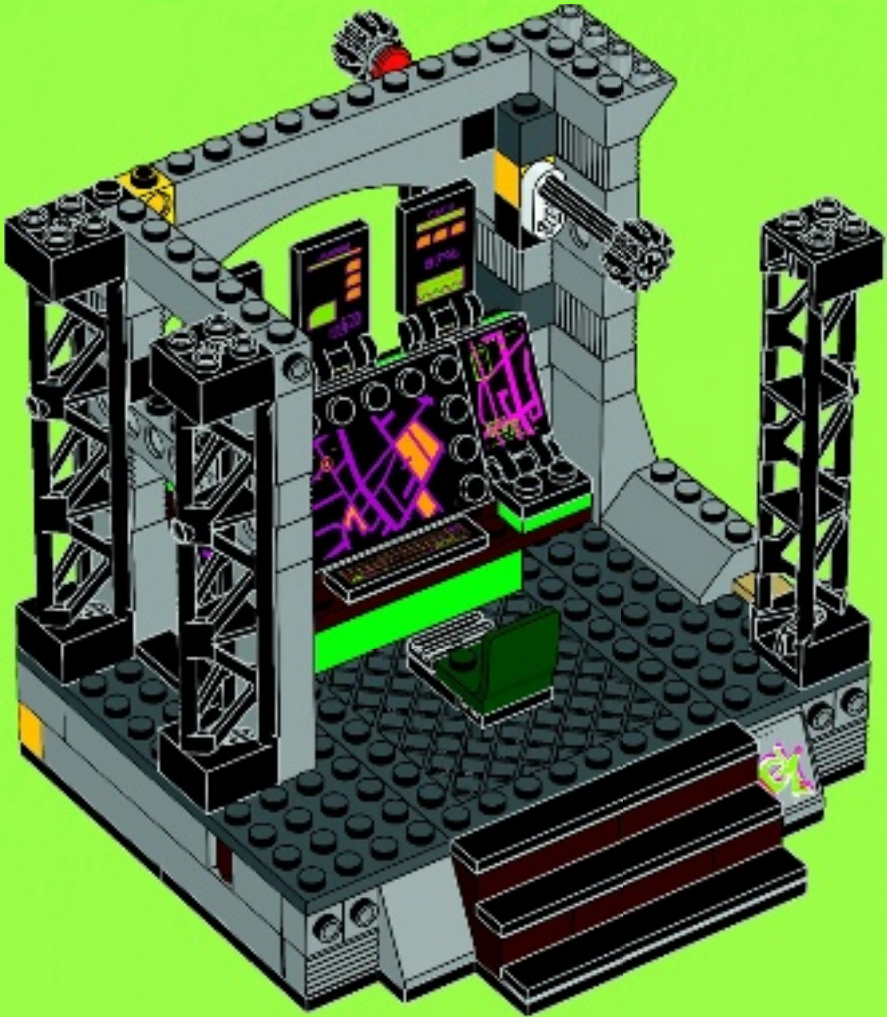



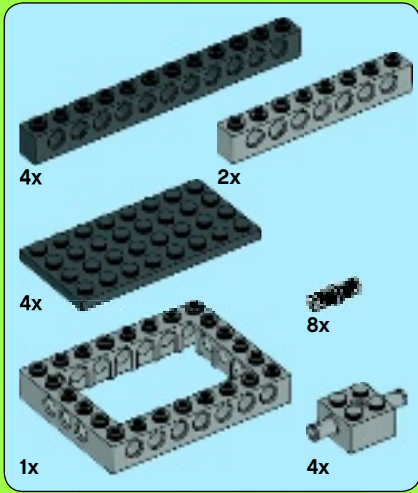
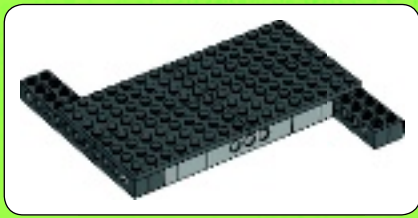

32

1

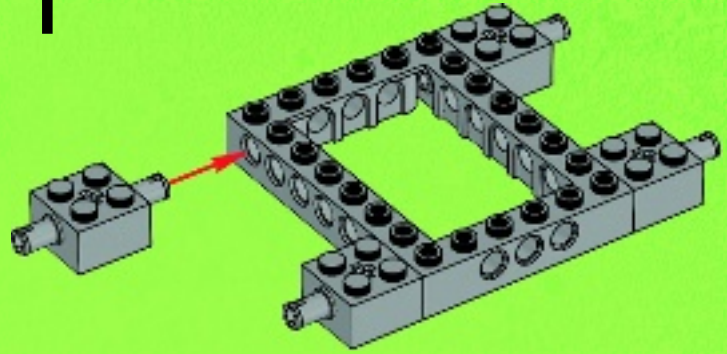

2

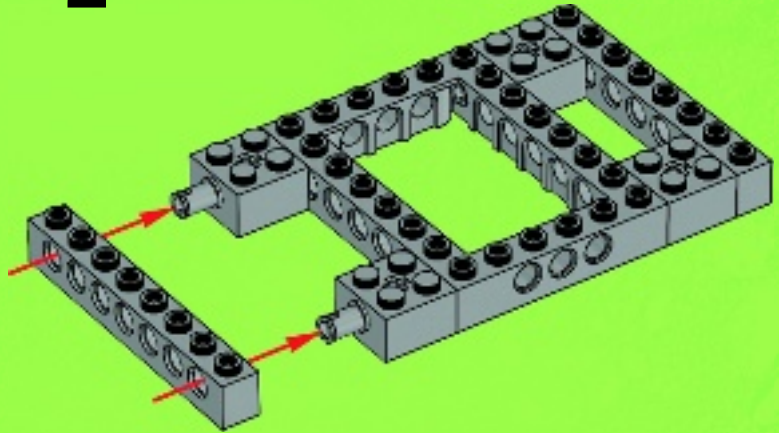

3

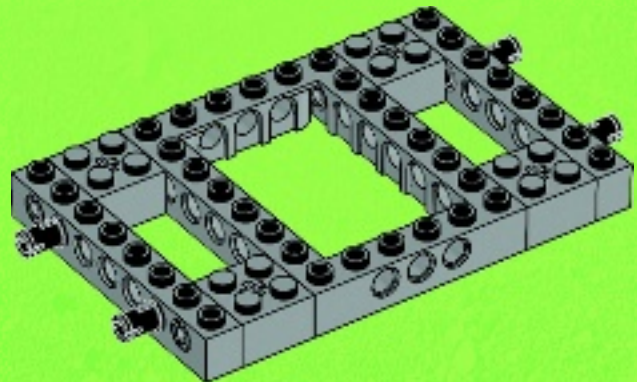



1

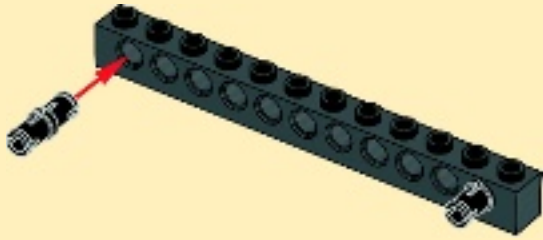

2

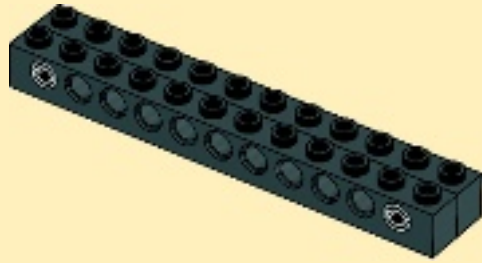

2x

4

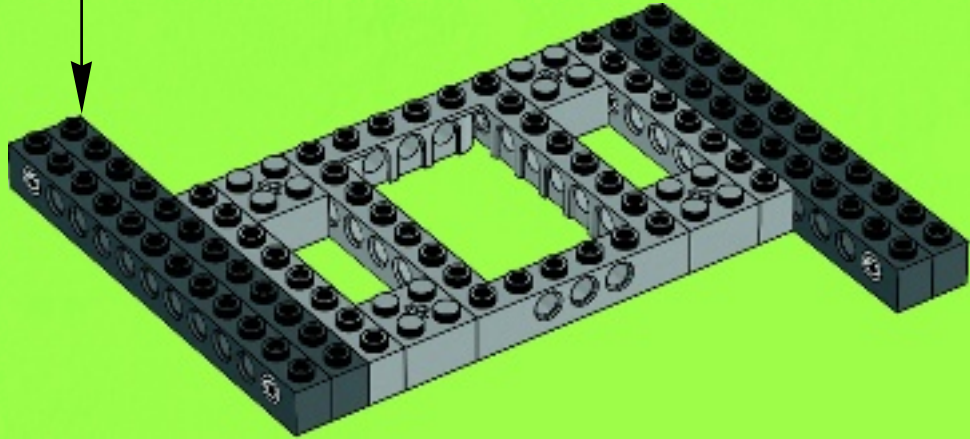

5

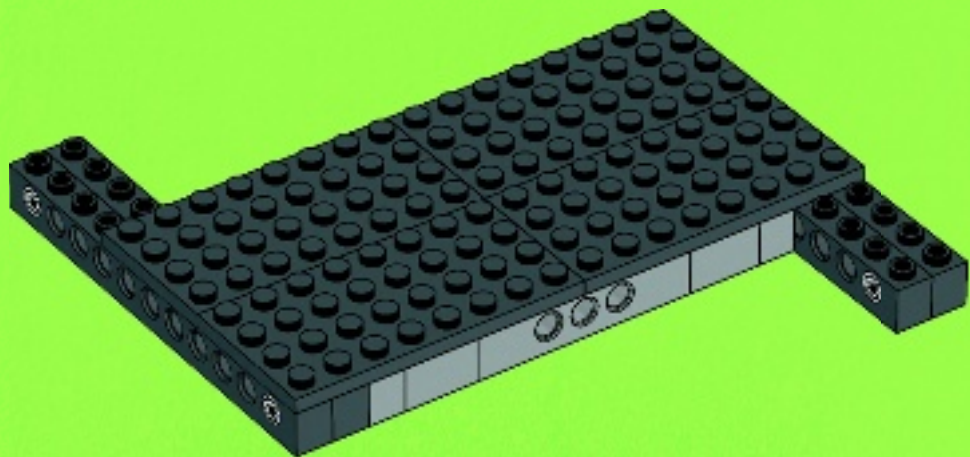



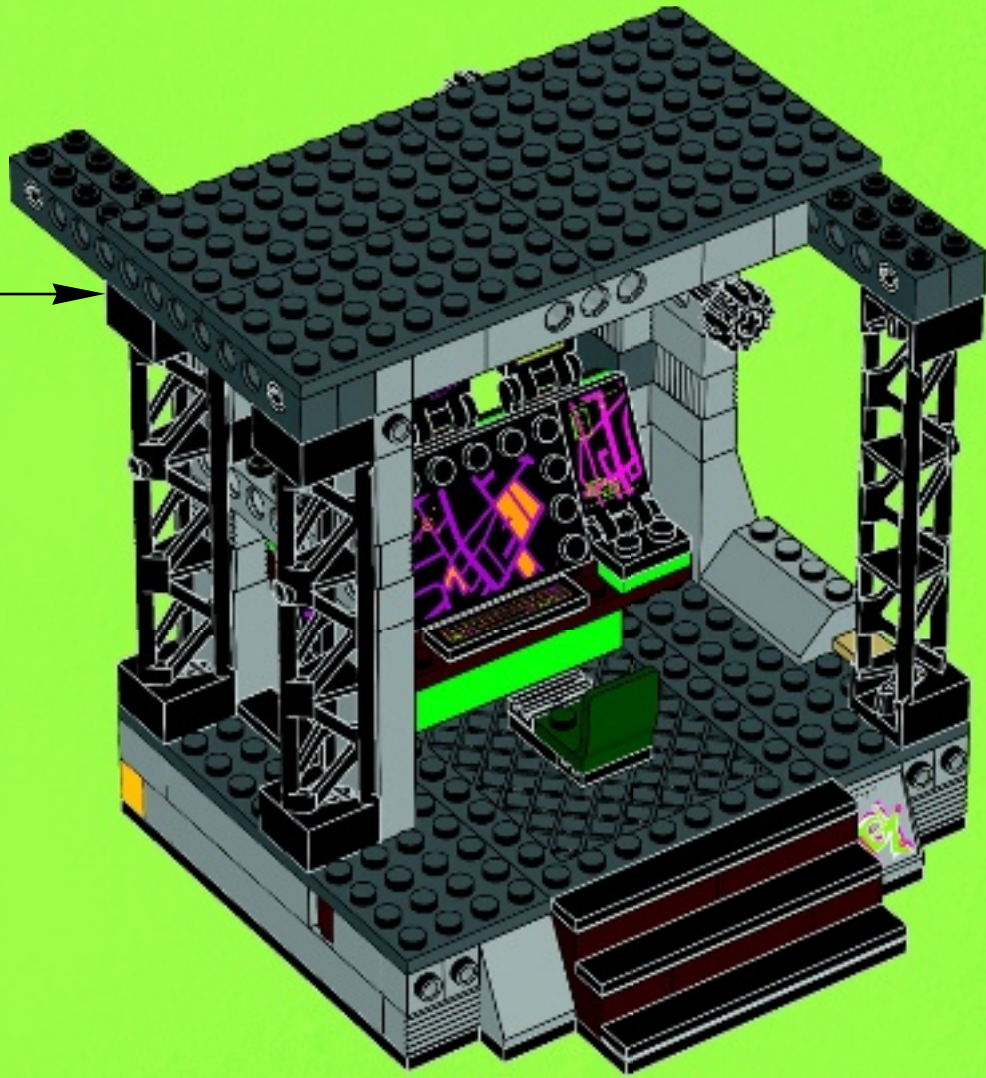





33

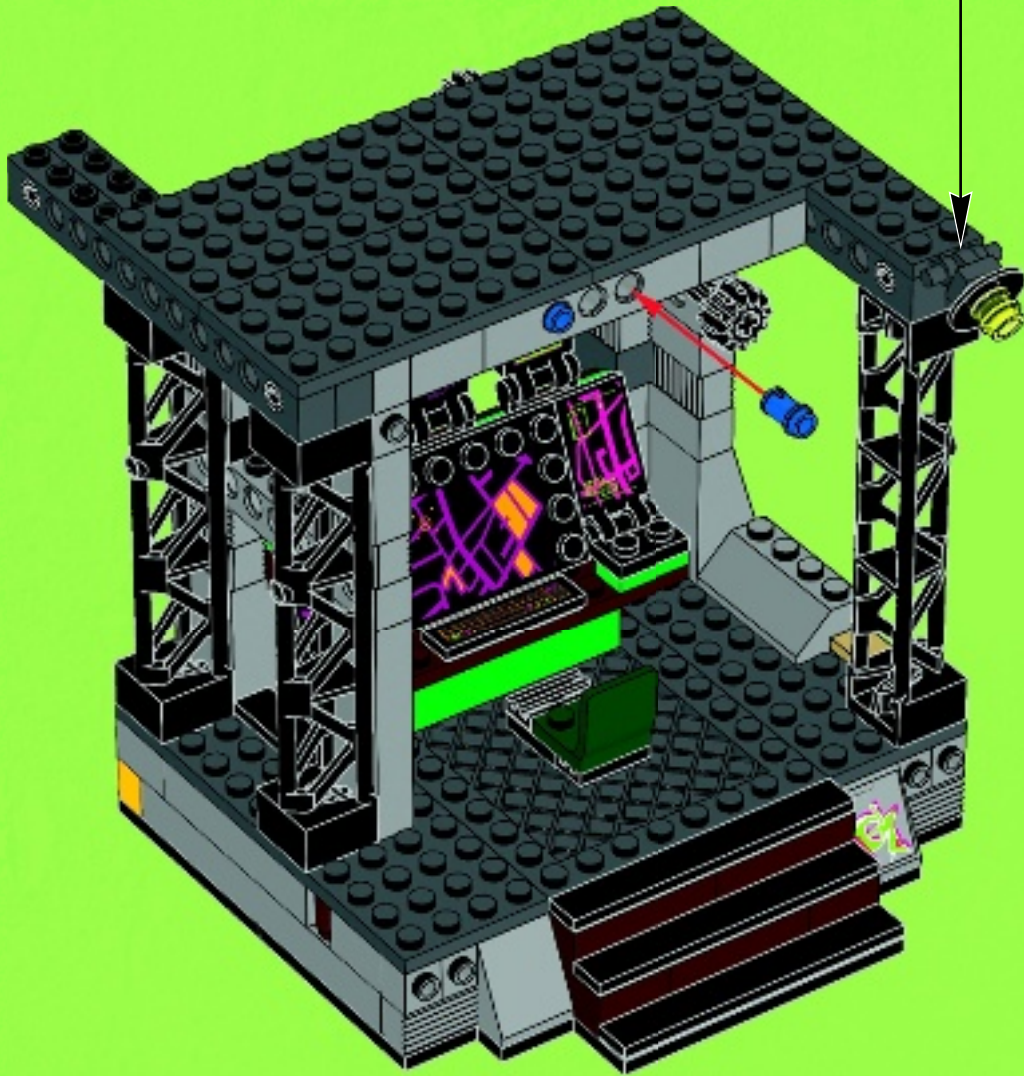



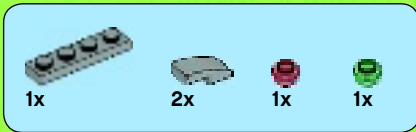

# 34

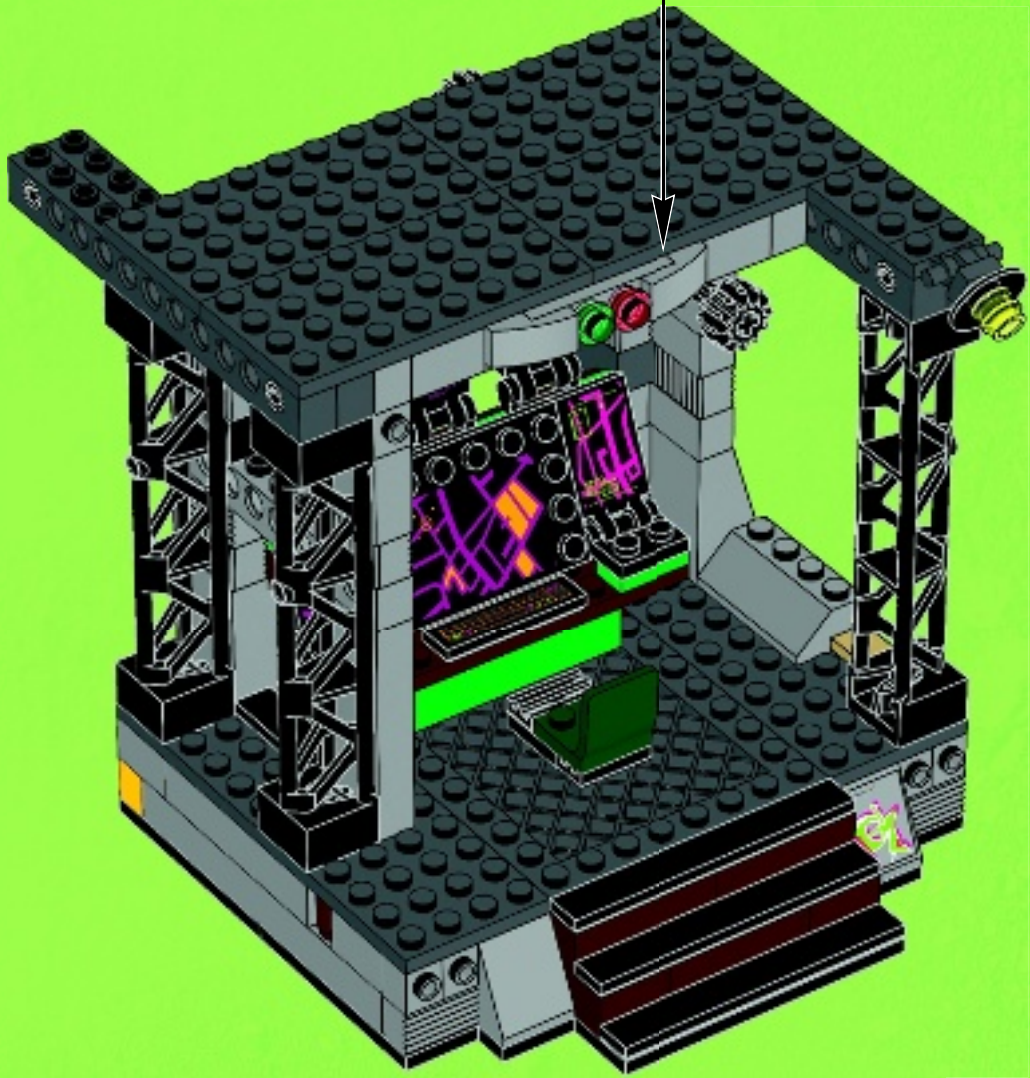
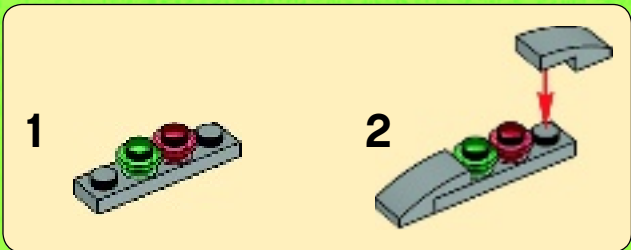





# 35

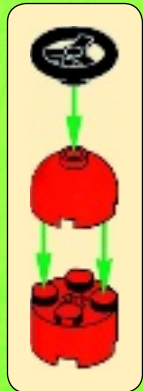
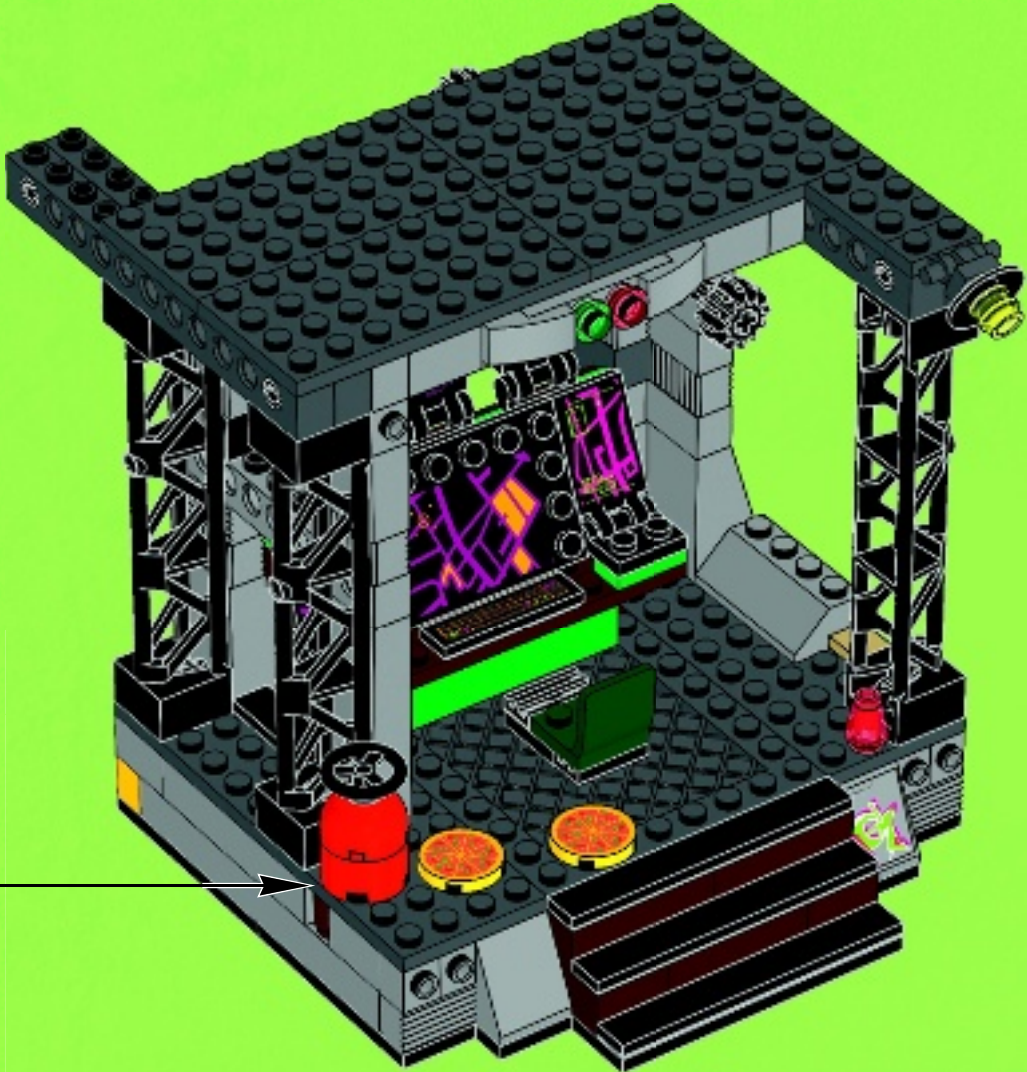



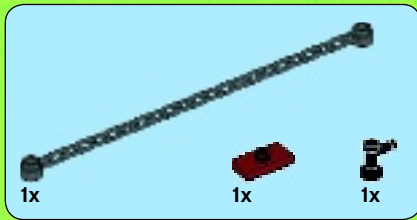

36

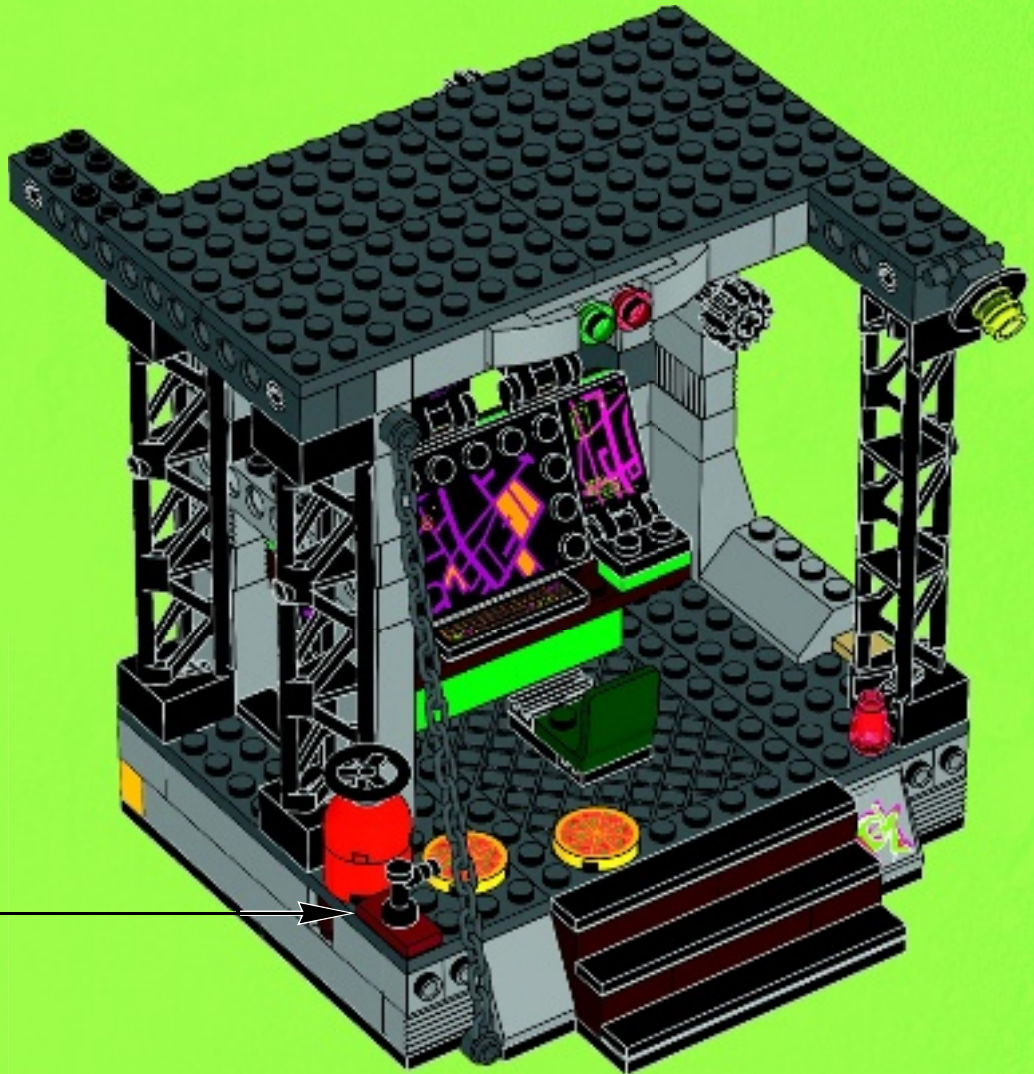



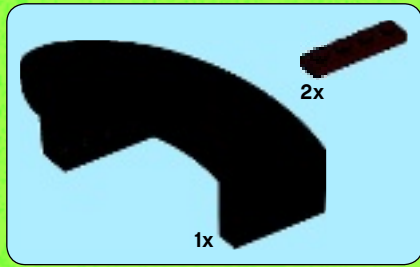

37

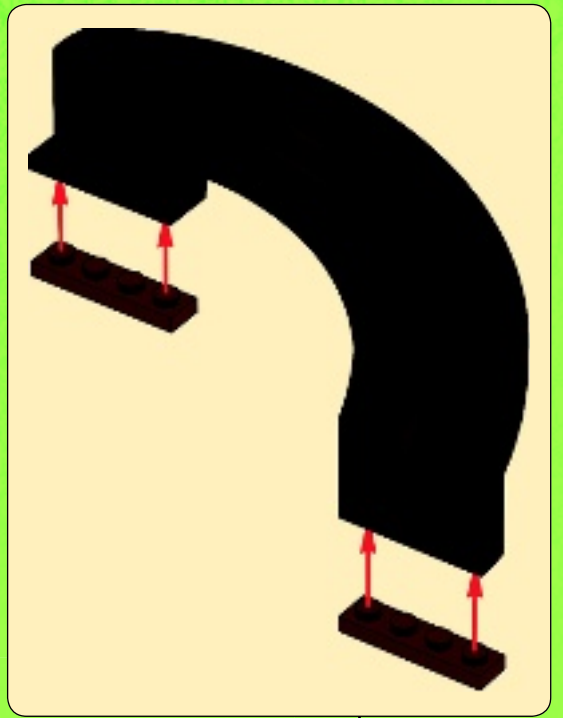
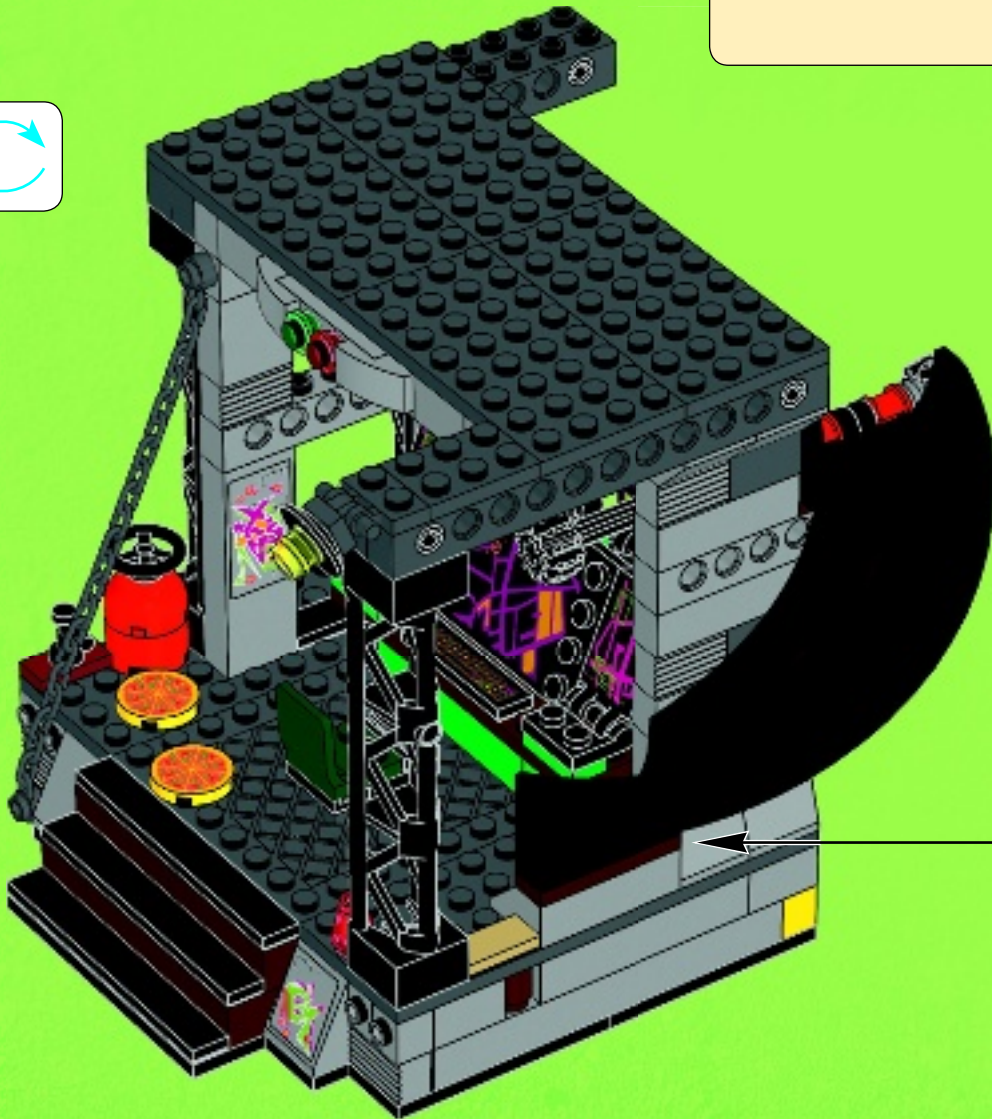



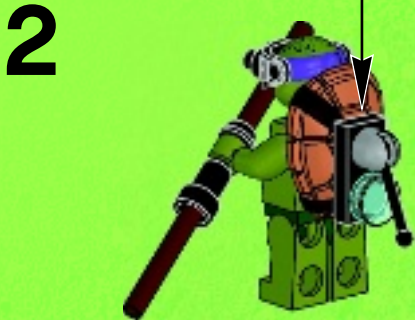
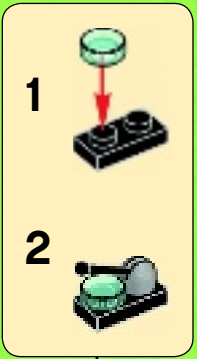
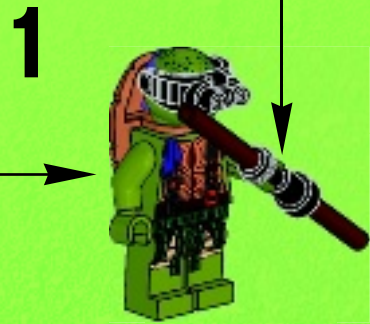
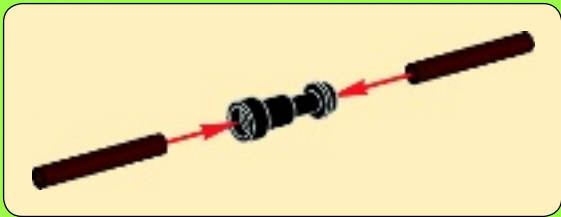
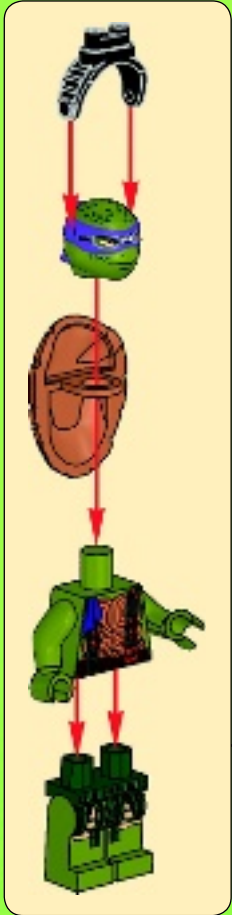
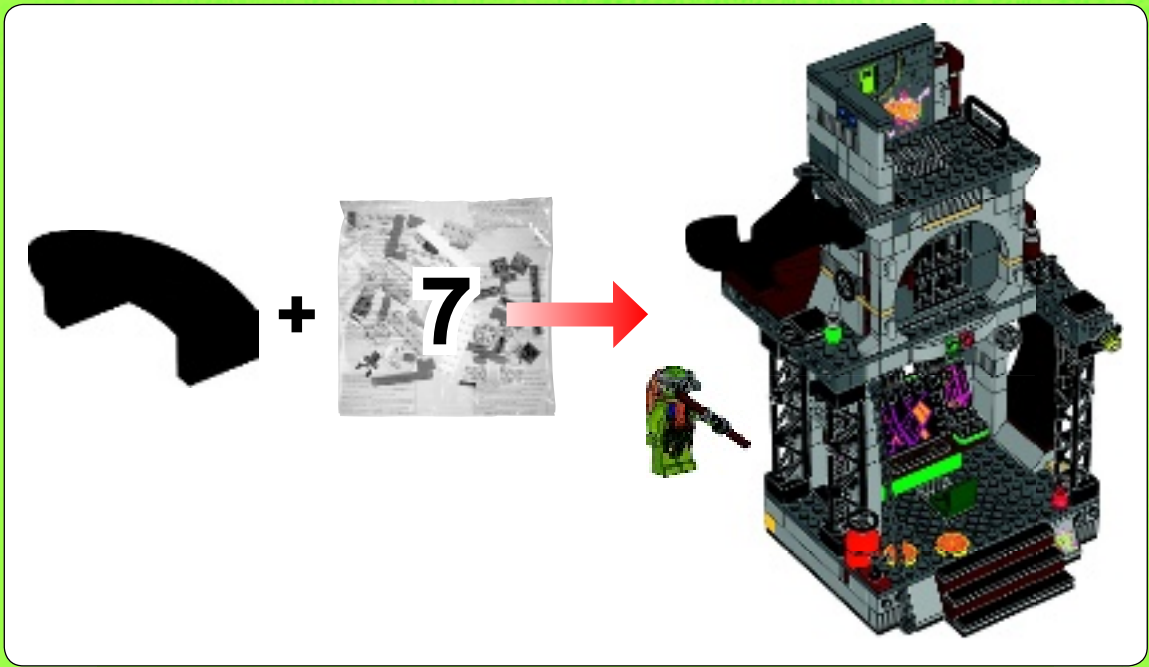





2x



1x



1x

# 38

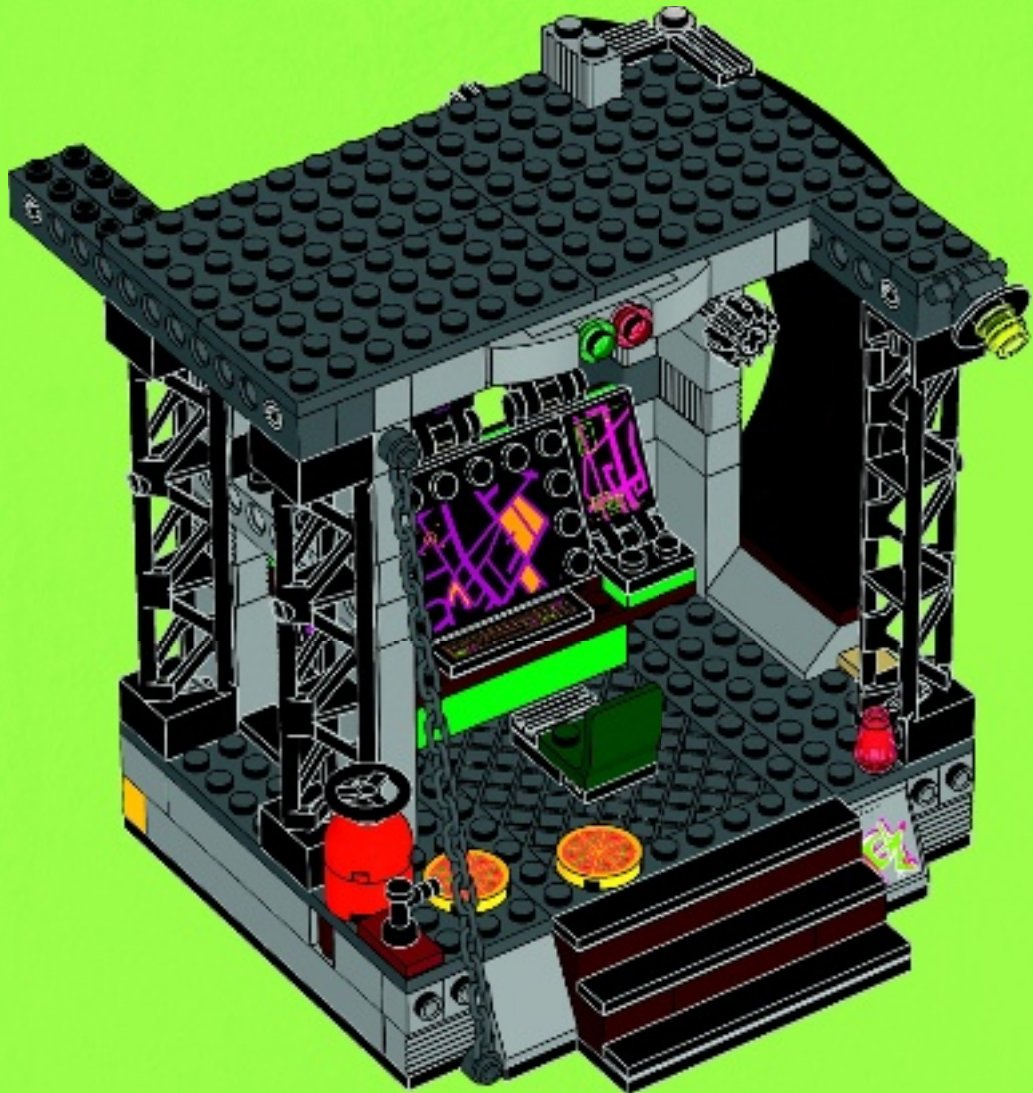



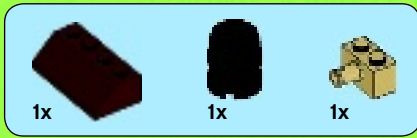

# 39

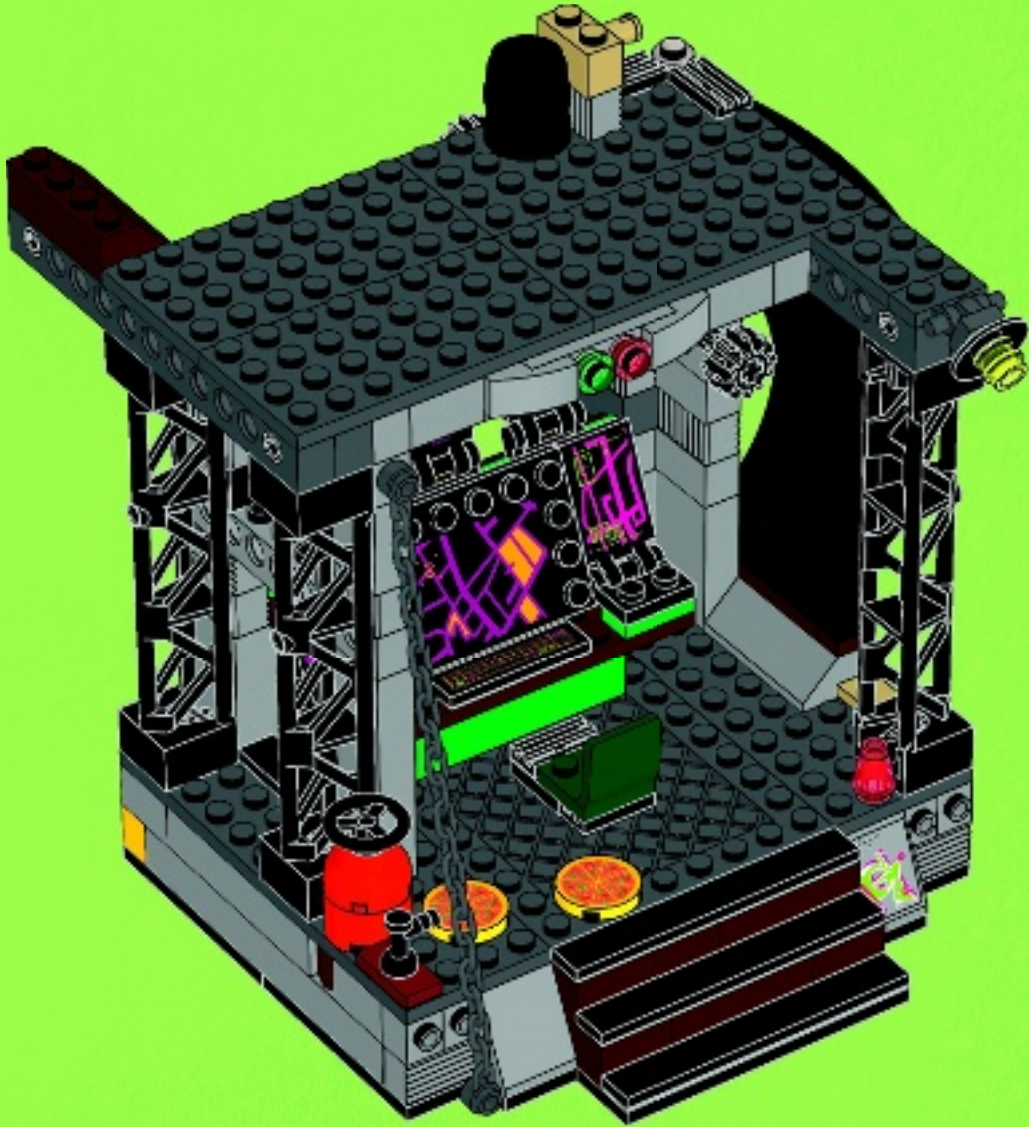





1x



1x



1x

# 40

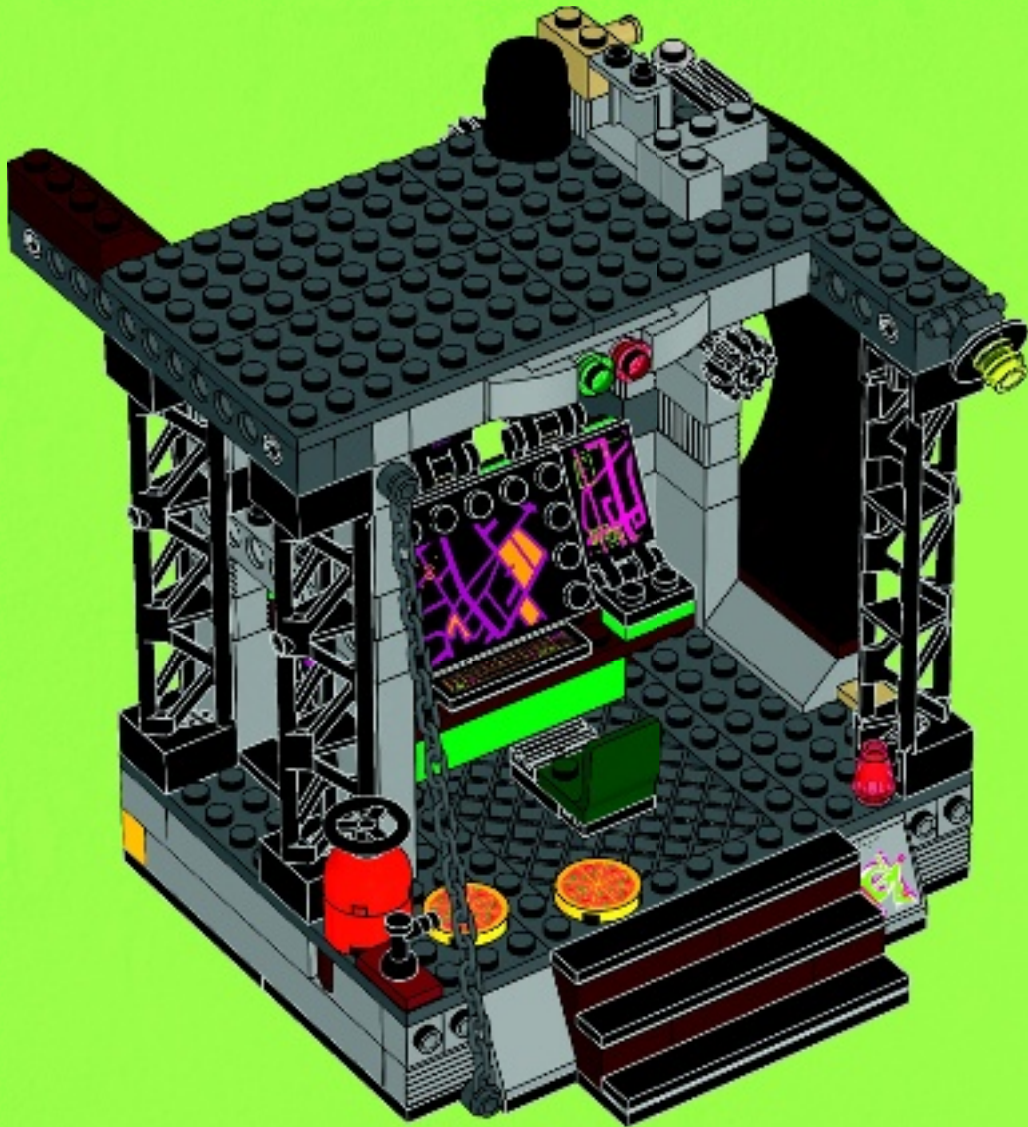



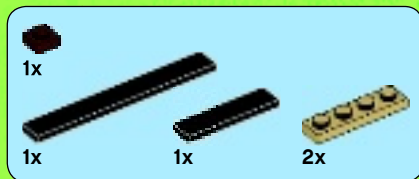

41

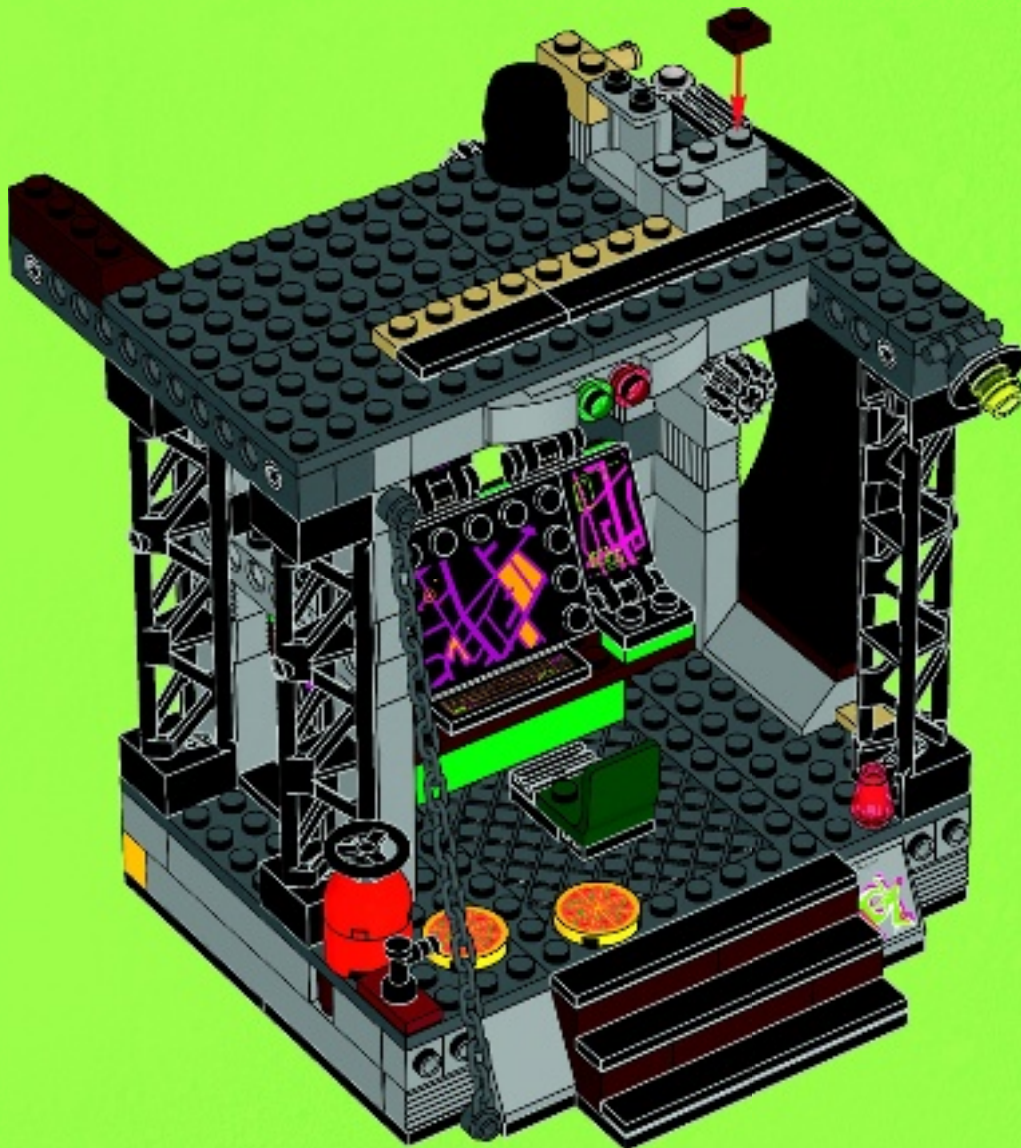



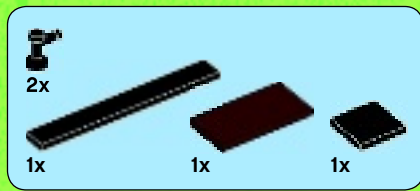

42

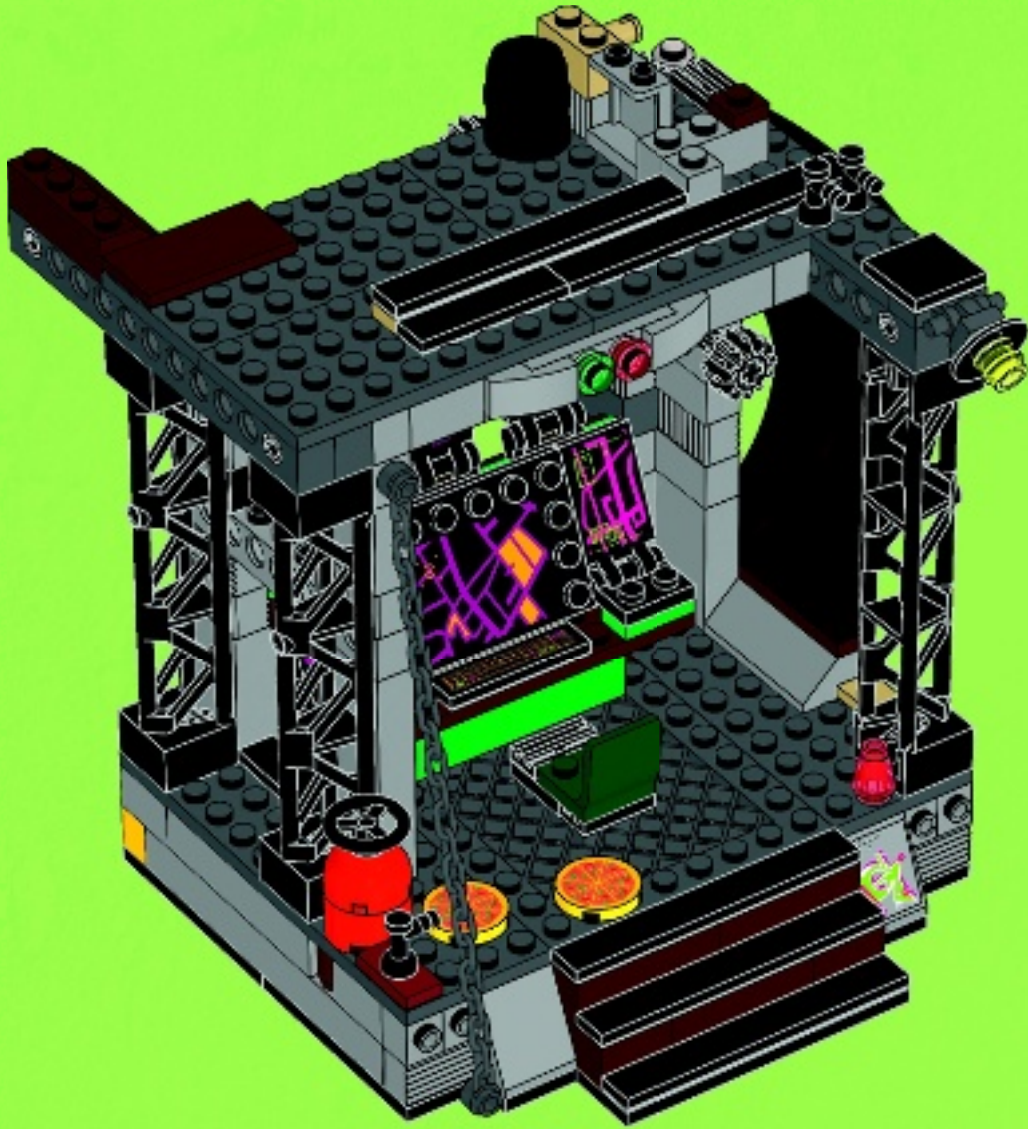





# 43

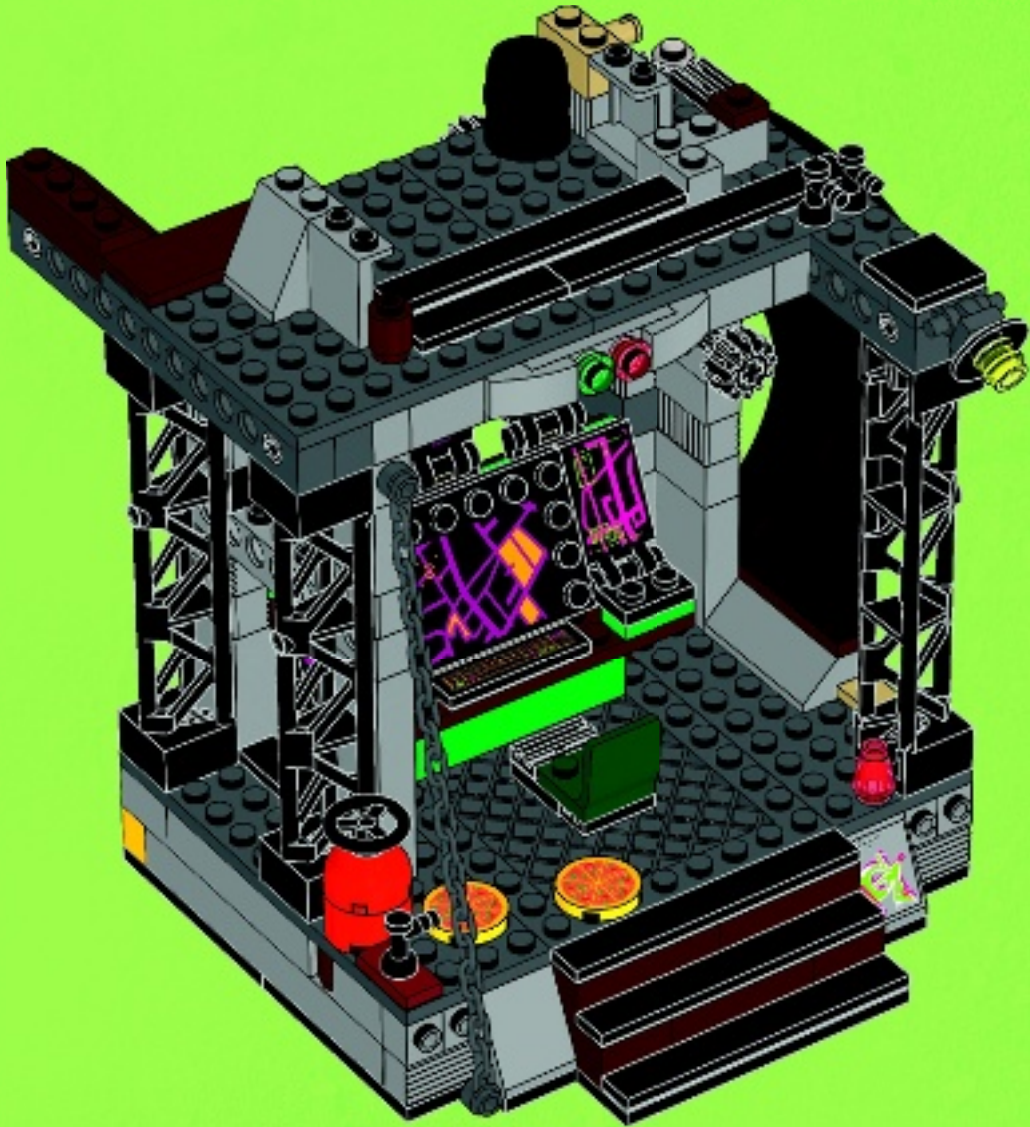





2x



2x

# 44

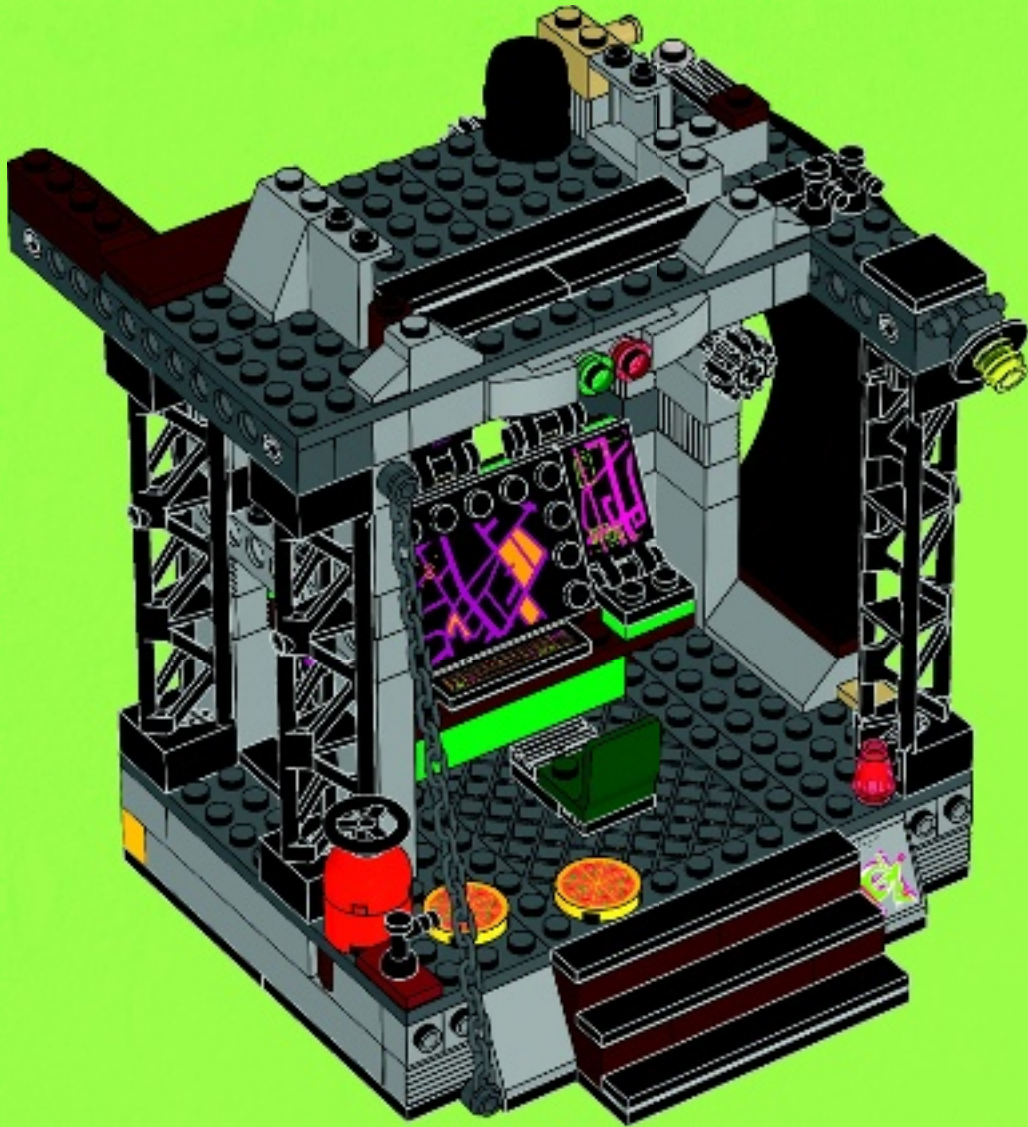







2x  1x 

# 46

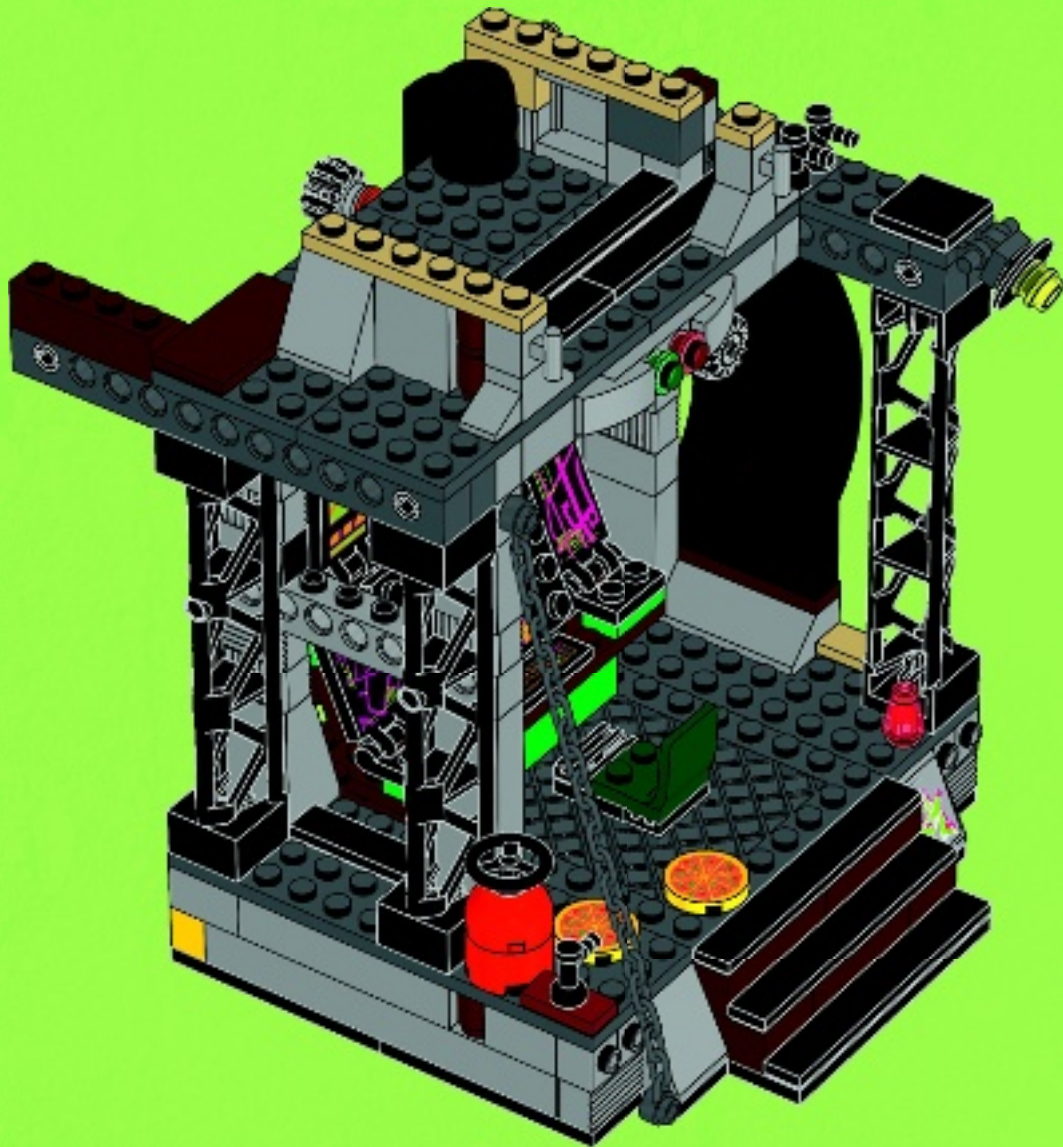



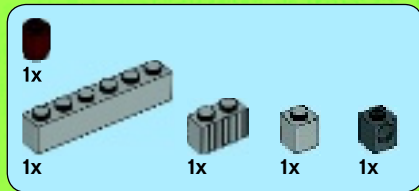

47

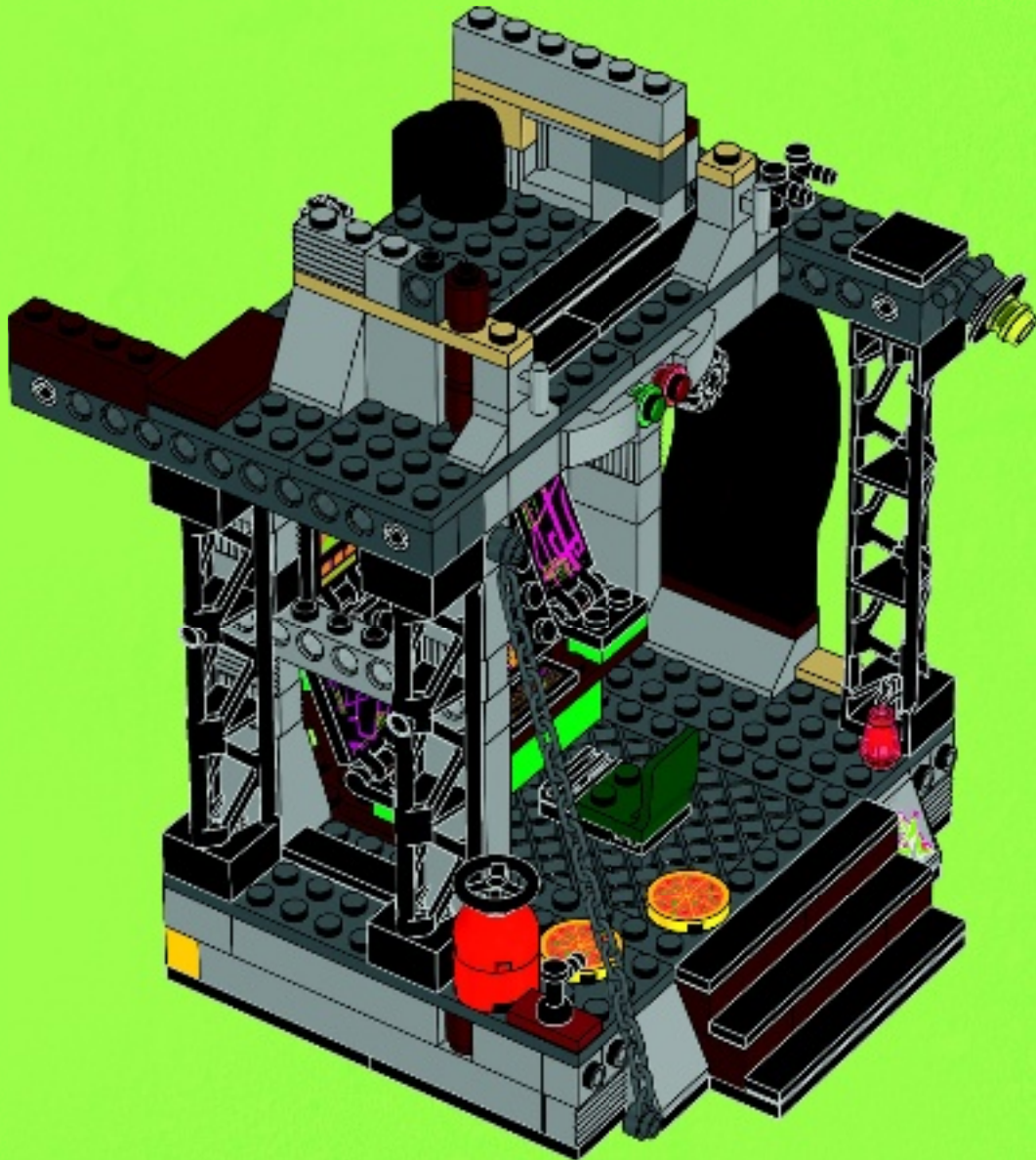



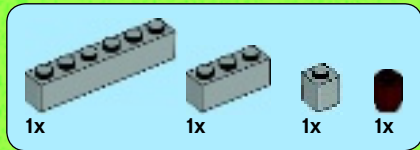

# 48

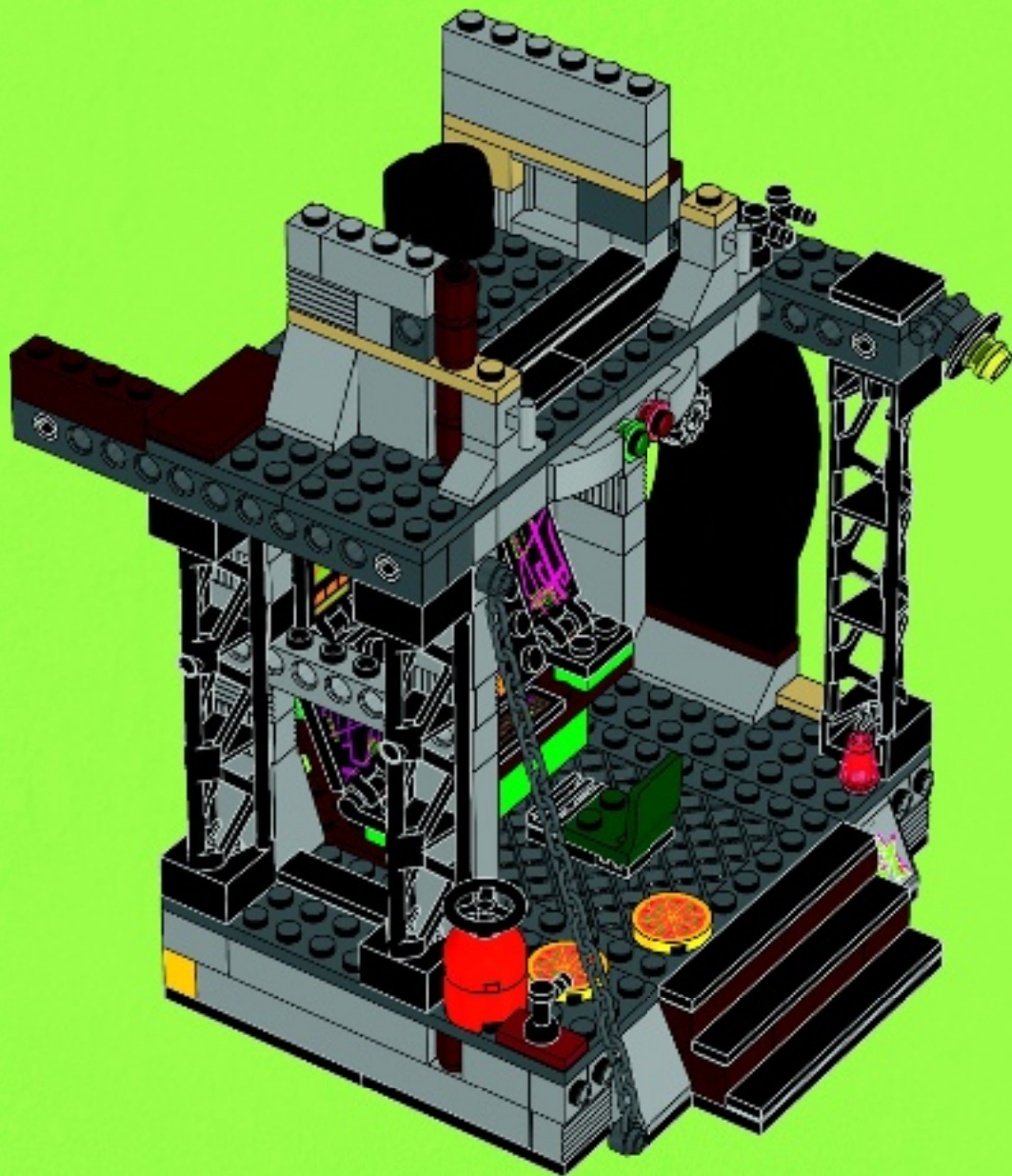



1x 4x 1x

49

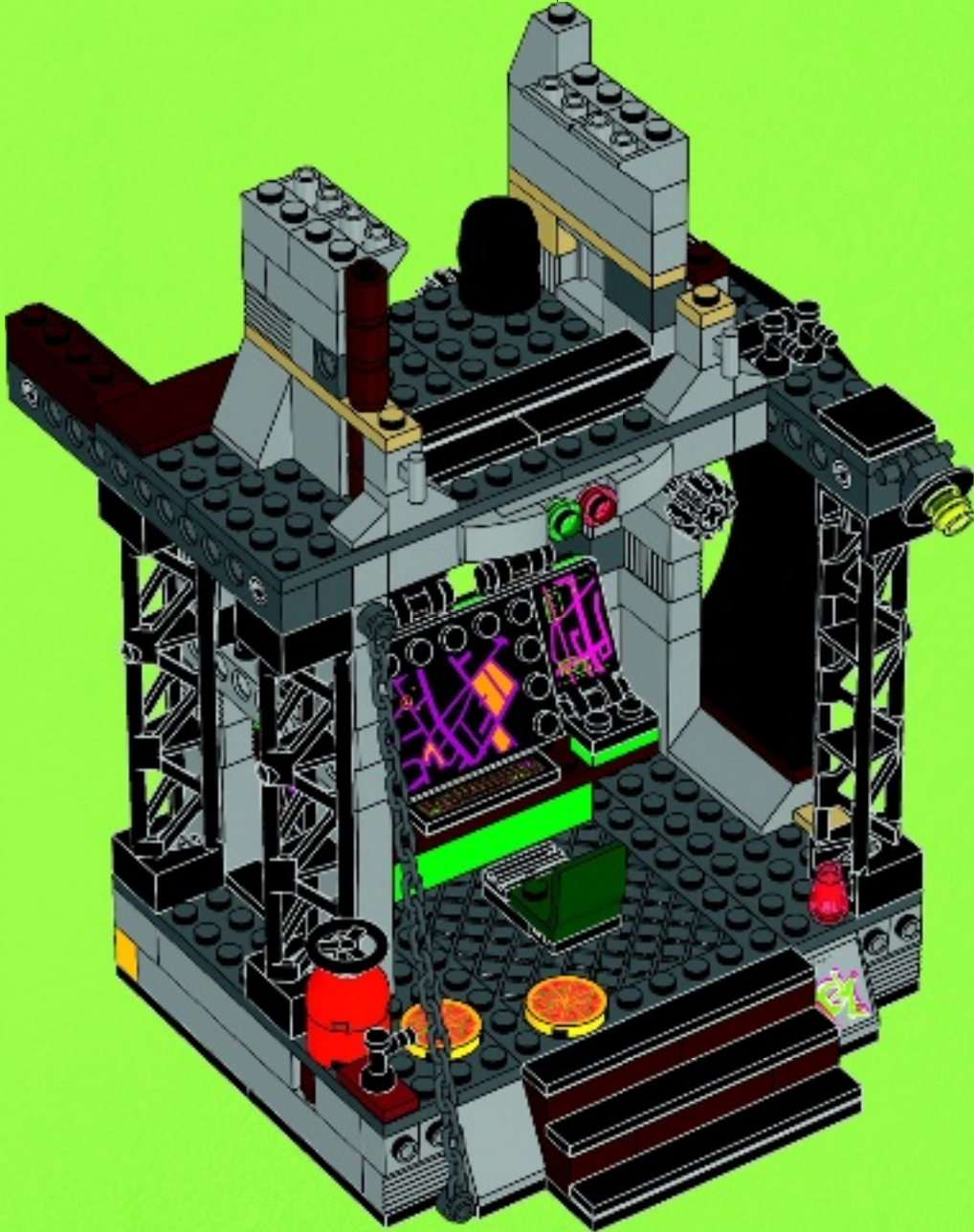



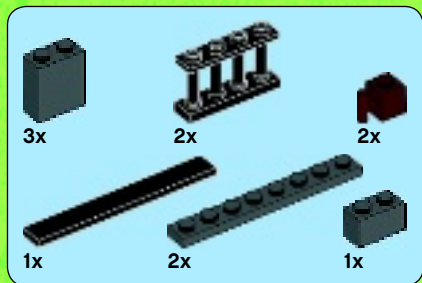

50

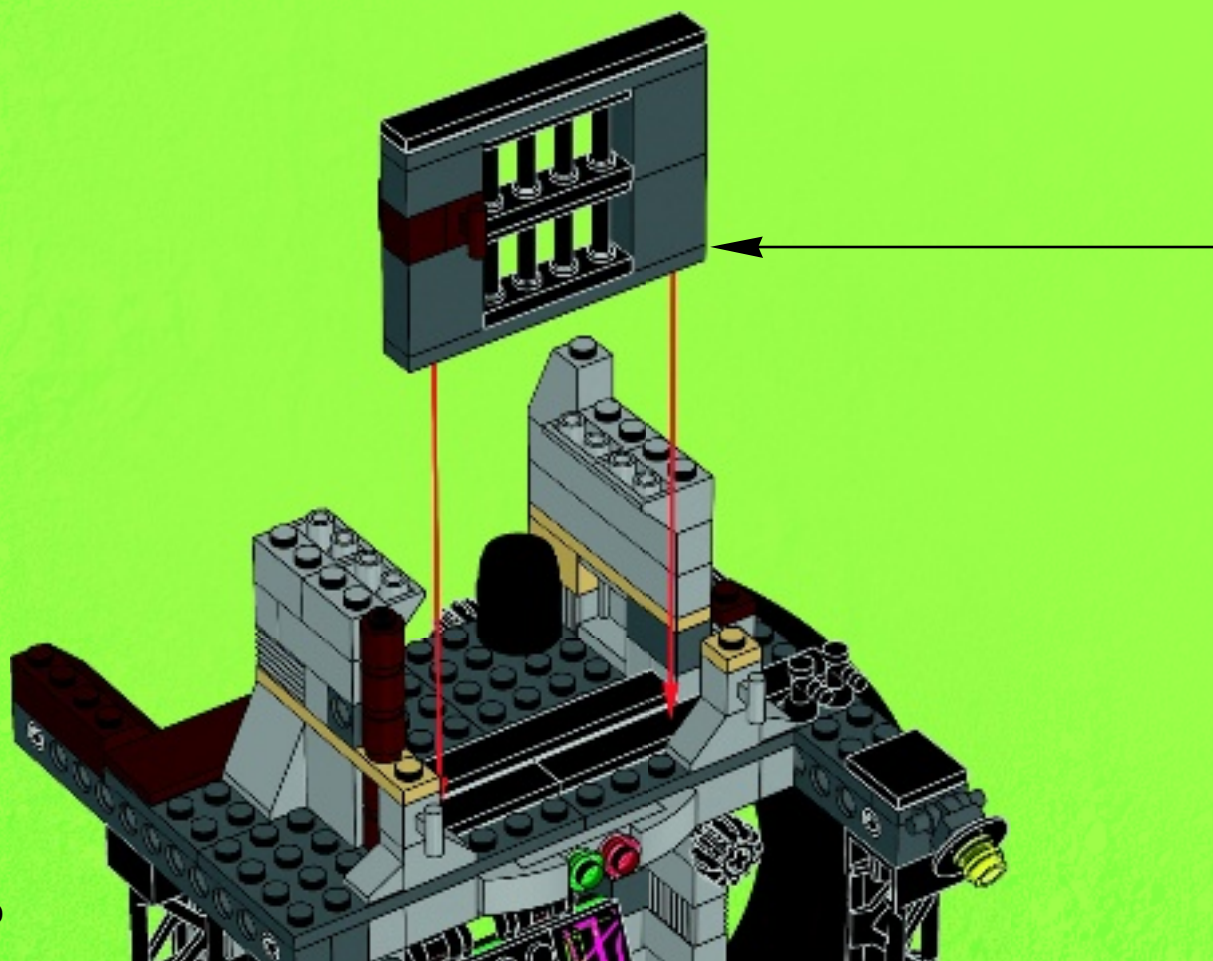
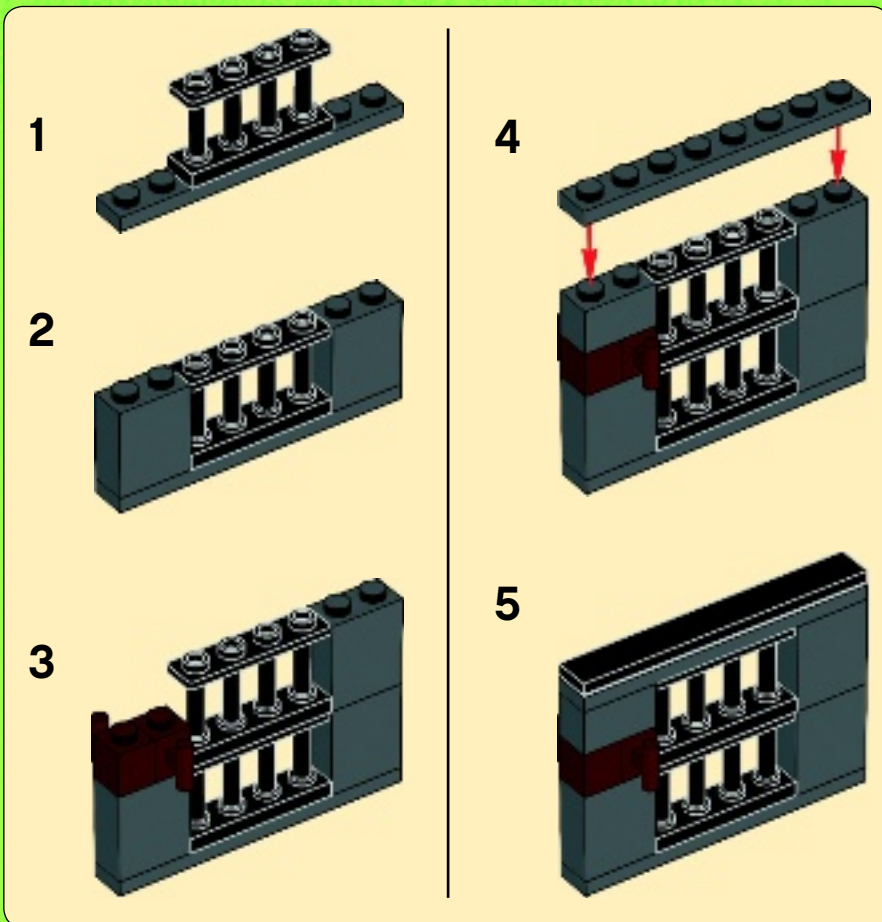



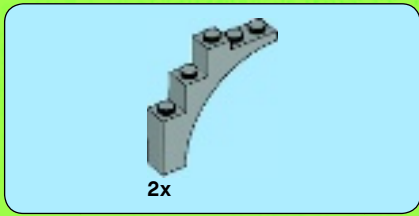

51

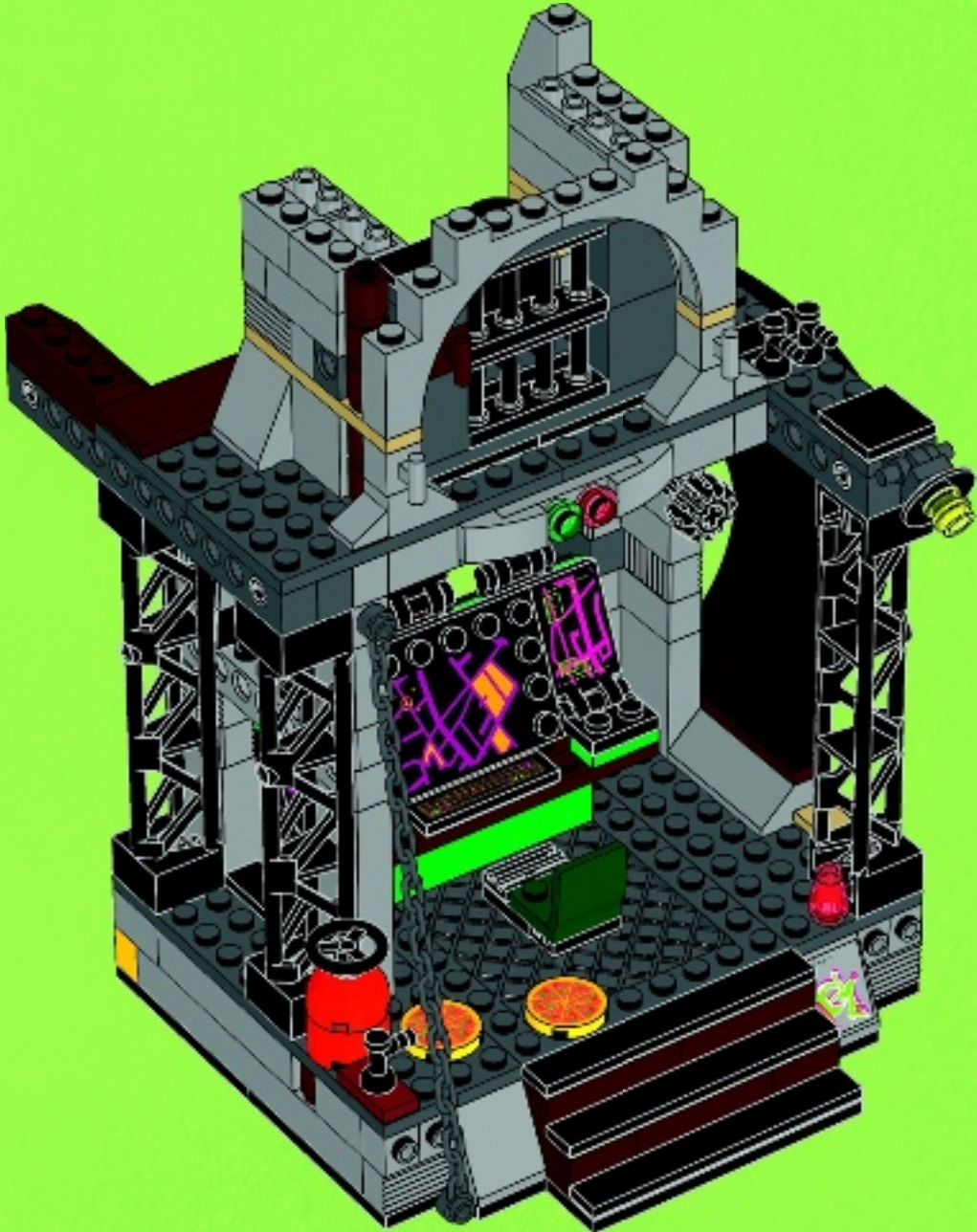





1x



2x

# 52

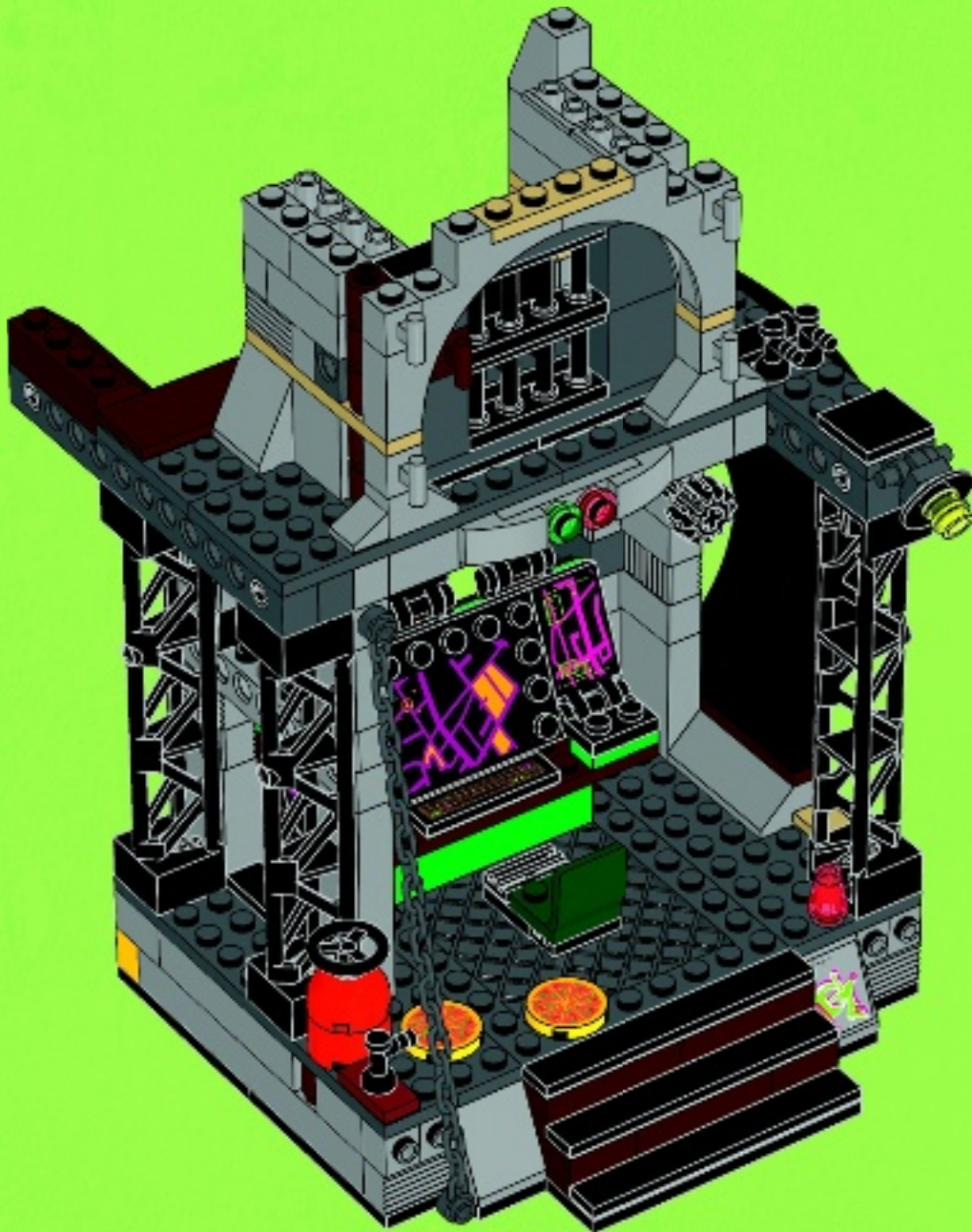



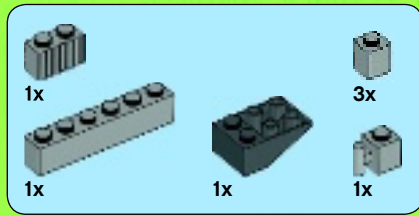

# 53

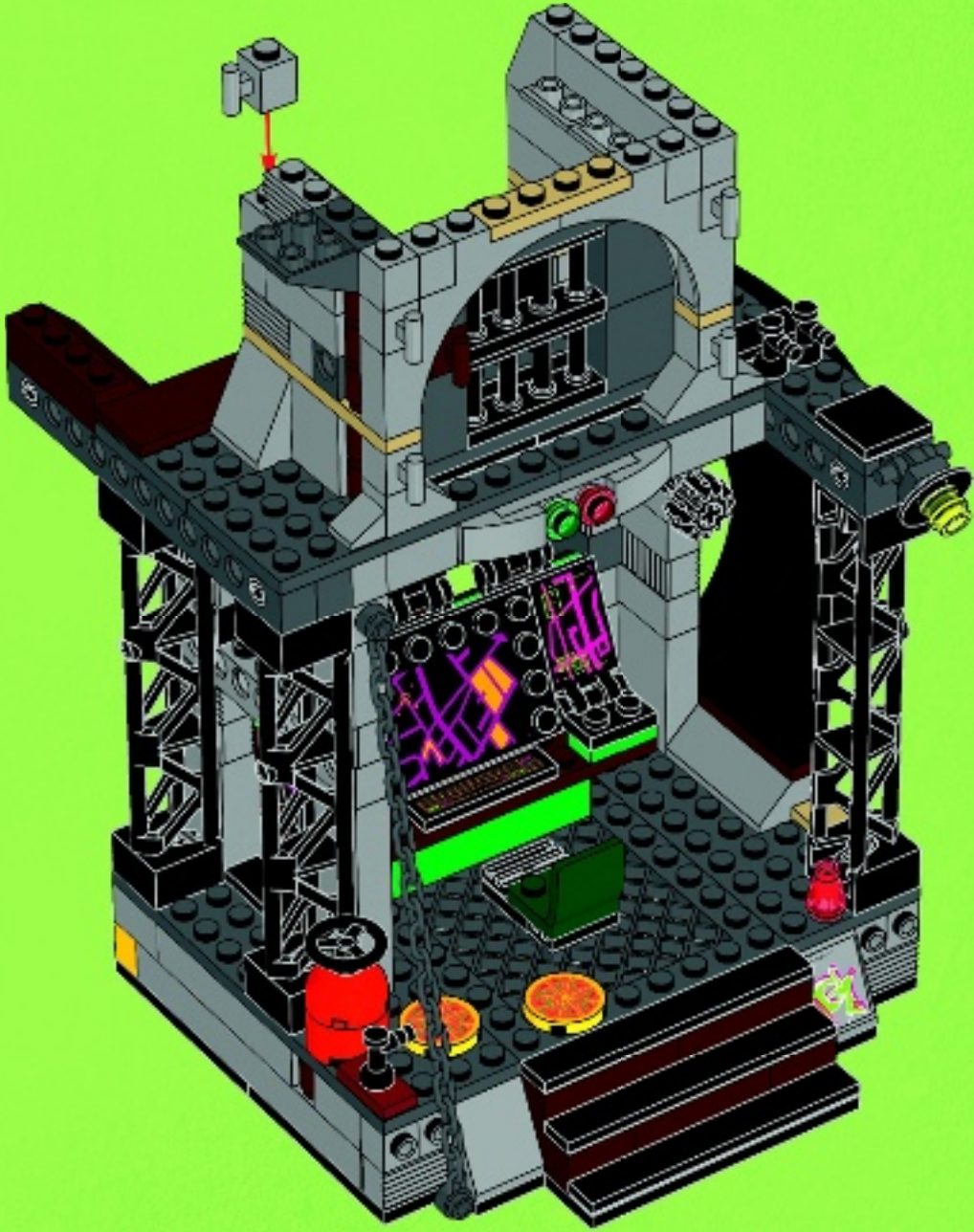



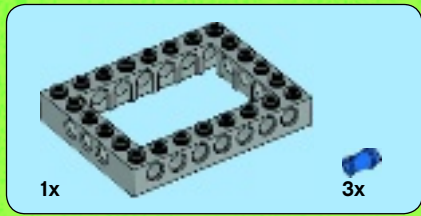

1

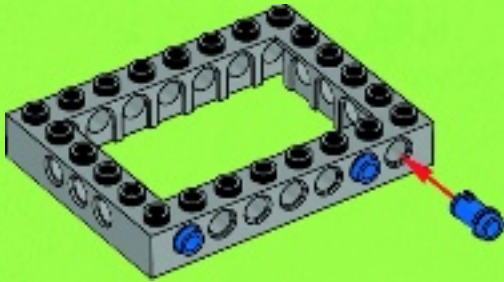

2

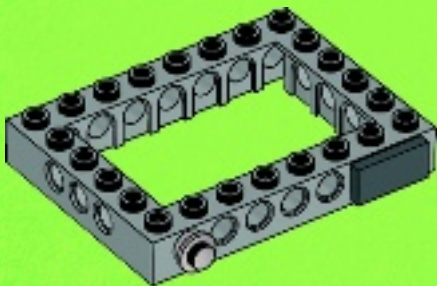

3

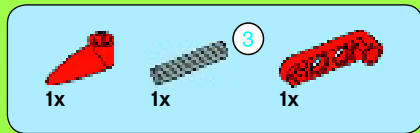
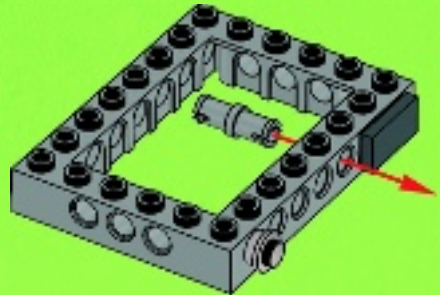

4

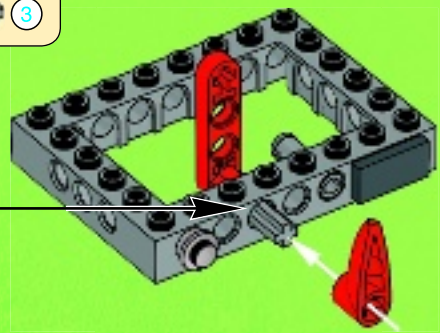
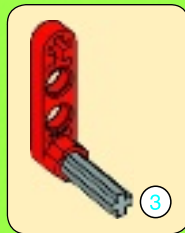



5

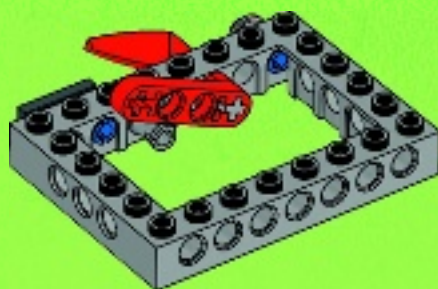

54

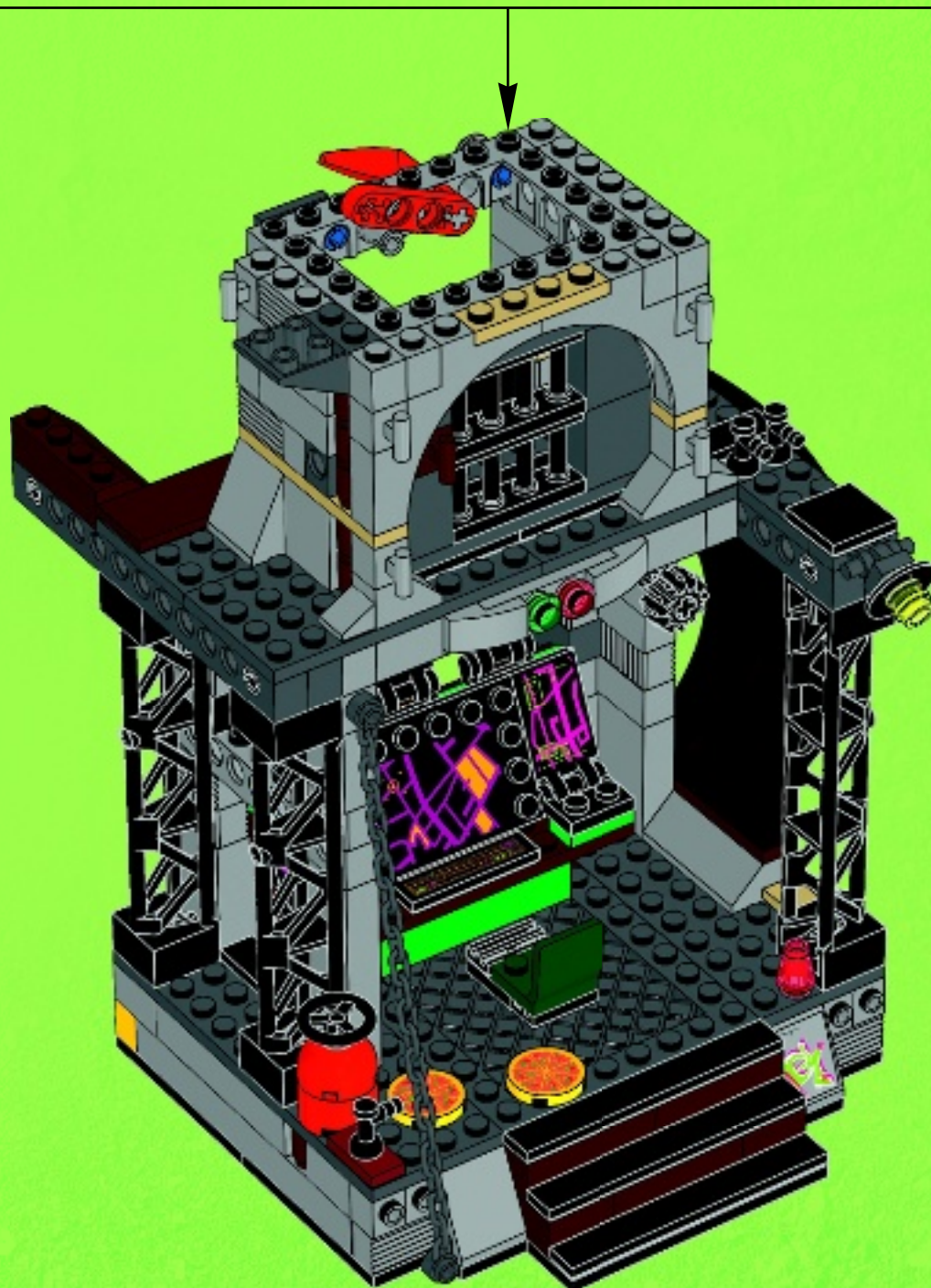



-   
2x
-   
2x
-   
1x
-   
2x

# 55

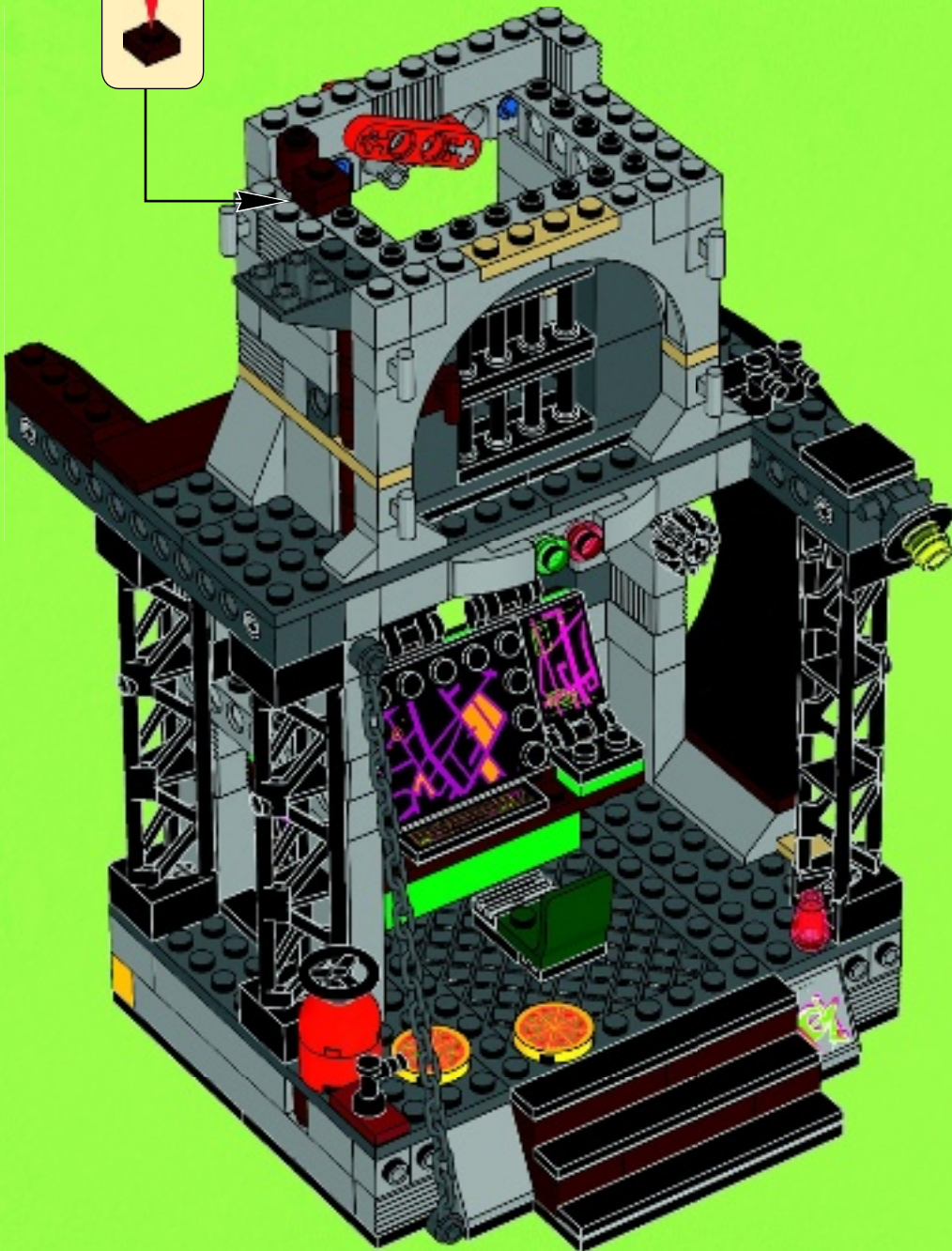
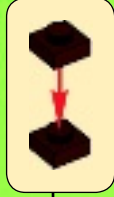



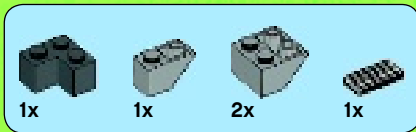

# 56

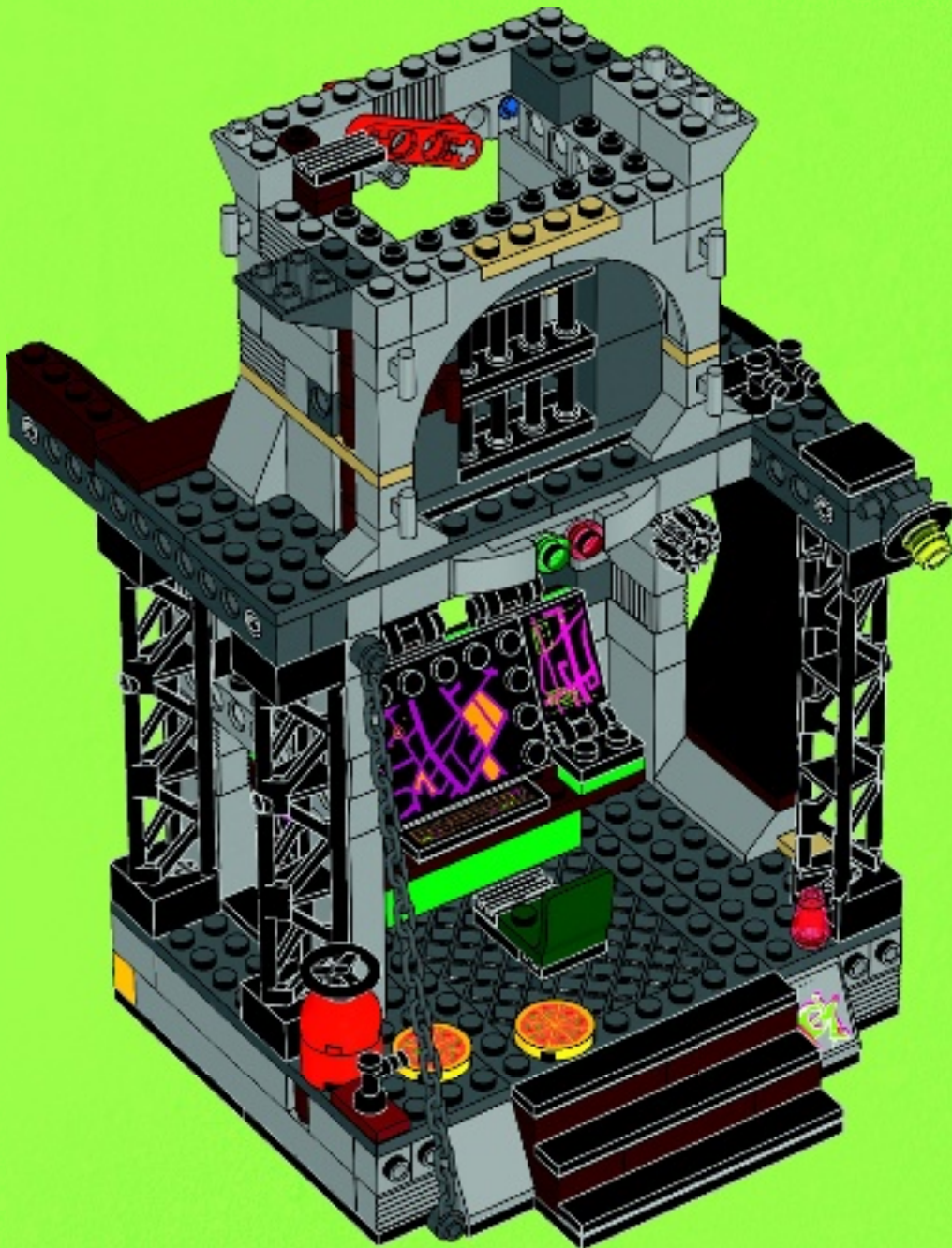





1x



1x

# 57

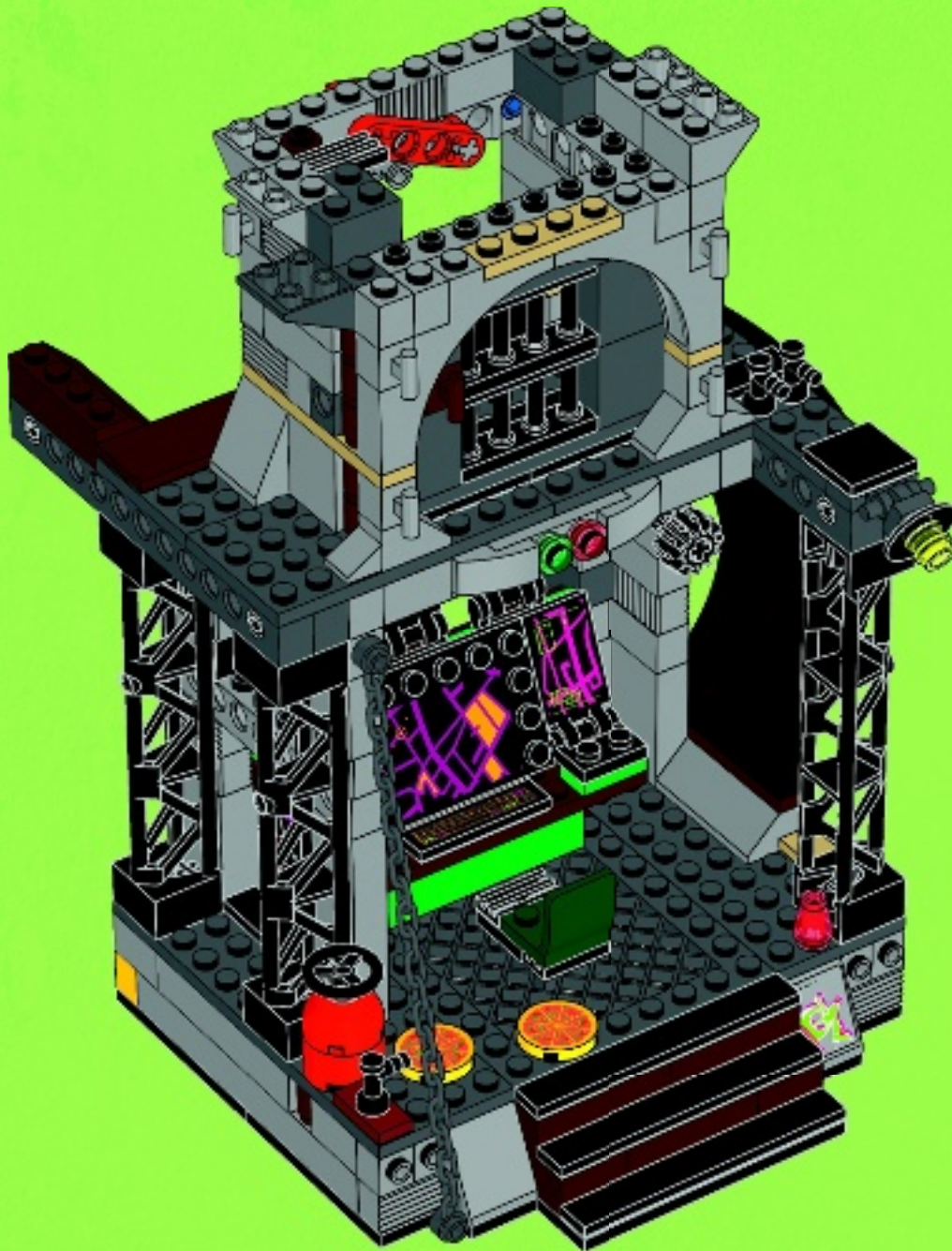





2x



2x

# 58

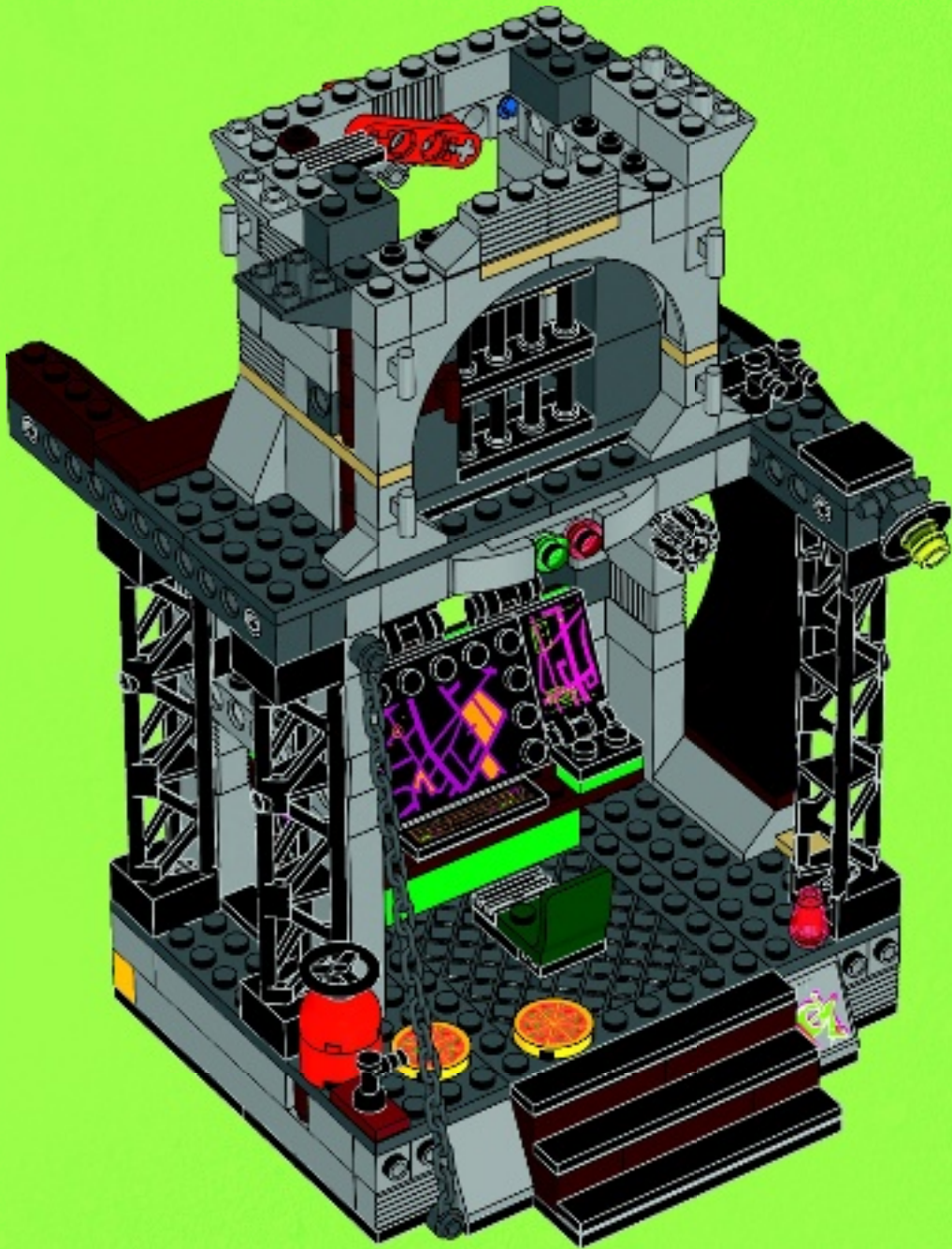





2x

# 59

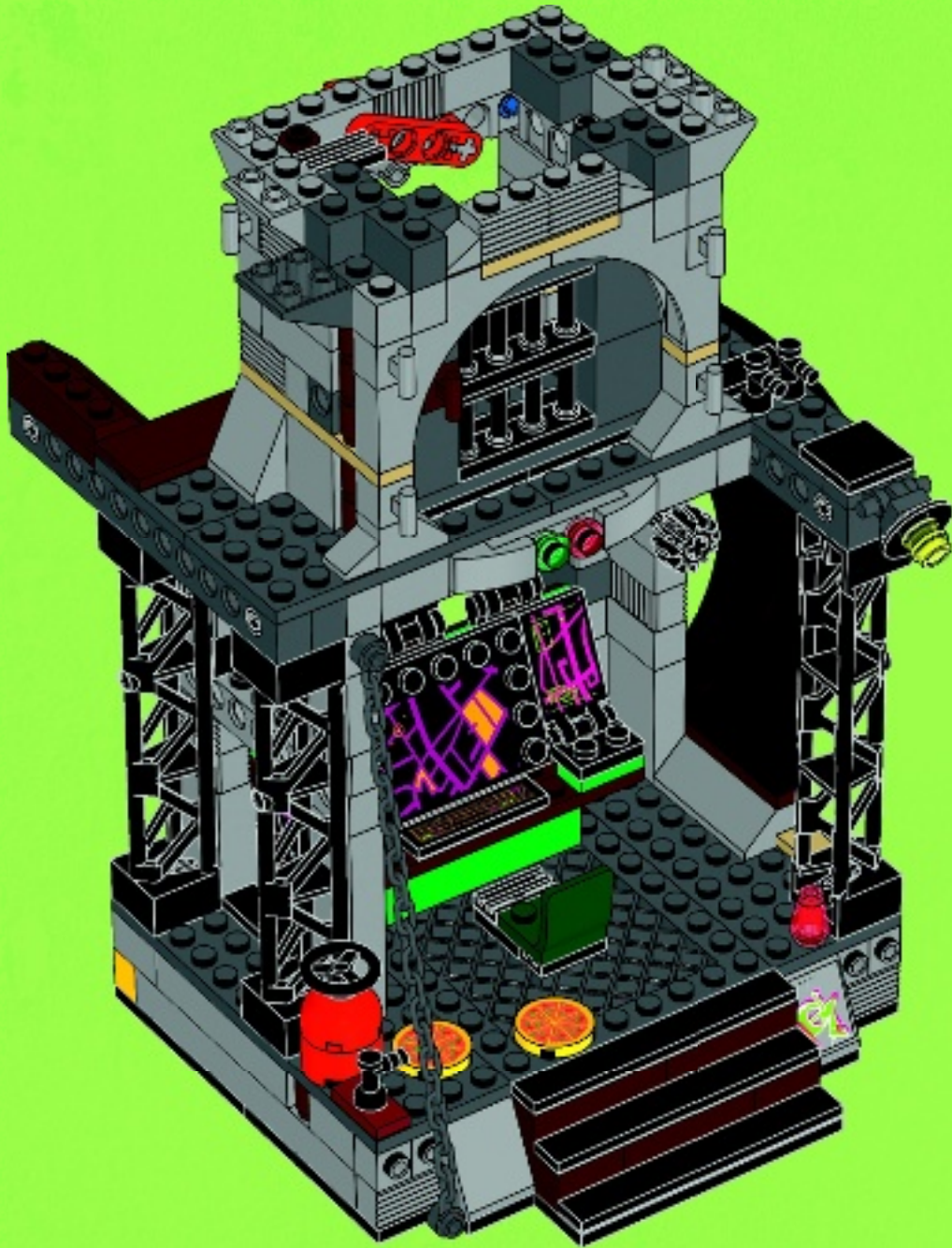





1x



1x

# 60

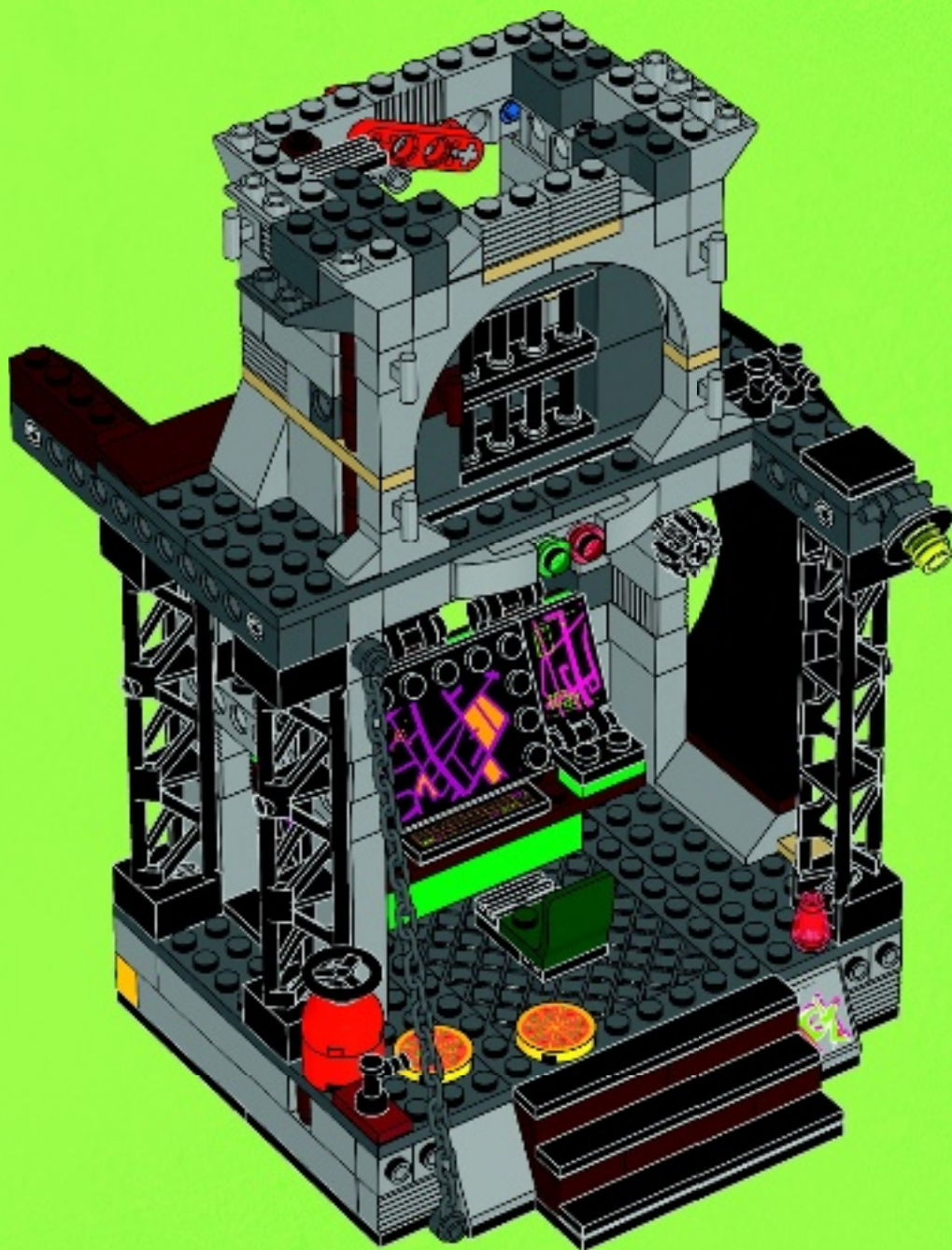



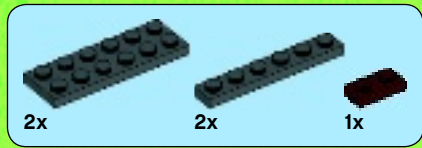

# 61

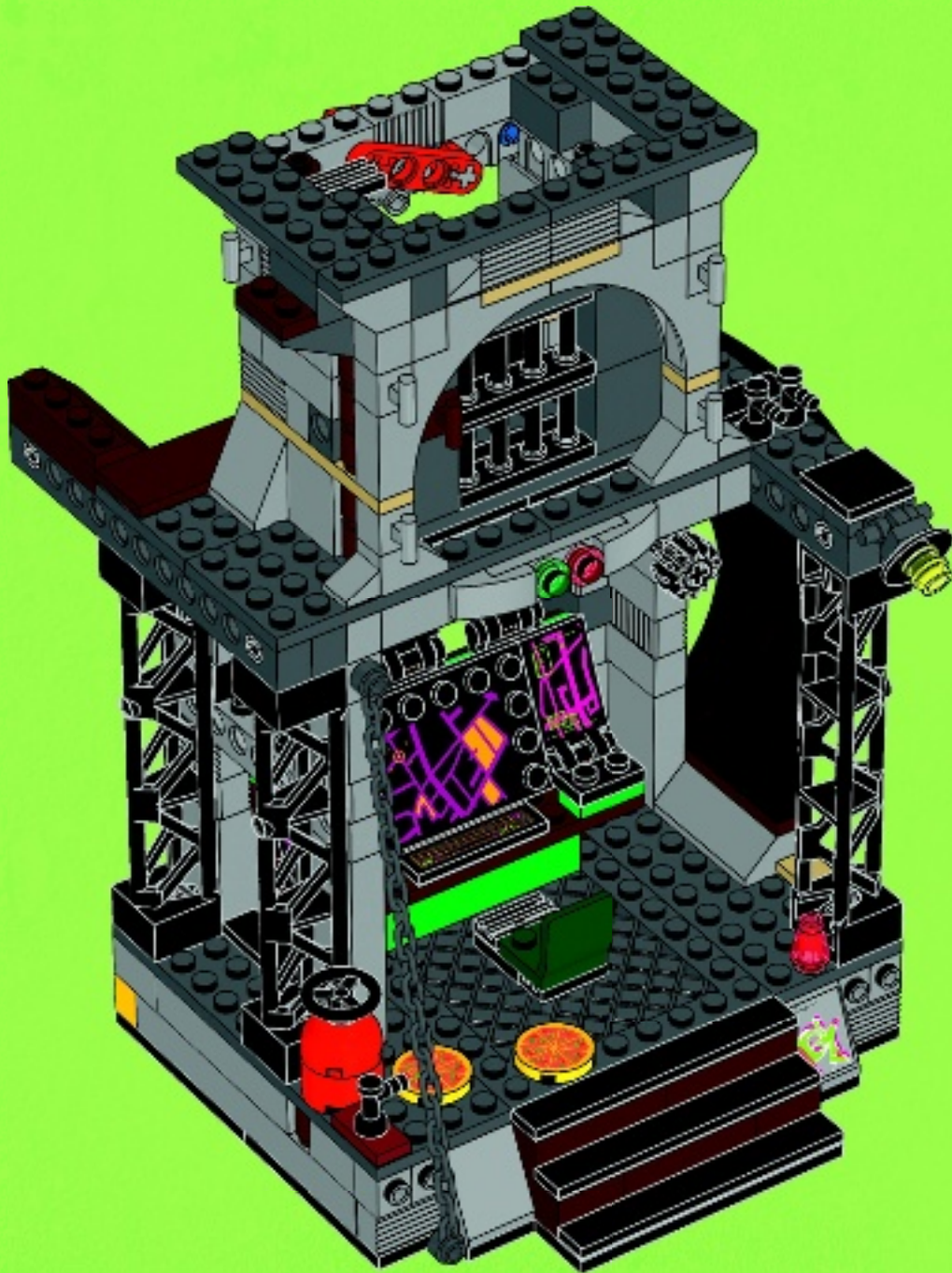





62

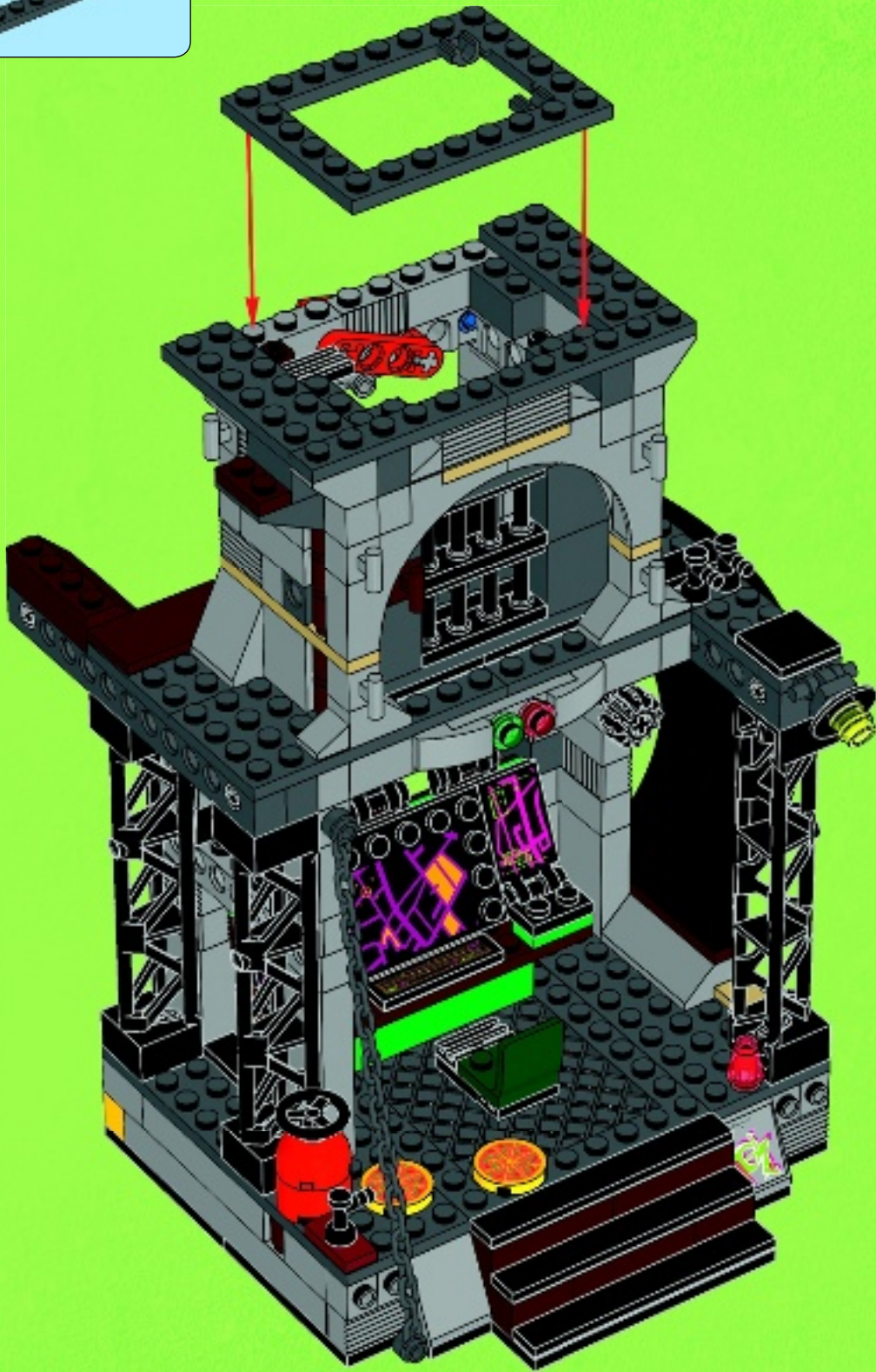





# 63

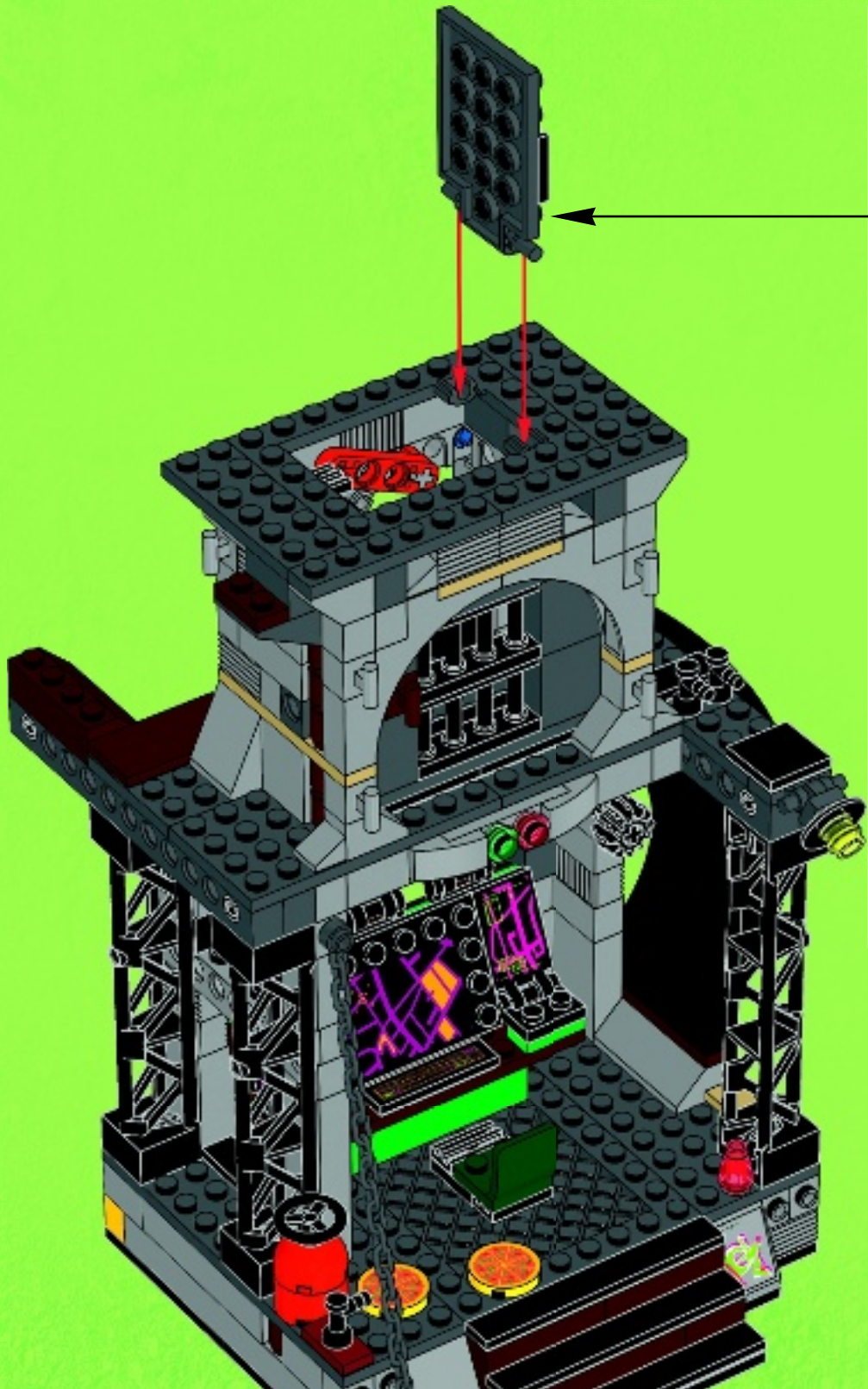



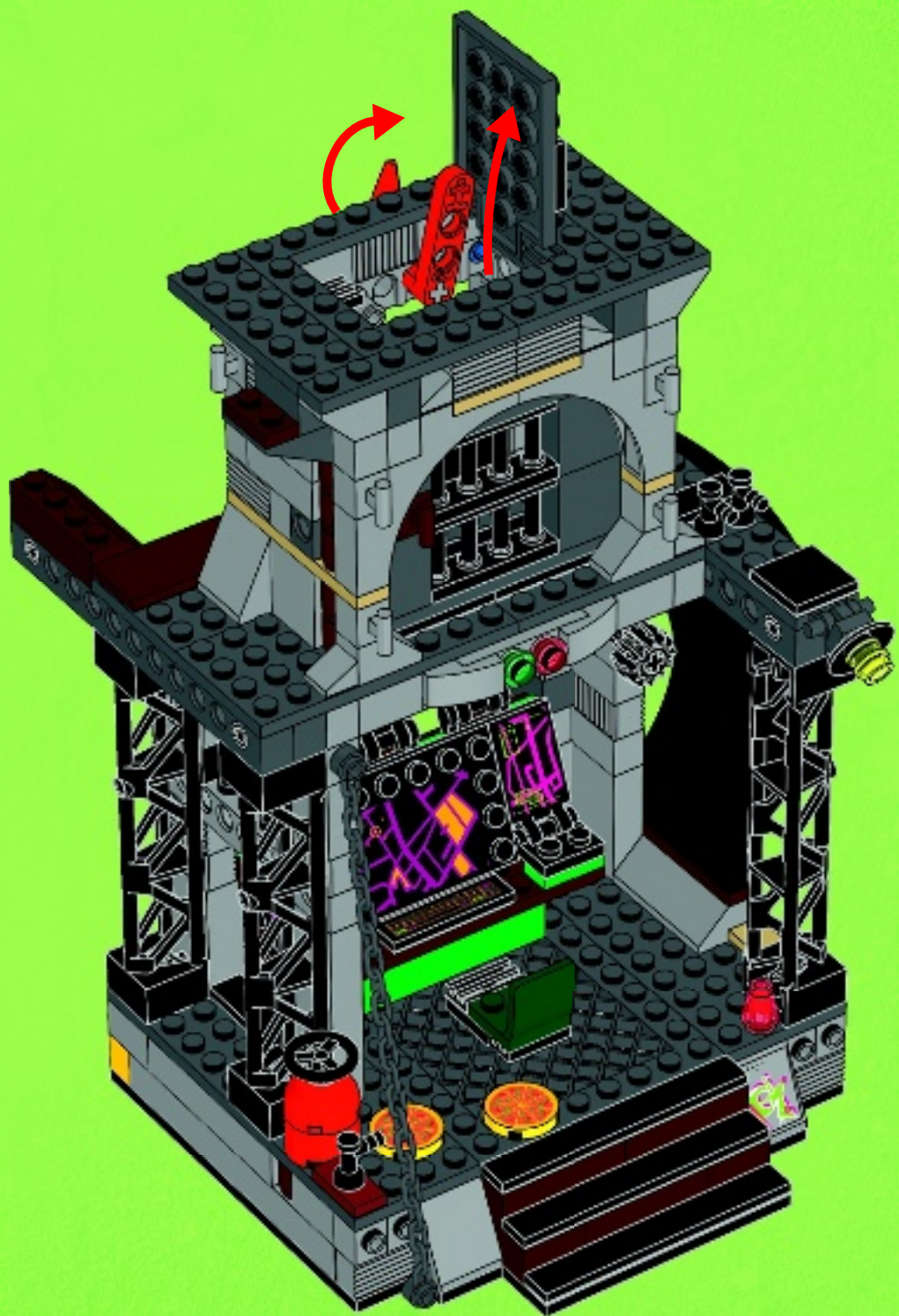





# 64

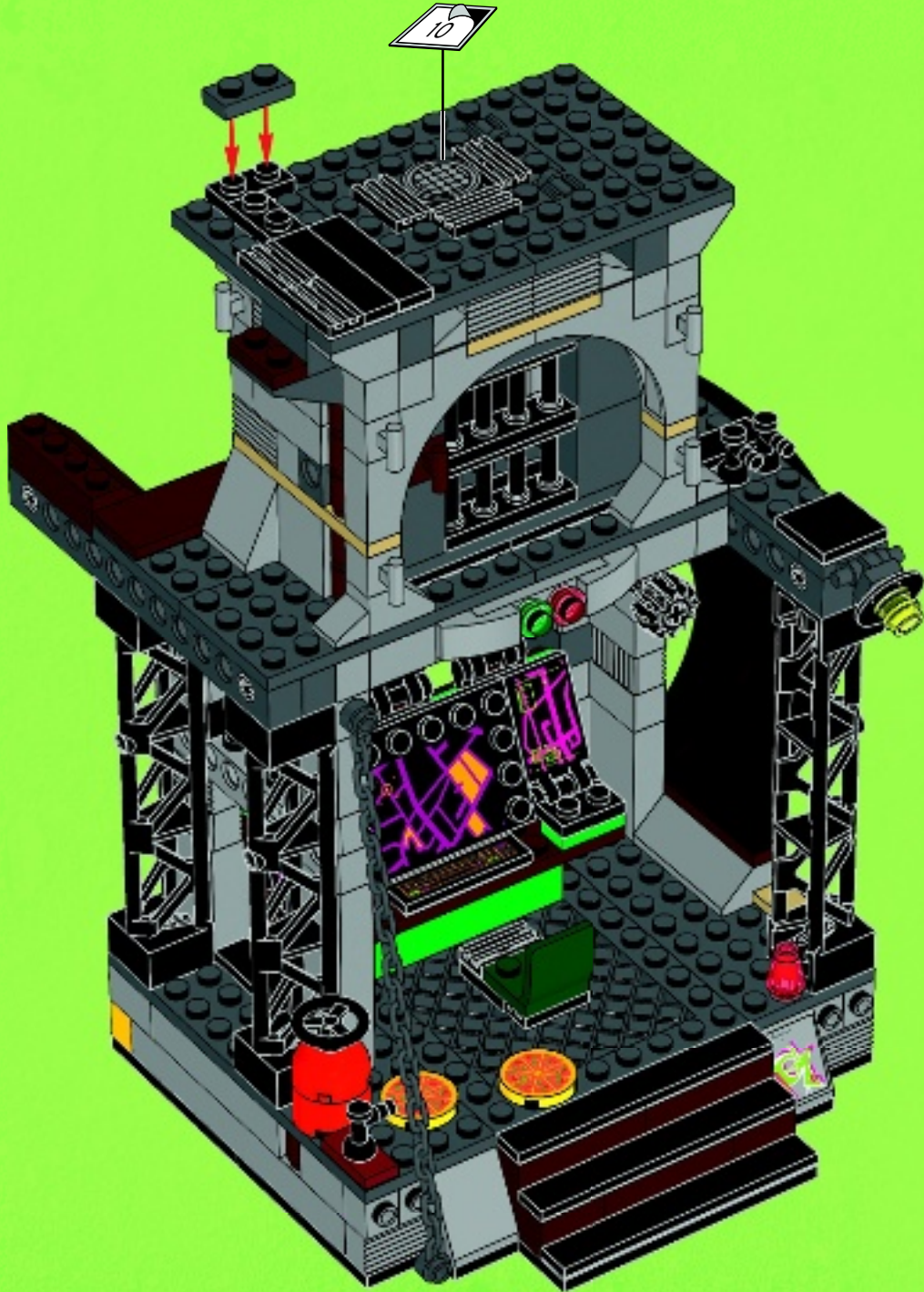



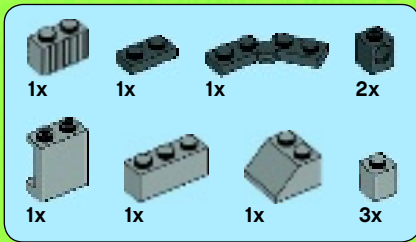

# 65

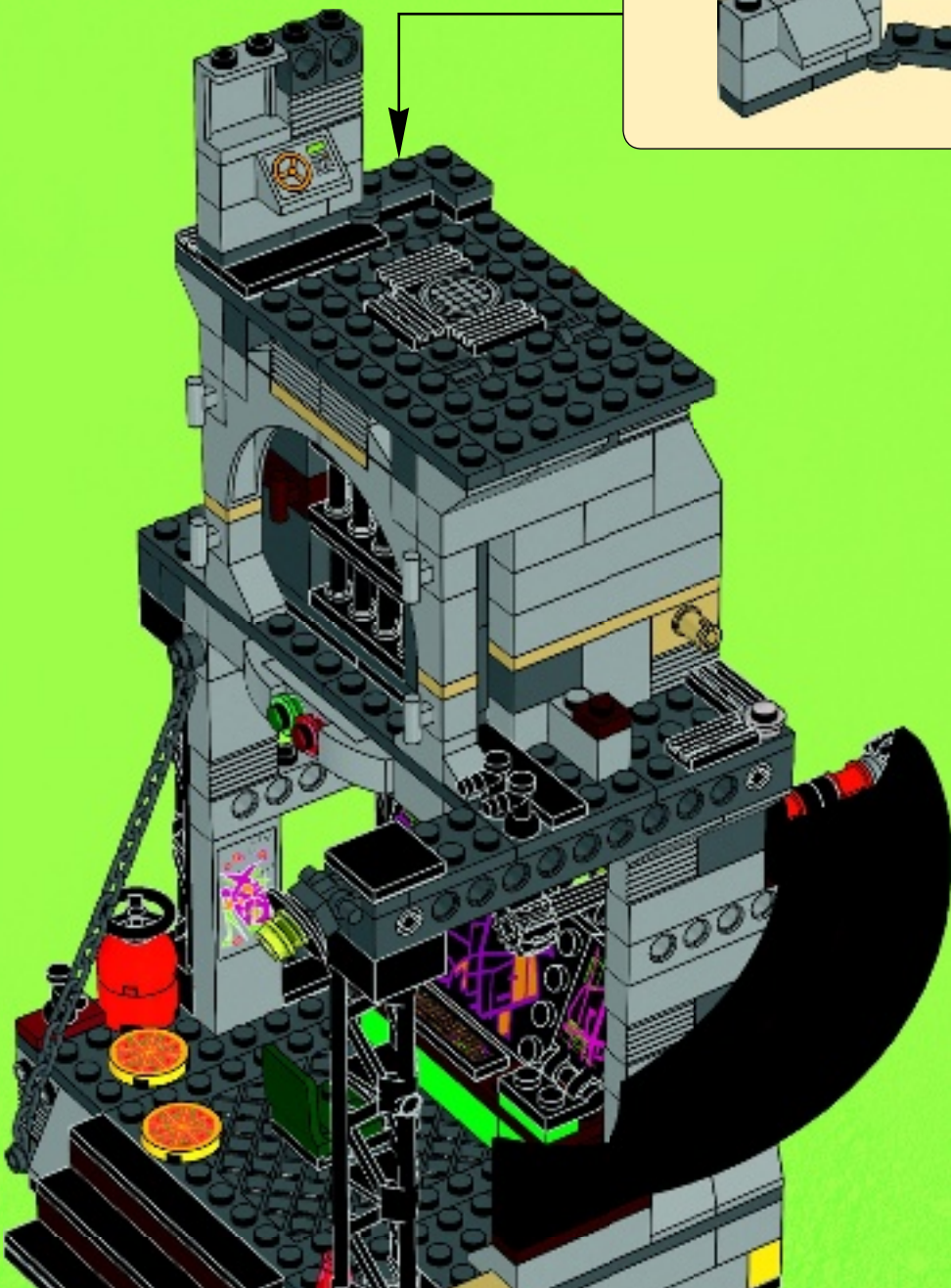
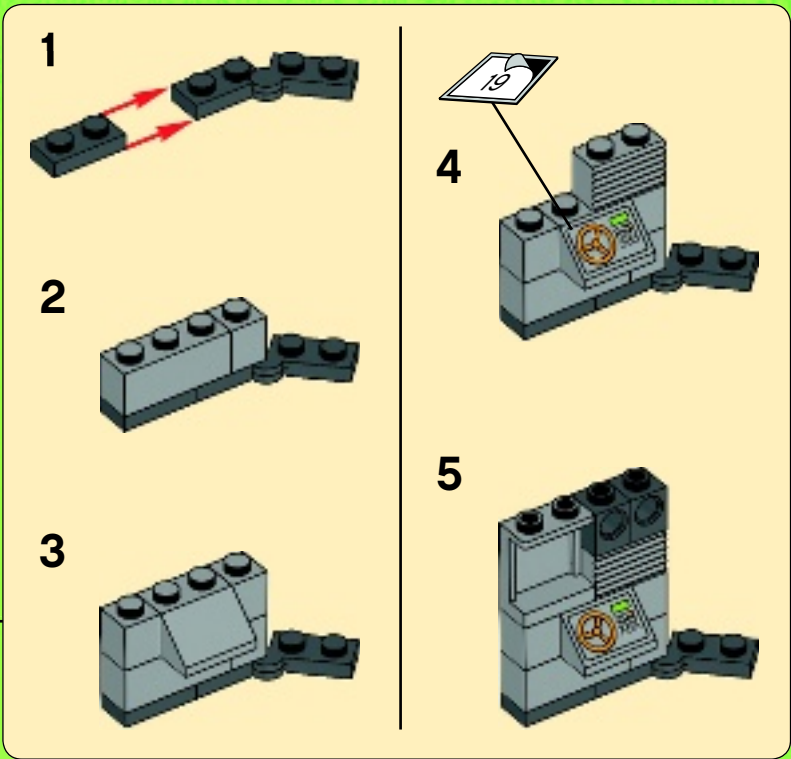





1x



1x

# 66

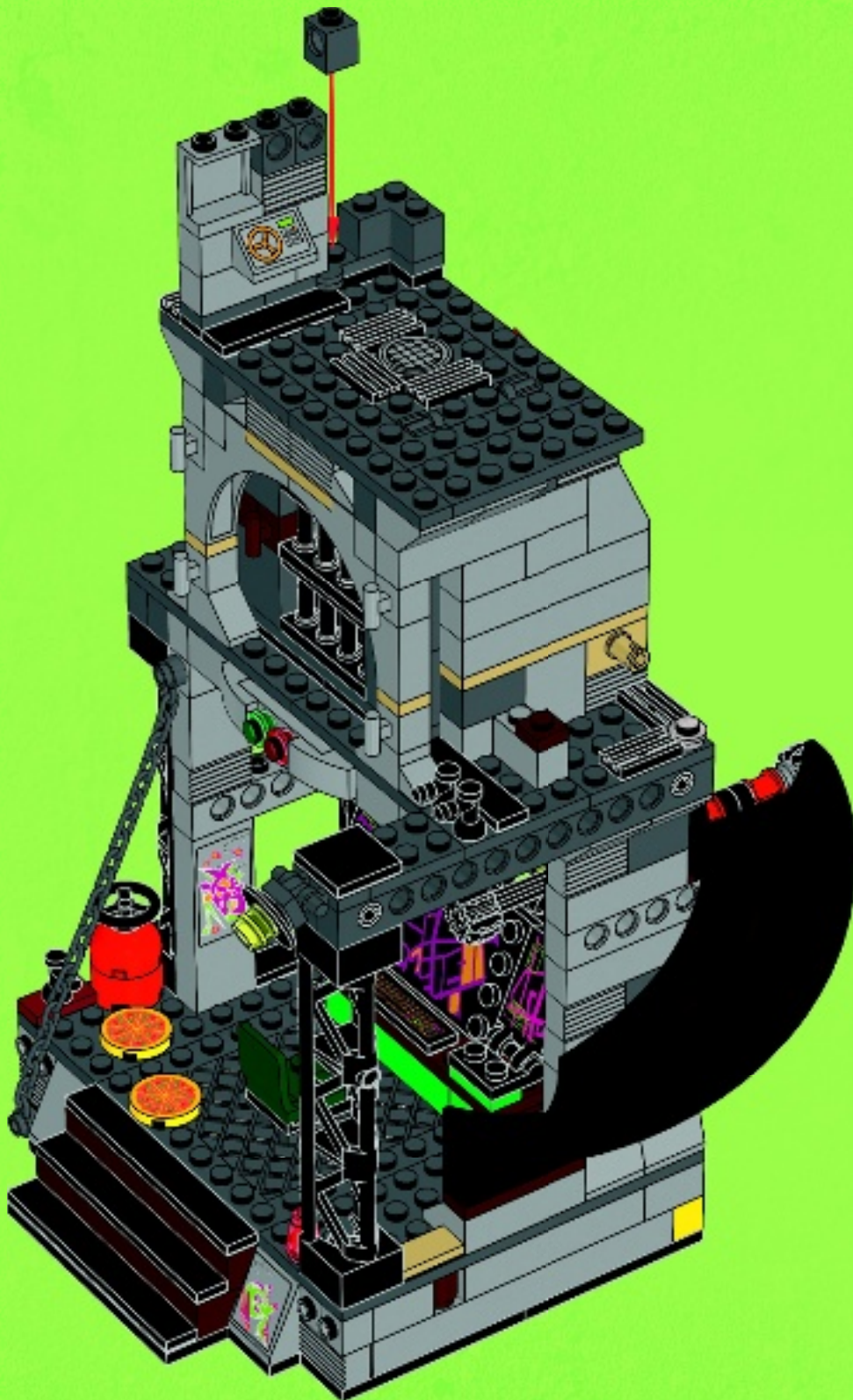





1x



1x

# 67

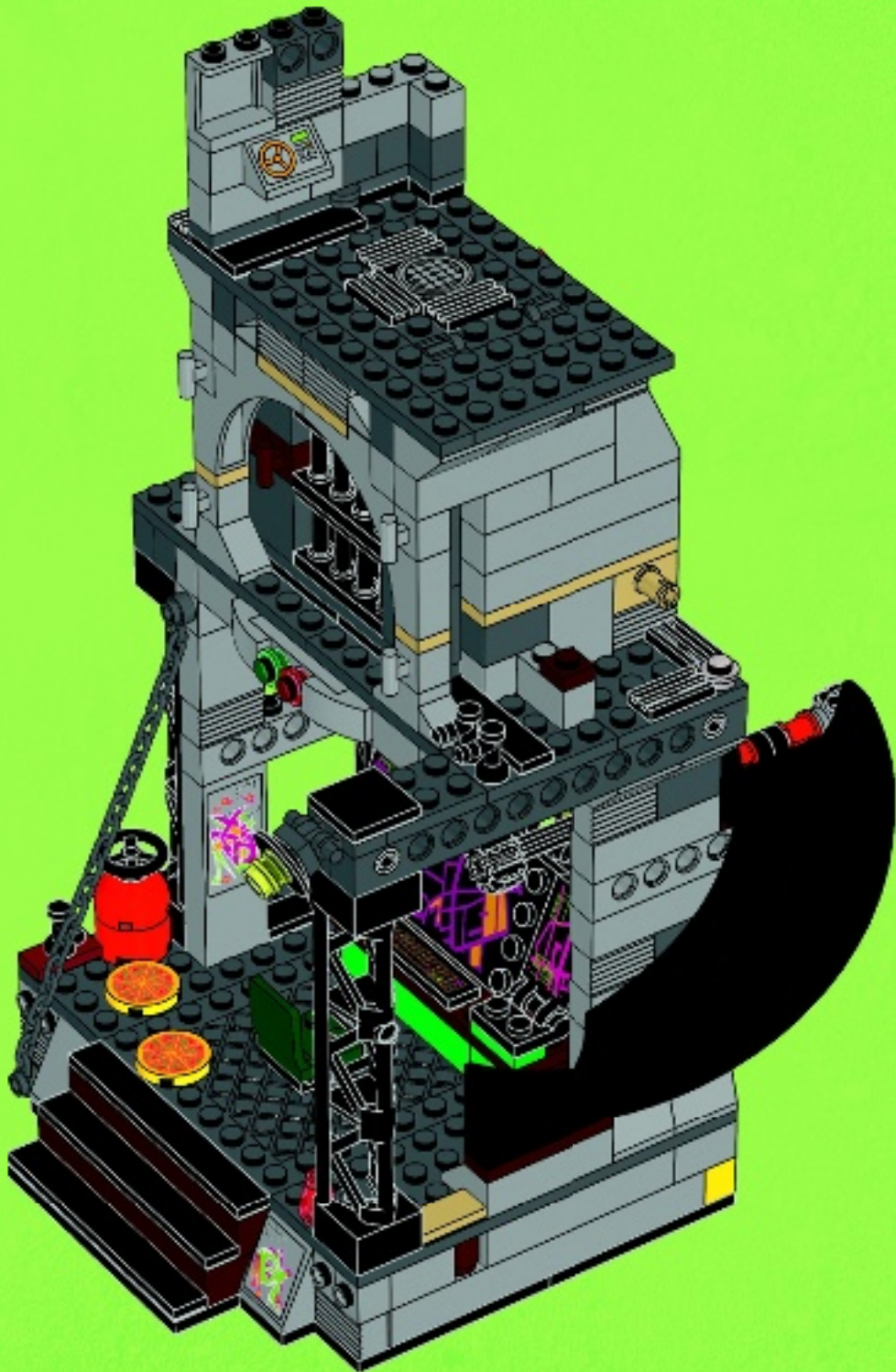





2x

68

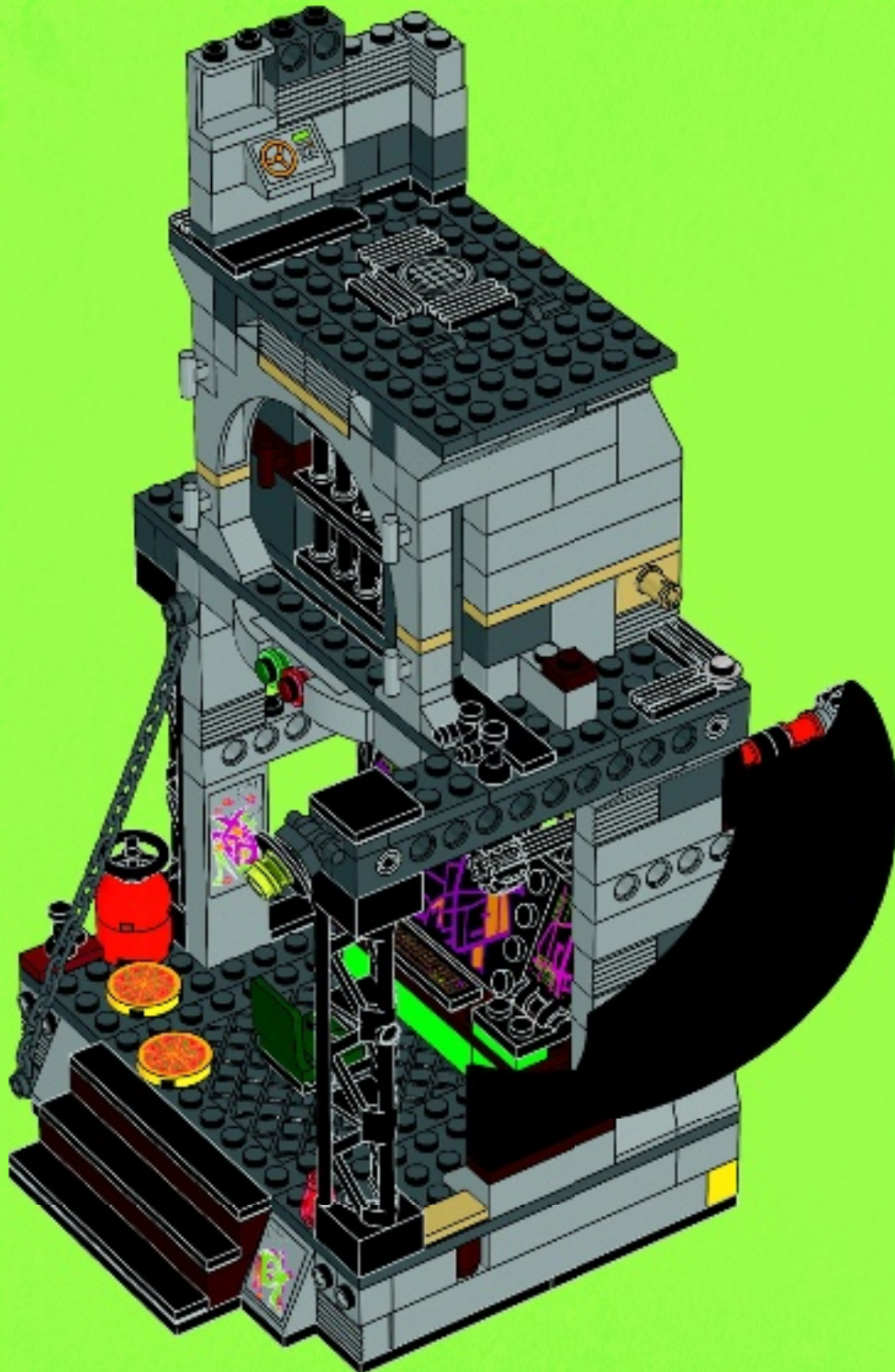





1x



1x

# 69

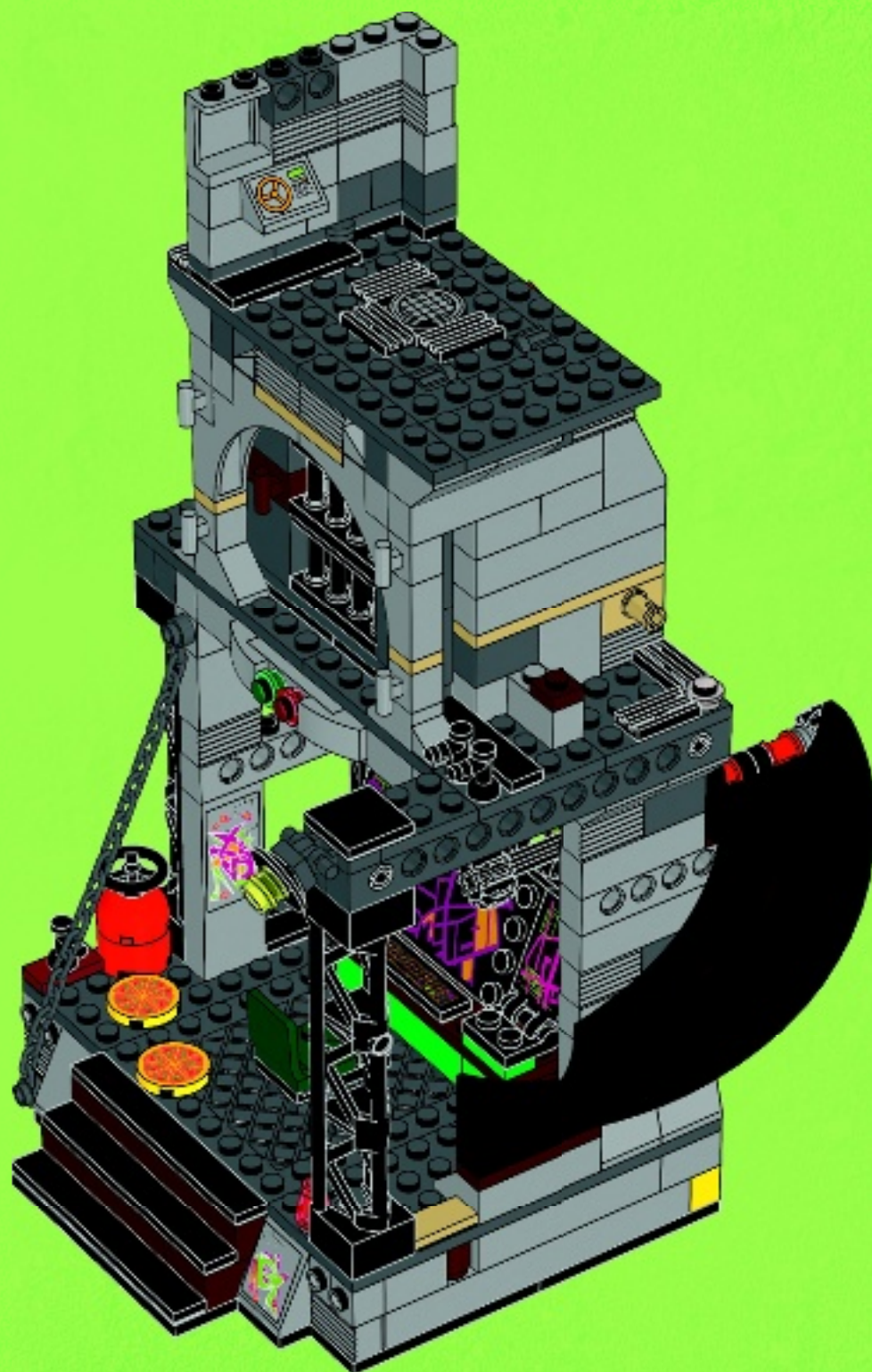





2x



1x

# 70

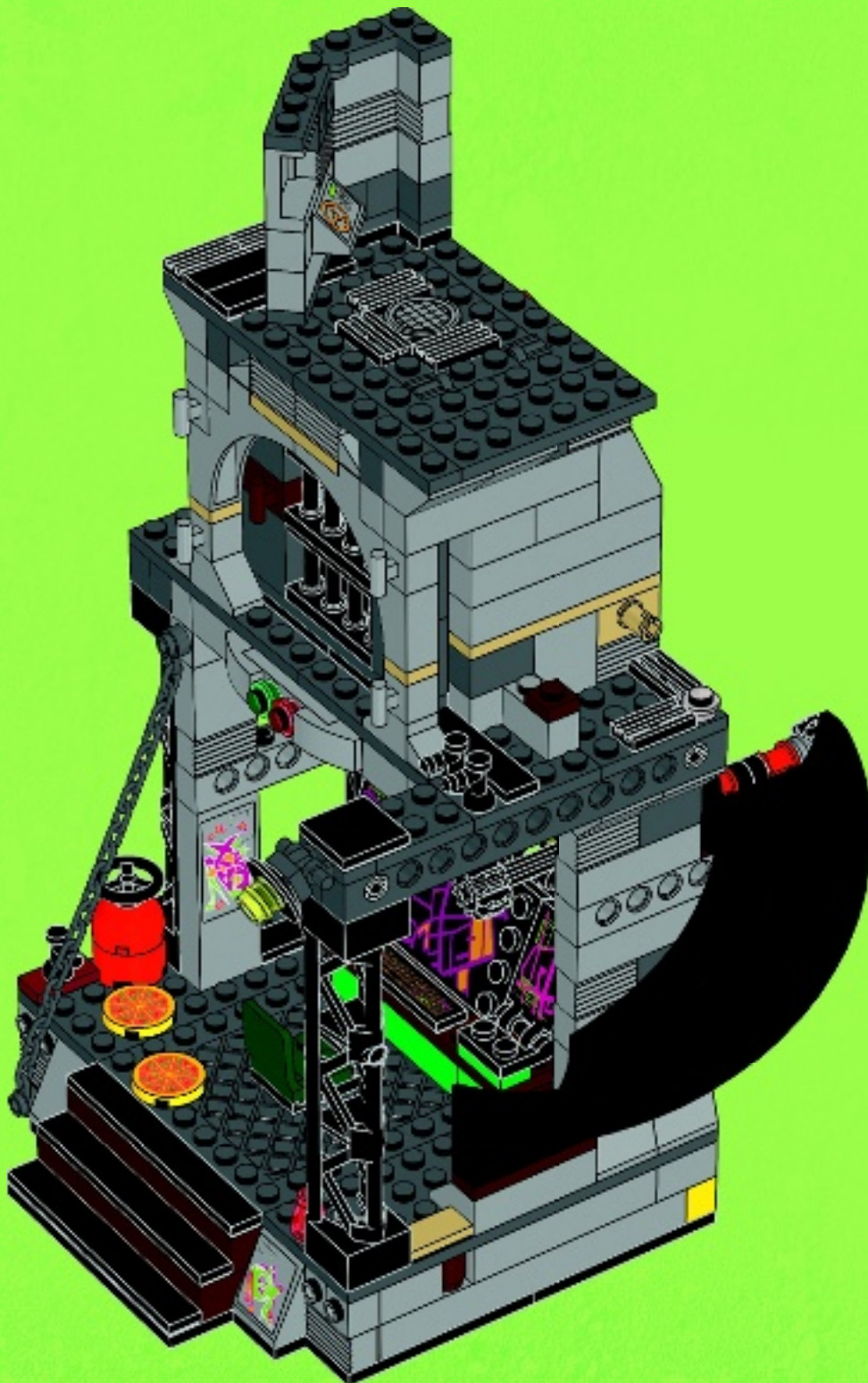



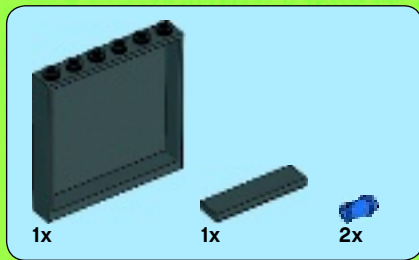

71

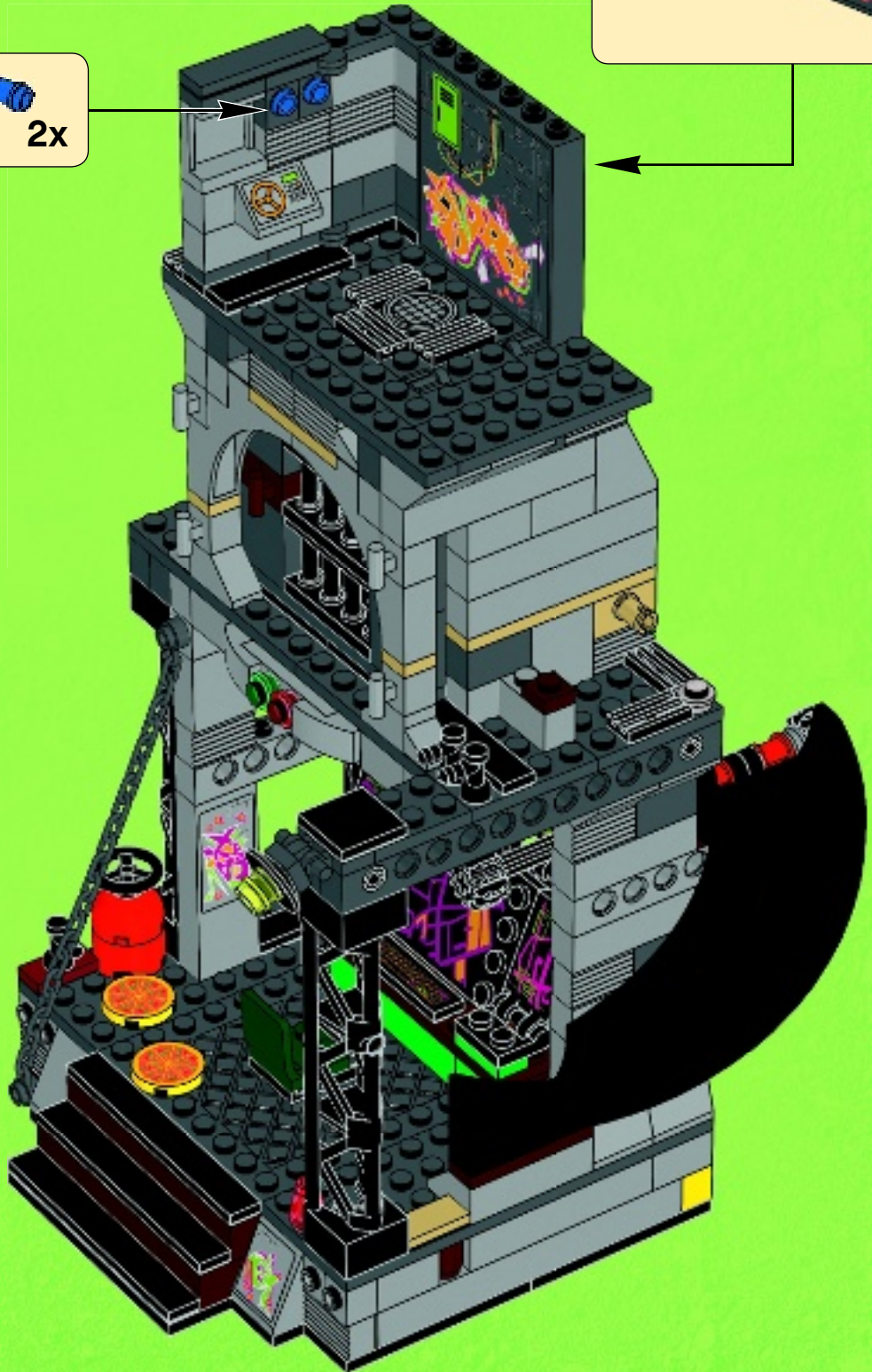
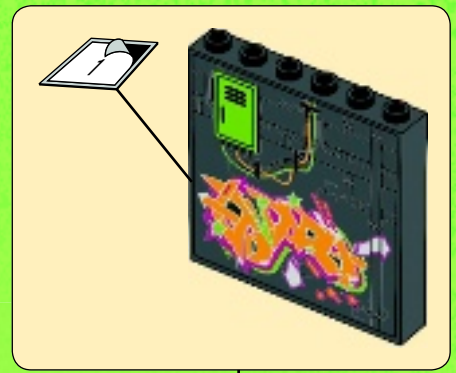



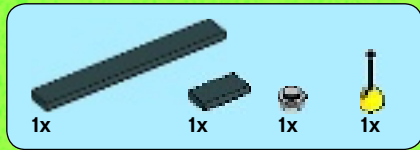

72

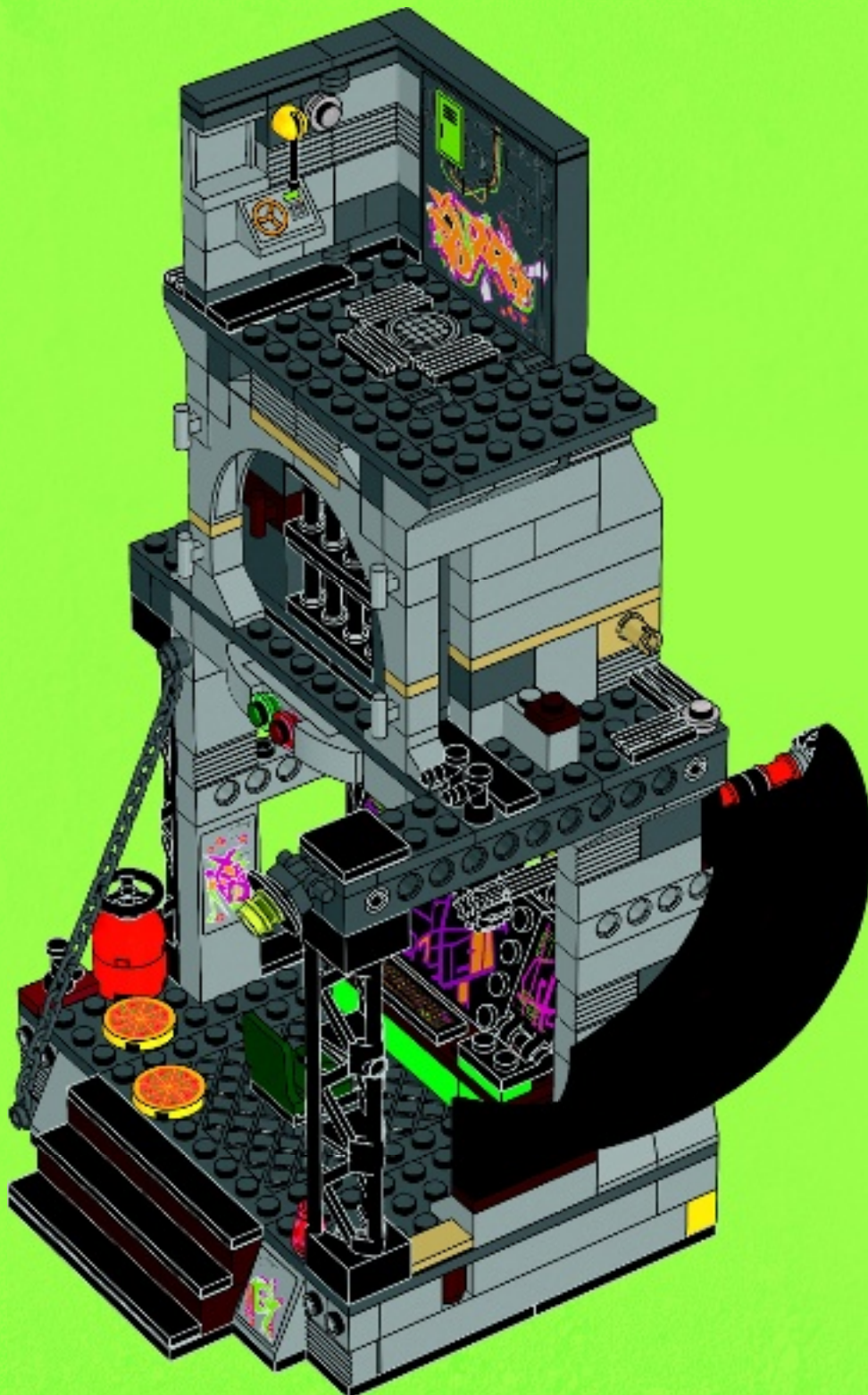



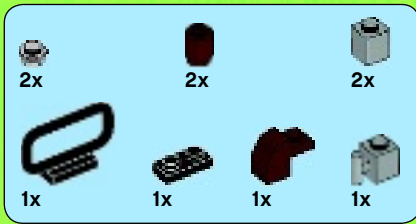

73

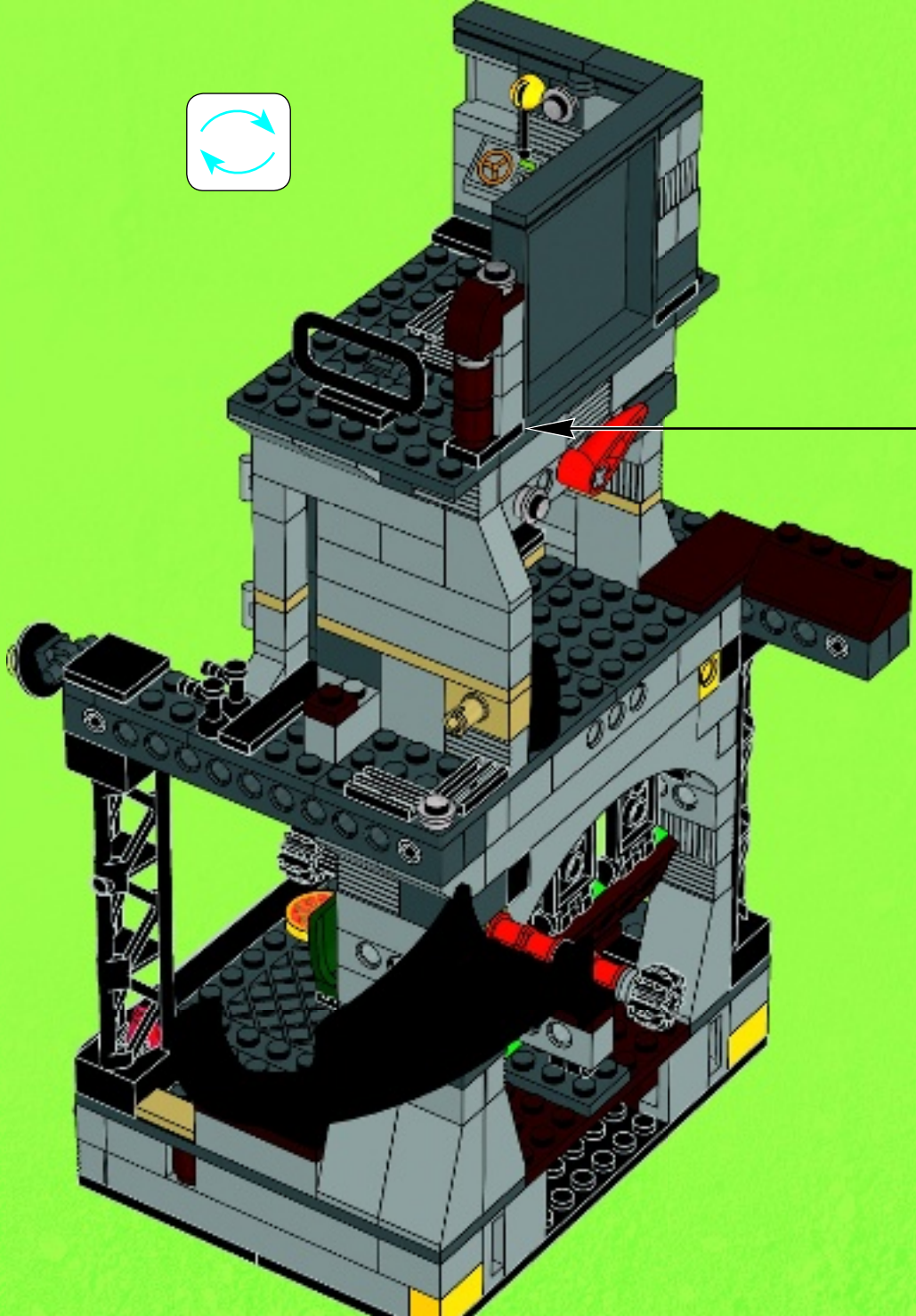
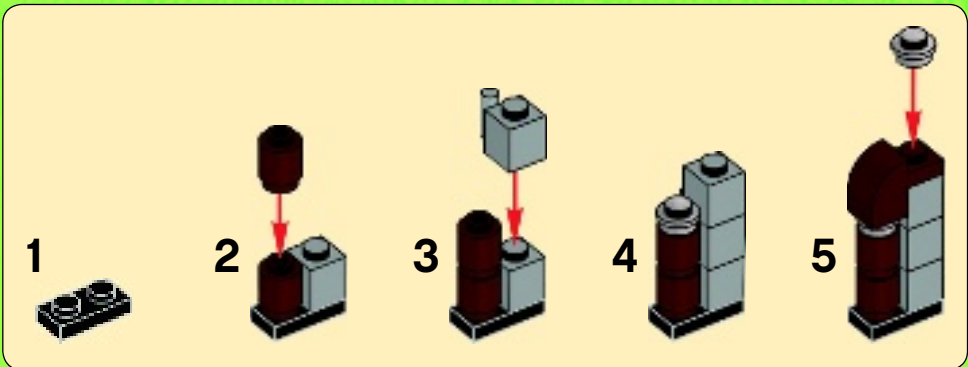



-  1x
-  1x
-  1x
-  1x

# 74

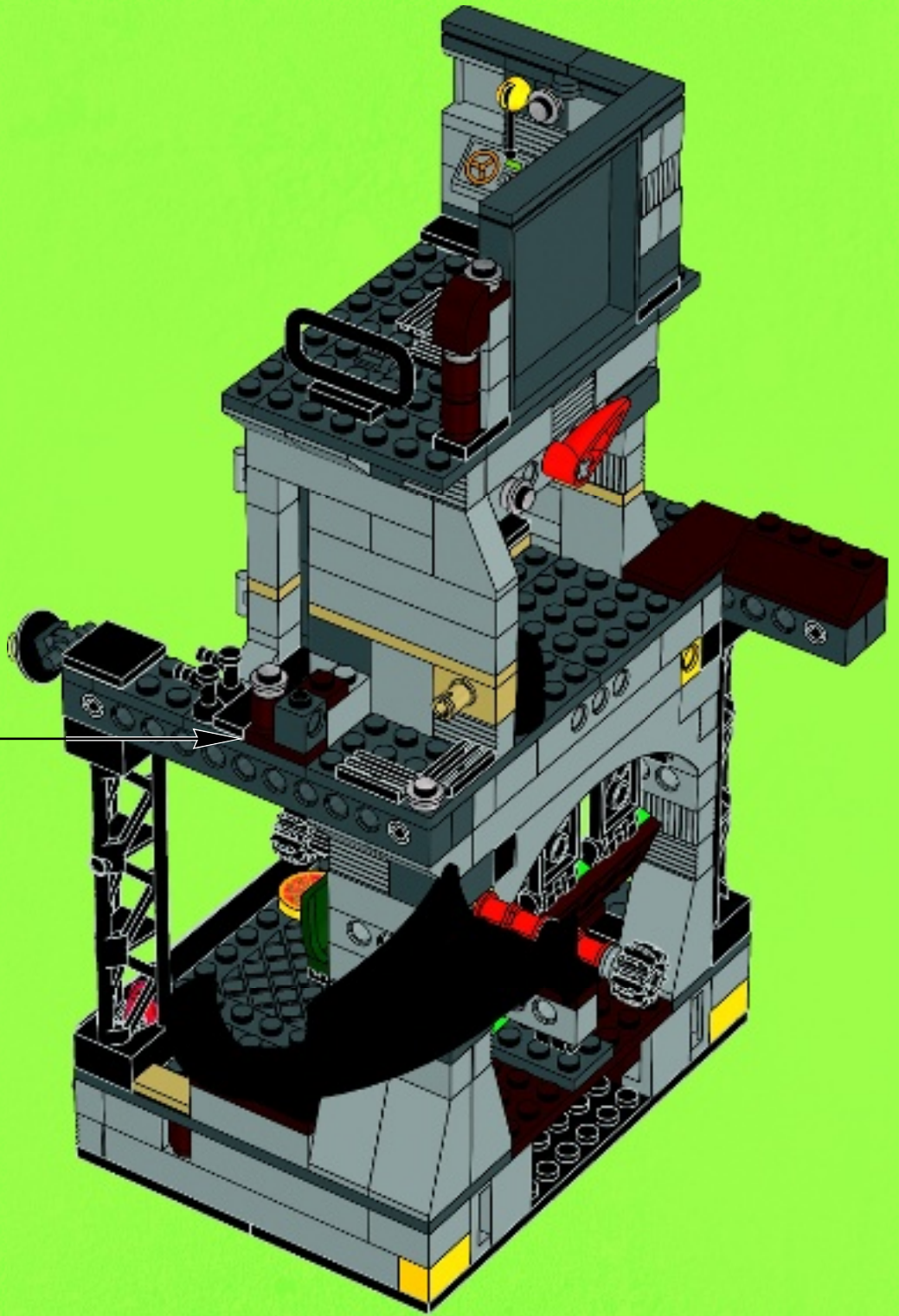

- 1 
- 2 



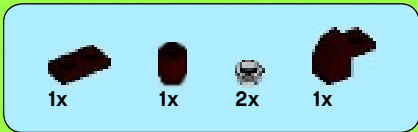

# 75

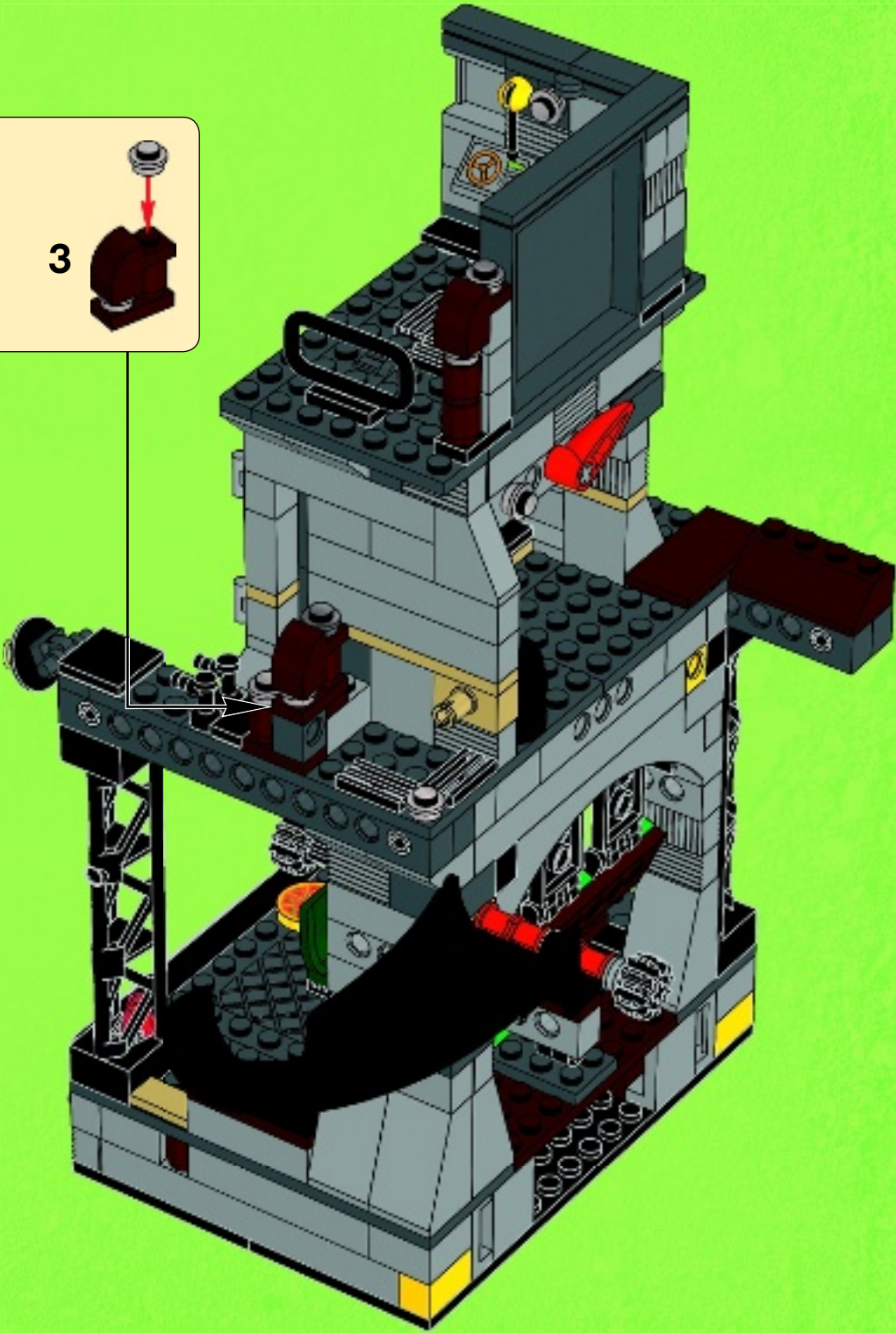





1x



1x



1x

# 76

1

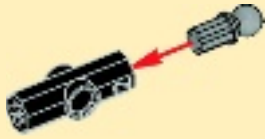

2

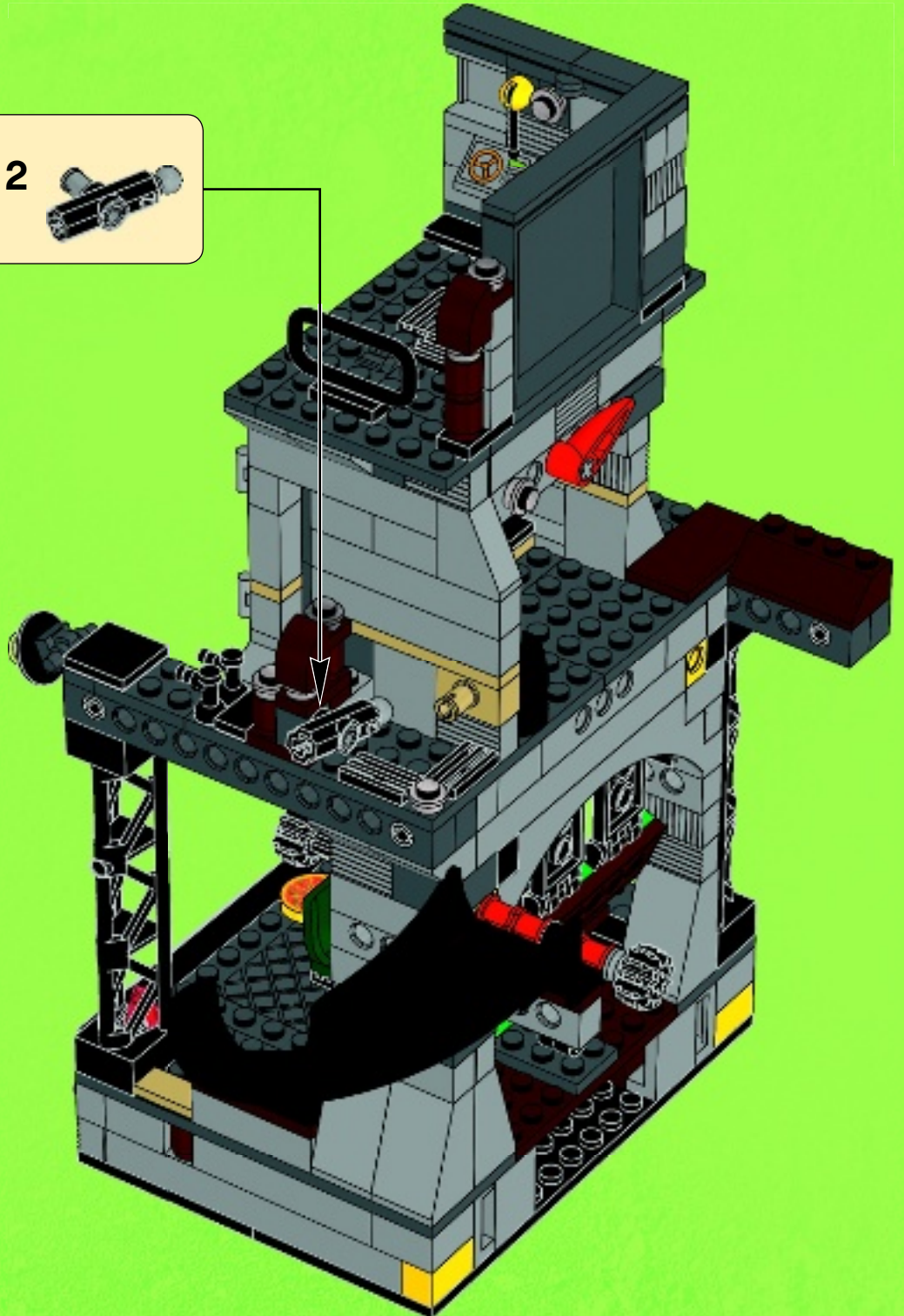
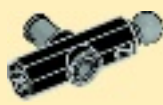



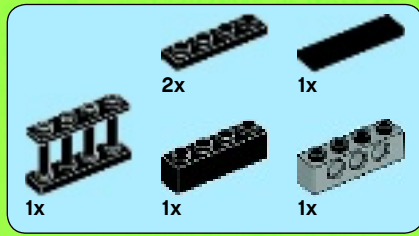

77

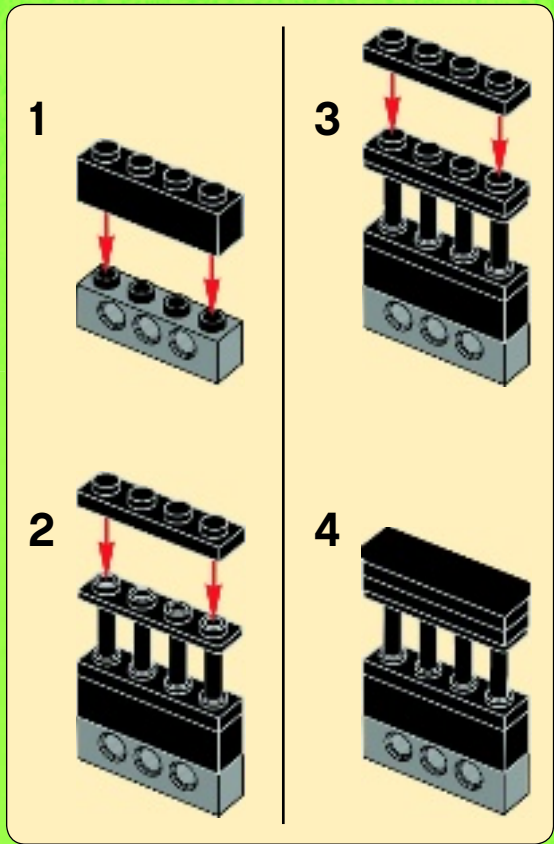
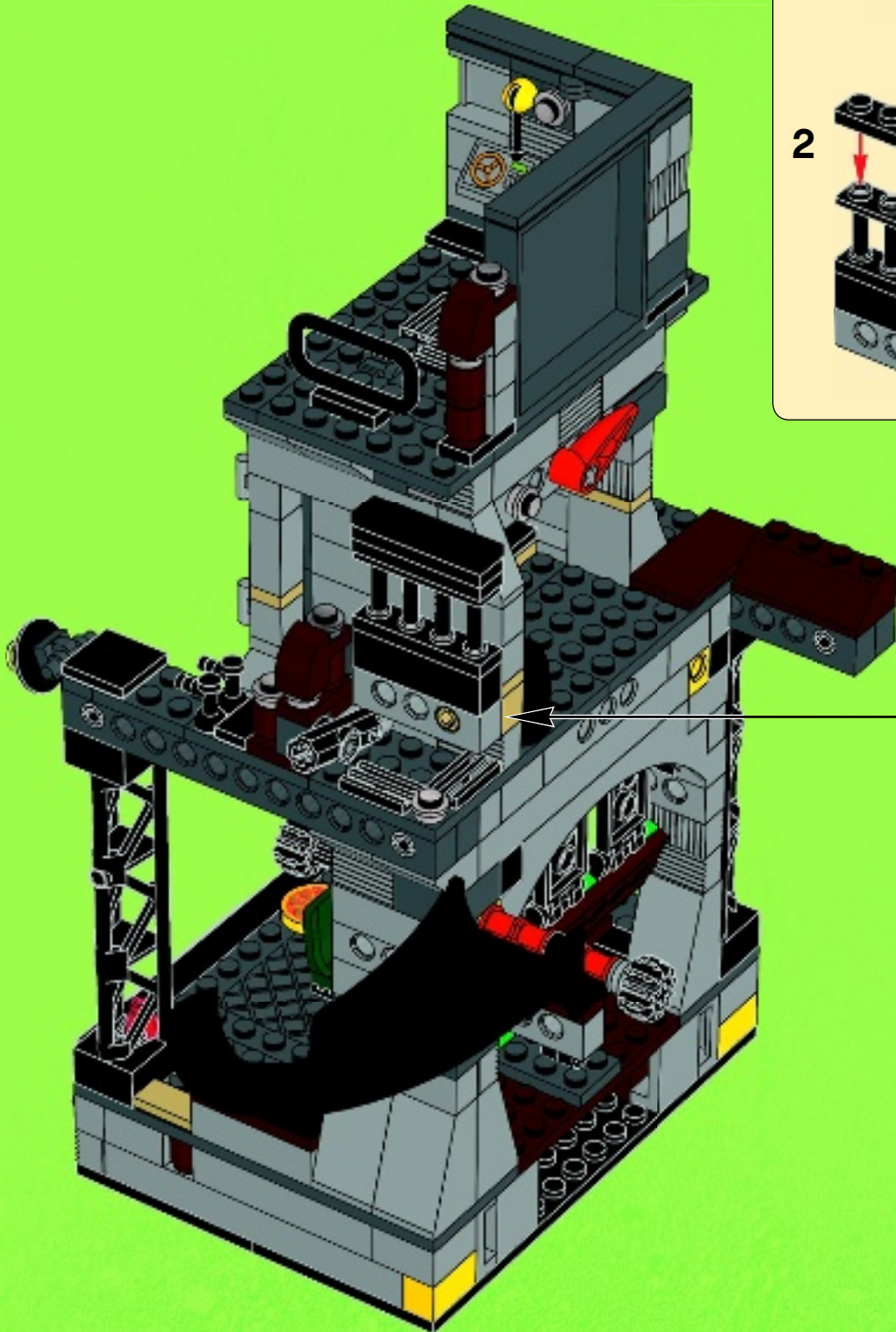



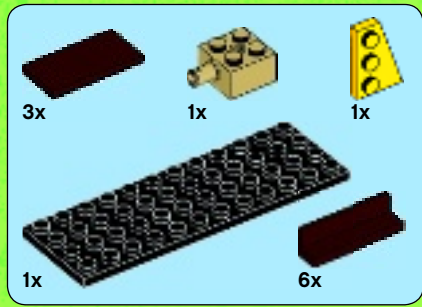

# 78

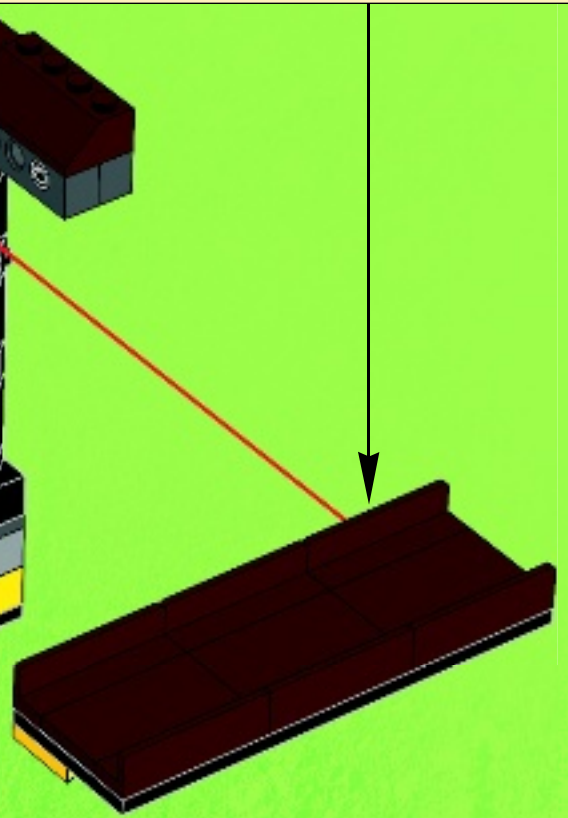
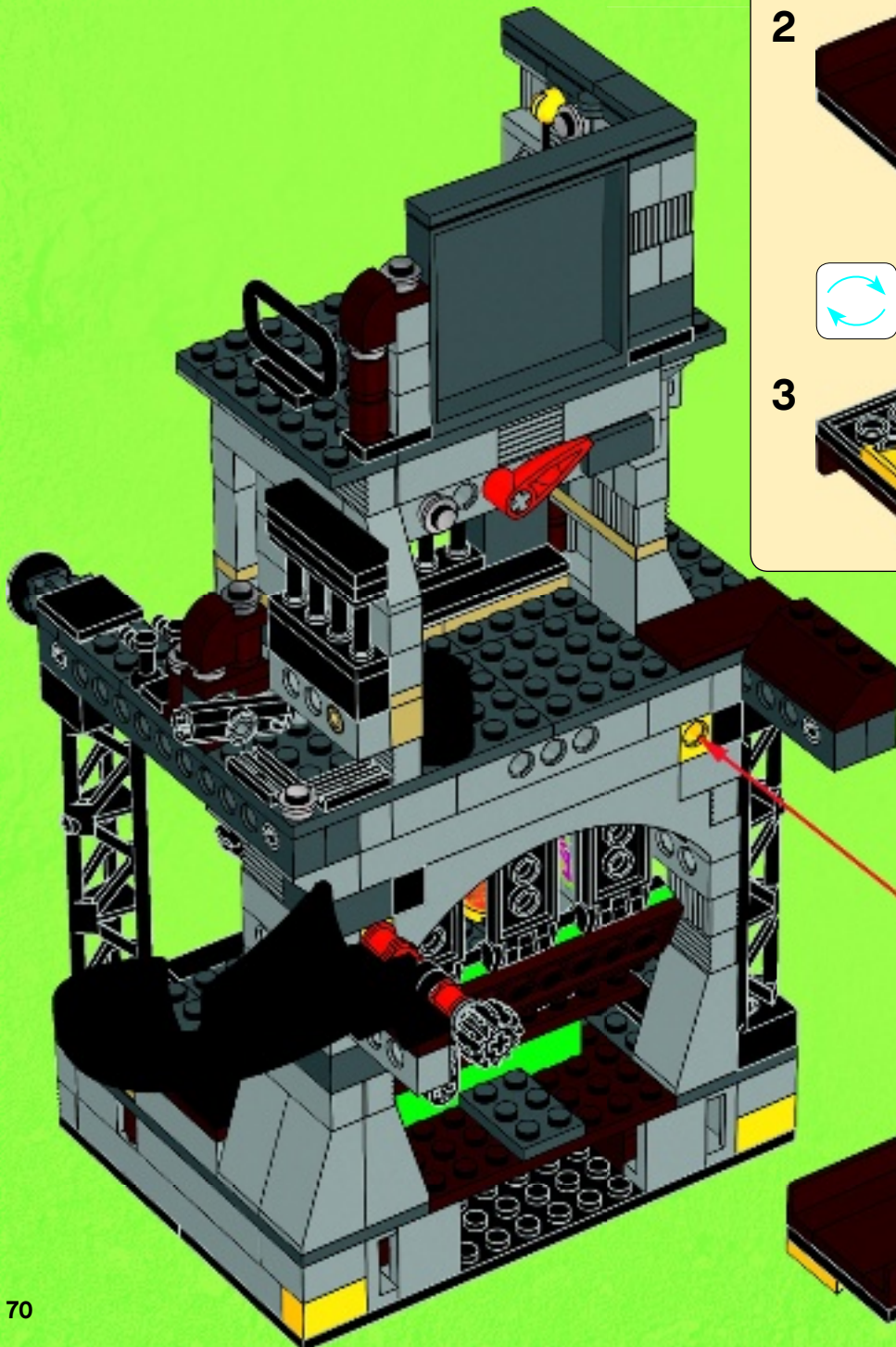



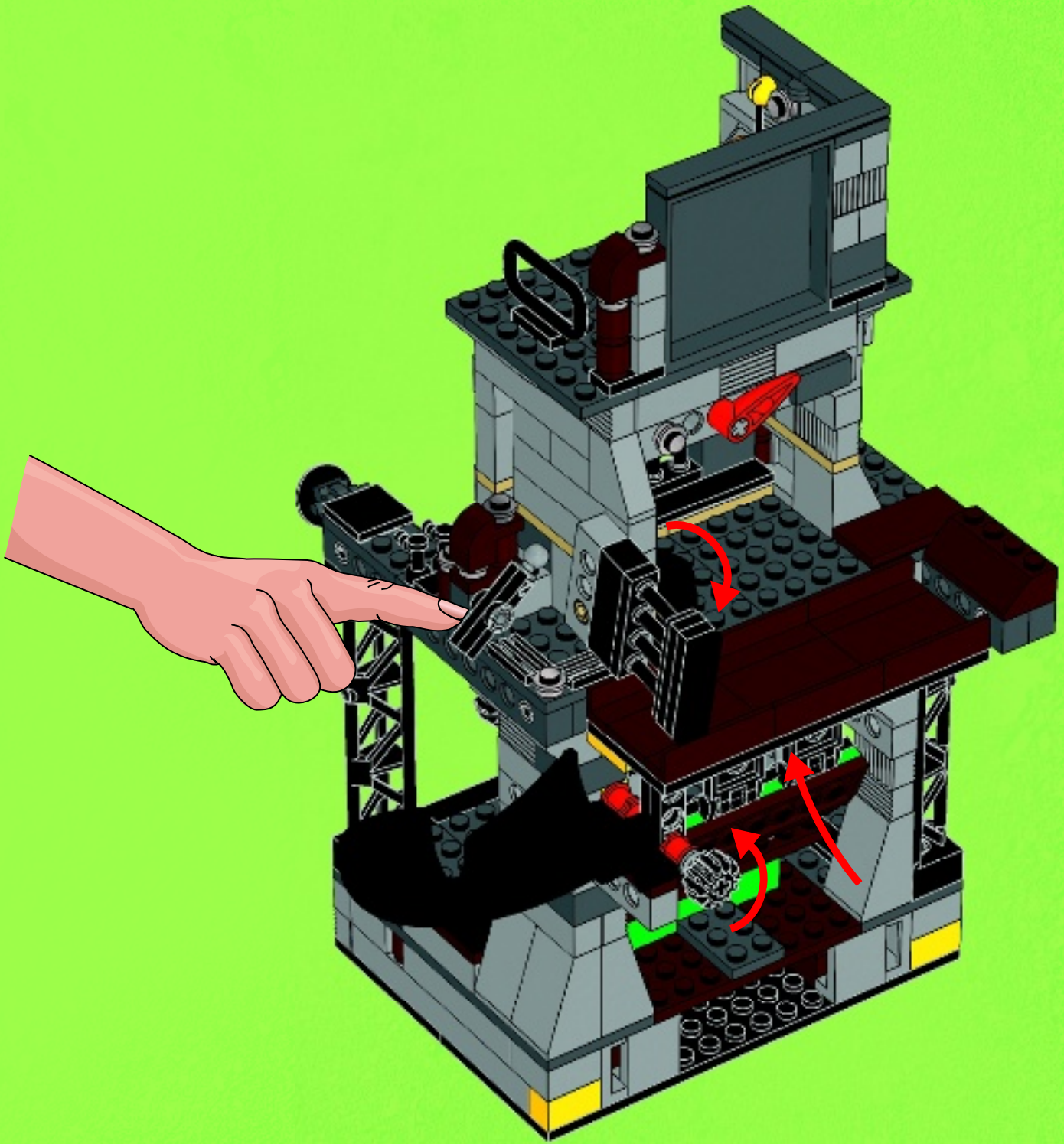



- 1x 
- 1x 
- 1x 
- 1x 

# 79

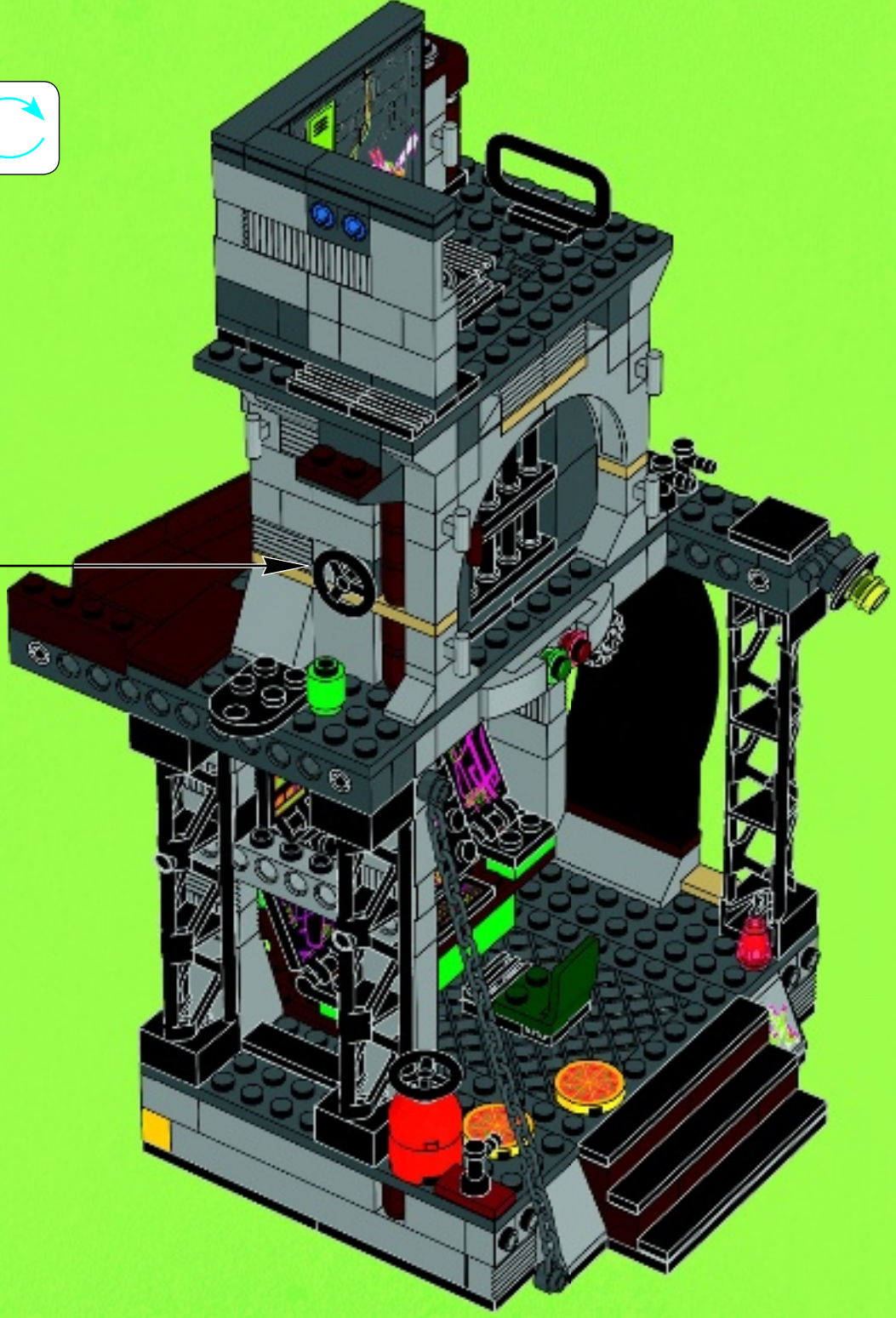
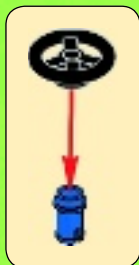





1x



1x

# 80

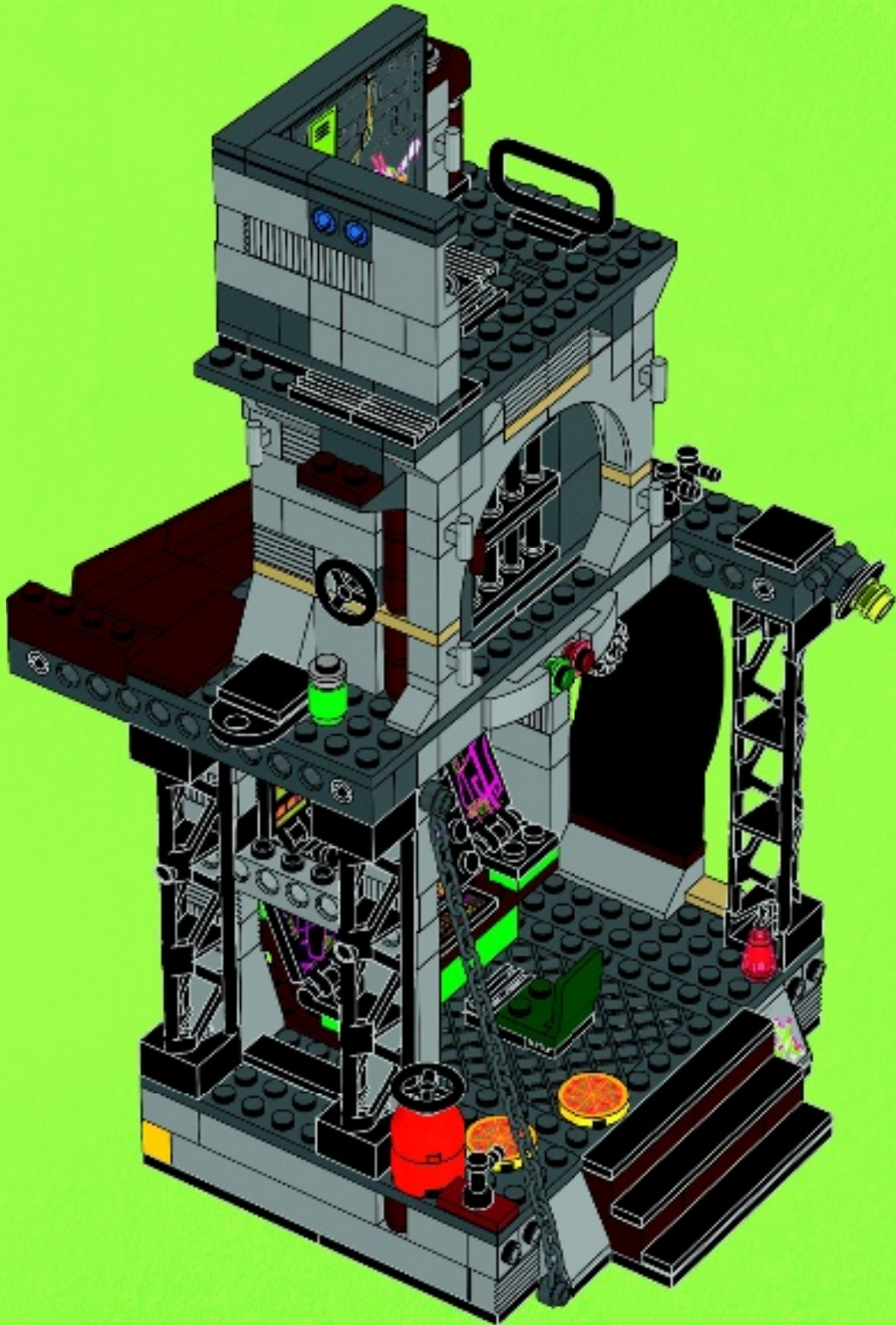



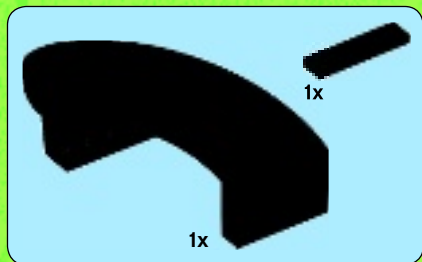

# 81

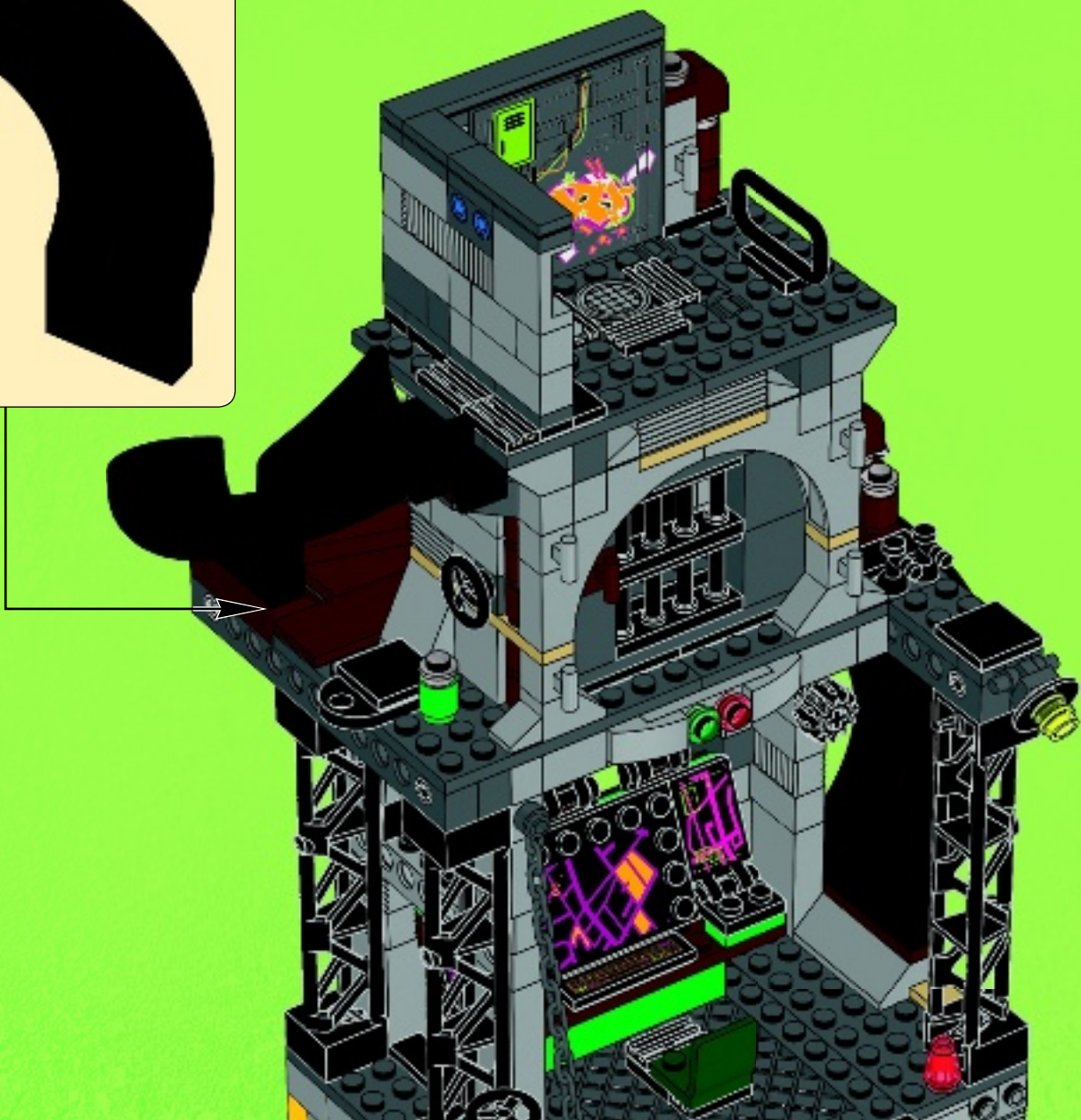
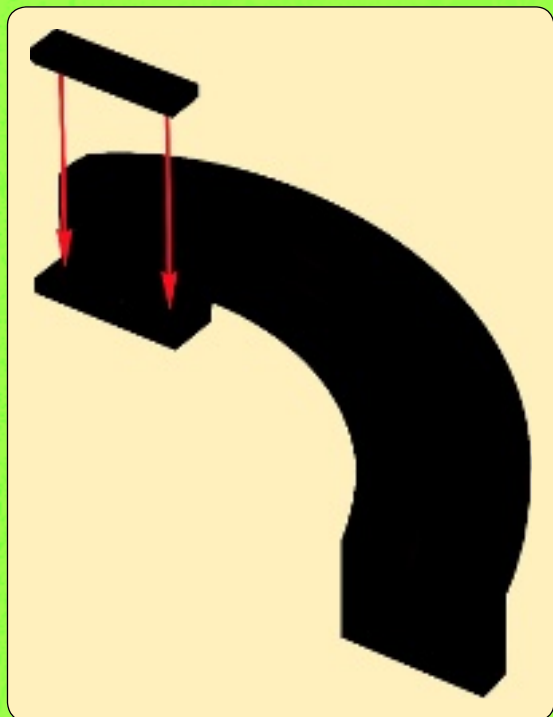



79115



79116



79117















1x 6024596  
 1x 4205105  
 1x 4185273  
 1x 4159553  
 1x 4114026  
 8x 4113917  
 3x 4113233  
 2x 4124067  
 1x 4507055  
 1x 4216657  
 1x 614321  
 2x 370021  
 2x 302321  
 1x 4588003  
 1x 4254591  
 1x 4227649  
 2x 4185661  
 3x 4227155  
 2x 4526984  
 1x 4538760

1x 4172695  
 8x 4143005  
 8x 300424  
 4x 654124  
 2x 81867  
 1x 4179094  
 1x 74156  
 4x 300526  
 4x 300326  
 1x 301026  
 3x 300126  
 1x 4233487  
 2x 654126  
 1x 370026  
 2x 4504382  
 2x 366026  
 4x 4581280  
 4x 302426  
 6x 307026  
 23x 241226

2x 370526  
 1x 370626  
 1x 370826  
 4x 663626  
 6x 416226  
 1x 4100378  
 1x 303426  
 1x 303526  
 1x 383226  
 1x 4514845  
 1x 303026  
 2x 302926  
 2x 345626  
 2x 302726  
 1x 6078308  
 1x 6083606  
 2x 6078030  
 1x 6058150  
 2x 4128593  
 1x 6078311

2x 4569733  
 5x 4225201  
 4x 4535739  
 2x 317626  
 2x 3004326  
 5x 4297713  
 3x 4180508  
 5x 4180536  
 5x 474026  
 3x 459926  
 3x 4141349  
 3x 6066113  
 4x 302326  
 9x 306826  
 8x 4121715  
 2x 4177431  
 2x 6078024  
 1x 6055612  
 1x 4538456  
 2x 249626

2x 6064174  
 3x 6057397  
 1x 6055123  
 7x 4667463  
 2x 368026  
 2x 4142236  
 1x 4580509  
 1x 4107783  
 1x 4107085  
 5x 243126  
 2x 371026  
 4x 302026  
 1x 4560182  
 1x 6070219  
 1x 6070369  
 1x 4163533

1x 4181135  
 1x 306228  
 2x 4522678  
 8x 302428  
 1x 379428  
 2x 302328  
 3x 302228  
 1x 4565321  
 2x 4107758  
 1x 302128  
 1x 371028  
 8x 4521931  
 1x 6030306  
 1x 4544720  
 4x 3000841  
 2x 3005741  
 1x 6022171  
 1x 3005748  
 10x 3005749  
 3x 4496699  
 1x 4539063

1x 4221590  
 2x 4216668  
 7x 4211201  
 1x 4216615  
 4x 4225823  
 30x 4211183  
 1x 4211205  
 6x 6035547  
 5x 4221744  
 2x 4211190  
 4x 4211150  
 4x 4579690  
 2x 4211257  
 3x 4211186  
 9x 4271949  
 3x 4211189  
 2x 6030330  
 1x 4544525  
 6x 4565214  
 2x 6030812



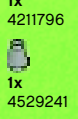
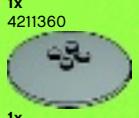
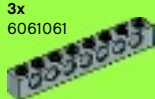
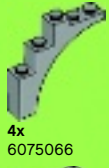
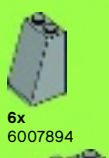
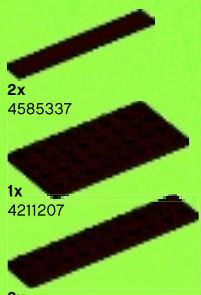

**Customer Service**  
**Kundenservice**  
**Service Consommateurs**  
**Servicio Al Consumidor**

[LEGO.com/service](http://LEGO.com/service) or dial



: 00800 5346 5555  
 : 1-800-422-5346





**LEGO.com/turtles**

LEGO and the LEGO logo are trademarks of the LEGO Group. ©2014 The LEGO Group.  
 ©2014 Viacom Overseas Holdings C.V. All Rights Reserved. Nickelodeon, Teenage Mutant Ninja Turtles and all related titles, logos and characters are trademarks of Viacom Overseas Holdings C.V. turtles.nicktv  
 ©2014 Paramount Pictures. All Rights Reserved. Nickelodeon and "NINJA TURTLES" are trademarks of Viacom Overseas Holdings C.V. 6090123

