

1

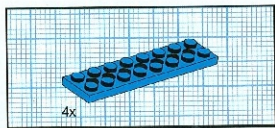

2

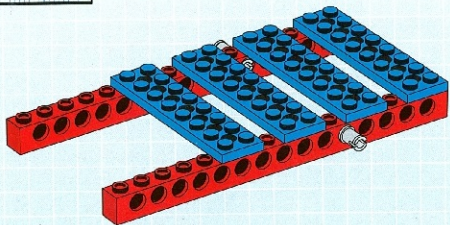

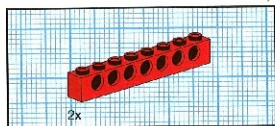

3

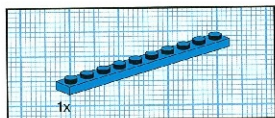
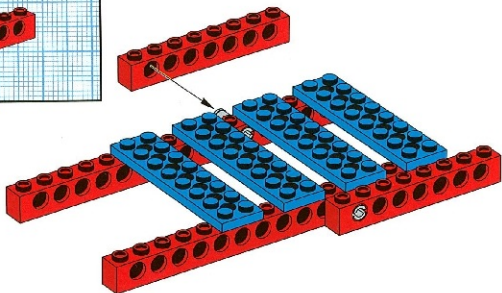

4

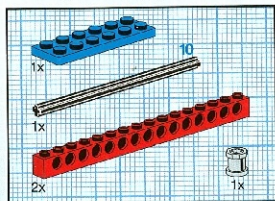
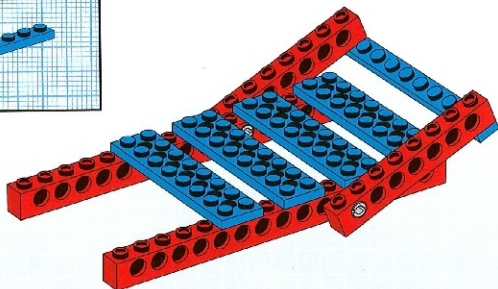

5

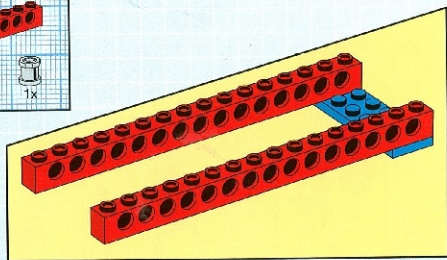

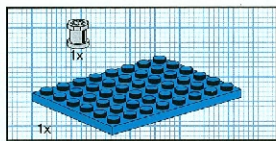
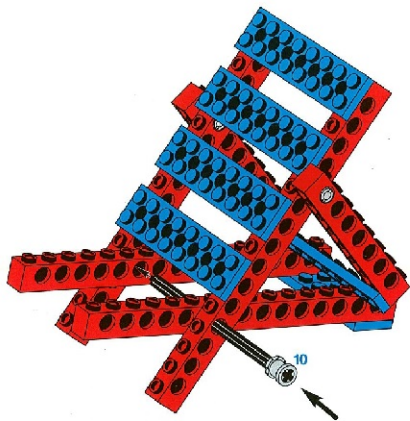

6

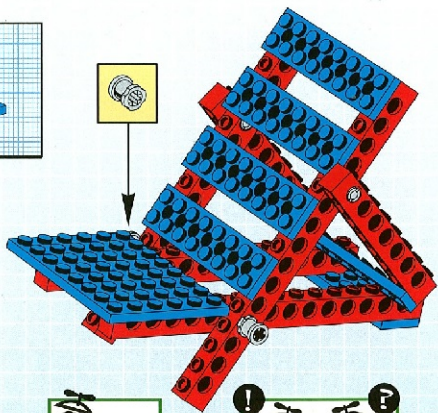

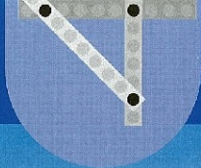

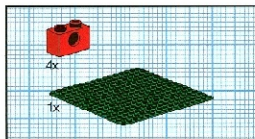
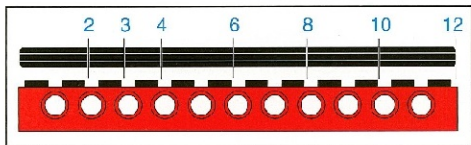

1

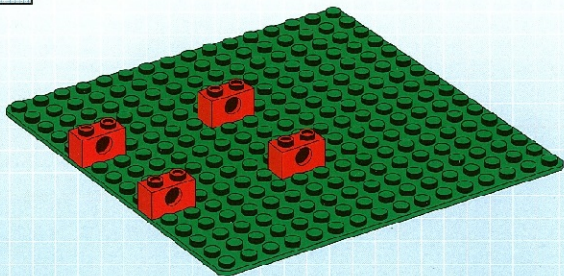

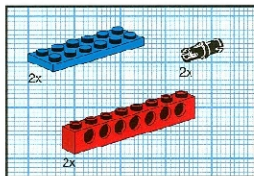

2

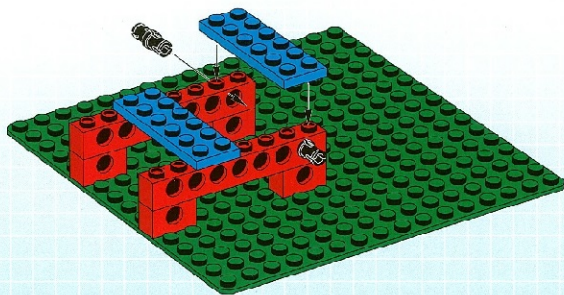

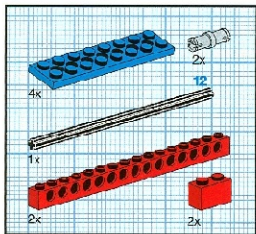

3

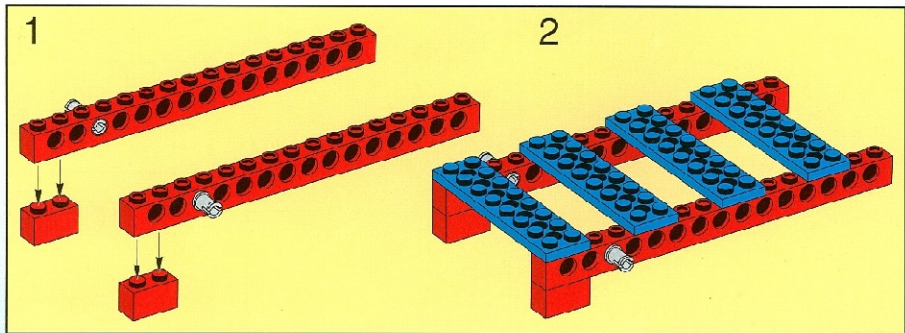

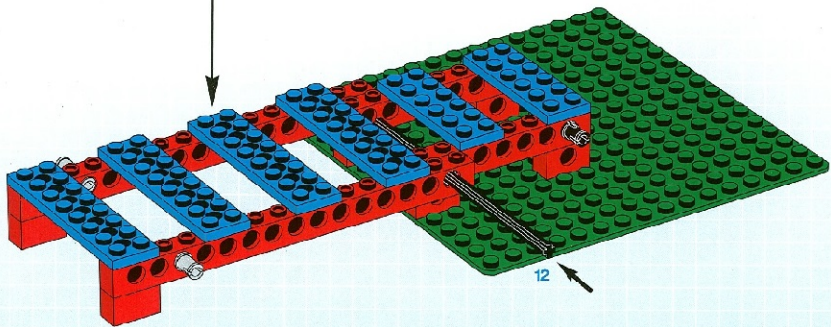

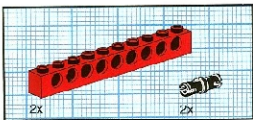

4

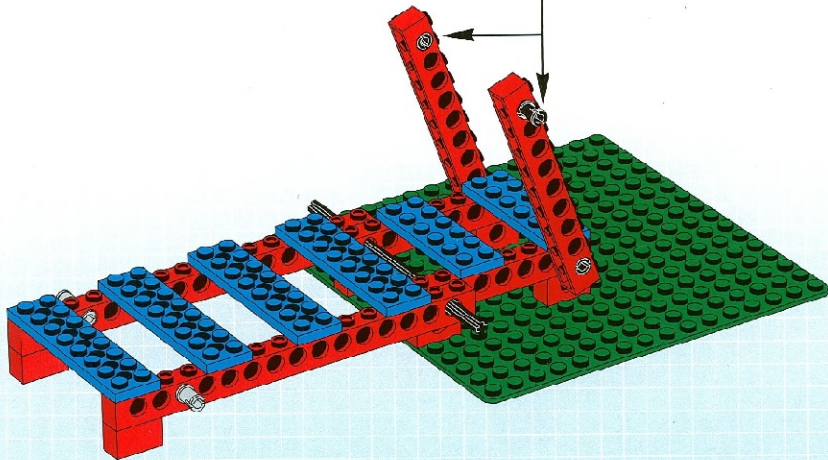

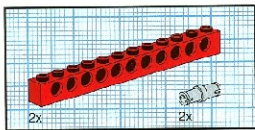

5

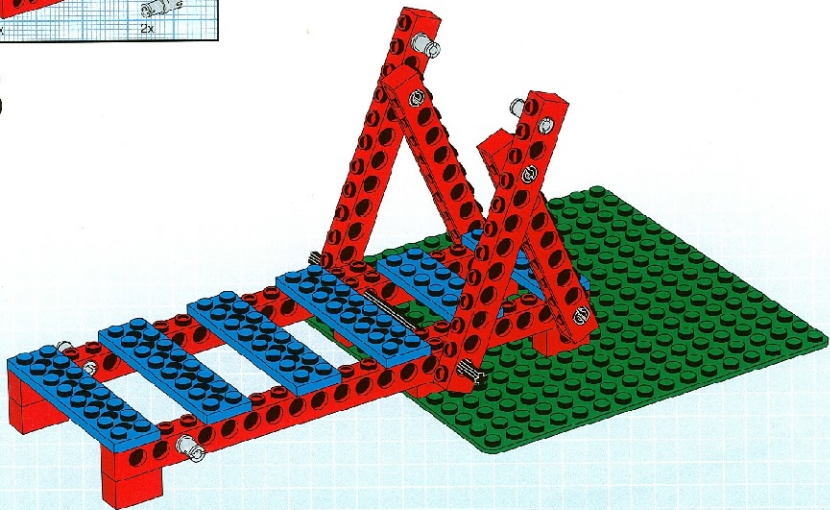

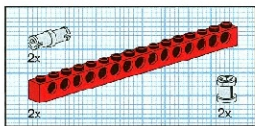

6

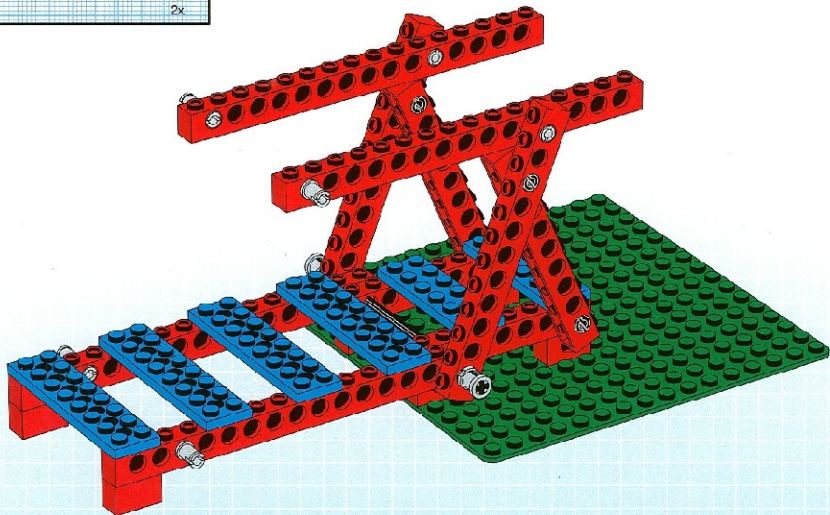

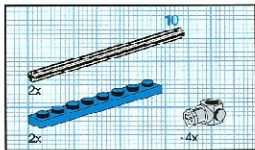

7

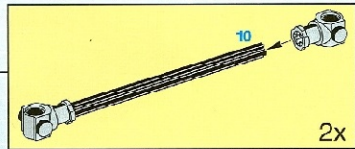
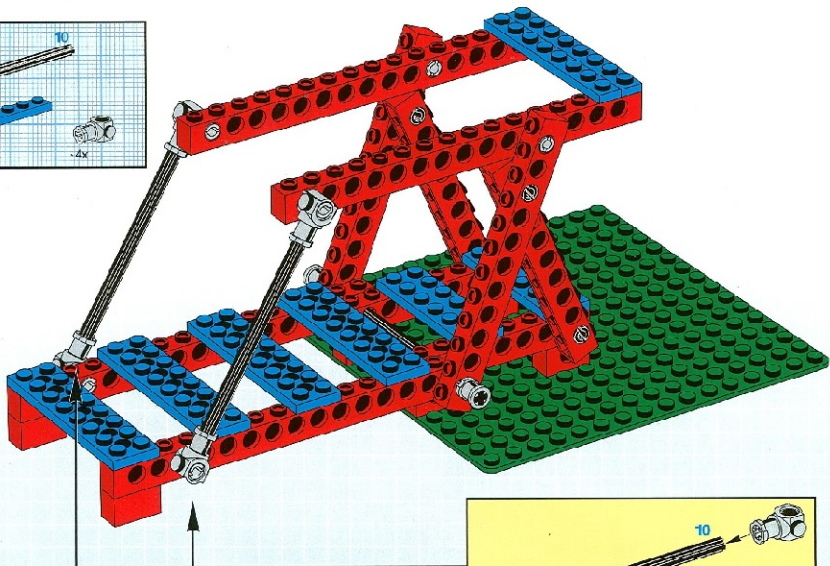



8

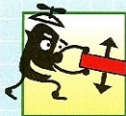
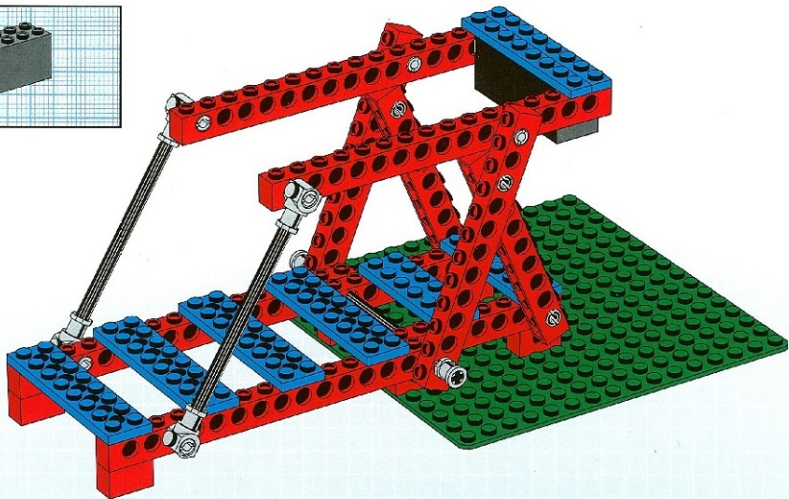



9

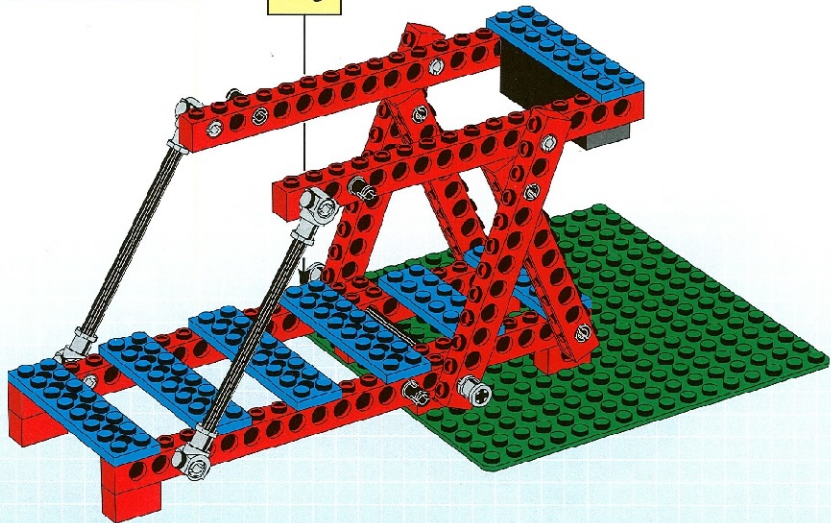

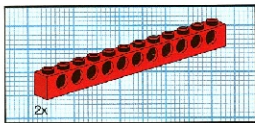

10

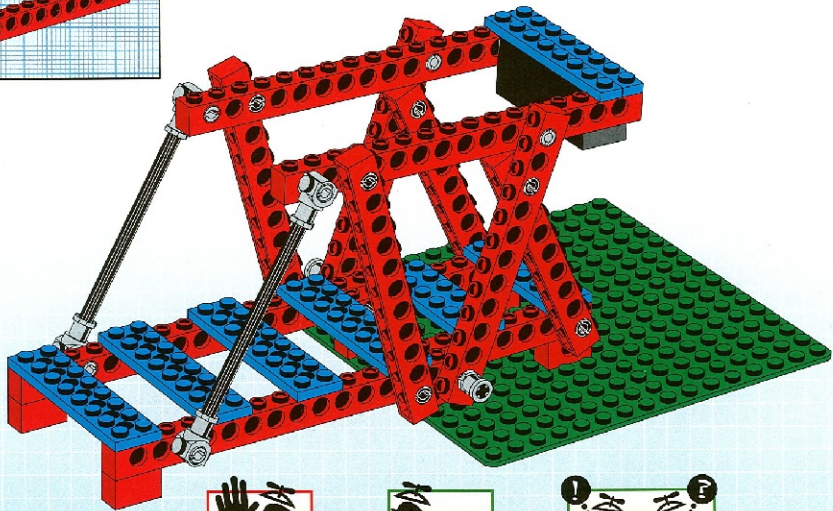

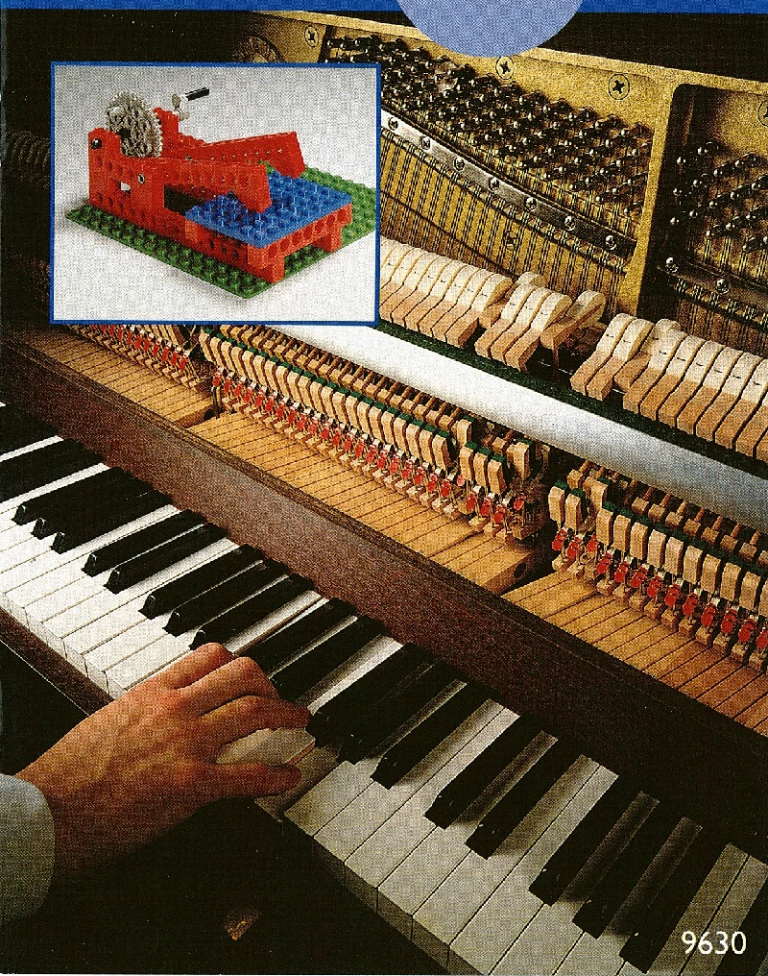
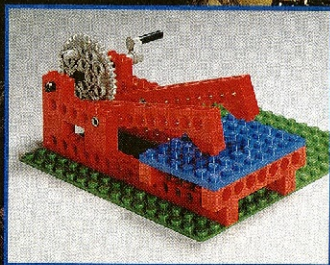
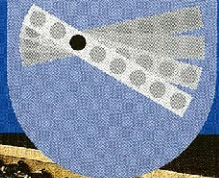

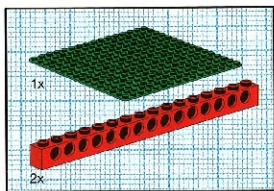
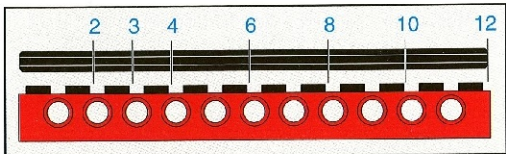

1

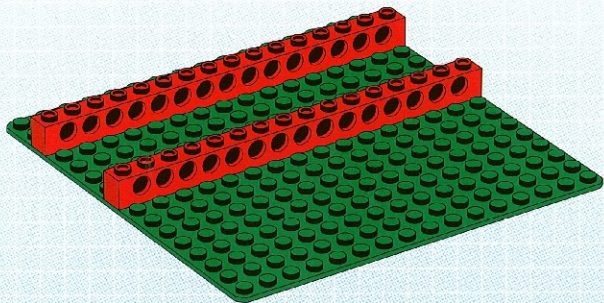

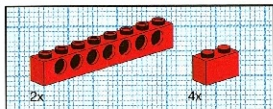

2

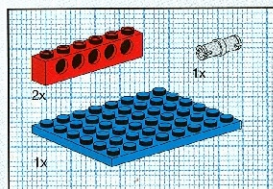
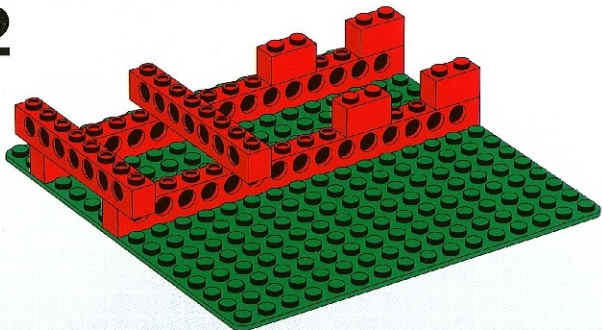

3

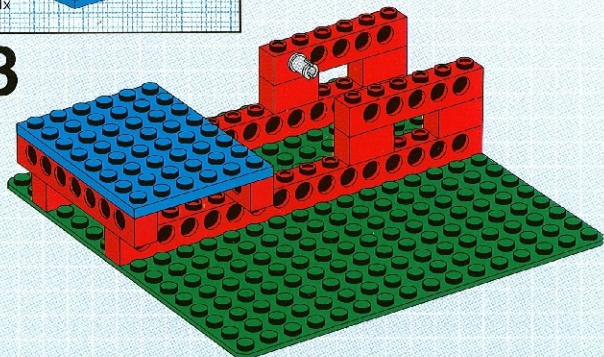

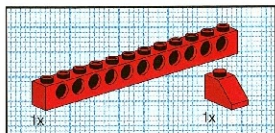

4

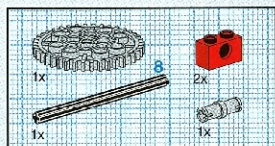
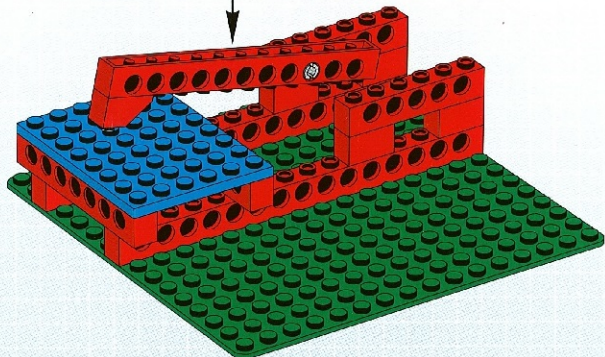
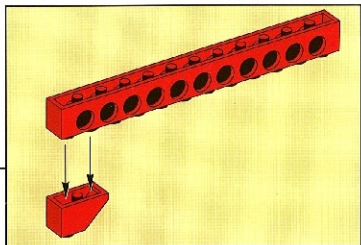

5

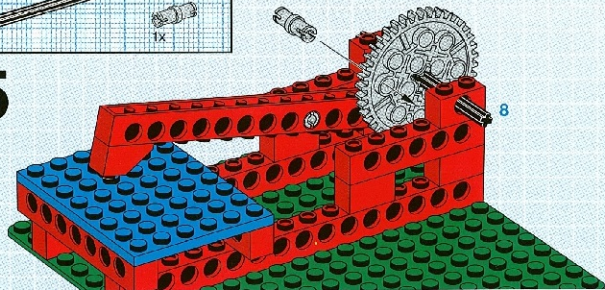

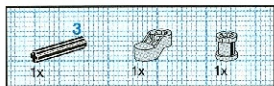

6

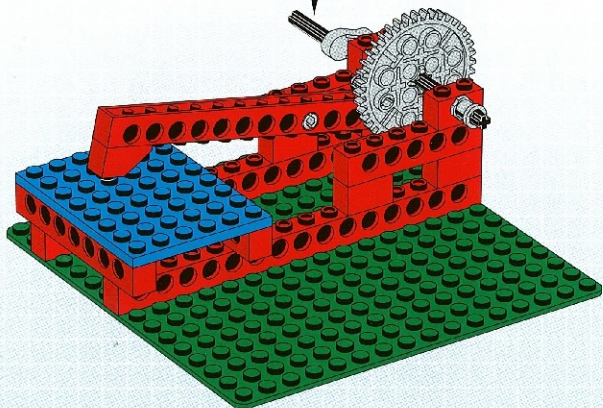
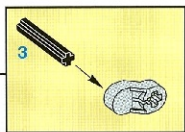



7

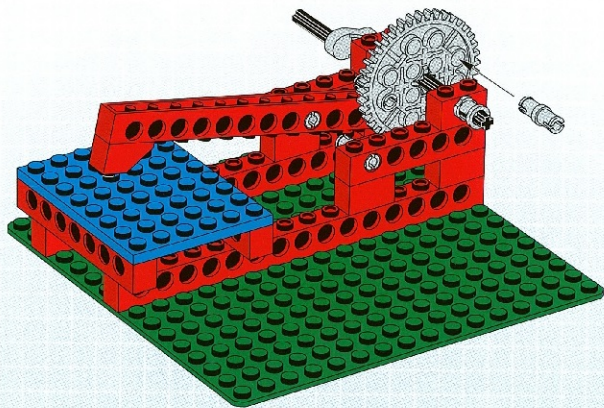

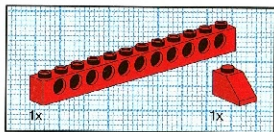

8

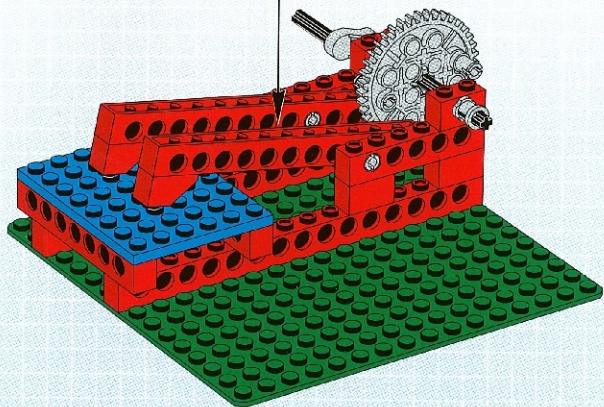
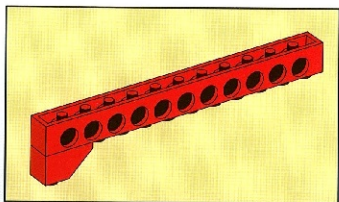

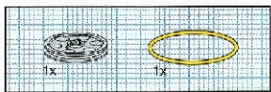
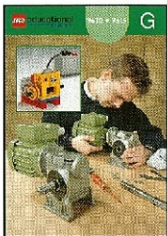
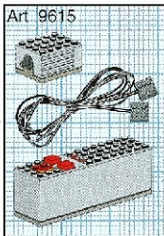
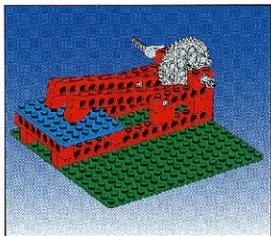

9

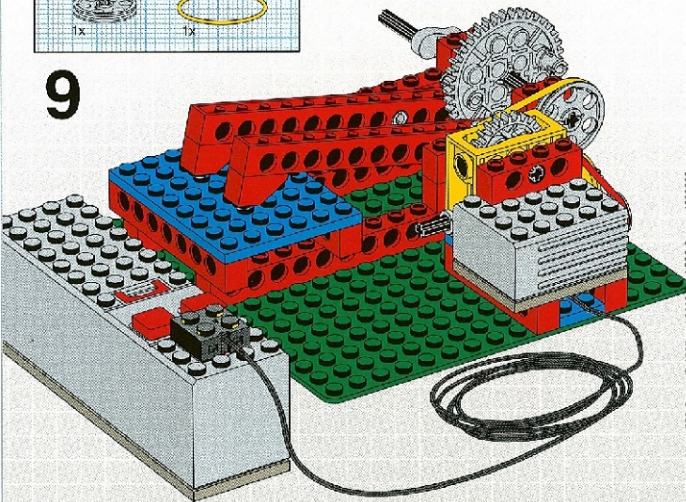

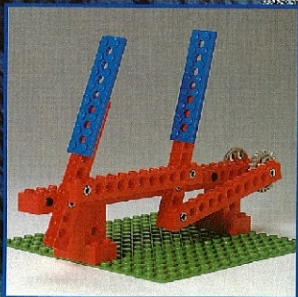
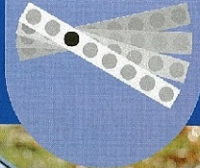

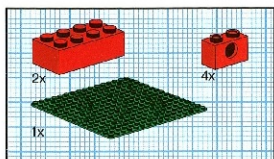
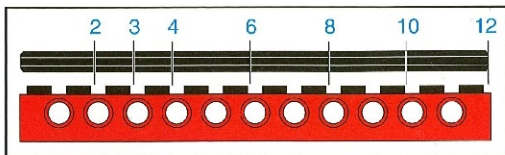

1

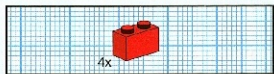
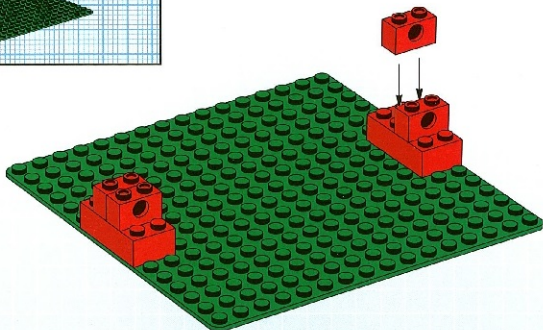

2

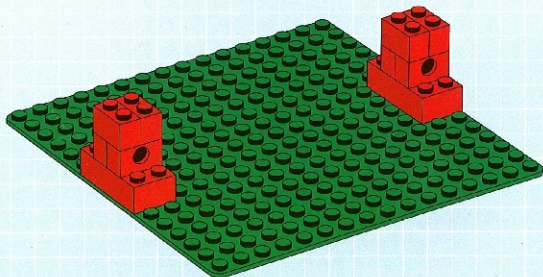

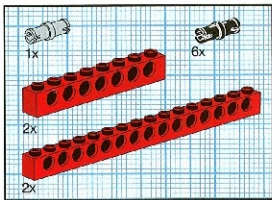

3

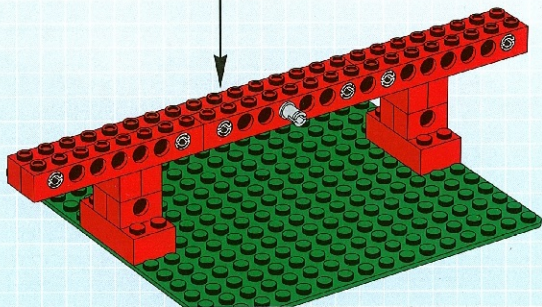
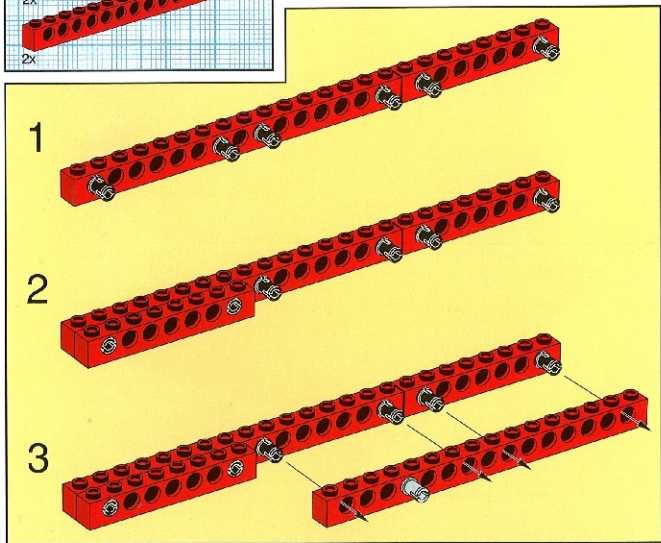

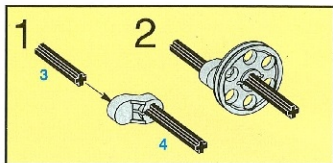
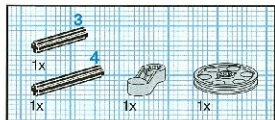

4

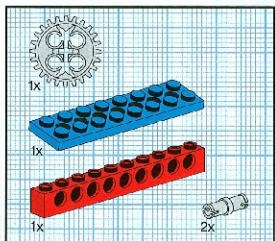
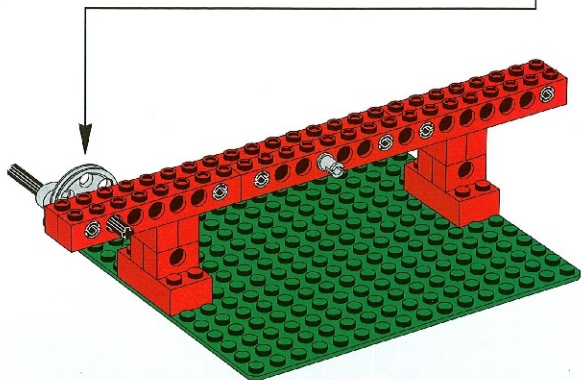

5

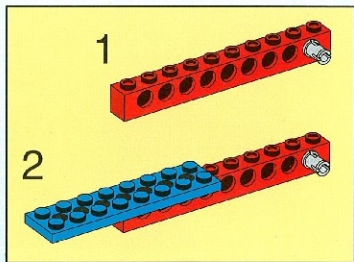

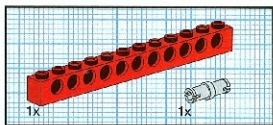
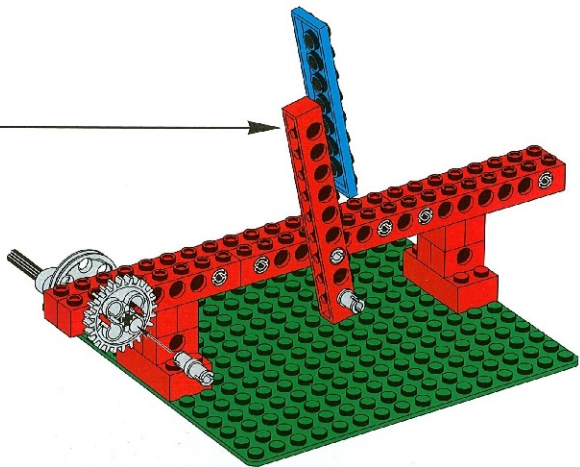

6

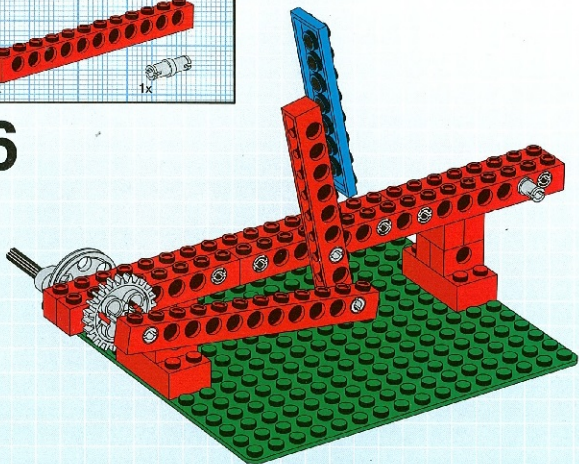

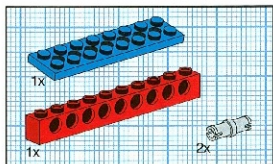

7

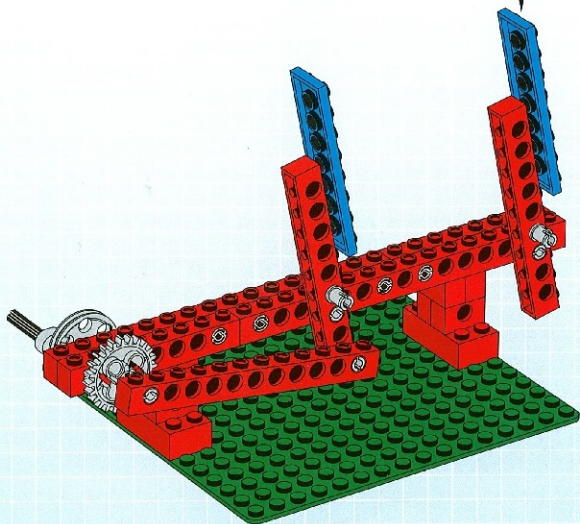
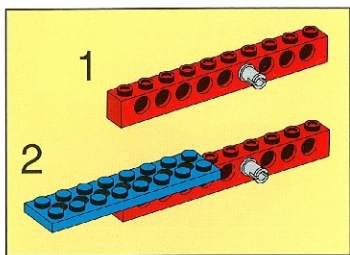

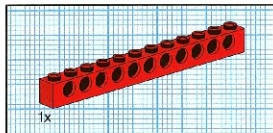

8

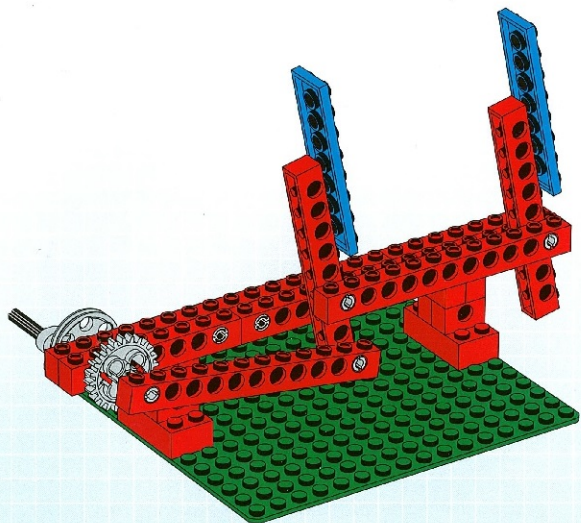

9

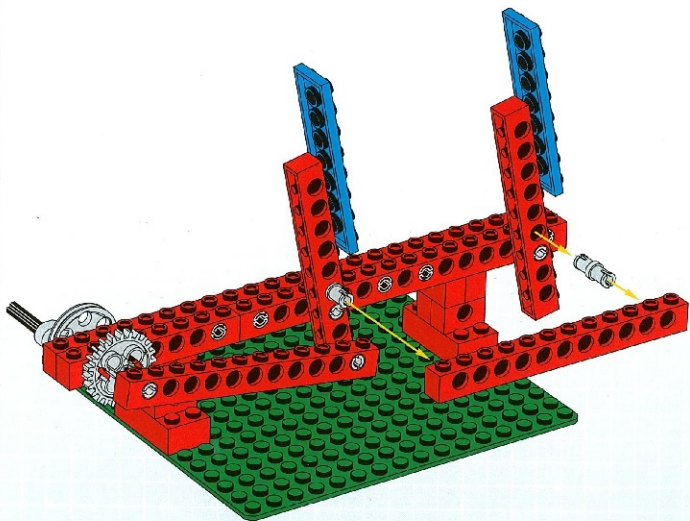

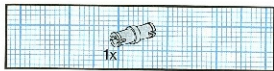

10

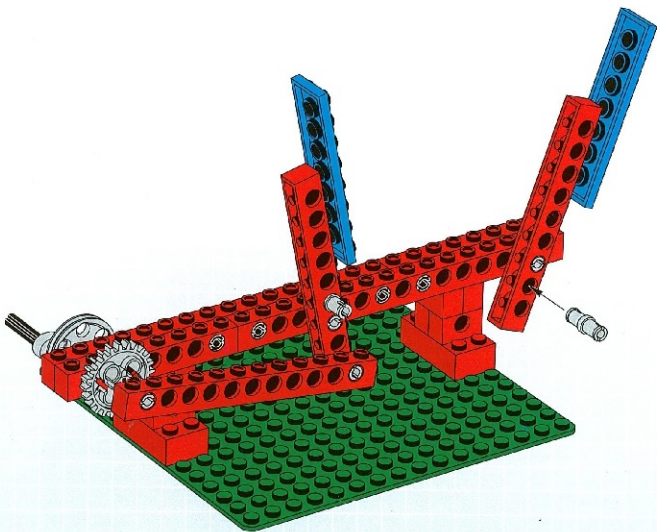

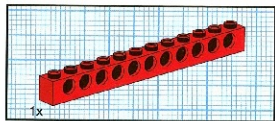

11

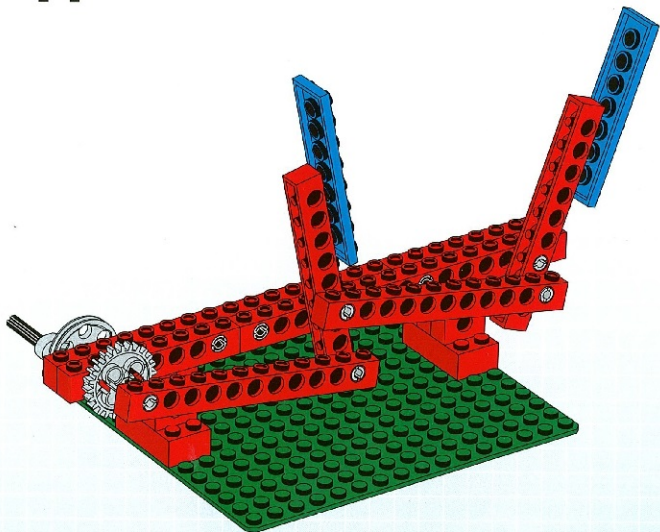

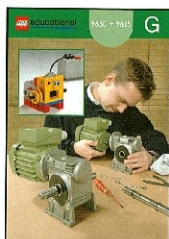
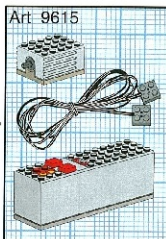
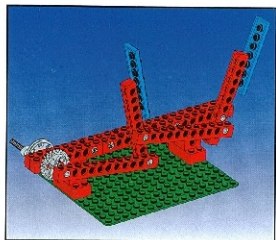

12

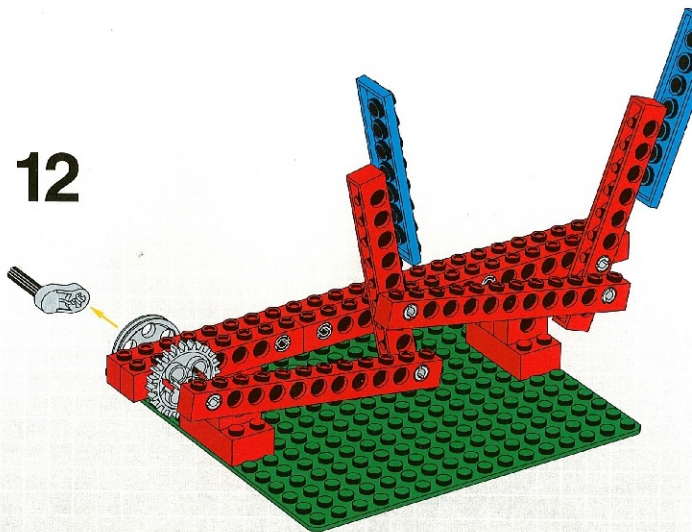

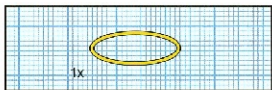

13

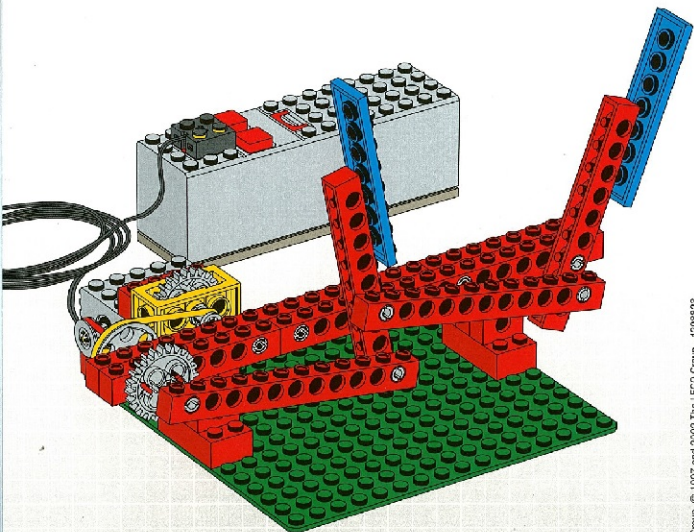



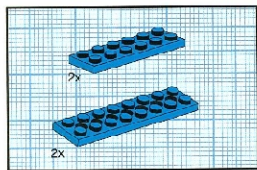
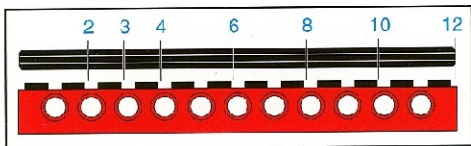

1

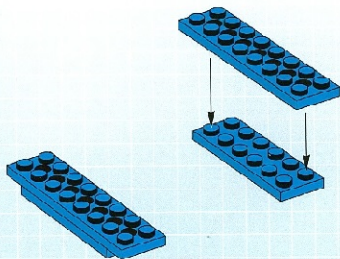

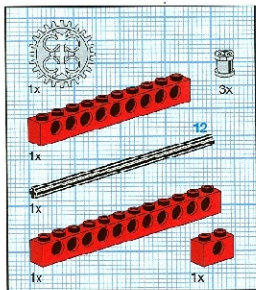

2

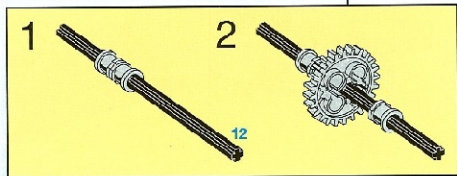
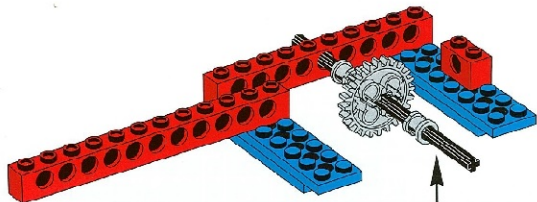

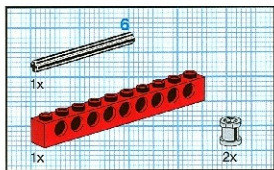

3

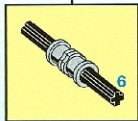
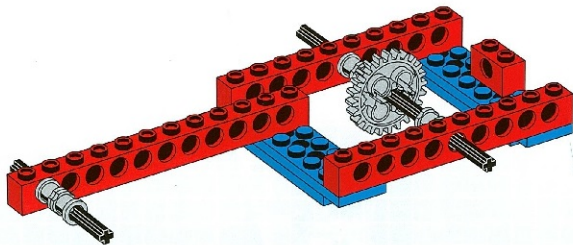

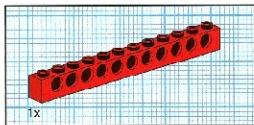

4

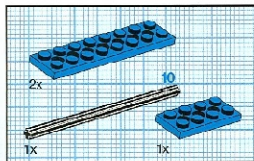
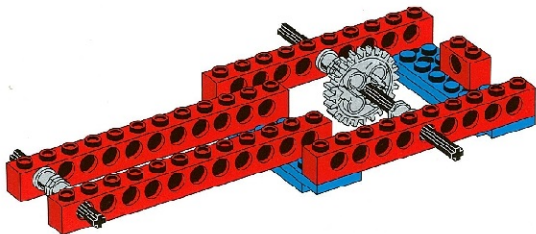

5

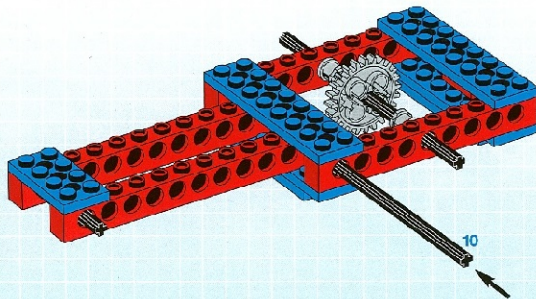

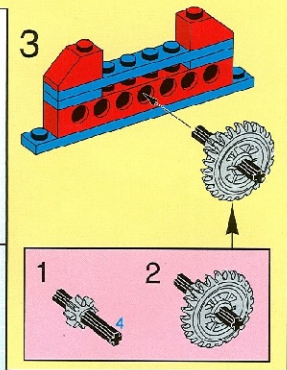
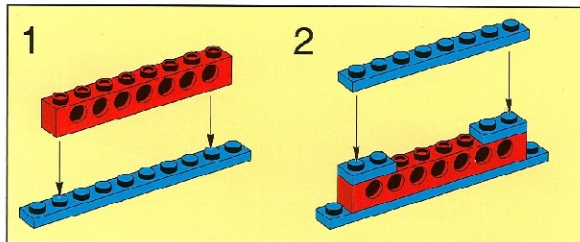
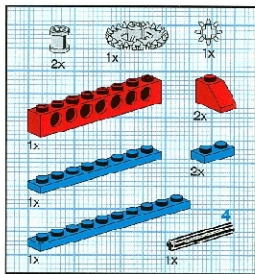

6

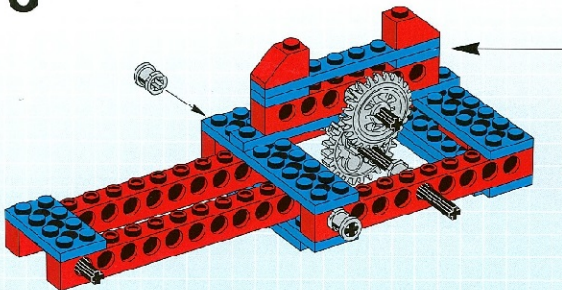

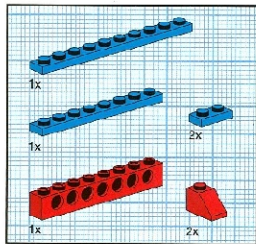

7

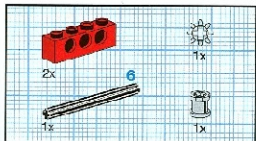
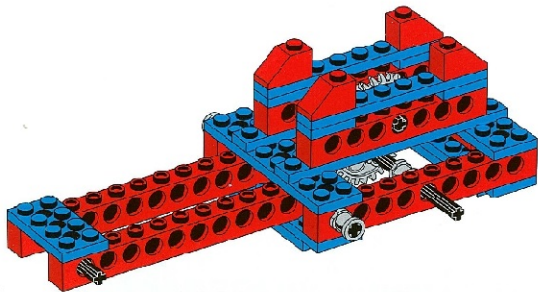

8

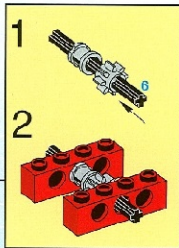
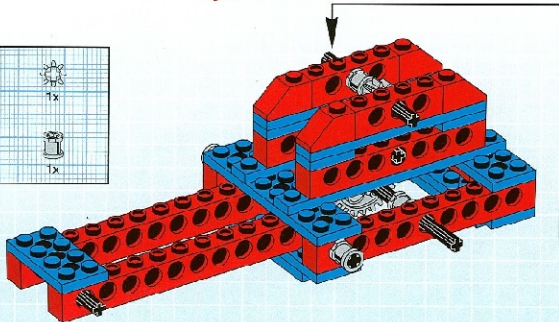

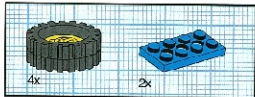

9

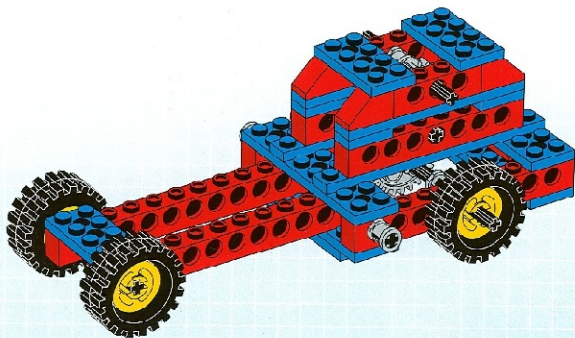



10

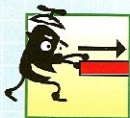
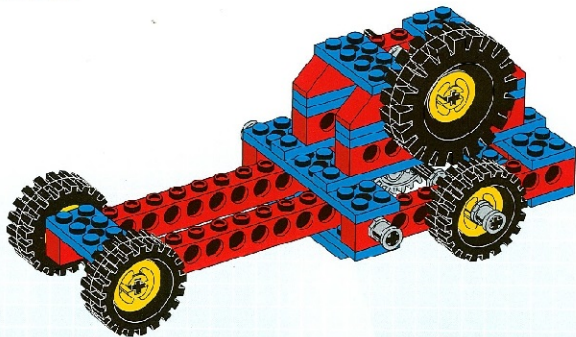



11

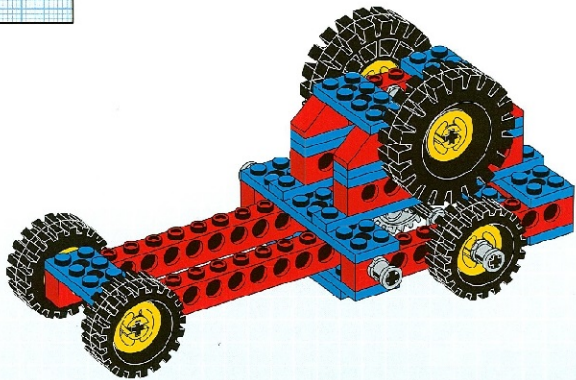

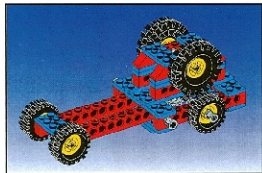

+

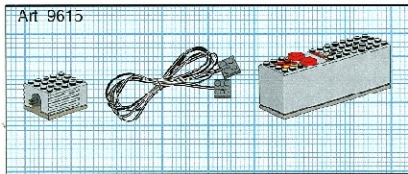

12

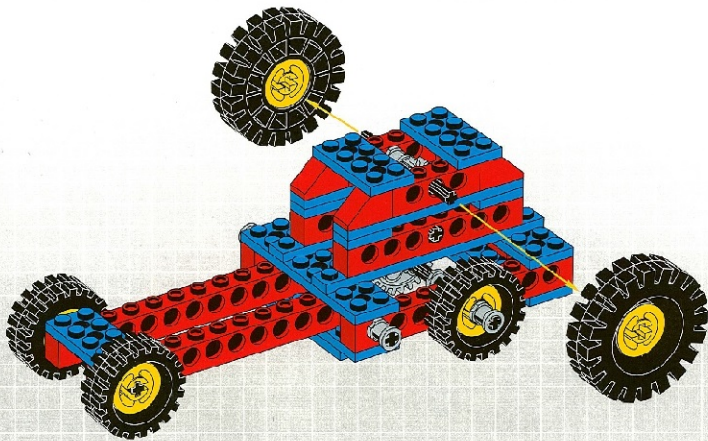

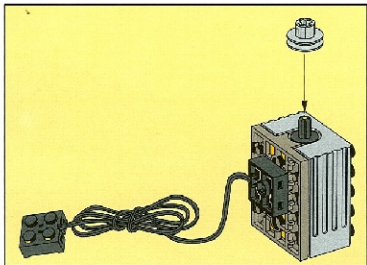
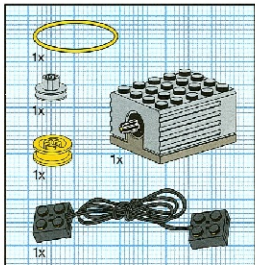

13

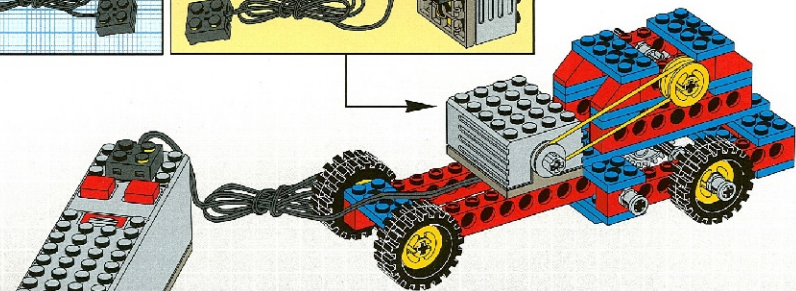

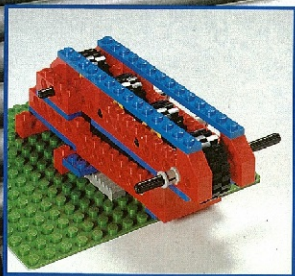
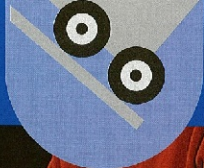

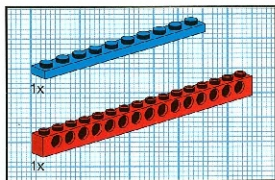
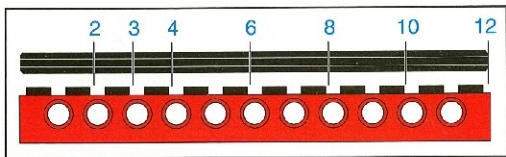

1

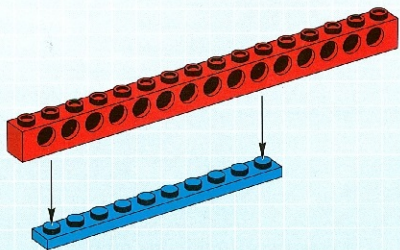

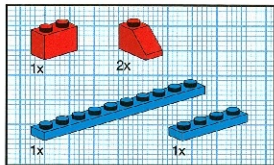

2

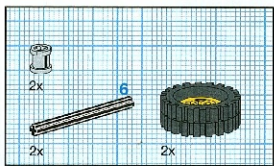
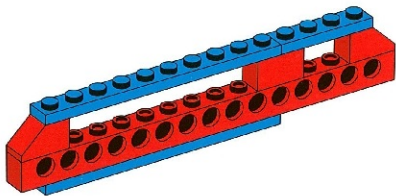

3

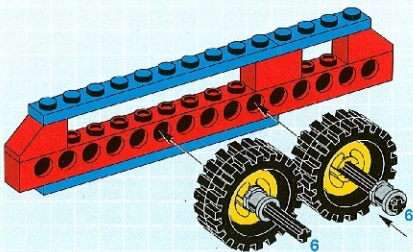

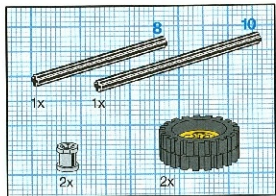

4

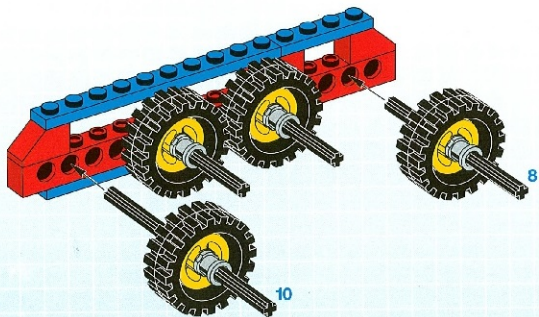

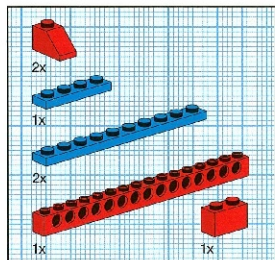

5

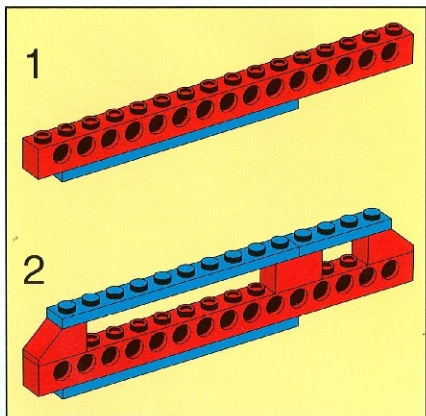

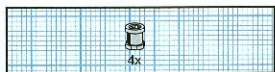
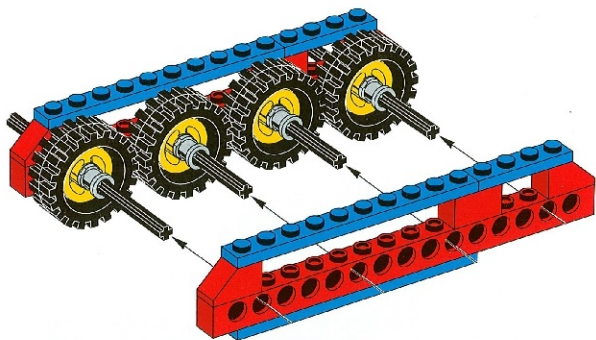

6

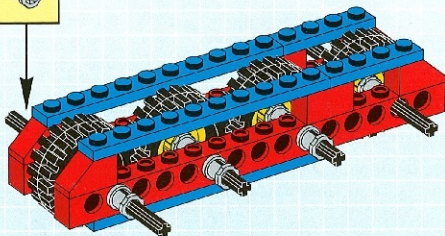

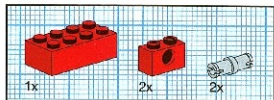

7

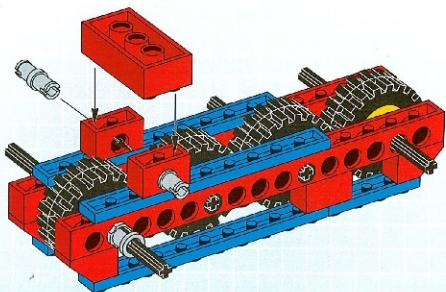

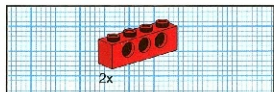

8

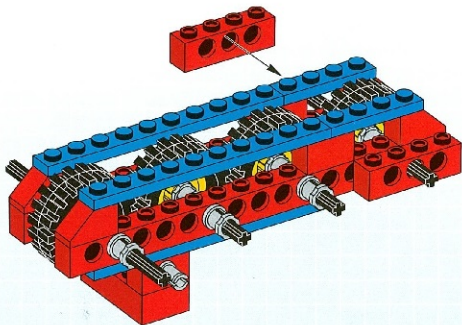

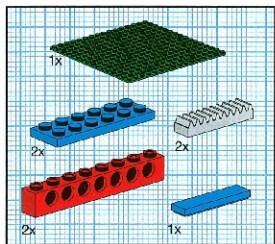

9

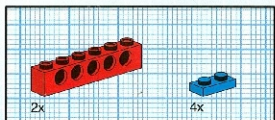
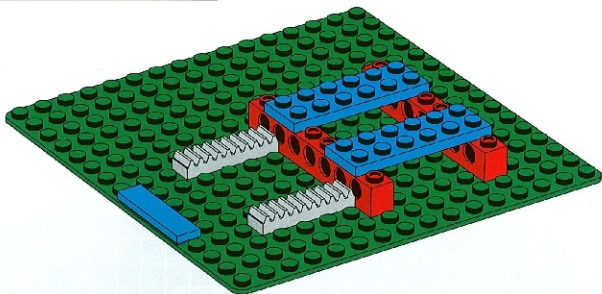

10

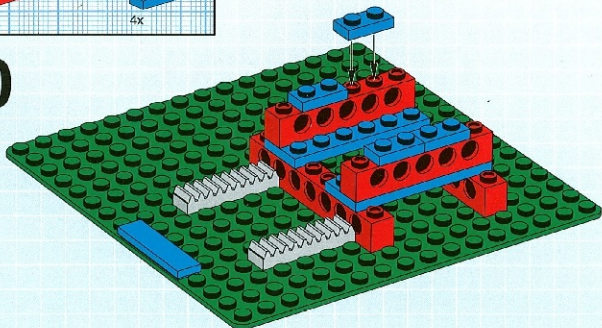

11

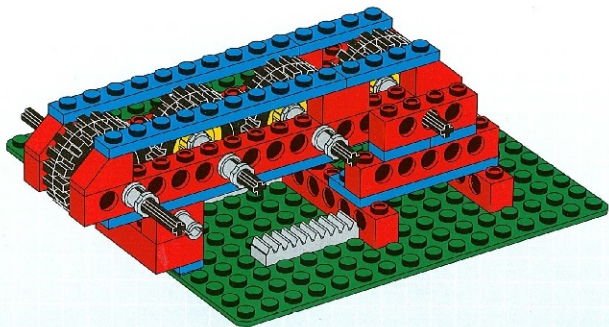

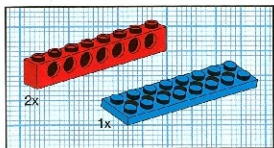

12

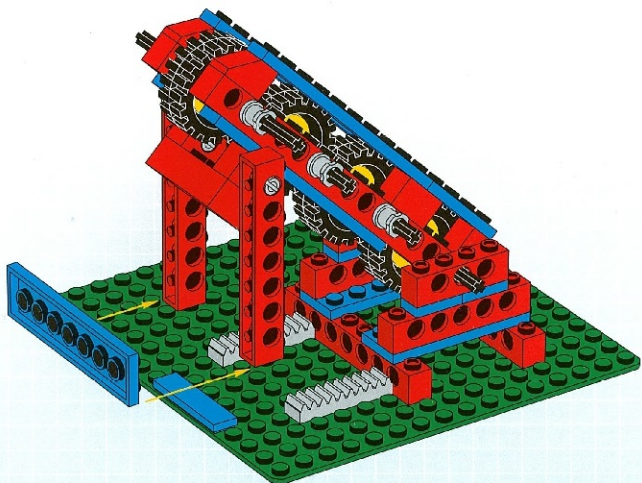

13

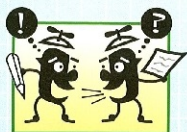
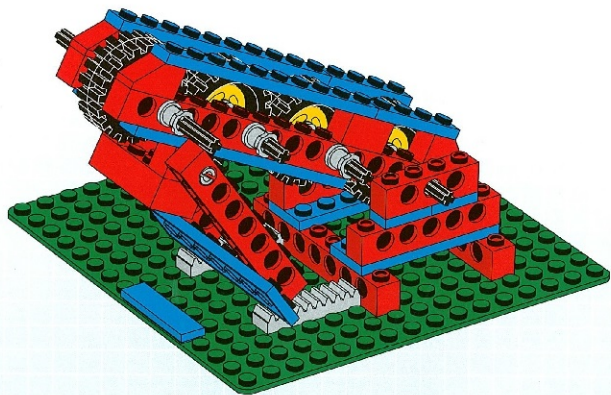



14

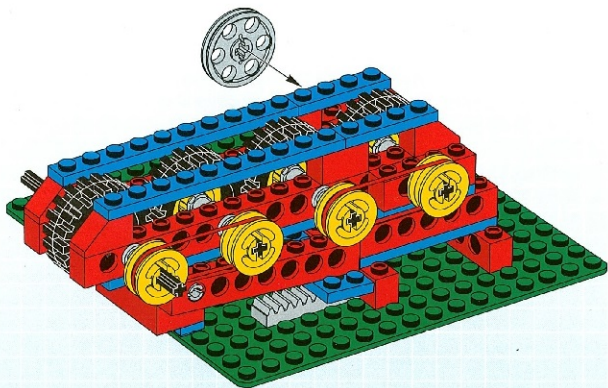

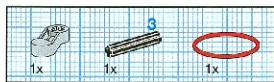

15

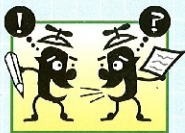
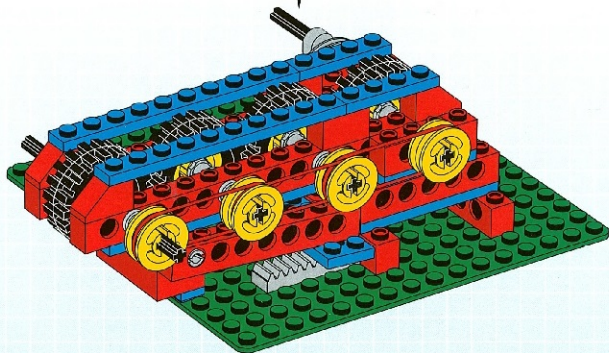
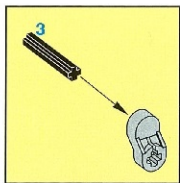

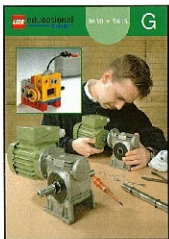
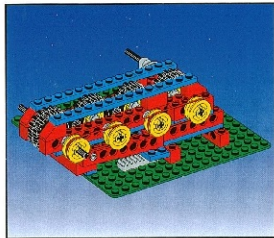

16

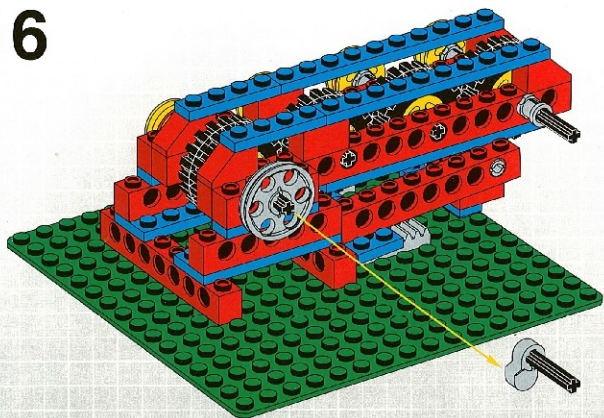



17

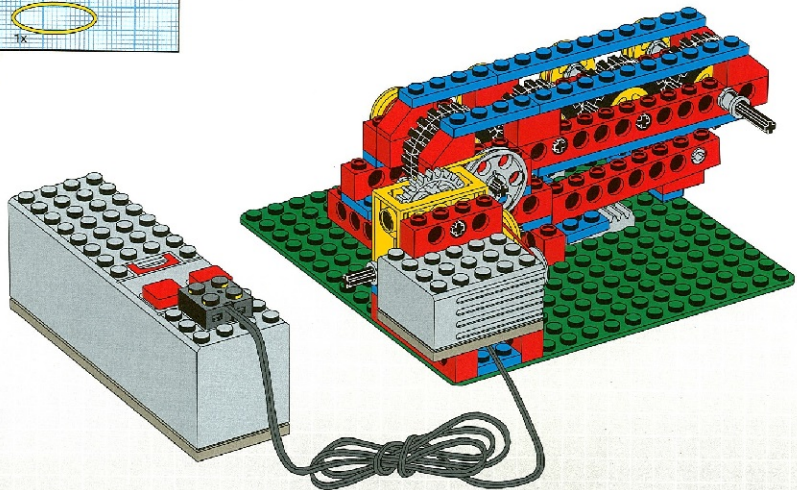



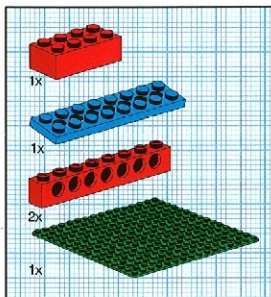
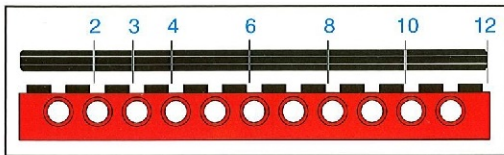

1

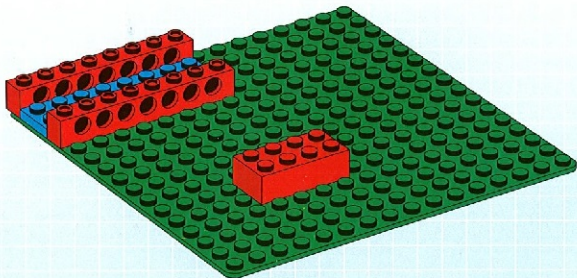

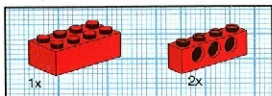

2

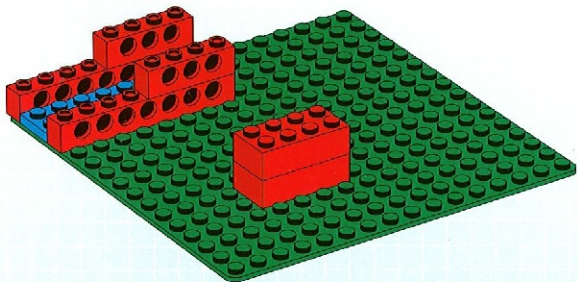

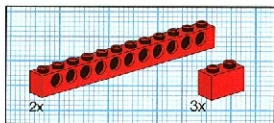

3

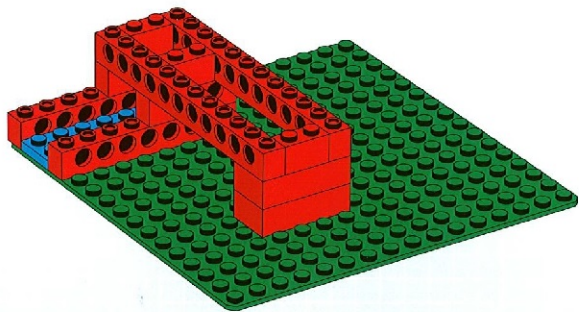

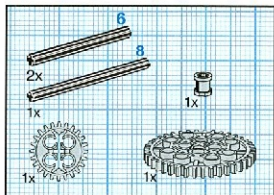

4

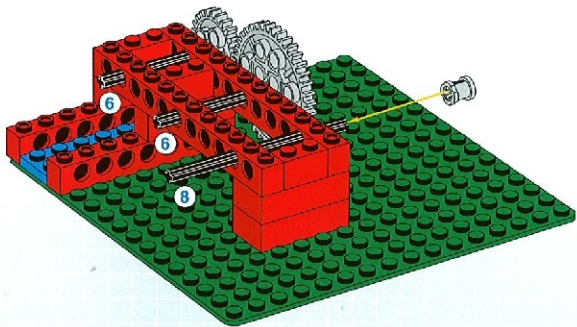

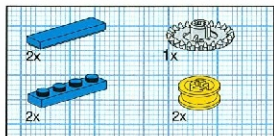

5

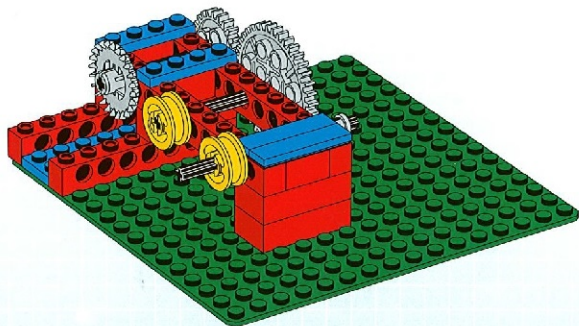

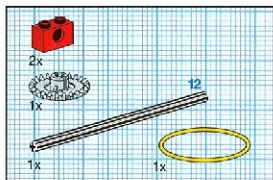

6

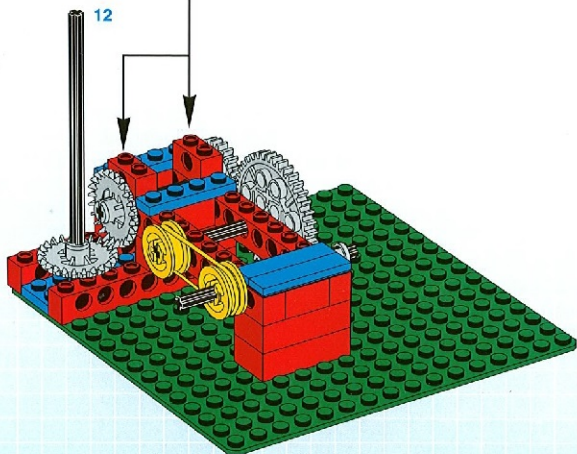
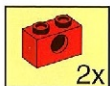

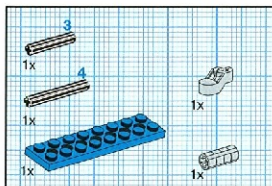

7

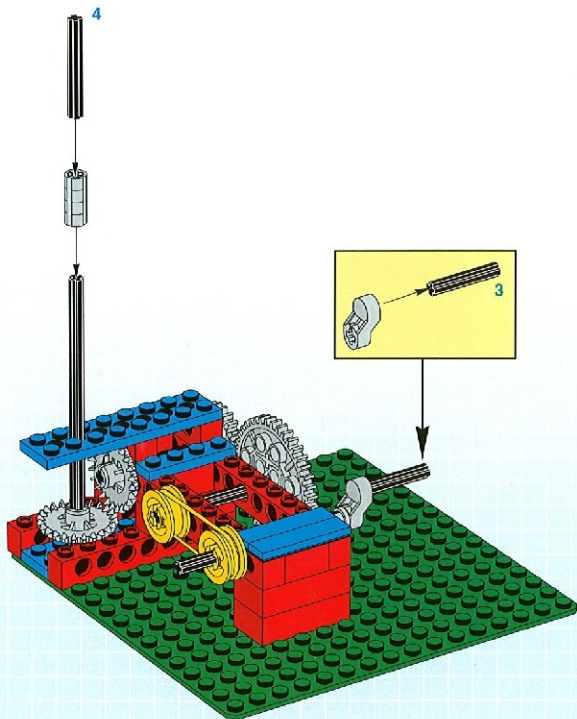

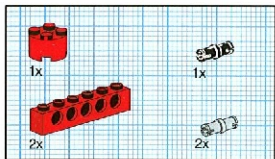

8

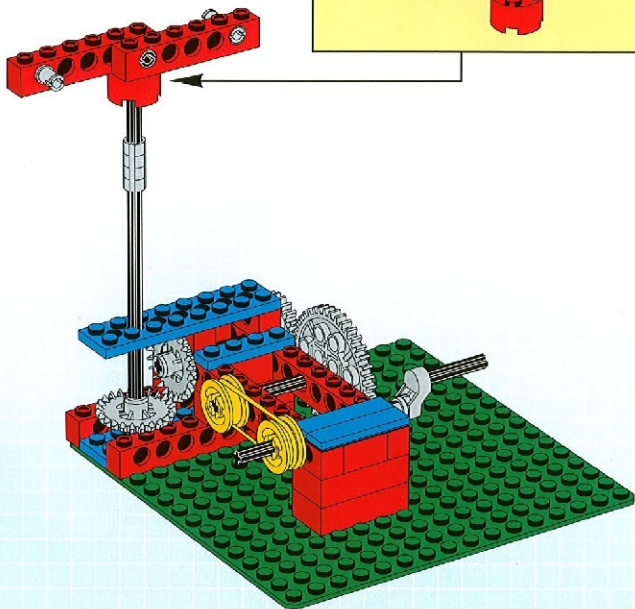
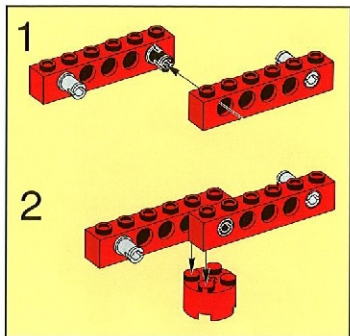

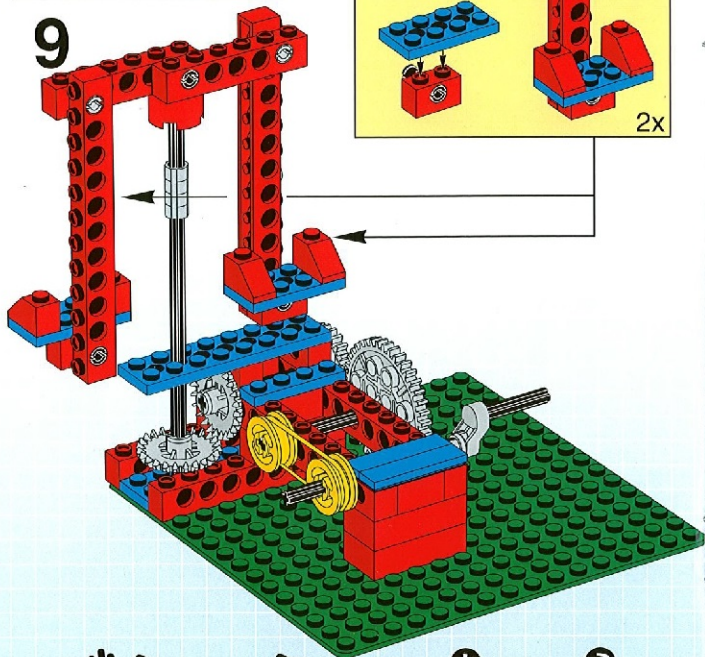
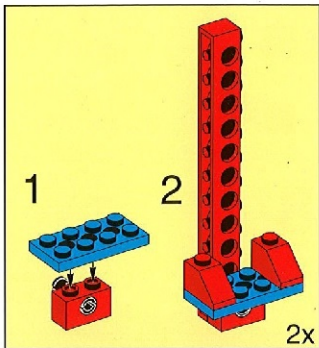
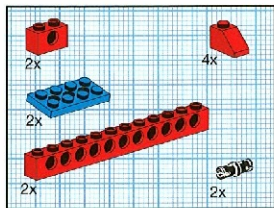

10

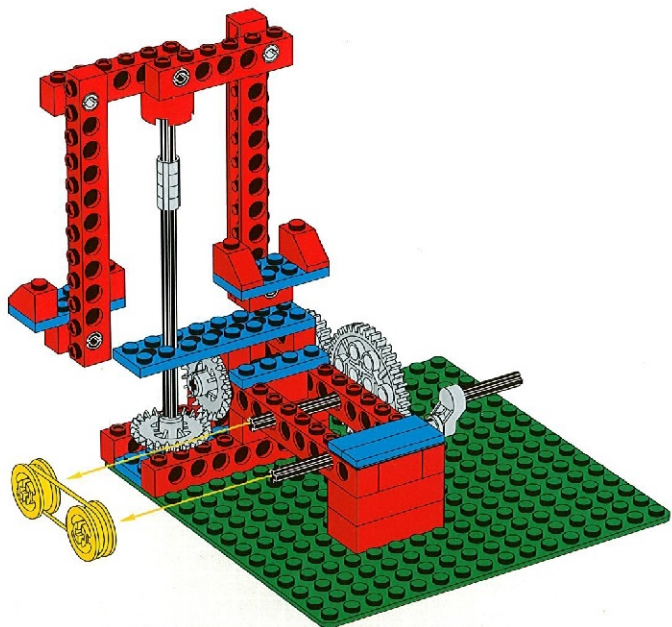



11

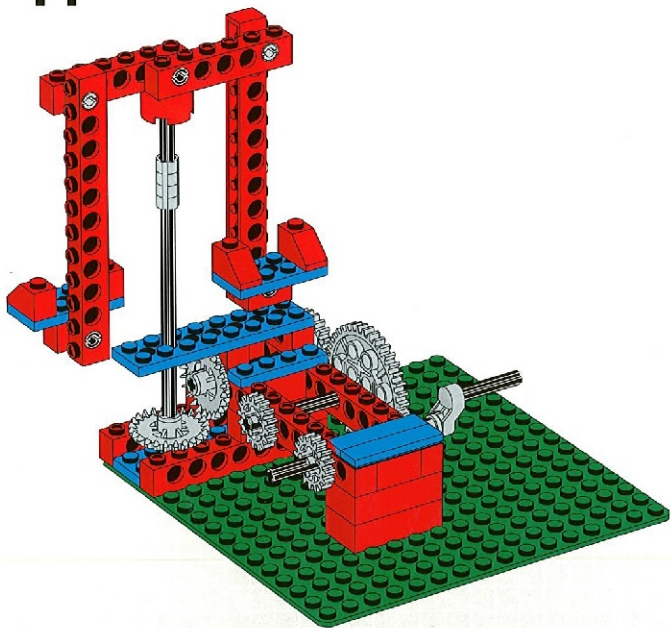



12

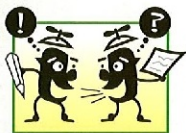
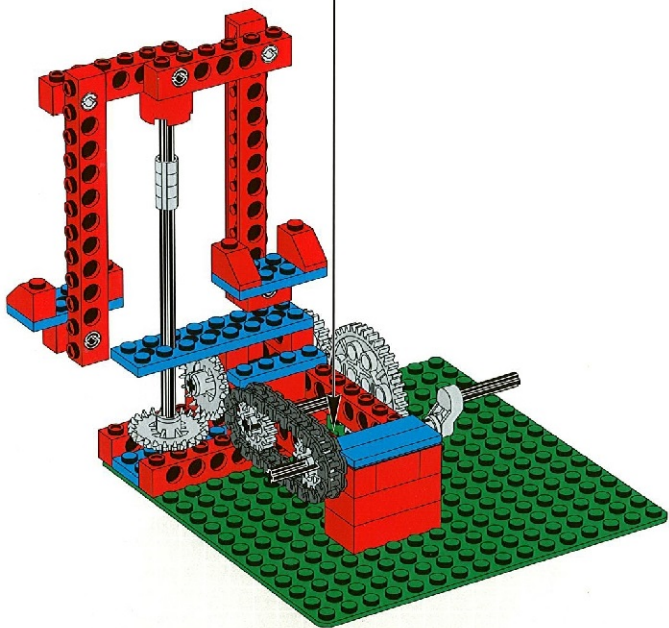
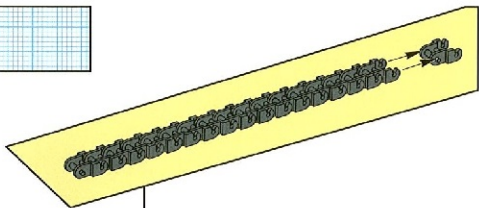

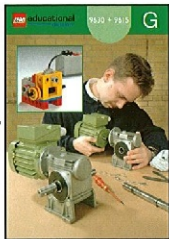
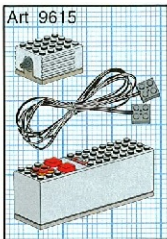
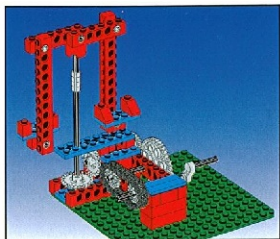

13

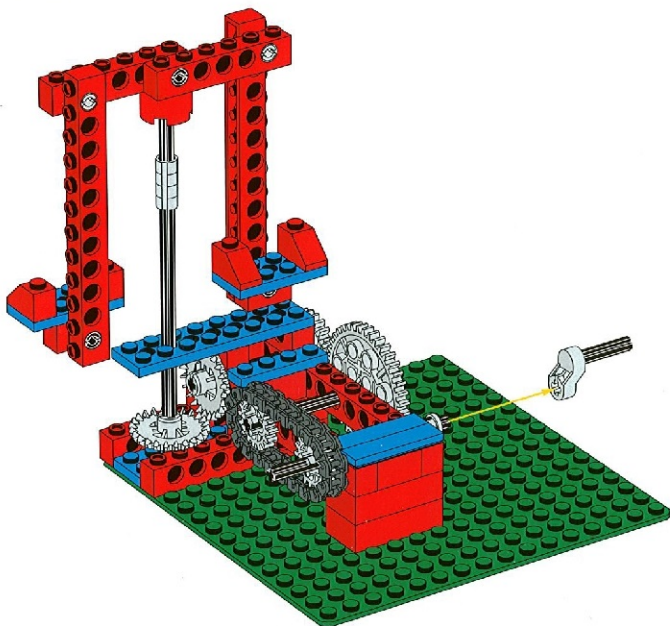

14

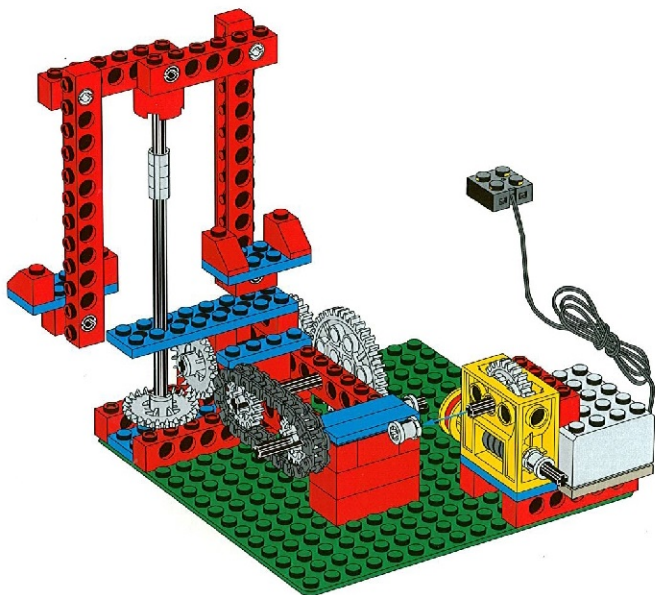

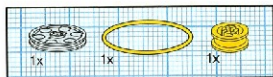

15

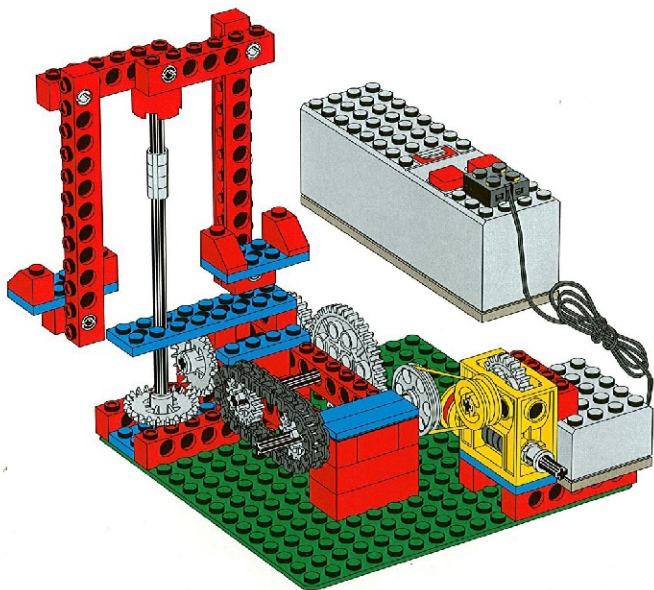

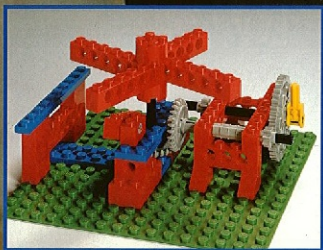

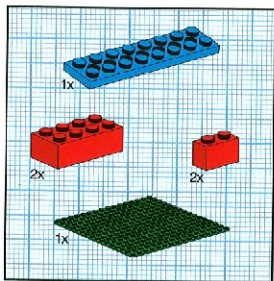
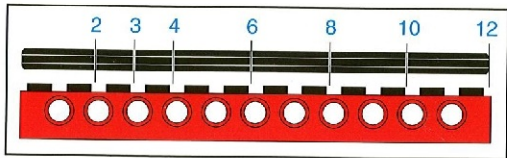

1

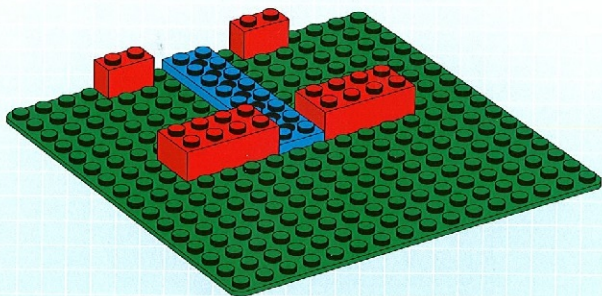

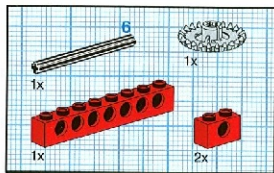

2

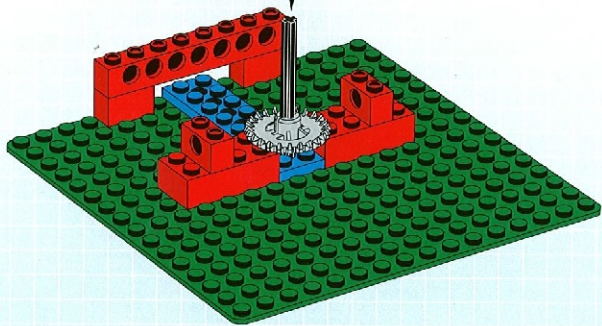

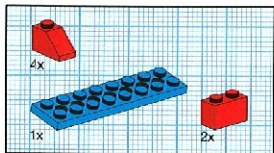

3

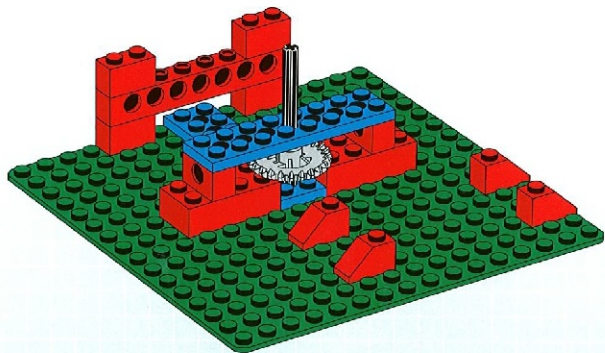

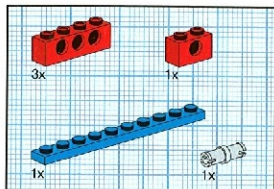

4

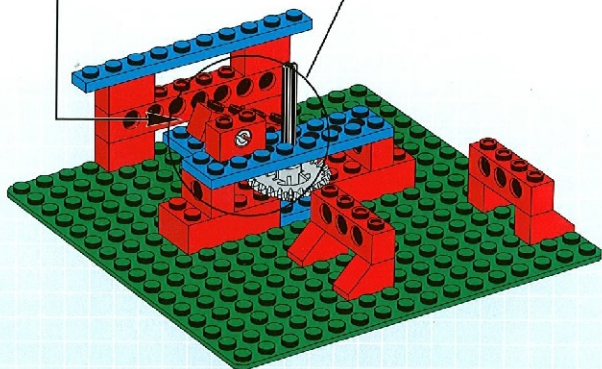
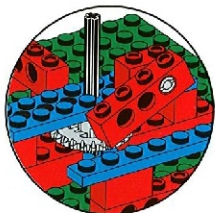
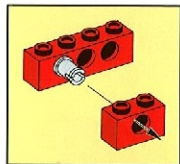

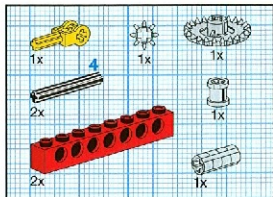

5

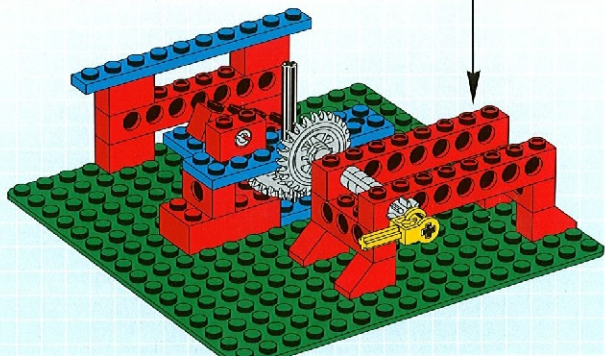
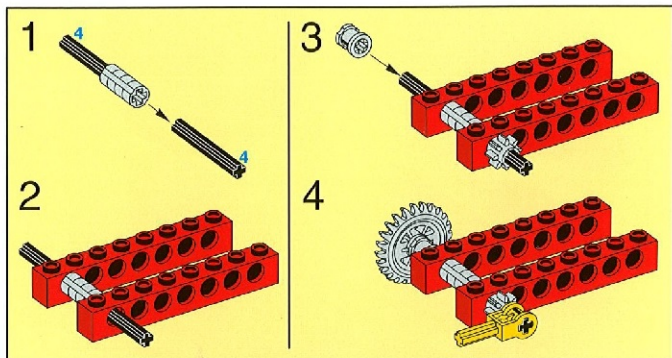

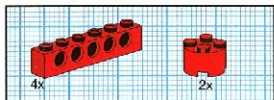

6

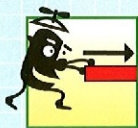
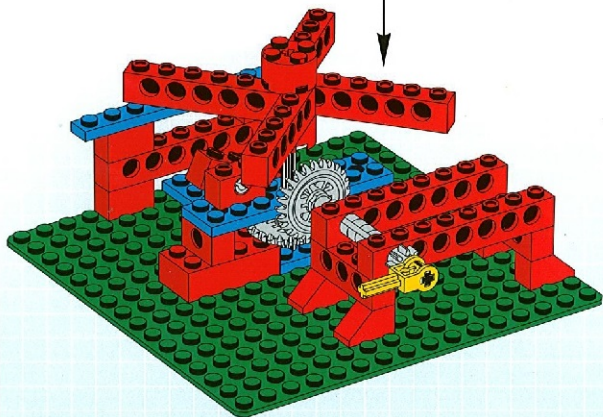
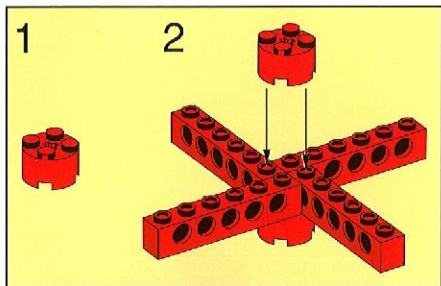

7

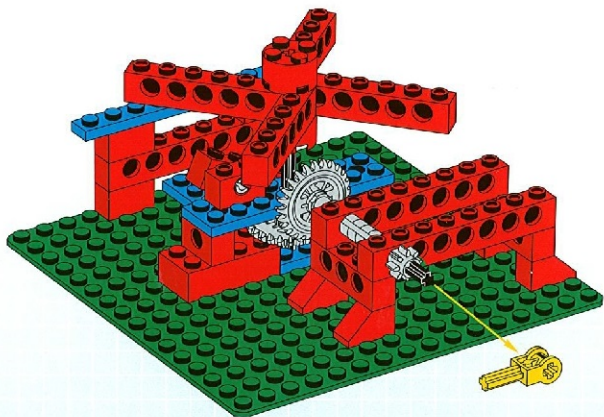

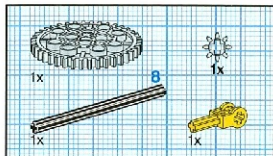

8

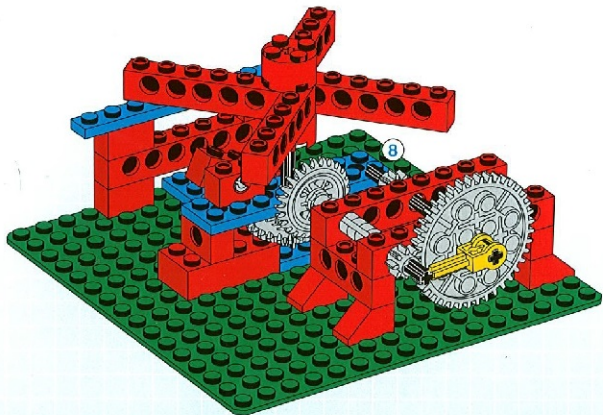

9

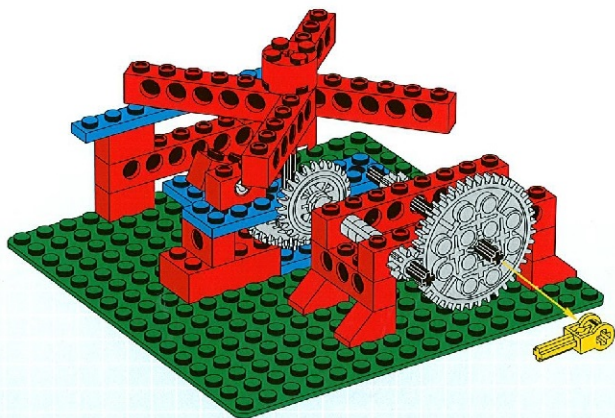

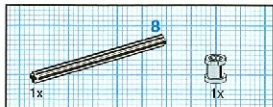

10

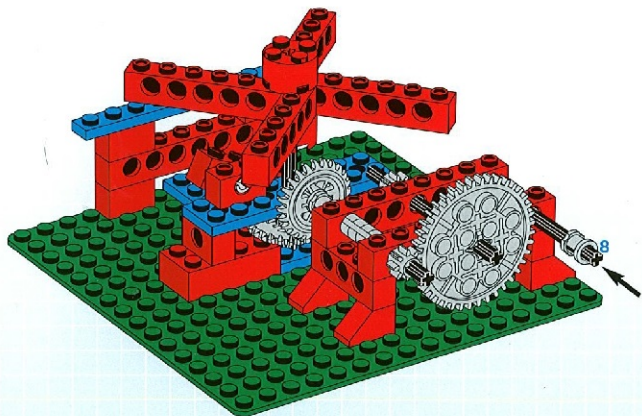

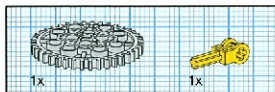

11

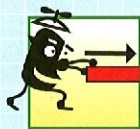
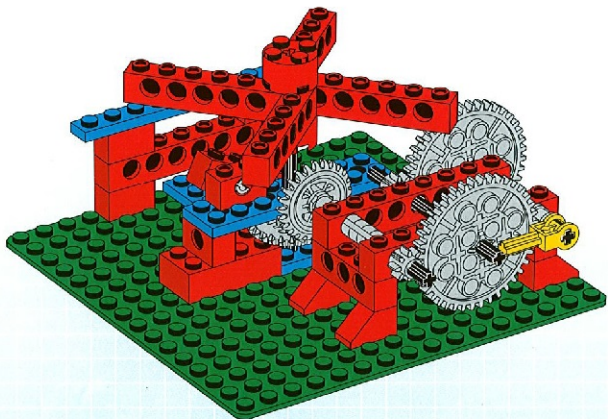

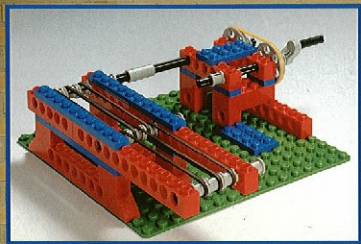

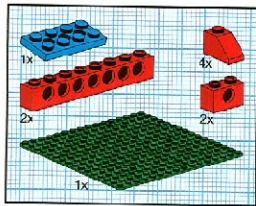
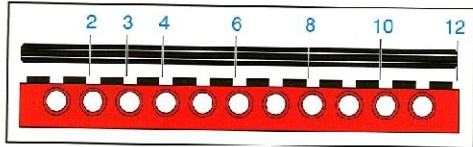

1

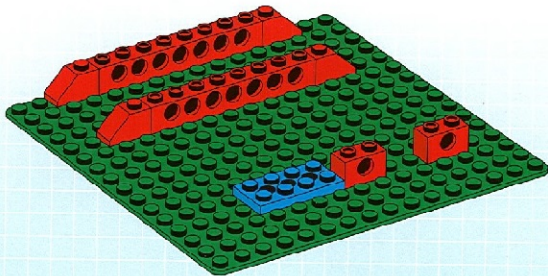

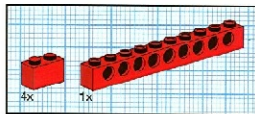

2

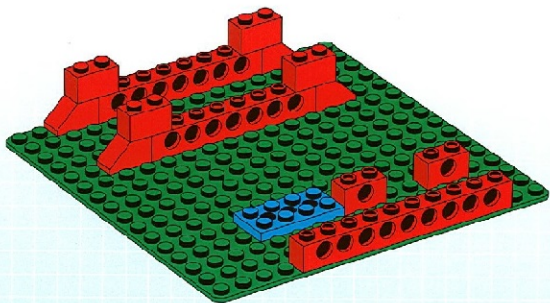

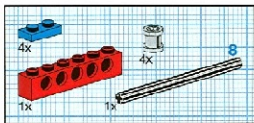

4

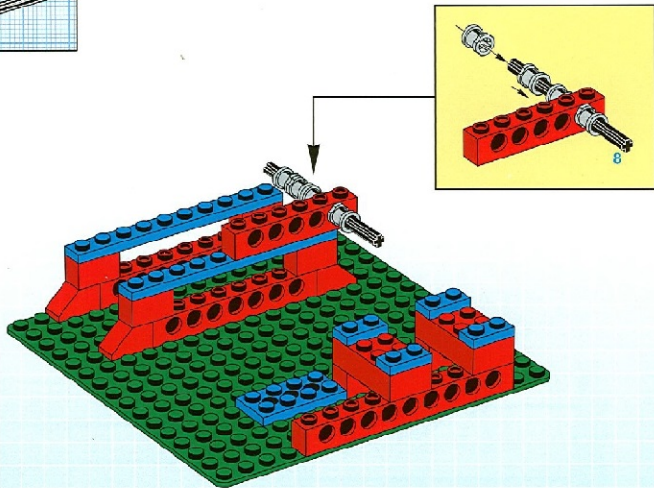

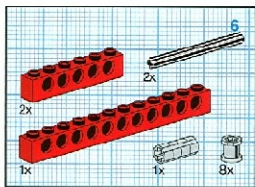

5

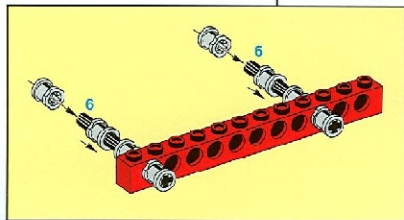
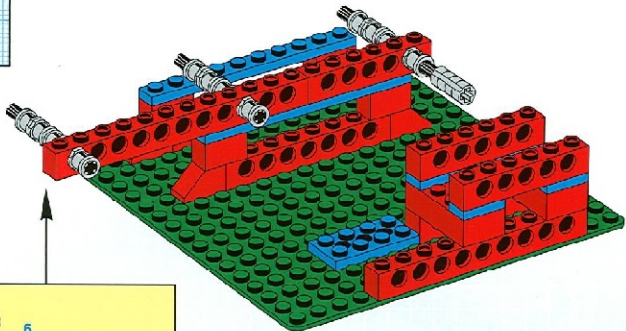

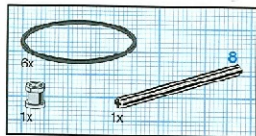

6

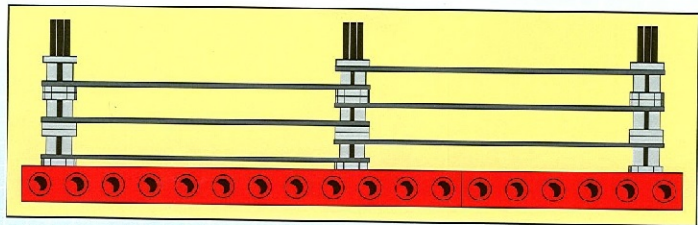
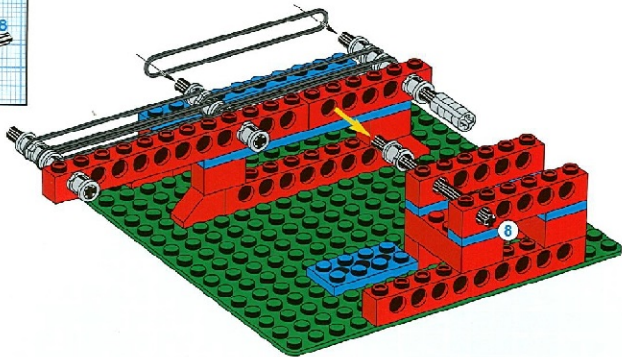

7

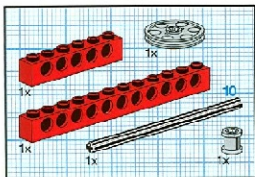

7

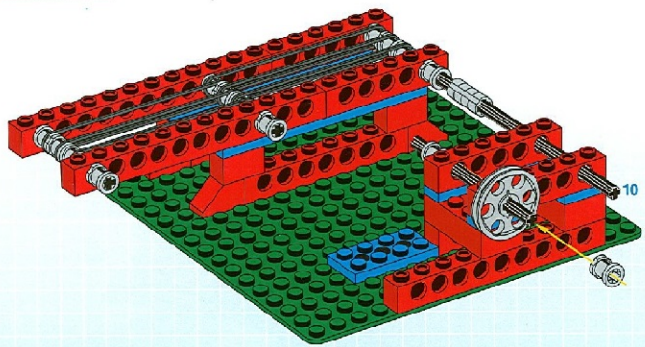

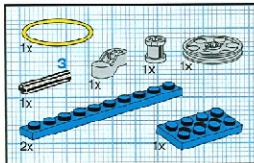

8

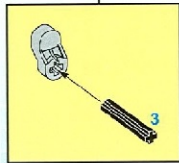
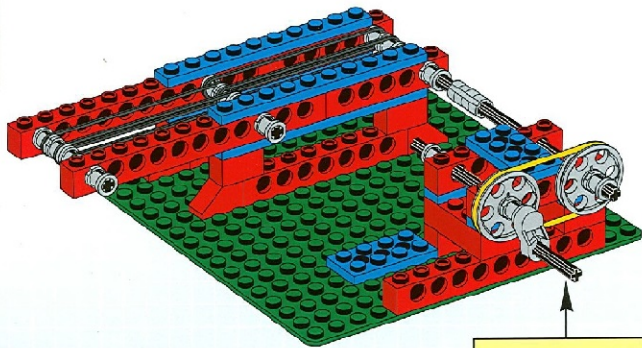

9

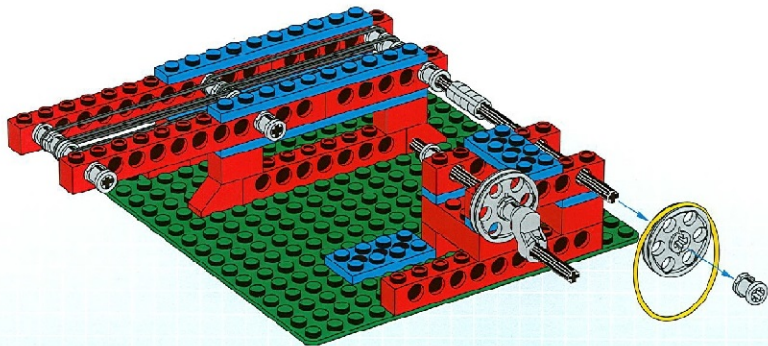



10

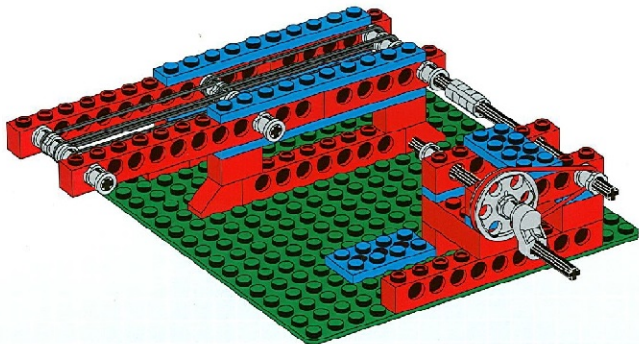

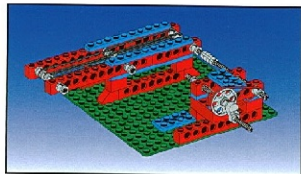

+

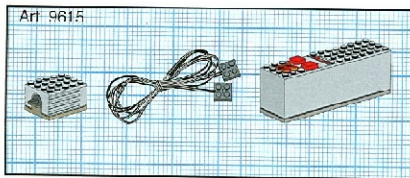

11

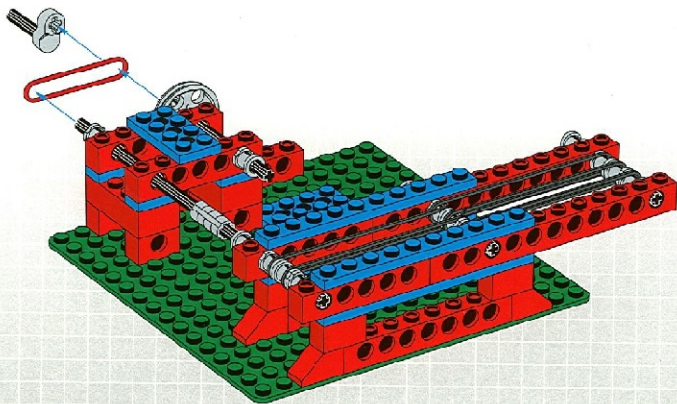

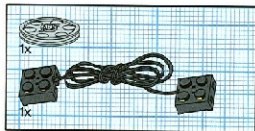

12

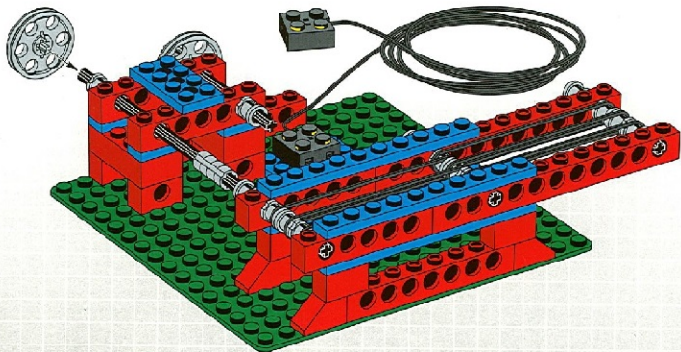

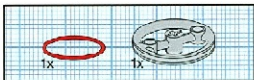

13

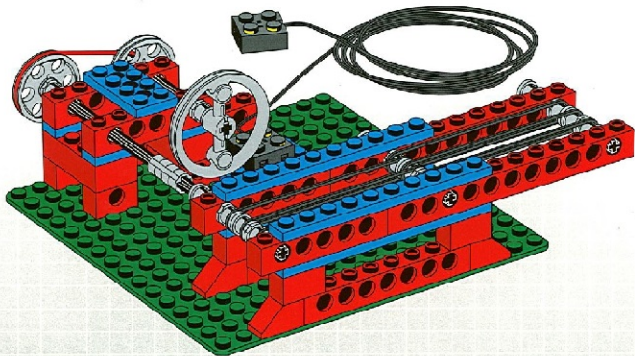

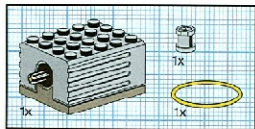

14

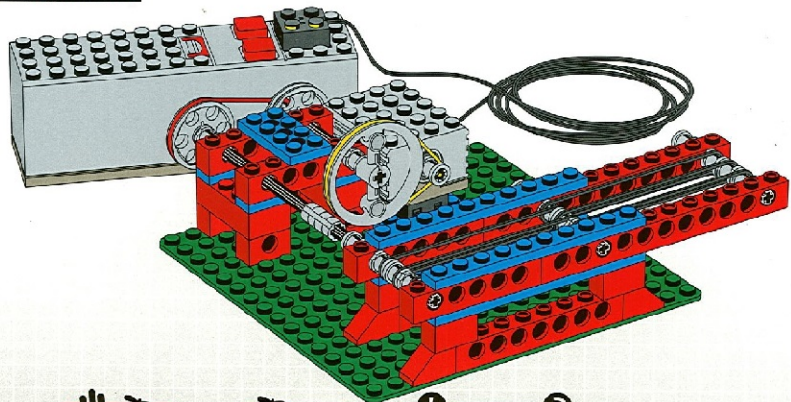

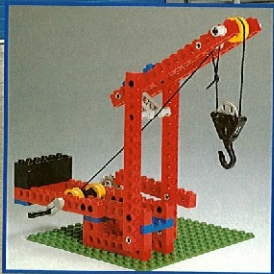

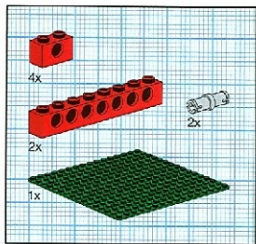
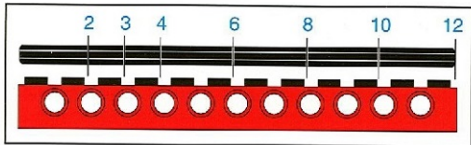

1

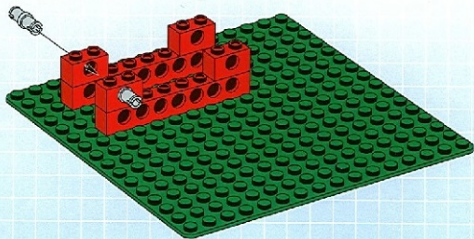



2

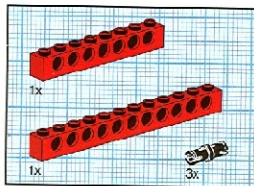

3

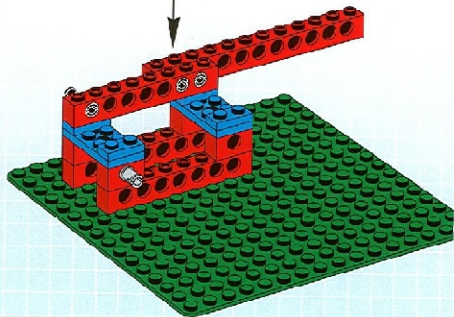
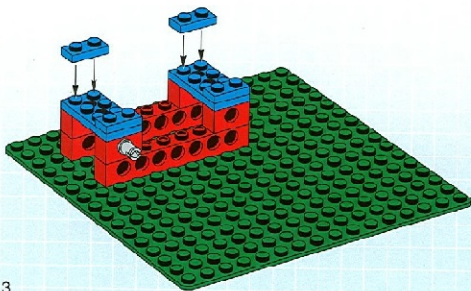
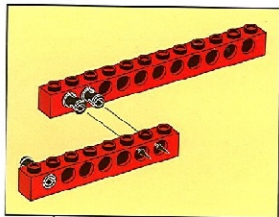

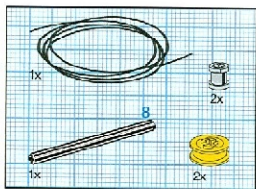

4

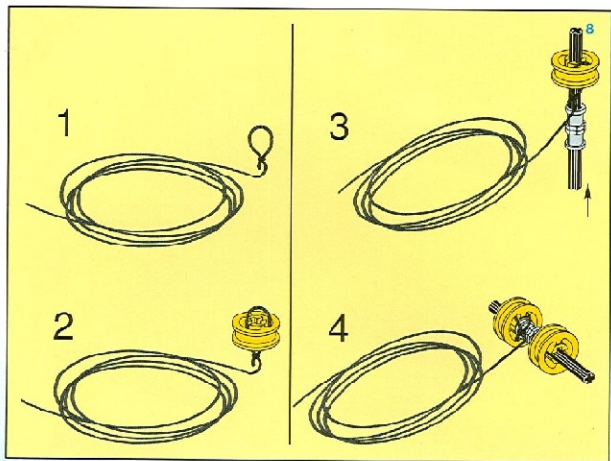

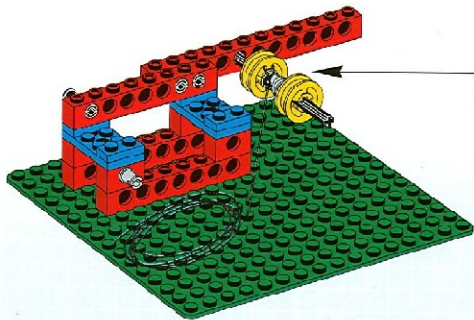

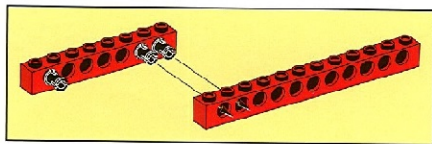
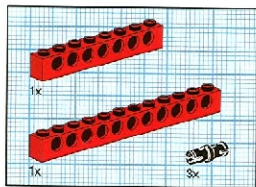

5

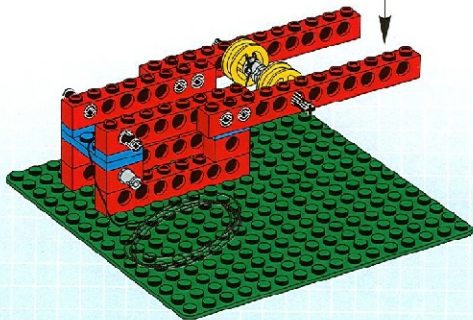

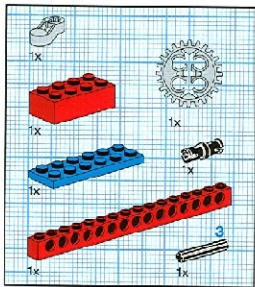

6

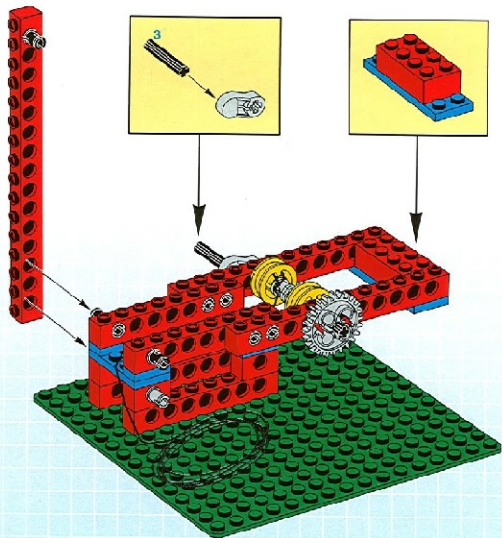

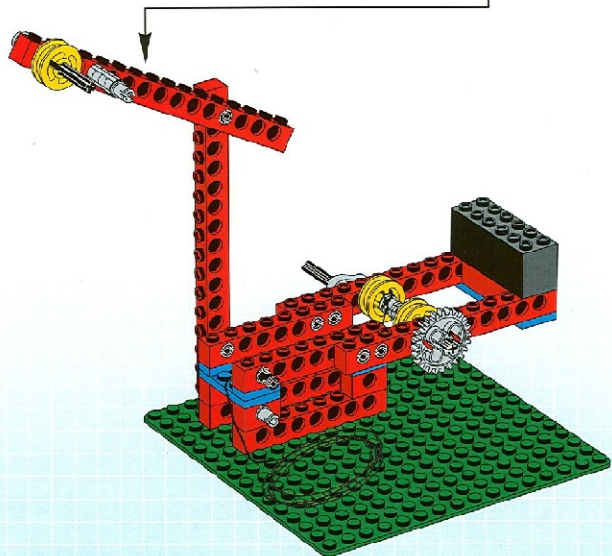

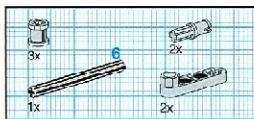

8

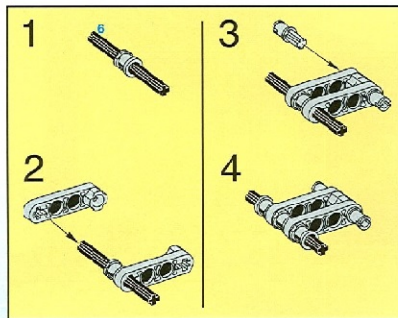

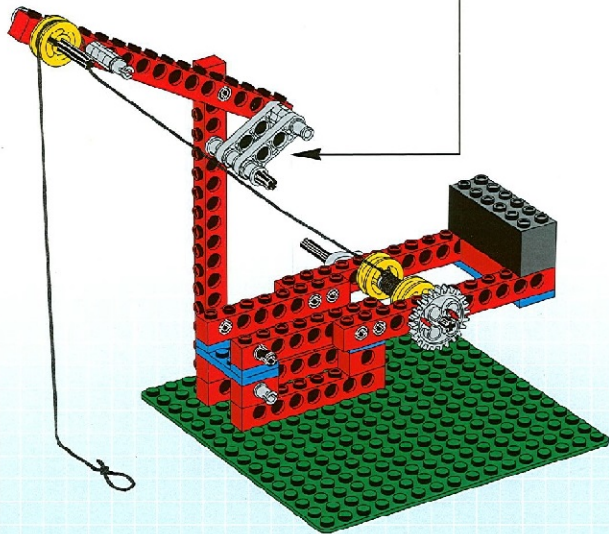

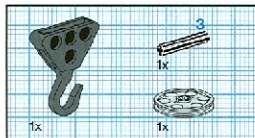

9

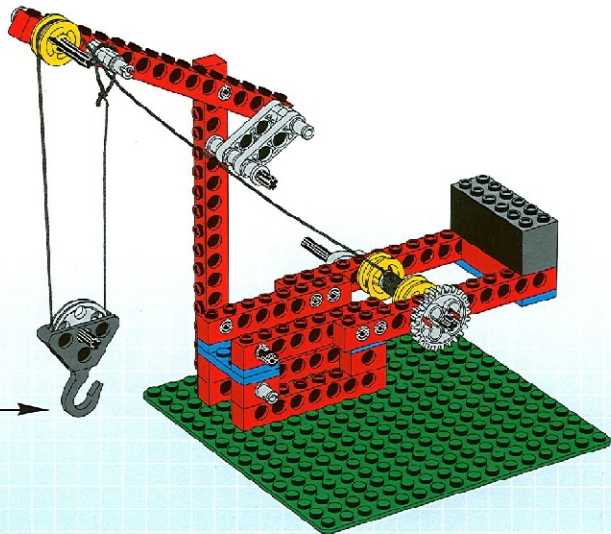
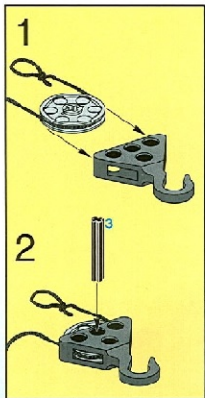

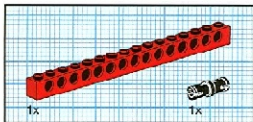

10

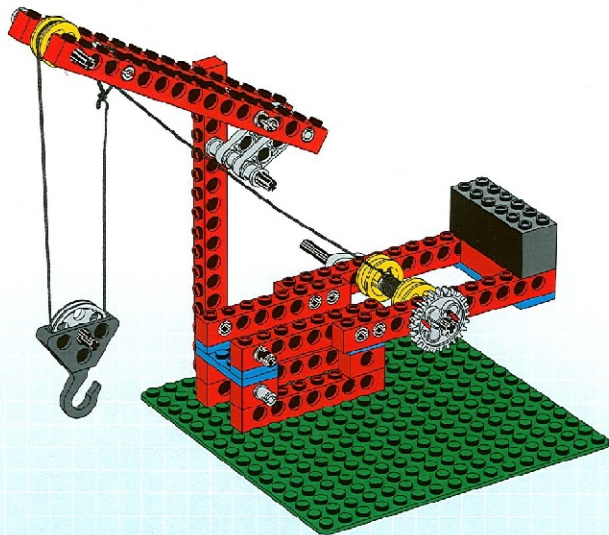

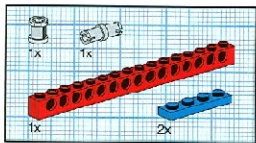

11

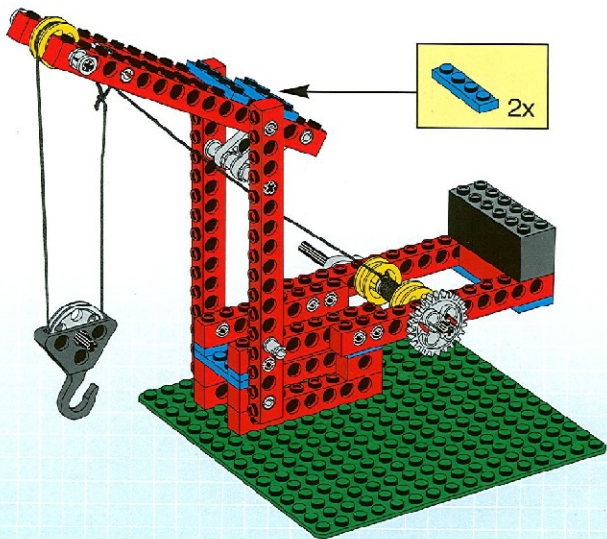

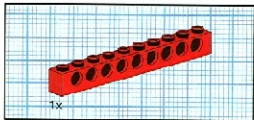

12

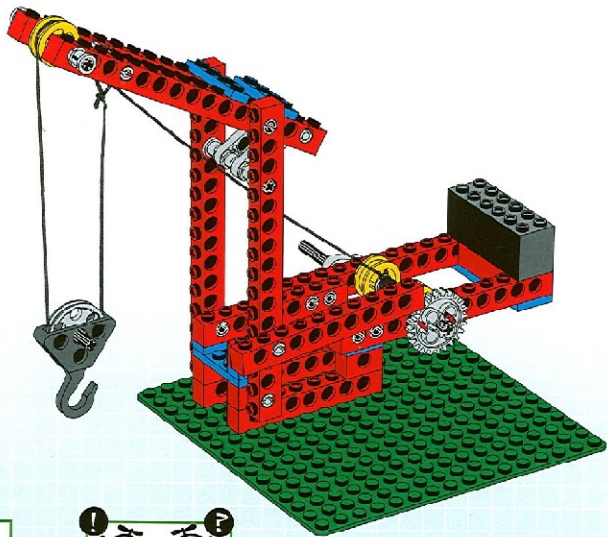

13

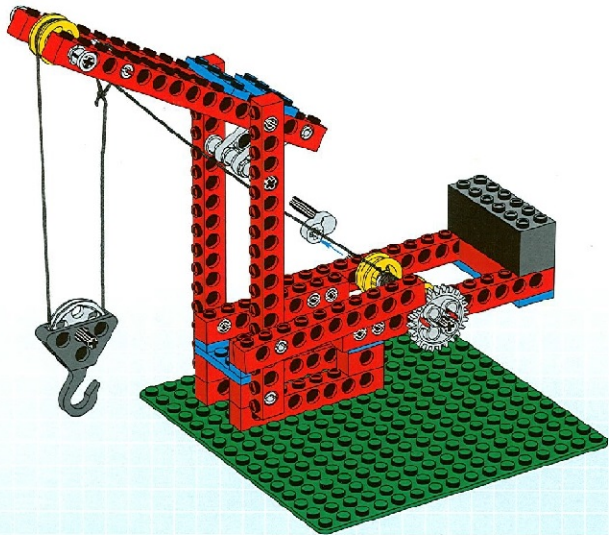



14

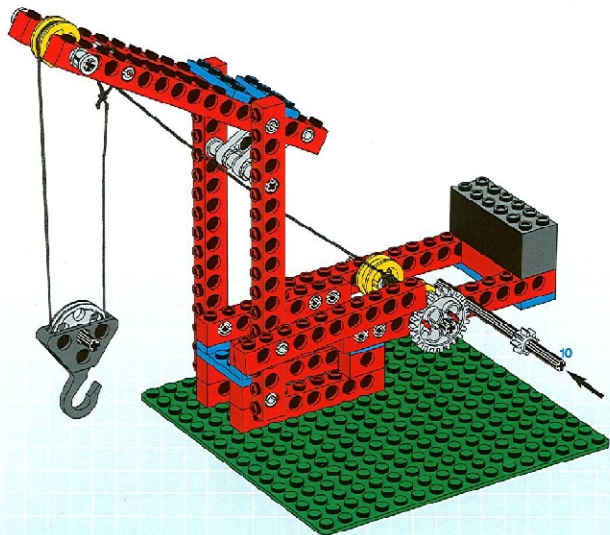



15

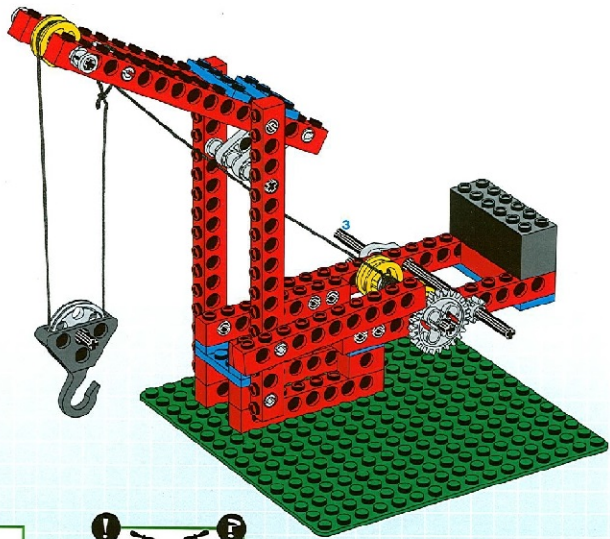

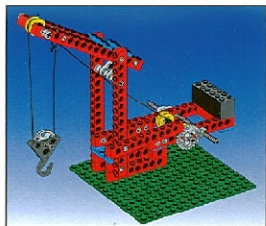

16

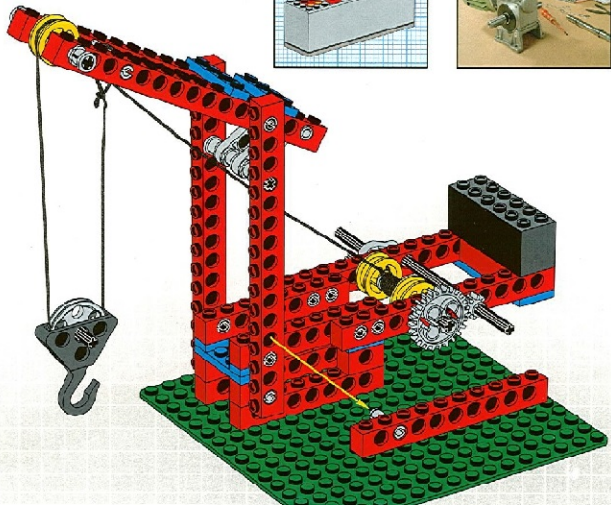

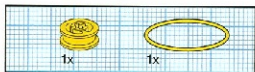

17

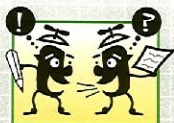
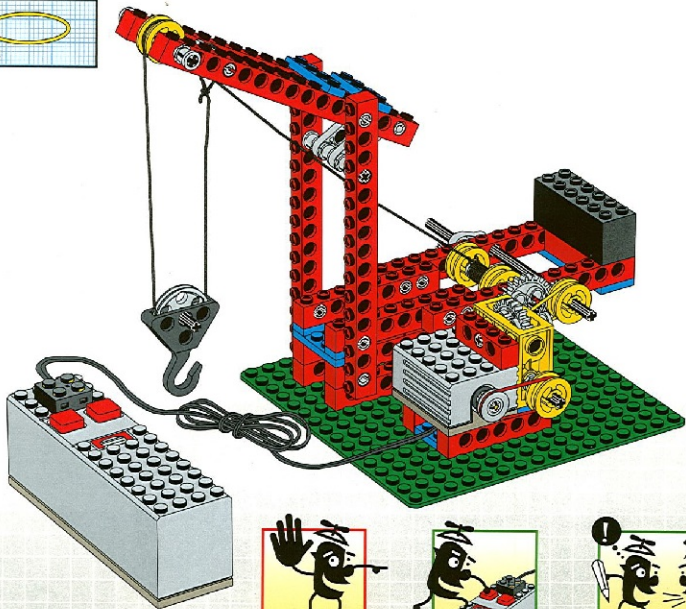

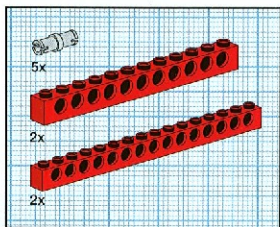

A.1

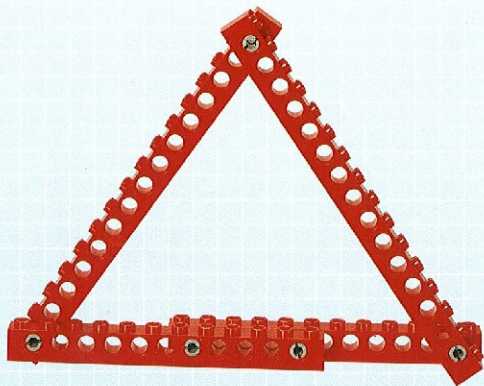

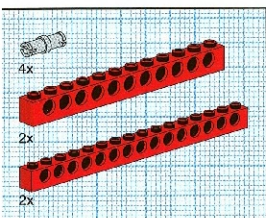

A.2

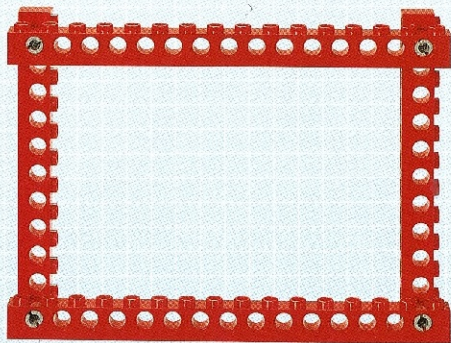

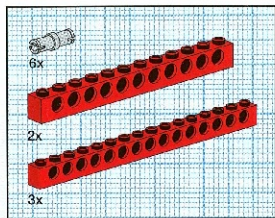

A.3

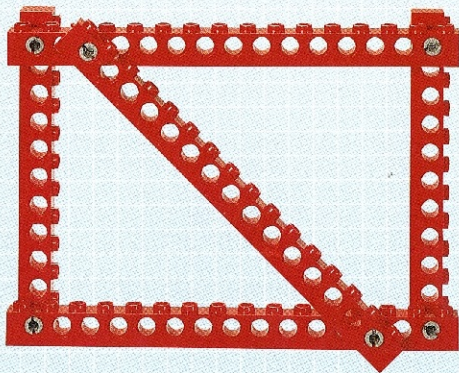

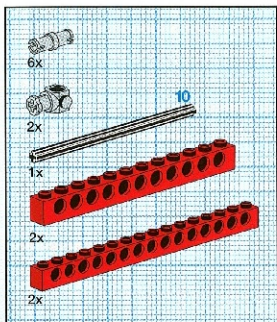

A.4

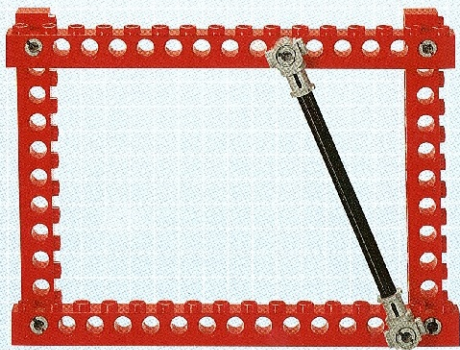

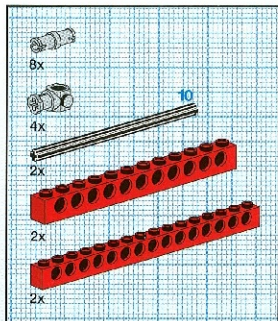

A.5

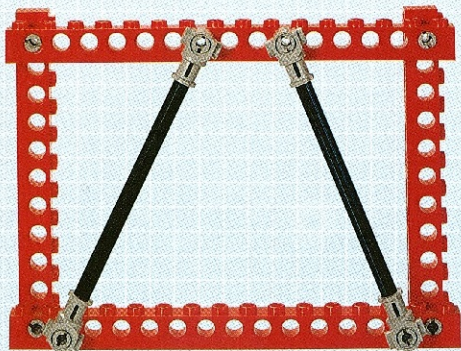

A.6

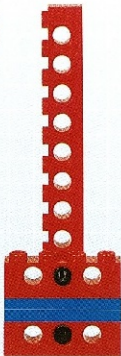

A.7

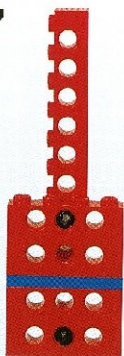

A.8



A.9

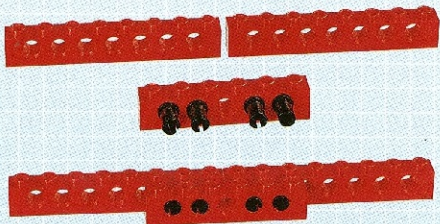

A.10



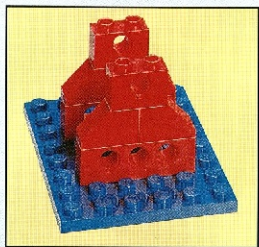
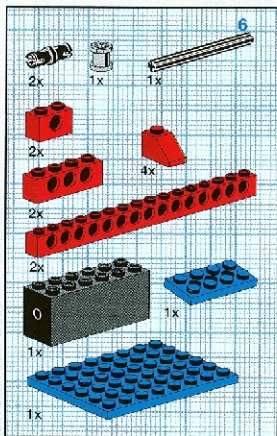
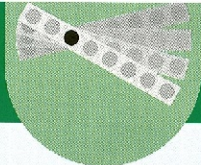

B.1

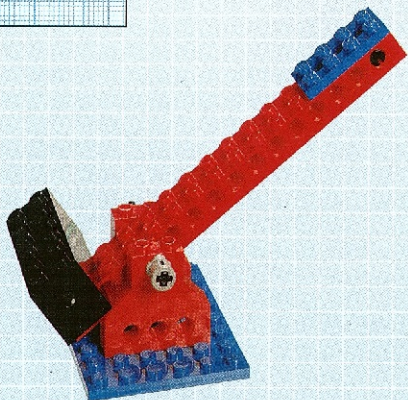

B.2

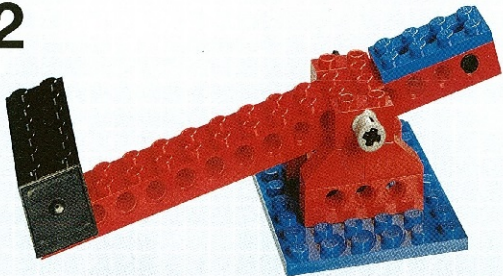

B.3

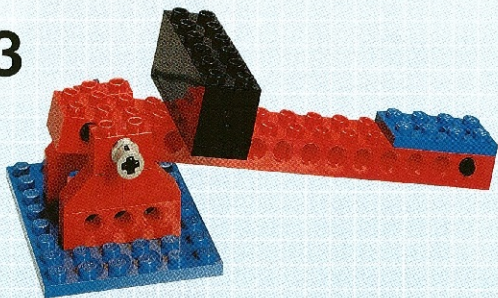

B.4

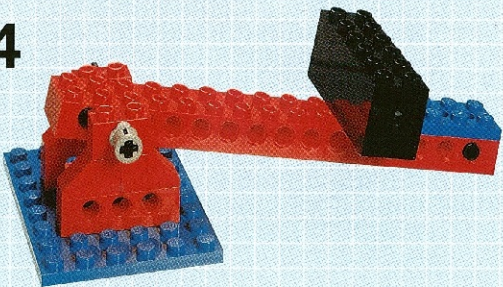

B.5

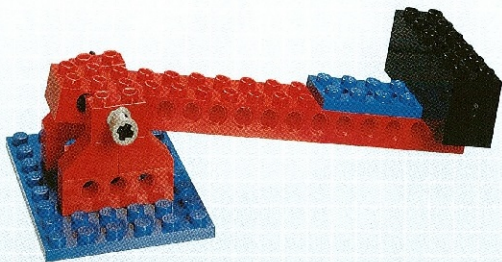

B.6

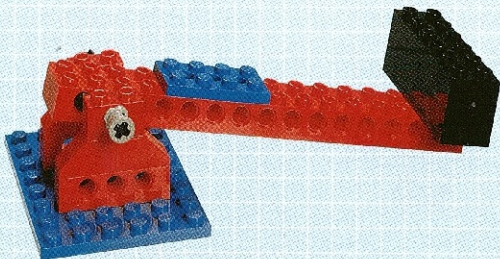

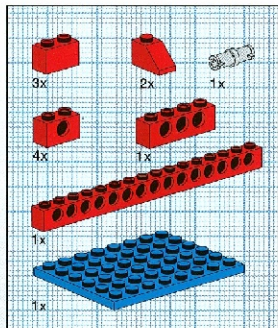

B.7

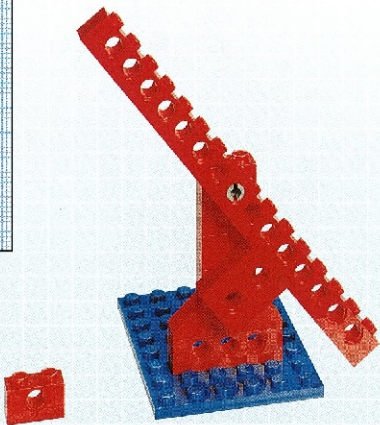

B.8

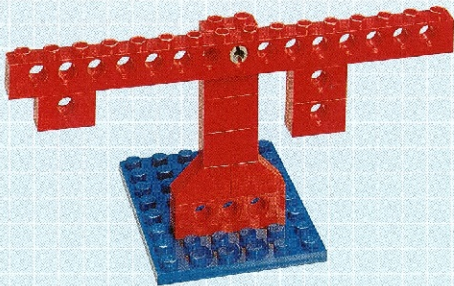

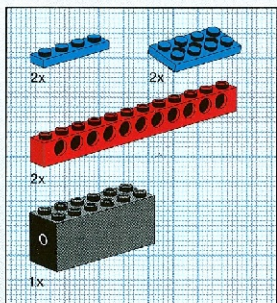

C.1

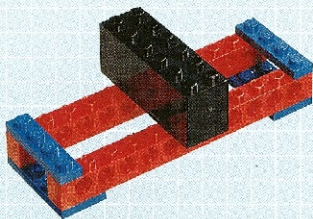

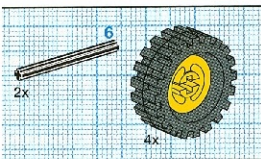

C.2

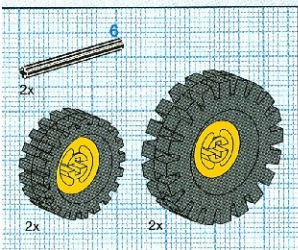
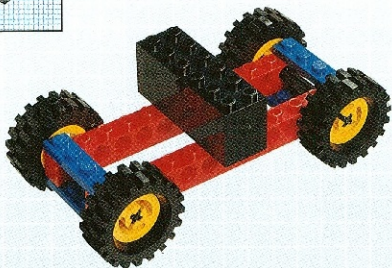

C.3

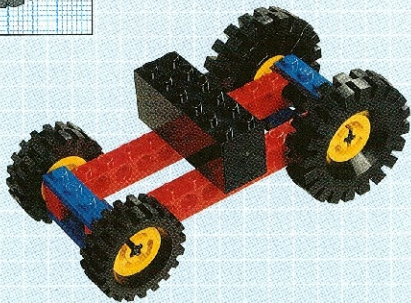

C.4

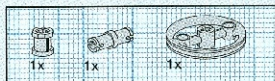
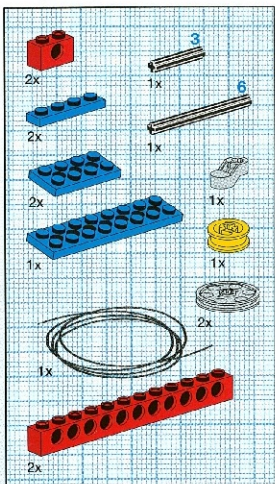
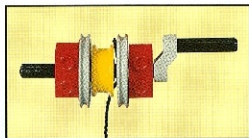

C.5



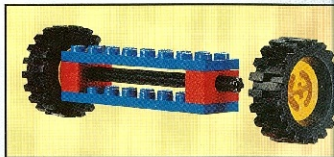
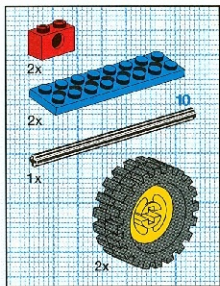

C.6

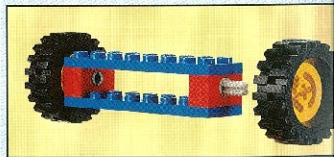
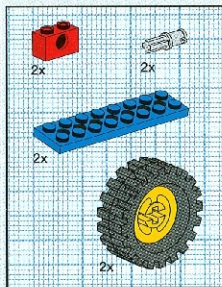

C.7

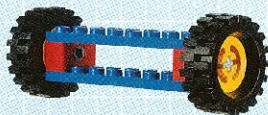

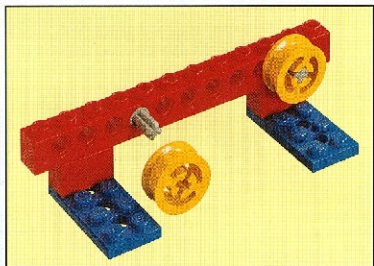
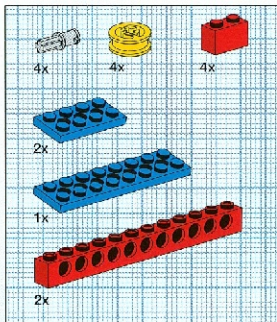

C.8

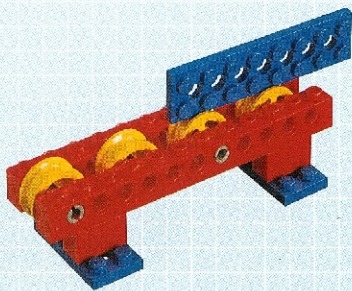

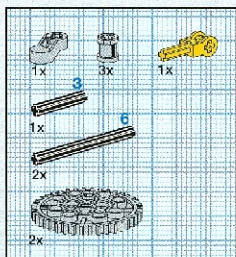
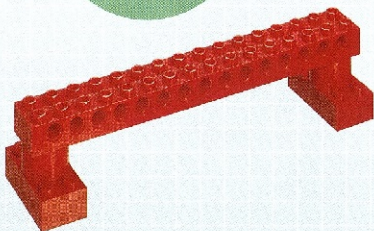
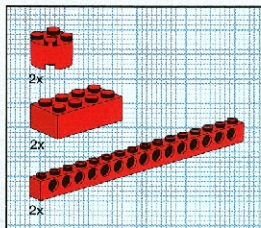

D.1

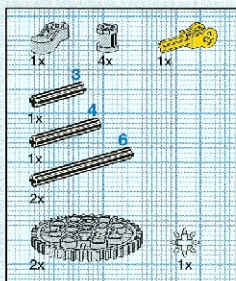
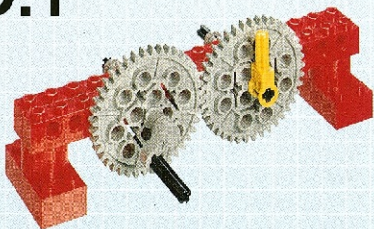

D.2

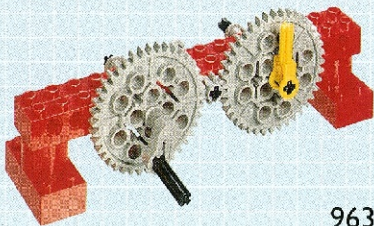

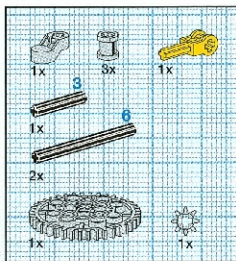

D.3

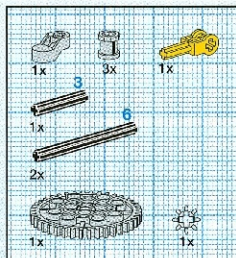
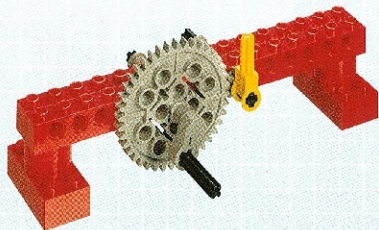

D.4



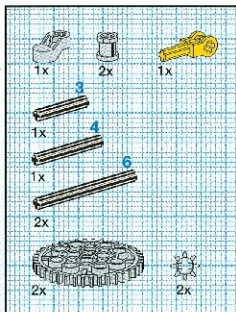

D.5

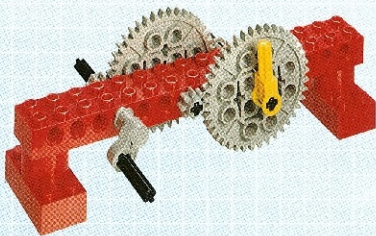

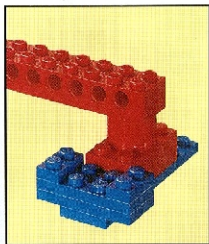
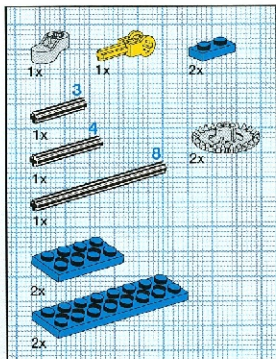

D.6

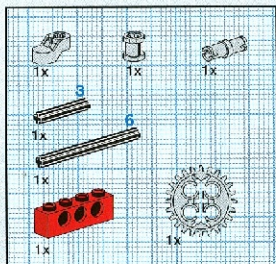
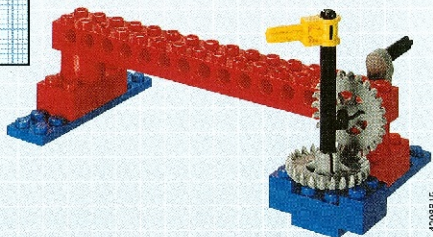

D.7

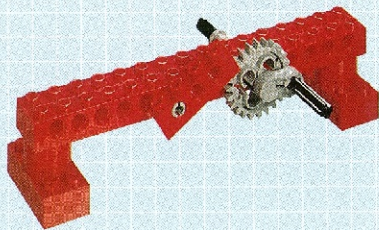

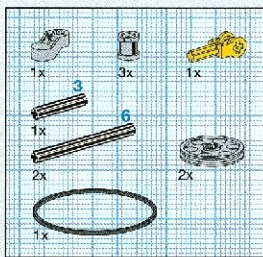
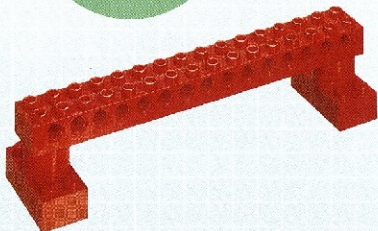
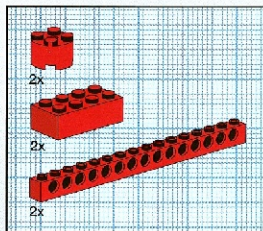

E.1

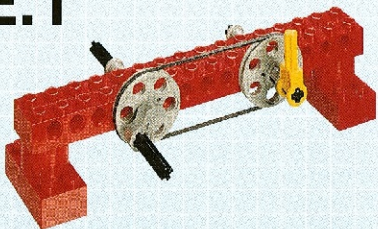

E.2

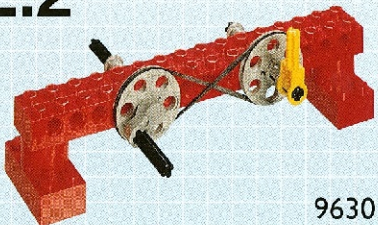

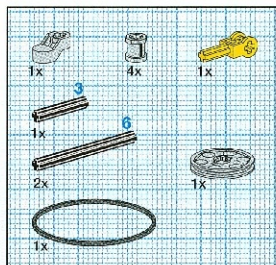

E.3

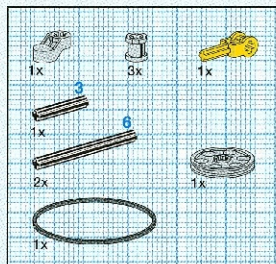
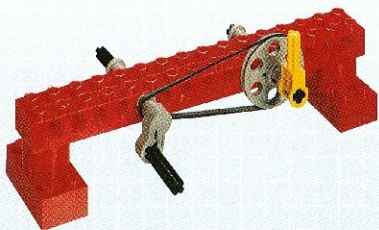

E.4

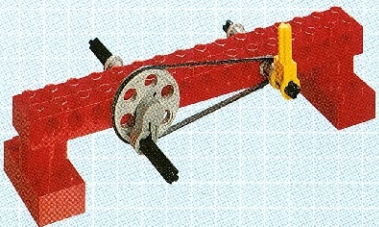

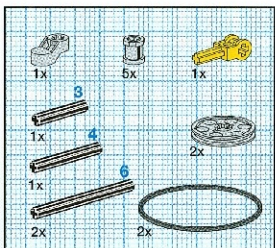

E.5

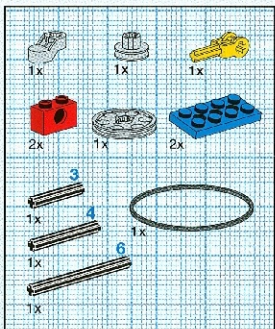
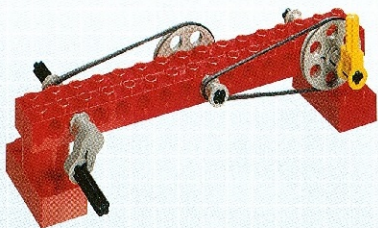

E.6

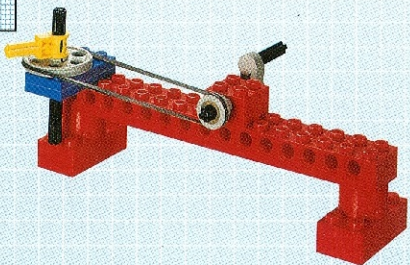

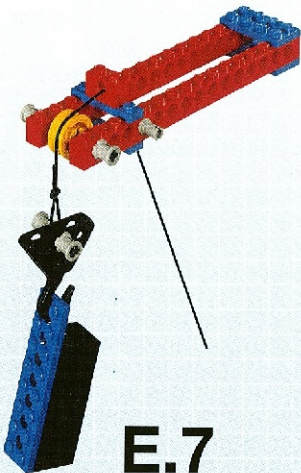
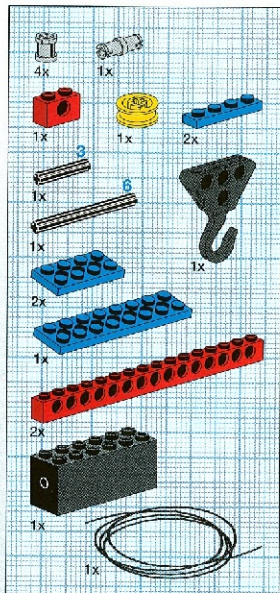

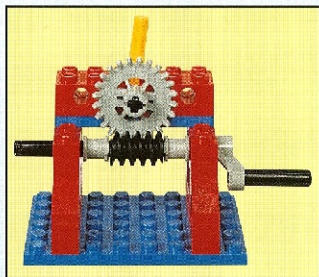
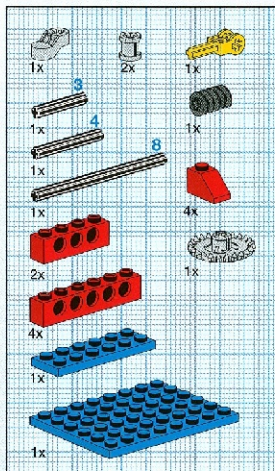

F.1



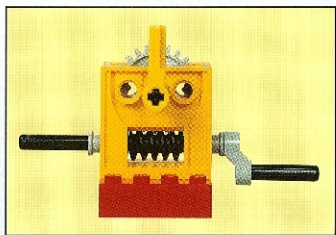
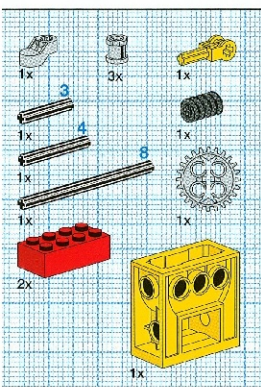

F.2



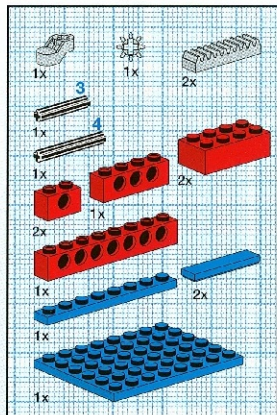

F.3

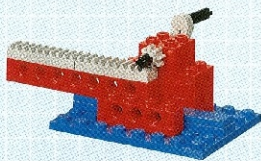

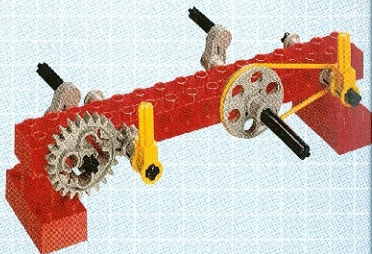
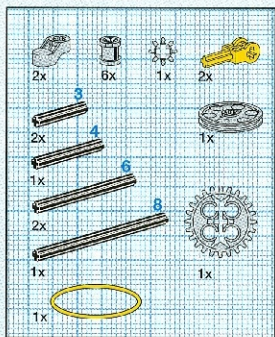
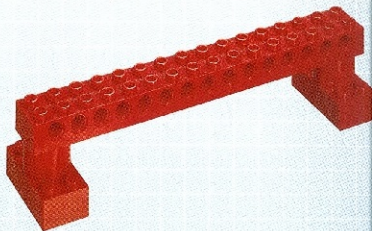
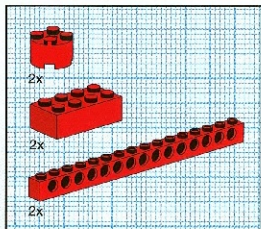

F.4

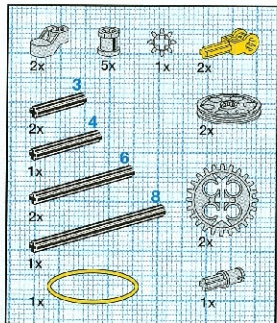

F.5

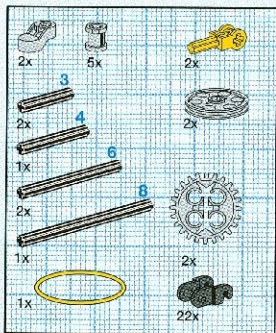
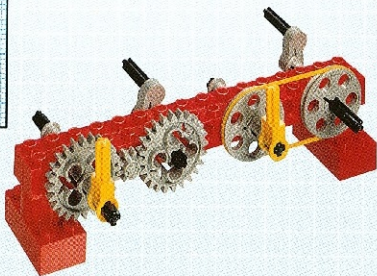

F.6

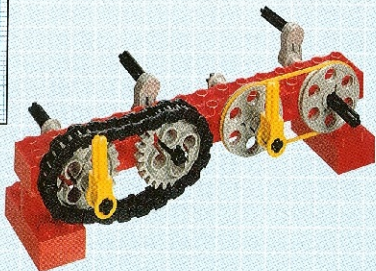

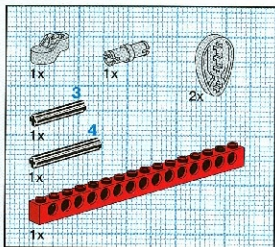

F.7-8

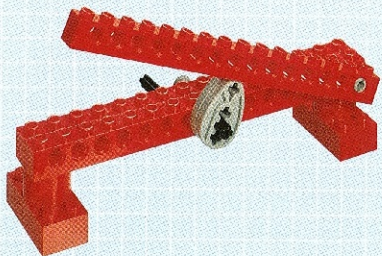
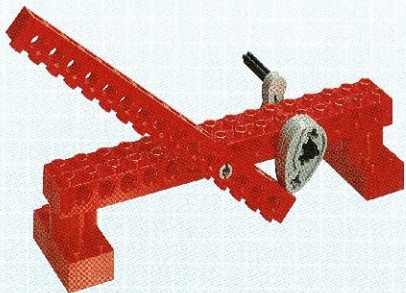



educational
division

9630 + 9615

G

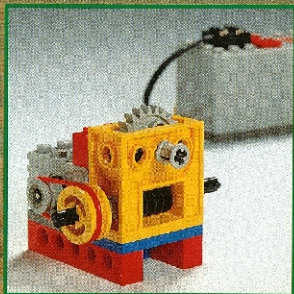

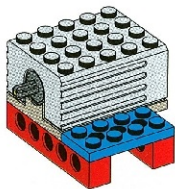
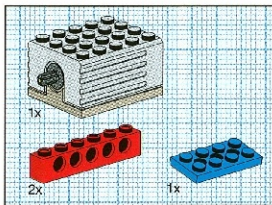
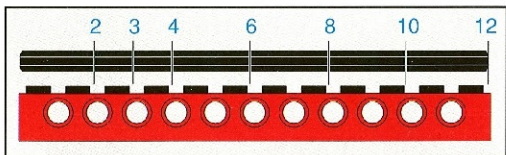

1

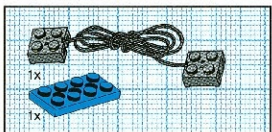

2

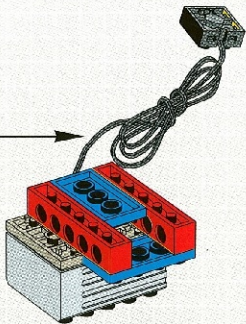
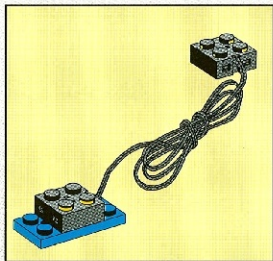



3

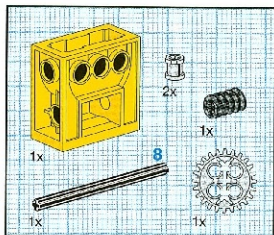

4

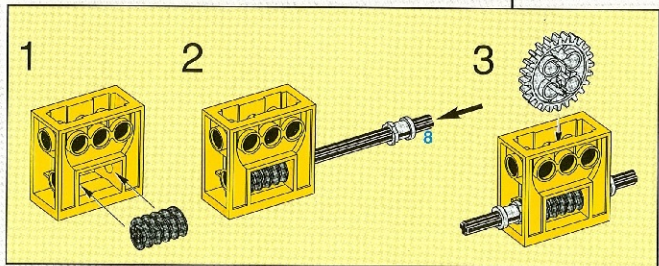

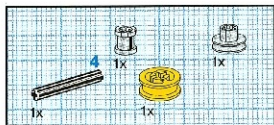

5



6

