



CITY

60052





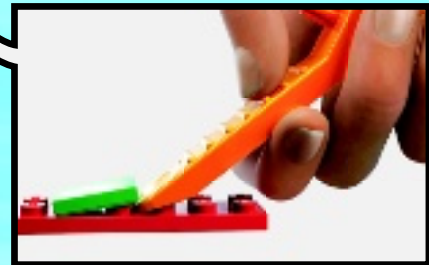
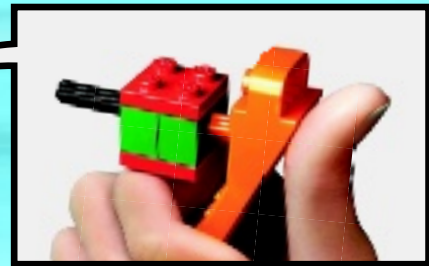
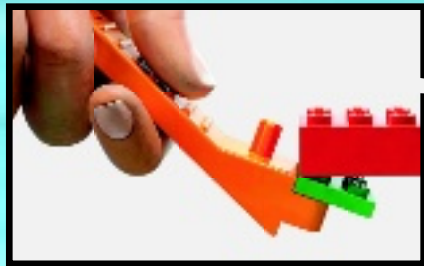

LEGO.com/brickseparator

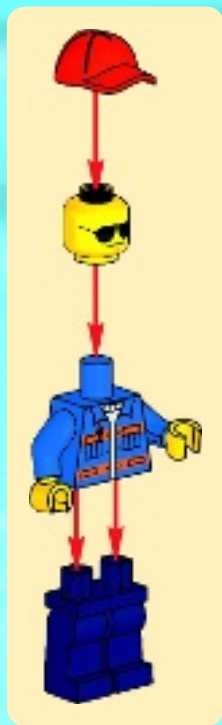



1x



1x

1



1



2





1x



1x

2

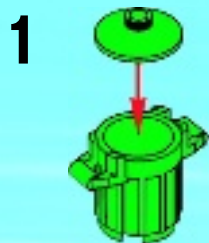

1x



1x

3

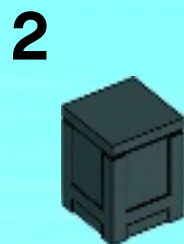
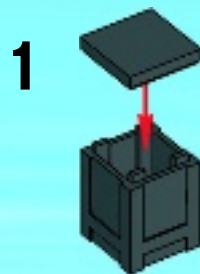

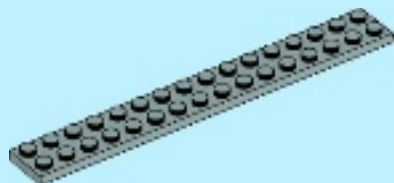

1x

1

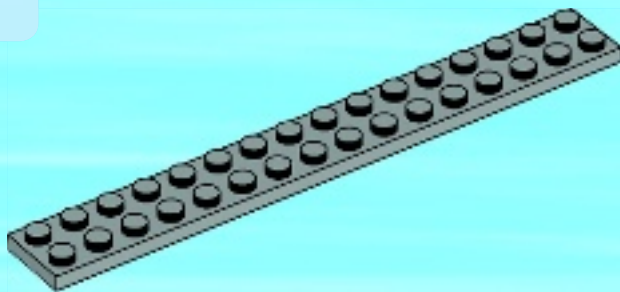



1x



2x

2

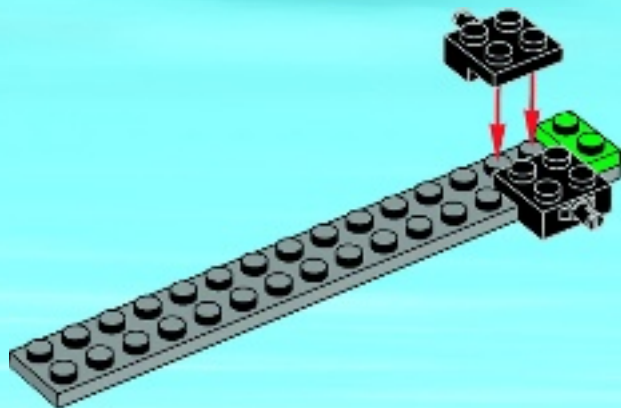



2x

3

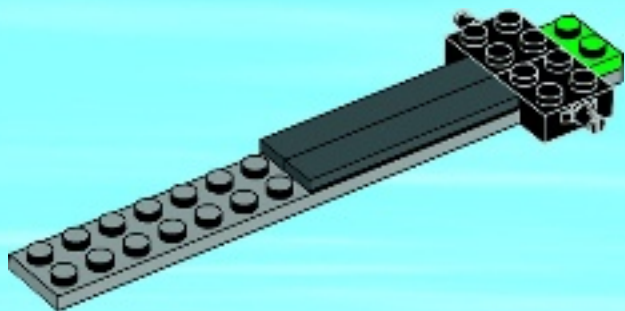

1x



1x



1x

4

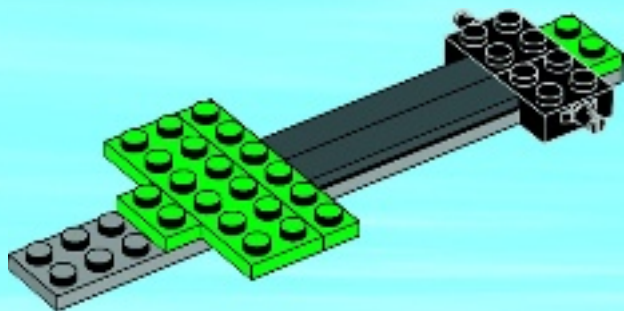



1x



2x

5

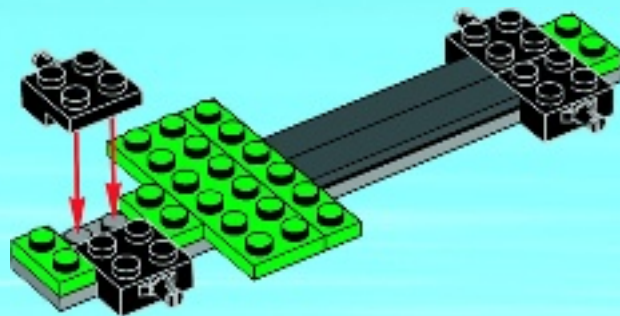

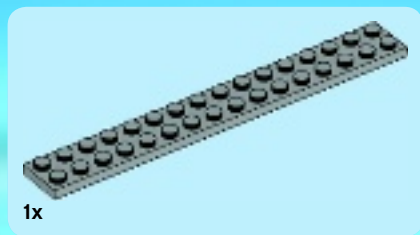

6

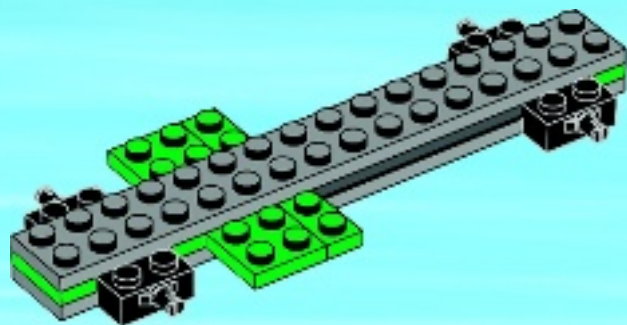



2x

7

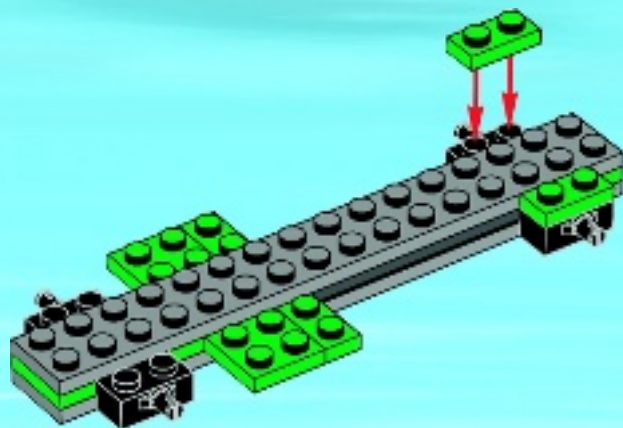



1x



1x

8

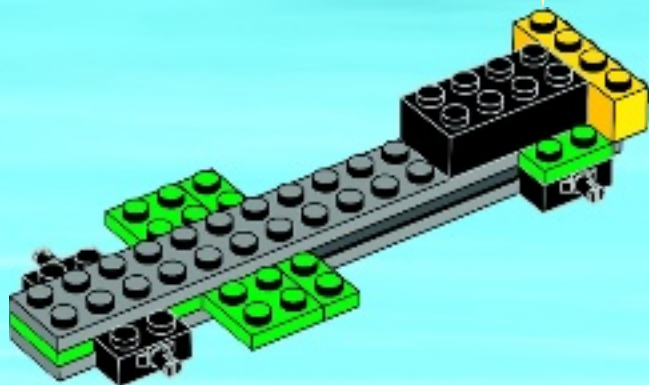
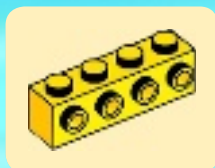



2x

9

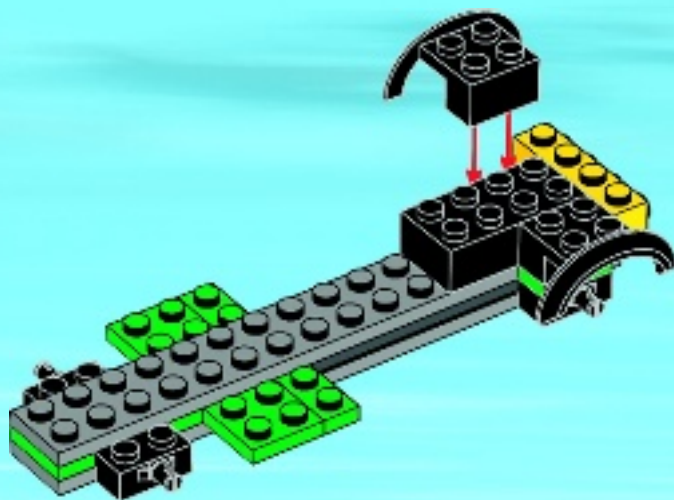



2x



2x



2x

10

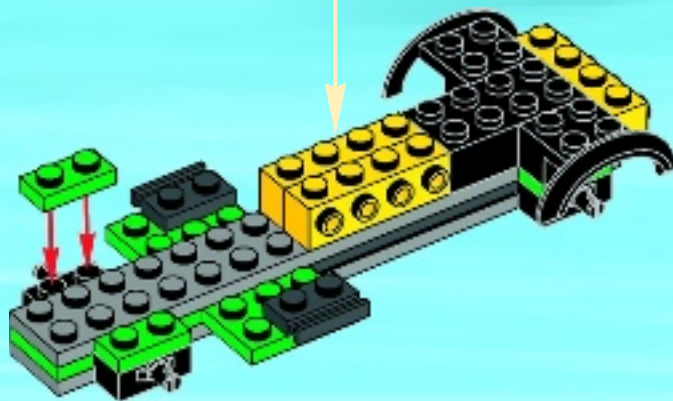
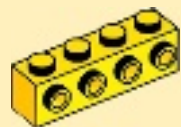



1x



2x

11

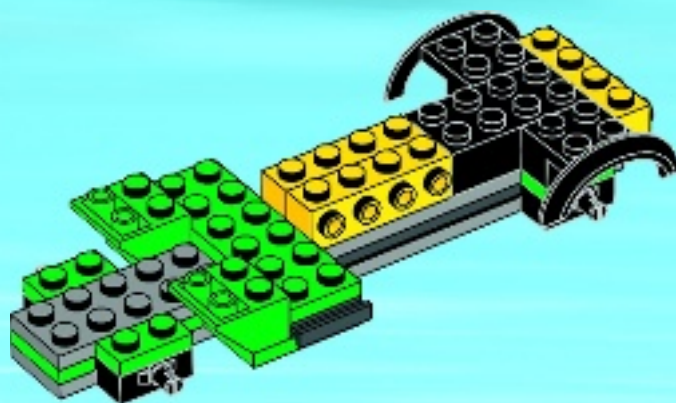



2x



1x

12

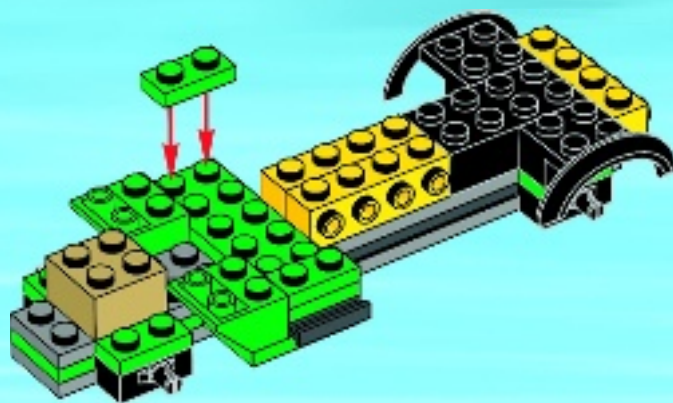



13

1

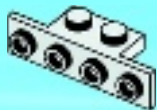

2

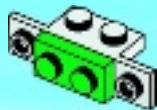

3

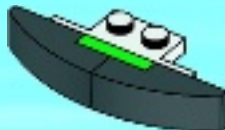

4



5

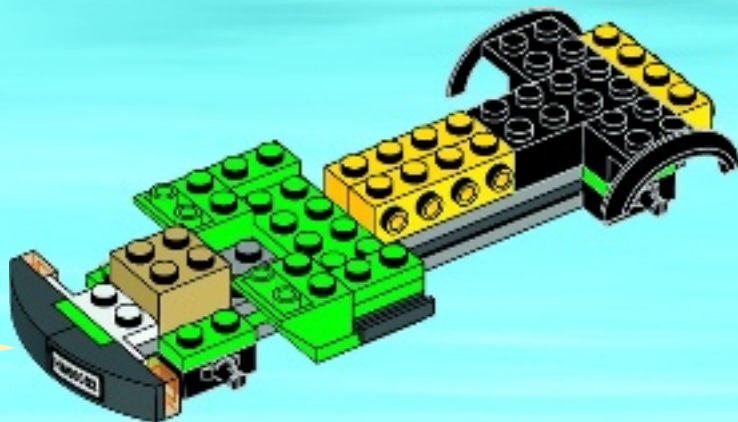



1x



1x

14

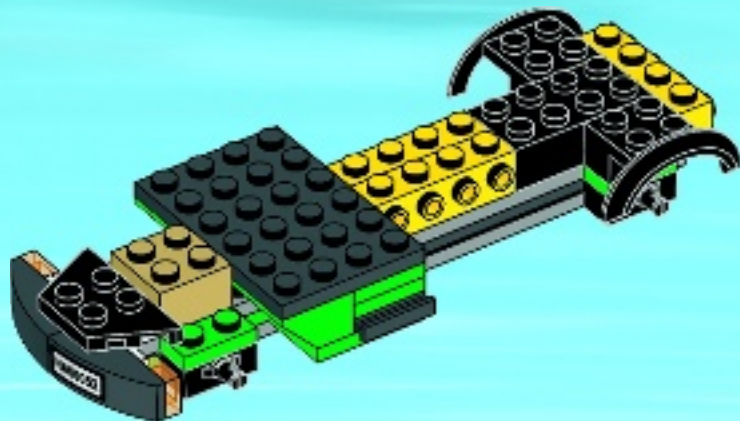



2x

15

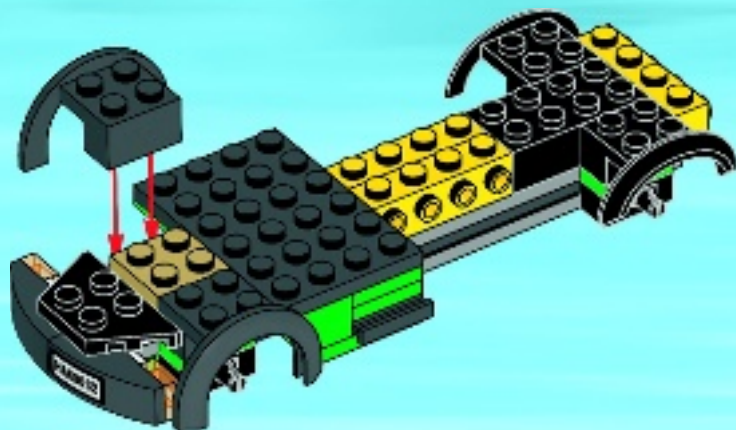



2x



1x



1x

16

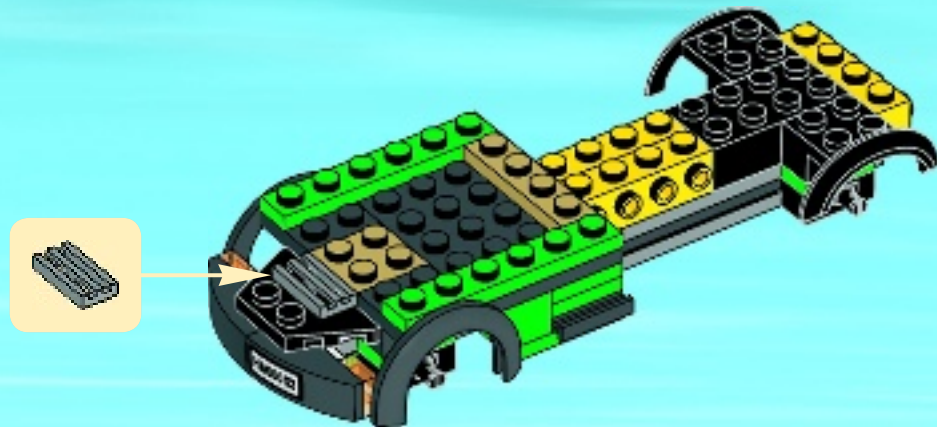

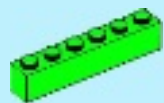

1x



1x



1x

17

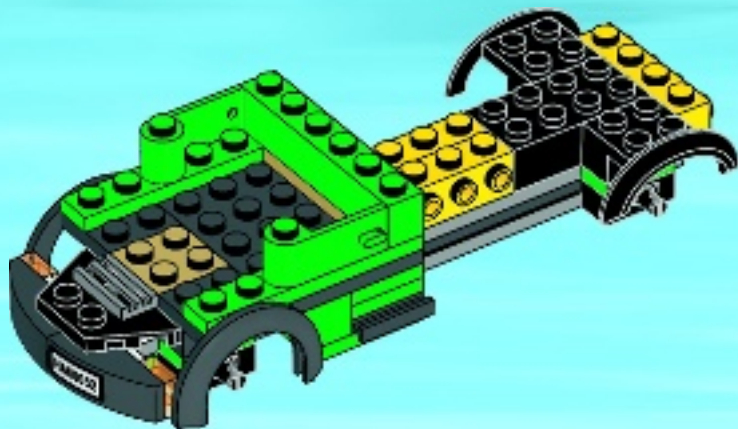



1x

18

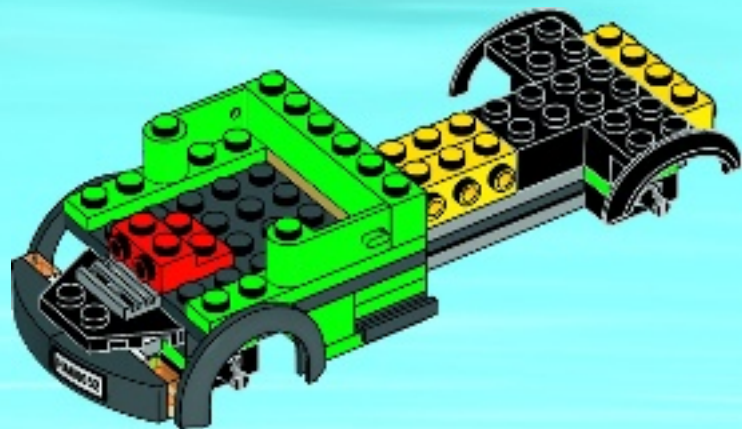



1x



1x

19

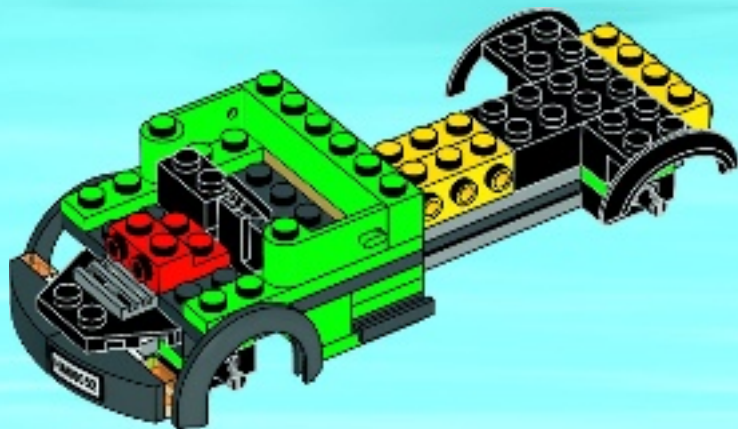



2x



2x

20

1

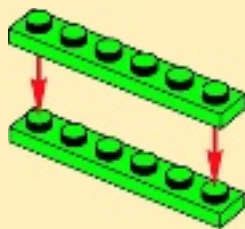

2

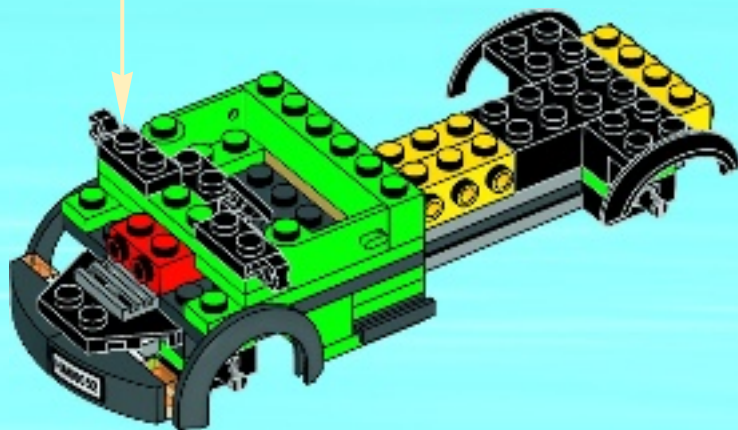
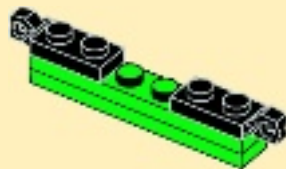



1x

21

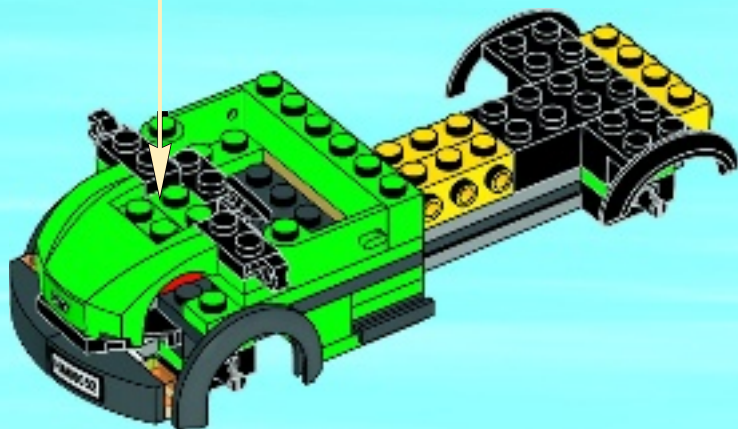



1x

22

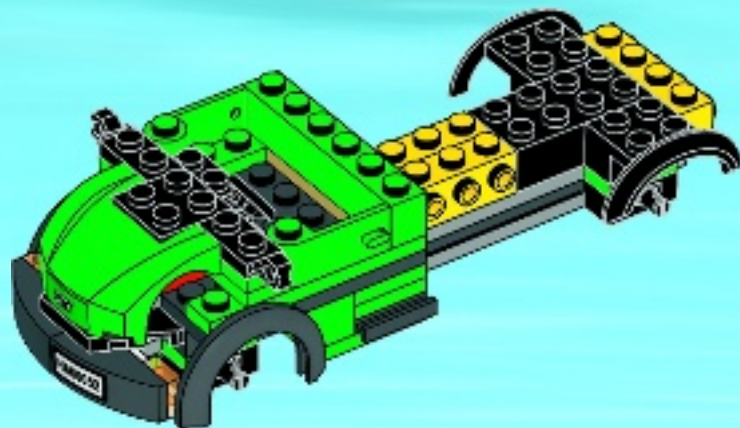



1x



2x

23

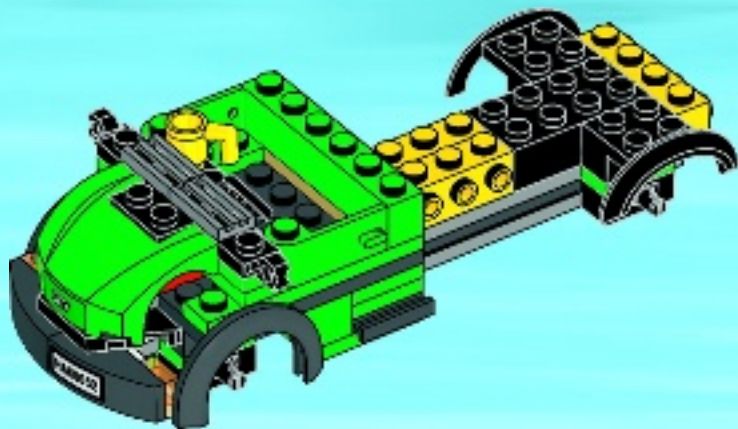



1x



1x



1x

1

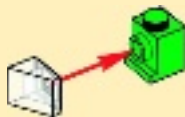

2



24

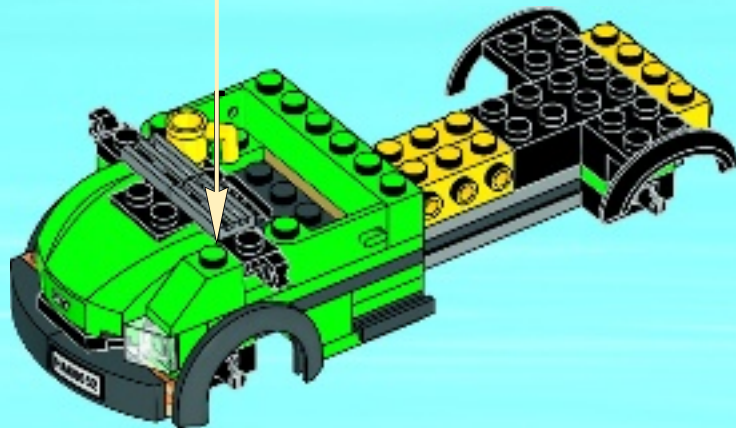



1x



1x



1x

1



2



25

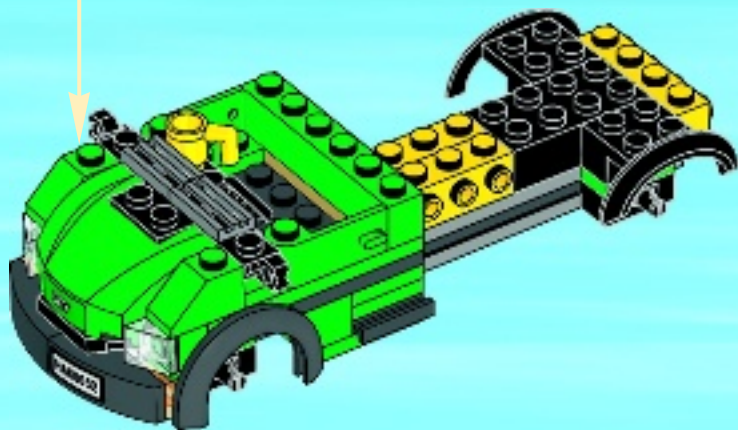

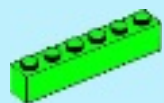

2x

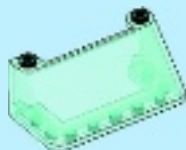

1x

26

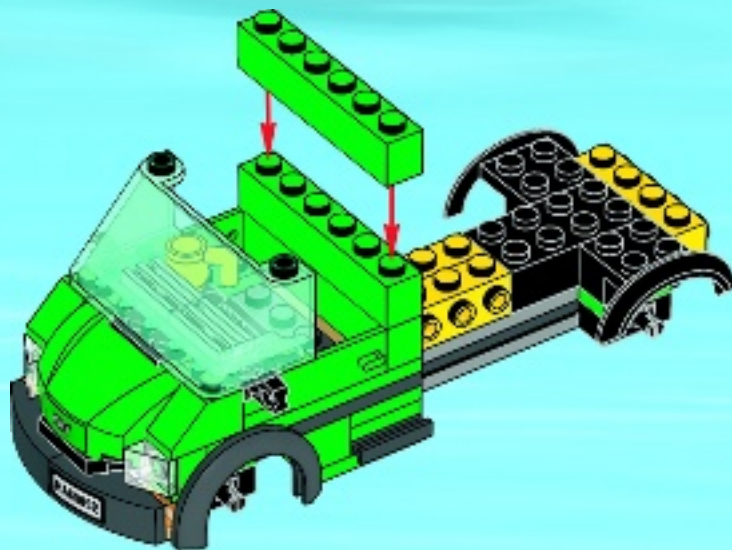

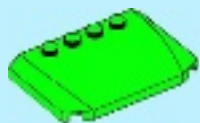

1x

1

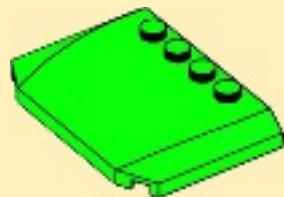

2



27

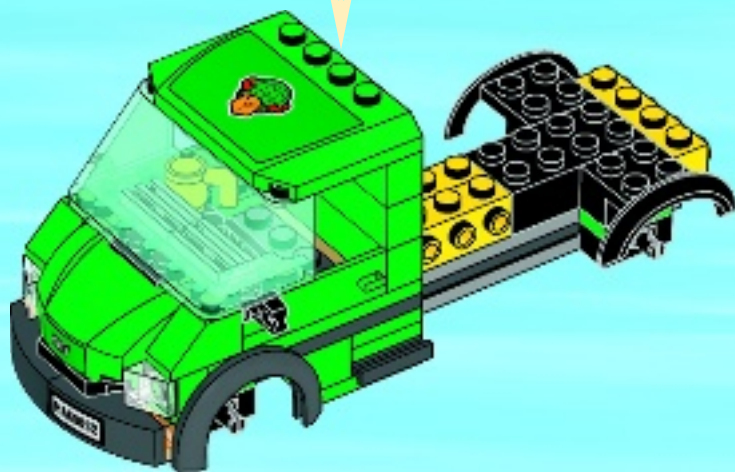



1x

1



2



28

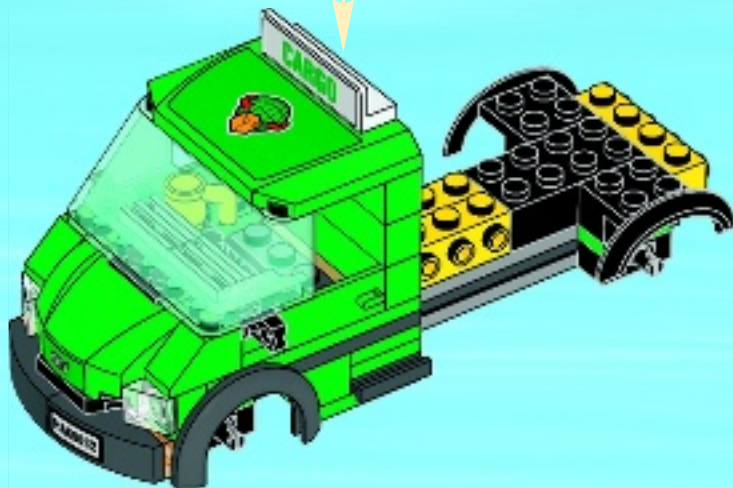



2x



2x



2x



2x



2x

29

1

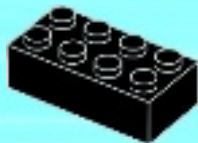

2

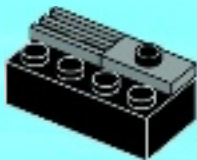

3

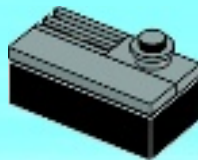

2x

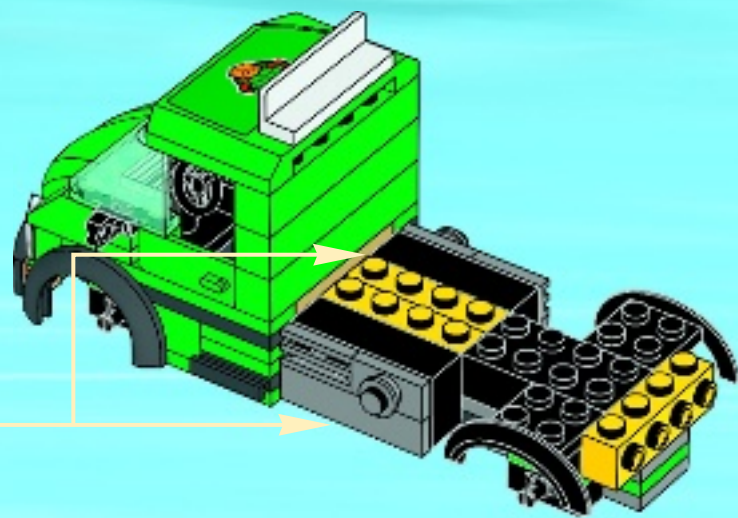



1x



2x



2x



1x



1x

30

1

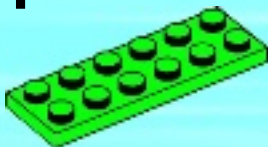

2

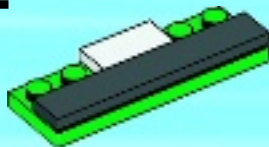

3

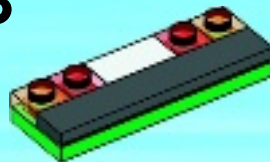

4

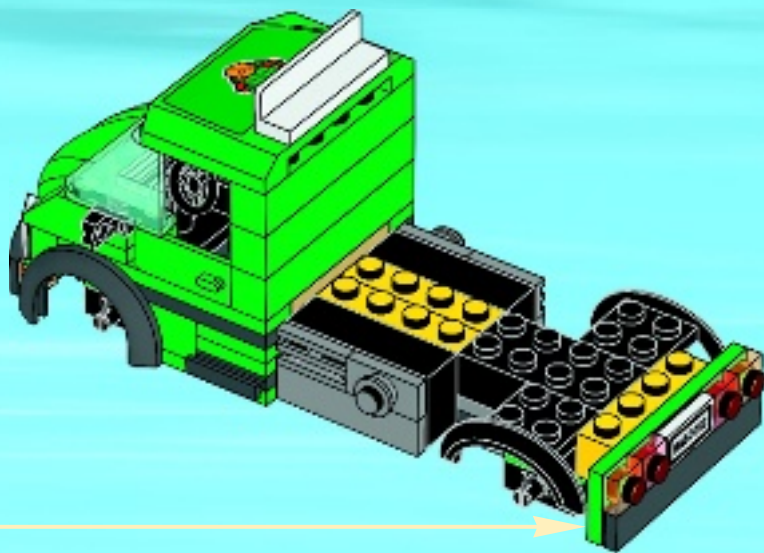
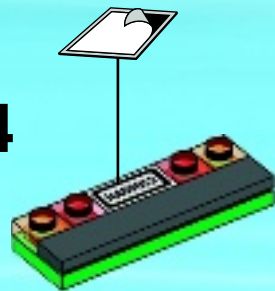

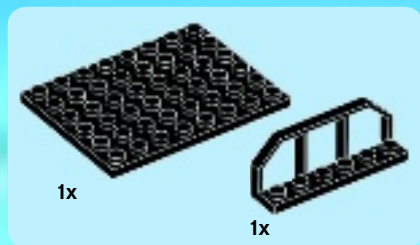

31

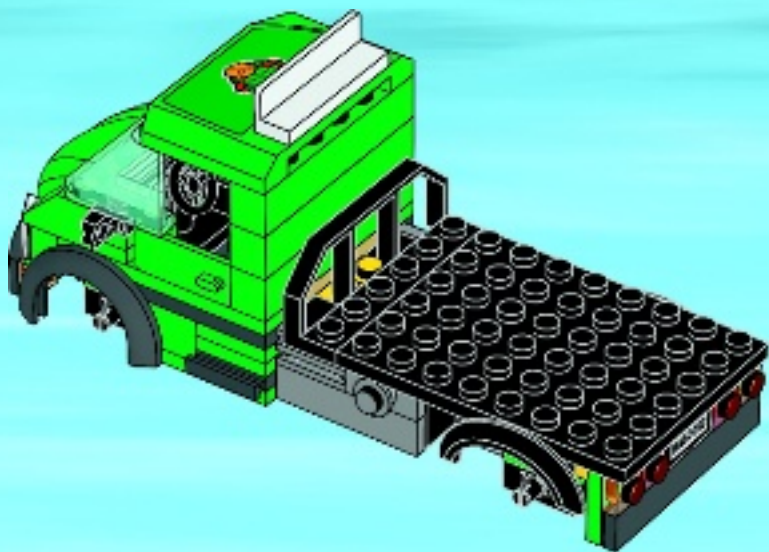



4x

32

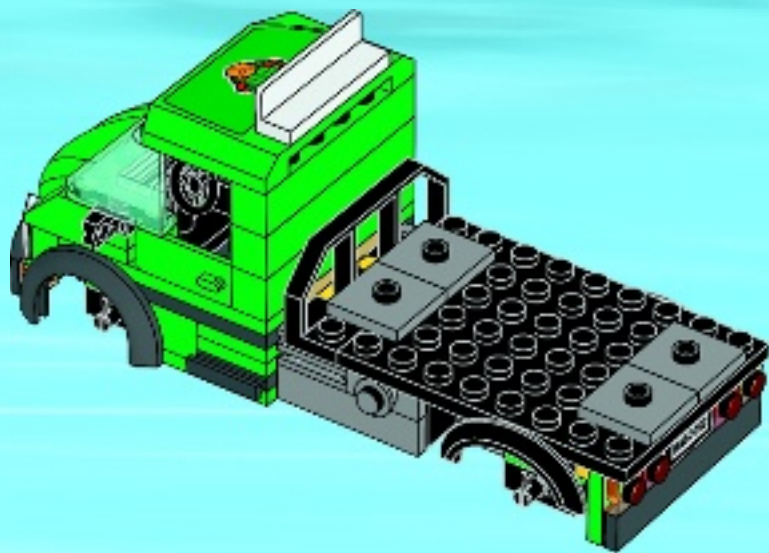



2x



2x

33

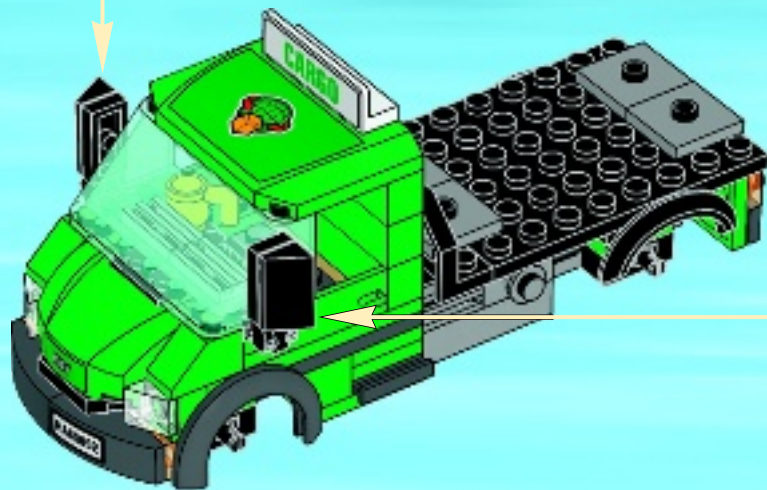



4x



4x

34



4x

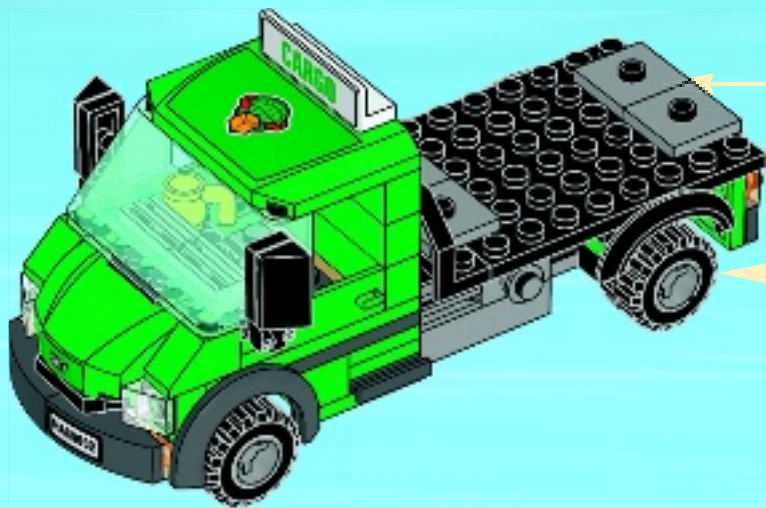

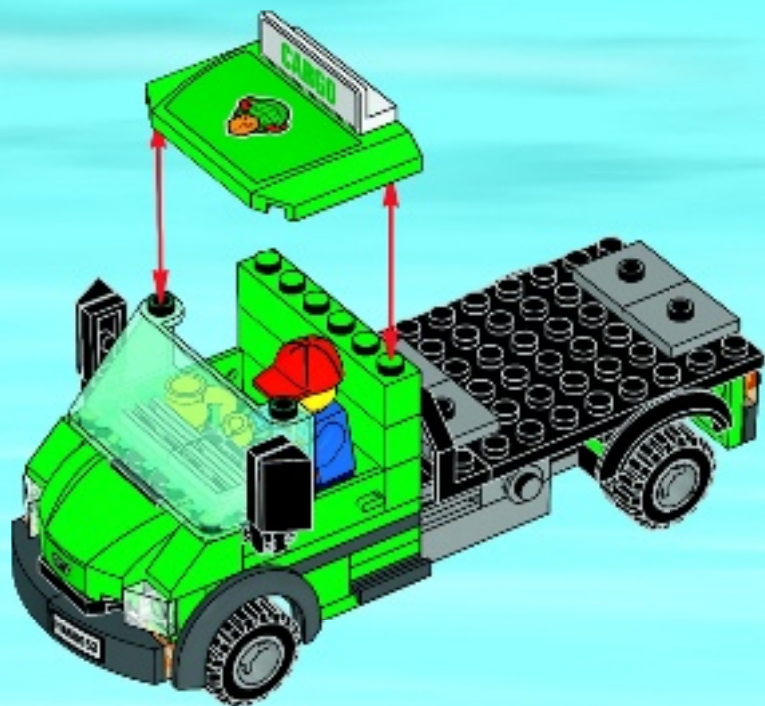

WIN

GO TO WWW.LEGO.COM/PRODUCTFEEDBACK AND
GIVE US YOUR SHORT **FEEDBACK** ABOUT THIS
LEGO® SET FOR A CHANCE TO WIN
A COOL LEGO PRIZE.



LEGO.com/productfeedback

GEWINNE



Erzähle uns auf
www.LEGO.com/productfeedback

etwas über die Erfahrungen, die du mit
diesem LEGO® Set gemacht hast, und
sichere dir die Chance auf einen coolen
LEGO Preis!

GAGNE



Rends-toi sur
www.LEGO.com/productfeedback

et donne-nous quelques commentaires
sur ce produit LEGO® pour avoir une
chance de gagner un prix LEGO !

GANAN



Visita
www.LEGO.com/productfeedback

y envíanos tu opinión acerca de este set
LEGO®. ¡Participarás en el sorteo de un
premio LEGO!

获取奖品



登录
www.LEGO.com/productfeedback

给出关于此乐高®套装的简短反馈，
就有机会获得炫酷乐高奖品

LEGO and the LEGO logo are trademarks of the LEGO Group. ©2014 The LEGO Group.

6124196



CITY

60052



 [LEGO.com/city](https://www.lego.com/city)

EN

Important information about batteries

Never use different types of batteries together, or a combination of old and new batteries. Always remove the batteries if the product is not to be used for a long time or if the batteries have run down. Never use damaged batteries. Only use batteries of the type recommended, or a corresponding type. Insert the batteries so that the poles are correctly positioned. Rechargeable batteries must be recharged using the correct battery charger under the supervision of an adult. You cannot recharge batteries while they are still in the product, and you must never try to do so. Never attempt to recharge non-rechargeable batteries. Never short-circuit the battery holder.

DE

Wichtige Information zu Batterien

Benutzen Sie niemals unterschiedliche Arten von Batterien oder alte und neue gleichzeitig. Nehmen Sie stets die Batterien heraus, wenn mit dem Modell längere Zeit nicht gespielt wird oder wenn die Batterien leer sind. Verwenden Sie niemals beschädigte Batterien. Verwenden Sie ausschließlich empfohlene bzw. geeignete Batterien. Achten Sie beim Einsetzen der Batterien auf die richtige Polung. Wiederaufladbare Batterien sollten mit einem geeigneten Ladegerät aufgeladen werden – unter Aufsicht eines Erwachsenen. Wiederaufladbare Batterien können und sollten niemals aufgeladen werden, während sie sich im Modell befinden. Versuchen Sie unter keinen Umständen, „normale“ Batterien wieder aufzuladen. Schließen Sie das Batteriefach niemals kurz.

FR

Informations importantes concernant les piles

Ne jamais utiliser un mélange de différents types de piles, ou de piles neuves et de piles anciennes ou déjà utilisées. Toujours retirer les piles si le produit n'est pas utilisé durant une période prolongée ou si les piles sont vides. Ne jamais utiliser de piles endommagées. Utiliser uniquement des piles du type recommandé ou d'un type équivalent. En insérant les piles, respecter scrupuleusement le sens d'orientation des pôles (+/-). Les piles rechargeables doivent être rechargées en utilisant un chargeur de piles adéquat et sous la surveillance d'un adulte. Il est impossible de recharger les piles quand elles sont installées dans le produit. Ne jamais tenter de le faire. Ne jamais essayer de recharger des piles non-rechargeables. Ne jamais court-circuiter le compartiment des piles.

IT

Importanti informazioni sulle batterie

Non usare mai contemporaneamente batterie di tipo diverso o batterie nuove e usate insieme. Rimuovere sempre le batterie qualora il prodotto non venga utilizzato per periodi prolungati, oppure se le batterie sono esauste. Non utilizzare mai batterie danneggiate. Usare esclusivamente batterie del tipo raccomandato o un equivalente. Inserire le batterie avendo cura che la loro polarità sia corretta. Le batterie ricaricabili vanno ricaricate in un caricabatterie di tipo idoneo e con la supervisione di un adulto. Non è possibile e non bisogna mai tentare di ricaricare le batterie mentre queste sono inserite nel prodotto. Non tentare mai di ricaricare batterie non ricaricabili. Non cortocircuitare mai il portabatterie.

NL

Belangrijke informatie over batterijen

Gebruik nooit verschillende soorten of een combinatie van oude en nieuwe batterijen tegelijkertijd. Verwijder de batterijen altijd als je het product lange tijd niet wilt gebruiken of als de batterijen leeg zijn. Gebruik nooit beschadigde batterijen. Gebruik uitsluitend batterijen van het aanbevolen type of een overeenkomstig type. Plaats de batterijen met de polen in de juiste richting. Oplaadbare batterijen moeten in een voor dit doel bestemde oplader en onder toezicht van een volwassene opnieuw worden opgeladen. Oplaadbare batterijen kunnen niet worden opgeladen terwijl ze zich nog in het product bevinden en dit mag ook nooit worden geprobeerd. Probeer nooit niet-oplaadbare batterijen opnieuw op te laden. Laat de batterijhouder nooit kortsluiten.

ES

Información importante acerca de las pilas

No use pilas de diferentes tipos ni pilas nuevas y antiguas para alimentar el producto. Extraiga las pilas del producto si este va a permanecer sin uso durante un período prolongado de tiempo o aquellas se han agotado. No use pilas dañadas. Use sólo pilas del tipo recomendado u otro equivalente. Inserte las pilas de modo que los polos queden situados en las posiciones correctas. La carga de pilas recargables debe tener lugar empleando un cargador apropiado y bajo la supervisión de un adulto. Las pilas recargables no se pueden cargar mientras permanecen insertadas en el producto; no intente hacerlo. No trate de cargar pilas no recargables. No cortocircuite el compartimento de las pilas.

DA

Vigtige oplysninger om batterier

Brug aldrig forskellige batterityper sammen eller en kombination af gamle og nye batterier. Fjern altid batterierne, hvis produktet ikke skal bruges i lang tid, eller hvis batterierne er flade. Brug aldrig beskadigede batterier. Brug kun den anbefalede type batterier eller en tilsvarende type. Sæt batterierne i, så polerne vender den rigtige vej. Genopladelige batterier skal oplades i den rigtige batterioplader. Batterierne skal sættes i opladeren under opsyn af en voksen. Batterierne kan ikke oplades, mens de stadig sidder i produktet, og man må aldrig forsøge at gøre det. Forsøg aldrig at oplade ikke-genopladelige batterier. Kortslut aldrig batteriholderen.

FI

Tärkeää tietoa paristoista

Älä koskaan käyttää erityyppisiä paristoja yhdessä. Älä myöskään käytä samassa laitteessa sekä vanhoja että uusia paristoja. Poista paristot tuotteesta aina, kun se on pitemmän aikaa käyttämättä, tai kun paristot ovat tyhjentyneet. Älä koskaan käytä viallisia paristoja. Käytä vain tuotteesta suositeltuja tai vastaavantyyppisiä paristoja. Aseta paristot siten, että navat osoittavat oikeaan suuntaan. Ladattavat paristot on ladattava oikeanlaisella laturilla aikuisen valvonnassa. Ne on poistettava tuotteesta lataamisen ajaksi. Älä koskaan yritä ladata paristoja, joita ei ole tarkoitettu ladattaviksi. Älä koskaan aiheuta oikosulkua pariston kosketinten välillä.

SV

Viktig information om batterier

Använd aldrig olika sorters batterier samtidigt, och inte heller en kombination av gamla och nya batterier. Ta alltid ur batterierna om produkten inte ska användas under en längre tid eller om batterierna är slut. Använd aldrig skadade batterier. Använd bara batterier av den typ som rekommenderas, eller av en motsvarande typ. Sätt i batterierna så att polerna hamnar i rätt läge. Laddningsbara batterier måste laddas med rätt slags batteriladdare och under en vuxens överinseende. Du kan inte ladda batterierna medan de fortfarande sitter i produkten, och du får heller aldrig försöka göra det. Försök aldrig ladda icke laddningsbara batterier. Kortslut aldrig batteriutrymmets kontaktkyter.

PT

Informação importante sobre as pilhas

Nunca use diferentes tipos de pilhas em simultâneo, ou uma combinação de pilhas usadas e novas. Retire sempre as pilhas se o produto não for usado durante muito tempo ou se as pilhas já não tiverem carga. Nunca use pilhas danificadas. Use apenas pilhas do tipo recomendado ou de um tipo correspondente. Insira as pilhas de forma a que os pólos fiquem corretamente posicionados. As pilhas recarregáveis devem ser recarregadas com o carregador de pilhas correto e sob a supervisão de um adulto. Não pode recarregar as pilhas enquanto as mesmas se encontram colocadas no produto e nunca deve tentar fazê-lo. Nunca tente recarregar pilhas não recarregáveis. Nunca deixe o compartimento das pilhas entrar em curto-circuito.

EL

Σημαντικές πληροφορίες για τις μπαταρίες

Μην χρησιμοποιείτε ποτέ διαφορετικούς τύπους μπαταριών μαζί και μην συνδυάζετε παλιές και καινούριες μπαταρίες. Αφαιρείτε πάντα τις μπαταρίες αν δεν σκοπεύετε να χρησιμοποιήσετε το προϊόν για αρκετό καιρό ή αν οι μπαταρίες έχουν αδειάσει. Ποτέ μην χρησιμοποιείτε μπαταρίες που έχουν σφύρει. Χρησιμοποιείτε μόνο μπαταρίες του συνιστώμενου τύπου ή κάποιαου αντιστοικού τύπου. Τοποθετήστε τις μπαταρίες με τους πόλους στη σωστή θέση. Οι επαναφορτιζόμενες μπαταρίες πρέπει να επαναφορτίζονται χρησιμοποιώντας το σωστό φορτιστή μπαταριών υπό την επίβλεψη ενήλικου. Δεν μπορείτε να επαναφορτίσετε τις μπαταρίες όταν αυτές βρίσκονται μέσα στο προϊόν και δεν πρέπει ποτέ να δοκιμάσετε κάτι τέτοιο. Μην επιχειρήσετε ποτέ να επαναφορτίσετε μη επαναφορτιζόμενες μπαταρίες. Ποτέ μην βραχυκυκλώνετε τη θήκη των μπαταριών.

JA

電池取扱いに関する重要事項

異なるタイプの電池や古い電池を混ぜて使用しないでください。商品を長時間使用しないときや電池が切れたときは、電池を必ず取り外してください。不具合のある電池は、絶対に使用しないでください。推奨されているタイプまたは対応しているタイプの電池を必ず使用してください。電極を確認して電池を正しい向きに入れてください。充電式電池は、保護者に見てもらった上で適切な充電器を使って充電してください。電池を商品の中に入れてそのまま充電することは絶対に避けてください。充電式ではない電池は絶対に充電しないでください。電池ホルダをショートさせないでください。

ZH

关于电池的重要信息

请勿同时使用不同类型的电池，或把新旧程度不同的电池混合使用。如果产品将有很长时间不会使用，或者电池已经没电，请注意取出电池。切勿使用已破损的电池。务必仅使用推荐类型或兼容类型的电池。装入电池时请注意正负极。如果使用充电电池，务必在成人监护下使用正确的电池充电器进行充电。电池仍在产品中时不可进行充电，请勿强行尝试充电。请勿尝试给非充电电池充电。切勿对电池仓进行短路连接。

KO

배터리 사용 시 주의사항

다른 종류의 배터리를 함께 사용하거나, 새 전지와 오래된 전지를 혼용하지 마세요. 배터리가 방전되었거나 장기간 제품을 작동하지 않을 때에는 반드시 배터리를 분리하세요. 파손된 배터리는 사용하지 마세요. 레고에서 권장하는 유형의 배터리를 사용하세요. 양극과 음극의 위치를 잘 맞춰서 넣으세요. 어른의 감독에 따라 지정된 충전기에 충전지를 충전해야 합니다. 충전지를 제품에 넣은 상태로 충전하면 안 됩니다. 일만 배터리는 충전해서 사용할 수 없습니다. 배터리 홀더의 접촉부에 배터리를 정확히 끼워서 사용하세요.

RU

Необходимая информация об элементах питания

Ни в коем случае не используйте одновременно элементы питания различных типов, а также элементы питания с разным сроком годности. В обязательном порядке внимайте элементы питания из терминалов в случае, если вы не пользуетесь прибором в течение долгого времени, либо в случае, если в элементах питания закончился заряд. Ни в коем случае не используйте поврежденные элементы питания. Используйте только рекомендуемые элементы питания либо элементы питания соответствующего типа. Установите элементы питания, соблюдая указанную полярность. Аккумуляторные элементы питания должны подзаряжаться в соответствующем зарядном устройстве под наблюдением взрослого. Ни в коем случае не пытайтесь подзаряжать элементы питания, находящиеся в приборе. Ни в коем случае не пытайтесь подзаряжать перезаряжаемые элементы питания. Ни в коем случае не пытайтесь замкнуть полюса в устройстве для элементов питания.

PL

Ważne informacje dotyczące baterii
Nigdy nie należy stosować razem różnych rodzajów baterii ani stosować równocześnie starych i nowych baterii. Jeżeli produkt nie jest używany przez dłuższy czas lub jeżeli baterie się wyczerpały, należy wyjąć baterie. Nigdy nie należy stosować uszkodzonych baterii. Należy stosować wyłącznie zalecany rodzaj baterii lub rodzaj mu odpowiadający. Przy wkładaniu baterii należy zwrócić uwagę na właściwe położenie biegunów. Baterie akumulatorowe należy ładować w odpowiedniej ładowarce pod nadzorem osoby dorosłej. Nie można naładować baterii bez wyjścia ich z produktu i nigdy nie należy tego próbować. Nigdy nie należy próbować ładowania baterii jednorazowych. Nigdy nie należy doprowadzać do zwarcia w gnieździe baterii.

CZ

Důležité informace o bateriích

Nikdy nepoužívejte najednou různé typy baterií nebo kombinaci starých a nových baterií. Nebude-li se výrobek delší dobu používat nebo jsou-li baterie vybité, vždy je vyjměte z výrobku. Nikdy nepoužívejte poškozené baterie. Používejte pouze doporučené nebo odpovídající typy baterií. Baterie instalujte se správnou orientací pólů. Nabíjitelné baterie musí být nabitý ve vhodné nabíječce pod dohledem dospělé osoby. Nabíjitelné baterie nelze nabíjet, jsou-li umístěny ve výrobku, a nesmíte se o to ani pokoušet. Nikdy se nesnažte nabíjet baterie, které nejsou nabíjitelné. Nikdy nezkratujte kontakty v prostoru pro baterie.

SK

Dôležitá informácia o batériách

Nikdy nepoužívajte naraz odlišné typy batérií ani nekombinujte staré batérie s novými. Batérie vždy vyberte, ak sa výrobok nebude dlhšie používať, ale ak sa batérie vybití. Nikdy nepoužívajte poškodené batérie. Používajte len odporúčané alebo zodpovedajúce typy batérií. Batérie vkladajte so správnou orientáciou pólou. Dobíjateľné batérie sa musia nabíjať vo vhodnom nabíjači pod dozorom dospelého osoby. Dobíjateľné batérie sa nesmú nabíjať, ak sú umiestnené vo výrobku, a nesmiete sa o to ani pokúšať. Nikdy sa nesnažte nabíjať batérie, ktoré nie sú dobíjateľné. Nikdy neskratujte kontakty v priestore pre batérie.

HU

Fontos tudnivalók az elemekről
Soha ne használjon különböző típusú elemeket, illetve ne használjon vegyesen új és használt elemeket. Mindig távolítsa el az elemeket, ha a készüléket előre láthatóan hosszabb ideig nem fogják használni, vagy ha az elemek lemerültek. Soha ne használjon megrongálódott akkumulátort. Csak az ajánlott típusú, vagy annak megfelelő elemet használjon. Az elemeket polaritás helyesen helyezze be. Az akkumulátorkat csak a megfelelő akkumulátortöltővel szabad feltölteni, egy felhőtt segítő felügyelete mellett. Az akkumulátorokat nem lehet feltölteni, ha azok a készülékben vannak. Ezt meg sem szabad próbálni. Soha ne próbálja meg feltölteni a nem tölthető elemeket. Soha ne hozzon létre rövidzárlatot az elemtartó kivezetésén.

UA

Необхідна інформація про батареї

Ніколи не використовуйте одночасно батареї різних типів або батареї з різним терміном придатності. Обов'язково вилучайте батареї з приладу, якщо довго не користуватись ним, або якщо в батареях вже скінчився заряд. Ніколи не використовуйте пошкоджені батареї. Використовуйте батареї лише рекомендованого або відповідного типу. Вставляйте батареї, враховуючи задану полярність. Акумуляторні батареї повинні заряджатись у відповідному зарядному приладі під наглядом дорослого. В будь-якому випадку не намагайтесь підзарядити батареї, що знаходяться в приладі. В будь-якому випадку не намагайтесь зробіти коротке замикання в приладі для батерей.

HR

Važne obavijesti o bateriji

Nikada nemoj koristiti različite vrste baterija zajedno, isto tako ni kombinaciju starih i novih baterija. Uvijek izvadite baterije ako dugo nećeš koristiti proizvod ili ako su one potrošene. Nikada nemoj koristiti oštećene baterije. Koristi samo preporučenu vrstu ili odgovarajuću vrstu baterija. Umetni baterije pažljivo da dobro okreneš polove. Akumulatorske se baterije moraju puniti uz pomoć propisanog punjača i uz nadzor odrasle osobe. Baterije se ne smiju puniti dok su još u proizvodu i to nikada nemoj pokušavati. Nikada ne pokušavaj puniti baterije koje nisu predviđene za punjenje. Nikada ne izazivaj kratki spoj u držaču baterija.

SR

Важне информације о батеријама
Никада не користите различите типове батерија заједно нити комбинацију старих и нових батерија. Увек извадите батерије уколико производ нећете дуже време користити или уколико су батерије празне. Никада не користите оштећене батерије. Употребљавајте само препоручени тип батерија или одговарајућу замену. Ставите батерије тако да су полови правилно позиционисани. Батерије на пуњење се морају пунити одговарајућим пуњачем под надзором одраслог лица. Батерије не смете да пуните нити да покушате пунити док су у производу. Никада не покушавајте да пуните батерије које не могу да се пуне. Никада не преспајајте половине кућишта за батерије.

SL

Pomembne informacije o baterijah

Nikoli ne uporabljajte skupaj različnih baterij ali kombinacije starih in novih baterij. Vedno odstranite baterije, če izdelka dlje časa ne boste uporabljali ali če so iztrošene. Nikoli ne uporabljajte poškodovanih baterij. Uporabljajte le baterije priporočene ali ustreznega tipa. Baterije vstavite tako, da so njihovi polji pravilno obrnjeni. Akumulatorske baterije je treba polniti s pravim polnilnikom pod nadzorom odrasle osebe. Akumulatorskih baterij ni mogoče polniti, dokler so še v izdelku. Tega tudi ne smete poskušati. Nikoli ne poskušajte polniti baterij, ki niso akumulatorske. Pazite, da ležišča za baterije ne boste spravili v kratek stik.

RO

Informații importante despre baterii

Nu folosiți niciodată împreună tipuri diferite de baterii, sau o combinație de baterii vechi și noi. Îndepărtați întotdeauna bateriile dacă produsul nu este folosit timp îndelungat sau dacă bateriile s-au epuizat. Nu folosiți niciodată baterii deteriorate. Folosiți numai baterii de tipul recomandat, sau un tip corespunzător. Introduceți bateriile astfel ca polișii să fie poziționați corect. Bateriile reincărcabile trebuie reincărcate utilizând încărcătorul corect sub supravegherea unui adult. Nu puteți reincărca bateriile în timp ce acestea sunt încă în produs, și niciodată nu trebuie să încercați să faceți acest lucru. Nu încercați niciodată să reincărcati baterii nereincărcabile. Nu scurtcircuitați niciodată suportul bateriei.

BG

Важна информация за батериите
Не използвайте различни типове батериите едновременно или комбинация от стари и нови батериите. Винаги изваждайте батериите, ако изделите време да се използва продължително време или ако батериите са се изтозили. Не използвайте повредени батериите. Използвайте само батериите от препоръчвания тип или съответстващ на него тип. Поставете батериите така, че полюсите да са разположени правилно. Аккумуляторните батериите трябва да се зареждат с подходящо зареждащо устройство под надзора на възрастни. Батериите не могат да се зареждат, докато са поставени в изделието, така че не трябва да се опитвате да правите това. Не се опитвайте да зареждате батериите, които не са акумулаторни. Не свързвайте в късо съединение контактите на отделението за батериите.

LV

Svarīga informācija par baterijām

Nekad vienlaikus nelietojiet dažādu tipu, kā arī vecas un jaunas baterijas. Vienmēr izņemiet baterijas, ja tās ir izlādējušas vai ja produktus ilgāku laiku netiek lietots. Nekad nelietojiet bojātas baterijas. Lietojiet tikai ieteicamā tipa vai atbilstoša tipa baterijas, ievietojot baterijas, ievērojiet pareizo polaritāti. Uzlādējamu bateriju lādēšanai izmantojiet atbilstošu bateriju lādētāju; uzlāde jāveic piesaūģušo uzraudzībā. Baterijas nevar uzlādēt un nekad nedrīkst mēģināt uzlādēt, kamēr tās ievietotas produktā. Nemēģiniet uzlādēt baterijas, kas nav uzlādējamas. Nepieļaujiet īssavienojumu bateriju nodalījumā.

ET

Oluline teave patareide kohta

Ära kunagi kasuta koos erinevat tüüpi patareisid, samuti vanu ja uusi patareisid. Kui märguasja ei kasutata pika aja jooksul, võta patarei sellest välja. Ära kunagi kasuta kahjustatud patareisid. Kasuta ainult ettenähtud tüüpi või neile samaväärseid patareisid. Pane patareid märguasja sisse nii, et pluss- ja miinuslemmi asend oleks õige. Akusid tuleb laadida ainult neile ettenähtud akulaadija abil täiskasvanu järelevalve all. Akusid ei saa laadida sel ajal, kui need on märguasja sees. Ära kunagi püüa nii teha. Ära kunagi proovi akulaadijaga laadida tavalisi patareisid. Patareipesa klemmide vahel ei tohi tekkida lühisid.

LT

SVarbi informacija apie elementus
Vieną metu nenaudokite skirtingų elementų, taip pat su naujais elementais nenaudokite senų. Jei nenaudosite gaminio ilgesnį laiką arba jei elementai išseko, visumet išimkite juos iš gaminio. Niekada nenaudokite pažeistų elementų. Naudokite tik rekomenduojamus arba atitinkamo tipo elementus. Elementus dėkite atsižvelgdami į jų poliškumą. Elementus galima įkrauti tik tinkamu krovikliu ir prižiūrint suaugusiems. Jokių būdu negalima, ir niekuomet nebandykite, įkrauti elementų neišėmus ju iš gaminio. Niekada nebandykite įkrauti vienkartinių elementų. Saugokitės, kad elementų dėklė nesukeltumėte trumpojo jungimo.

TR

Piller hakkında önemli bilgiler

Hiçbir zaman değişik tipte pilleri ya da eski pillerle yeni pilleri bir arada kullanmayın. Urün uzun süre pilli kullanılmayacaksa ya da piller bitmişse, pilleri çıkarın. Hiçbir zaman zedelemmiş pilleri kullanmayın. Sadece önerilen tipte piller ya da bunların dengi olan piller kullanın. Pilleri kutupları doğru konumda olacak şekilde yerleştirin. Bitince sarılı pilleri doğru pil sarı aletini kullanarak, bir yetkisinin denetiminde sarı edin. Sarılı pilleri, ürünü içindeyken sarı edemezsiniz ve hiçbir zaman bunu yapmaya çalışmayın. Hiçbir zaman, sarılı olmayan pilleri sarı etmeye çalışmayın. Hiçbir zaman pil kutusunda kısa devre yaptırmayın.

ID

Informasi penting tentang baterai

Jangan gunakan baterai yang jenisnya berlainan, atau mencampur baterai lama dan baterai baru. Lepas baterai jika produk tidak akan digunakan untuk waktu lama atau jika baterai sudah lemah. Jangan gunakan baterai yang rusak. Gunakan jenis baterai yang dianjurkan atau yang sejenis. Masukkan baterai dengan posisi kutub yang tepat. Baterai isi ulang harus diisi ulang dengan charger baterai yang sesuai dan di bawah pengawasan orang dewasa. Anda tidak dapat mengisi ulang baterai saat masih terpasang di dalam produk, dan jangan pernah coba melakukannya. Jangan pernah coba mengisi ulang baterai biasa. Jangan pernah membuat arus pendek pada dudukan baterai.



EN	Protect the environment by not disposing of this product with your household waste (2002/96/EC). Check with your local authority for recycling advice and facilities.	EL	Προστατέψτε το περιβάλλον. Μην πετάτε αυτό το προϊόν μαζί με τα συνηθισμένα οικιακά απορρίμματα (2002/96/EC). Επικοινωνήστε με τις τοπικές αρχές σχετικά με συμβουλές και εγκαταστάσεις ανακύκλωσης.	HR	Zaštitite okoliš tako da ovaj proizvod ne odložite u otpad zajedno s kućanskim otpadom (2002/96/EZ). Od lokalnih vlasti zatražite savjet ili informacije o pogonima za recikliranje.
DE	Schützen Sie die Umwelt und entsorgen Sie dieses Produkt nicht mit Ihrem Hausmüll (2002/96/EC). Informationen zu Recycling-Möglichkeiten erhalten Sie bei den örtlichen Behörden.	JA	環境保護のため、本製品は家庭ごみとは別に処分してください(2002/96/EC)。リサイクルに関する指示や施設については、お住まいの地方自治体にお問い合わせください。	SR	Zaštitite životnu sredinu tako što nećete odlagati ovaj proizvod sa kućnim otpadom (2002/96/EC). Obratite se lokalnoj ovlašćenoj službi da biste dobili savete o recikliranju i saznali o objektima za reciklažu.
FR	Protégez l'environnement : ne jetez pas ce produit avec vos autres déchets ménagers (Directive européenne 2002/96/EC). Contactez les autorités locales pour obtenir des informations sur le recyclage et connaître les points de collecte.	ZH	注意保护环境，请勿将本产品与家庭垃圾一起丢弃处理(2002/96/EC)。请咨询您当地相关部门，了解回收设施与回收建议。	SL	Zaščitite okolje! Okolje varujte tako, da tega izdelka ne zavržete skupaj z gospodinjiskimi odpadki (v skladu z direktivo 2002/96/ES). Pri krajevni upravi preverite, kakšne možnosti in kateri obrati za recikliranje obstajajo v vaši okolici.
IT	Proteggi l'ambiente! Non smaltire questo prodotto con i rifiuti domestici (2002/96/EC). Per consulenza sul riciclaggio dei rifiuti e le strutture di riciclaggio, rivolgersi alle proprie autorità locali.	KO	환경 보호를 위해 이 제품을 생활폐기물과 함께 버리지 마십시오(2002/96/EC). 재활용 방법 및 시설에 관한 사항은 현지 관계 당국에 문의하십시오.	RO	Protejați mediul înconjurător și nu vă debarașați de acest produs împreună cu deșeurile menajere (2002/96/CE). Consultați autoritățile locale pentru îndrumări și facilități de reciclare.
NL	Bescherm het milieu: gooi dit product niet samen met het andere huisvuil weg (2002/96/EC). Raadpleeg de plaatselijke instanties voor locaties van milieustations en advies over hergebruik.	PL	Aby chronić środowisko naturalne, nie należy wyrzucać tego produktu wraz z odpadkami z gospodarstwa domowego (2002/96/WE). W celu uzyskania wskazówek dotyczących recyklingu oraz adresów zakładów należy skontaktować się z lokalnym urzędem.	BG	Защитете околната среда и не изхвърляйте този продукт заедно с битовите си отпадъци (2002/96/EO). Свържете се с местните власти относно съвети и съоръжения за рециклиране.
ES	Proteja el medio ambiente no deshaciéndose de este producto junto con sus residuos domésticos (2002/96/EC). Solicite a su autoridad local consejos e información sobre instalaciones de reciclado.	CZ	Nevyhazujte tento produkt do domácího odpadu, chraňte životní prostředí (2002/96/EC). Zjistěte si prosím u místních úřadů možnosti recyklace a dostupná zařízení.	LV	Lai saudzētu vidi, neizmetiet šo izstrādājumu kopā ar sadzīves atkritumiem (2002/96/EC). Vērsieties vietējās varas iestādēs, lai noskaidrotu, kur un kā tas nododams pārstrādei.
DA	Beskyt miljøet! Smid ikke dette produkt ud sammen med husholdningsaffaldet (2002/96/EF). Få vejledning om genbrug og genbrugsstationer hos din kommune.	SK	Nevyhádzajte tento produkt do domáceho odpadu, chráňte životné prostredie (2002/96/EC). Zistite si prosím na miestnych úradoch možnosti recyklácie a dostupné zariadenia.	ET	Keskkonda saate kaitsa nii, et ei kõrvalda seda toodet koos olmejäätmetega (2002/96/EÜ). Nõuandeid toote taaskasutusse võtmise ja ümbertöötlemispunktide kohta saate asjaomaselt kohalikult asutuselt.
FI	Tämä tuote on hävitettävä ympäristönsuojelun vuoksi asianmukaisesti talousjätteistä erillään (2002/96/EC). Tietoja kierrätyspisteiden sijainnista saa kunnan tai kaupungin teknisestä virastosta.	HU	Környezetét óvja, ha ettől a terméktől nem a háztartási hulladékkal együtt válik meg (2002/96/EC). Érdeklődjék a lakóhelyéhez közel eső hatóságnál az újrahasznosítás módjáról és lehetőségeiről.	LT	Saugokite aplinką – nemeskite šio produkto kartu su buitinėmis atliekomis (2002/96/EB). Atsižvelkite į savo vietos valdžios rekomendacijas dėl pakartotinio panaudojimo ir sąlygas.
SV	Skydda miljön genom att inte kasta denna produkt bland ditt hushållsavfall (2002/96/EC). Kontakta din kommun för frågor om återvinning och miljöstationer.	UA	Допоможіть захистити довкілля: не утилізуйте цей виріб разом із побутовим сміттям (2002/96/EC). Вказівки з утилізації та відомості про пункти прийому з'ясуєте в місцевих компетентних органах.	TR	Bu ürünü, evsel atıklarla birlikte atmayarak çevreyi koruyun (2002/96/EC). Geri dönüşüm tavsiyeleri ve tesisler hakkında bilgi için yerel yönetimle iletişimi kurun.
PT	Proteja o ambiente não eliminando este produto com o seu lixo doméstico (2002/96/CE). Consulte as autoridades locais para informação sobre reciclagem e sistemas de recolha.			ID	Jagalah lingkungan dengan tidak membuang produk ini bersama sampah rumah tangga Anda (2002/96/EC). Periksa peraturan pemerintah setempat tentang saran dan fasilitas daur ulang.



Remote Control

Fernbedienung
Télécommande
Control remoto
Comando à distância
Távírányító
远程控制
Remote control



ON/OFF
An/Aus
Marche/arrêt

Encendido/apagado
Ligado/Desligado
Be/ki

开/关
Hidup/mati

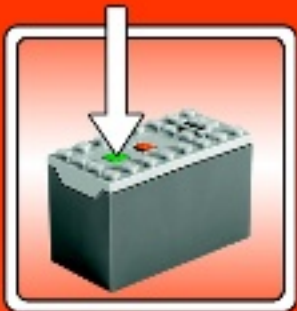

Battery Box

Batteriebox
Boîtier à piles
Batería
Bateria
Elemtartó doboz
电池盒
Kotak baterai





7 speeds • 7 Geschwindigkeiten • 7 vitesses
7 velocidades • 7 velocidades • 7 sebességfokozat • 7 速 • 7 kecepatan



7 speeds • 7 Geschwindigkeiten • 7 vitesses
7 velocidades • 7 velocidades • 7 sebességfokozat • 7 速 • 7 kecepatan

Change direction of train
Änderung der Fahrtrichtung
Change le sens de la marche du train
Cambia la direzione del treno
Verander de rijrichting van de trein
Cambia la dirección del tren
Skift togets retning
Junan kulkusuunnan vaihtaminen
Ändra tågets riktning
Mudar a direcção do comboio
Αλλάξε την κατεύθυνση του τρένου
トレインの進行方向を変える
改变列车方向
회전 방향 바꾸기
Изменение направления движения поезда
Zmień kierunek jazdy pociągu
Změna směru vlaku
Zmena smeru vlaku
A menetirány átváltása
Переключатель направления движения поезда
Promjena smjera vlaka
Промени смер воза
Spremeni smer voznje vlaka
Schimba direcția trenului
Променете посоката на движение на влака
Maini vilciēna kustības virzienu
Rongji soidusuuna muuttmine
Pakeisk traukinio krypti
Tren yönünü deęiřtirin
Ubah arah kereta

Turn wheel and change speed
Einstellung der Fahrtgeschwindigkeit
Tourne le volant et change de vitesse
Gira la rotellina e cambia velocit a
Draai het wiel voor meer of minder snelheid
Gira la rueda para cambiar la velocidad del tren
Drej hjulet, og skift hastighed
Nopeuden s a t o k aant opyr all a
Vrid p  ratten och  ndra hastighet
Rodar o bot o para alterar a velocidade
Γυρίσε τον τροχό και  λλαξε ταχύτητα
車輪を回転させる / スピードを変える
转向与改变速度
바퀴를 돌려 속도 바꾸기
Поверните колесико, чтобы изменить скорость
Obr c ko o, by zmieni c predkosc
Oto  kole ekem a zme n rychlost
Oto  kolieskom a zme n rychlost
A ker k elforgatas val a sebesség v ltozik
Обертанням колеса змiнюється швидкiсть
Brzina se podeřava okretanjem kota ca
Okreni to kkih da promeniř brzinu
Zavrti koleřek in spremeni hitrost
Roteste roata ři schimb  viteza
Zavъртете колелото, за да промените скоростта
Pagriez ripu un maini  trumu
Keera rooli ja muuda kiirust
Pasuk ratuka ir pakeisk greitį
Tekeri  eviriip hizi deęiřtirin
Putar tombol untuk mengubah kecepatan



Train trouble-shooting guide
Anleitung zur Fehlerbehebung bei Z gen
Guide de d pannage du train
Guia de solu  o de problemas ferroviarios
Vas ti javit si  tmutat o
列车故障指南

LEGO.com/city





Remote Control

Fernbedienung
Télécommande
Control remoto
Comando à distância
Távirányító
远程控制
Remote control



Receiver

Empfänger
Récepteur
Receptor
Receptor
Vevő
接收器
Receiver

8 Channels Frequenzen canaux
canales canals csatorna 频道 Kanal





2

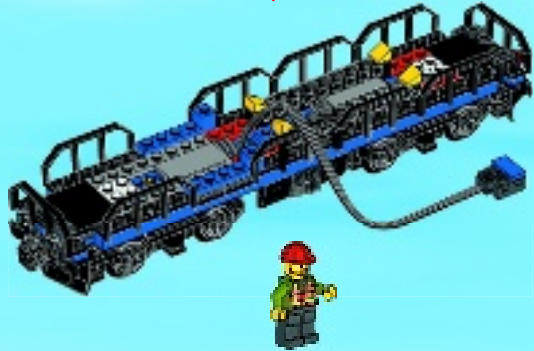

3

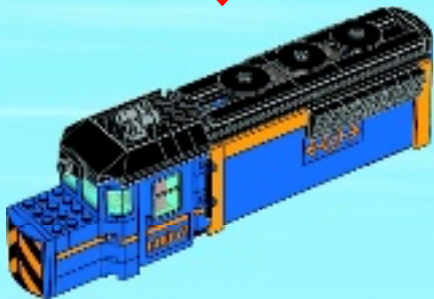

8x

1x

1x

2x

+



2

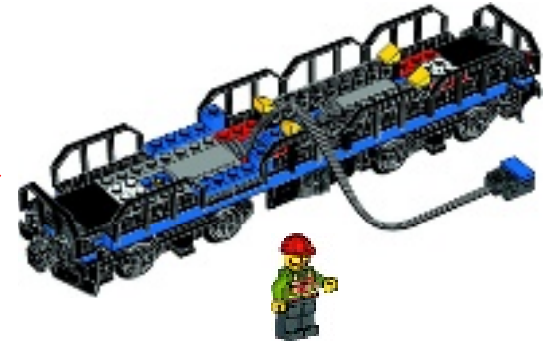

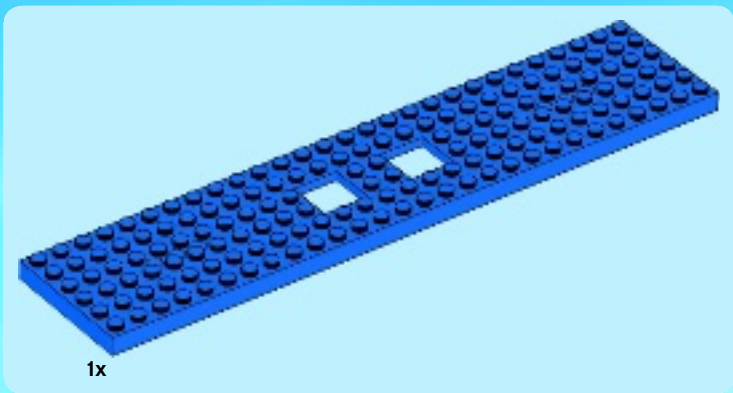

1

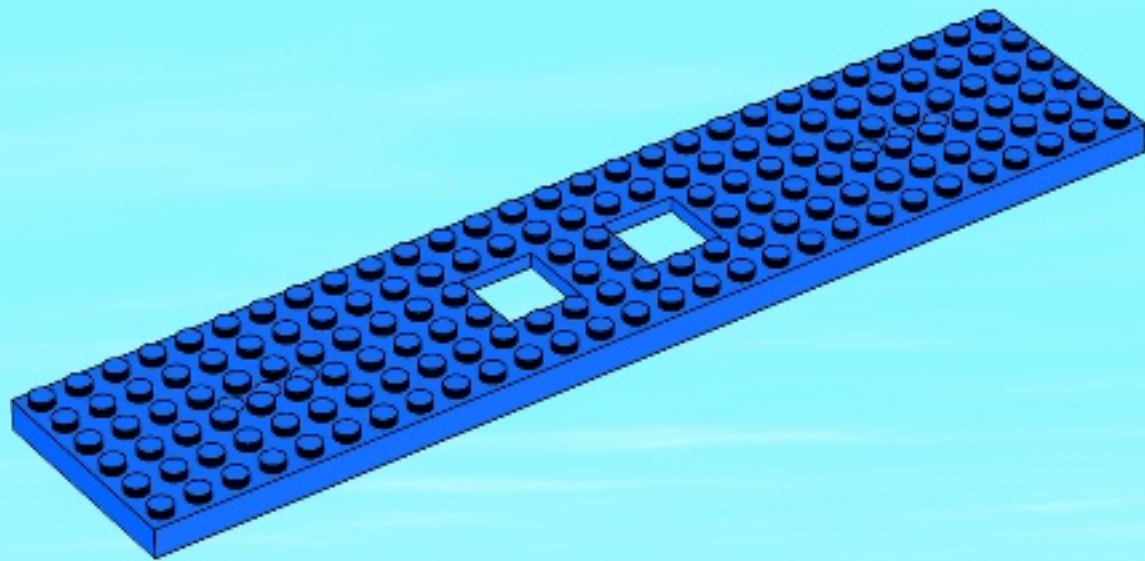



2x



2x

2

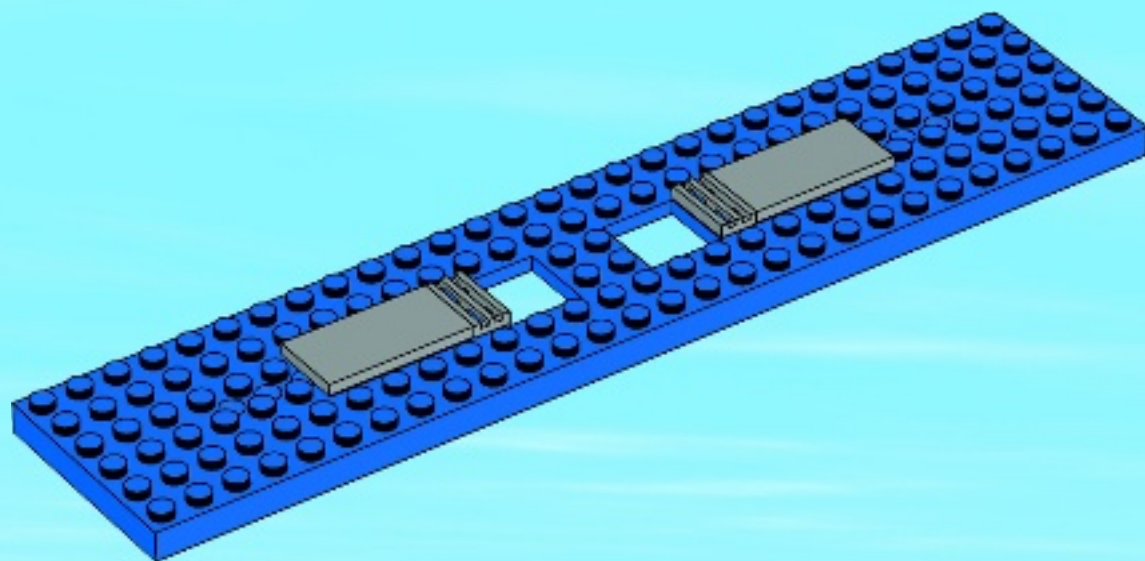



1x



1x



2x



1x



1x



2x



2x

3

1

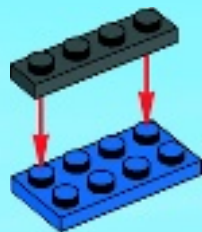

2



3

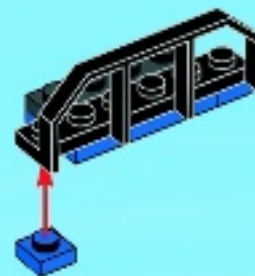

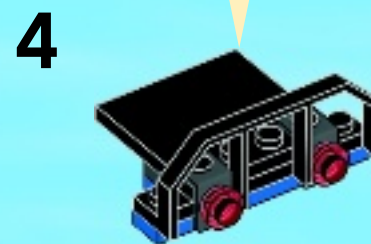

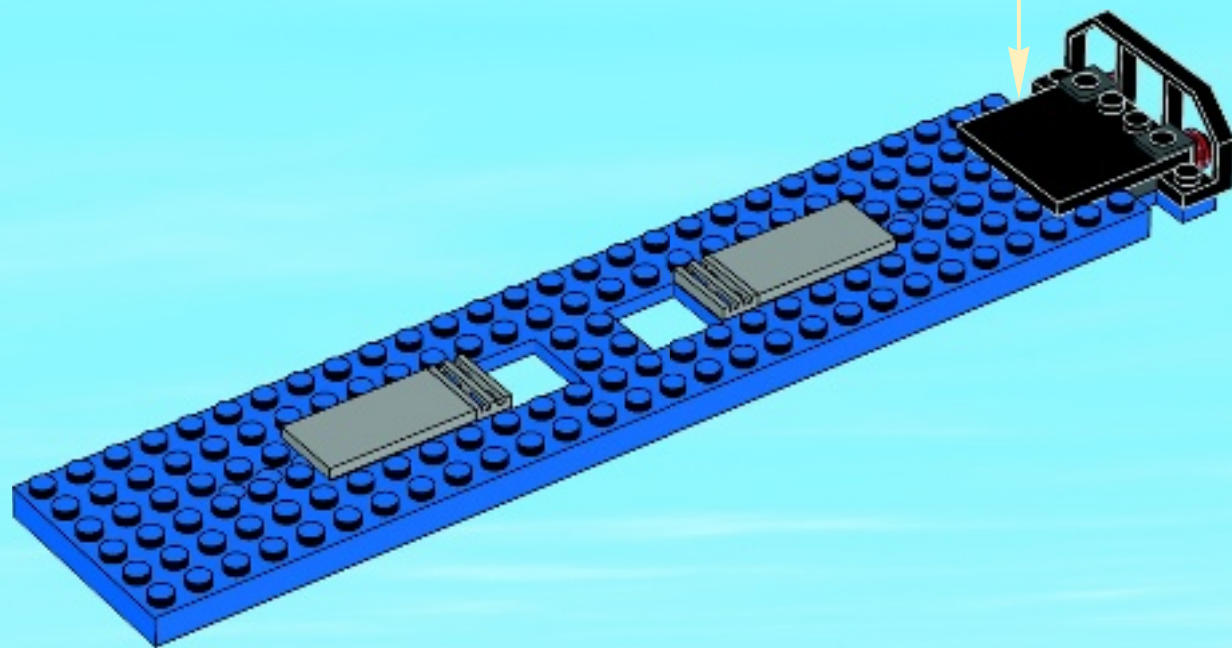



1x



2x

4

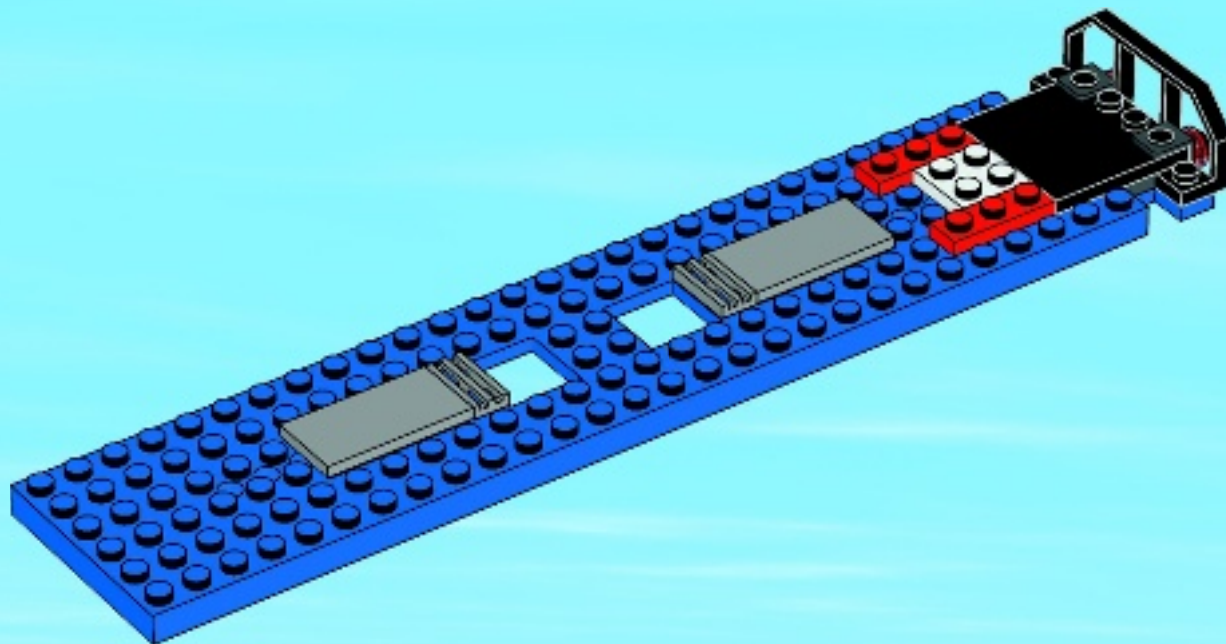



5

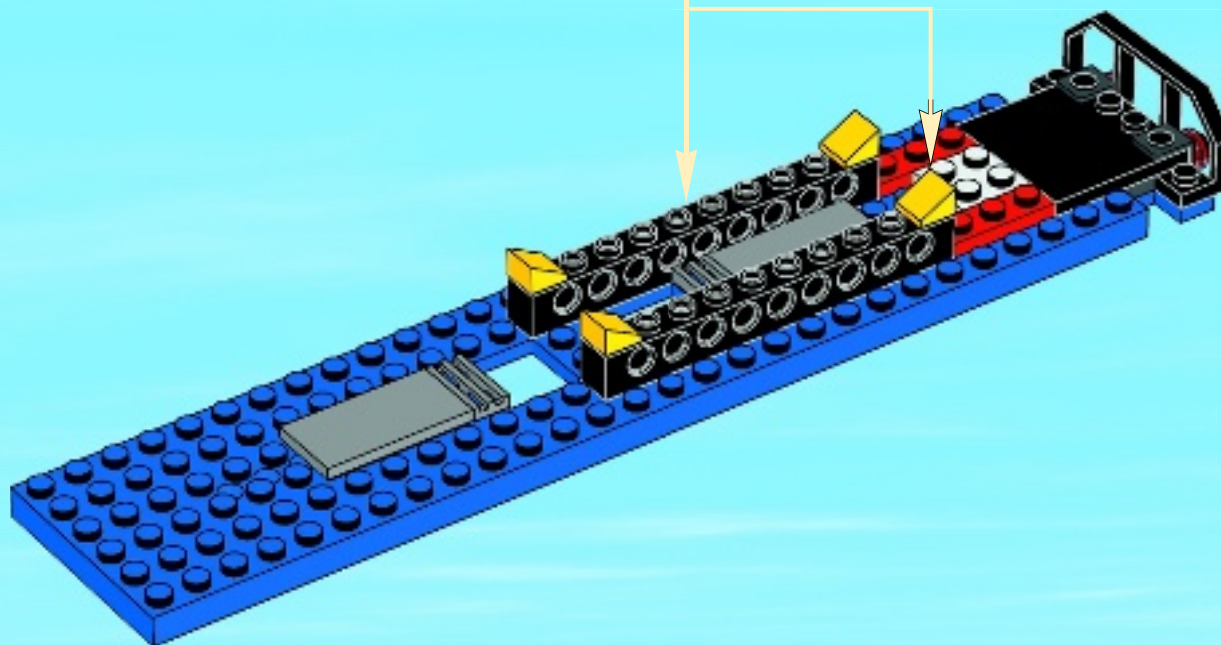
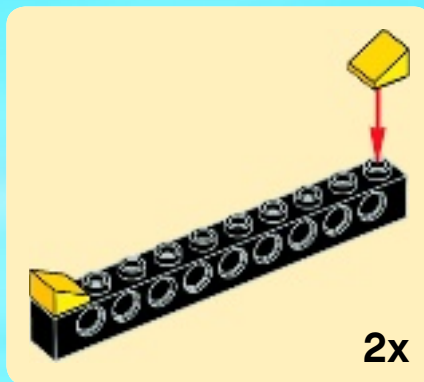



2x

6

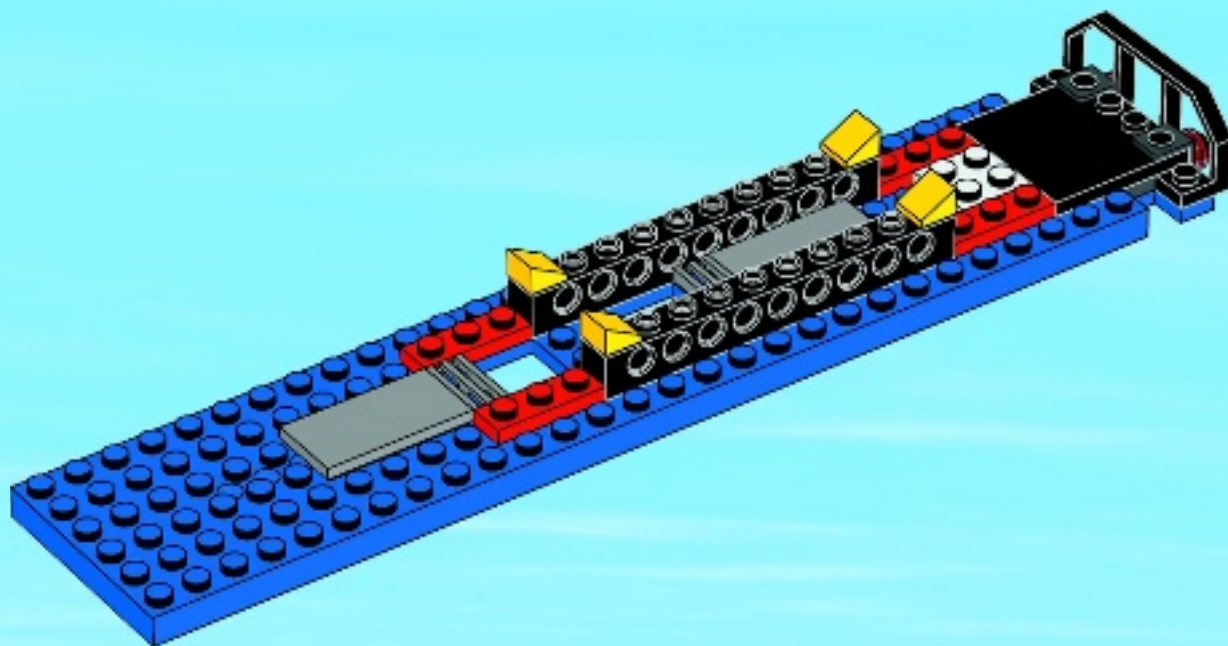

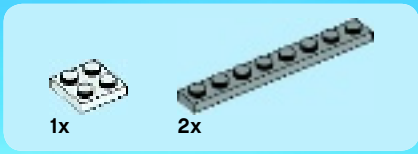

7

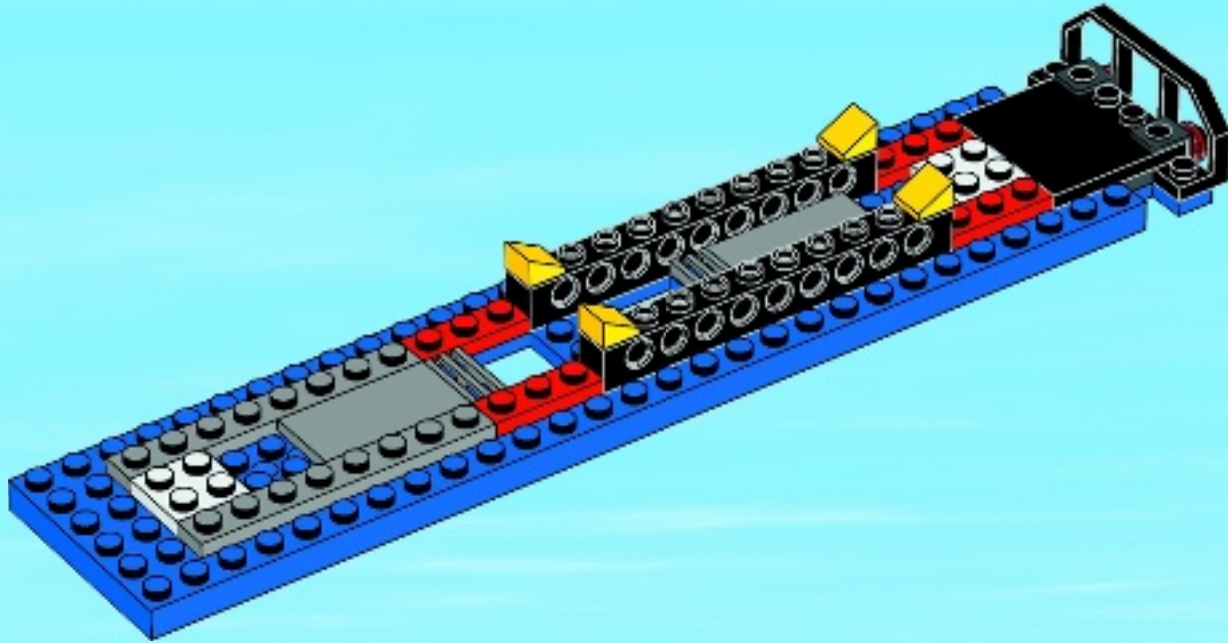

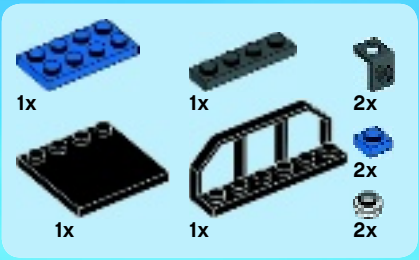

8

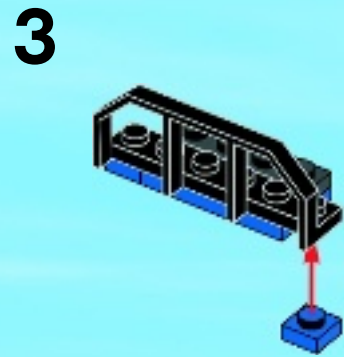
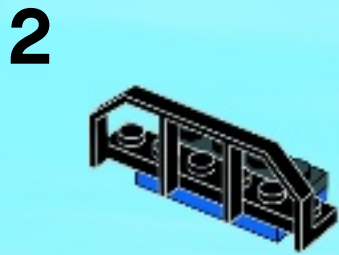
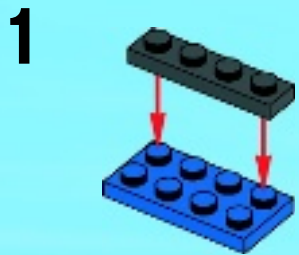

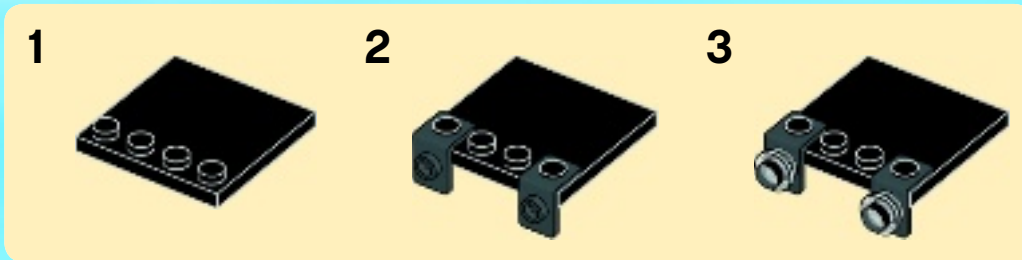

4

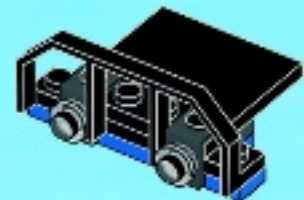

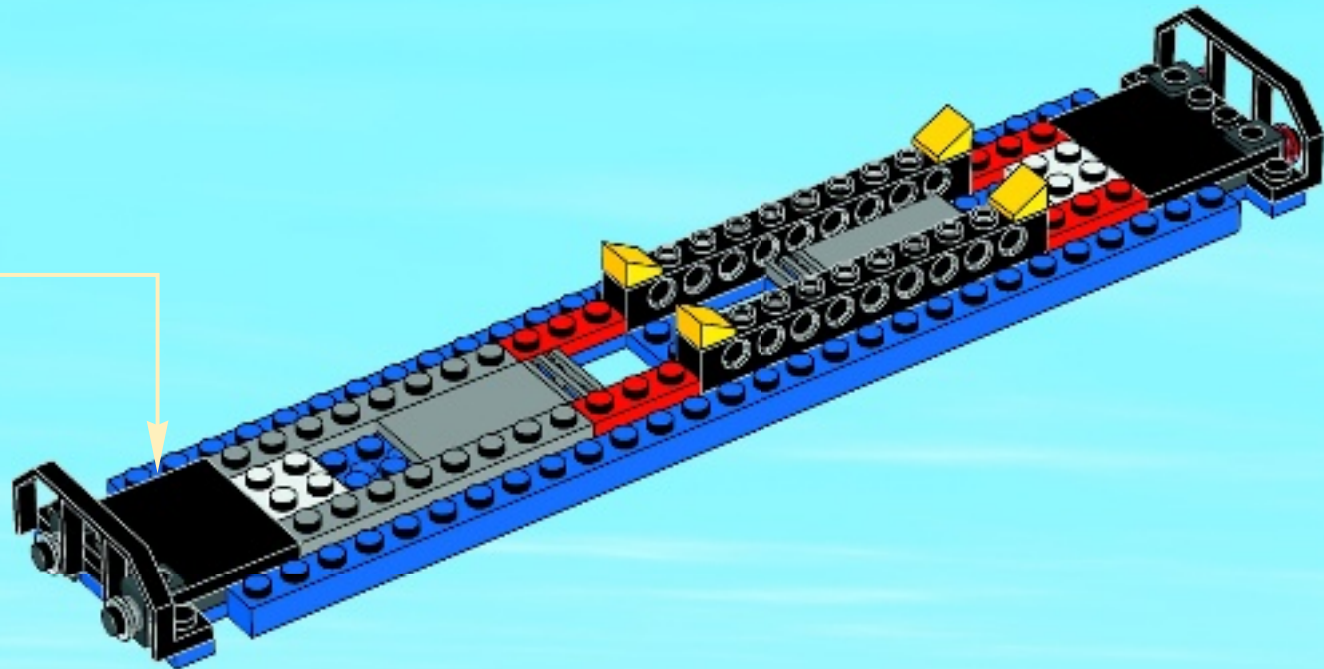



6x

9

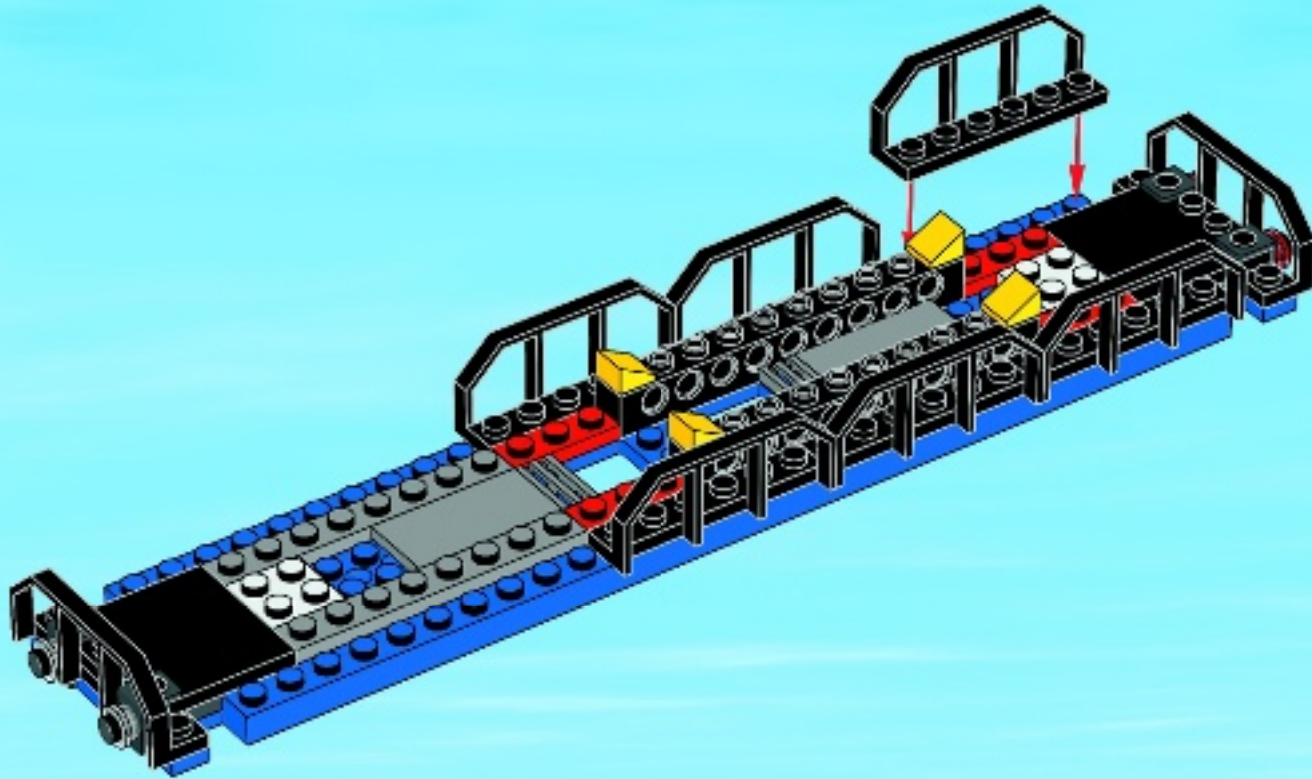



2x

10

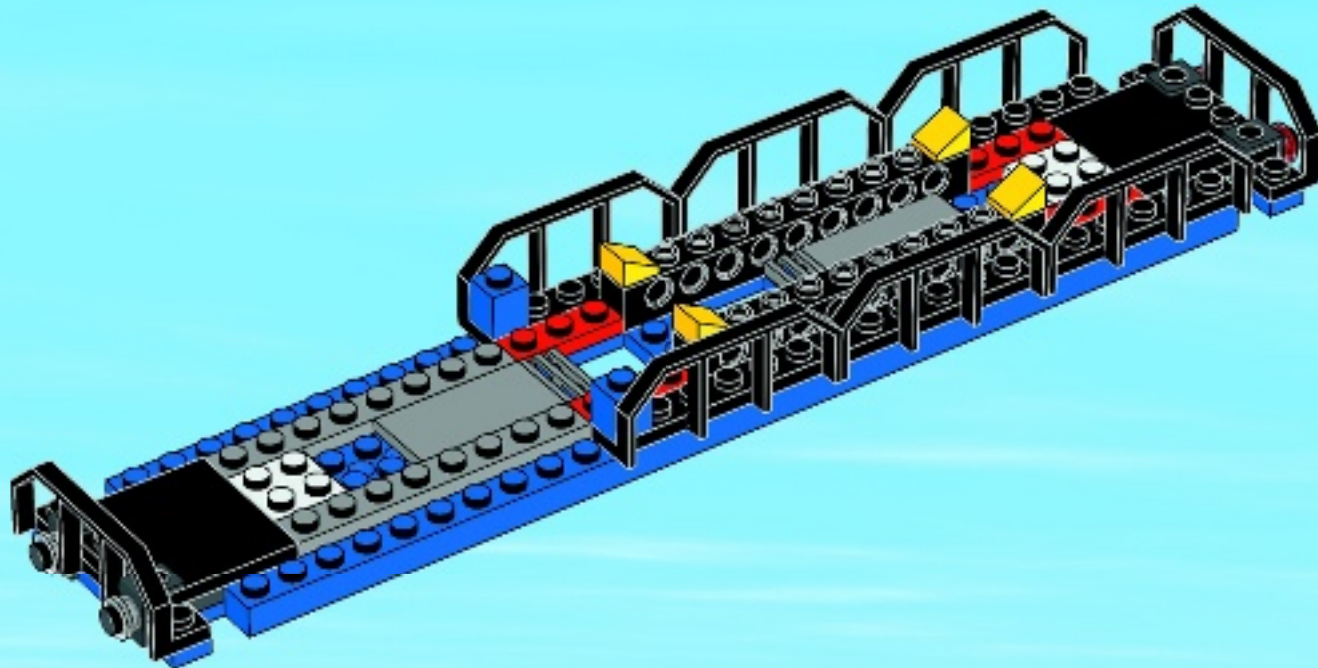



2x



4x

11

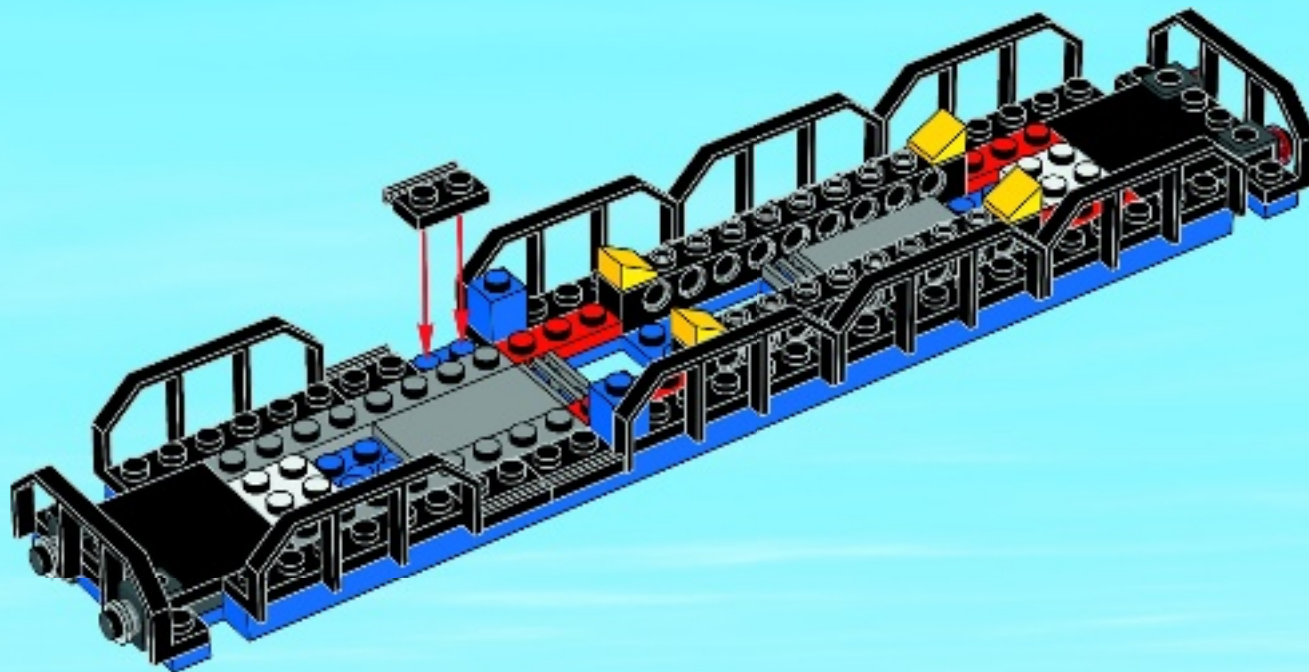



2x

12

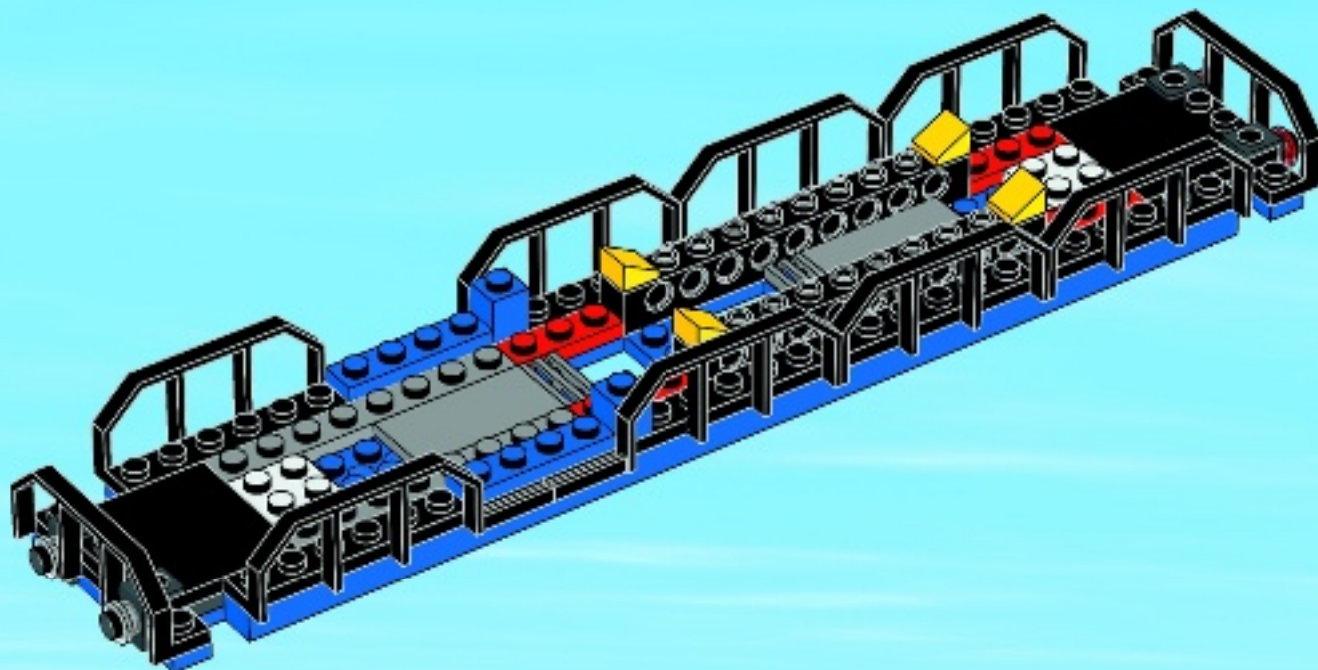



1

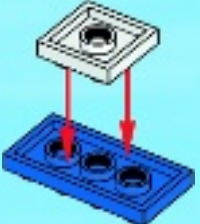

2

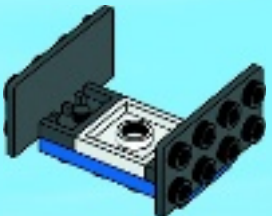

3

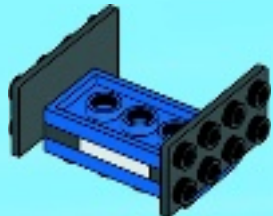



4

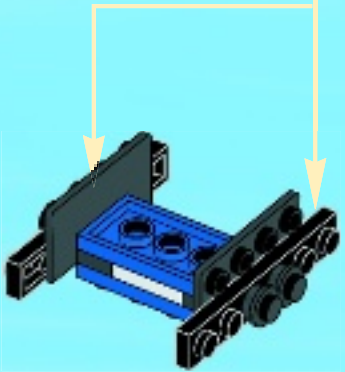
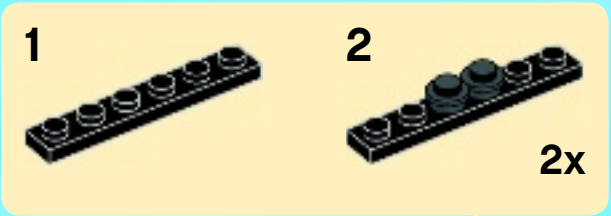

5

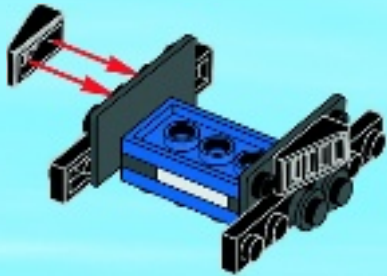



2x

6

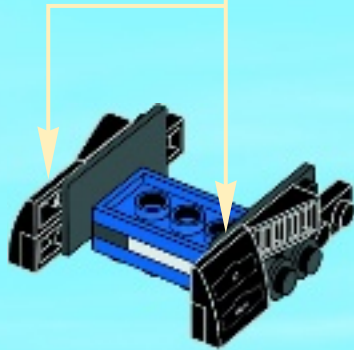
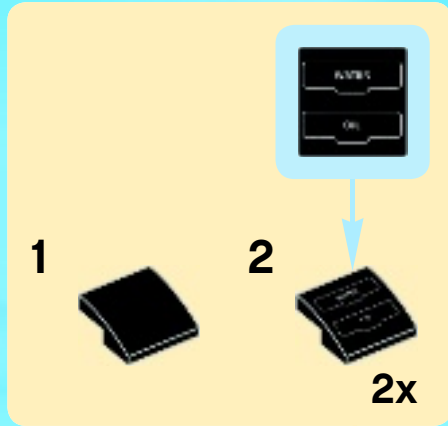

2x

7

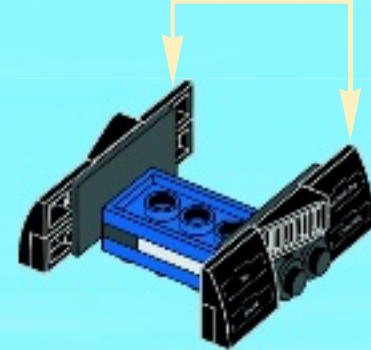
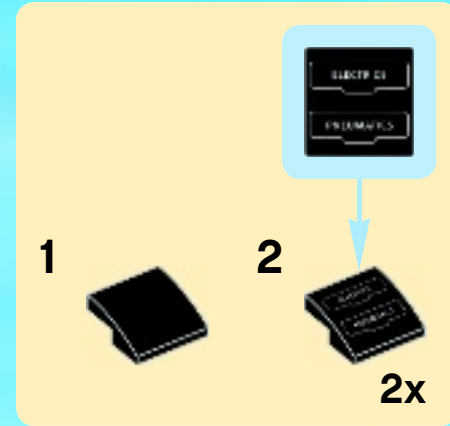

13

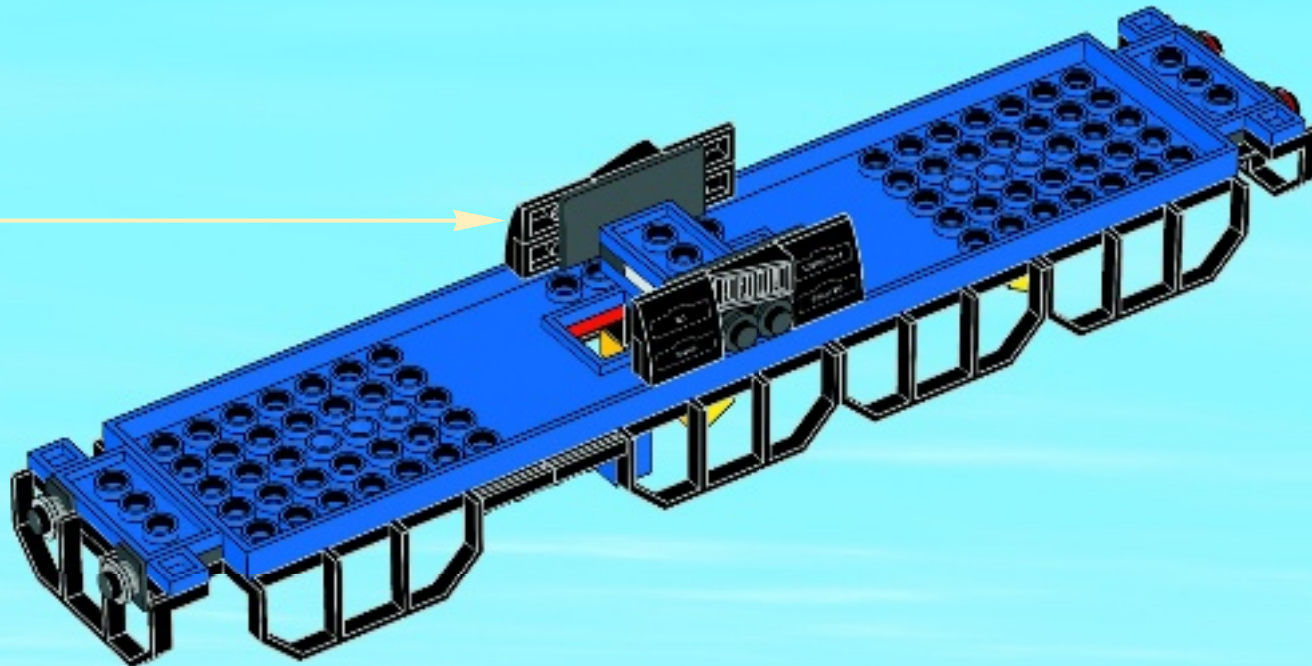

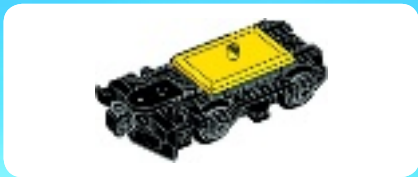

1



2

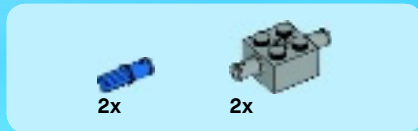

3

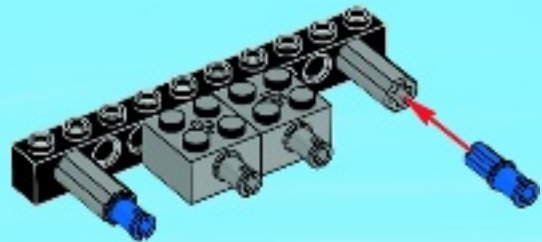



4

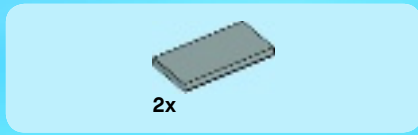

5

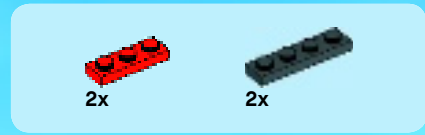
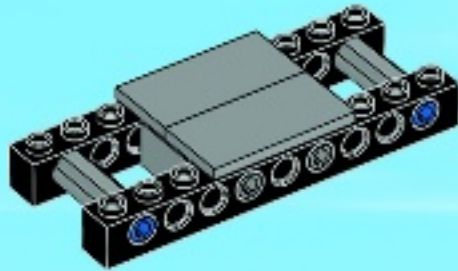

6

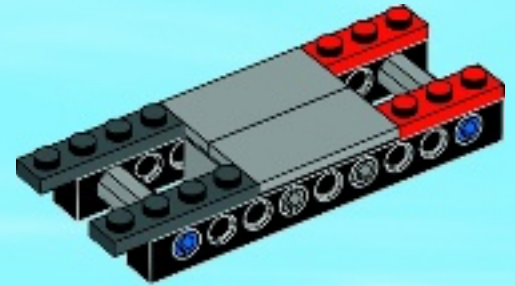



7



8

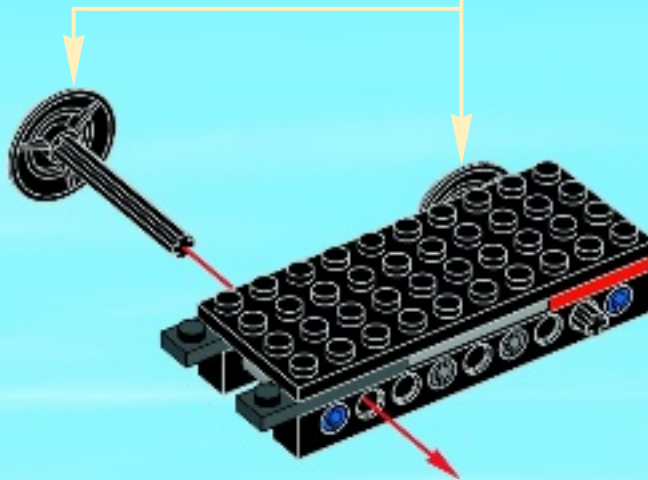
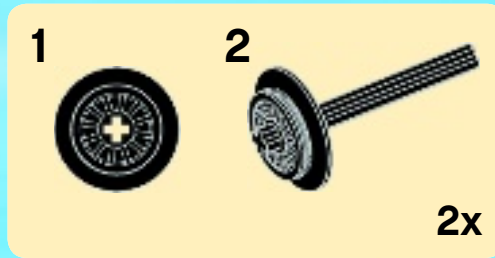

9





10



11



12

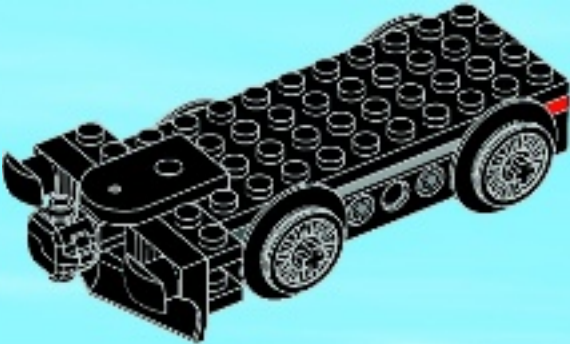

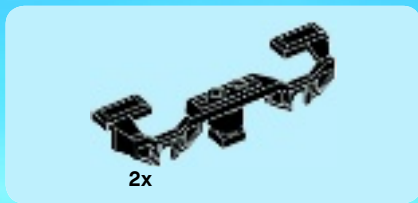

13

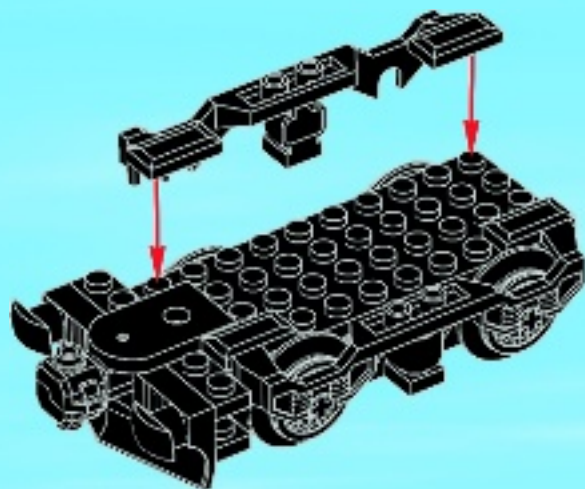

14

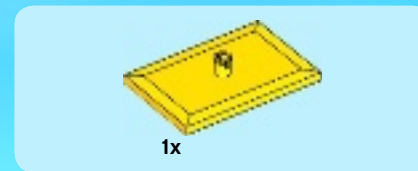
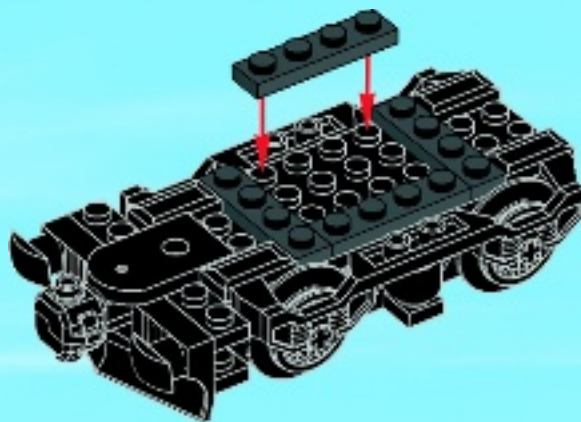

15

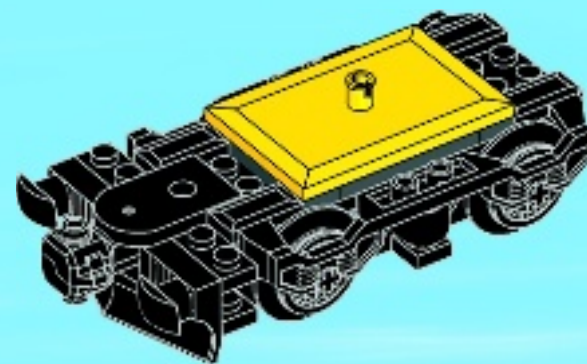

14

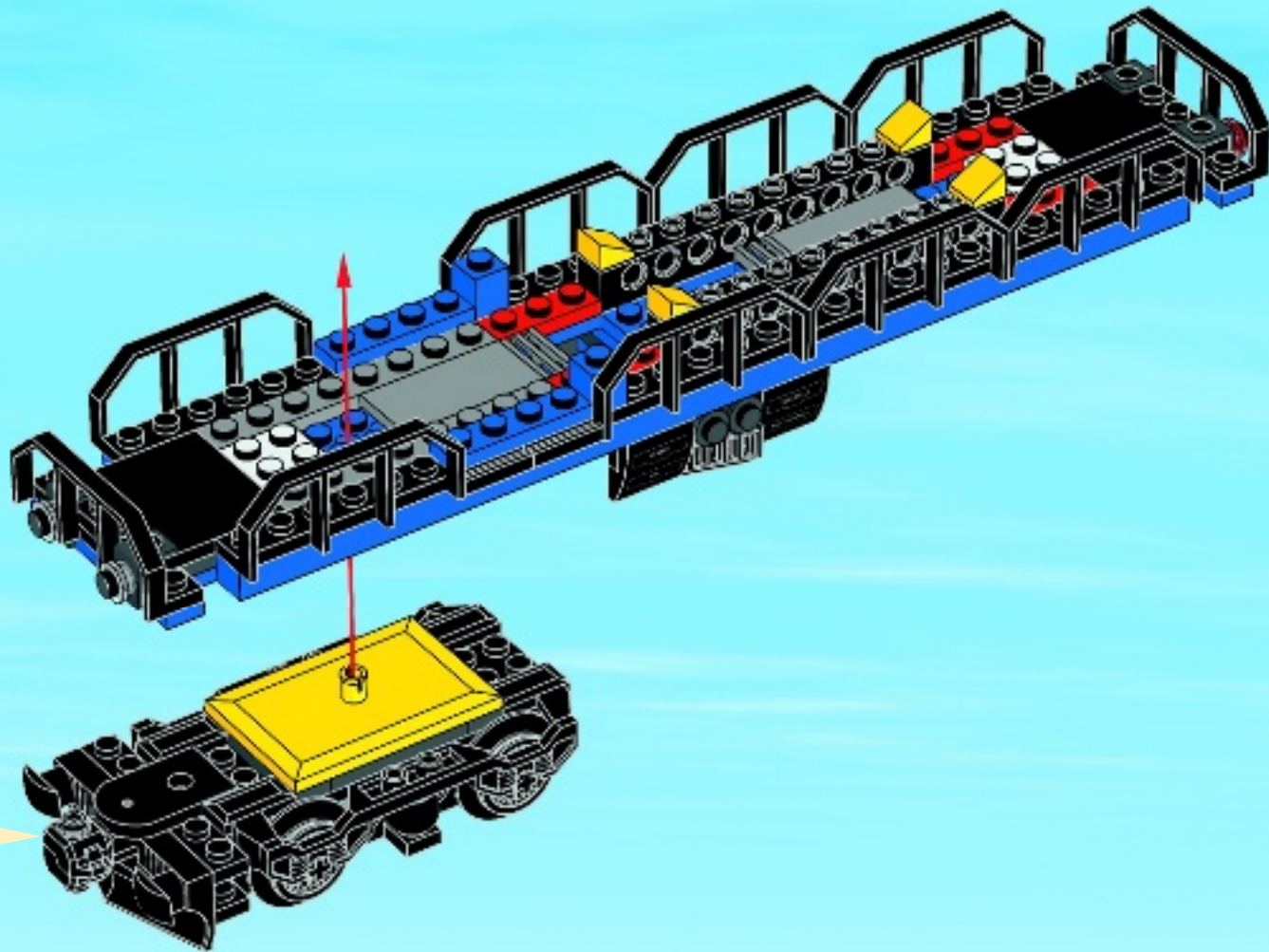

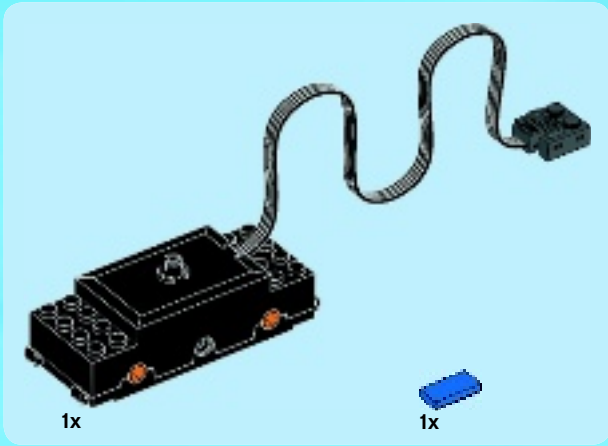
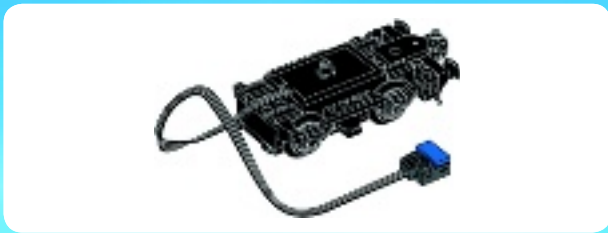

1

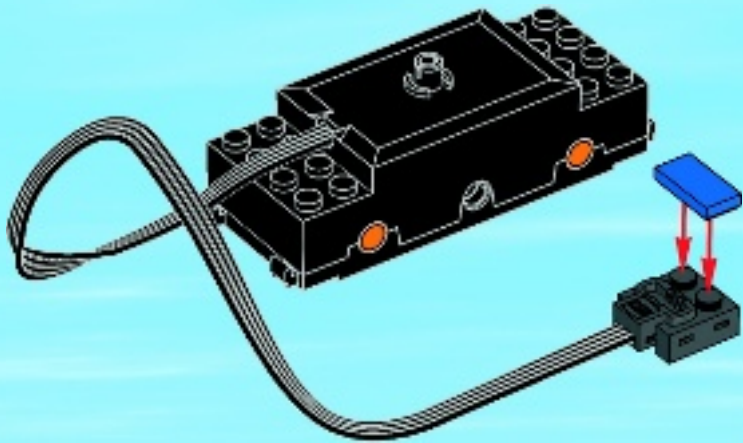

2

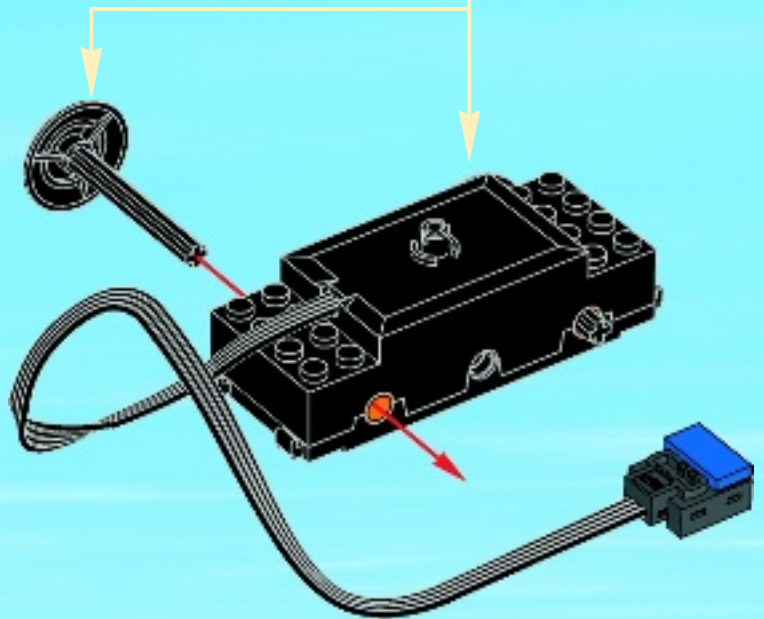
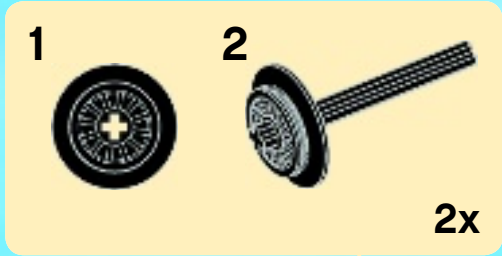



2x

3

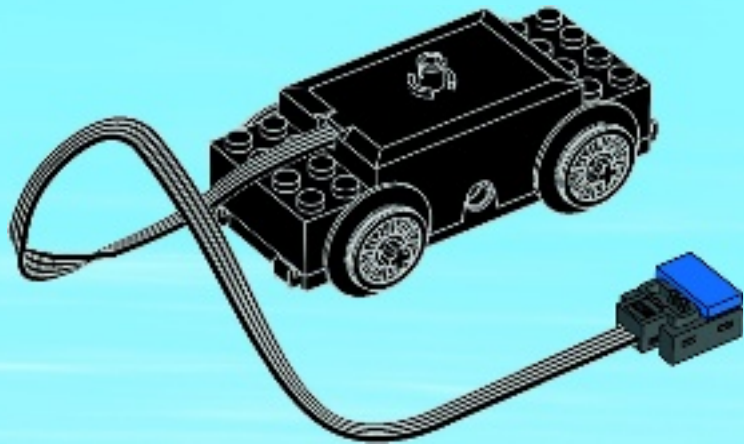

2x



2x

4

1



2

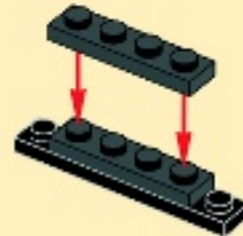

3

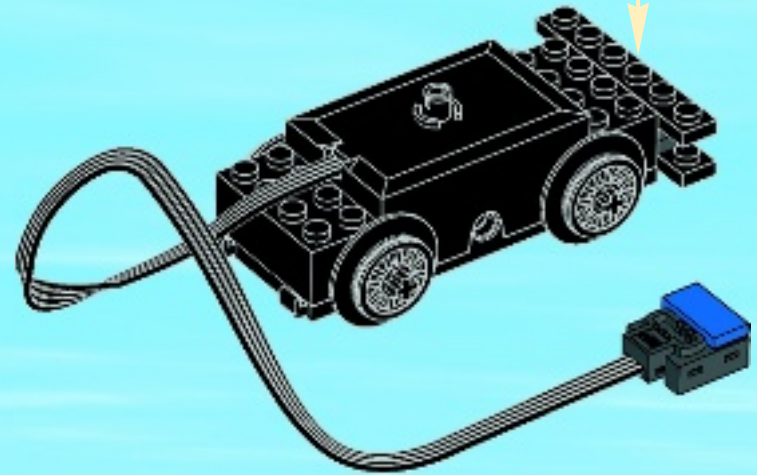
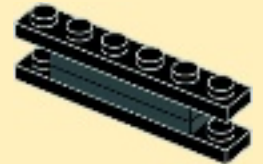



1x

5

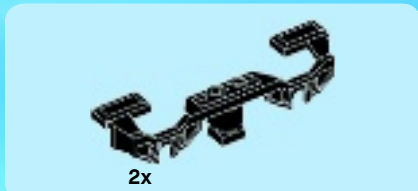
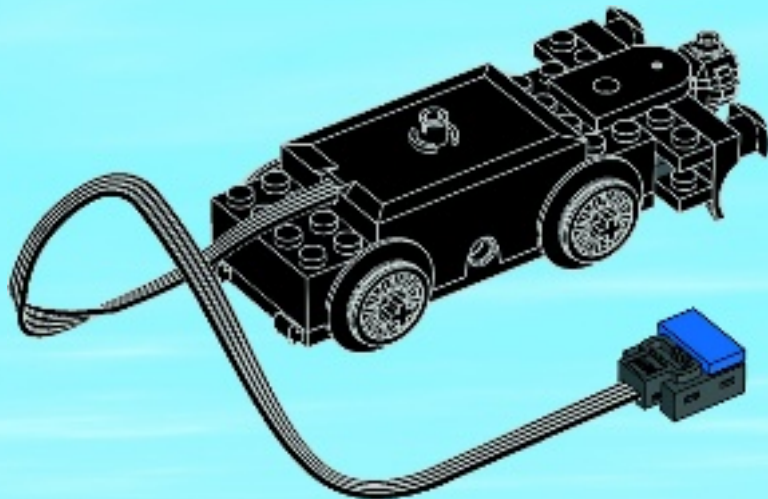



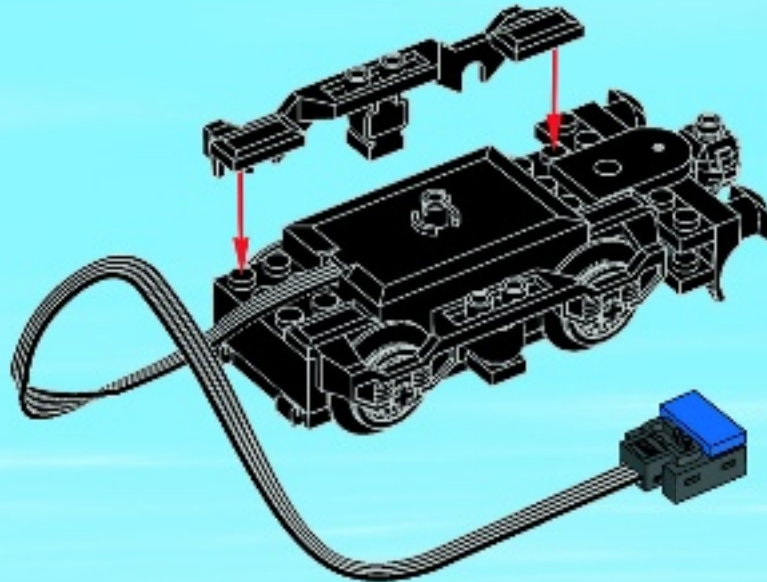

2x

6

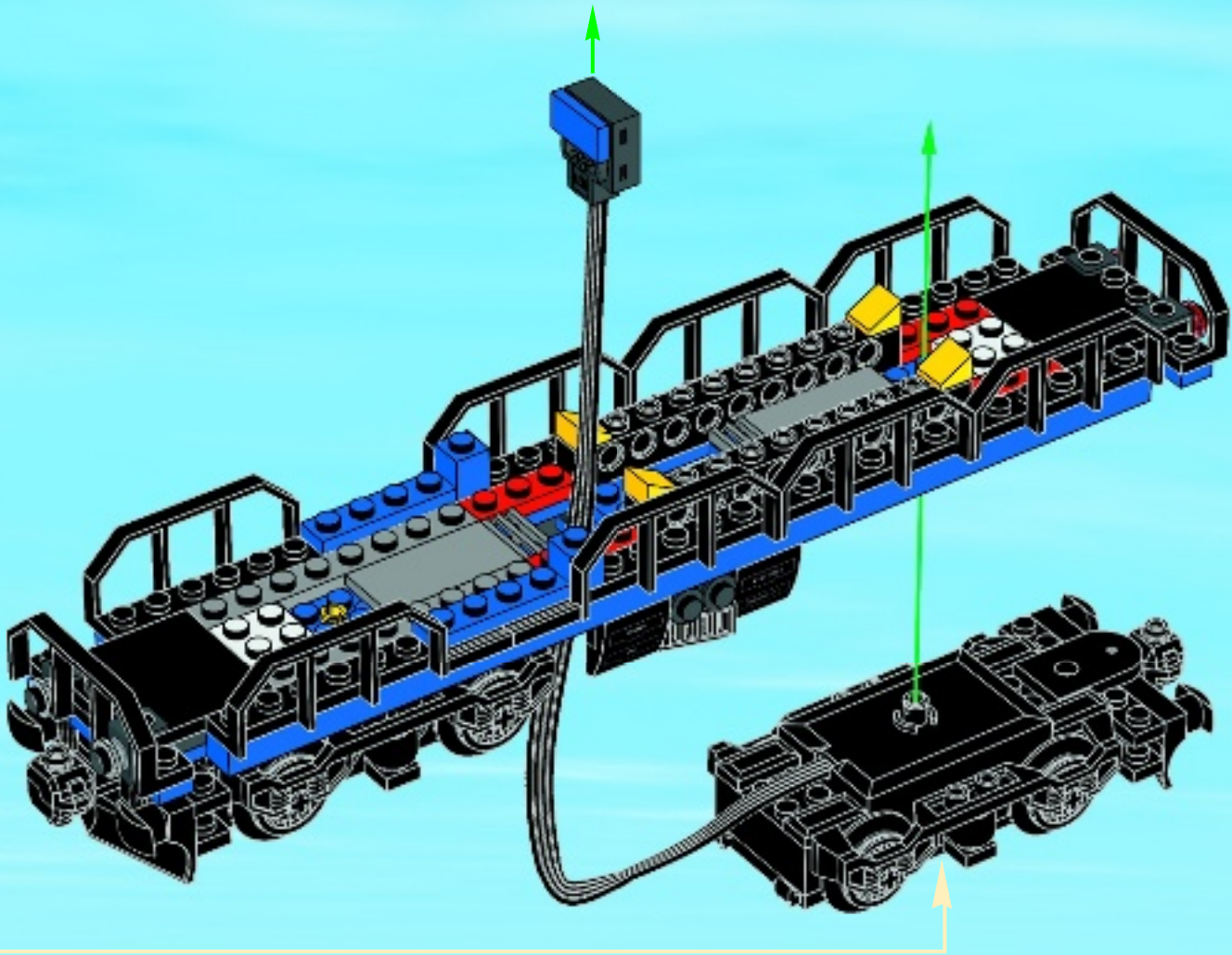

15



- 1x 
- 1x 
- 2x 

+

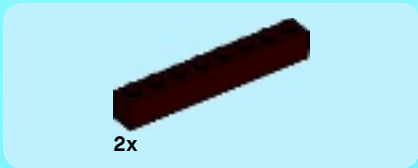
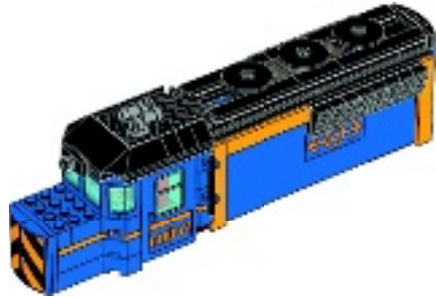

16

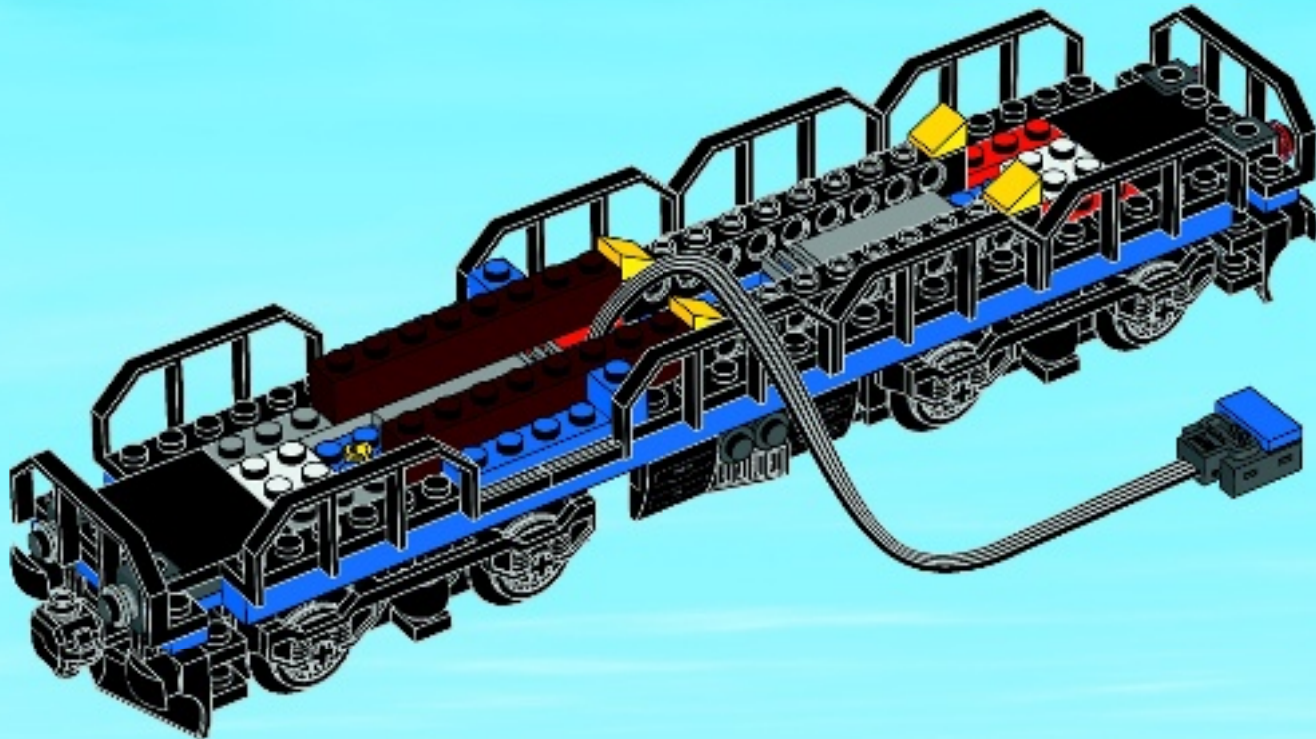

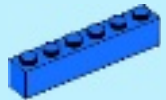

1x



2x

17

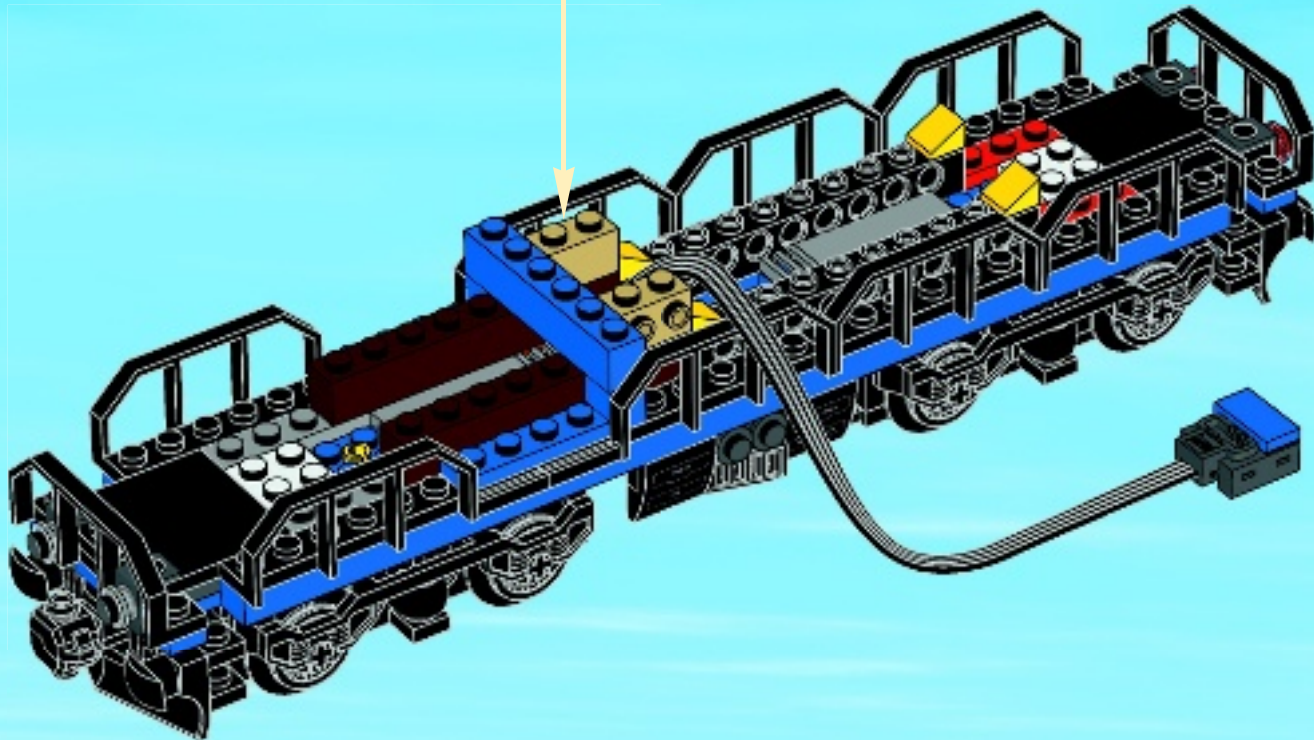



2x

18

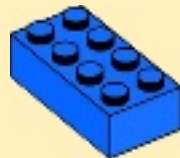

2x

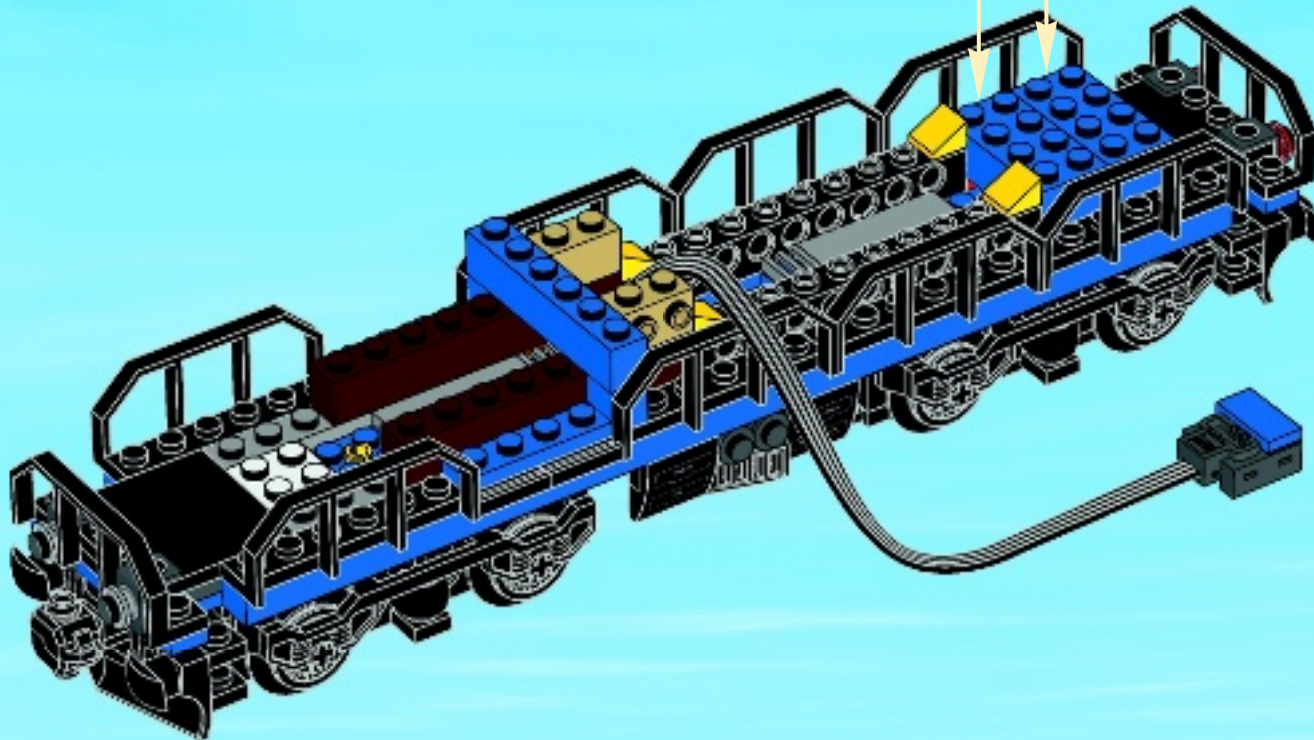

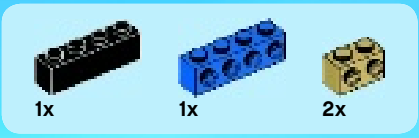

19

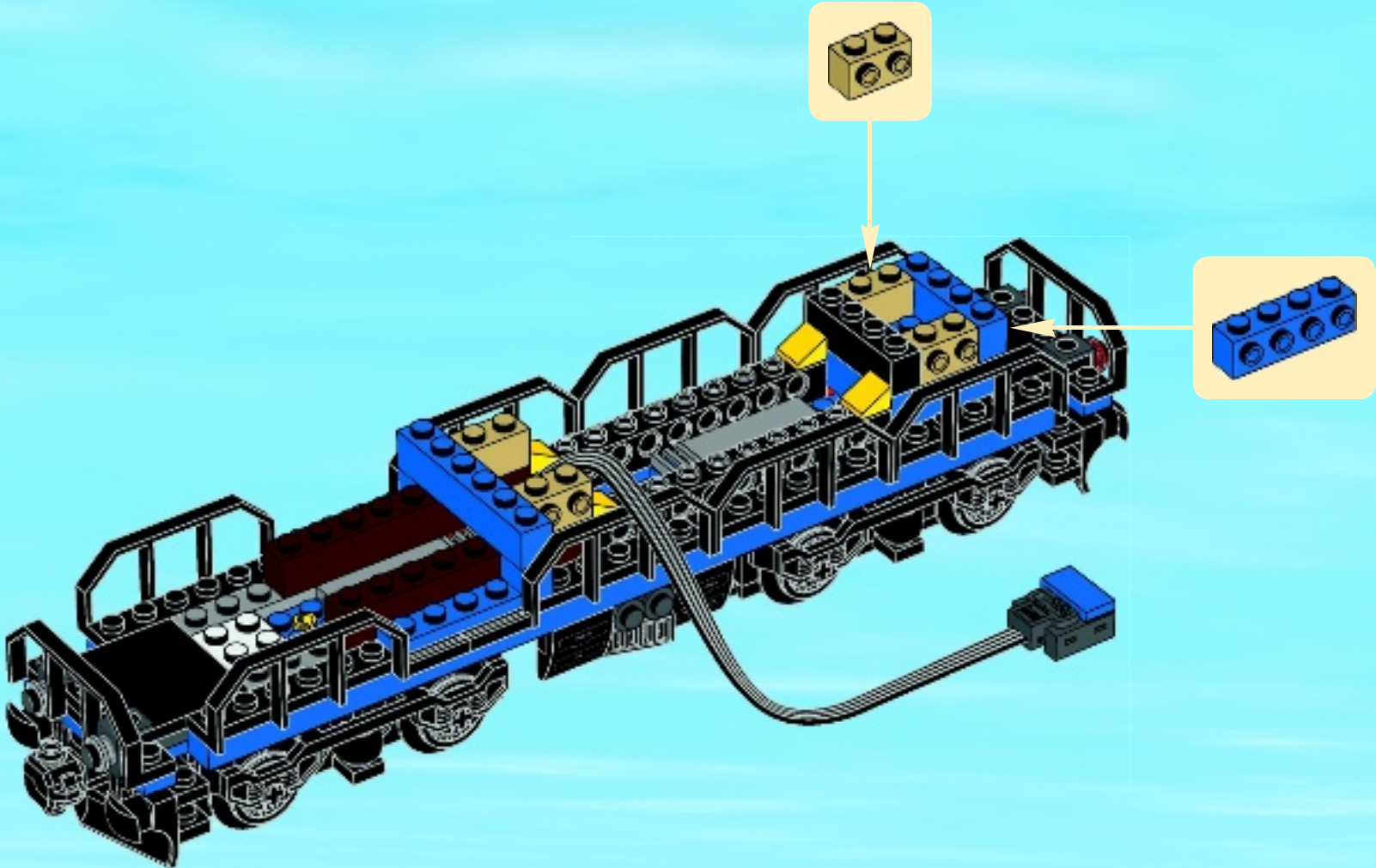

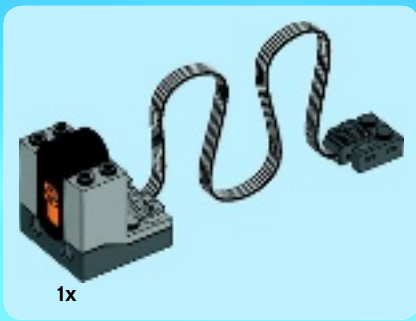

20

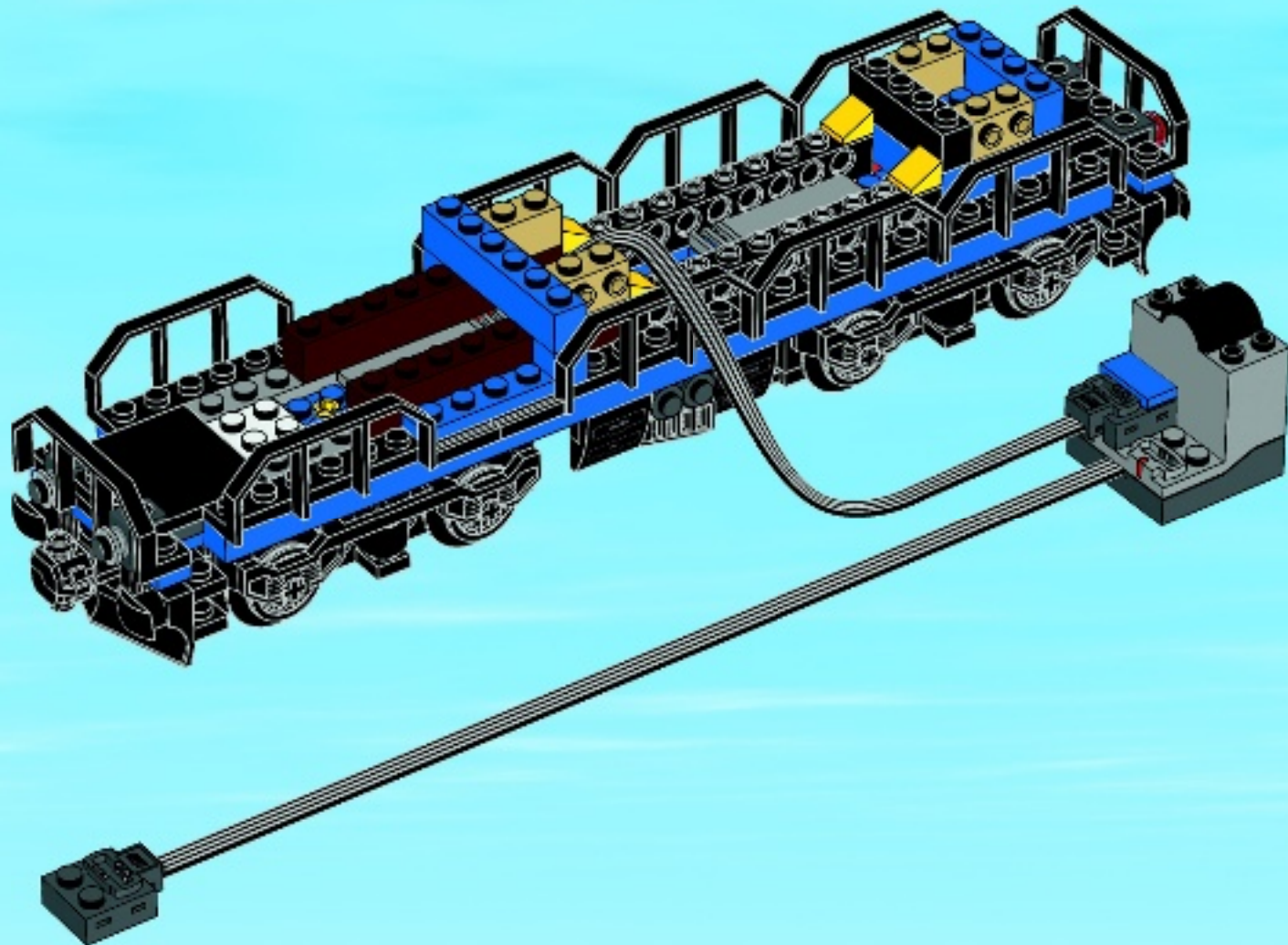

21

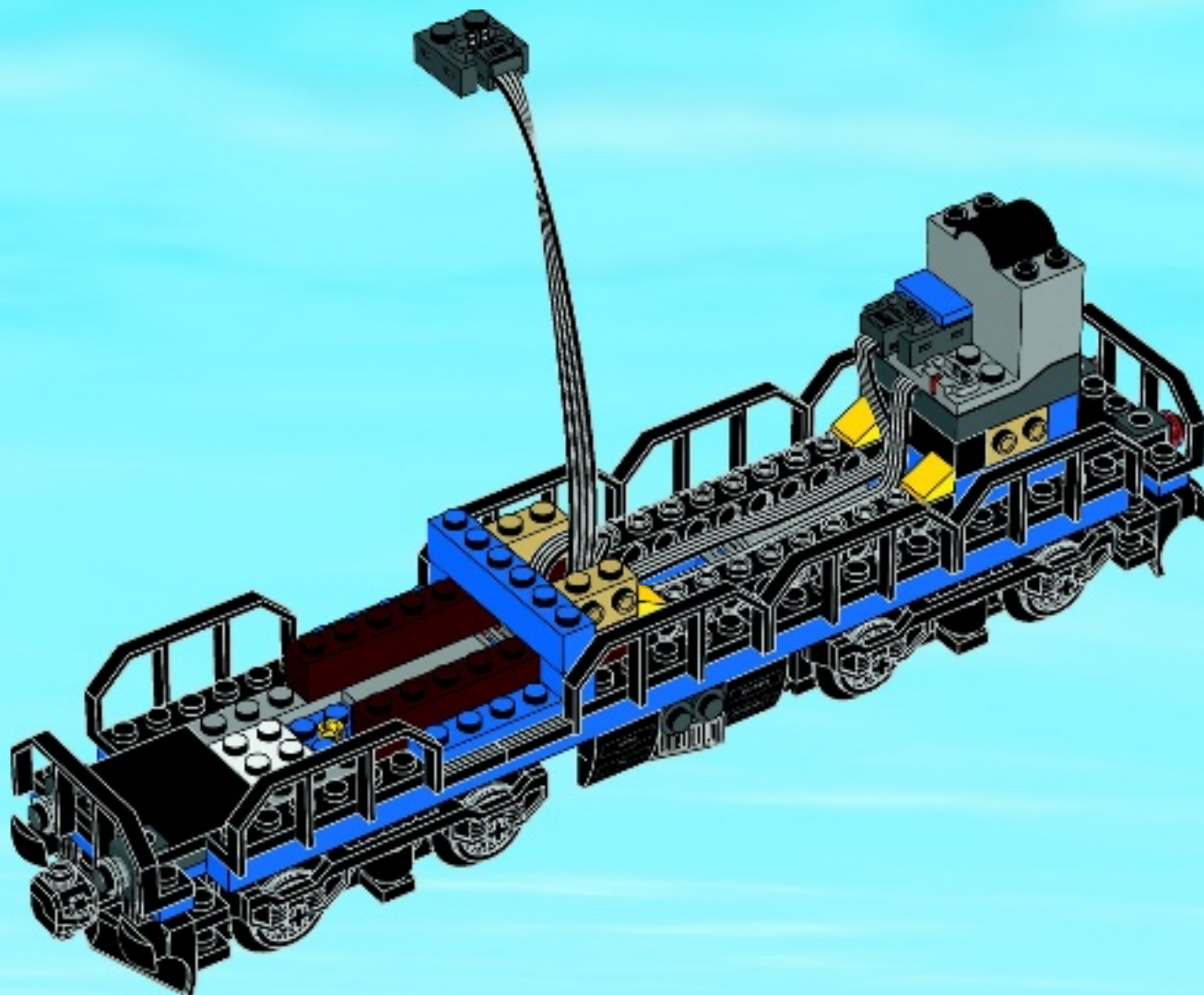

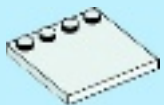

2x

22

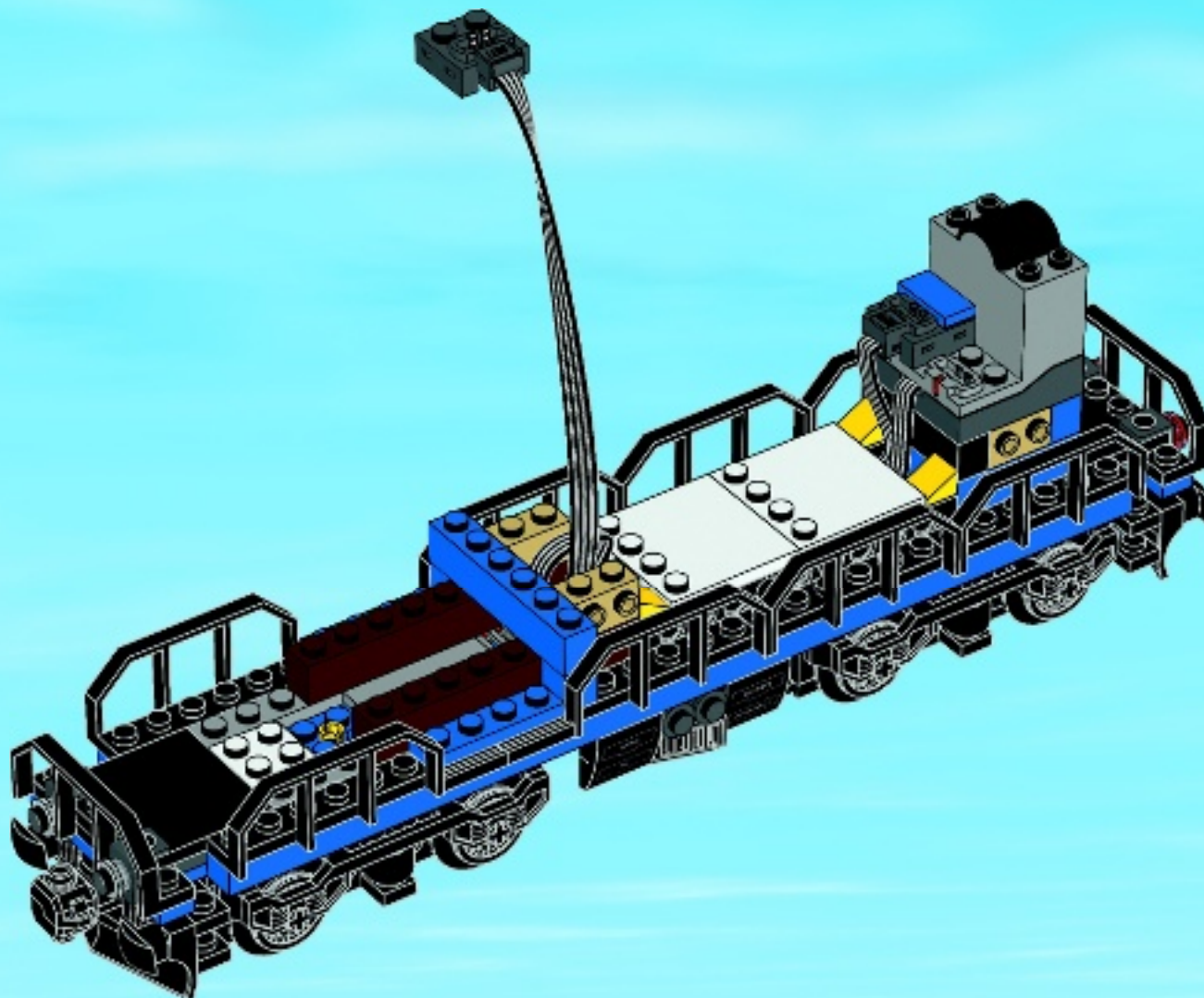



1x

23

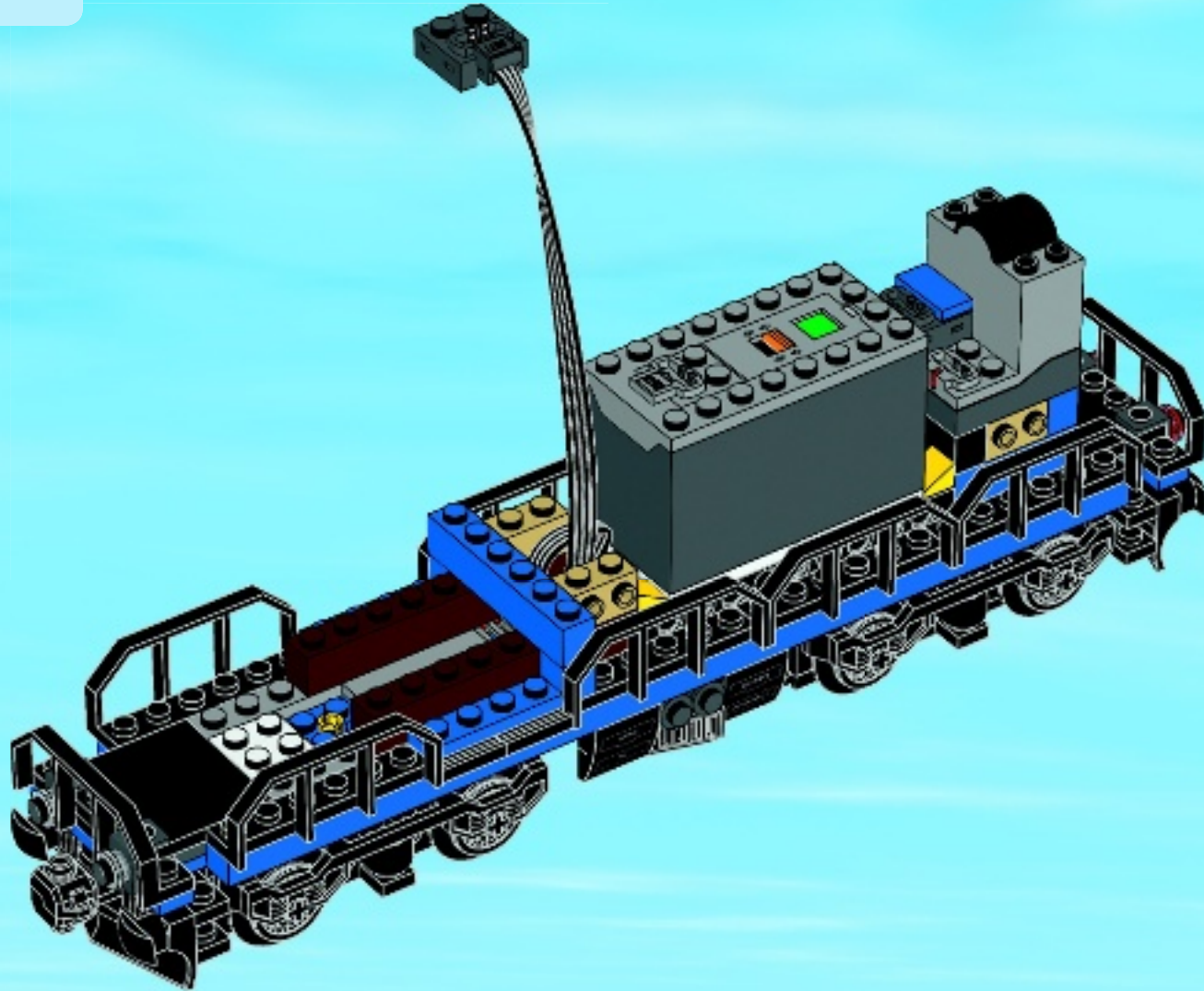



24





1x



1x

25





26

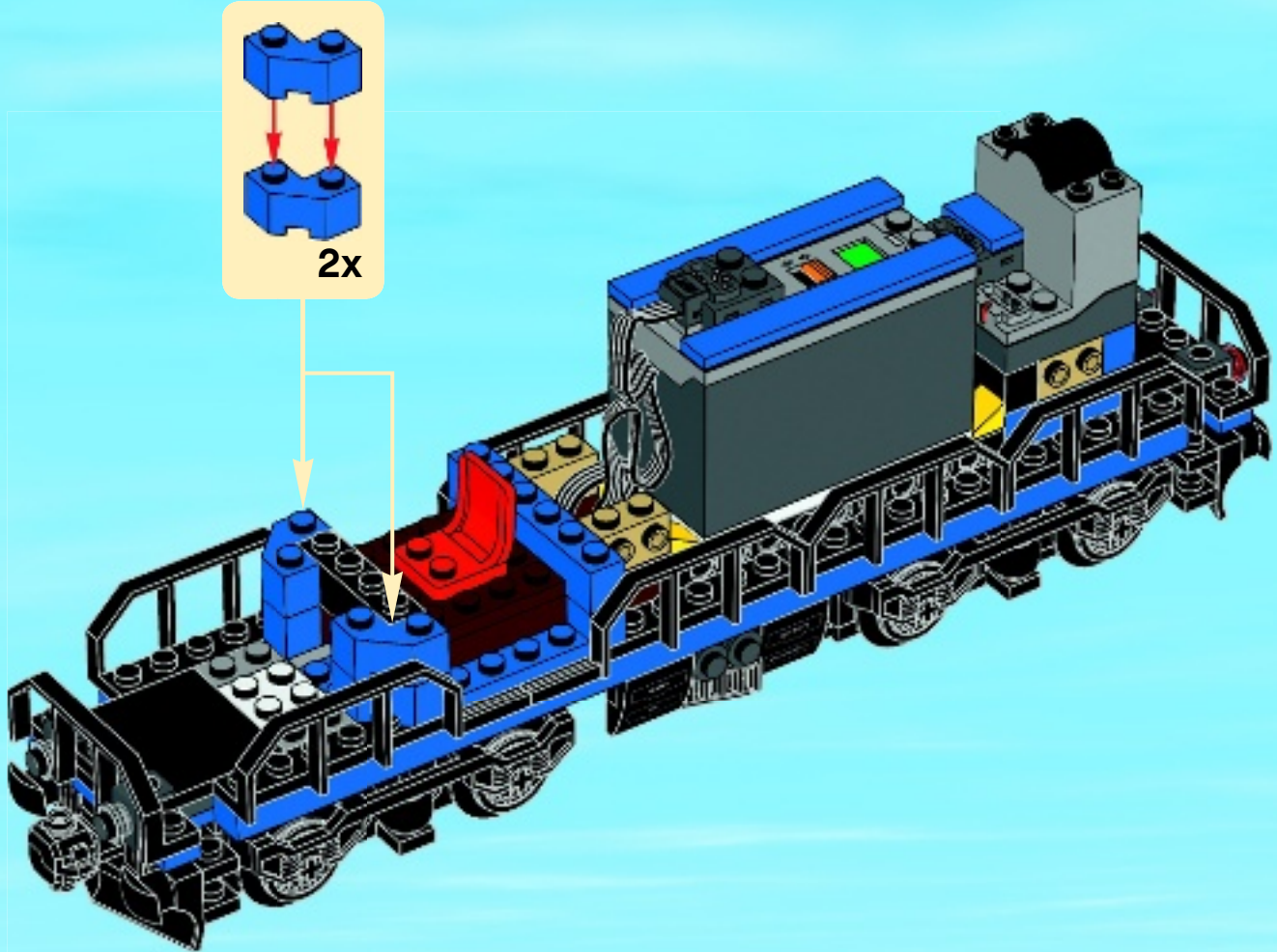



4x

27

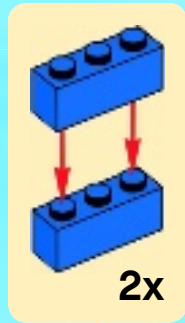

2x

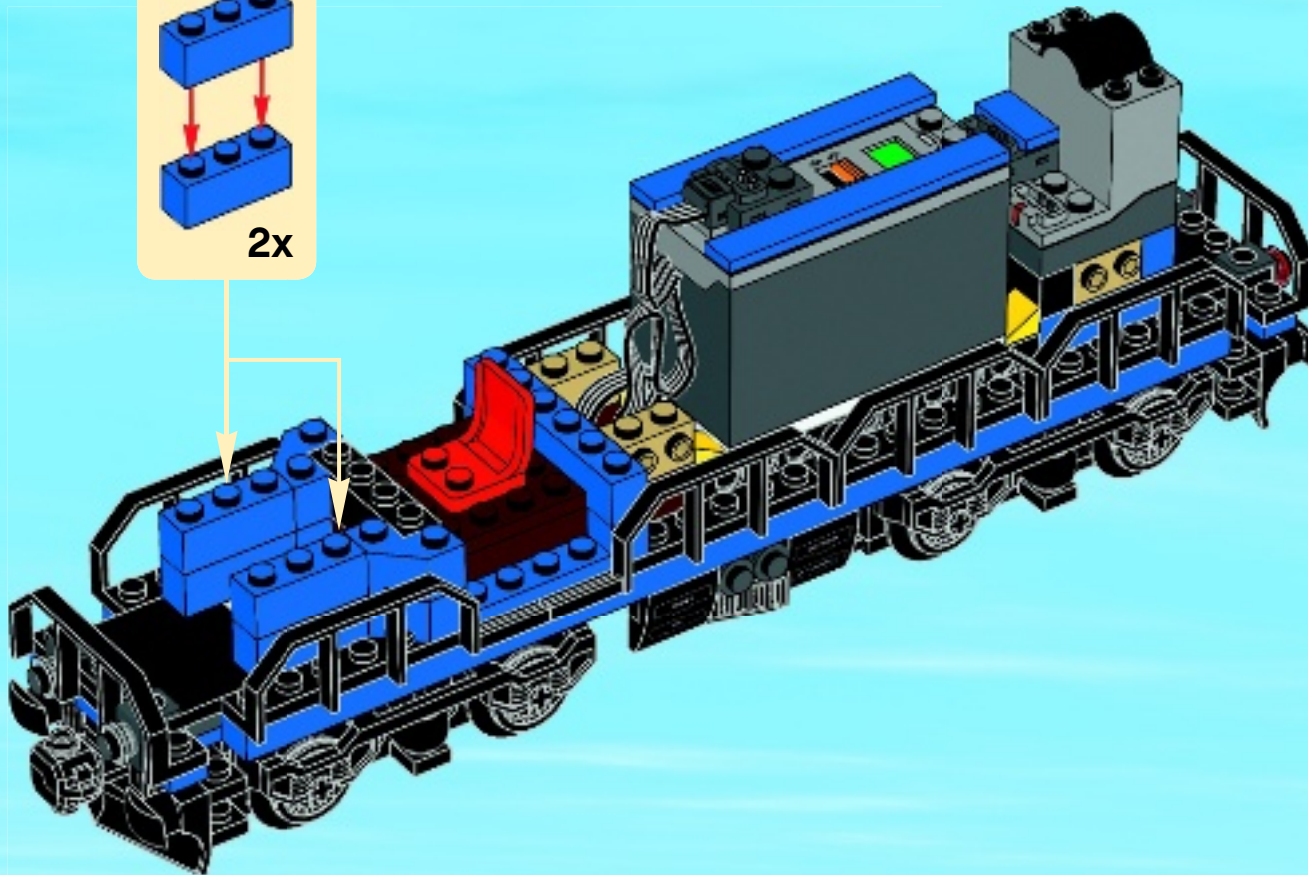



3x



2x

28

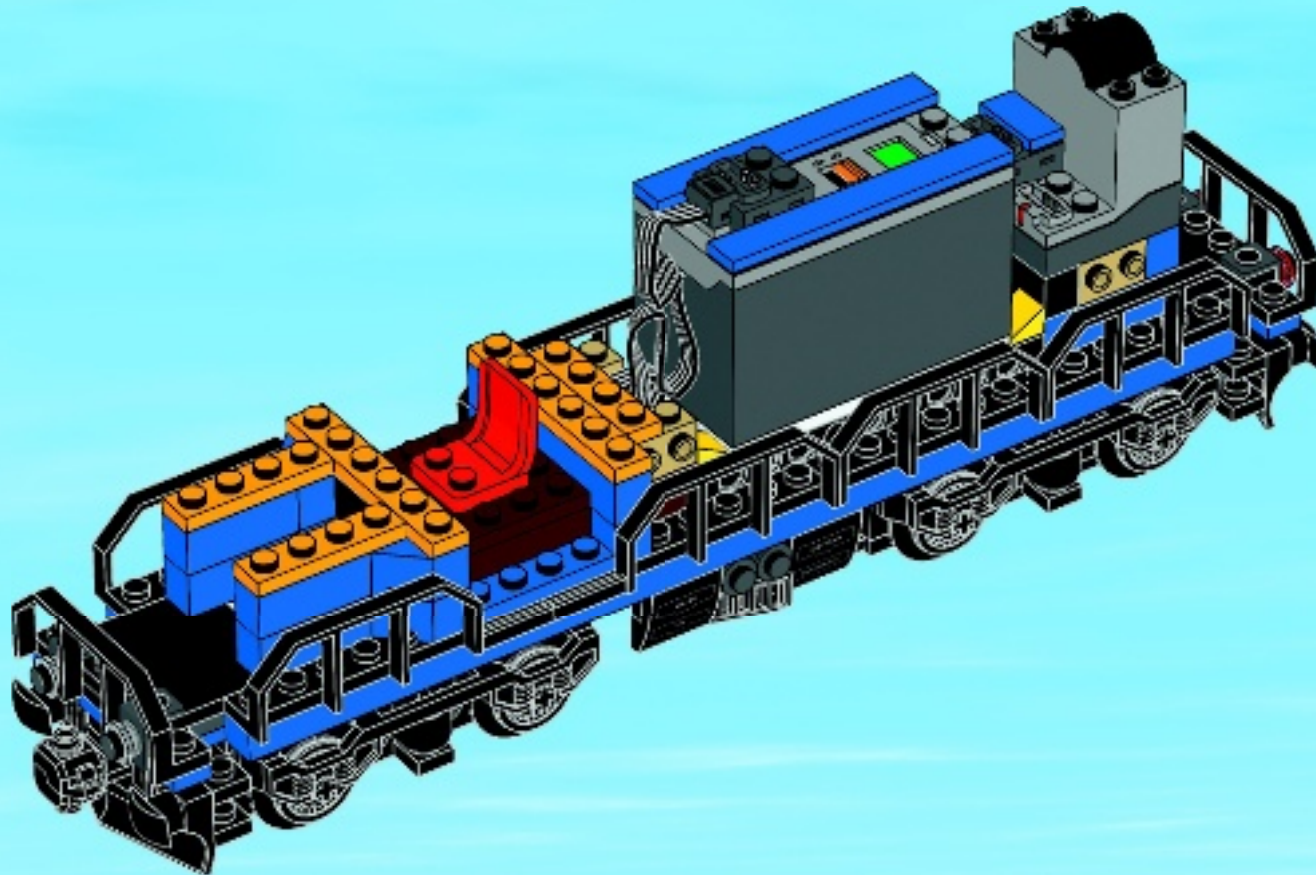



1x



2x

29

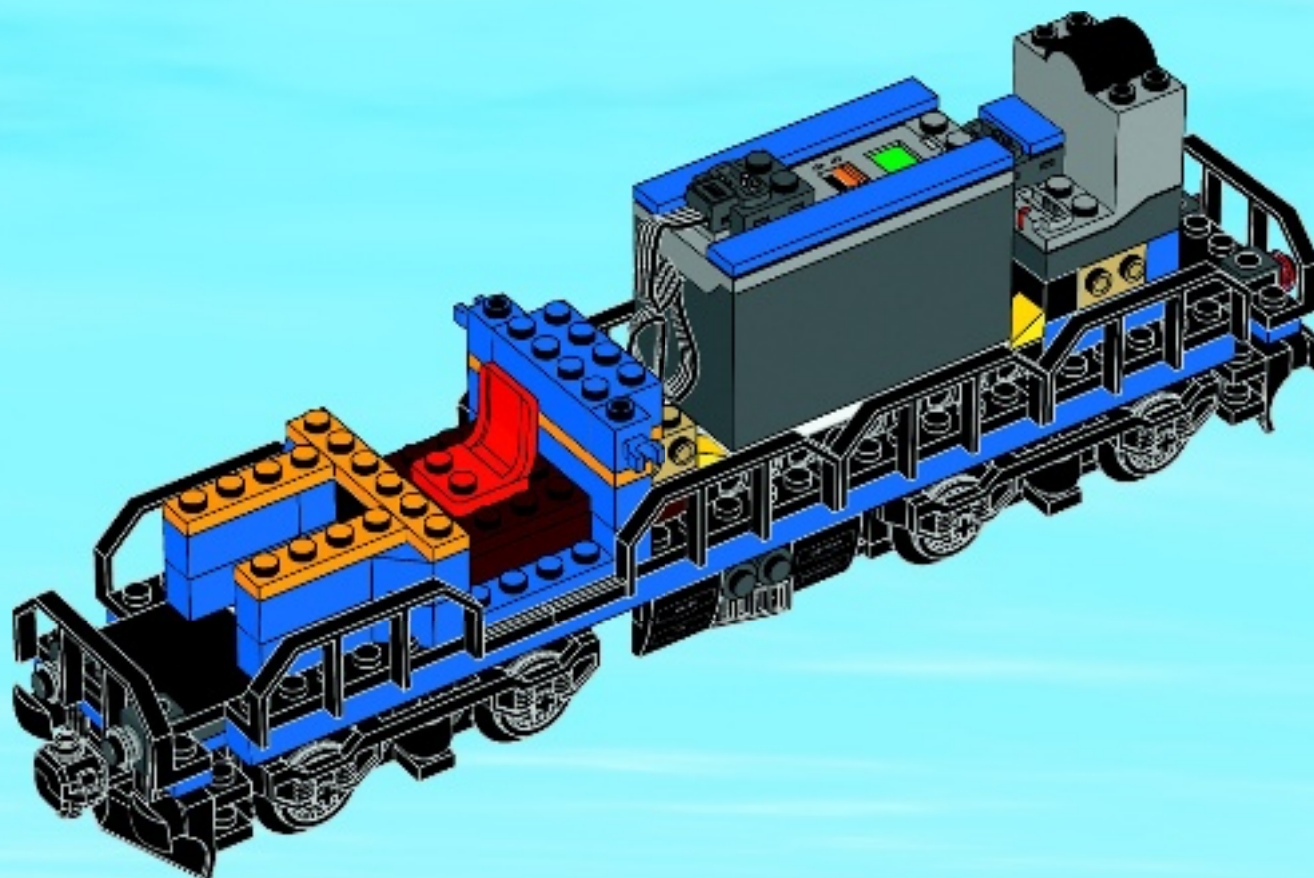



1x



1x

30

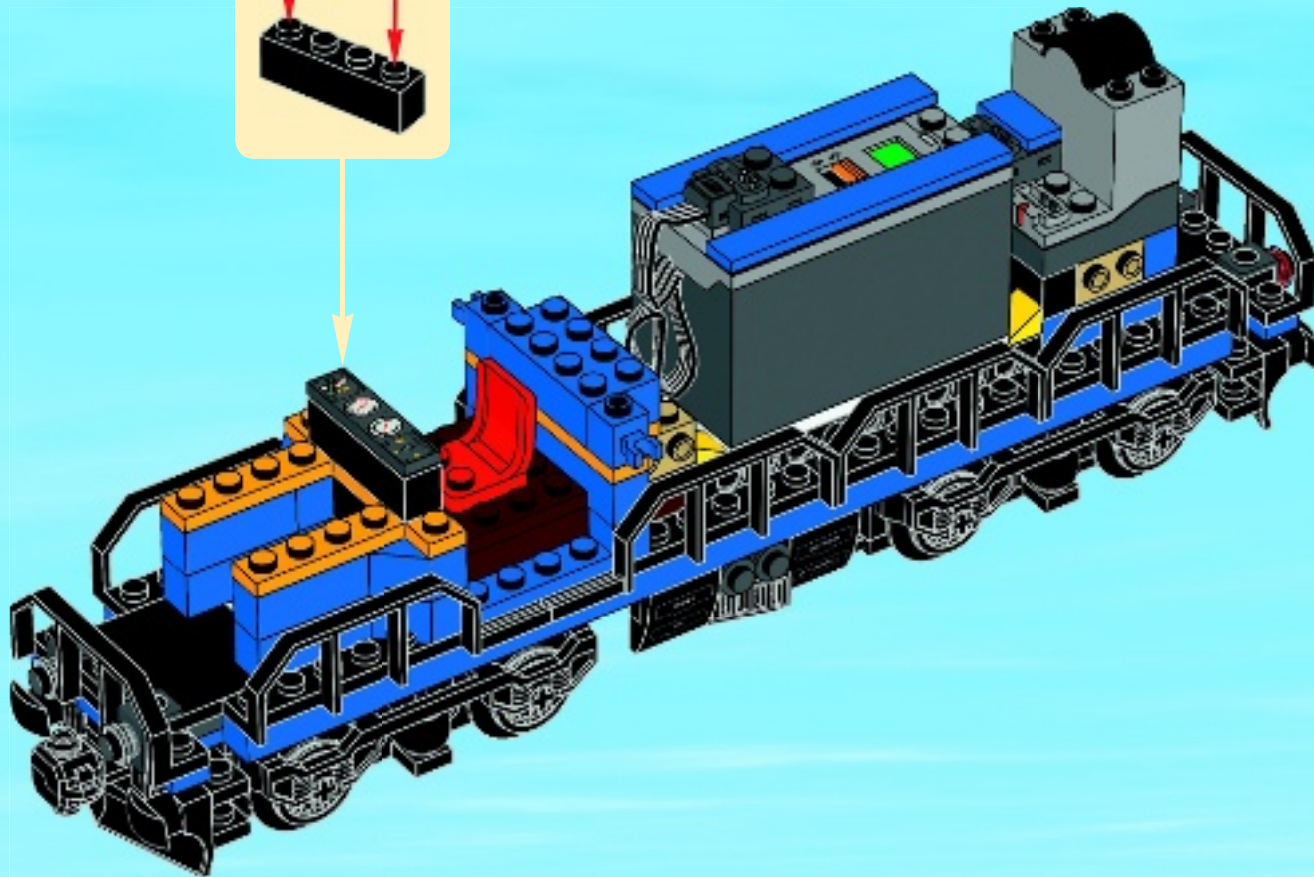
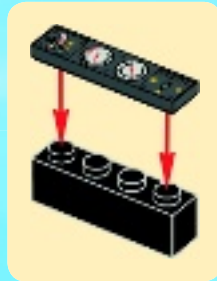

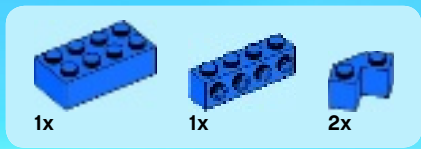

31

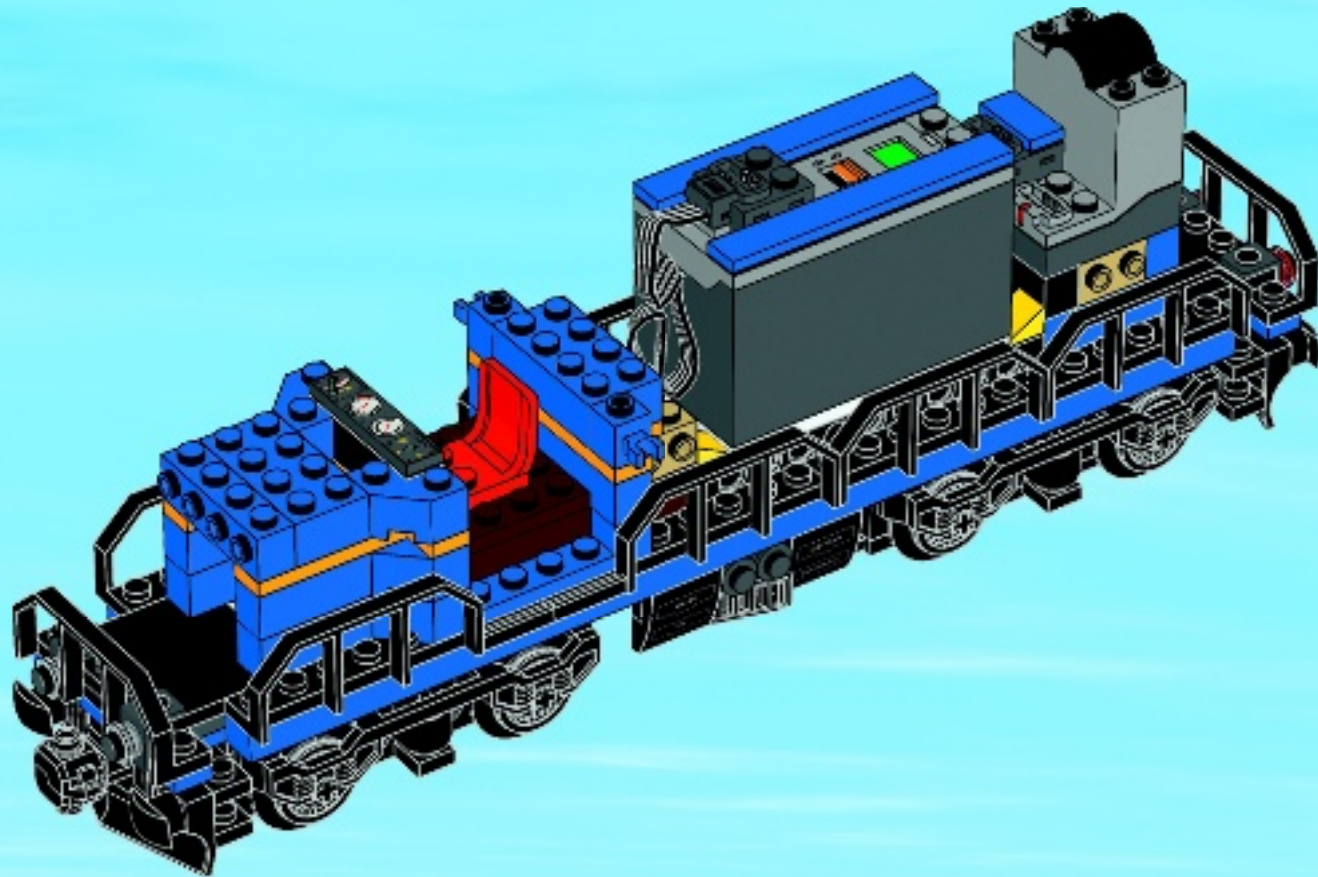

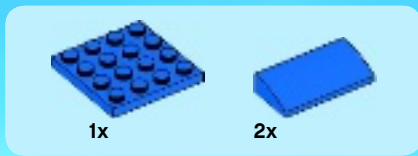

32

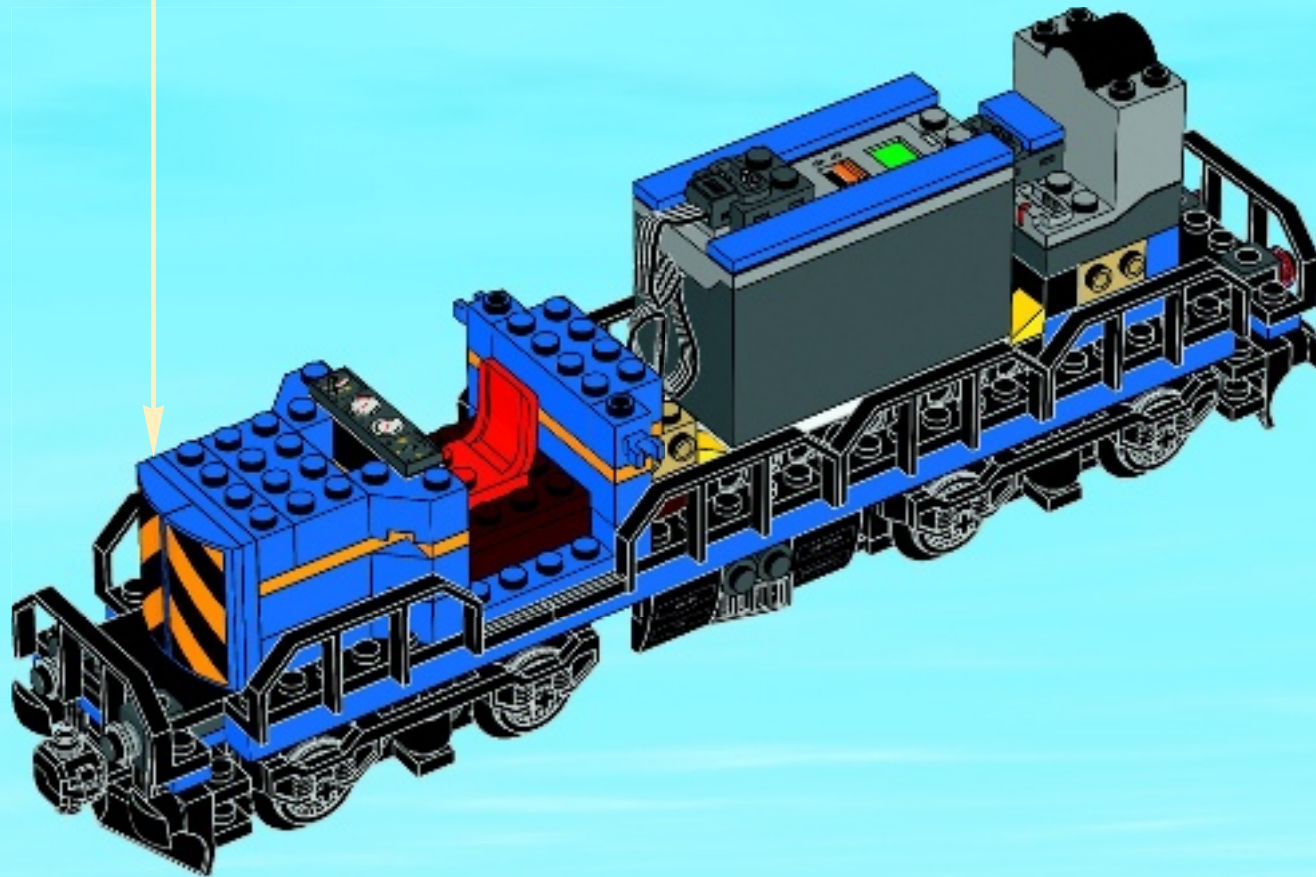
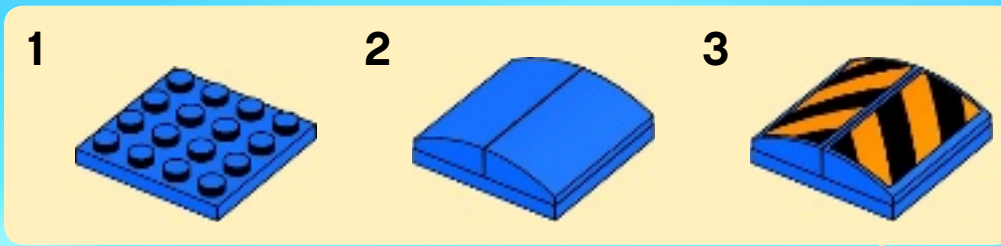

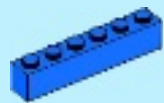

1x



1x

33

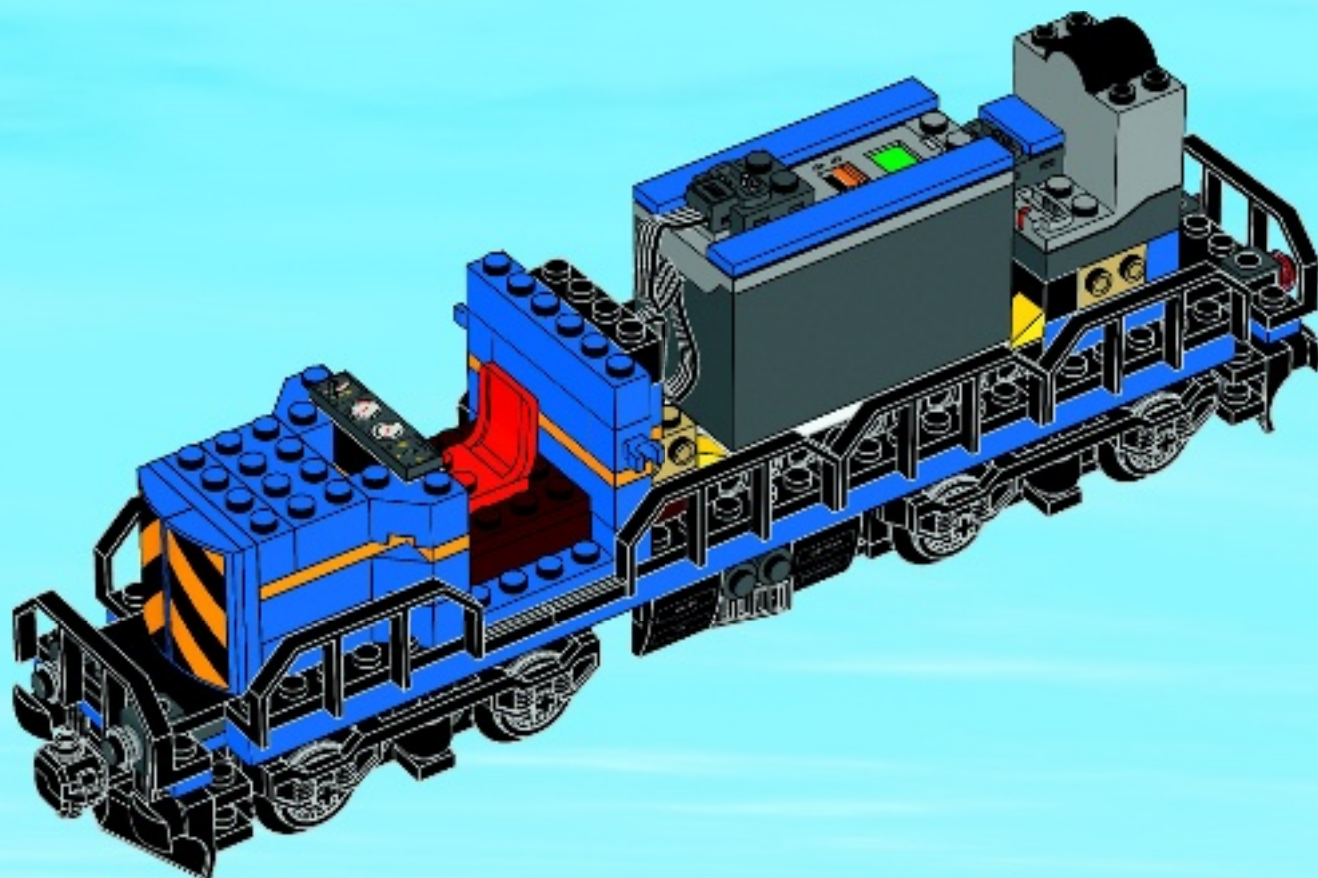



2x



2x

34





1x



2x

35



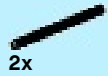

2x

36



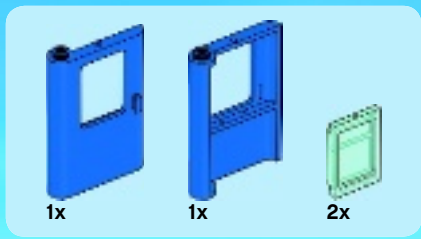

37

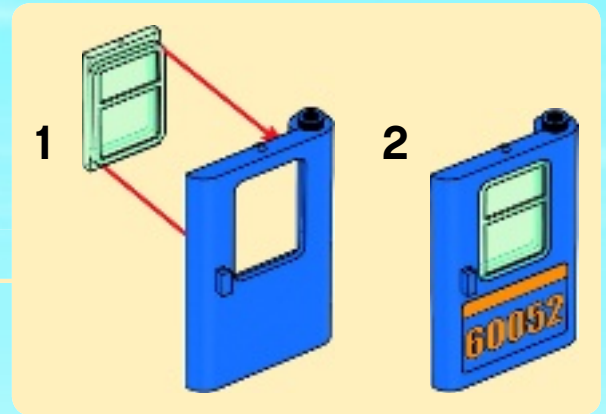
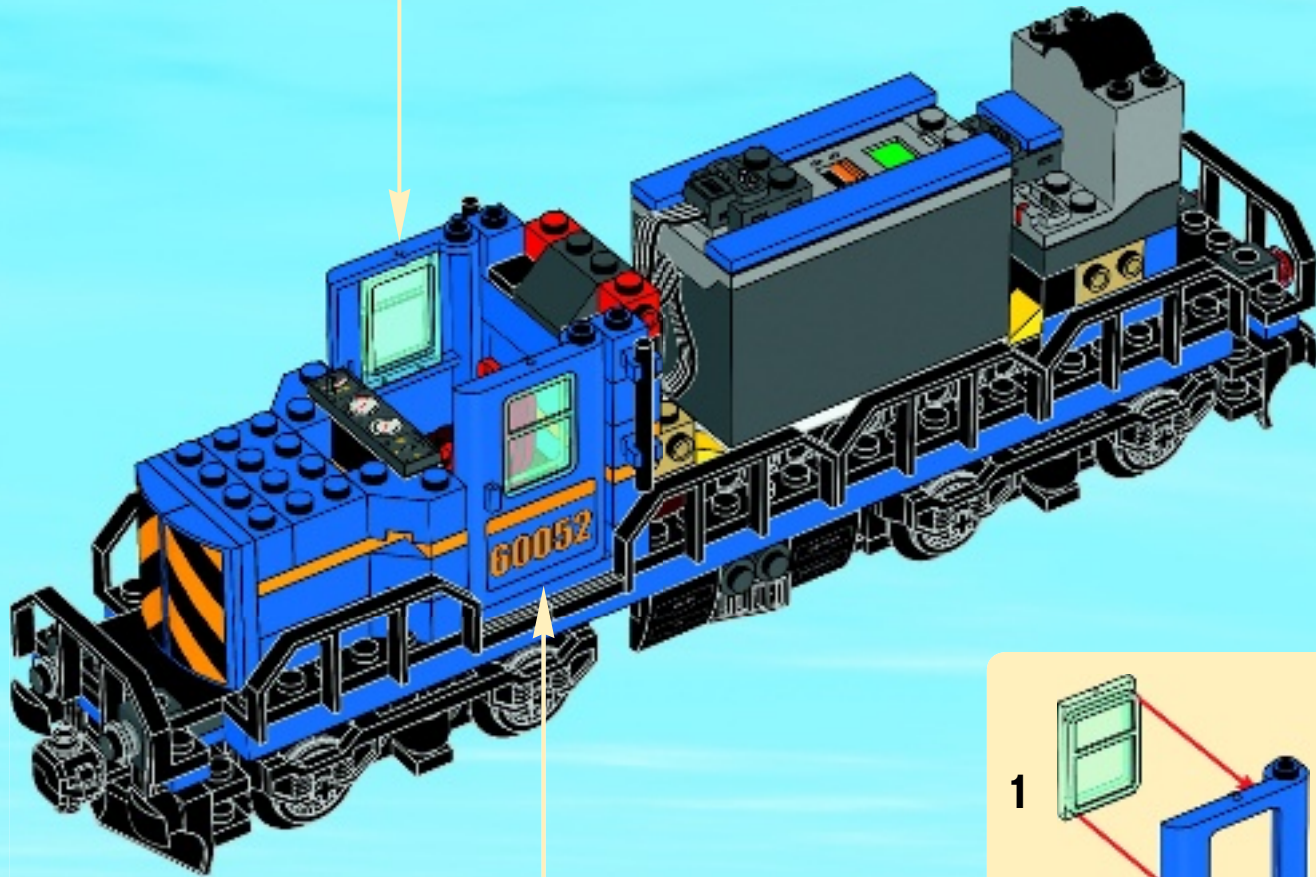
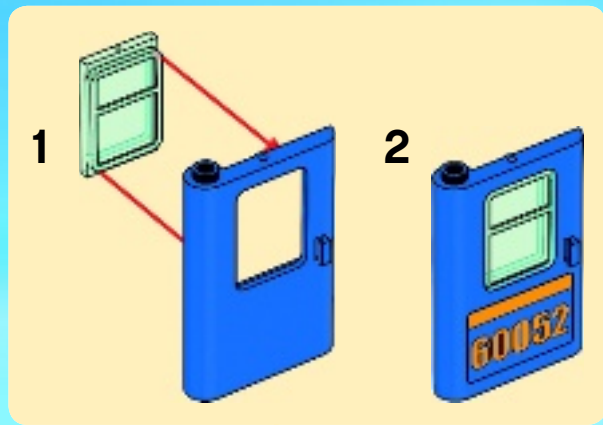

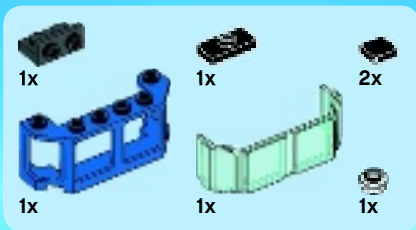

38

1

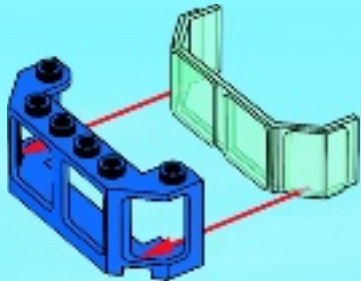

2



3

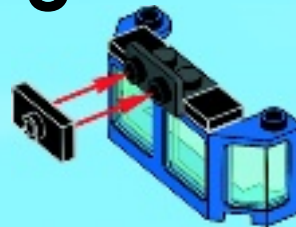

4







2x

39



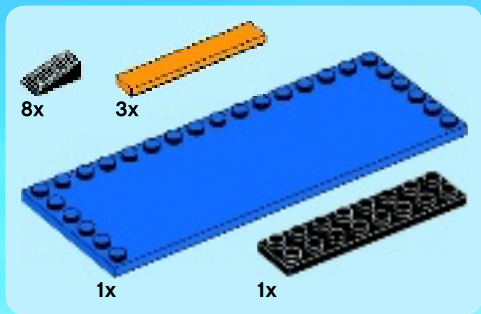

40

1

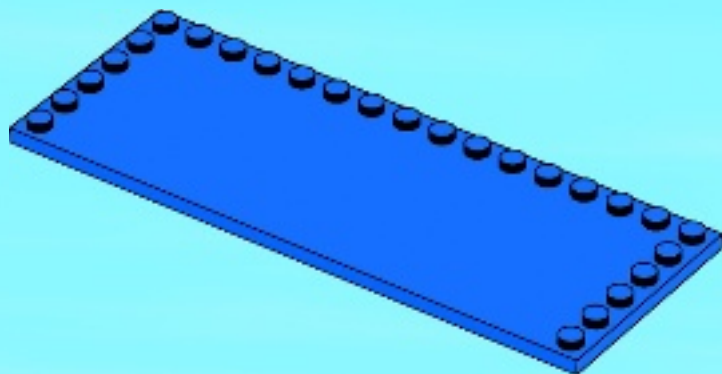

2

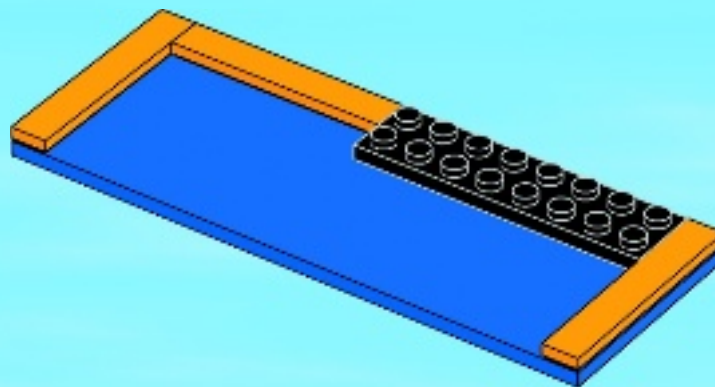

3

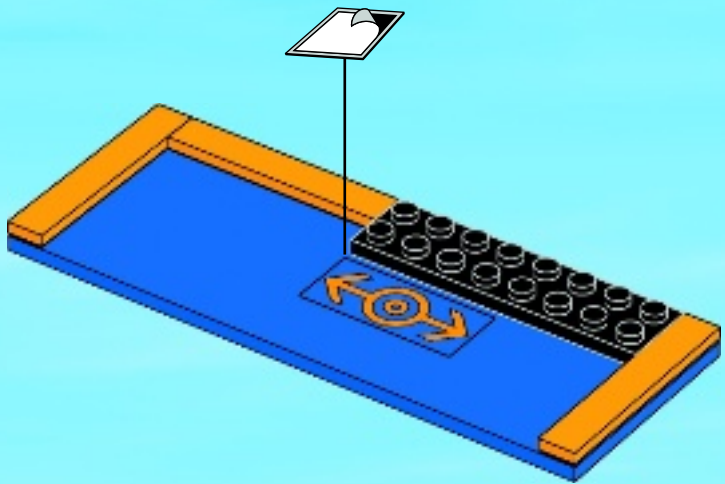

4

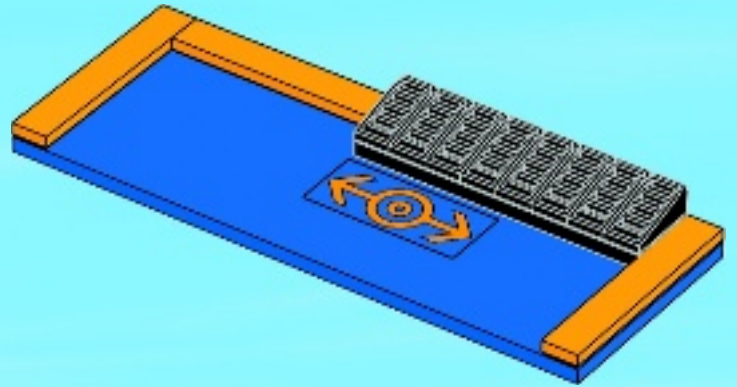



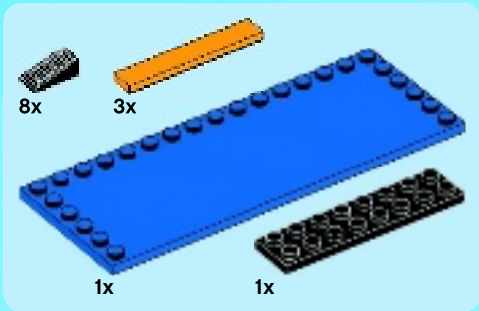
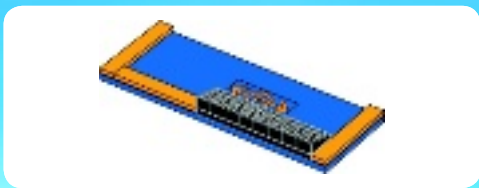

41

1

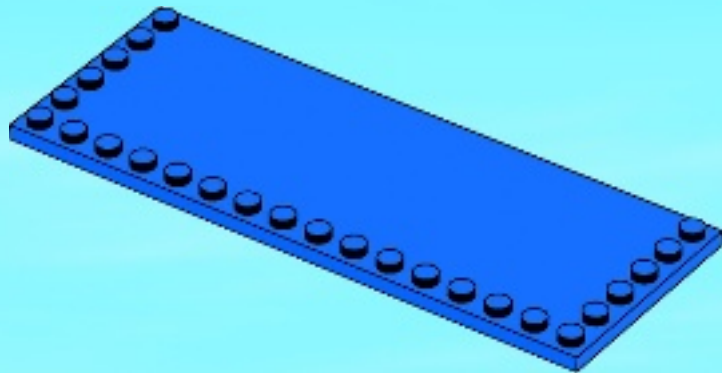

2

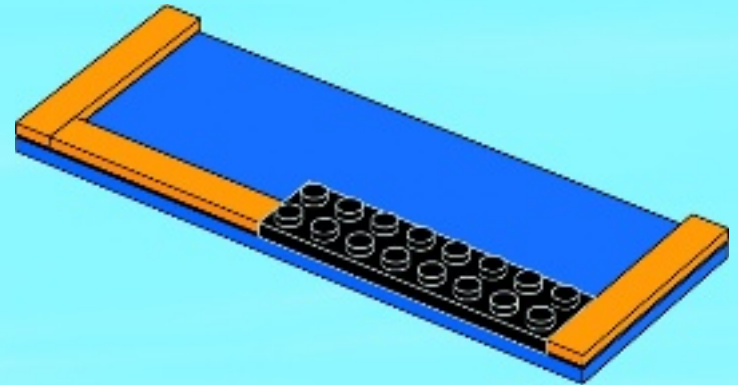

3

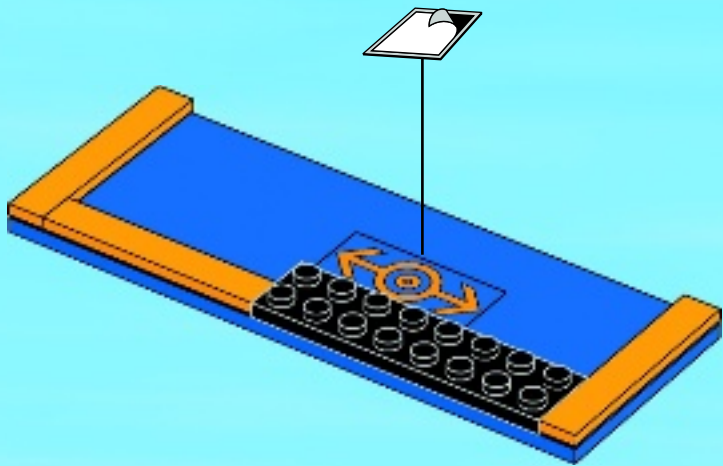

4

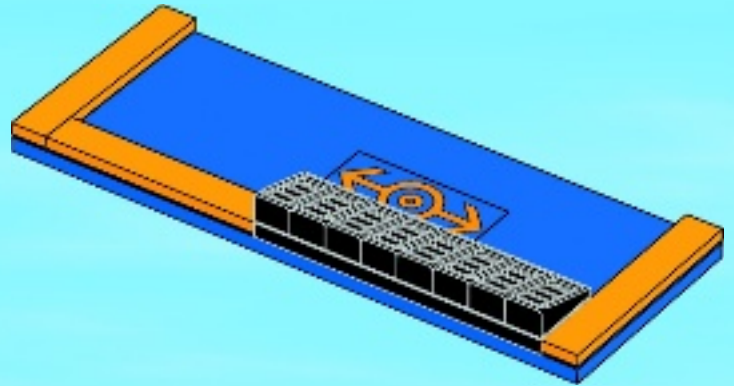



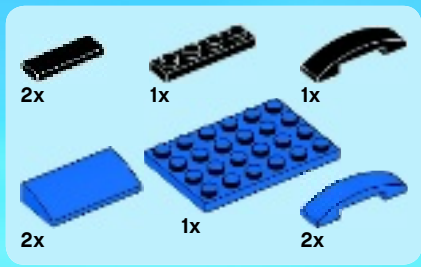

42

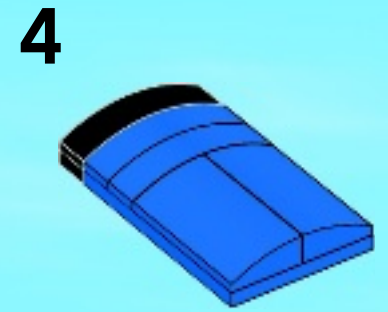
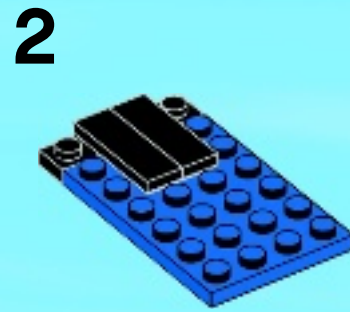
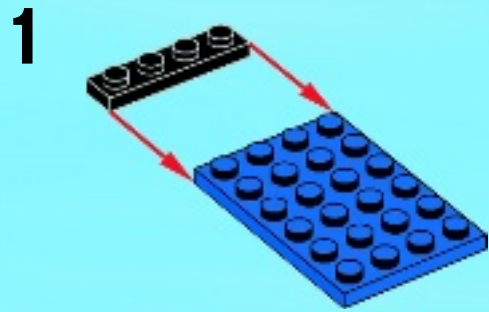

5





1



2

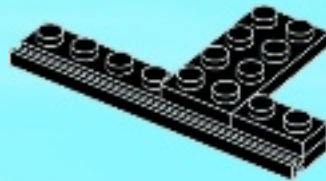



3

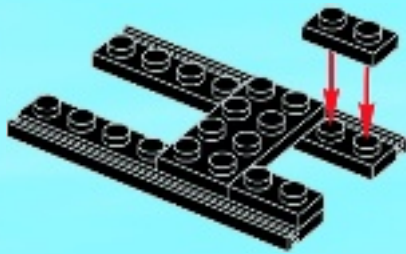

4

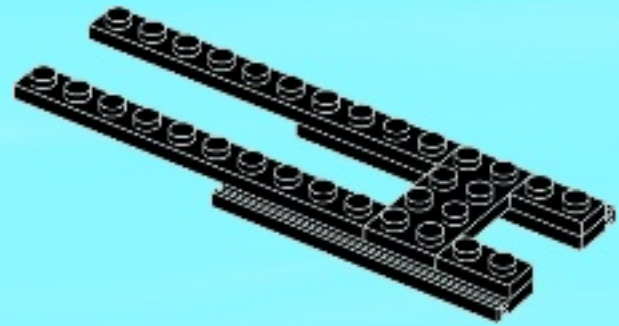



2x

5

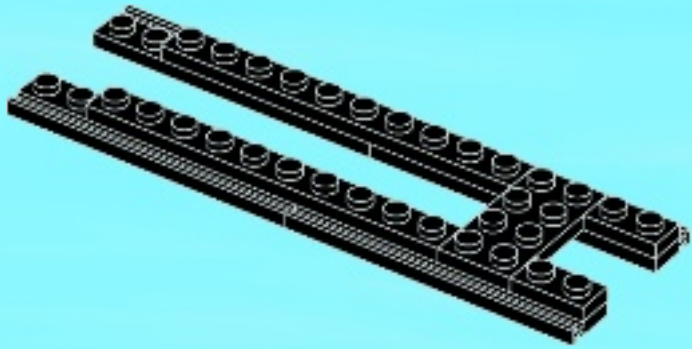

2x

6

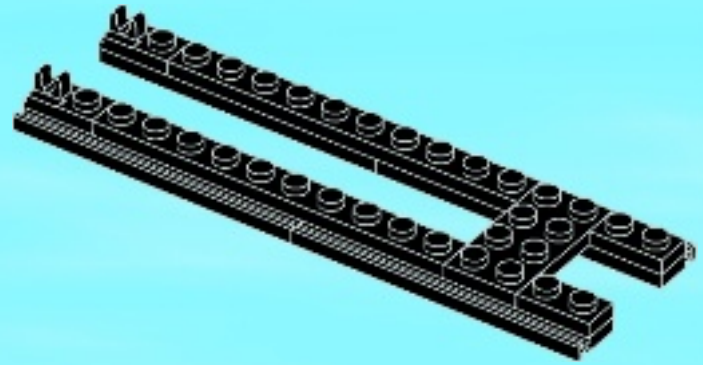



7

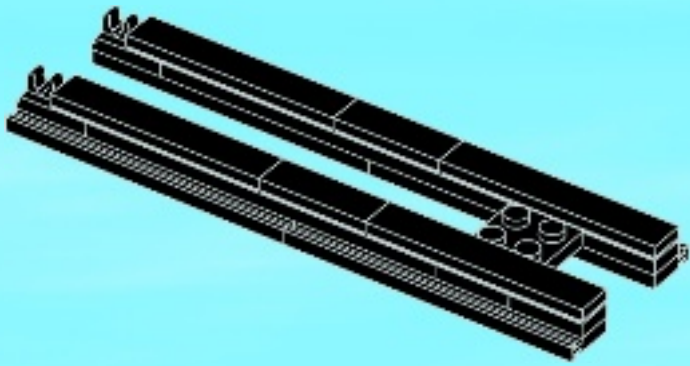

8

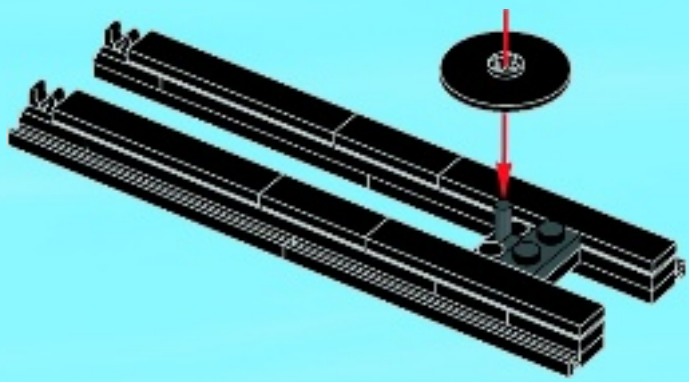

43





1



2



3

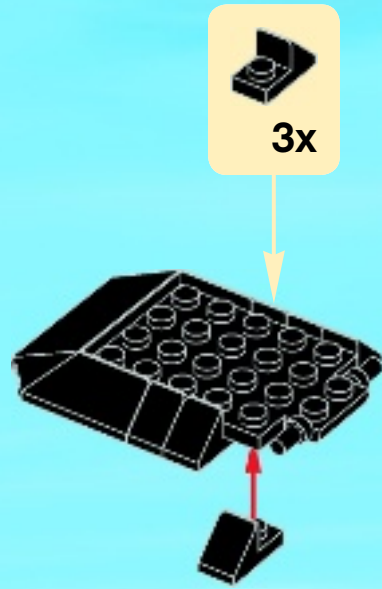

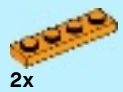

2x

4

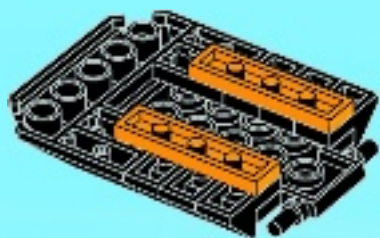

2x

5



2x

6



44

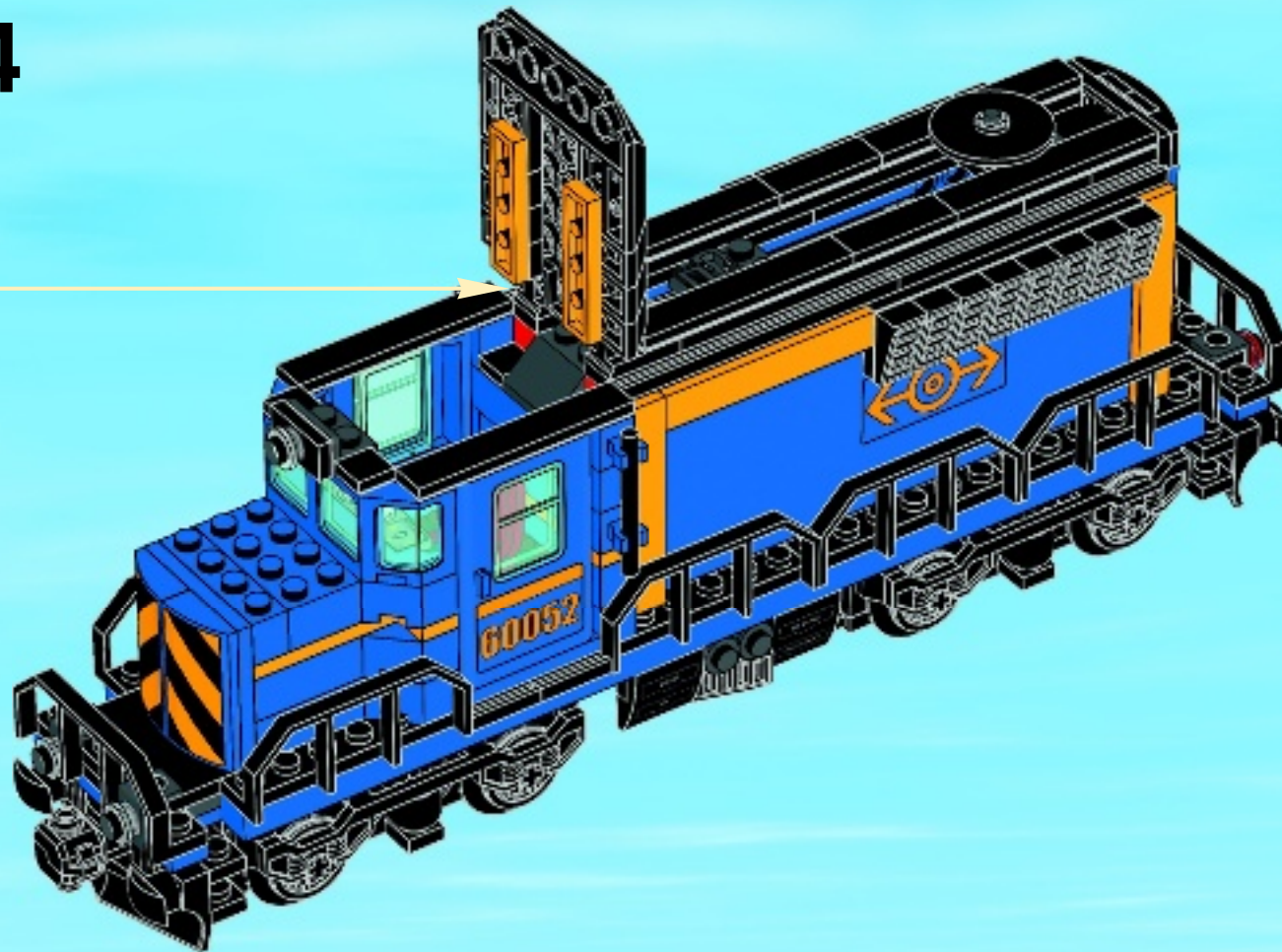



45

1



2

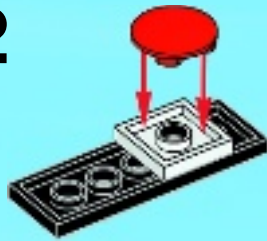

3

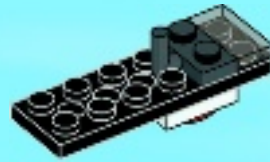

4

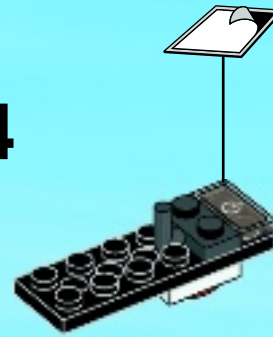

5



6



46

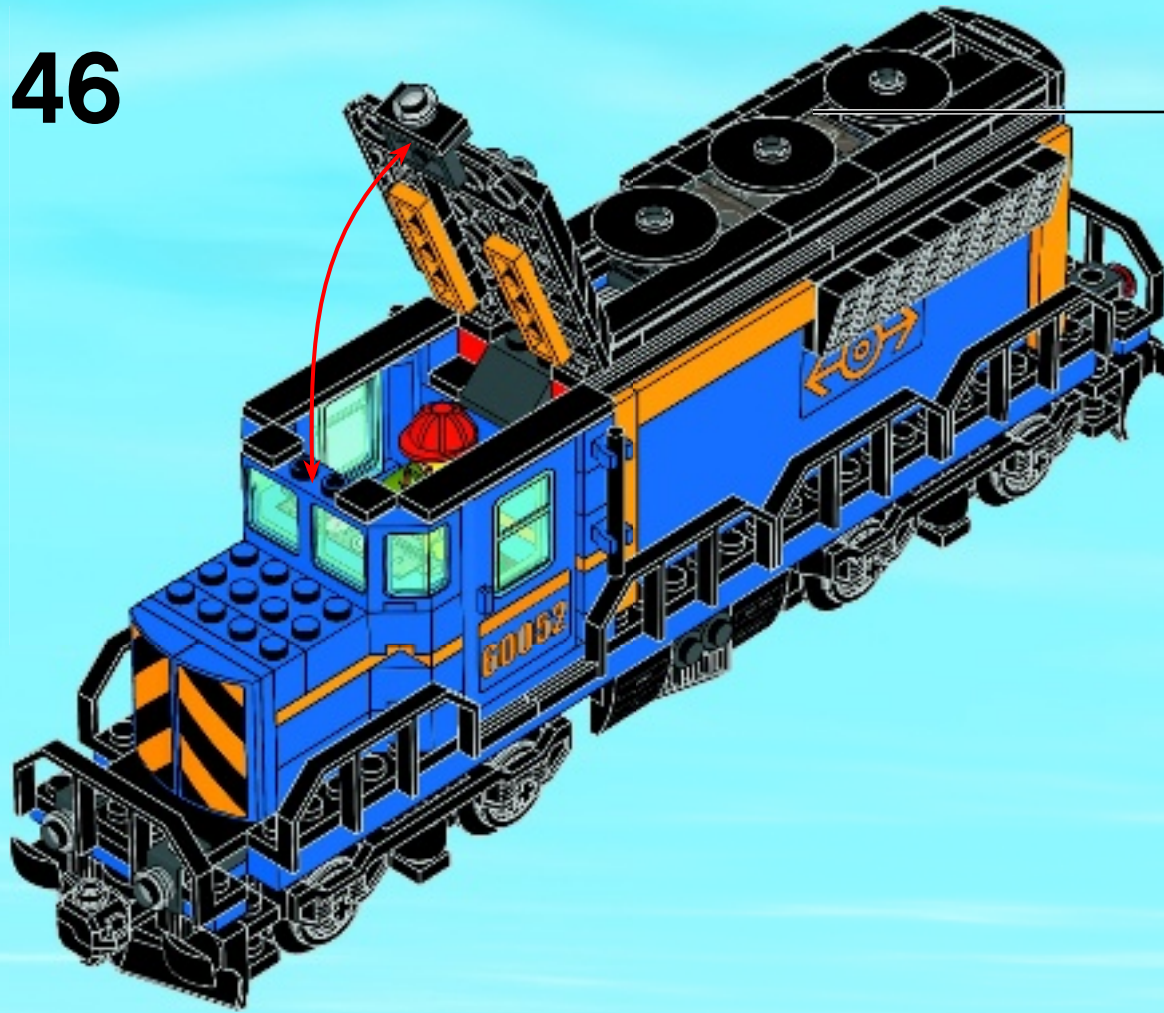

on/off

An/Aus

Marche/arrêt

Encendido/apagado

Ligado/Desligado

Be/ki

开/关

Hidup/mati

1

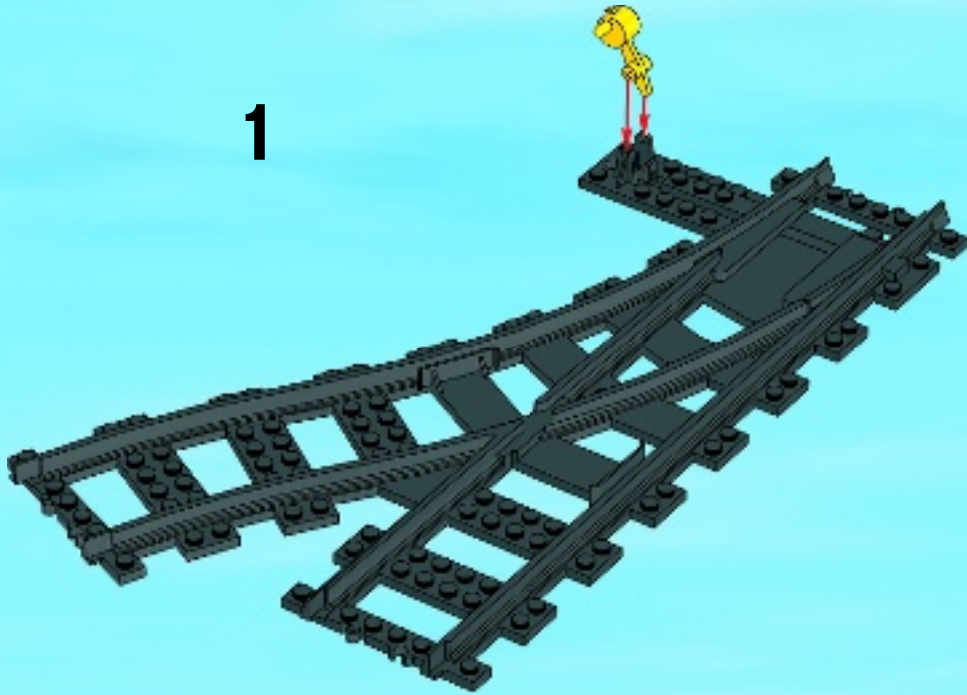

2

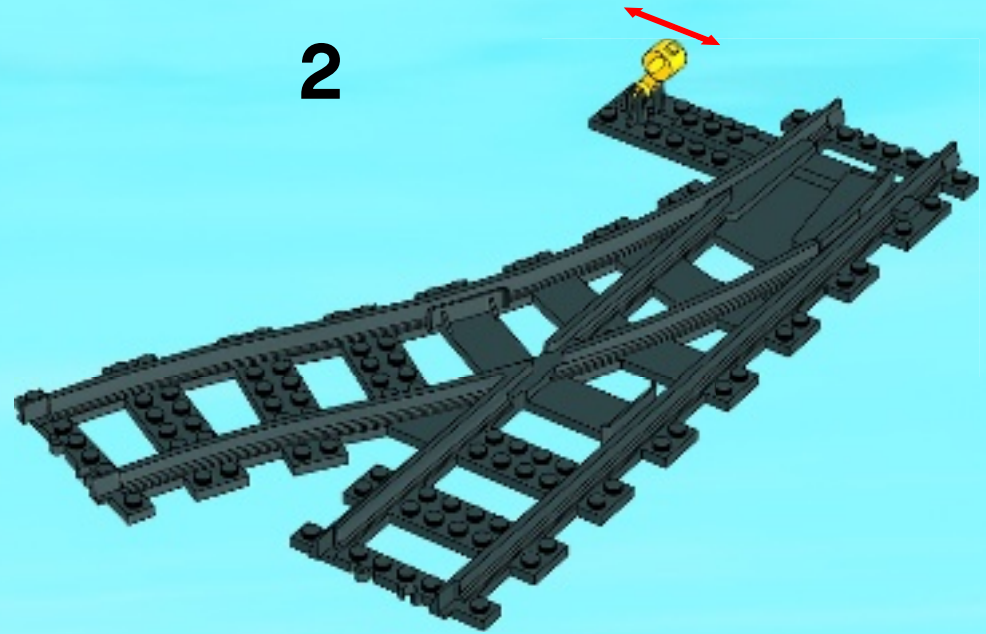

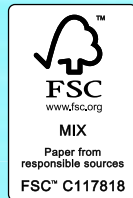
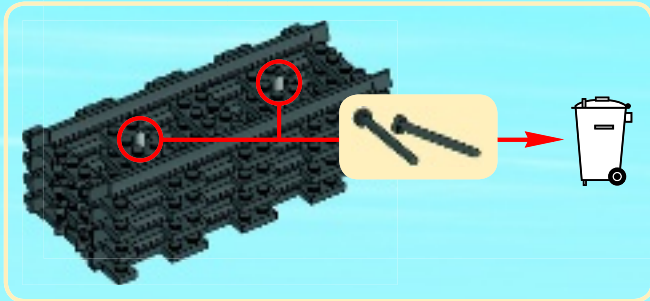
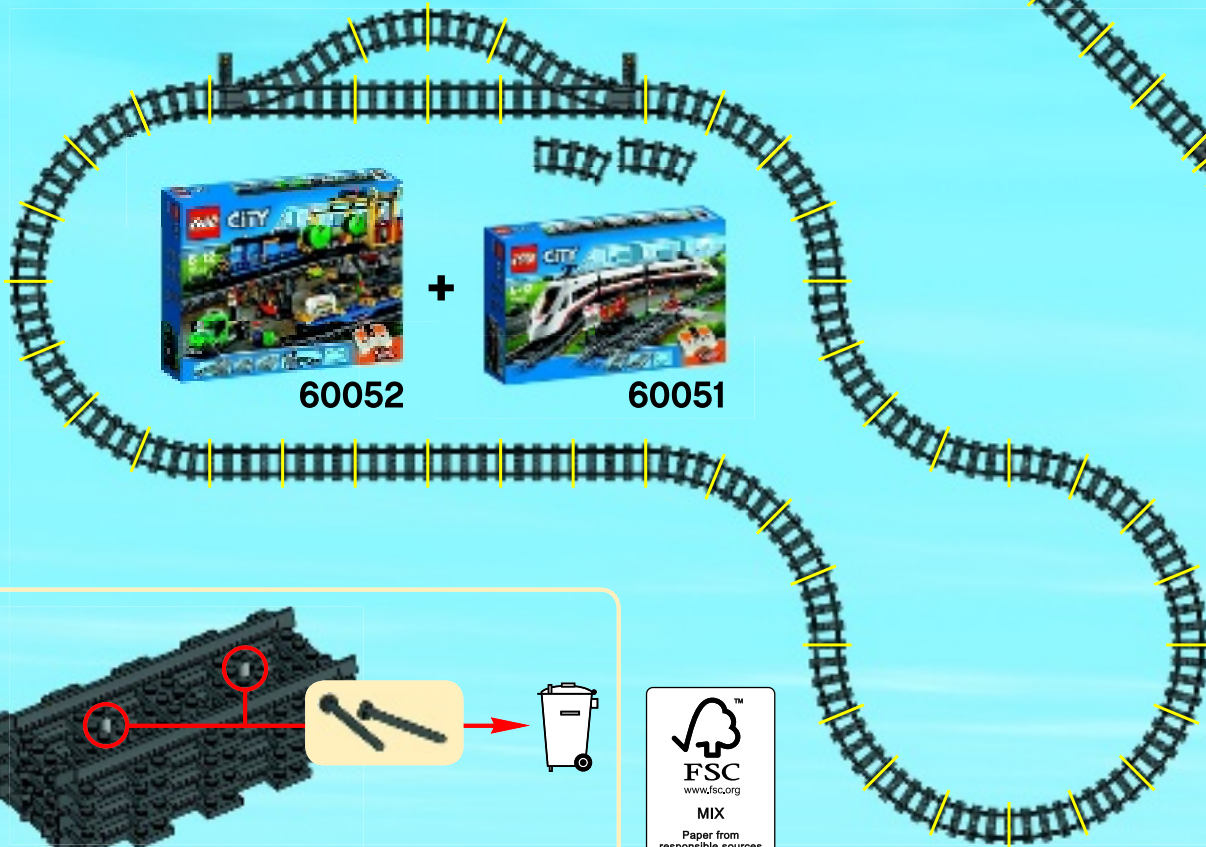



CITY

60052



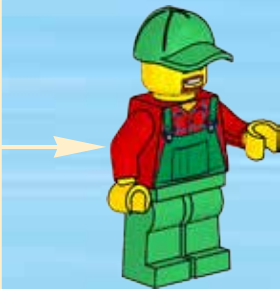
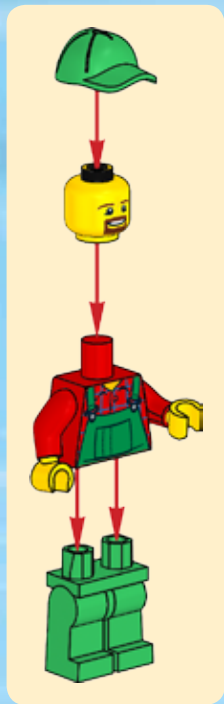
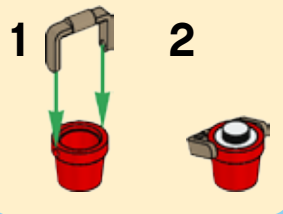
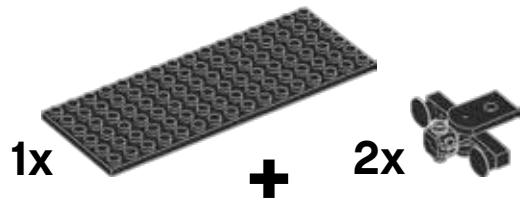

1



2



3

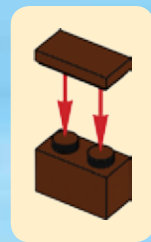

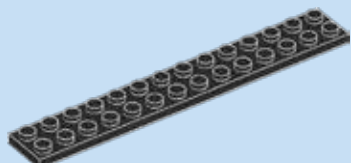

1x

1

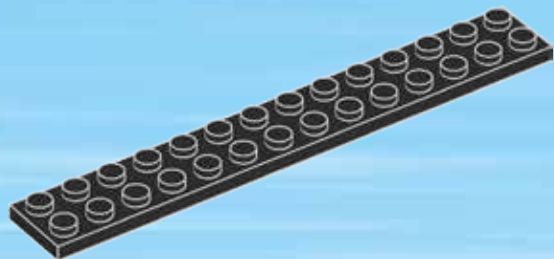



5x

2

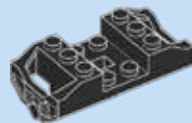
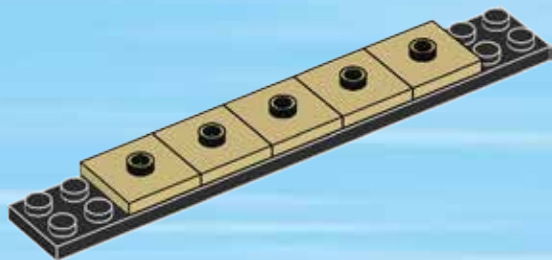

2x

3

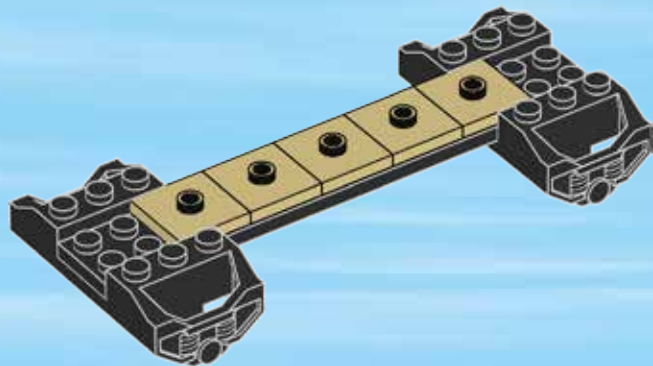

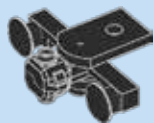

2x

4

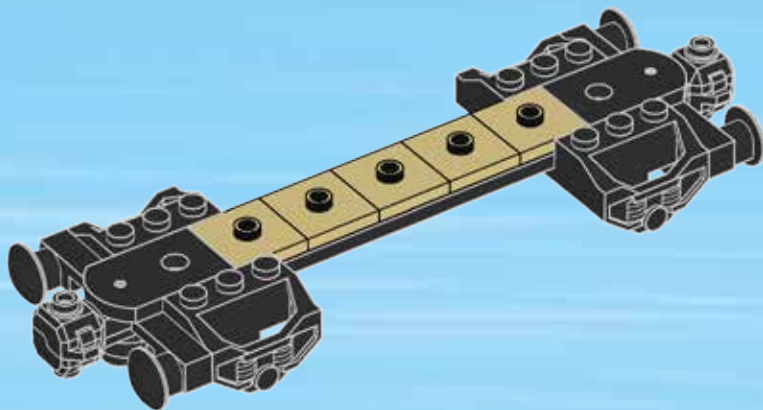

6

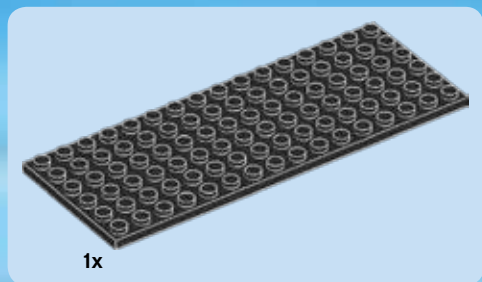

5

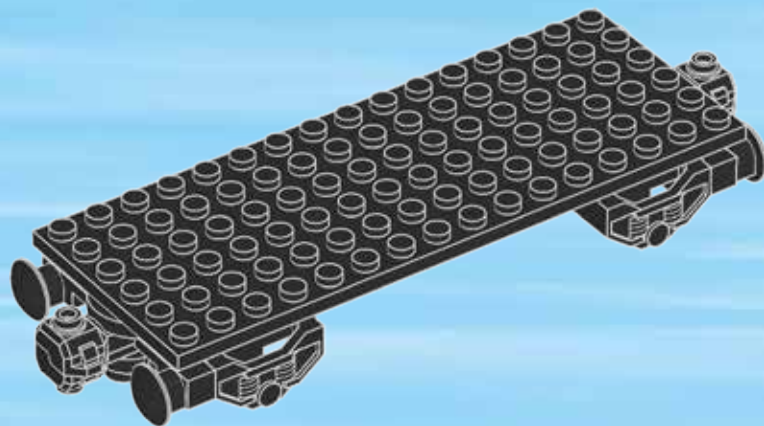



10x

6

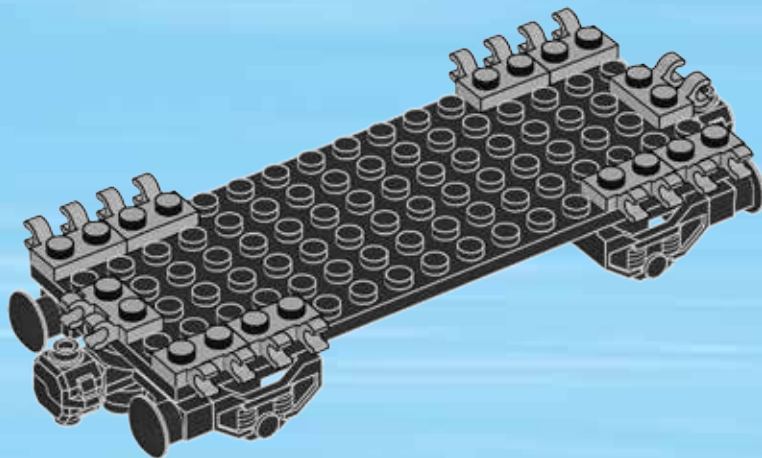

8



3x

7

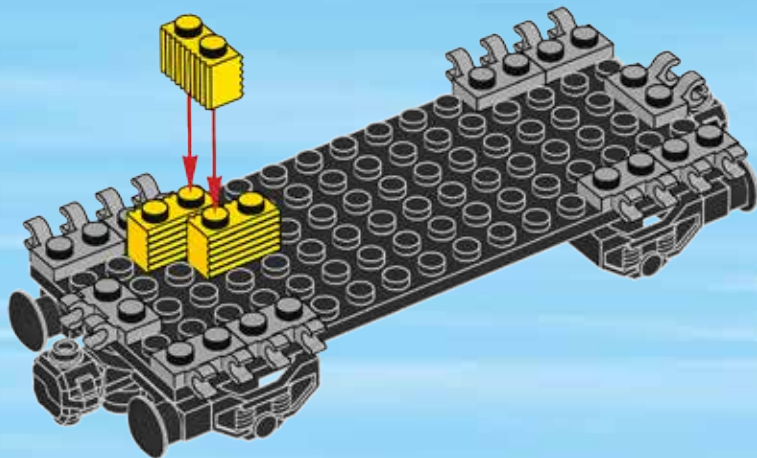

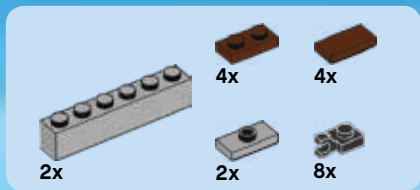

8

1

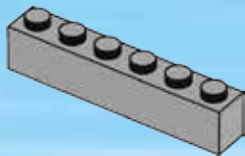

2

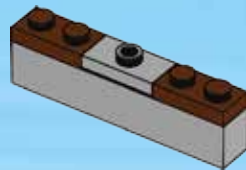

3

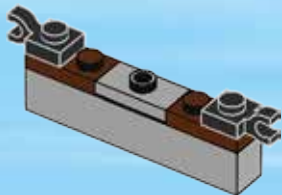

4

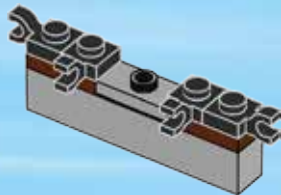

5

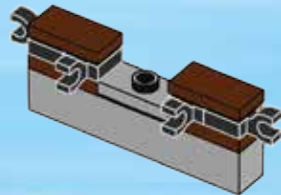

2x

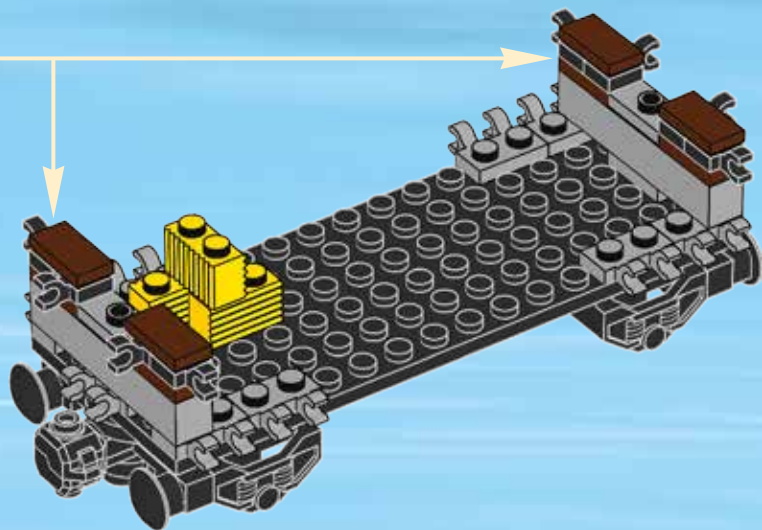



4x

9

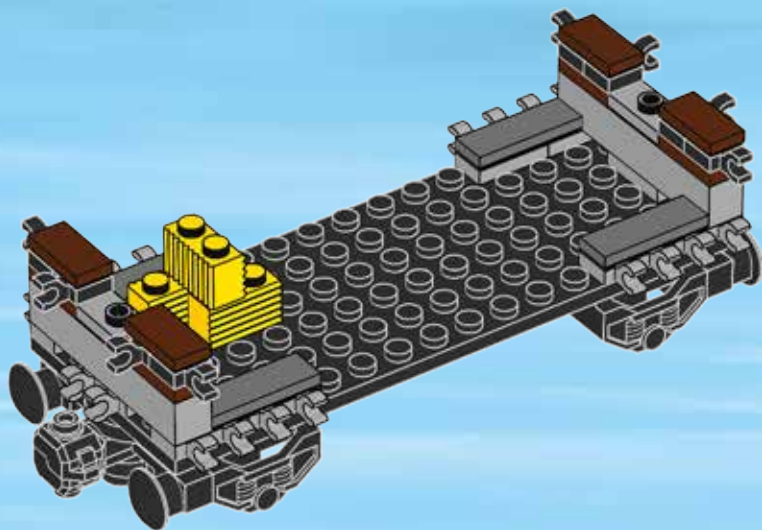



2x



2x

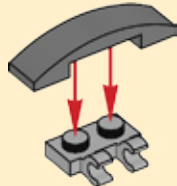

2x

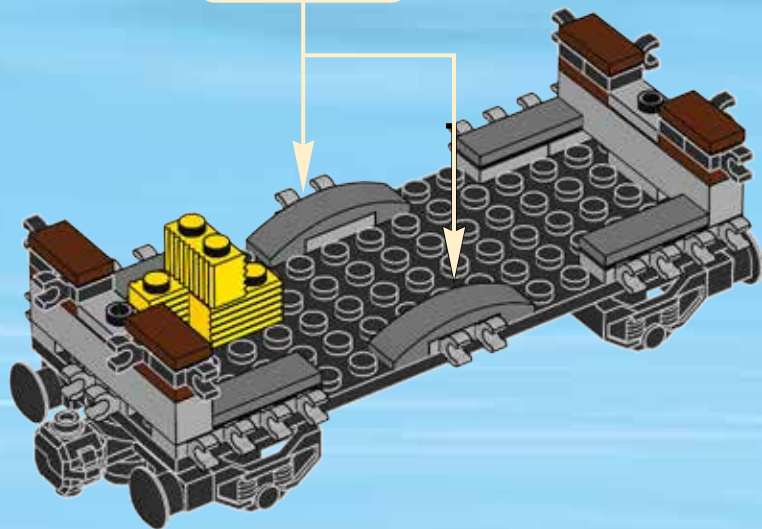

10

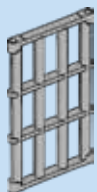

2x

11

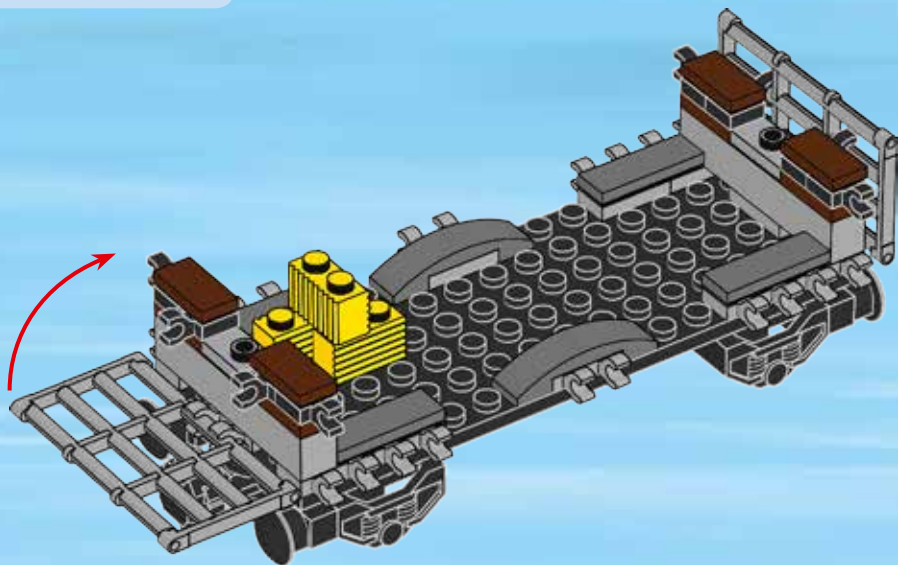

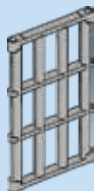

4x

12

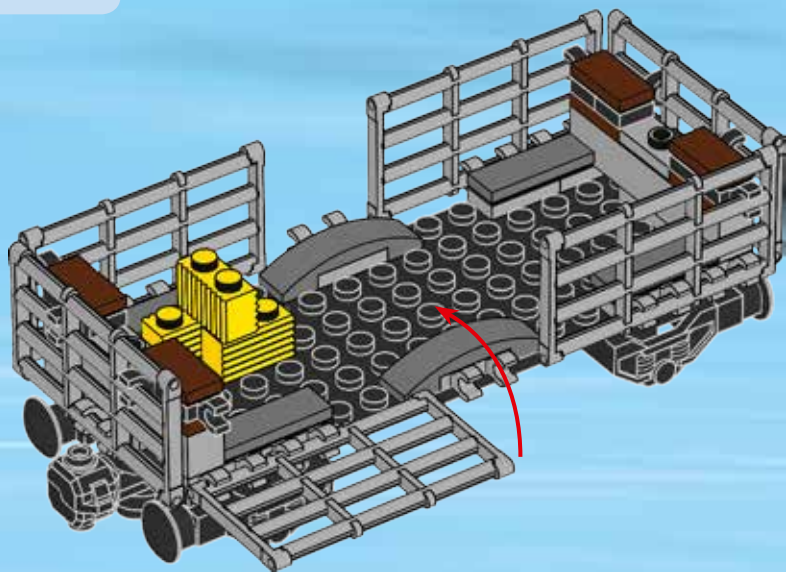

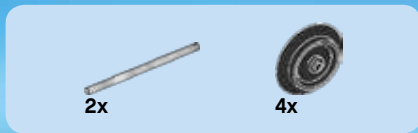

13

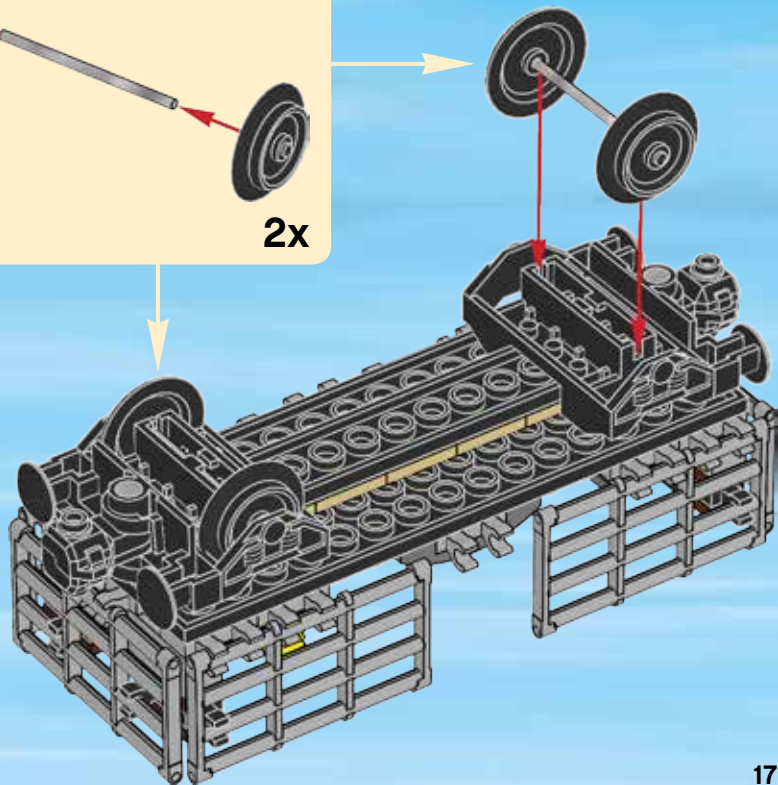
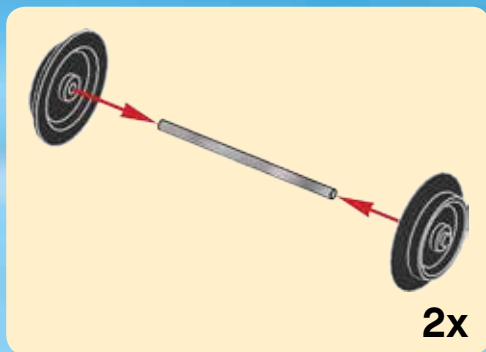



1x



2x



14

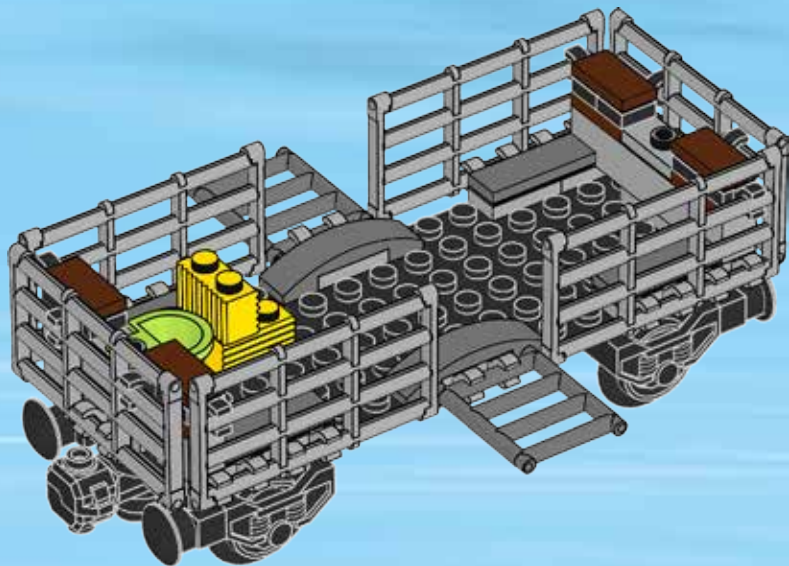

15



LEGO CITY



60110



60109



60108



60107



60106



60105

LEGO and the LEGO logo are trademarks of the LEGO Group. ©2014, 2016 The LEGO Group. 6158134

 LEGO.com/city



CITY

60052



2x



1x



+

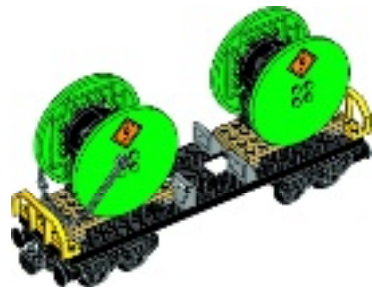

1

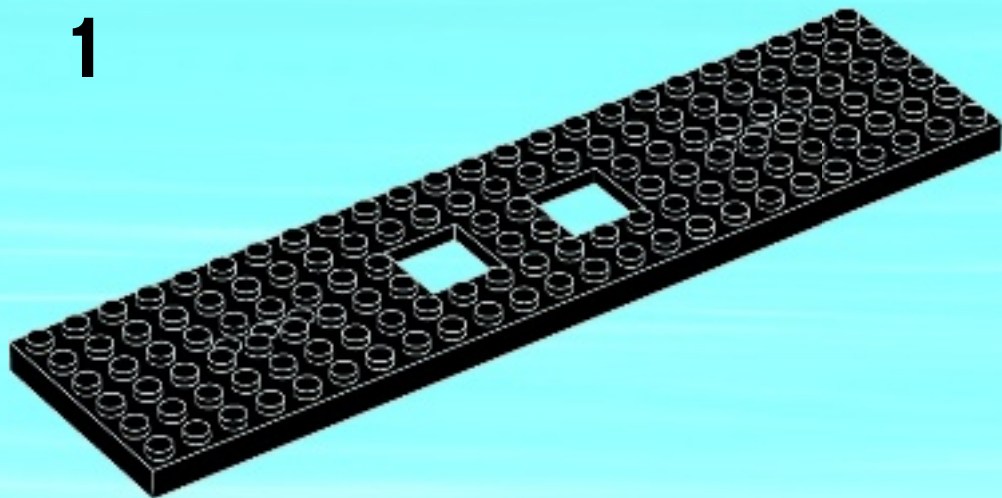

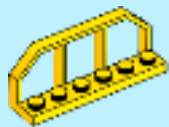

2x

2

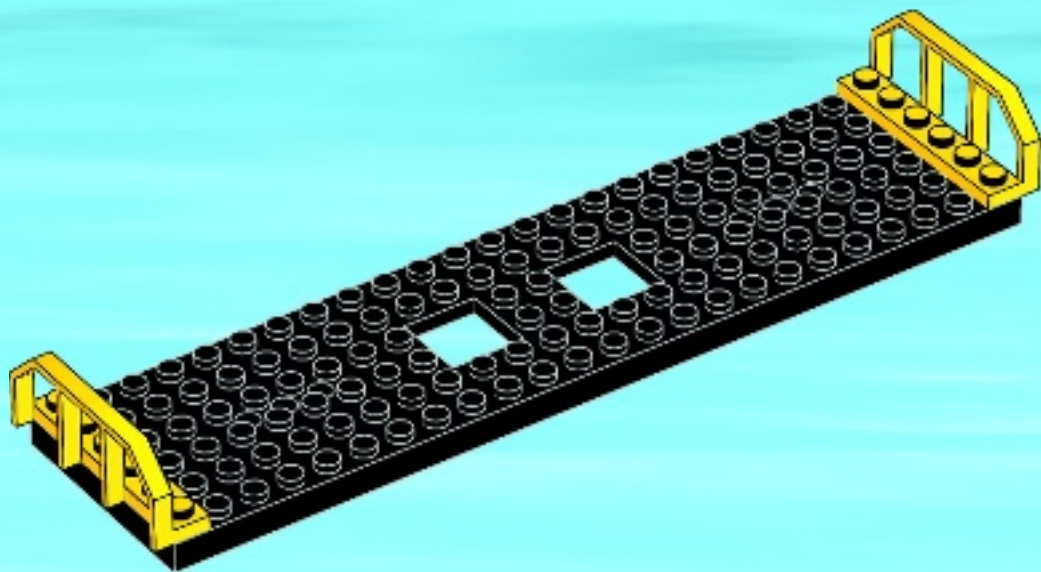



4x

3

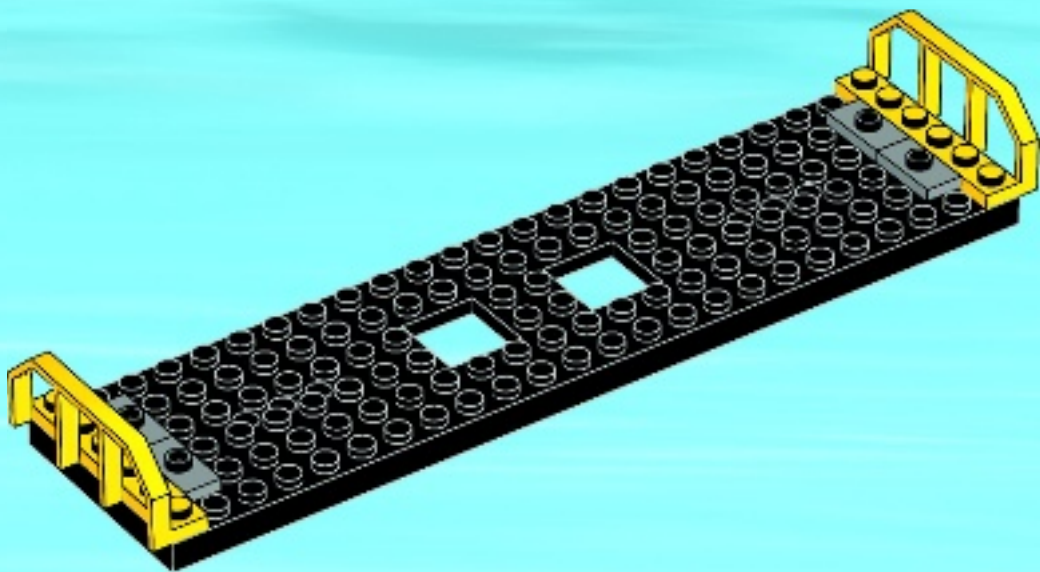

4



4x

4

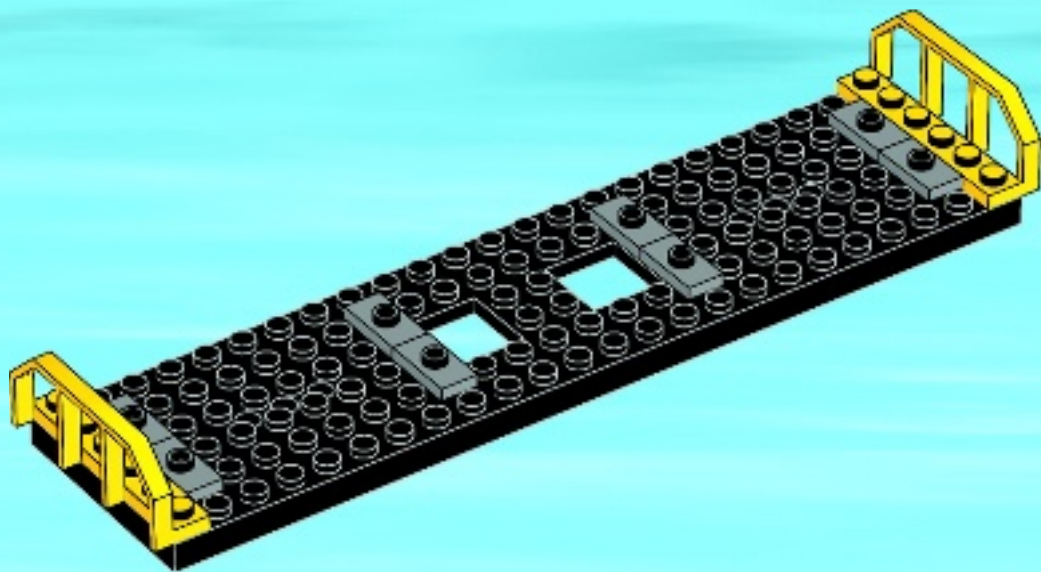



4x

5

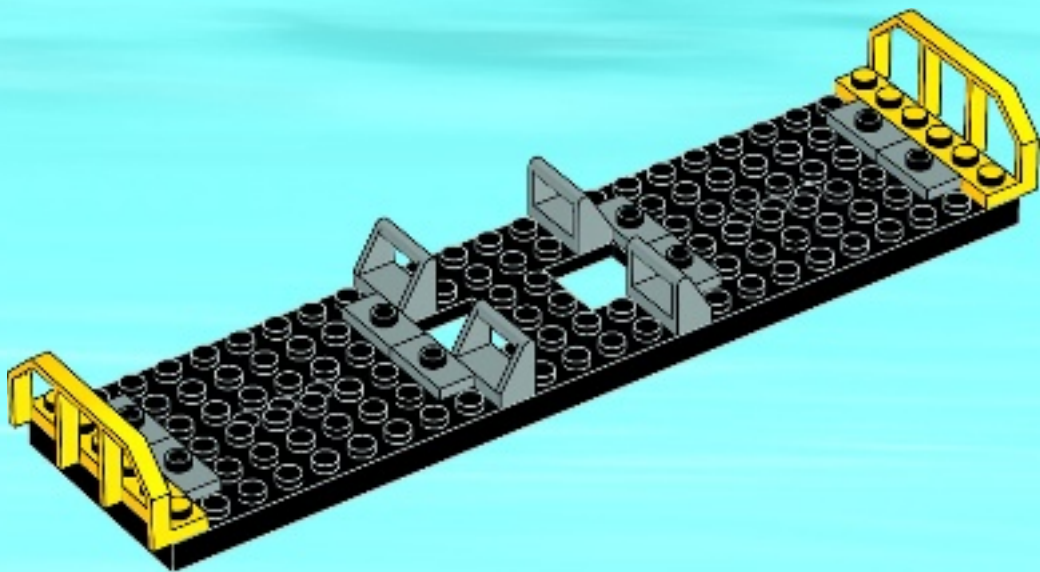

6



4x

6

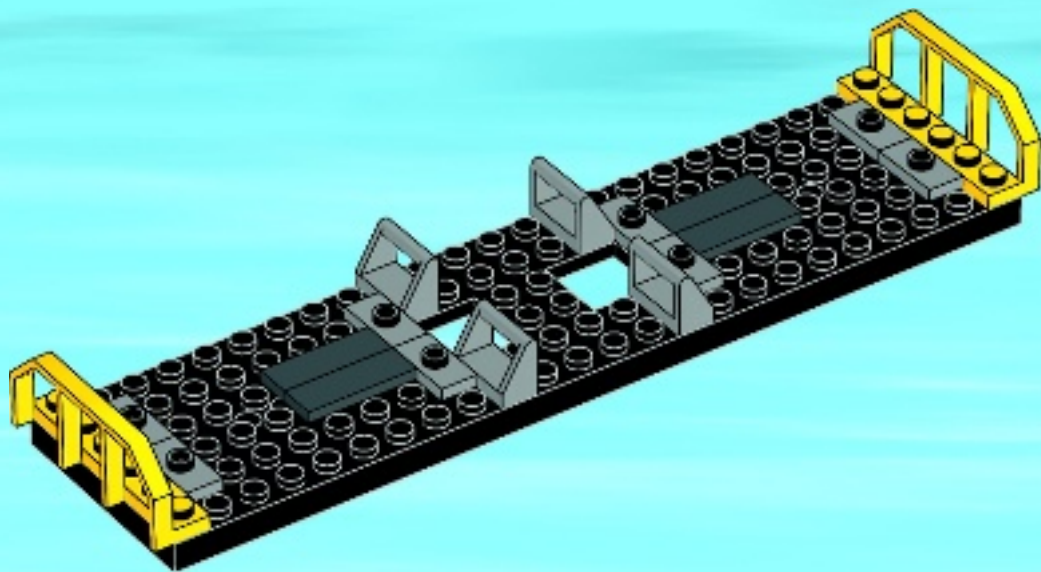

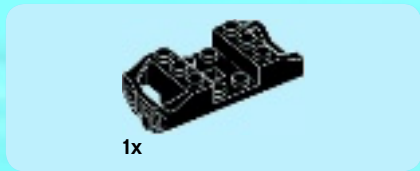
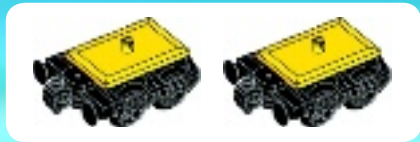

1x

1

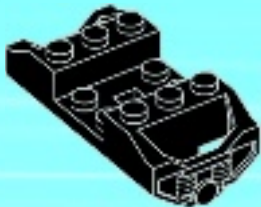

1x

2

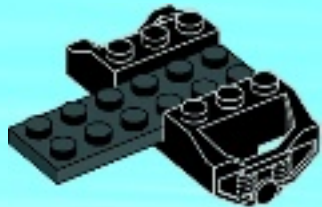



1x

3



1x



1x

4





2x



4x

5

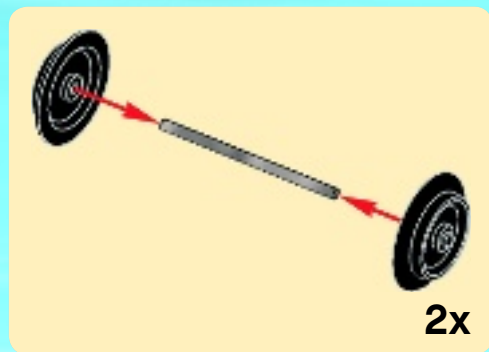

2x

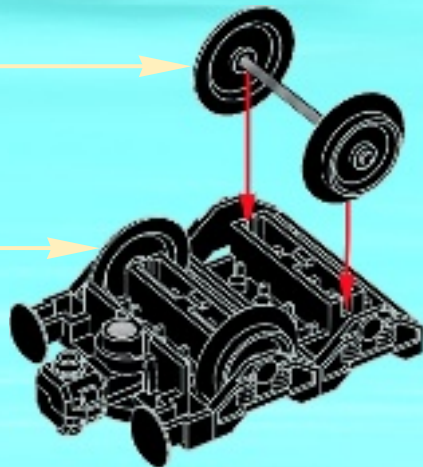

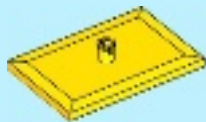

1x

6



2x

7

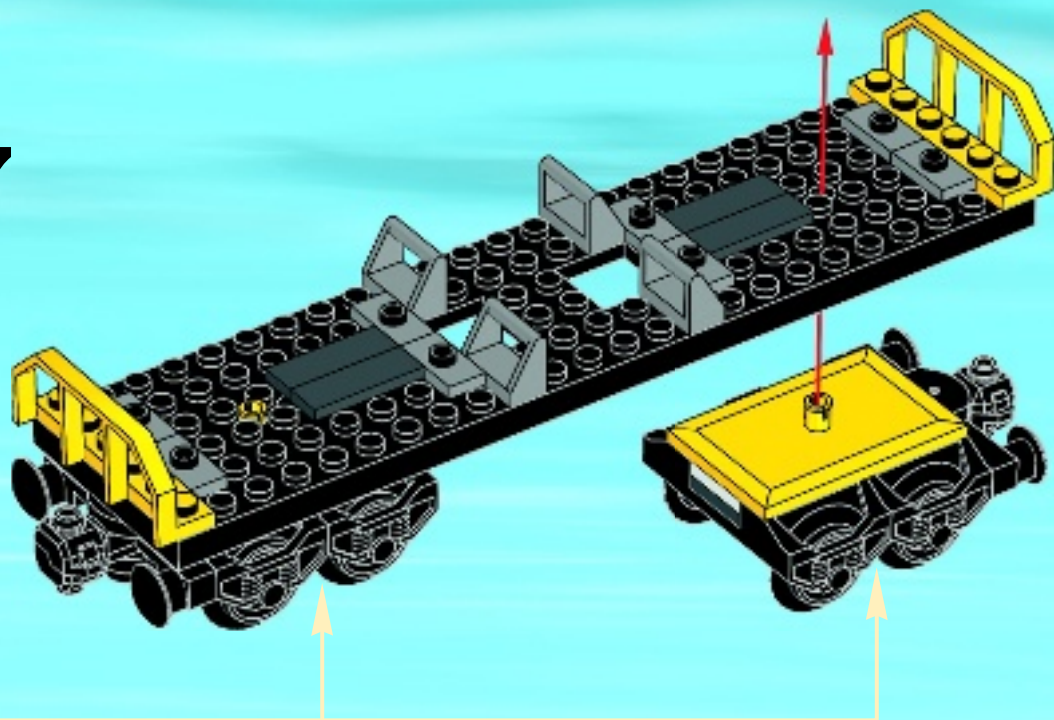

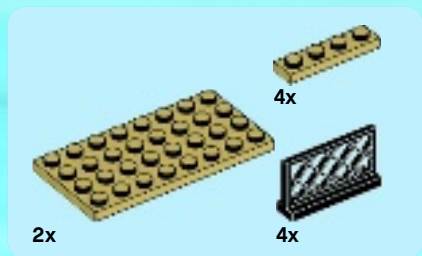

8

1

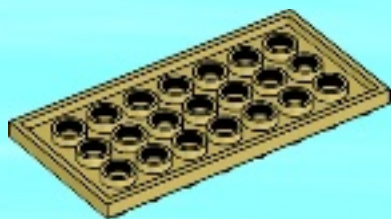

2

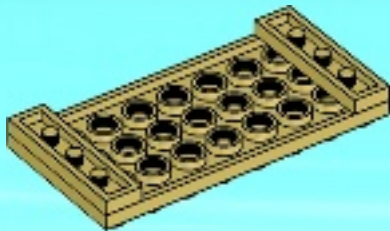

3

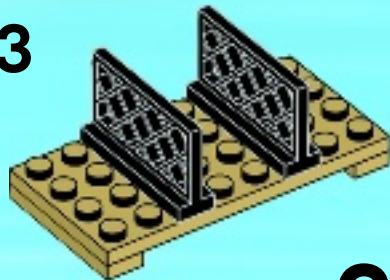

2x

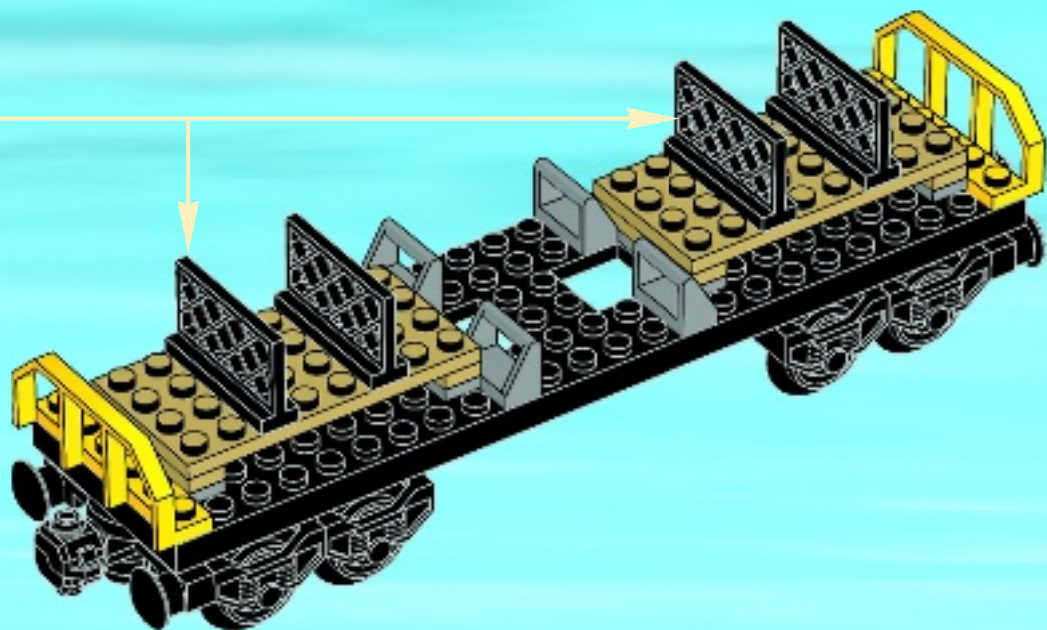



1

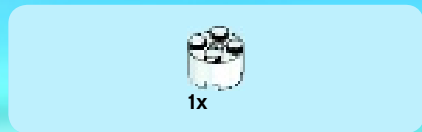

2





2x

3



2x

4





1x

5



1x

6





1x

7

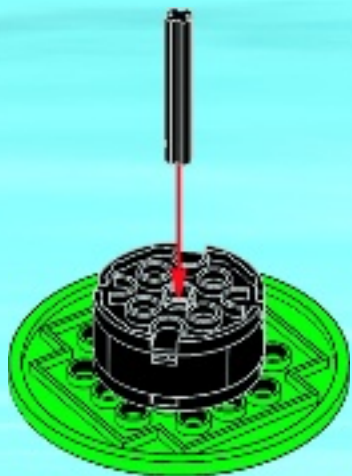

8

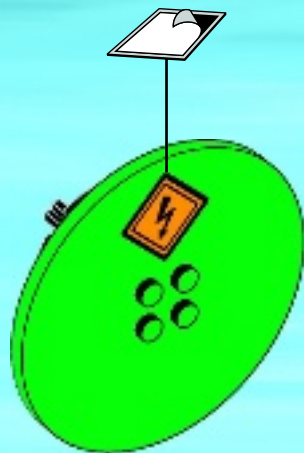

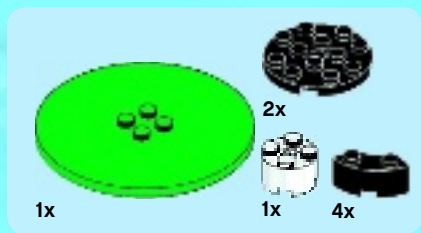
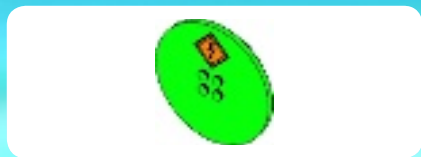

9

1



2



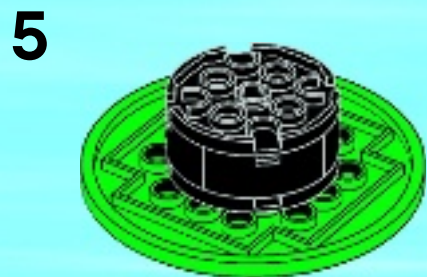
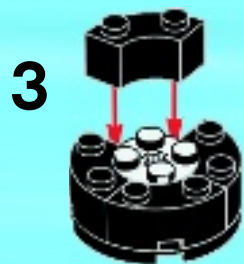



6

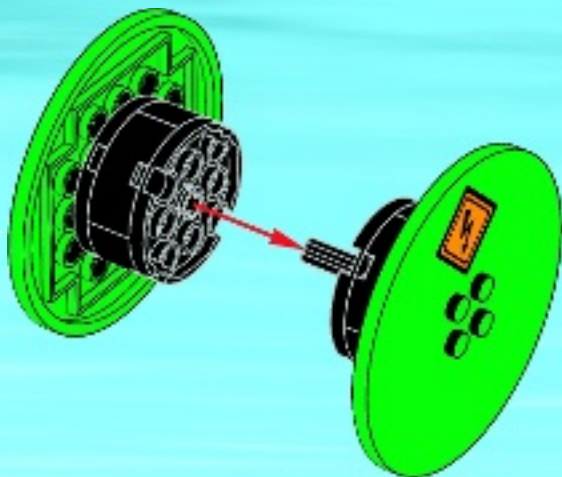
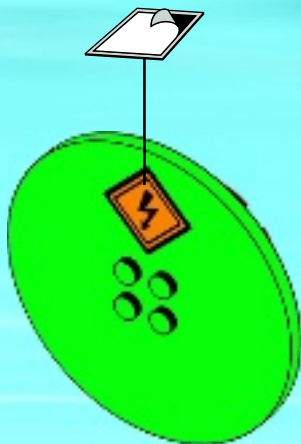

2x

9

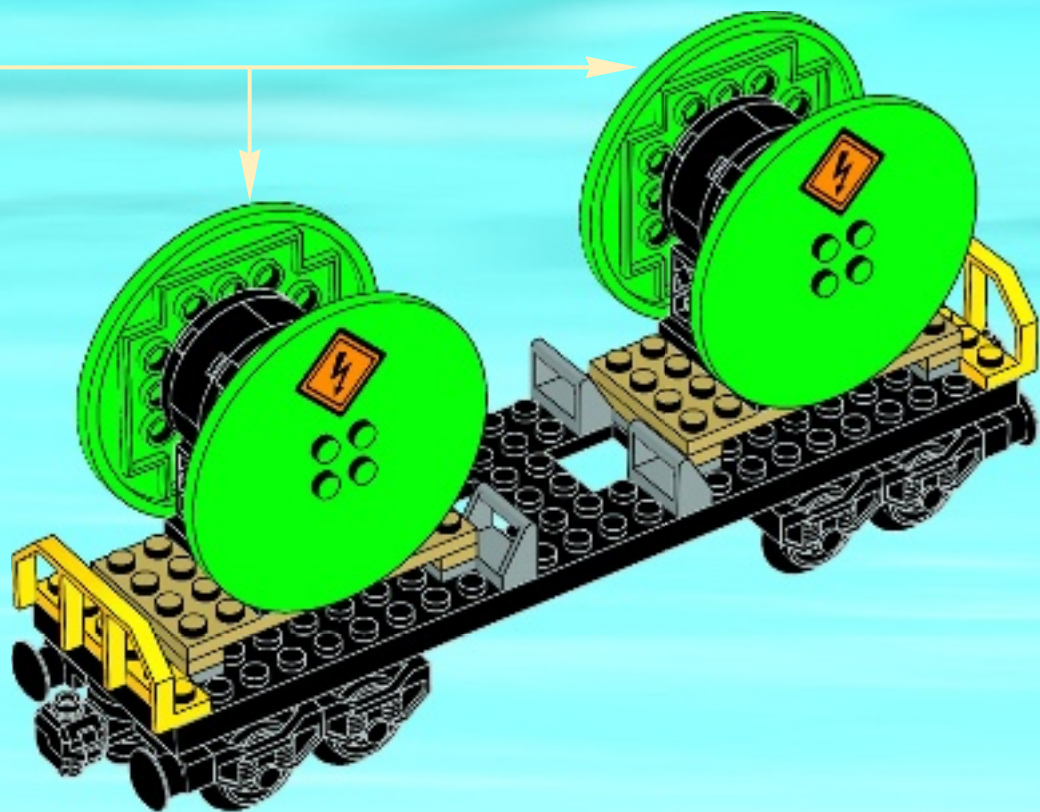



10

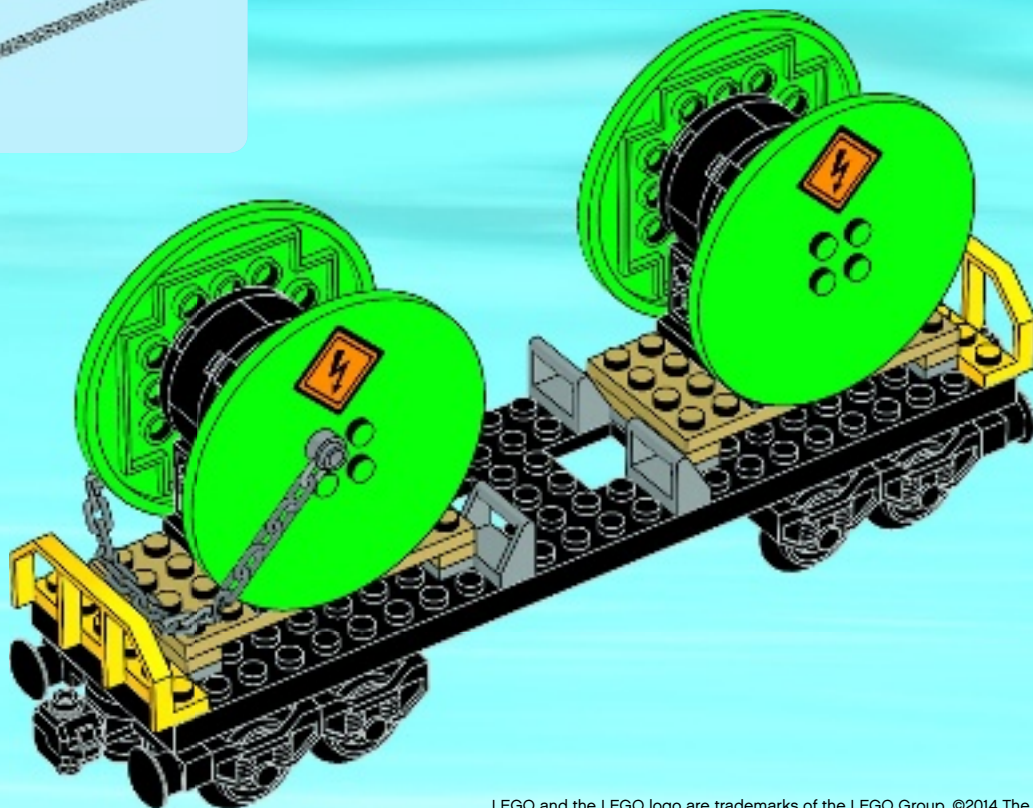





CITY

60052

5



1x  + 2x 

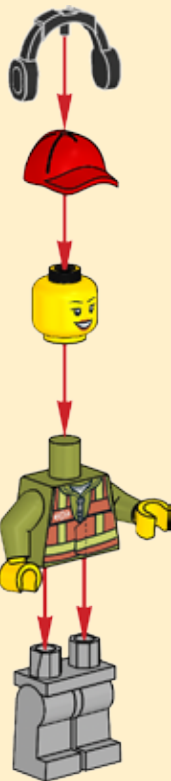
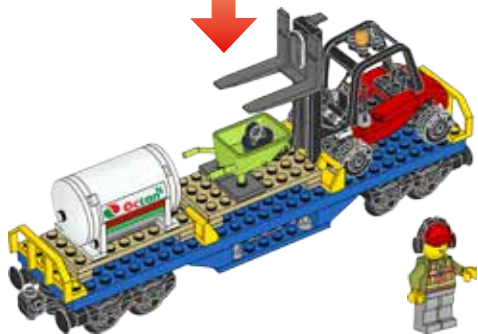



1x

1



2x

2

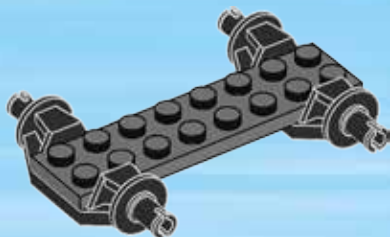

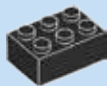

1x

3

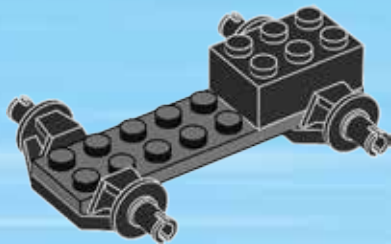

4



2x



1x

4

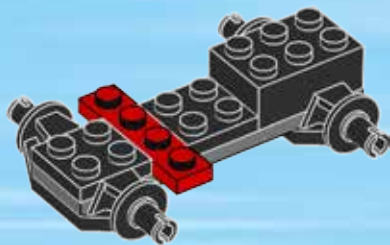

1x



1x



2x

5

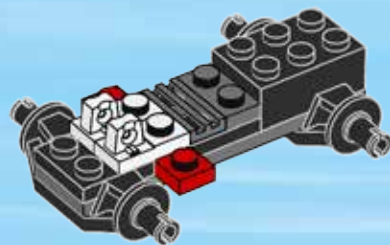



1x

6

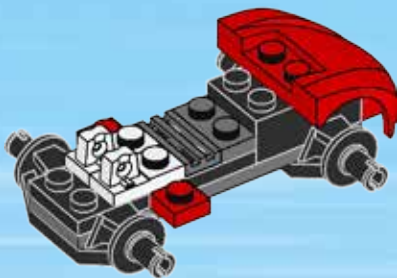



2x

7

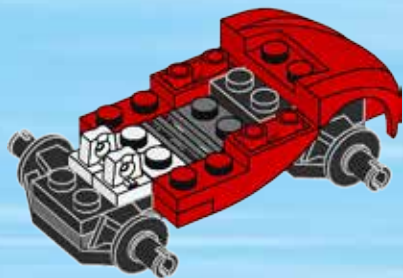

2x

8

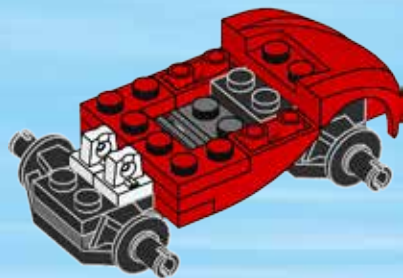



1x

9

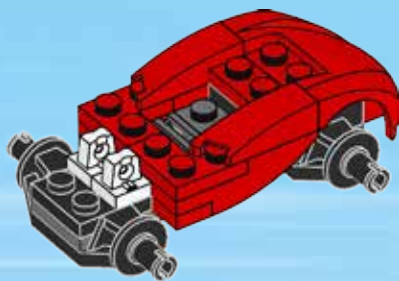

8



1x



2x

10

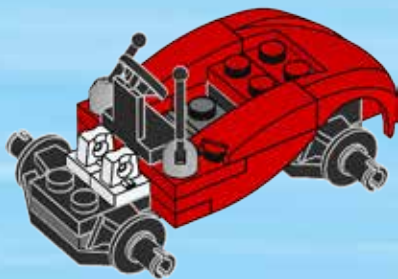

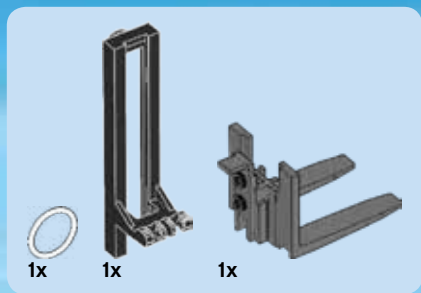

11

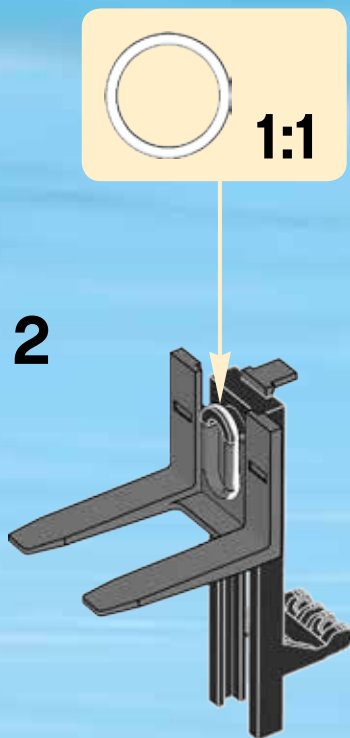
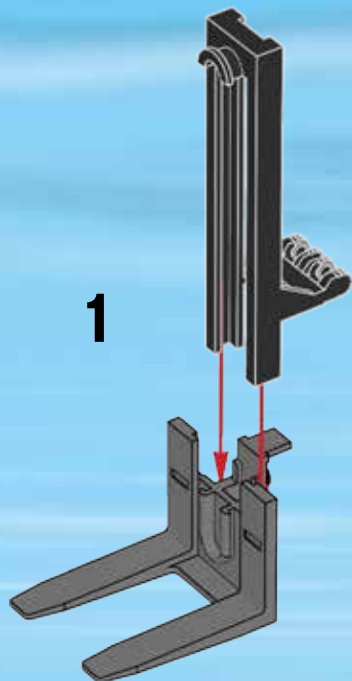



2x

12

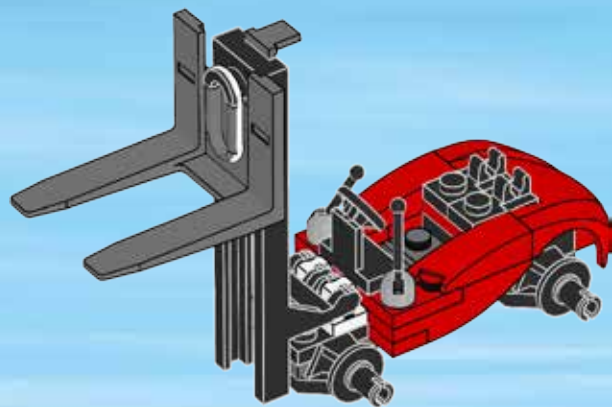
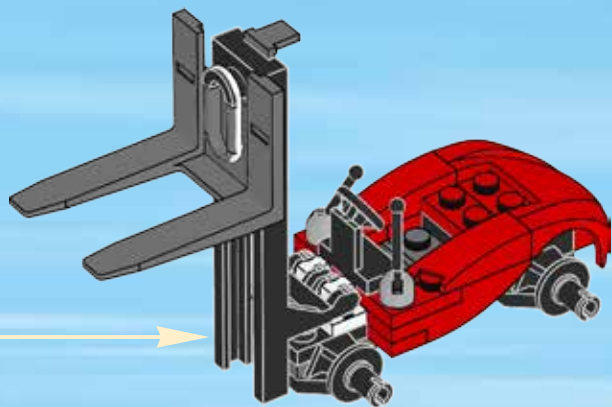

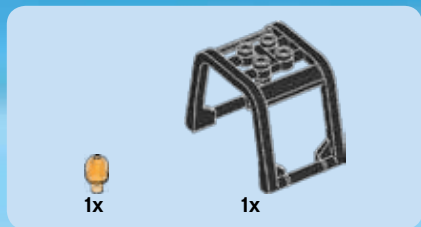

13

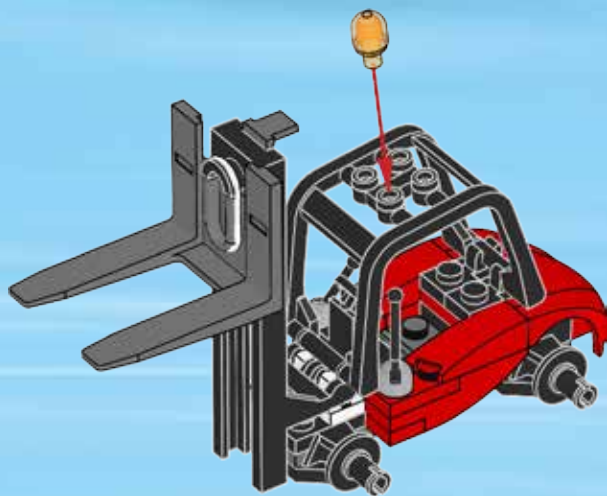



4x



4x

14



4x

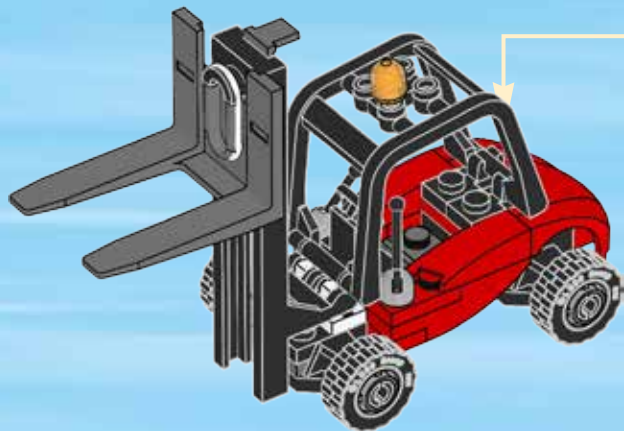

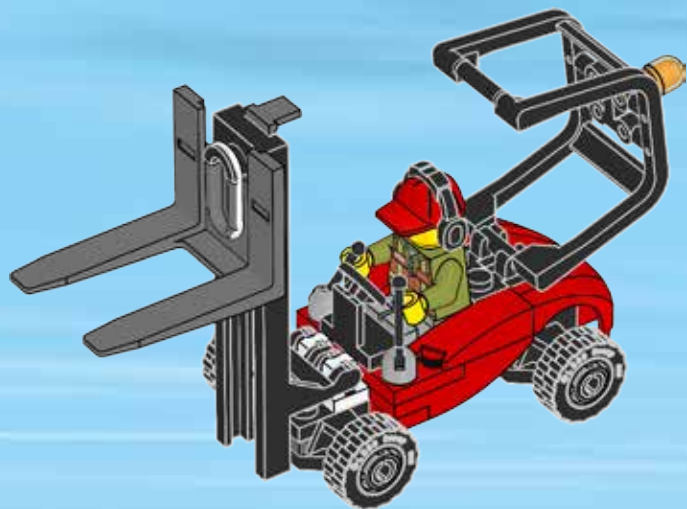

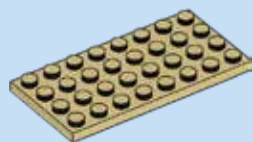

1x

1



2x

2





2x

3

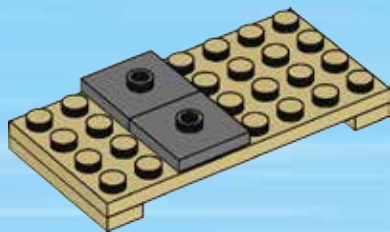

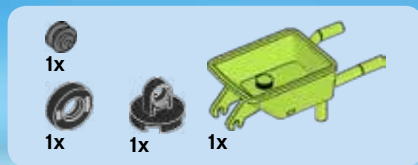

4

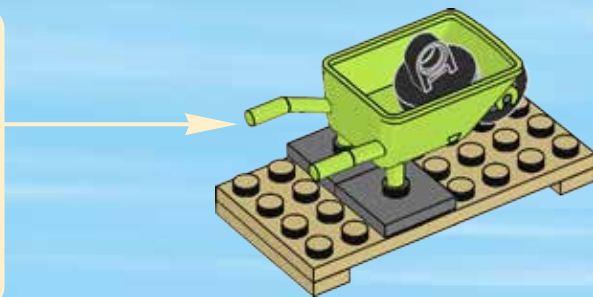
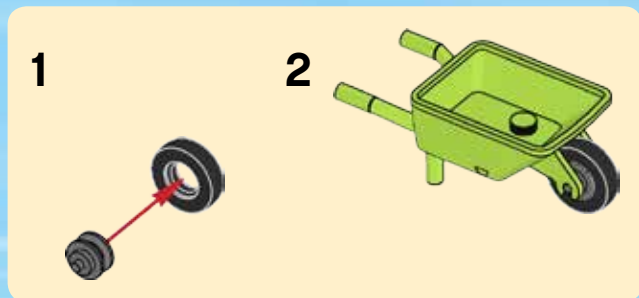

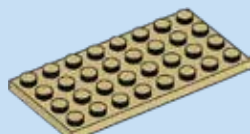

1x

1





2x

2



2x



2x

3

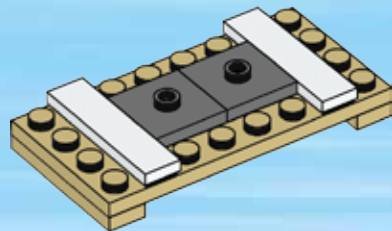



1x

4

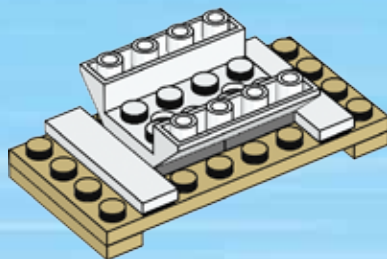



2x



2x

5

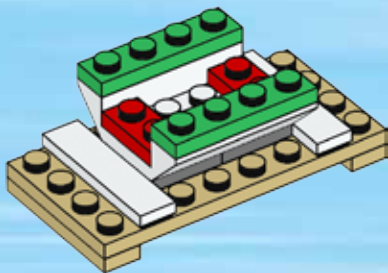

2x

6

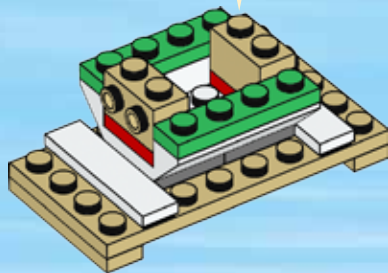
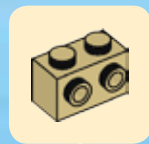



2x

7

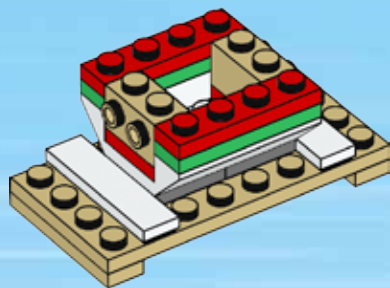

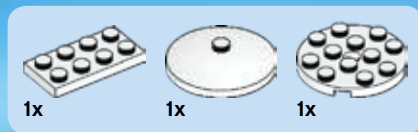

8

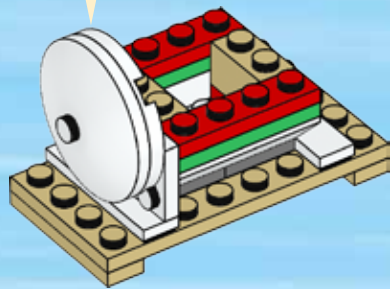

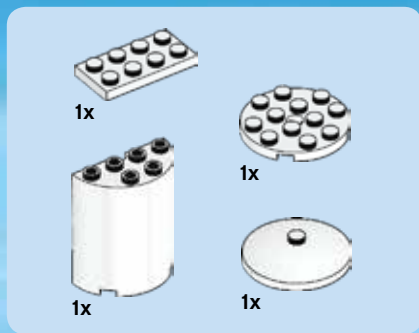

9

1



2



3





4

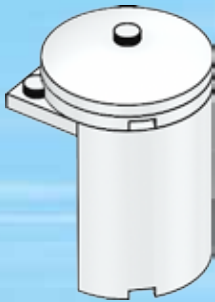

5

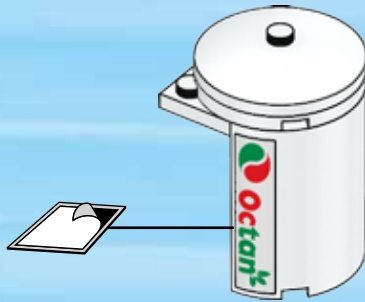

6



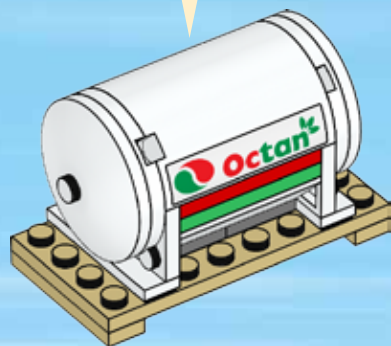

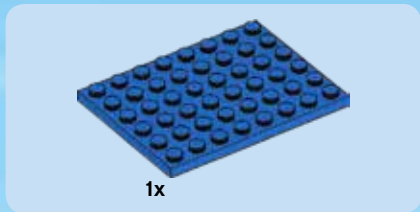
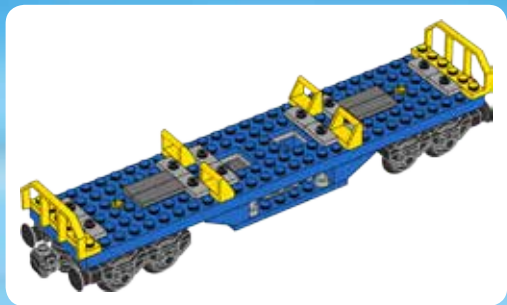

1x



1

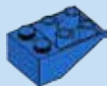

4x

2

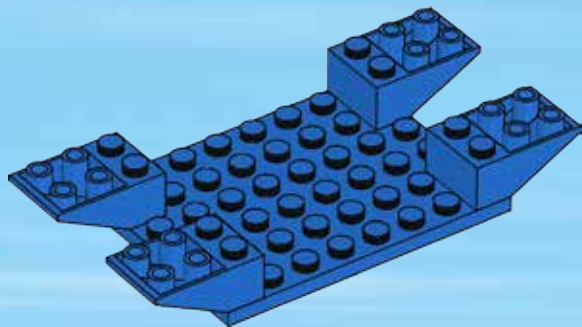

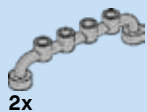

2x

3

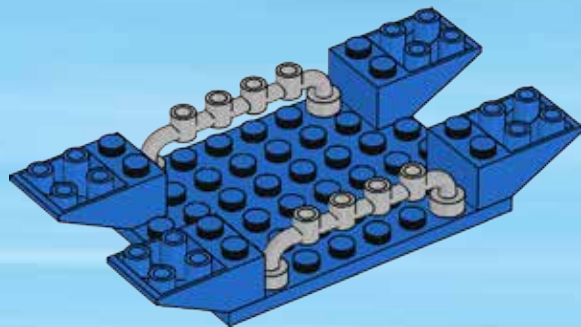



1x

4

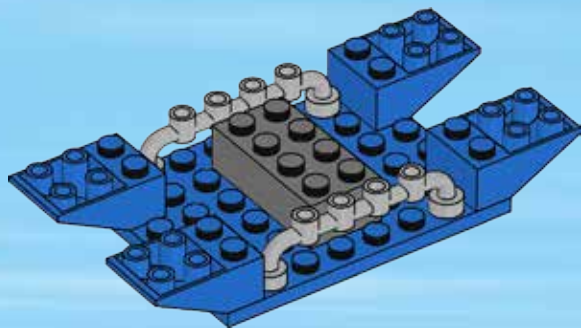

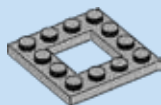

2x

5

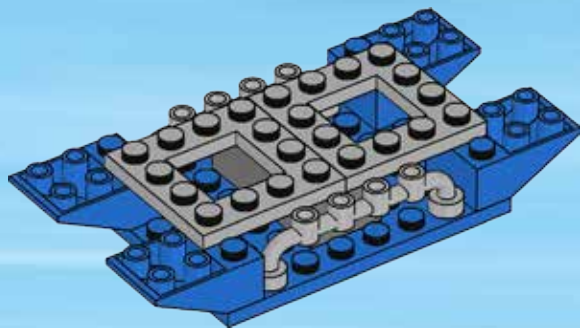

6

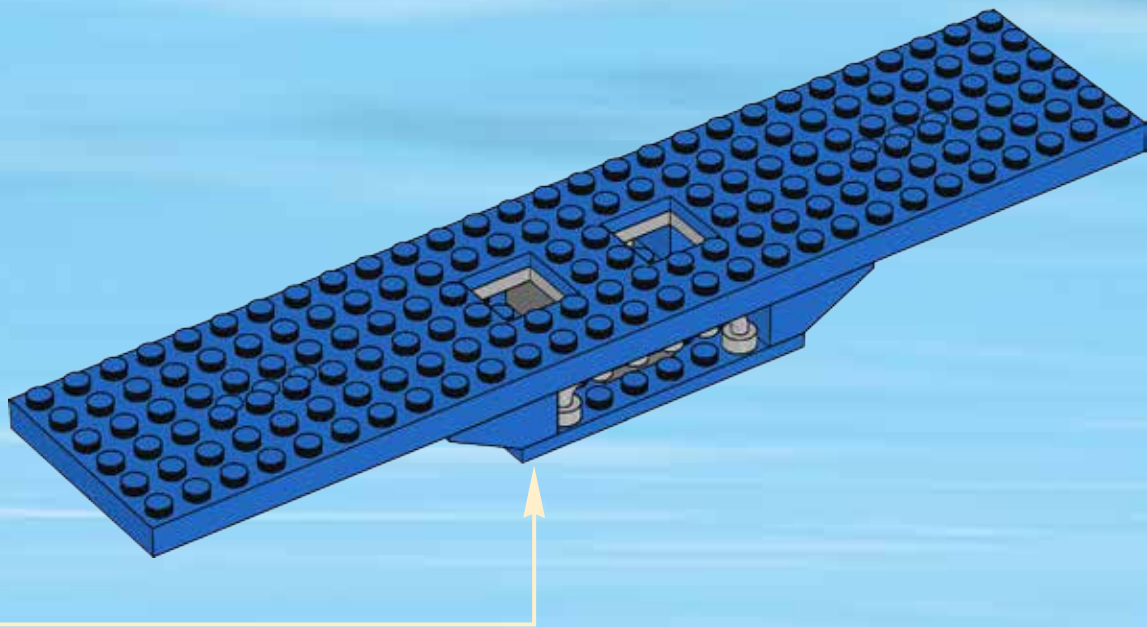



4x

7

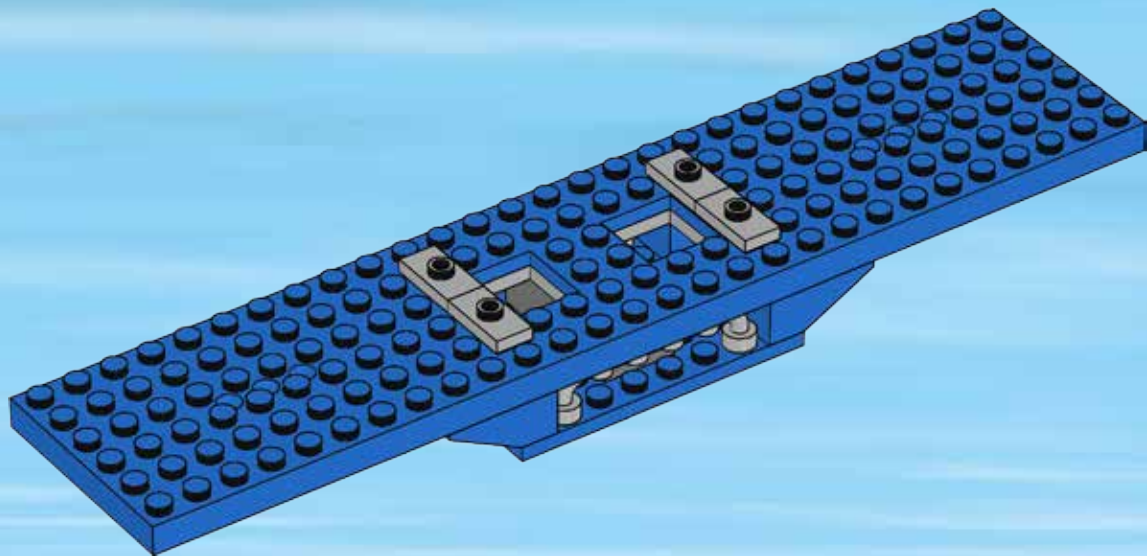



4x

8

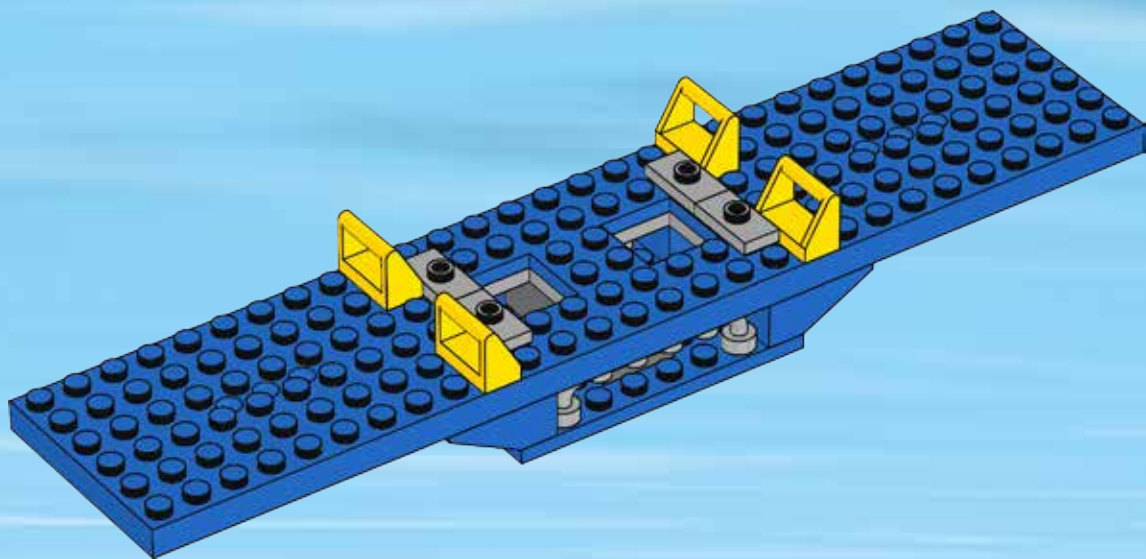



4x

9

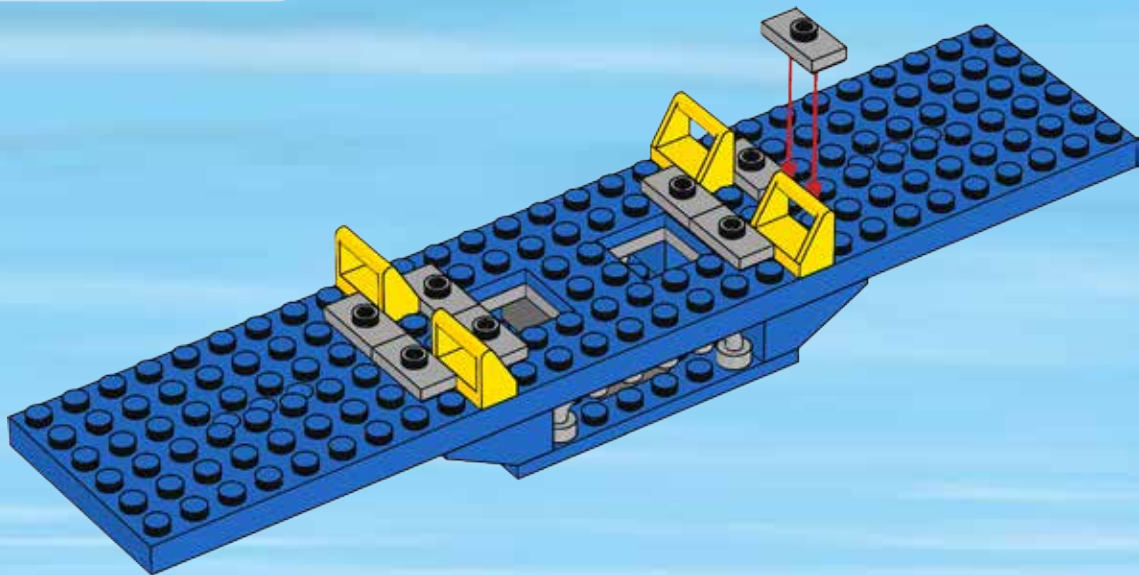



4x

10

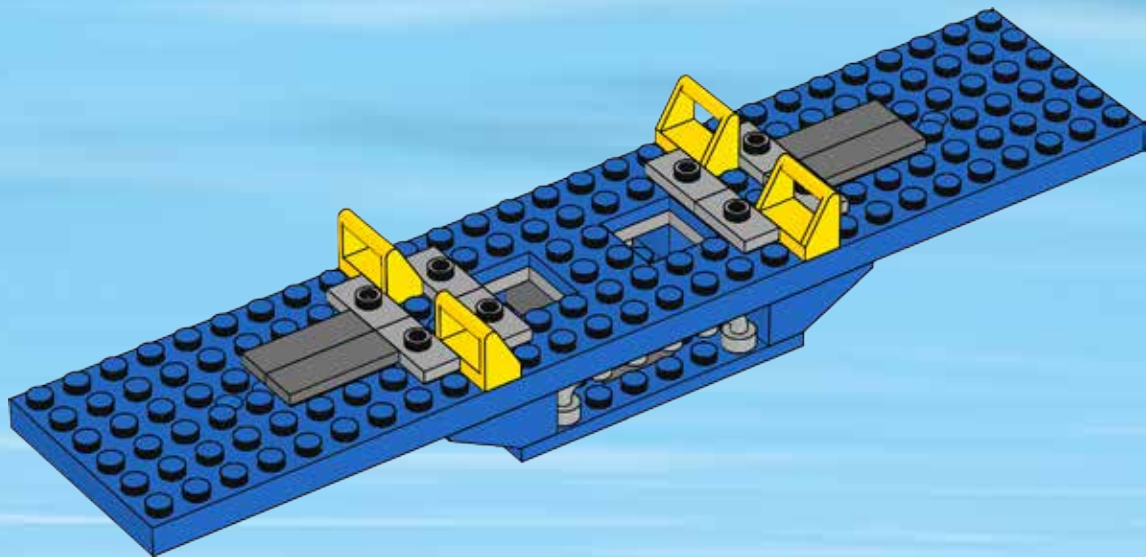

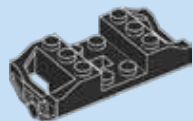
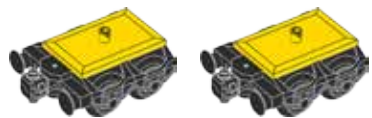

1x

1

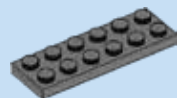
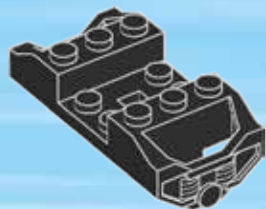

1x

2

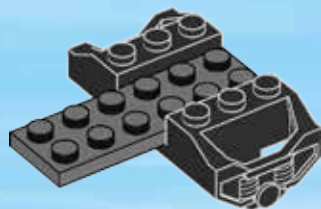

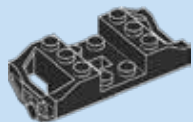

1x

3

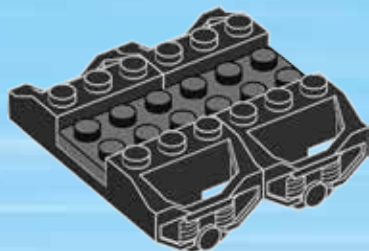

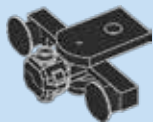

1x



1x

4



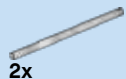

2x



4x

5

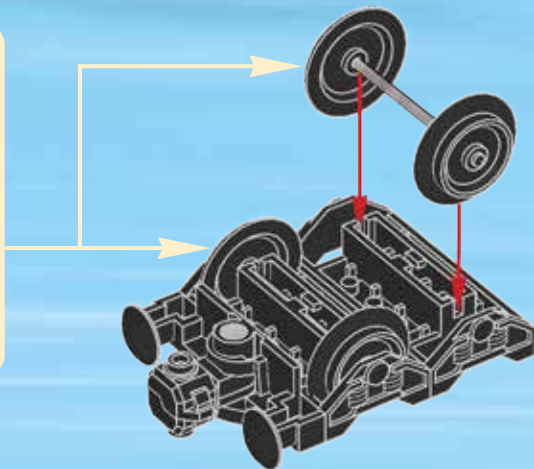
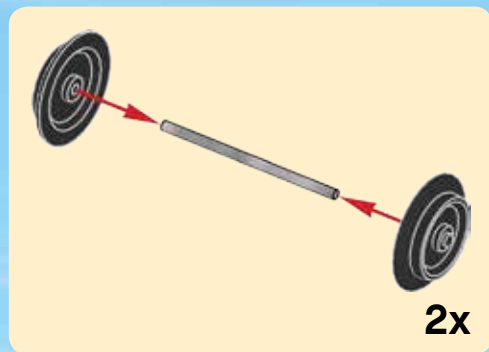



1x

6



2x

11

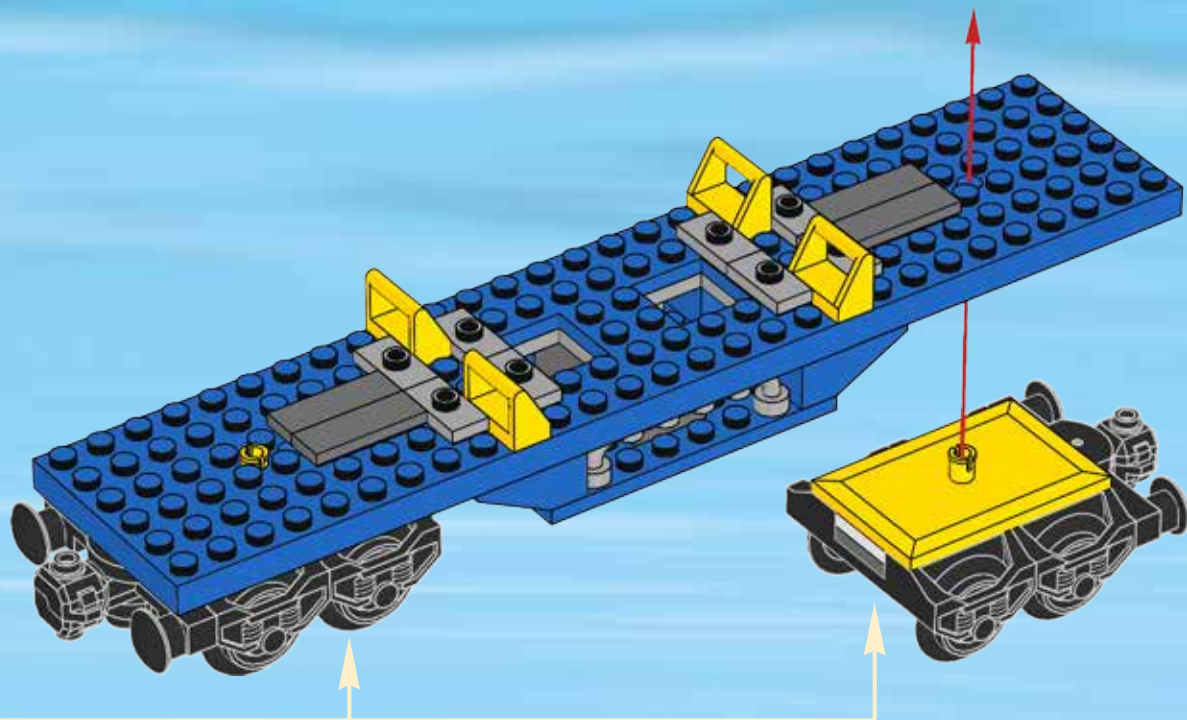



4x

12

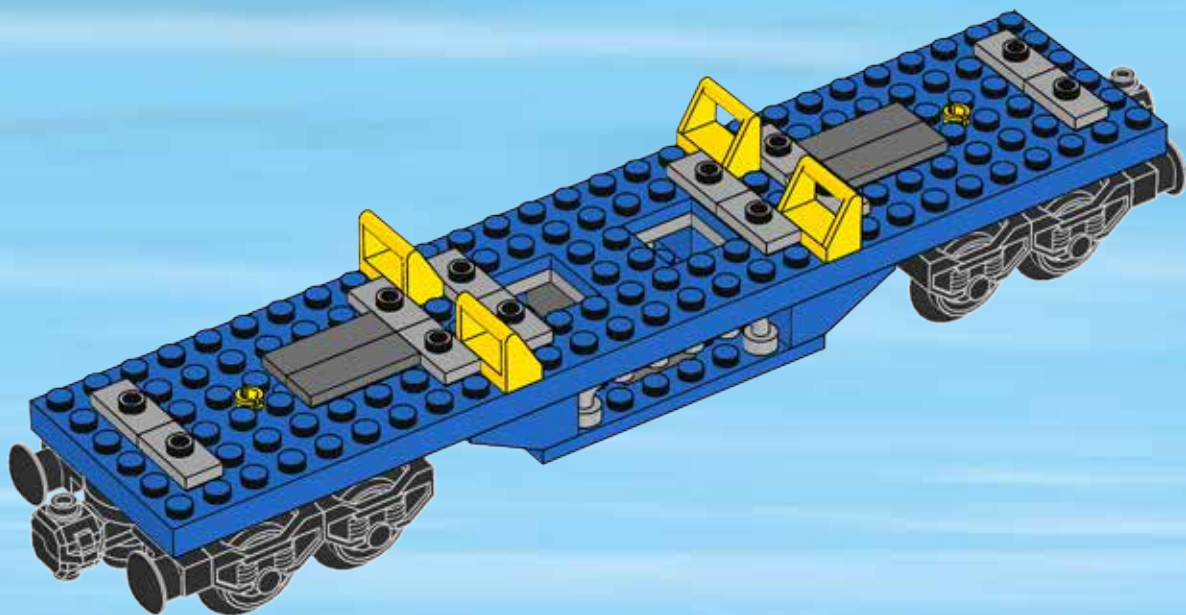



2x

13

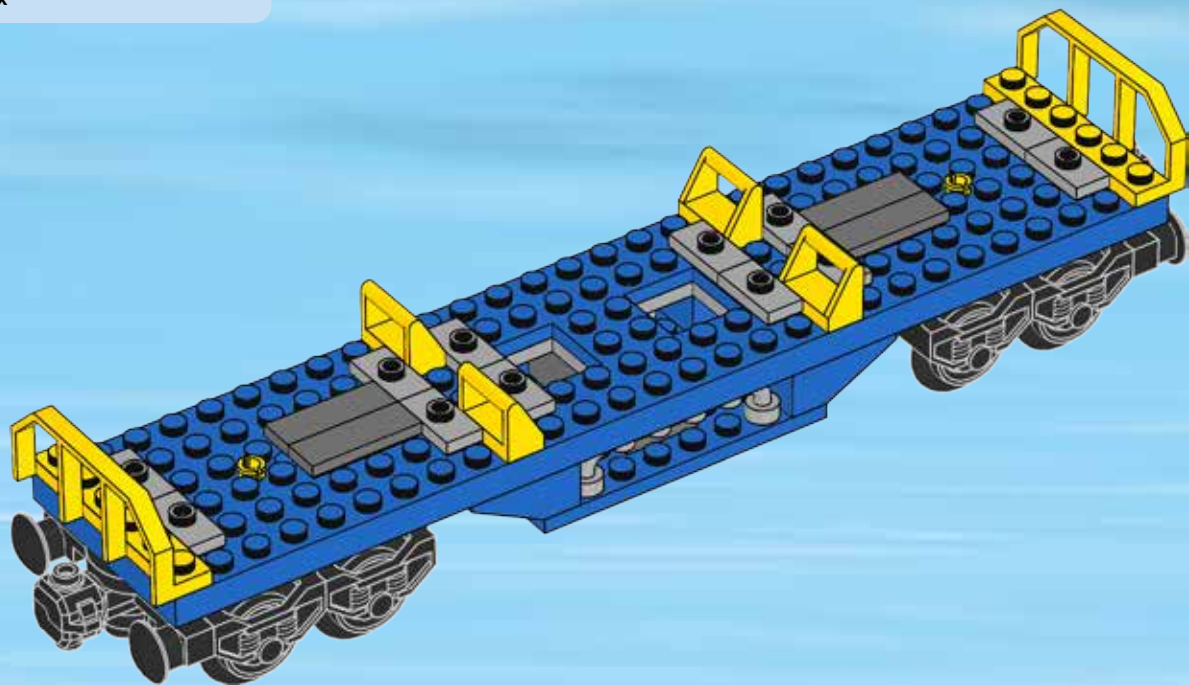







60130



60129



60128



60127



60126



CITY



60051



60052



60050

LEGO and the LEGO logo are trademarks of the LEGO Group. ©2014, 2016 The LEGO Group. 6158136

LEGO.COM/CITY



CITY

60052



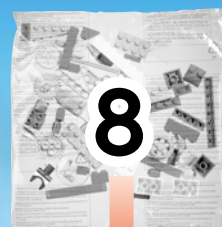
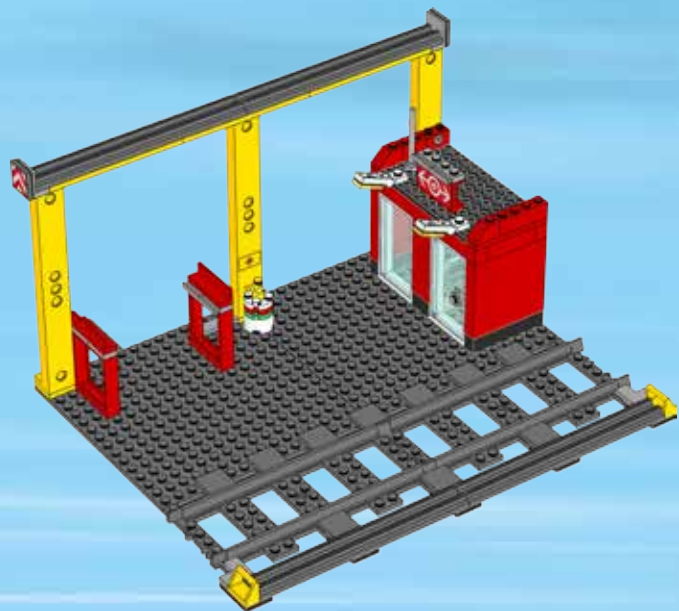

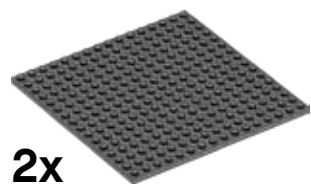

2x



2x



3x

+

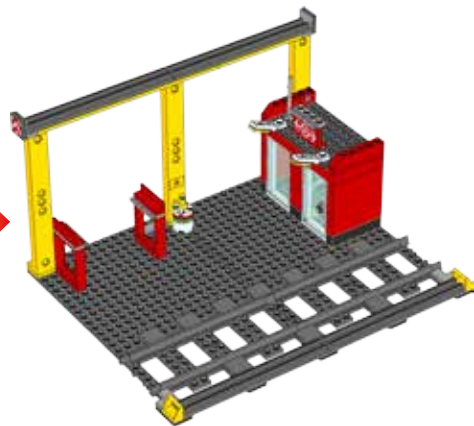

1x

1

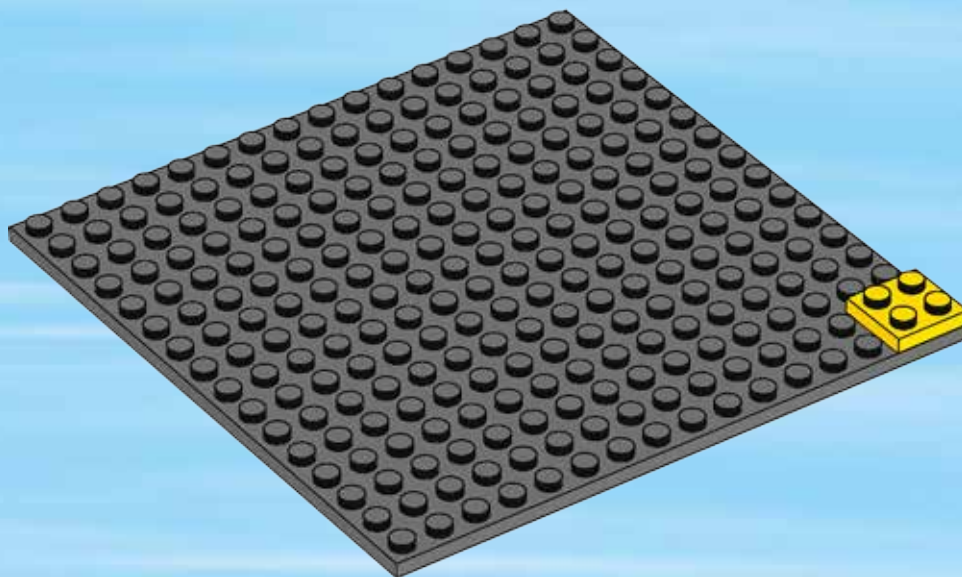

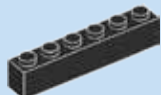

1x

2

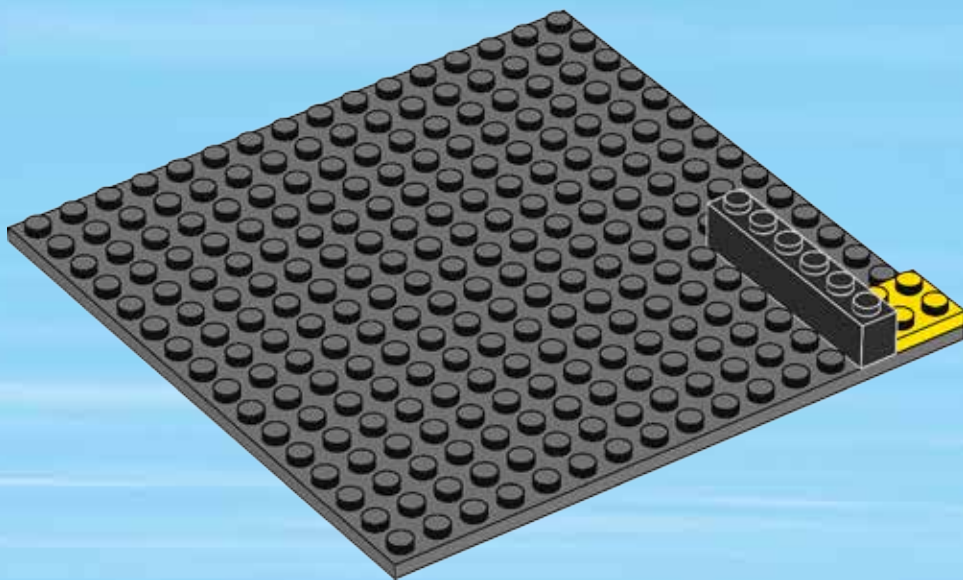

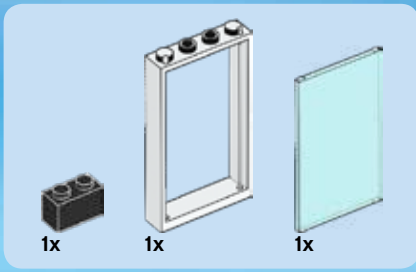

3

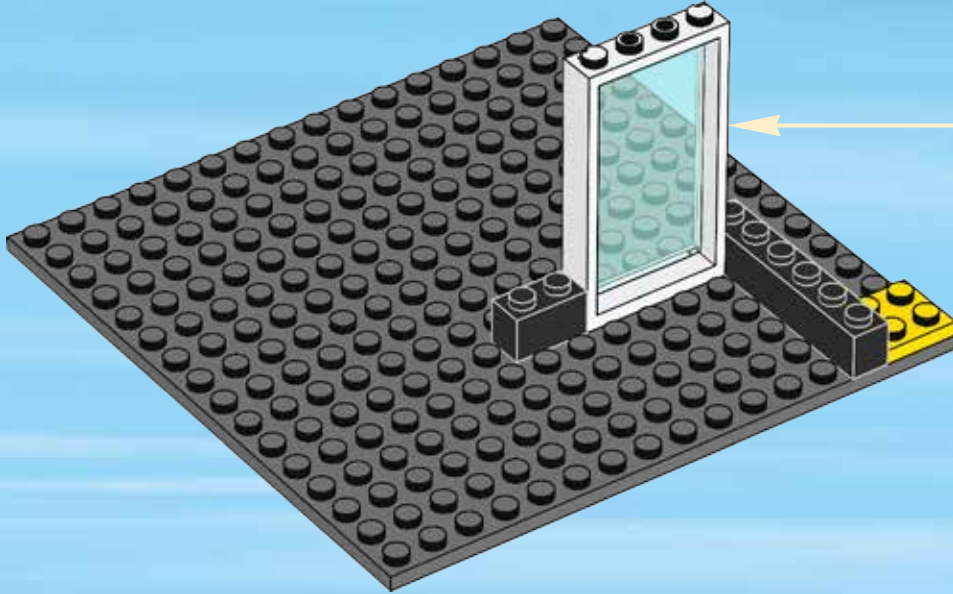
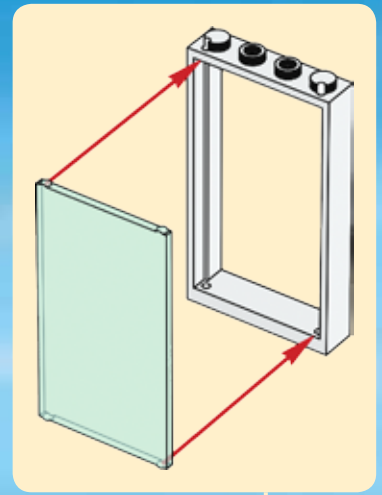

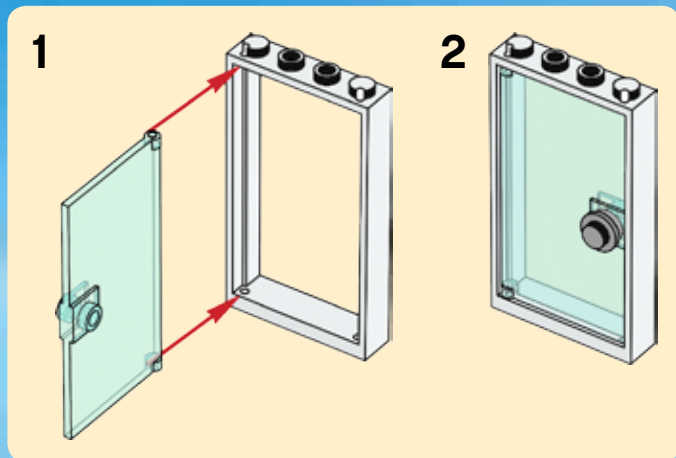
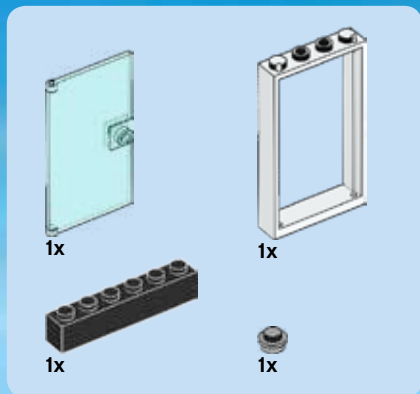

4

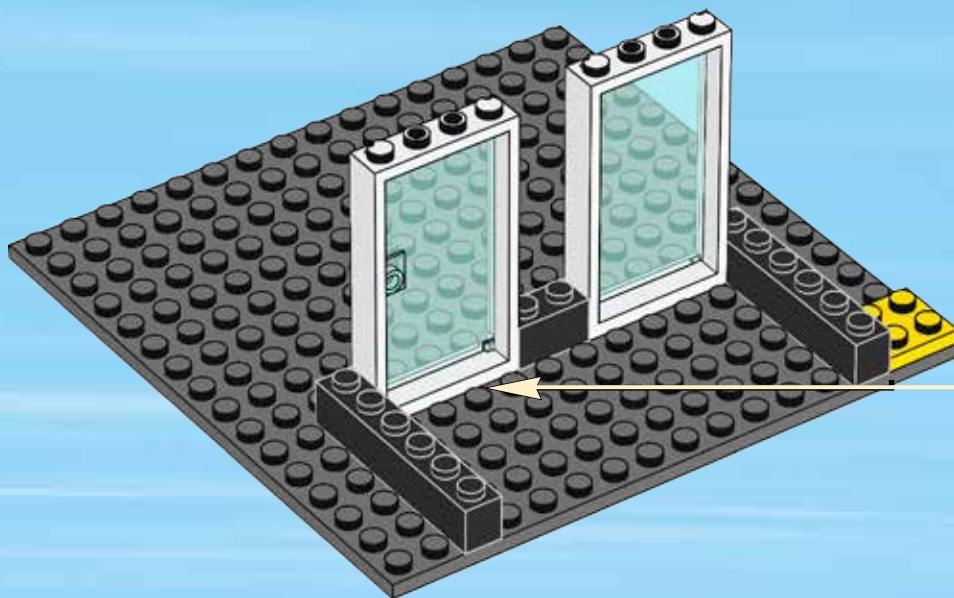

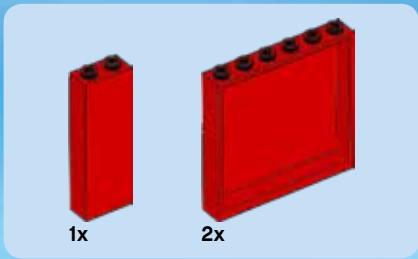

5

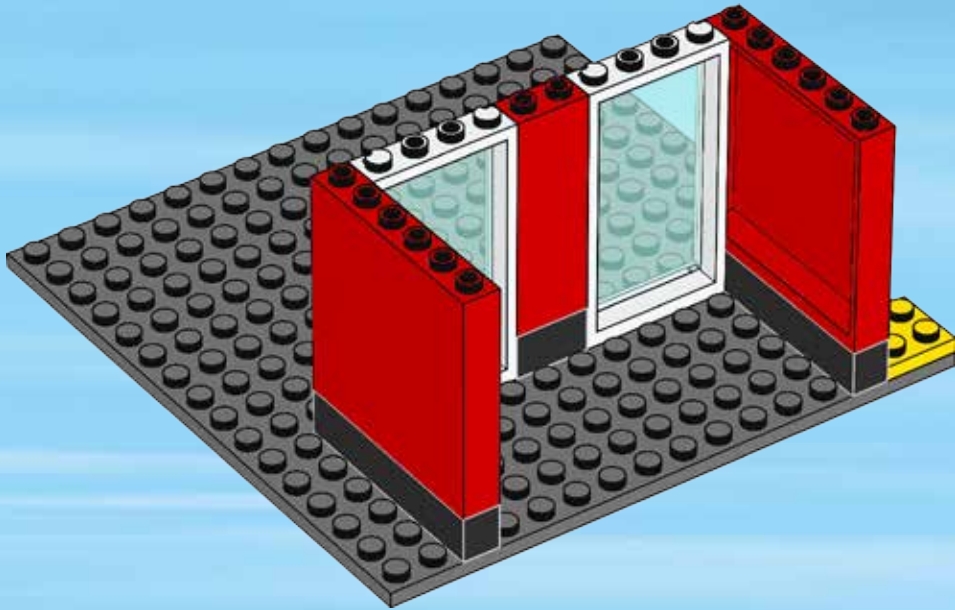

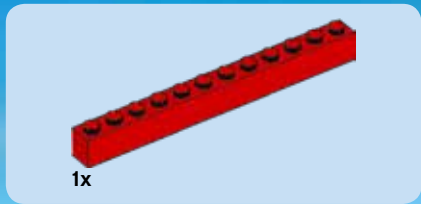

6

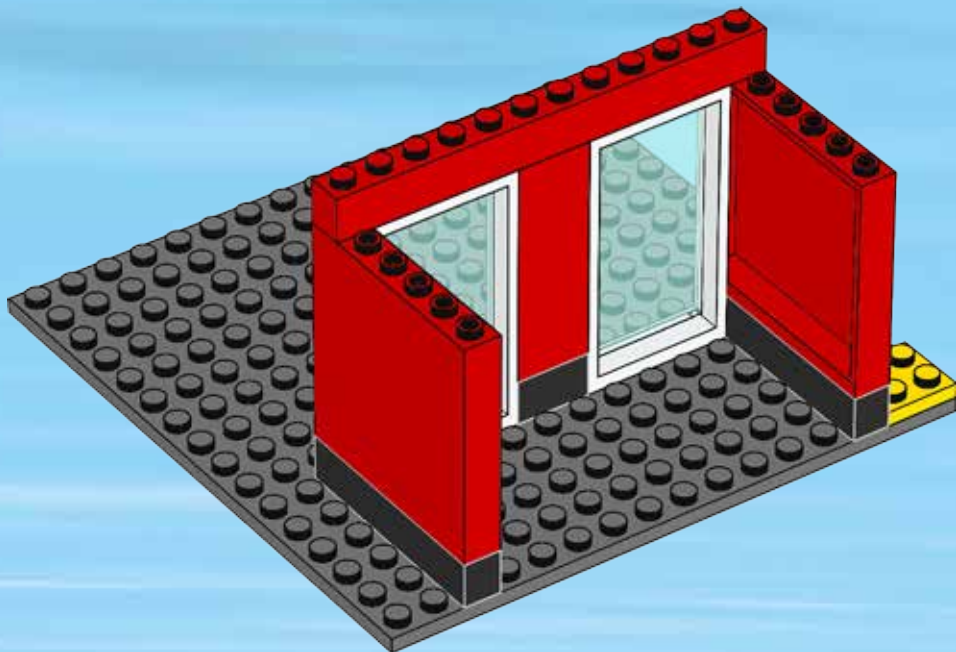

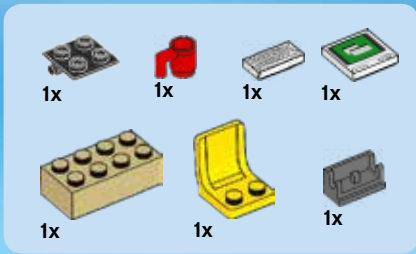

7

1



2



3

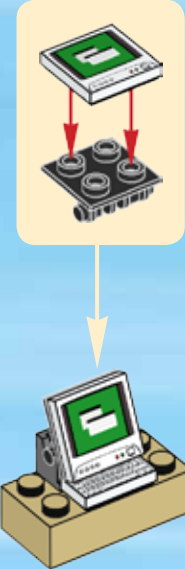

4



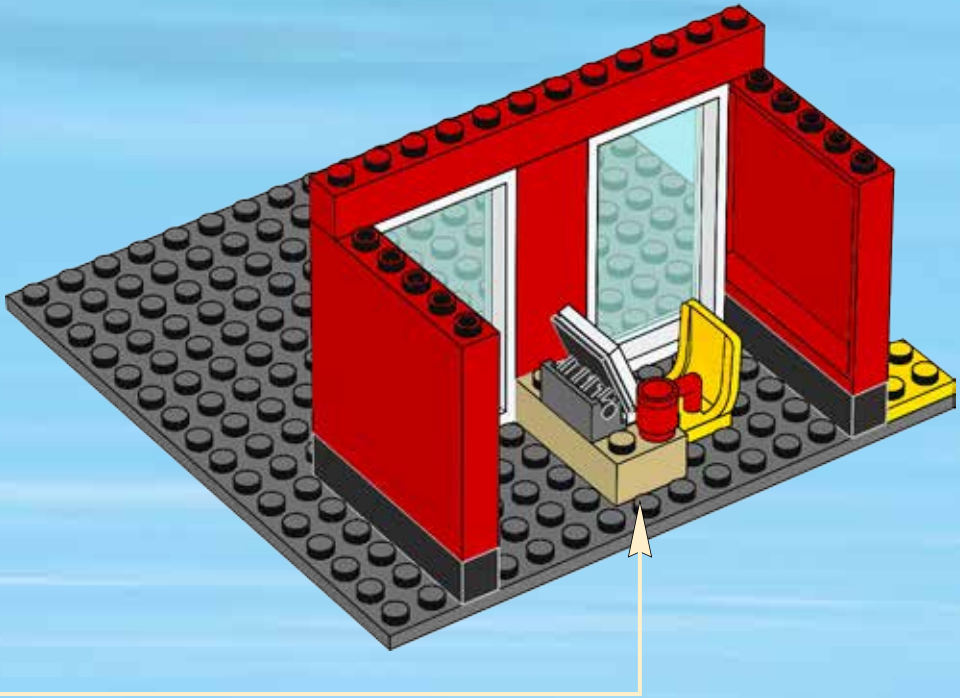

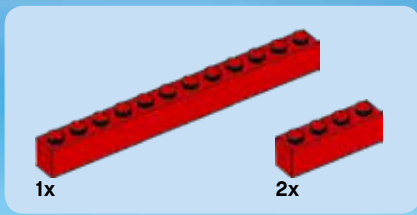

8





2x

9

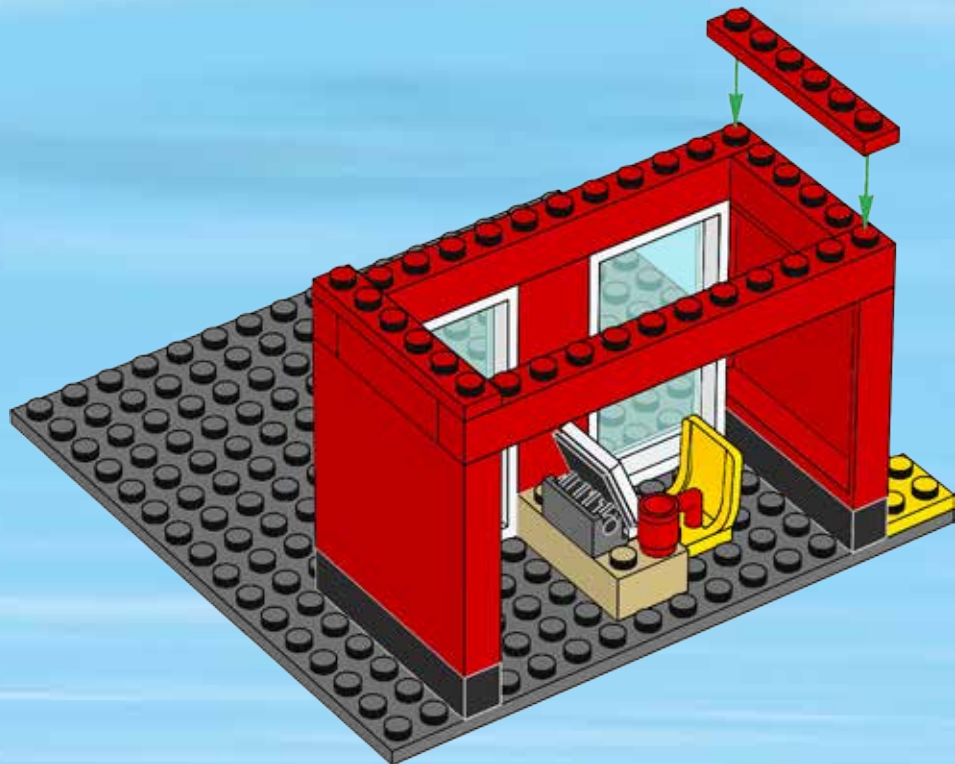

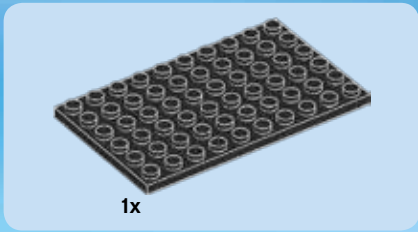

10

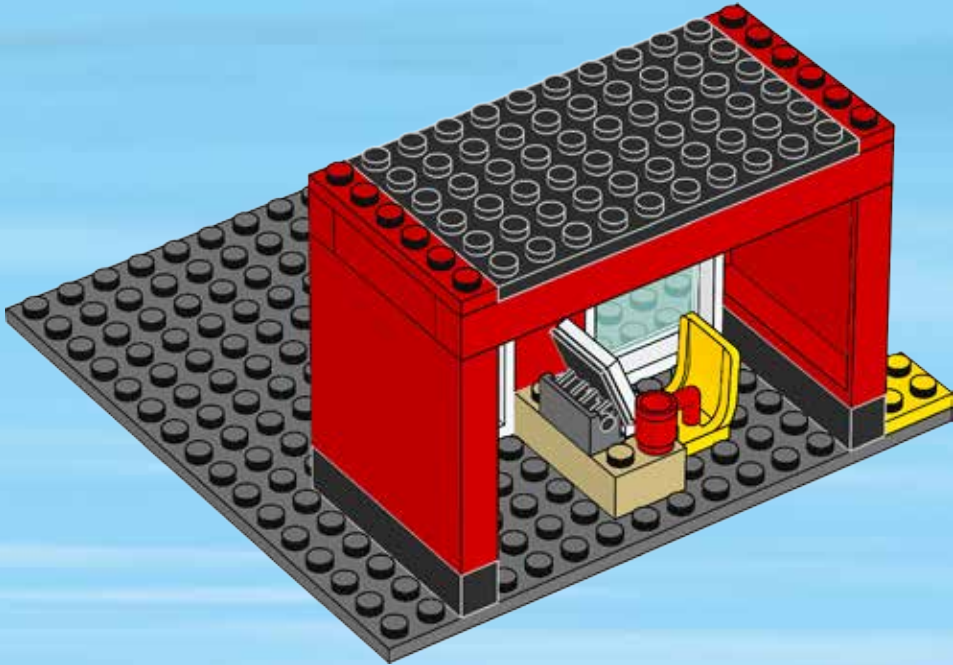

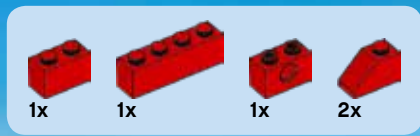

11

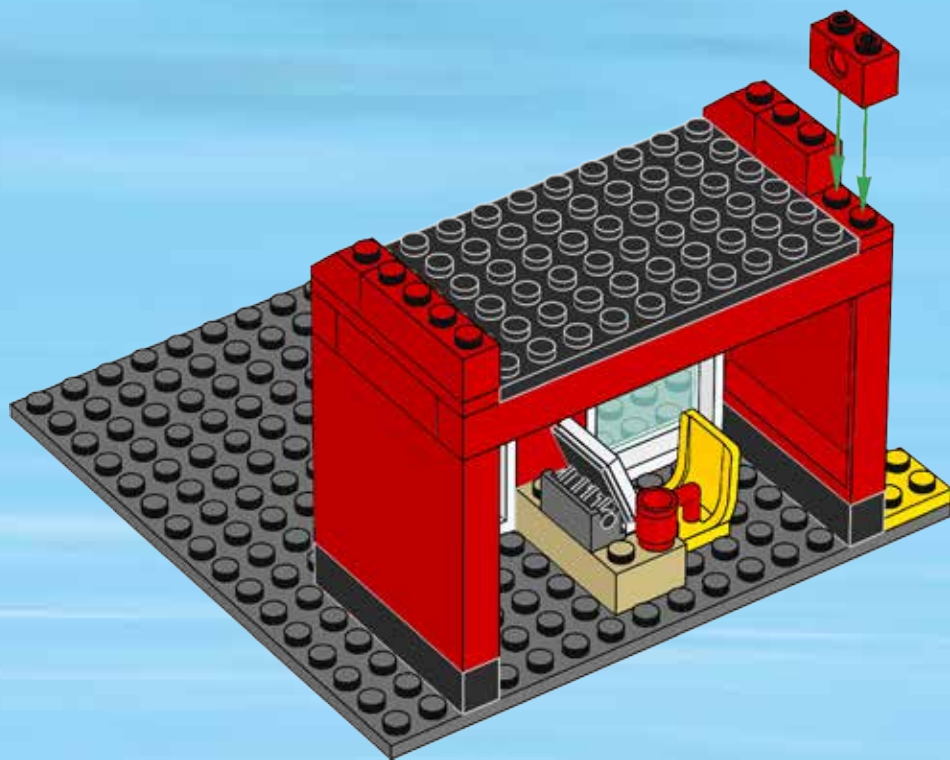

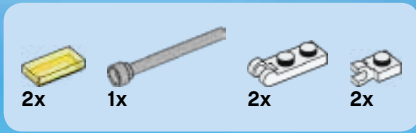

12

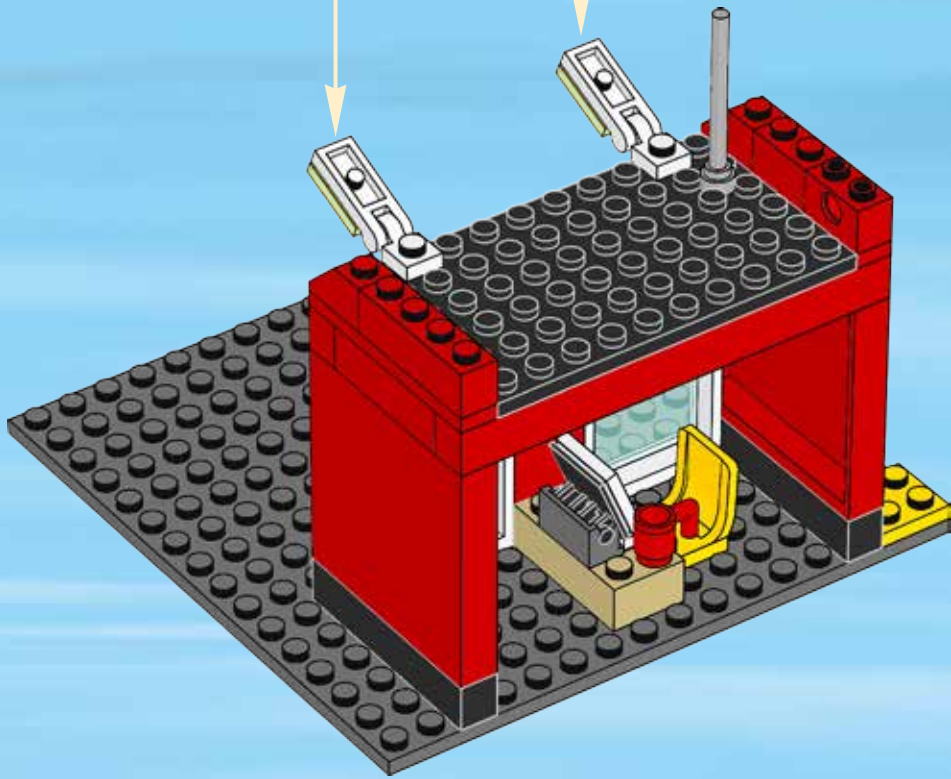
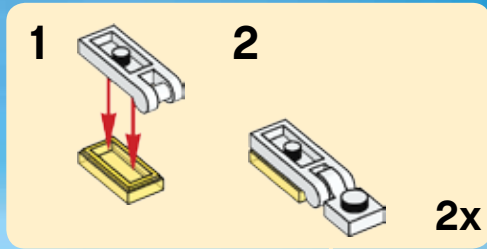

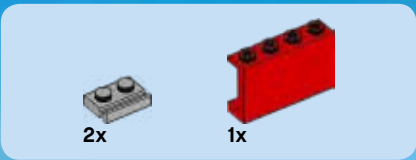

13

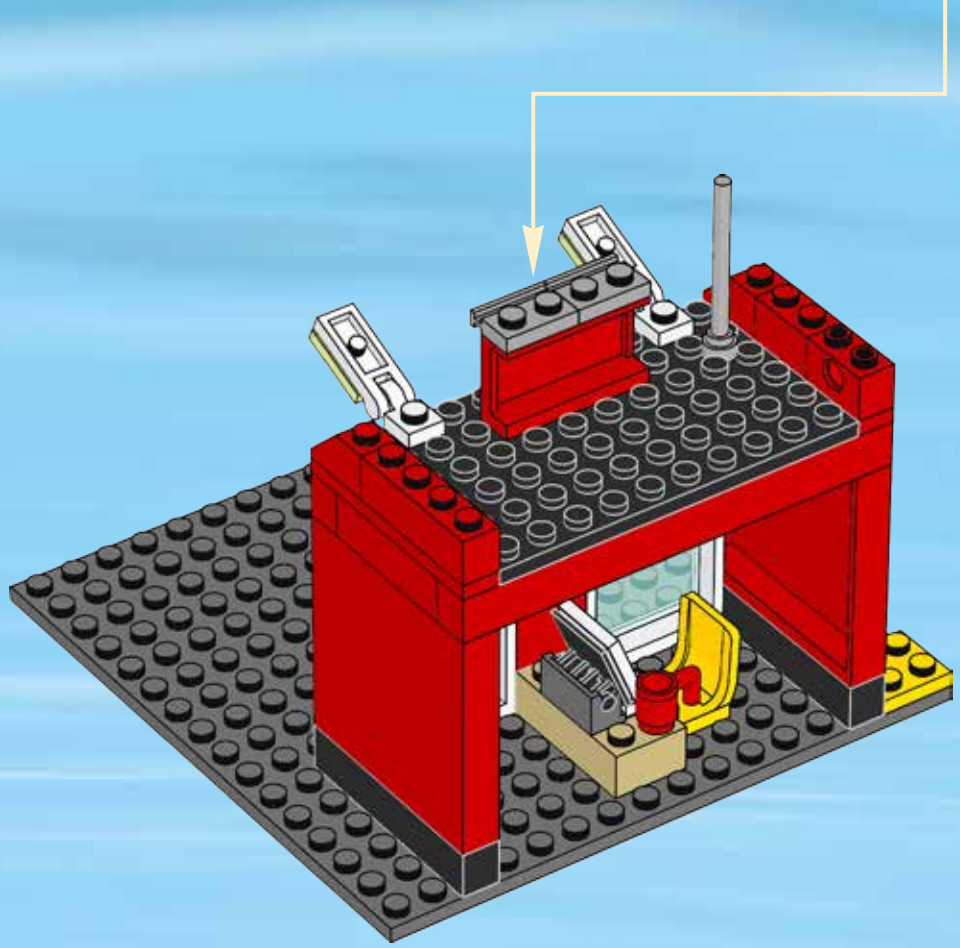
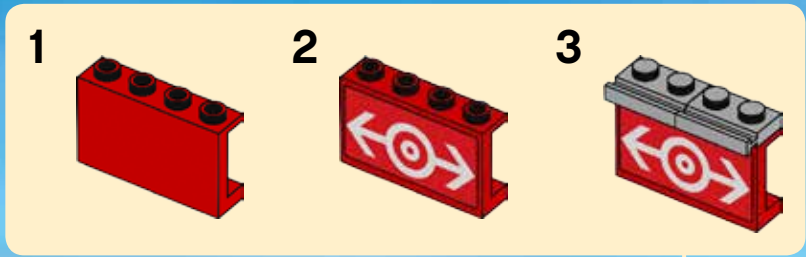



1x

14

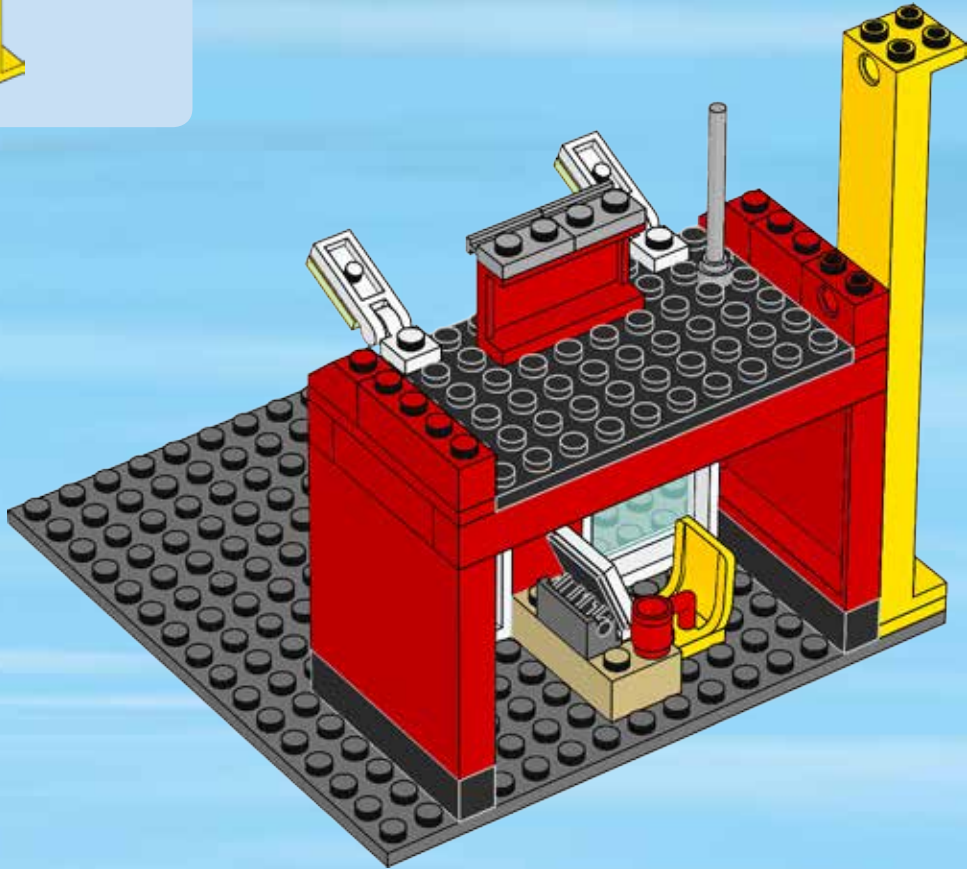



1x

15

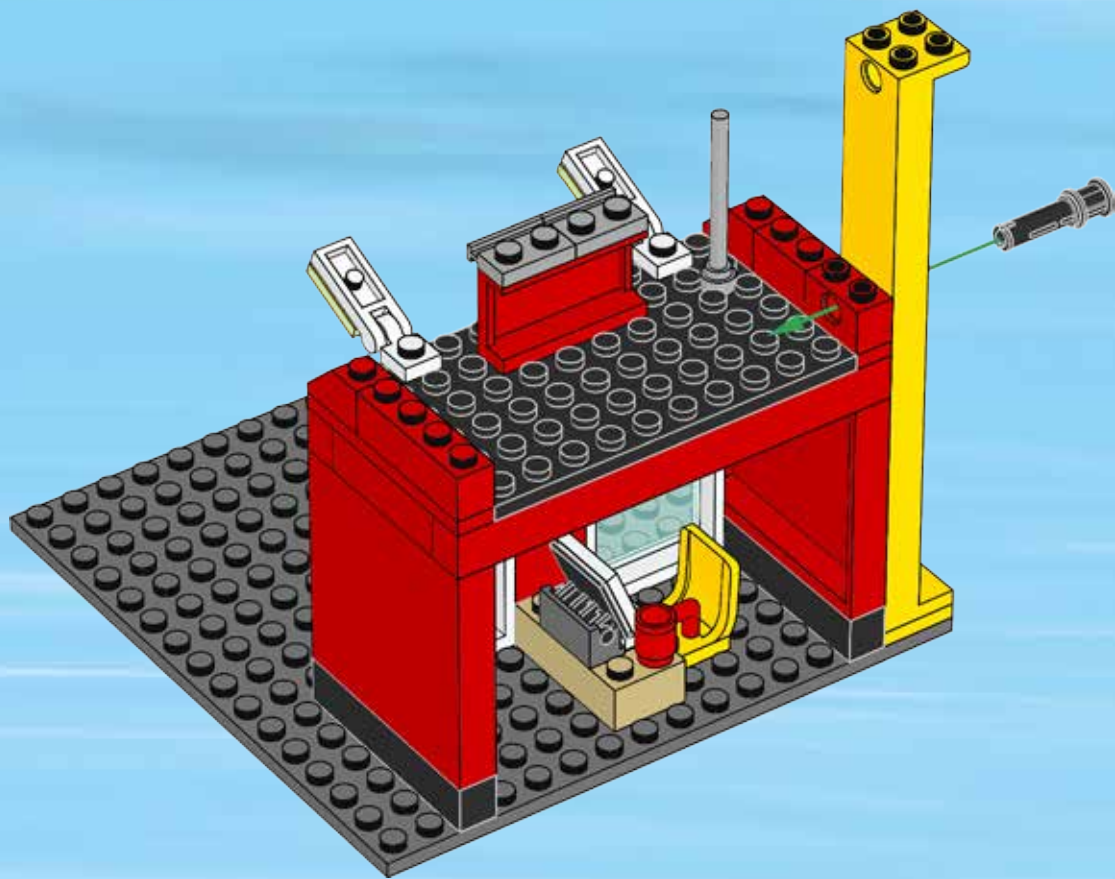

16

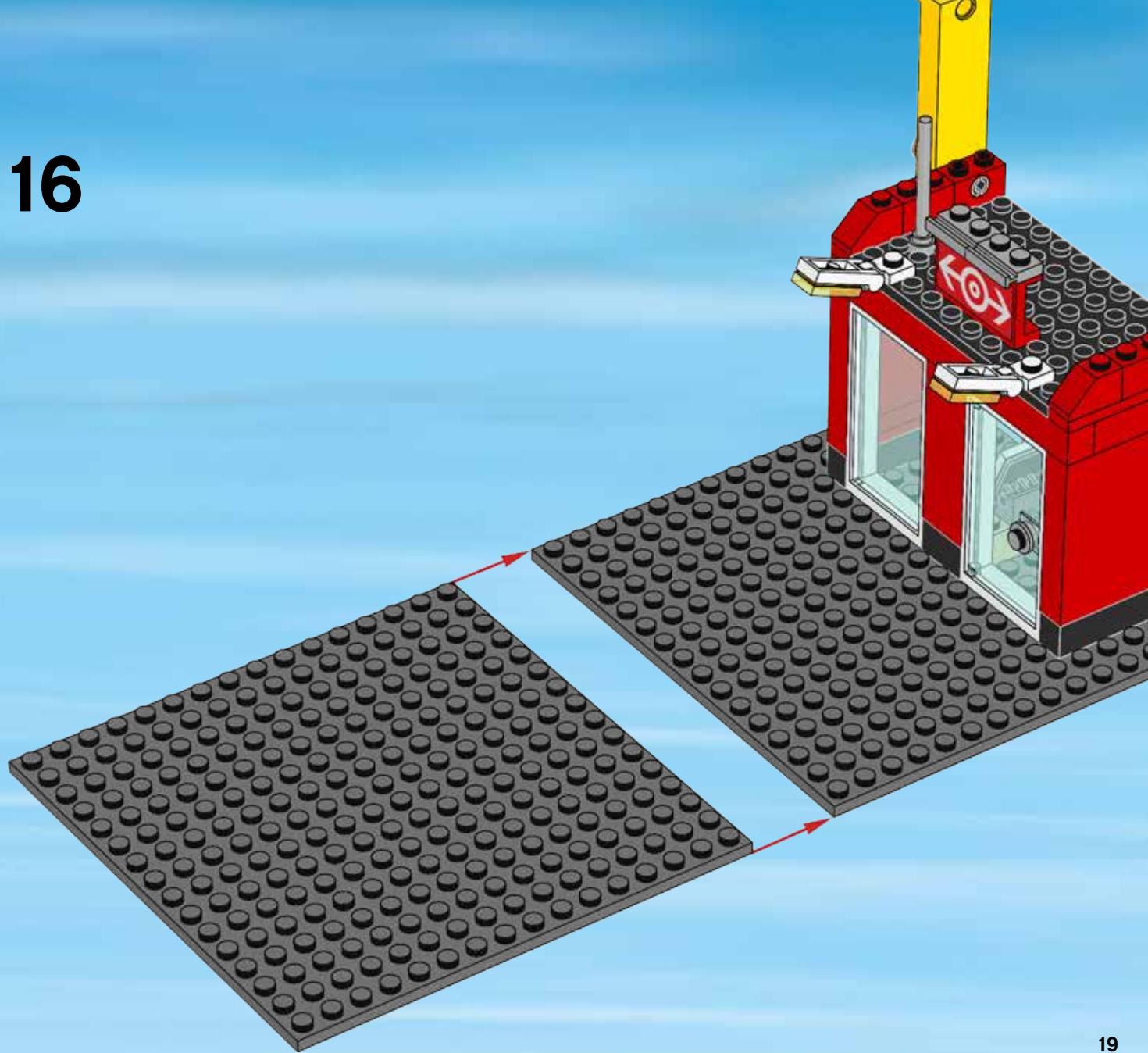



1x



1x



1x

17

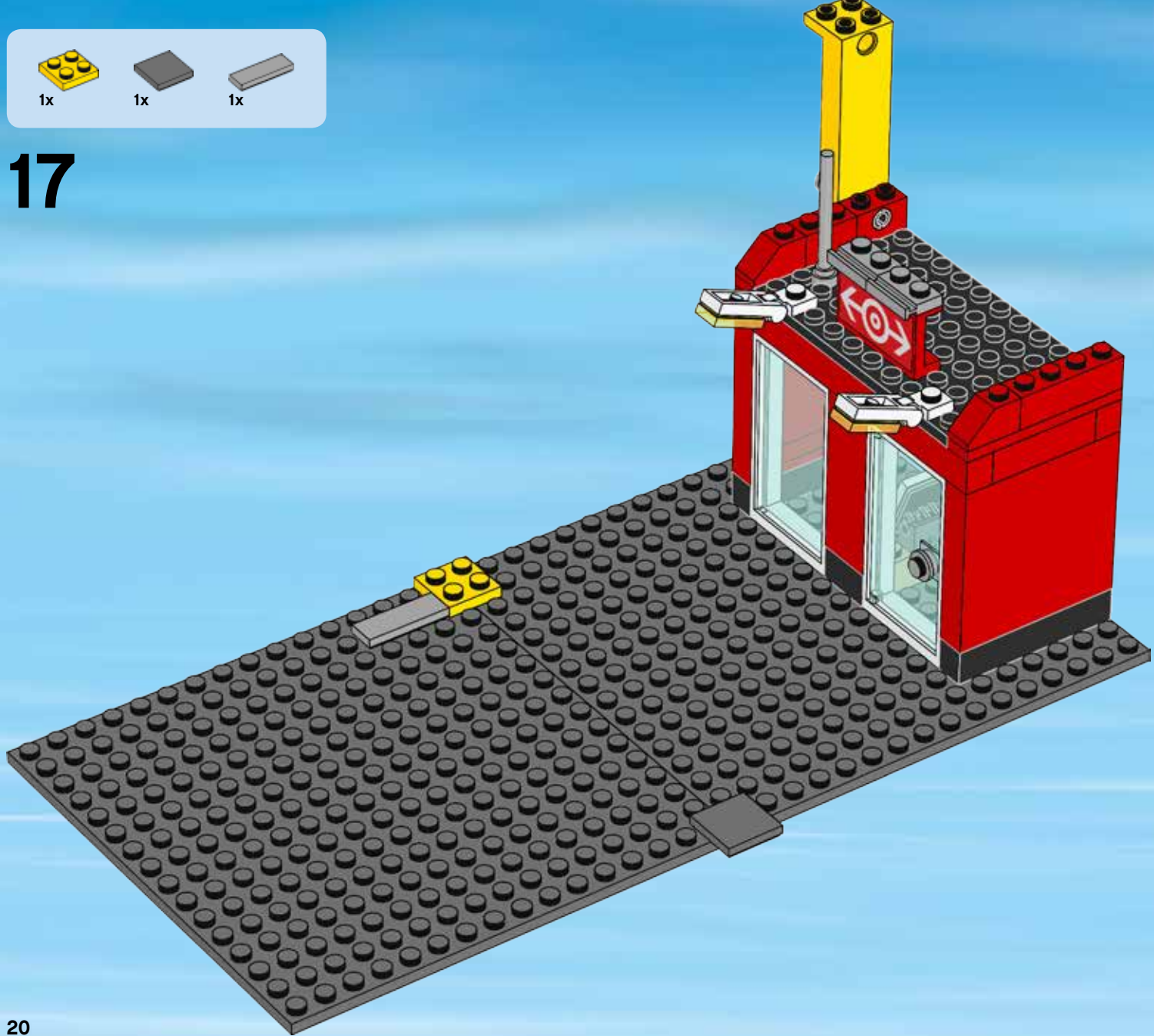



1x



1x



1x



1x



1x

18

1



2



3



4



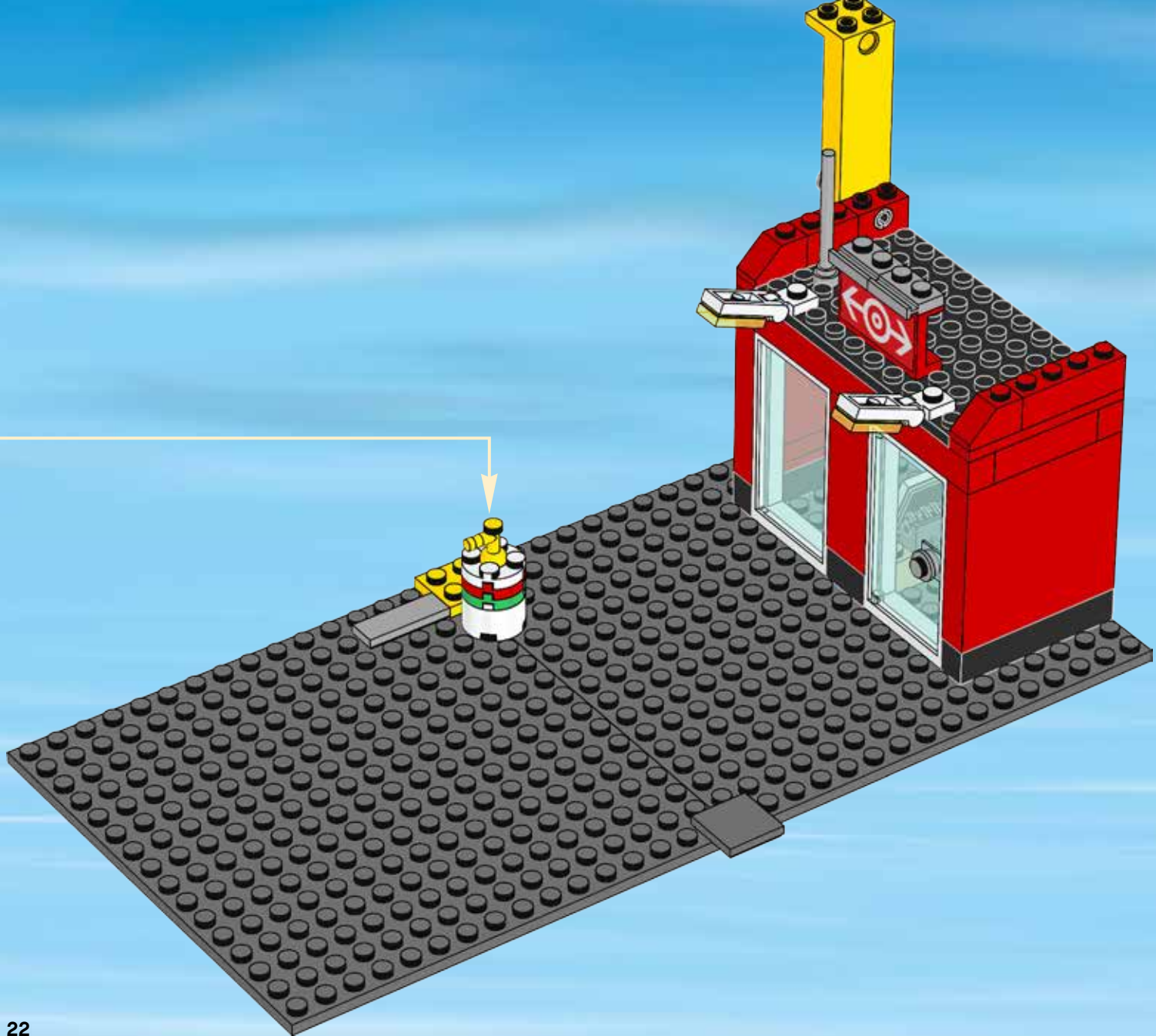



1x

19



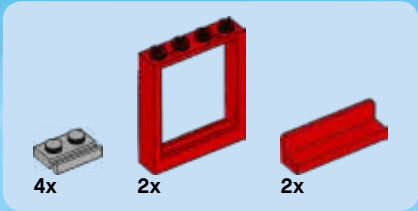
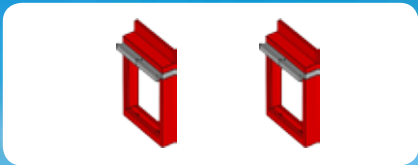

20

1

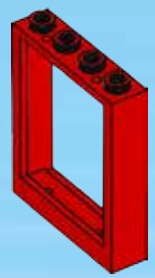

2

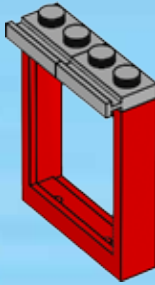

3

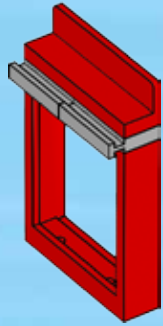

2x

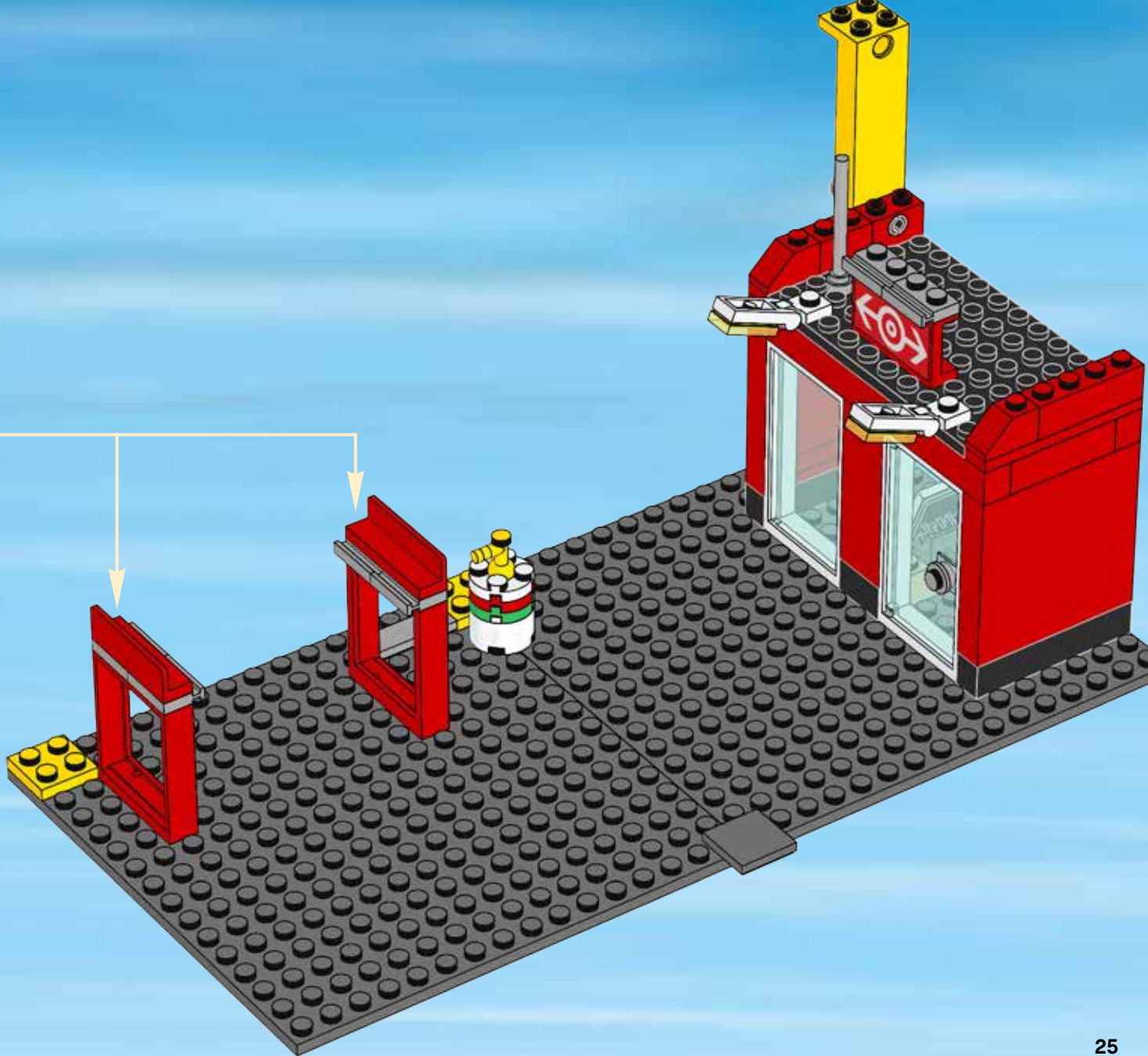



2x

21

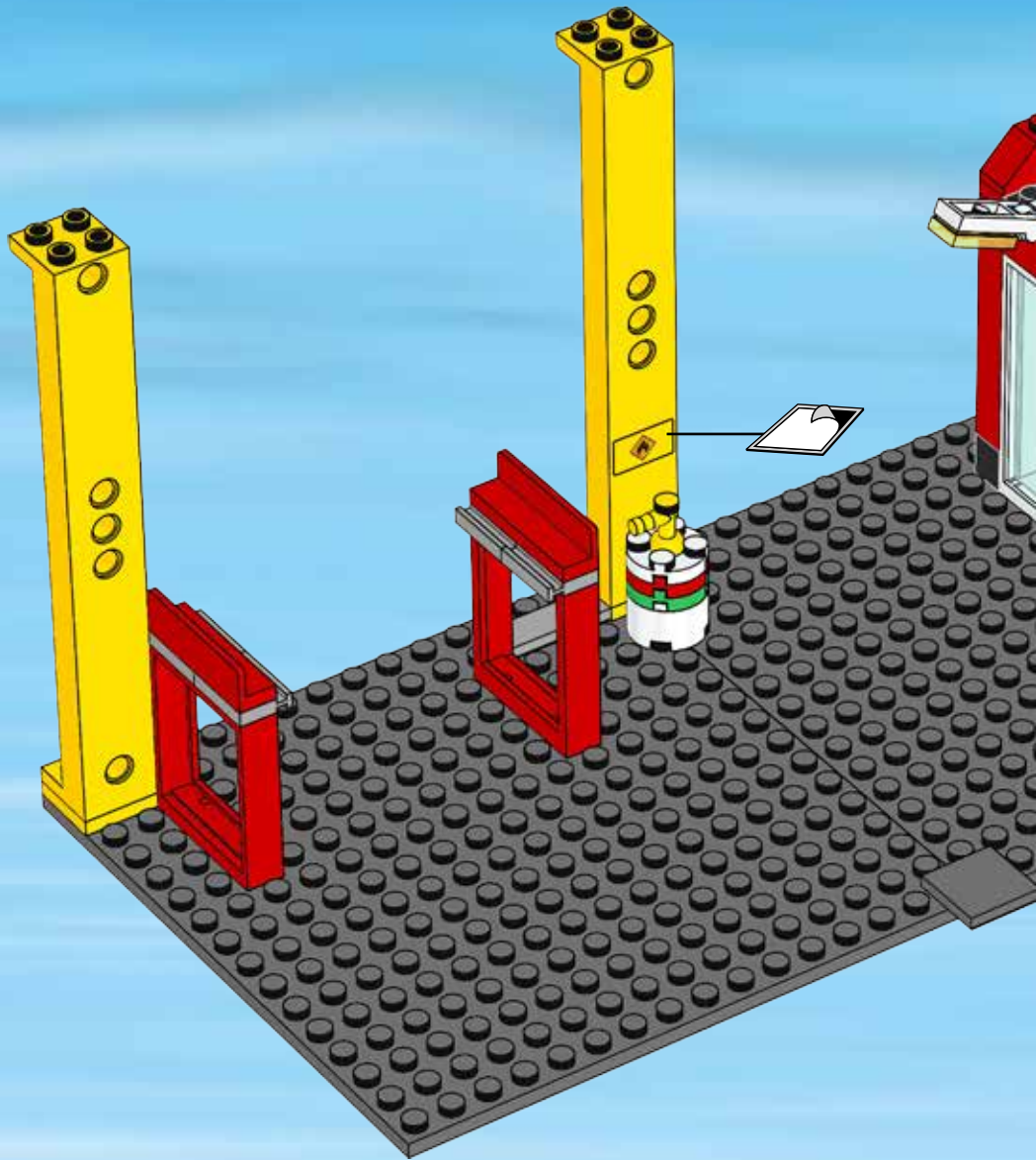

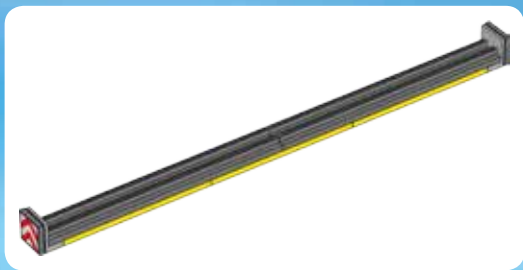

1

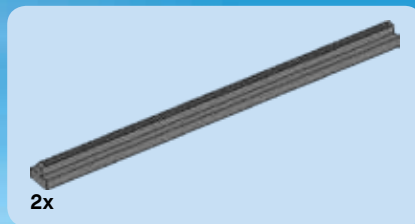
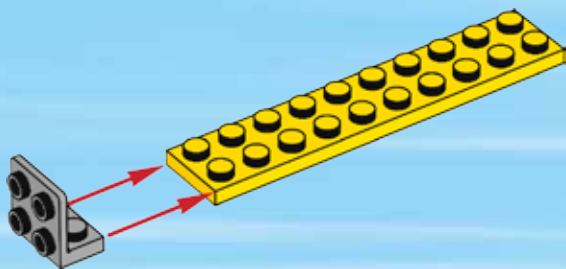

2

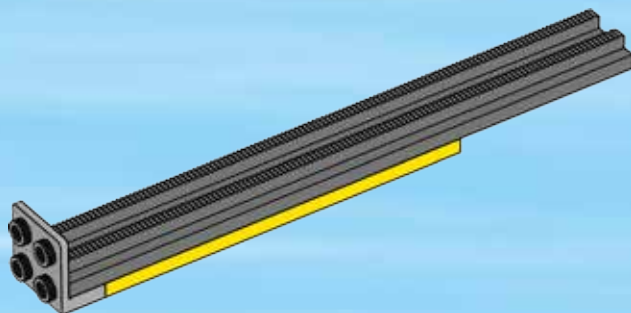

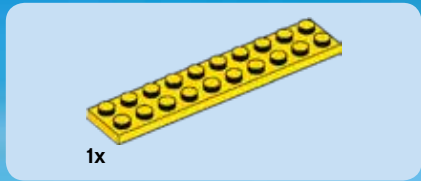

3

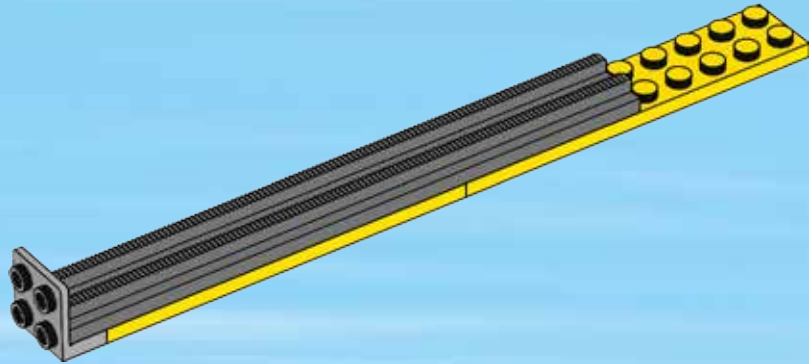

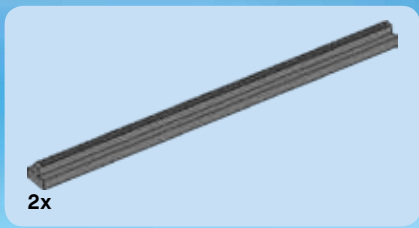

4

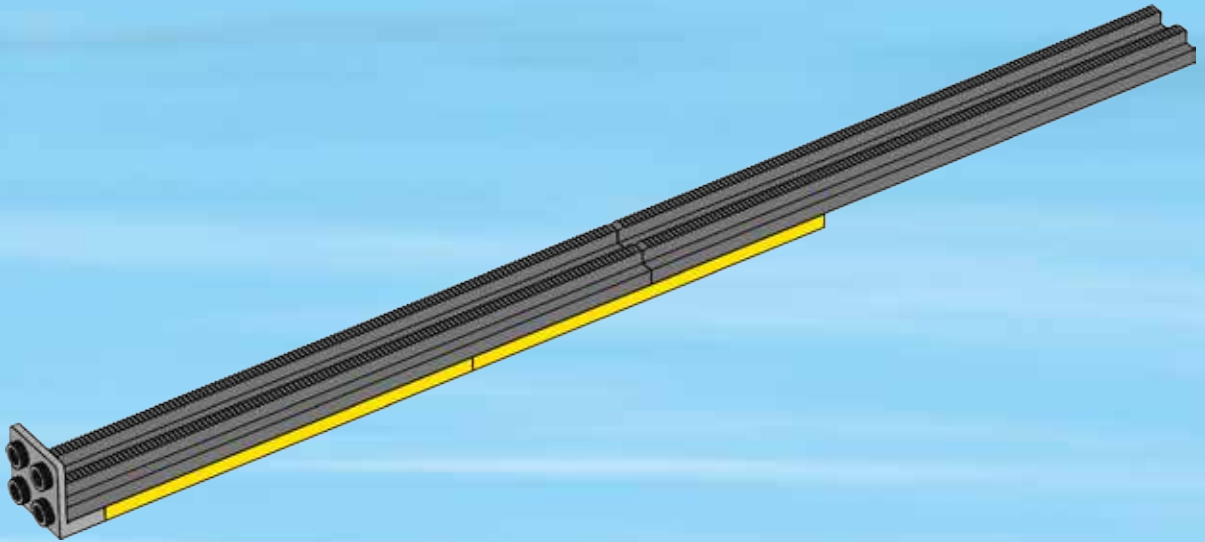

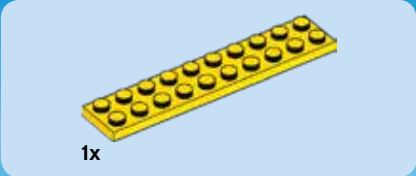

5

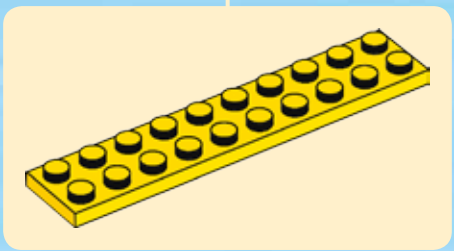
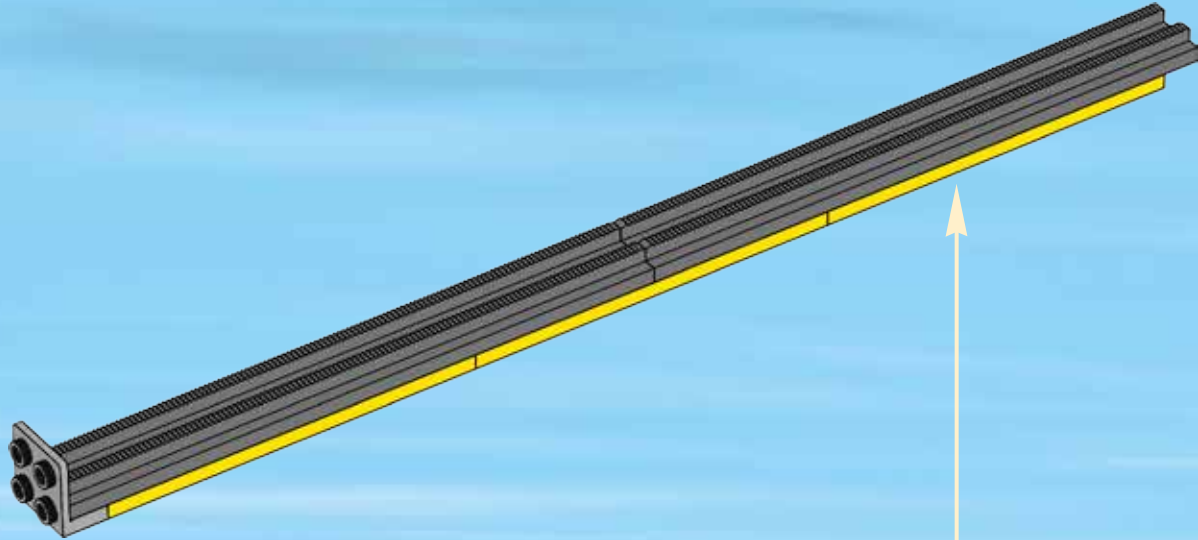



1x

6

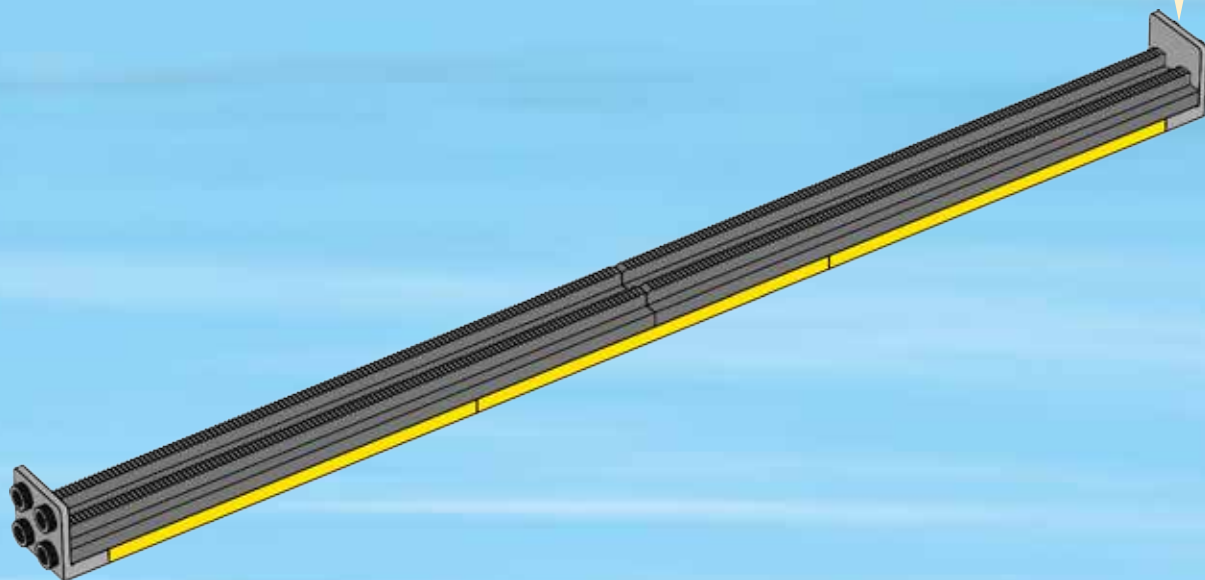
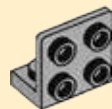



2x

7

1

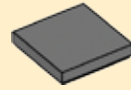

2



2x

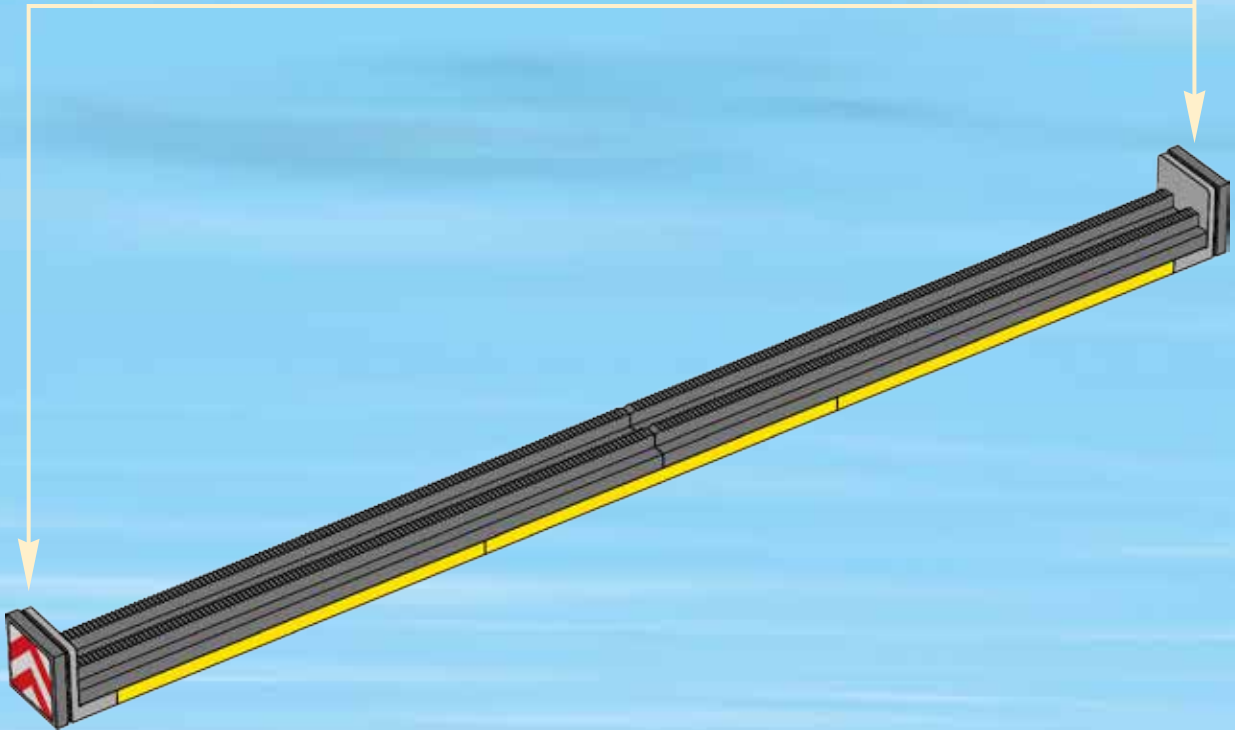

22

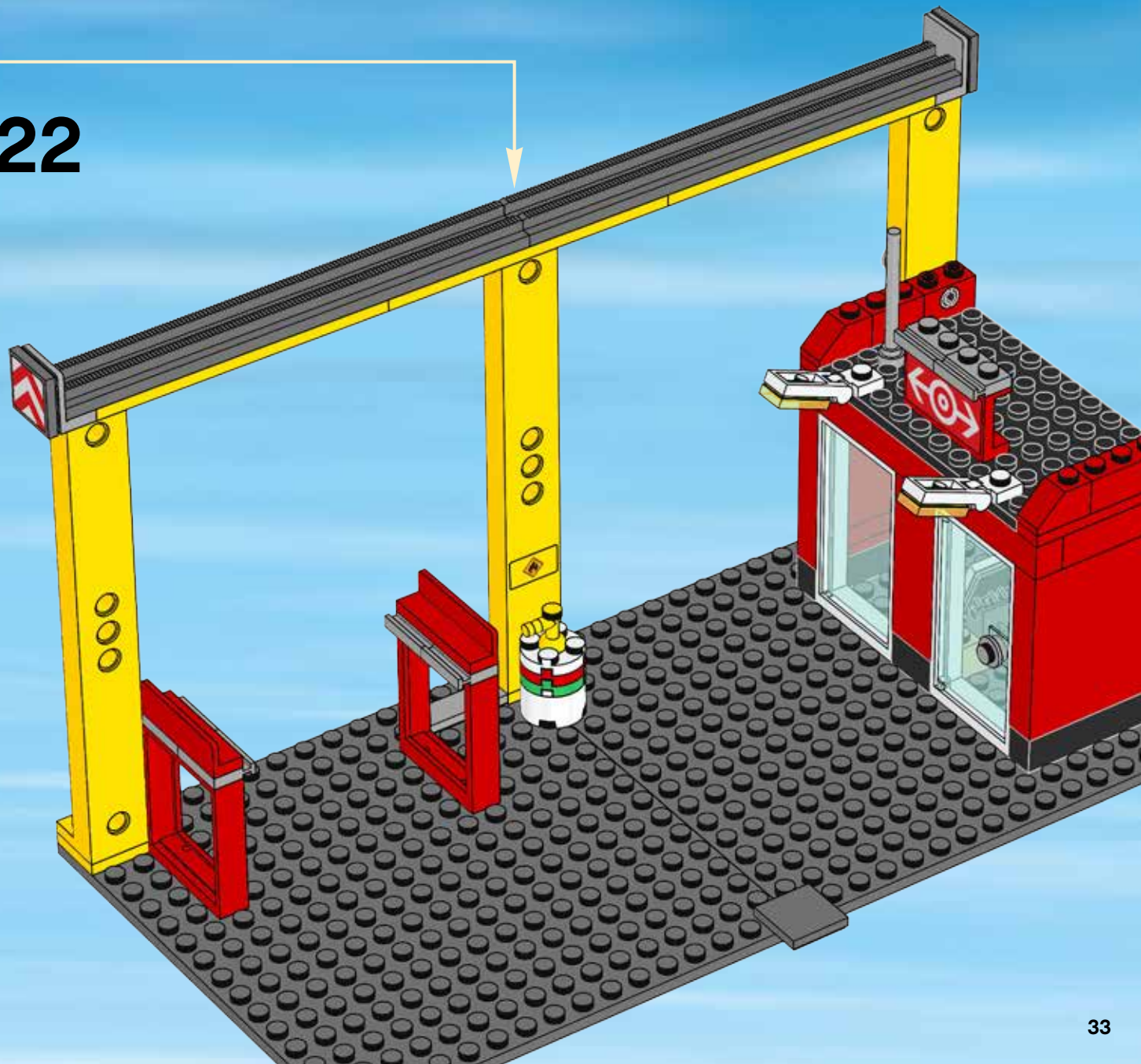

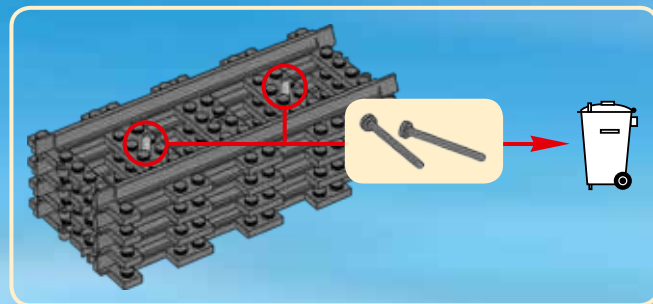
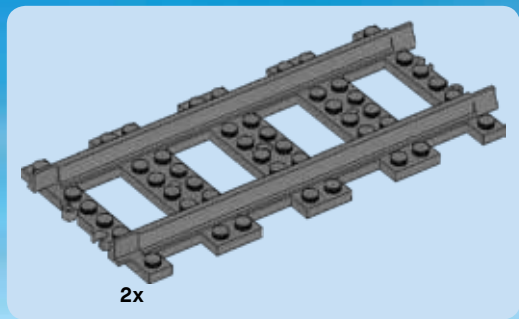

23

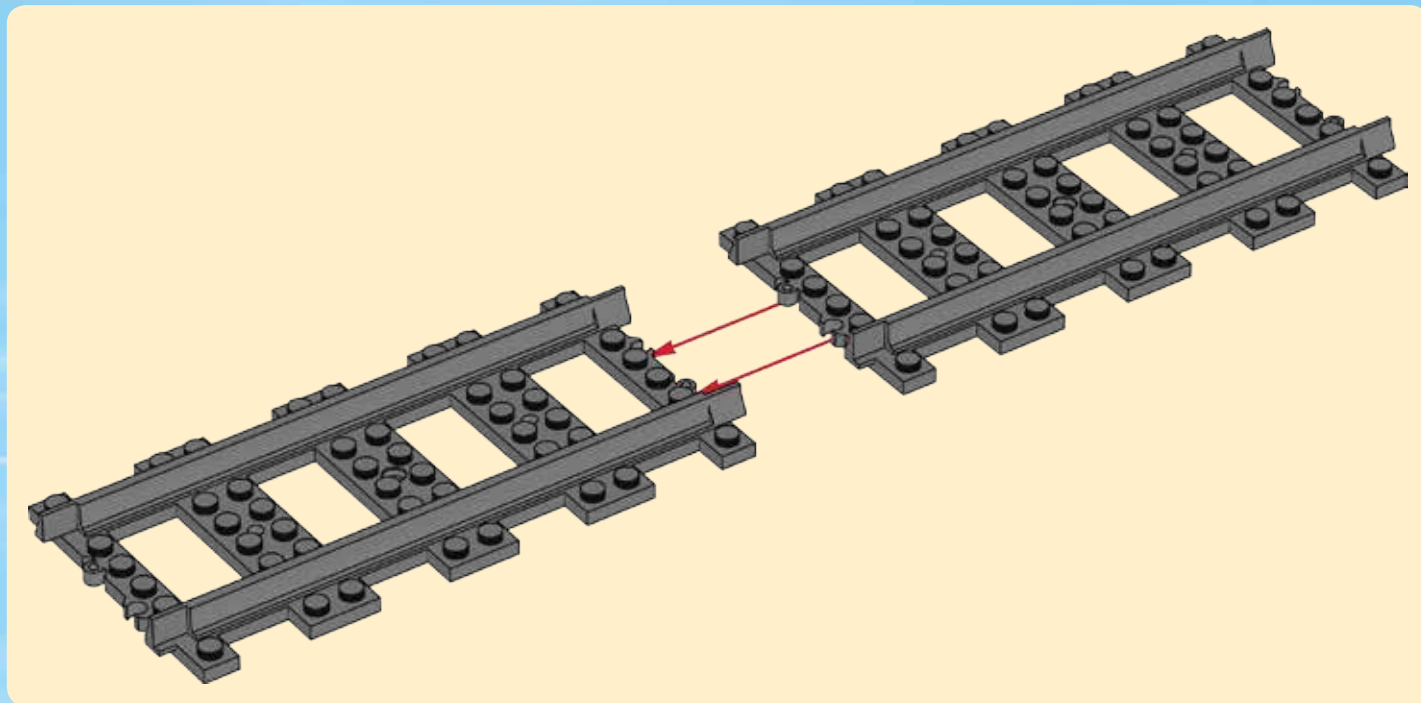

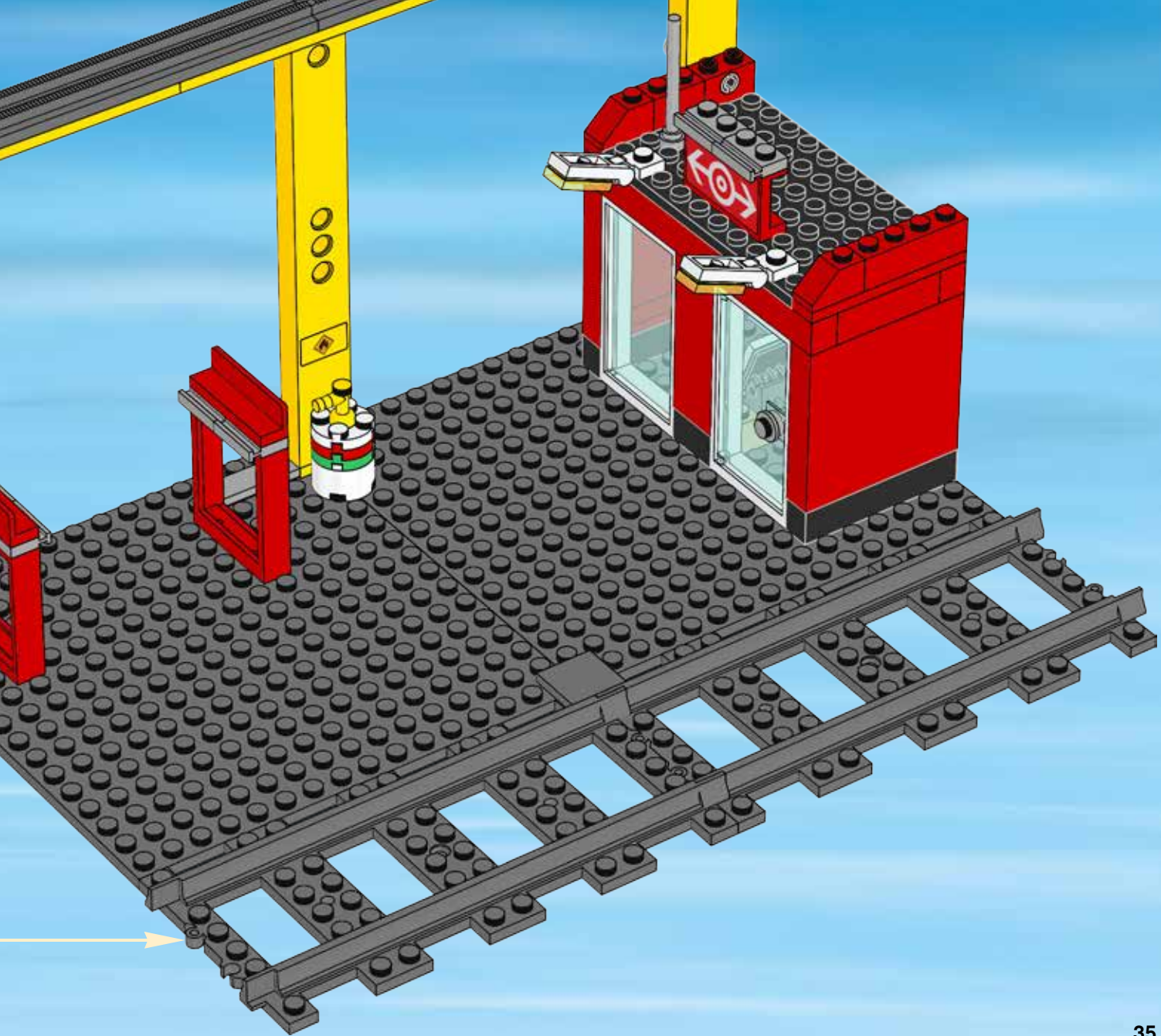



6x

24

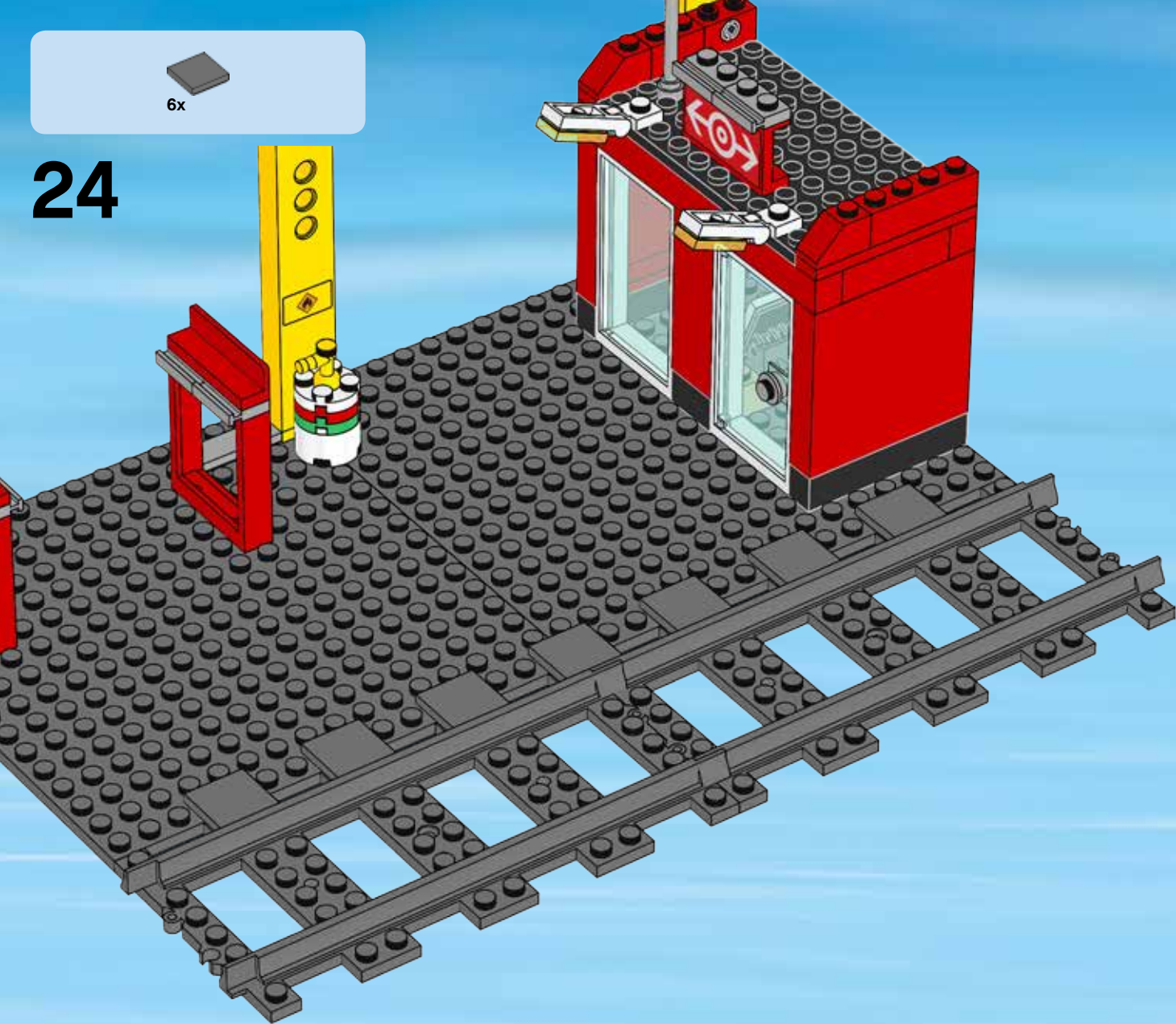

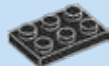

3x



3x

25

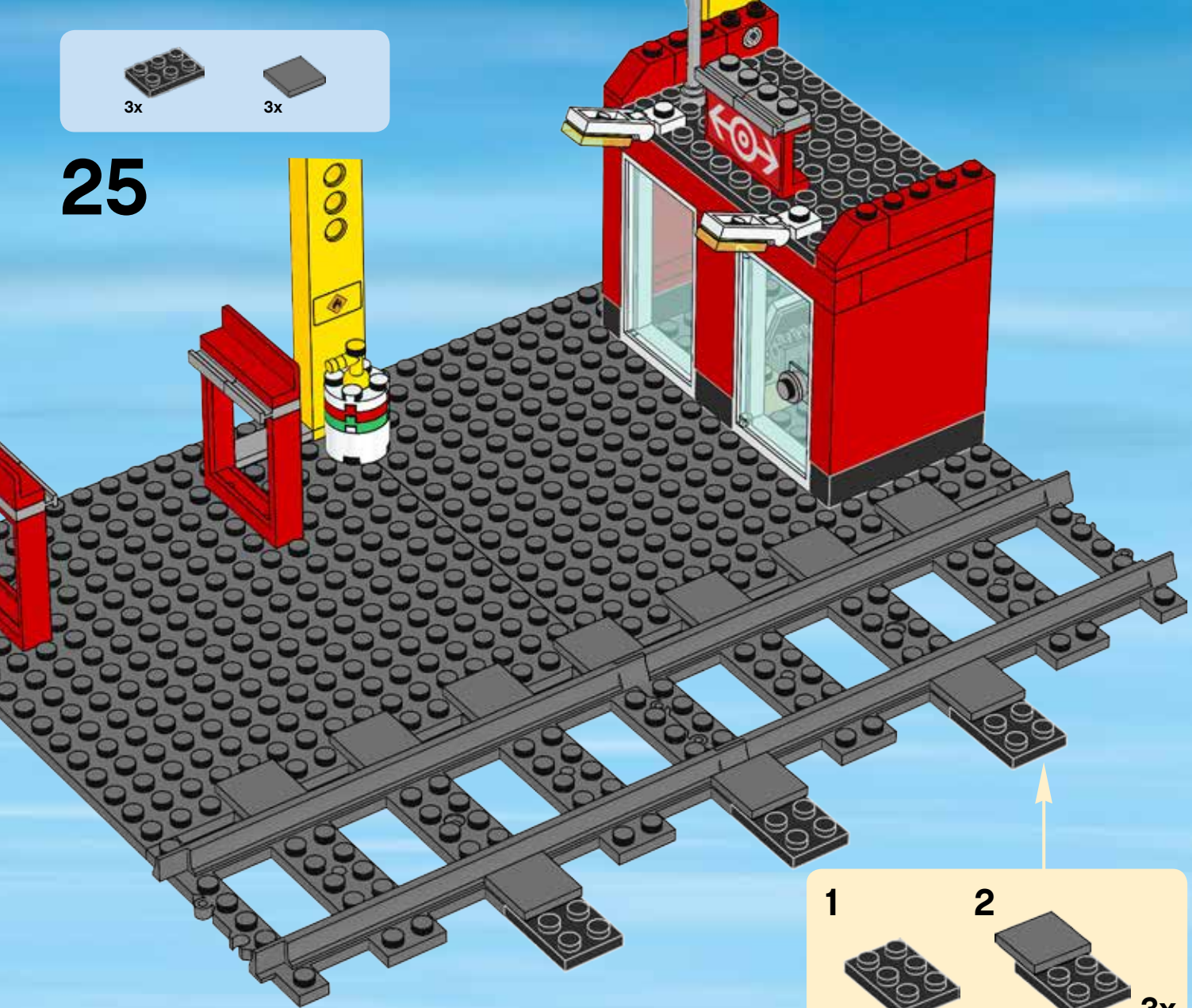

1



2



3x



26

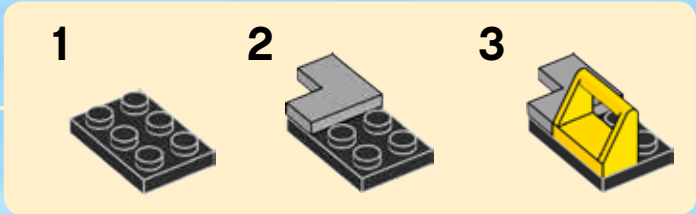
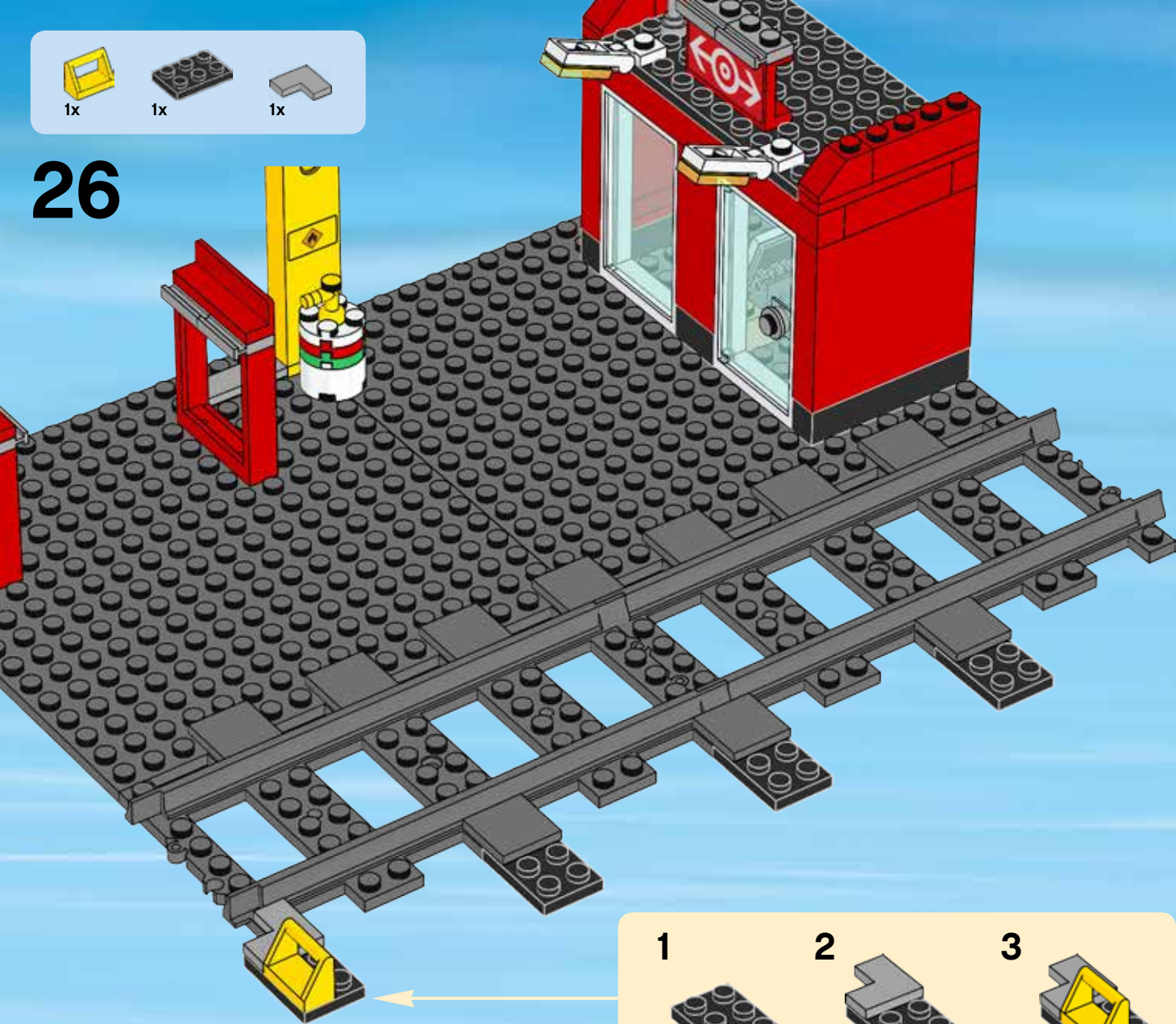



1x

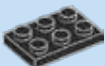

1x



1x

27

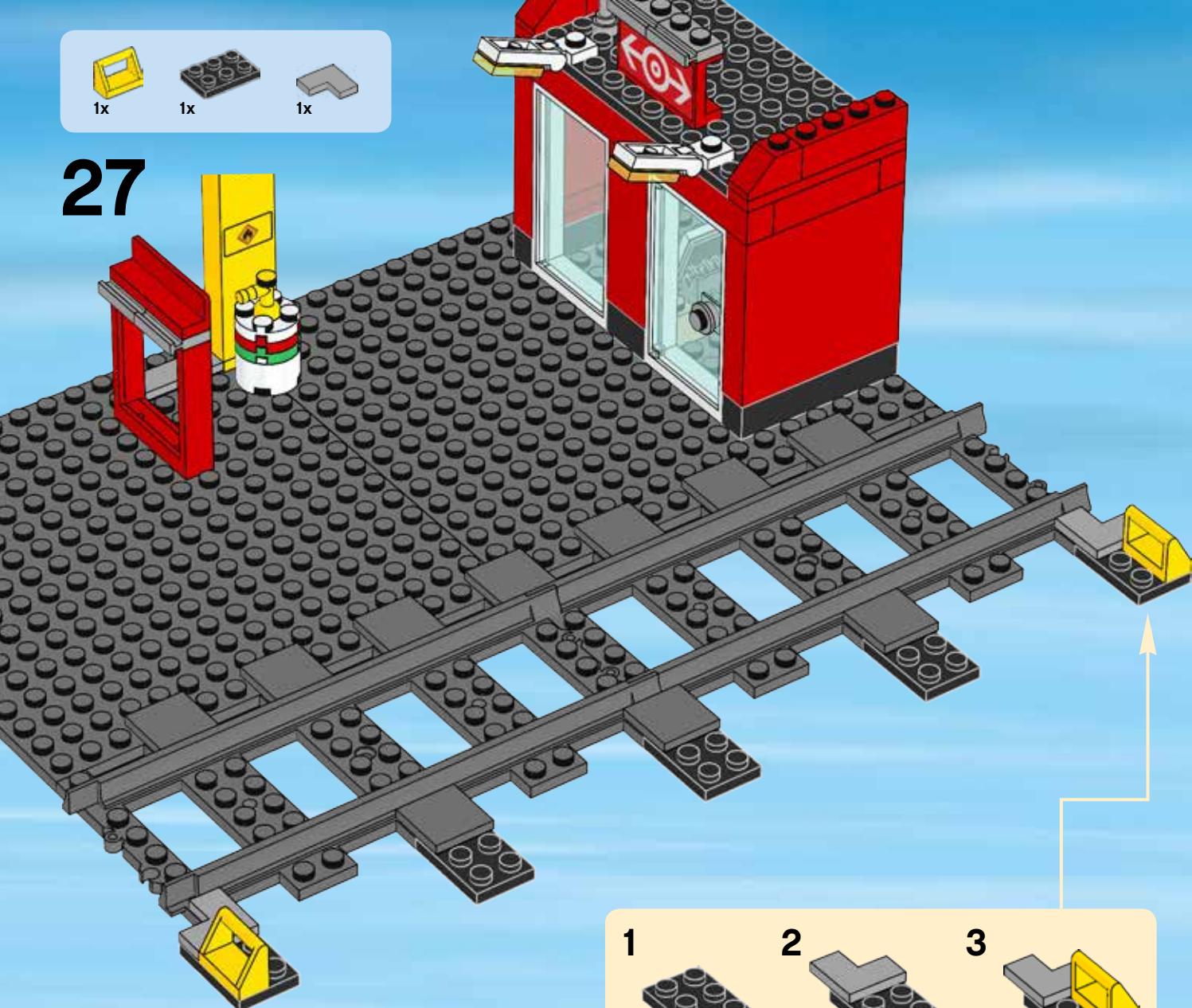

1

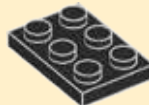

2



3

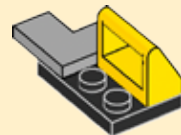

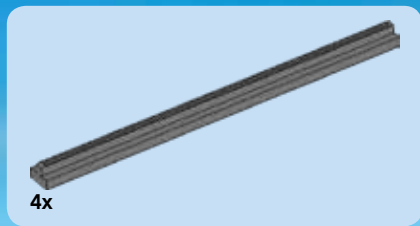

28

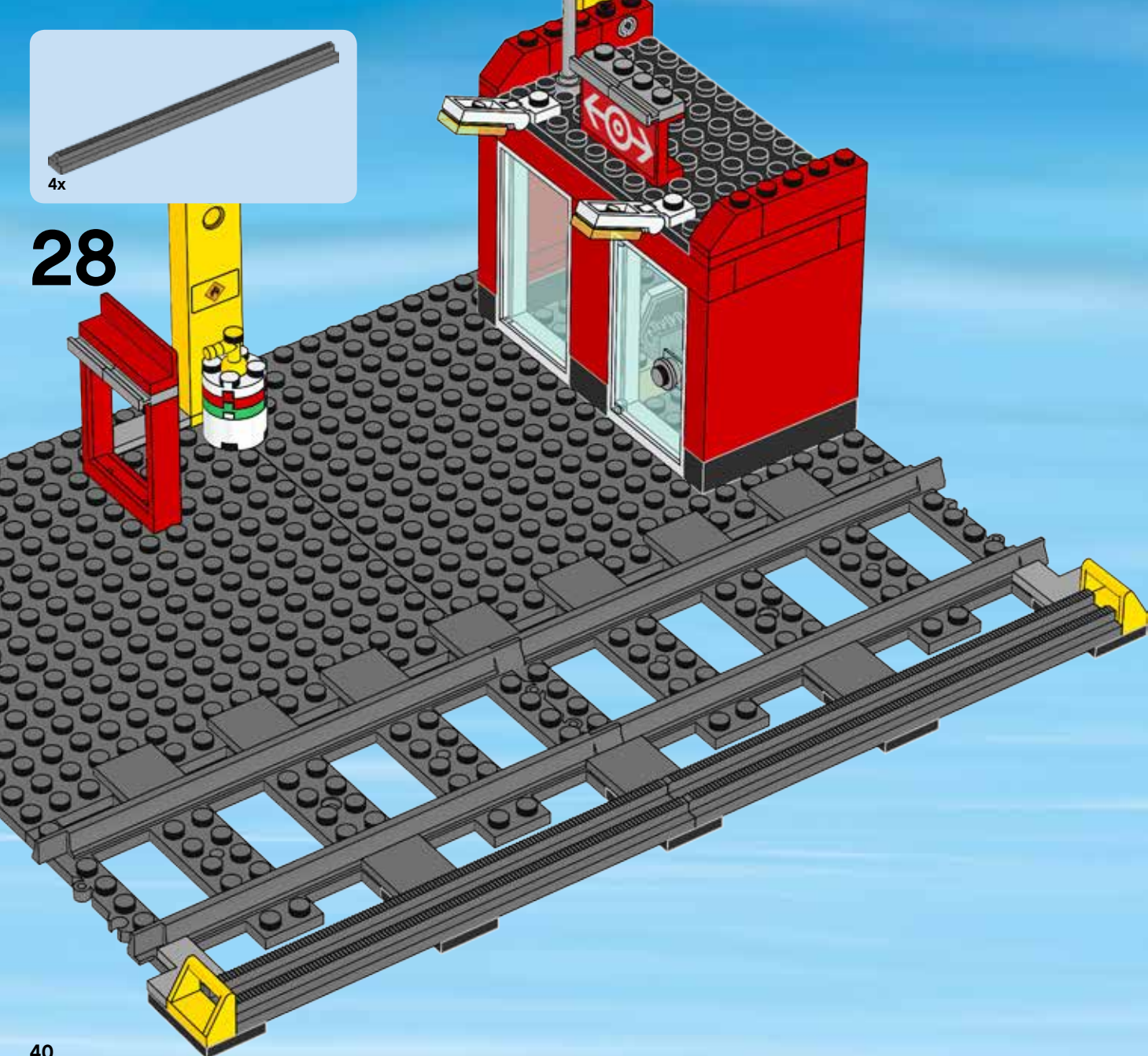



+



1x

1

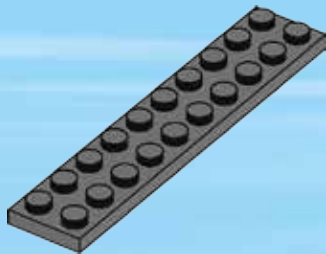

2x

2

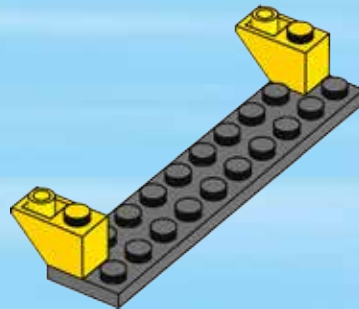



2x

3

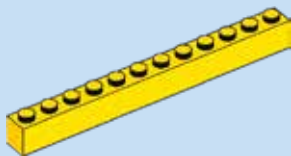
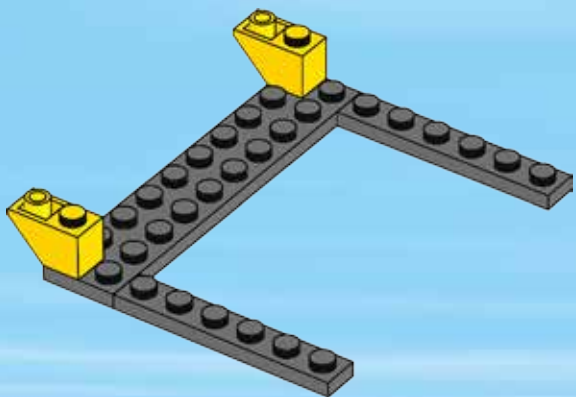

2x

4

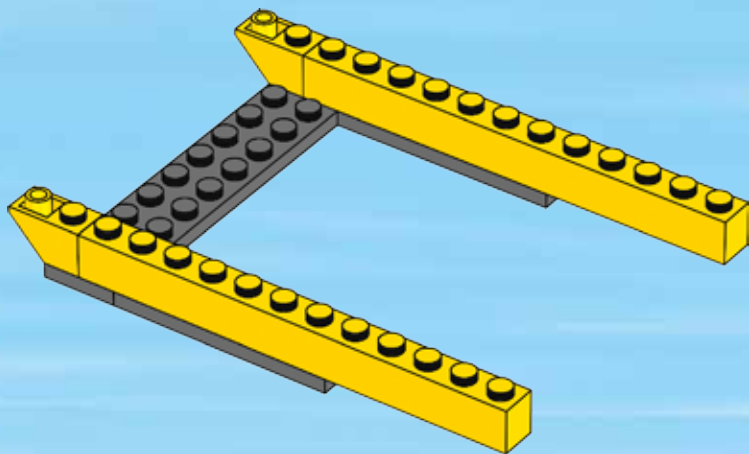



5

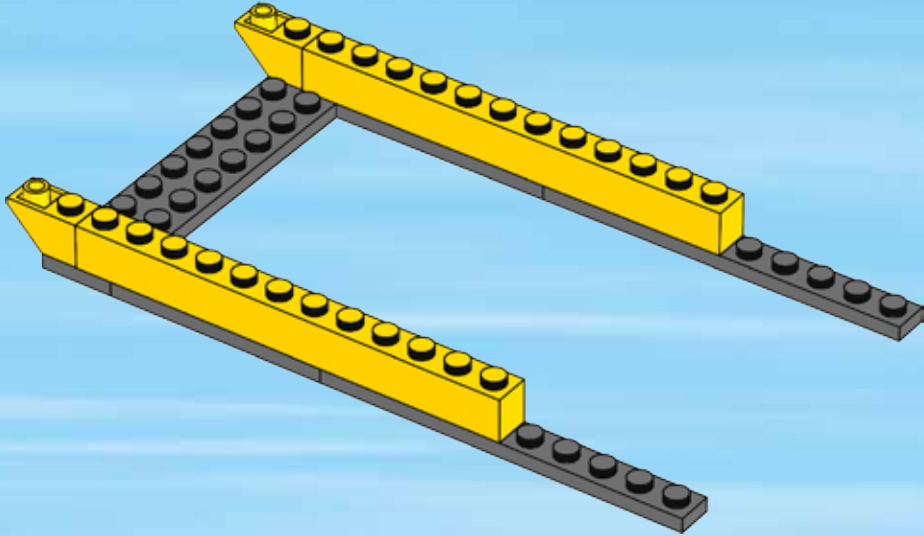

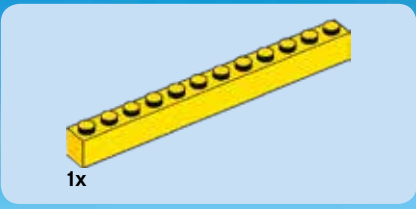

6

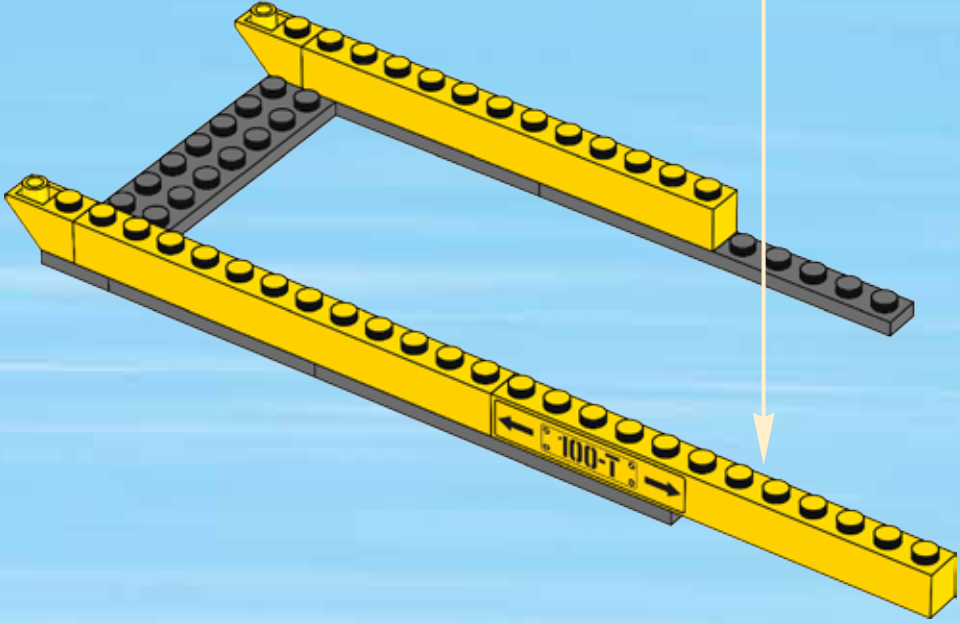
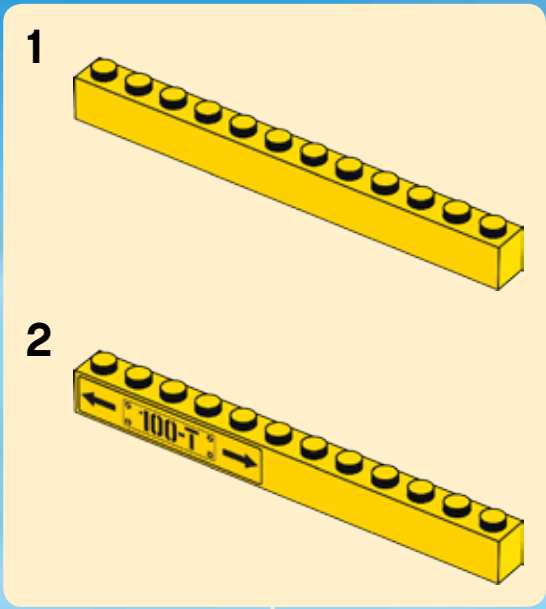

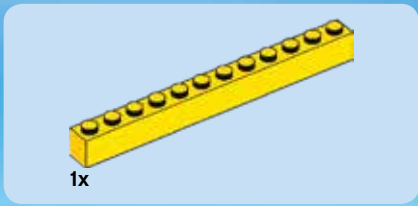

7

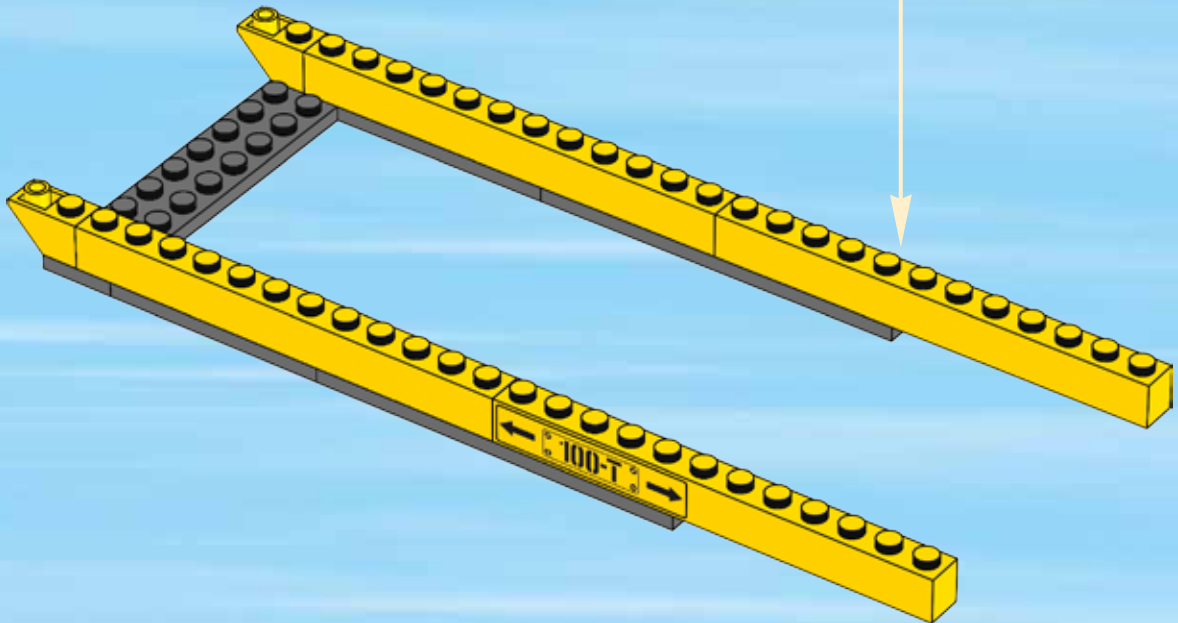
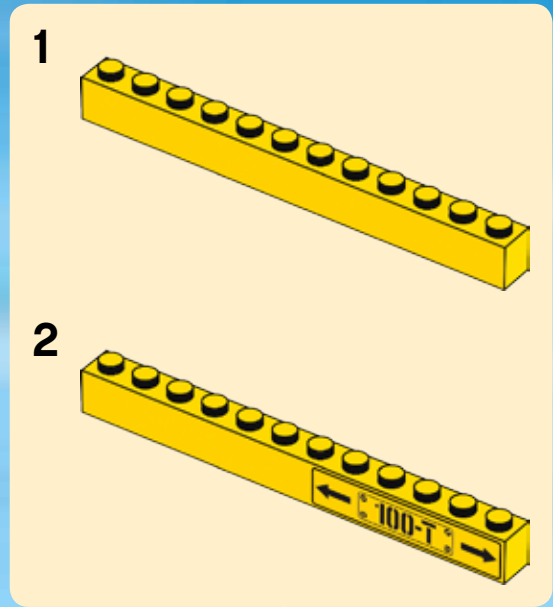

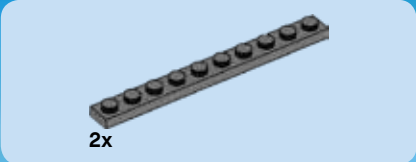

8

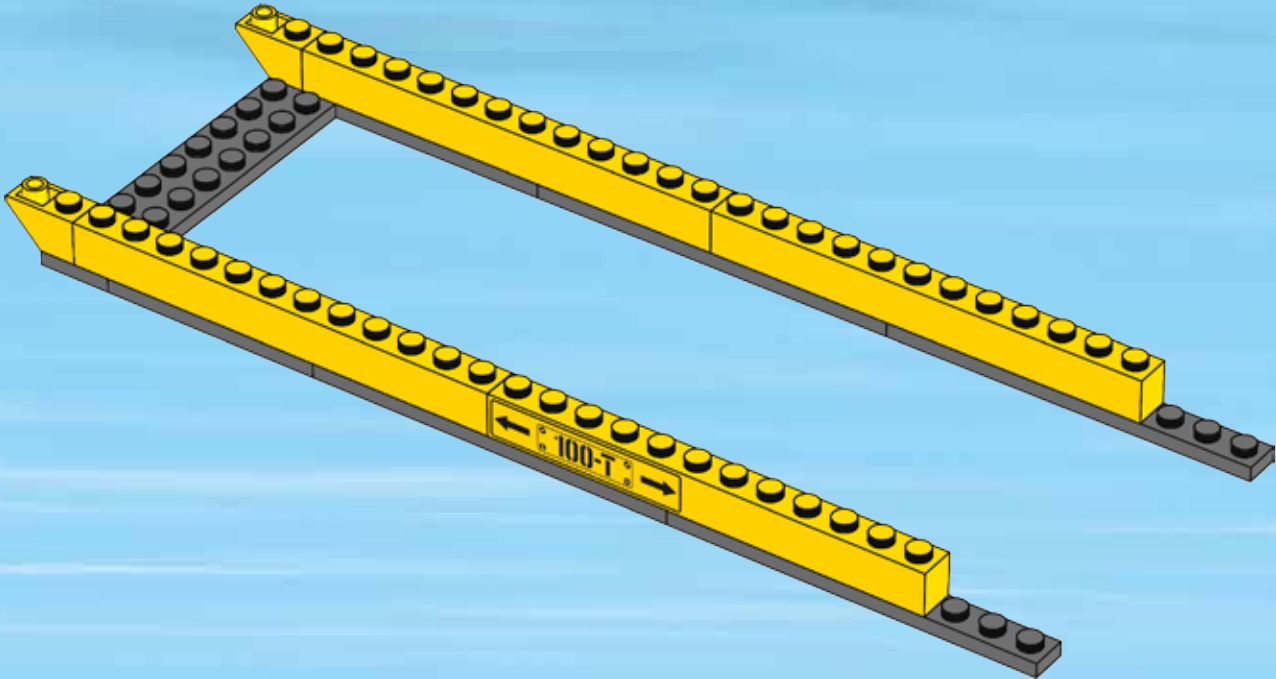



2x



2x

9

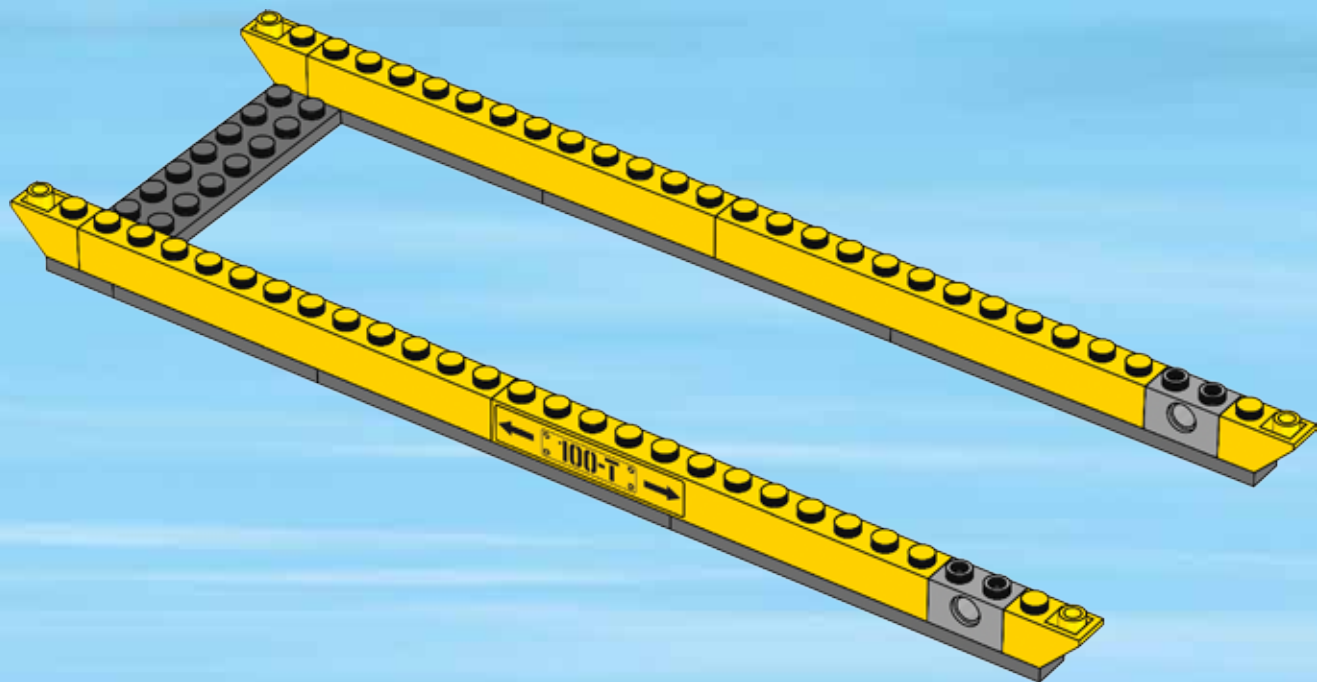



10

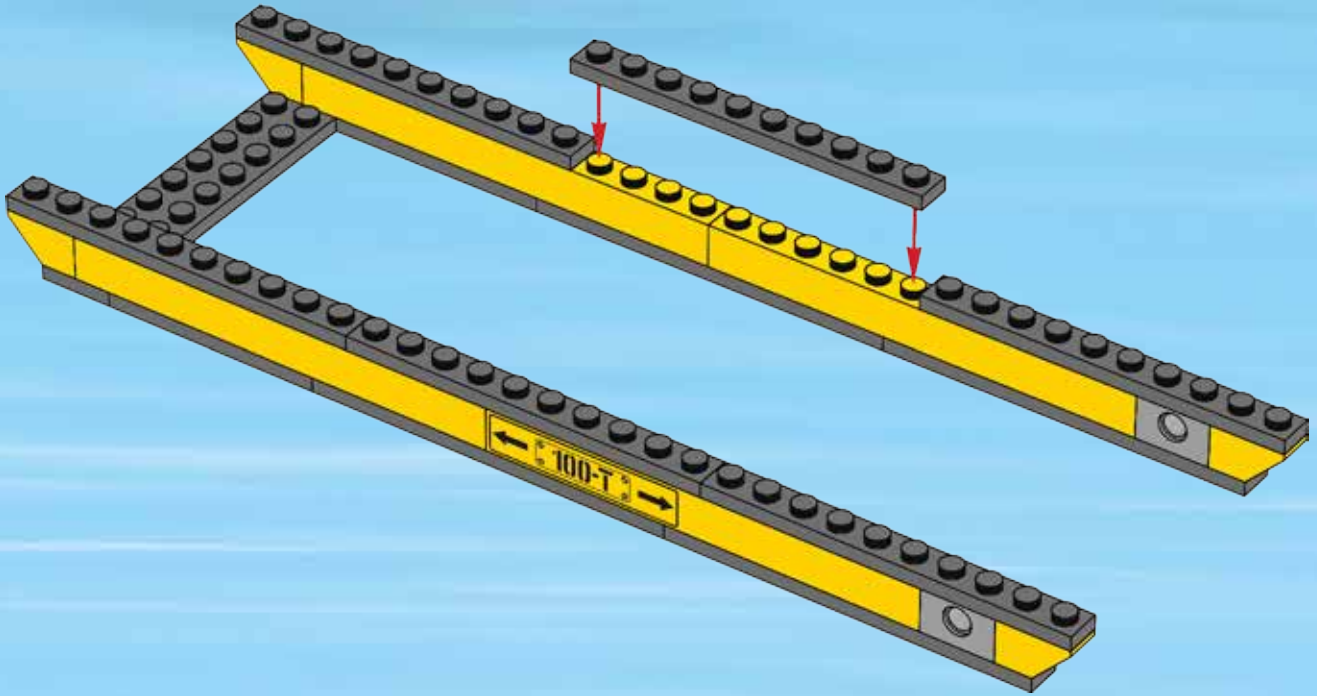

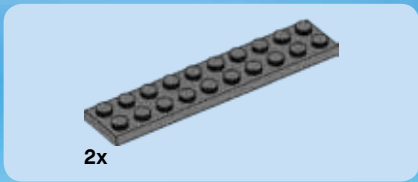

11



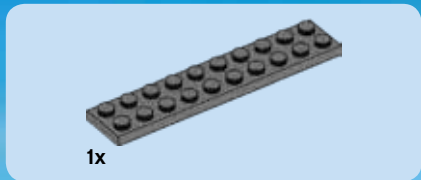

12



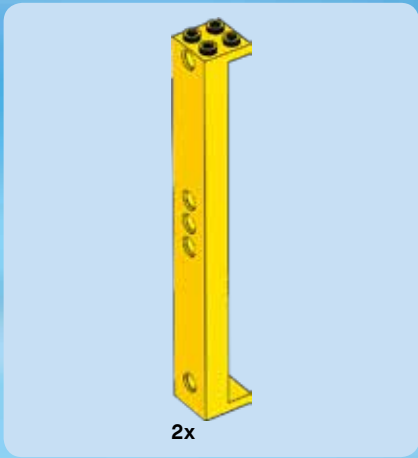

13



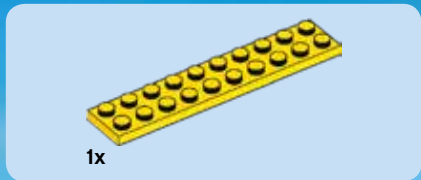

14

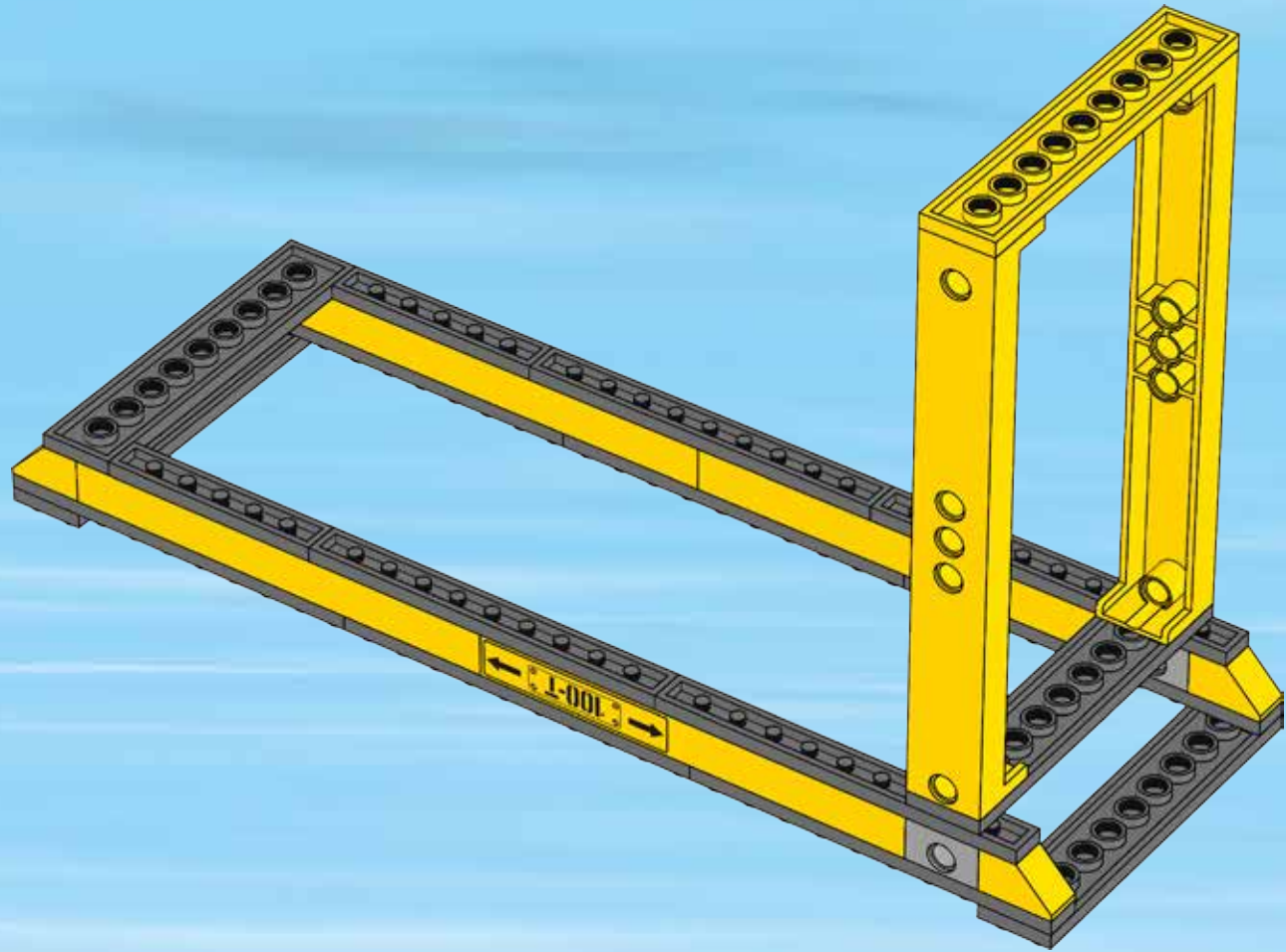



4x

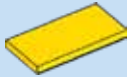

2x

15

1



2

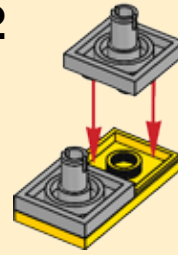

3



2x





4x



8x

16

1

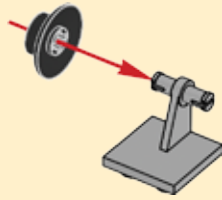

2



4x





2x

17

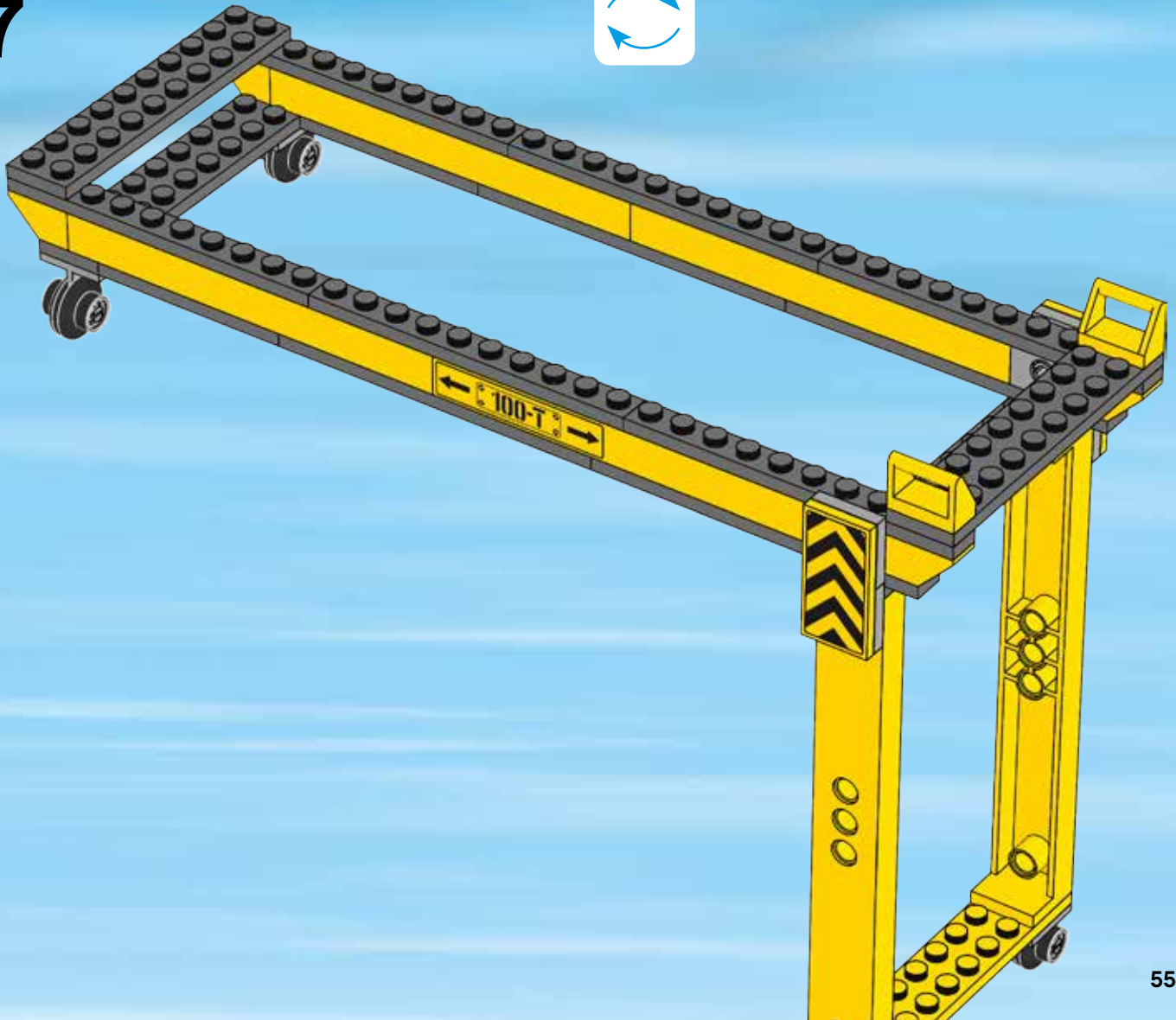



2x



2x

18

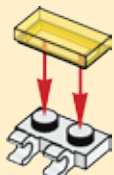

2x

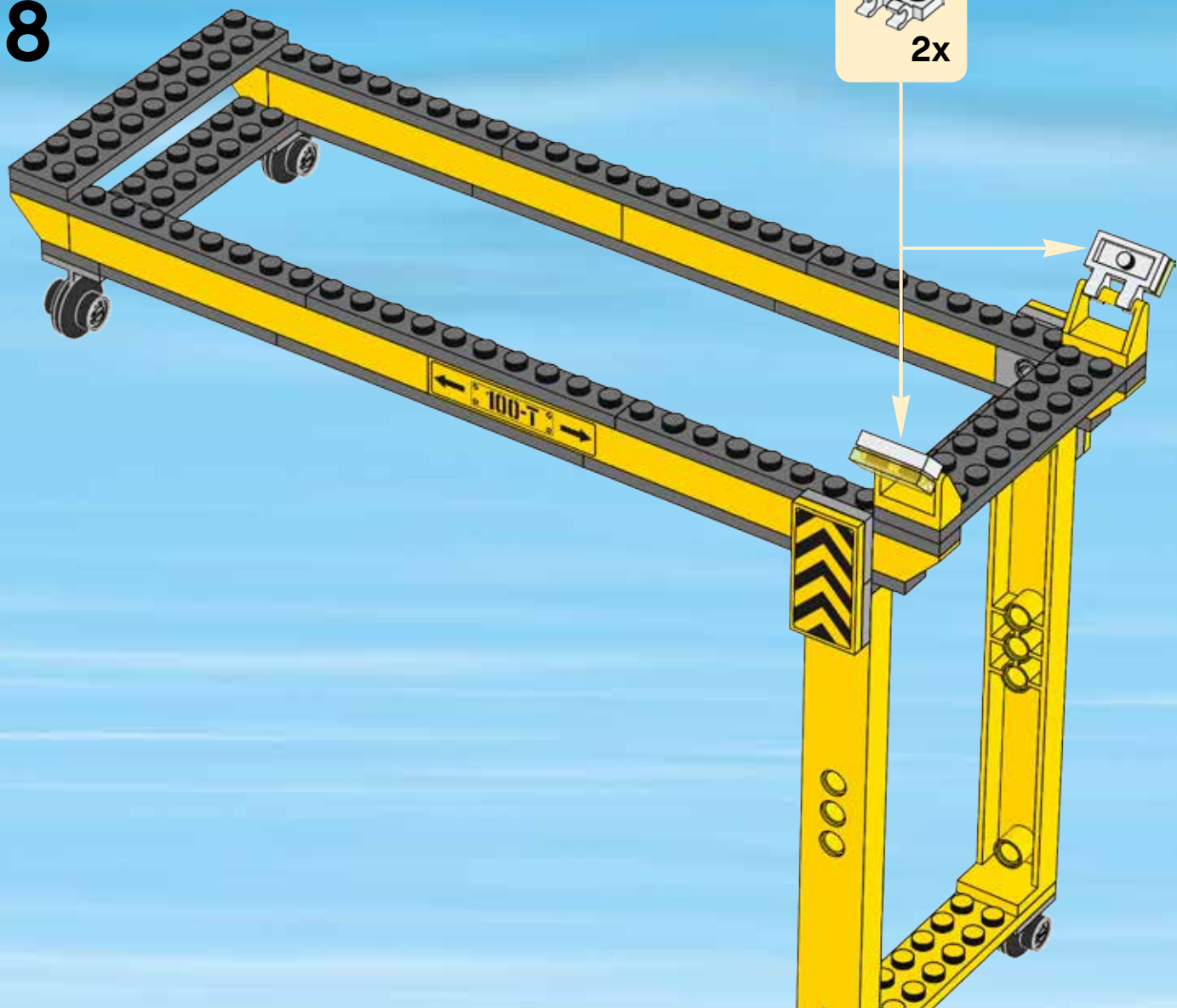

19

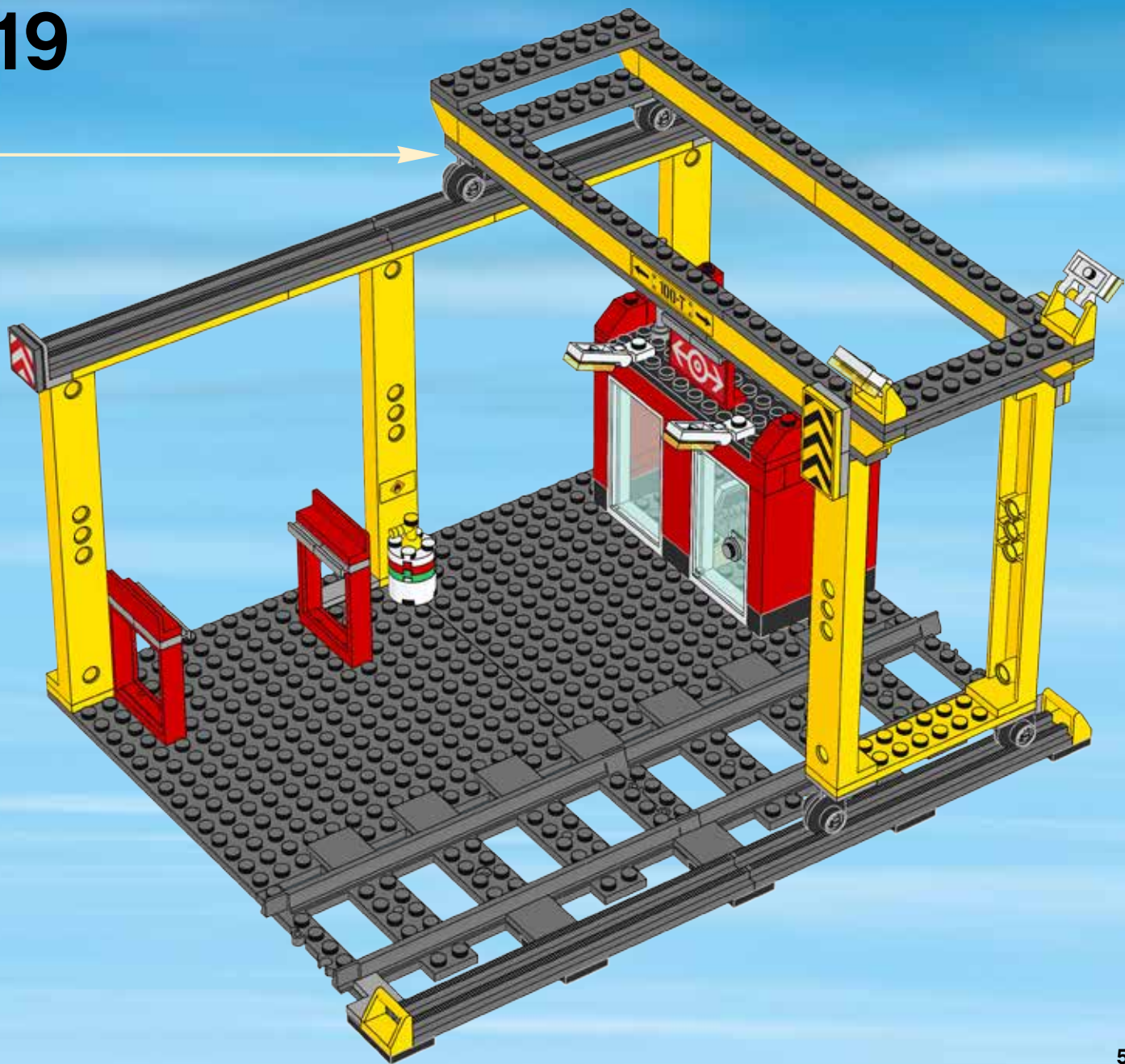



1x

1

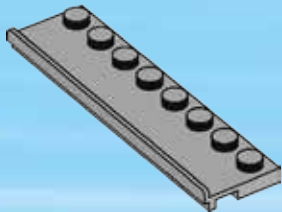

2x



1x

2

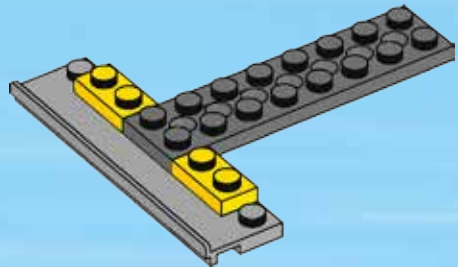

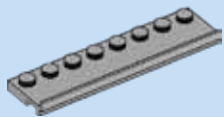

1x

3

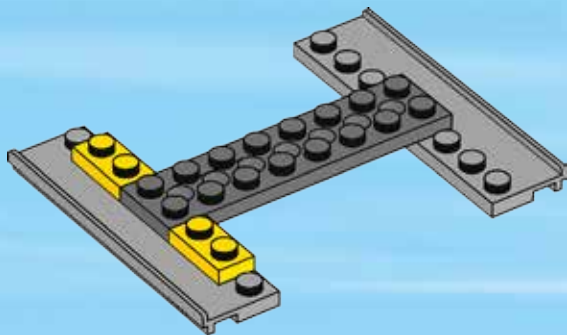

2x

4

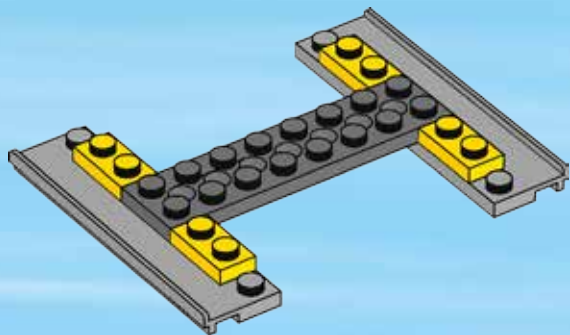



1x



1x

5

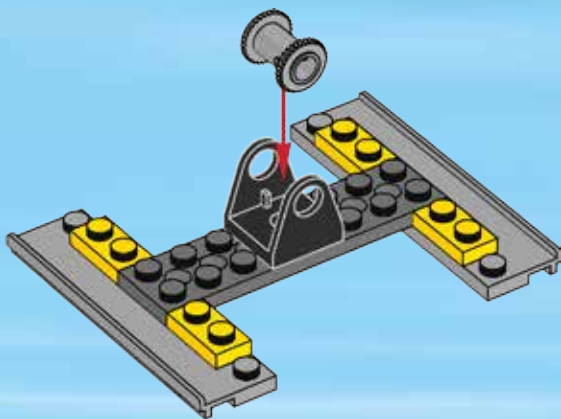

1x

6

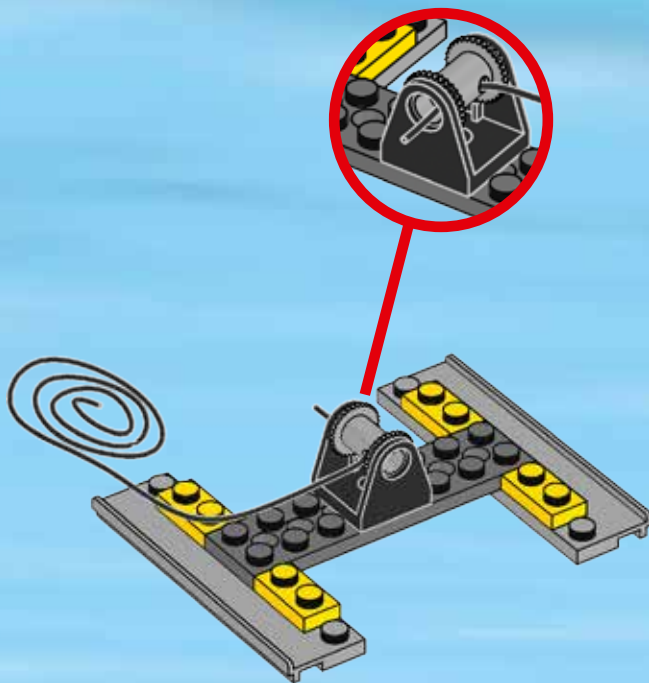



7

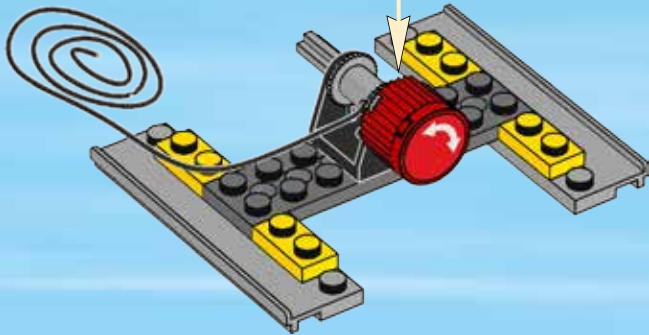
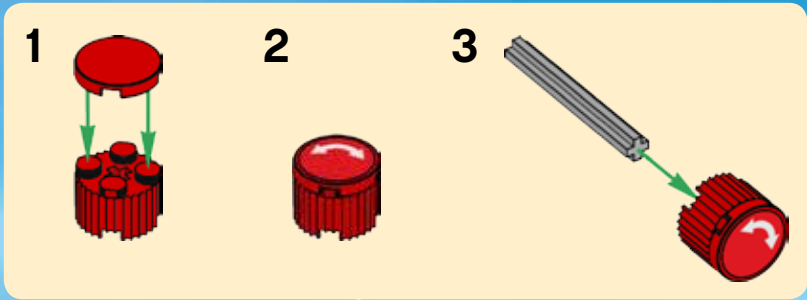



1x



1x

8

1



2

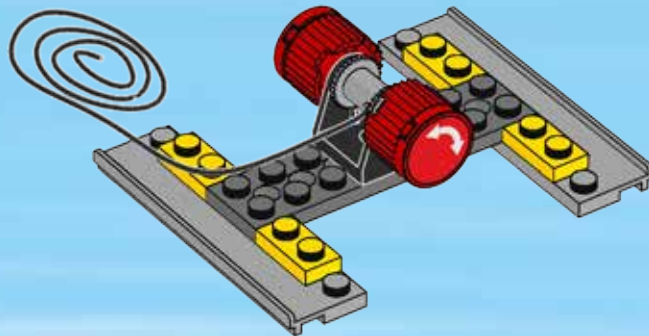

9

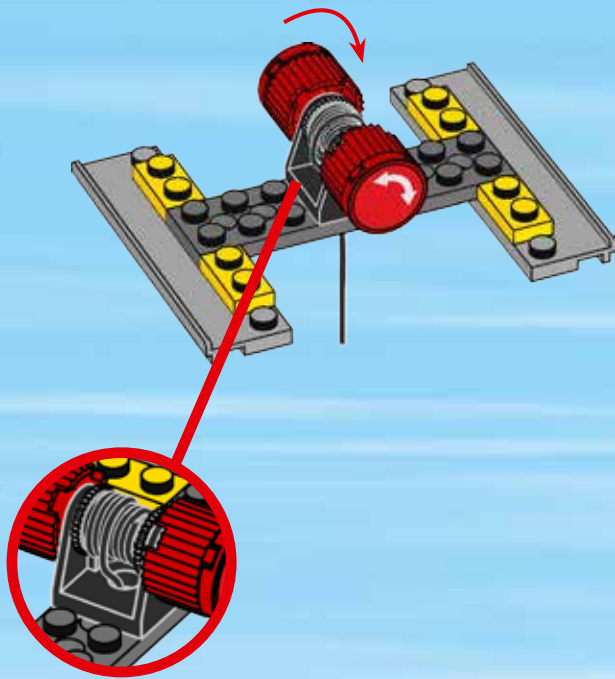

10

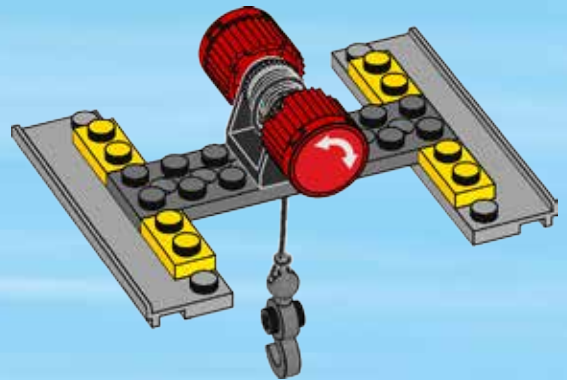



2x

11

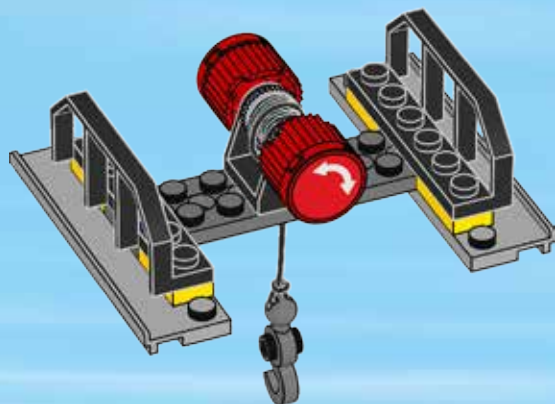

1x

12

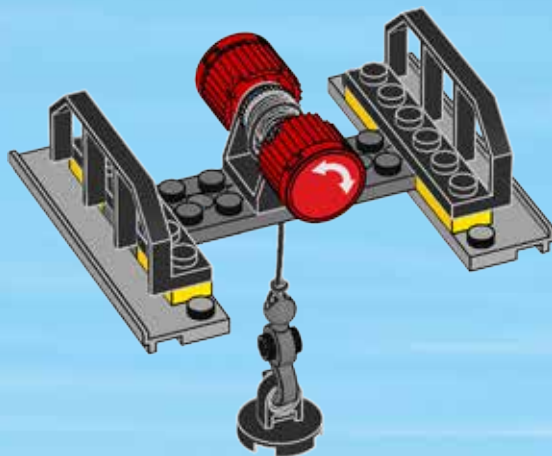

20

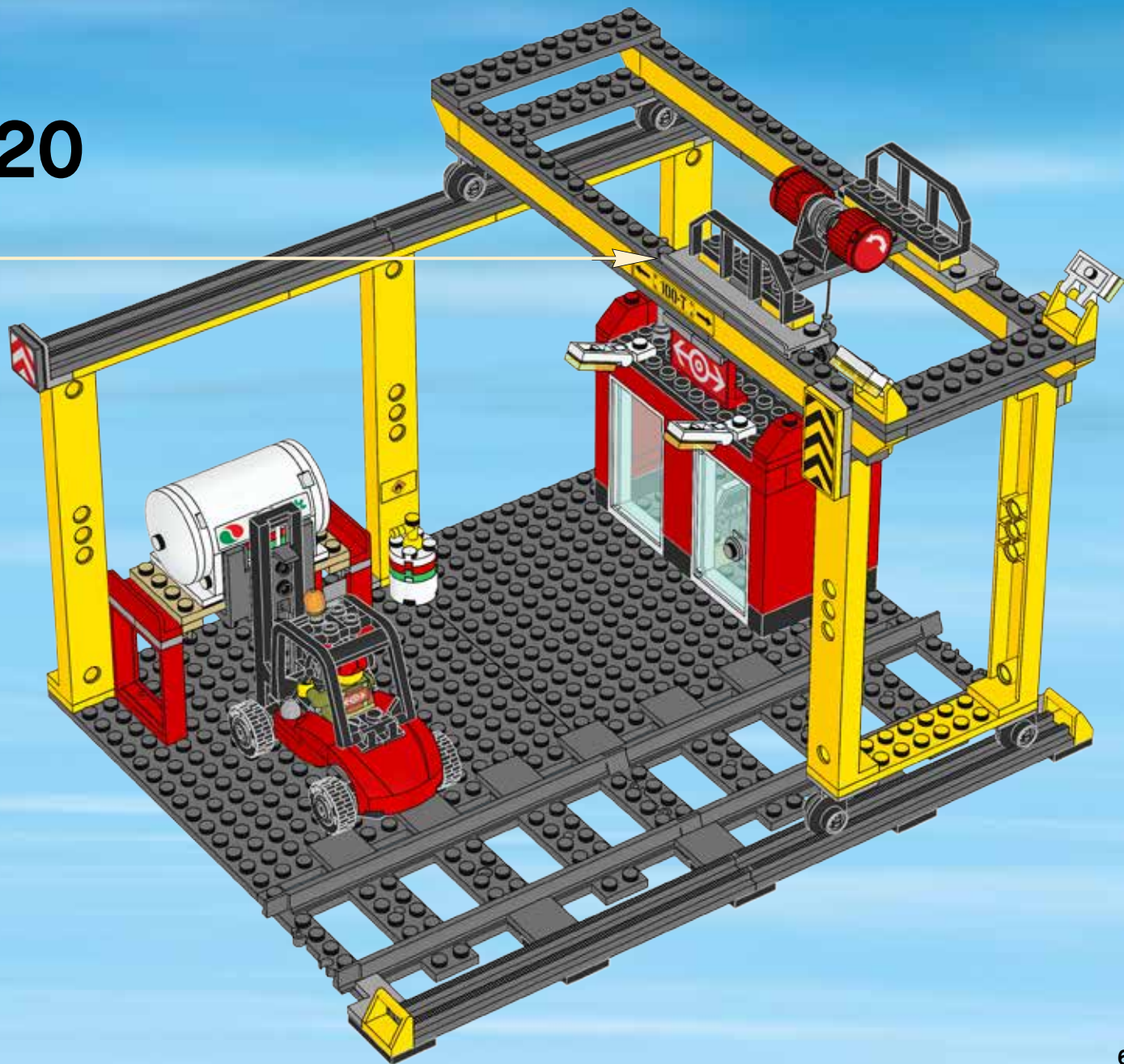



club™



10x 4298979
5x 614301
2x 4538353
1x 4293350
2x 4262011
2x 4556152
1x 4289304
1x 306901
8x 302201
2x 243101
2x 302001
2x 617901
2x 4541956

2x 4515364
1x 6089574
1x 614101
1x 403201
2x 4515347
2x 396001
1x 4163987
1x 6061047
1x 4658973
2x 6032360
1x 4544140
1x 4114306
4x 4509897

1x 4114319
6x 6024495
5x 4565387
9x 4113233
1x 300421
1x 4212414
3x 301021
2x 4558886
2x 4650646
1x 370021
2x 4121934

2x 6057432
2x 242021
6x 362321
3x 371021
2x 366621
1x 6061711
2x 6066342
1x 403221
1x 4278275
2x 6046379
2x 4505067
2x 611221

2x 4262009
2x 302321
1x 6049737
1x 407921
1x 4540429
1x 383321
2x 6032178
1x 6003001
1x 389921
1x 249521
1x 6031520
1x 6016772

4x 302423
4x 300123
2x 300923
4x 302023
1x 4243815
2x 416223
1x 303223
1x 303623
2x 6072638
2x 6058179

4x 362223
4x 6072680
2x 4212411
6x 6072633
2x 300523
4x 4509443
2x 4649773
4x 4651237

1x 6072637
1x 6072636
1x 6071445
1x 4548877
2x 371023
4x 4206482
1x 306923

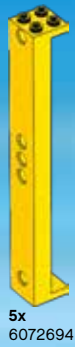

5x
6072694



3x
287724



3x
4164073



4x
4504381



4x
366524



4x
302324



3x
302224



4x
4251468



4x
383224

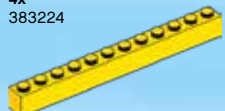

4x
4271082

68



1x
6021675



1x
6018620



1x
6022354



1x
4651443



1x
389924



2x
286624



8x
243224



1x
4256320



1x
407924

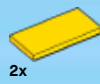

2x
4560181



5x
6051861



1x
6031790



4x
273026



2x
300426



1x
300226



4x
301026



3x
300126



2x
300926



16x
4567436



2x
4548180



6x
6069000



4x
6053077



1x
4613153



4x
307026



1x
379426



2x
302326

3x
302226



4x
4558170



5x
302126



1x
371026



1x
302026

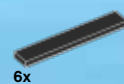

6x
663626



18x
4541191



1x
6035530



1x
4124096



1x
258426



8x
4621116

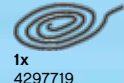

1x
4297719



1x
4140801



4x
4188953



13x
658326



2x
4140303



1x
6036006



1x
4516843



4x
4617848



4x
4568644



1x
249626



4x
6092658

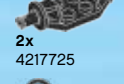

2x
4217725



2x
73081



2x
4648117



8x
4515350



6x
366626



2x
617926



1x
4539385



8x
4295370



20x
4496343

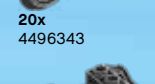

10x
287826

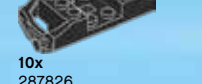

4x
4493326



4x
4493326

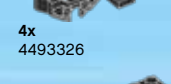

4x
4286009



2x
4589489



2x
4589489

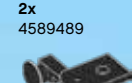

6x
4589495



2x
303426



2x
447726

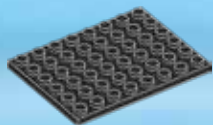

1x
303626



1x
303026

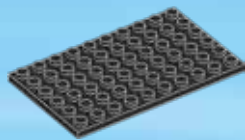

1x
303326

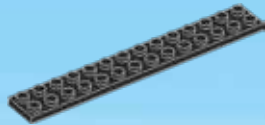

1x
6001494

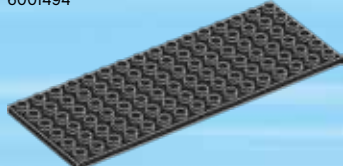

1x
302726

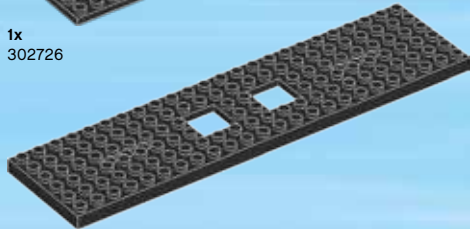

1x
6016487



8x
4517925



4x
4598528



4x
4107761



2x
4183043



2x
4183060



2x
6010831



1x
4531412

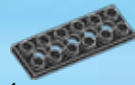

1x
3200126

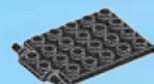

1x
6057903



1x
4567908



3x
4111844



2x
4187334



2x
4121969



2x
4142717



10x
302328



2x
371028

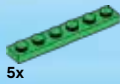

5x
366628



3x
370526

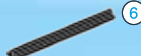

4x
370626



3x
4218868



1x
4584375



3x
379528



1x
403228



1x
4567914



1x
4567918



1x
4626650



1x
74040



1x
6032177



1x
6072605



1x
4503291



1x
4584375



4x
6022880



2x
4244362



3x
3005740



2x
3000841



2x
3005741



4x
4542673



1x
4524365



3x
4529685



1x
4520810



1x
6063576



1x
6022905



1x
4520866



2x
6074032



1x
6080721

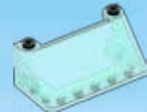

1x
4599455



4x
4194535



1x
4626884



2x
6076153



1x
4162916



1x
4654448

5x
6020073



6x
4654129



2x
6020074



1x
4211149



4x
4211150



5x
4211151



1x
4243838



2x
4263776



1x
6074310



2x
4211440



2x
4211752



7x
4211350

70



24x
6066097



4x
4565393



2x
6065824



1x
4558169



2x
4211356



4x
4560183



2x
4654580



12x
4556157



1x
4211639



1x
4512049



1x
6019910



2x
4211486

2x
4211486



2x
4221775



6x
4211568



4x
4237084



2x
6030711



4x
4211357

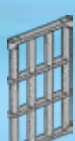

6x
4599496



2x
4211524



2x
4211524



2x
4211393



2x
4612621



2x
4211425



2x
4211425



2x
4222019

2x
4222019



1x
4211473



3x
4211525



1x
4227657



2x
4657366



4x
4211764



4x
4211516



1x
4211370



4x
4211758



2x
4512360



1x
4211085



1x
4211054



2x
4246896



2x
4648256



1x
4211063



4x
4565322



13x
4211055



12x
4568734



11x
4211001



2x
4211056



3x
4210651



4x
4211002



1x
4211115



1x
4211115



1x
4260707



1x
4210997



10x
4257526



4x
4210678

4x
4210678



3x
4611703



1x
6000606



2x
4543086



2x
4648067



1x
6020825



1x
4210631



4x
4210633



2x
4521886



1x
4520307



1x
4222693



4x
4210469



1x
6005463



2x
4260124



2x
4260124

1x
4212529

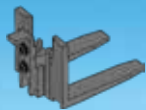

1x
6058407

1x
4211066



1x
4638959

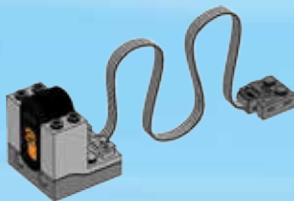

1x
6040157

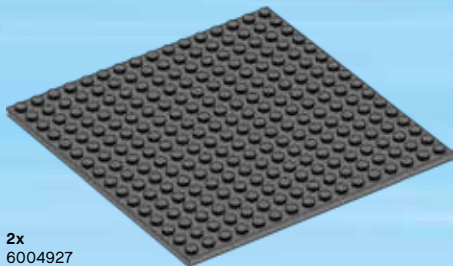

2x
6004927

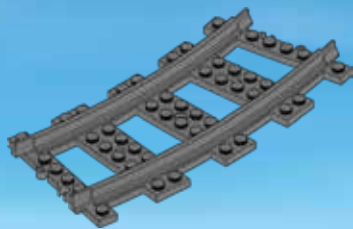

20x
4279717

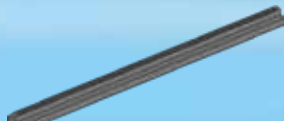

8x
4638990

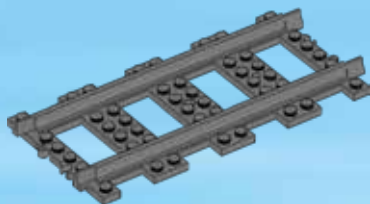

8x
6070018

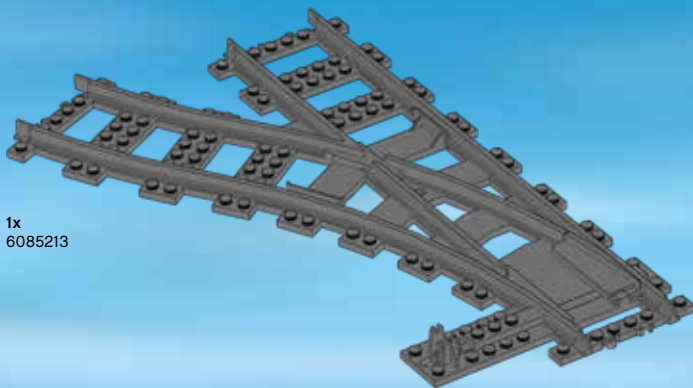

1x
6085213

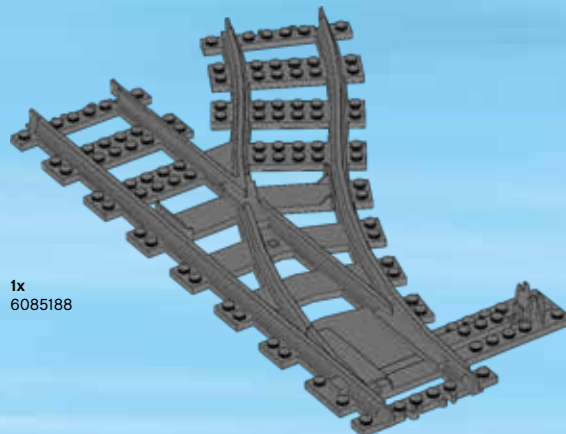

1x
6085188



Customer Service
Kundenservice
Service Consommateurs
Servicio Al Consumidor
LEGO.com/service or dial

: 00800 5346 5555
: 1-800-422-5346



60110



60109



60108



60107



60106



60105