



# ELVES

41192



[LEGO.com/elves](http://LEGO.com/elves)



1



2

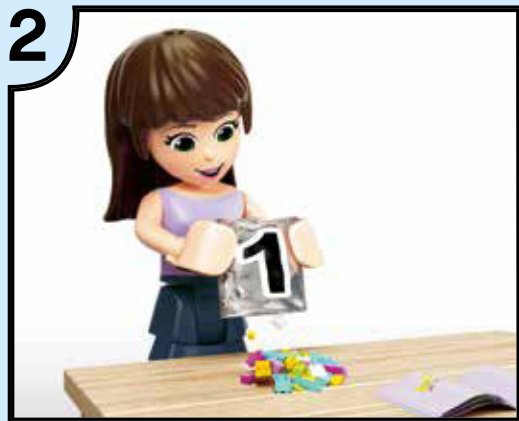

3

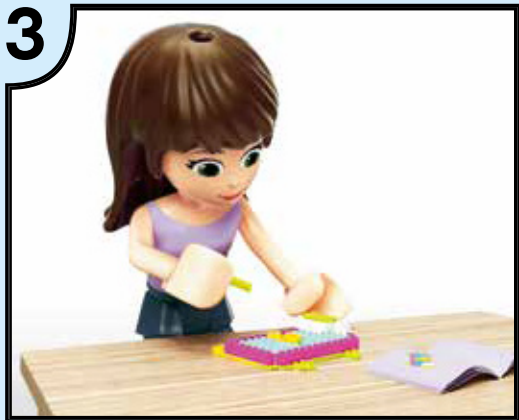

4



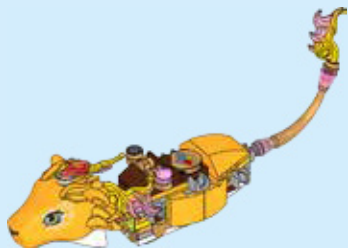
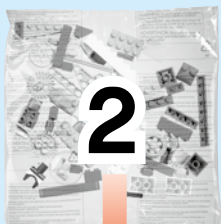

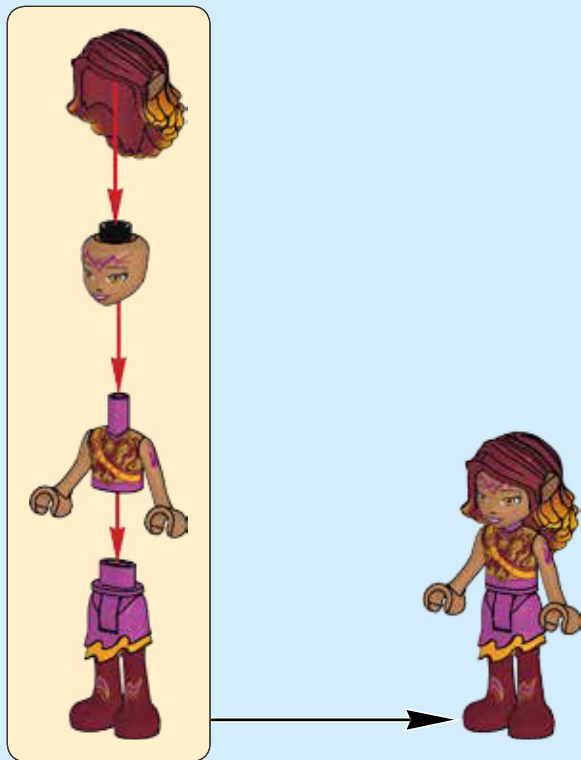
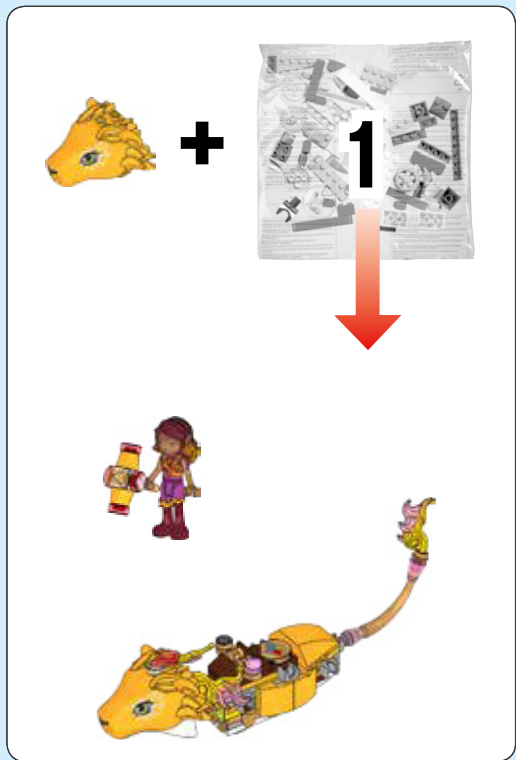

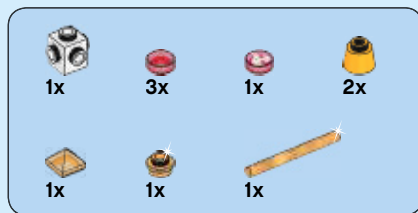

**1**

**1**



**2**

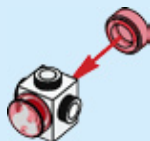

**3**



**4**



**5**

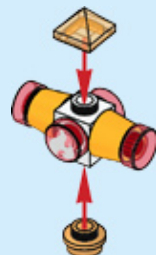

**6**



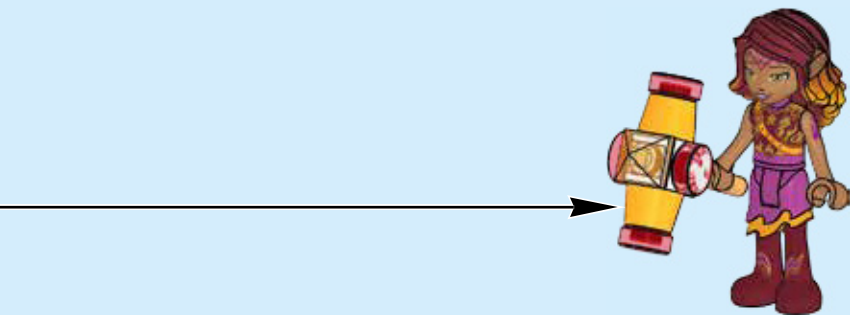

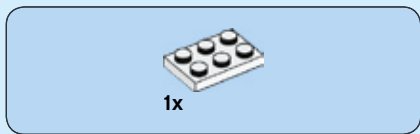
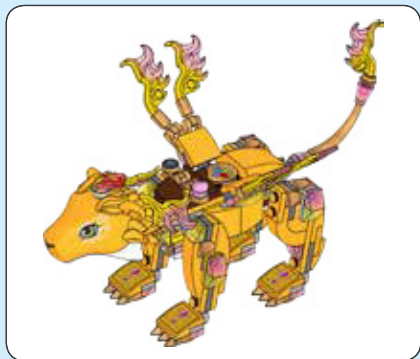

**1**

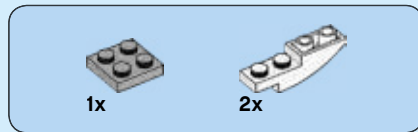

**2**

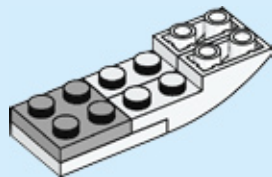



1x



2x

3

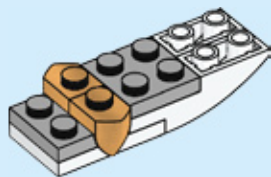

2x

4

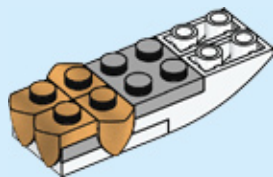





1x



2x

5

1



2

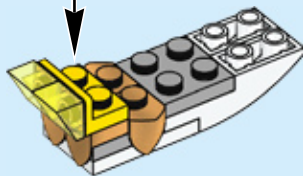

1x

6

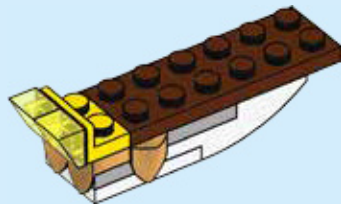



1x

7

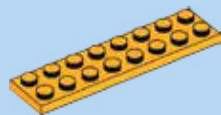
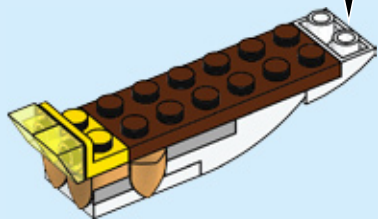
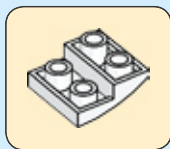

1x

8

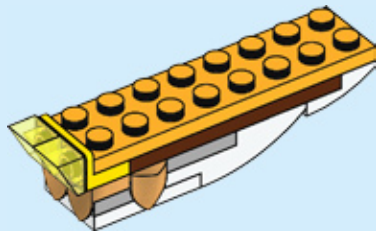



1x



4x

9

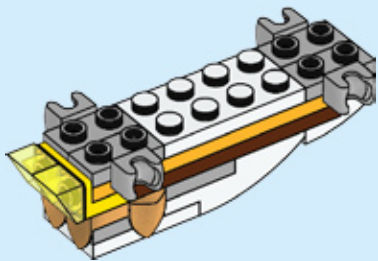

1x



1x

10

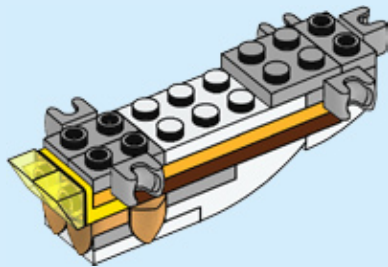



# 11

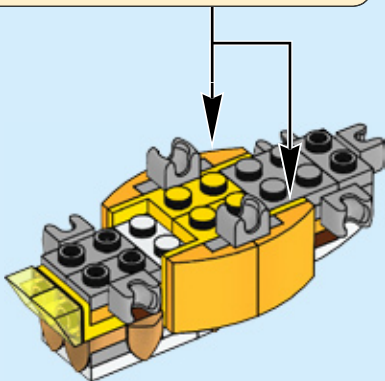



1x



1x

# 12

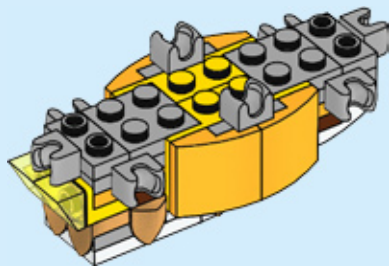

1x



1x



1x



1x

# 13

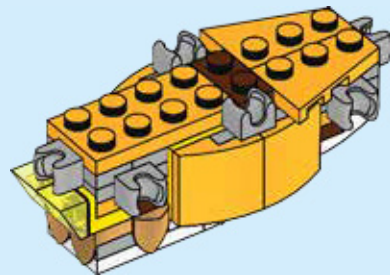



14

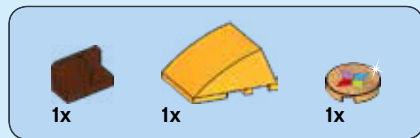
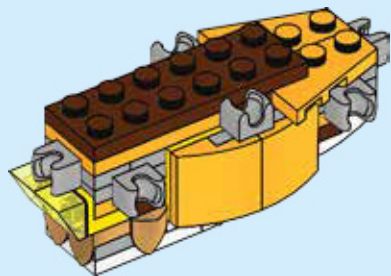

15

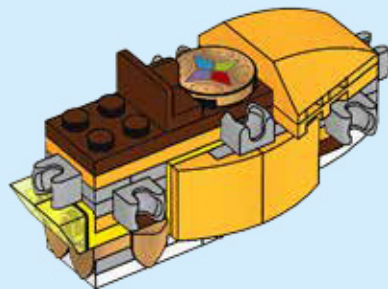



1x



2x

# 16

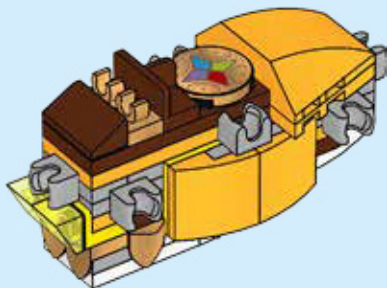

1x

# 17

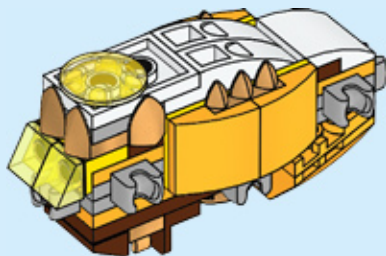
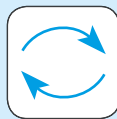

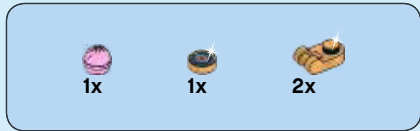

18

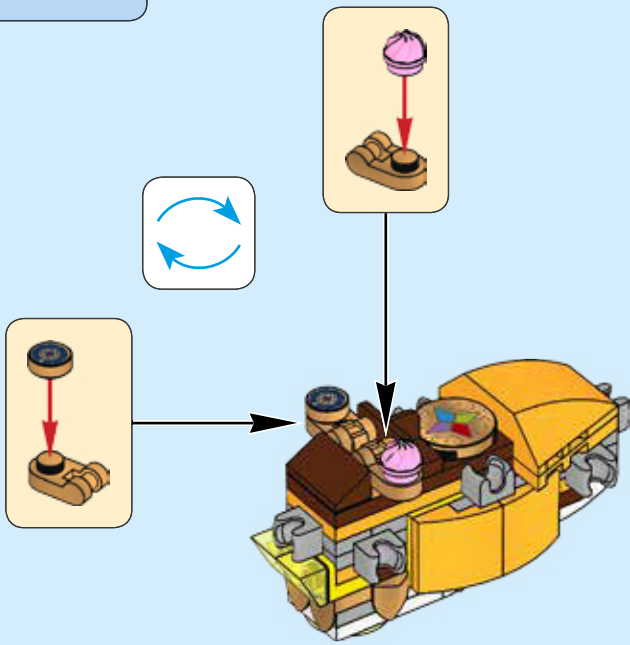



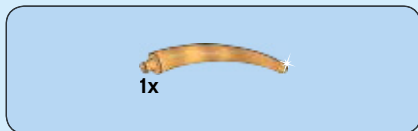

1x

19



2x

20





21

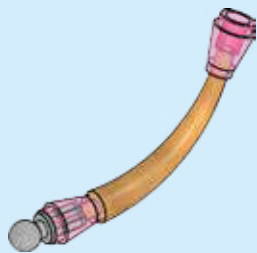

22

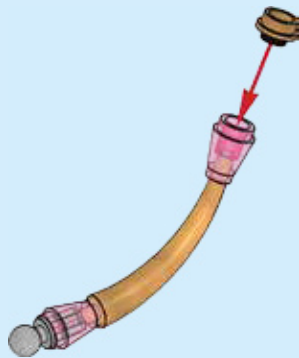

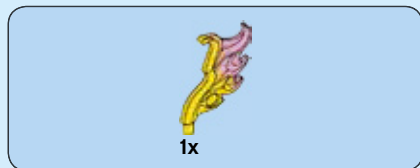

23



24

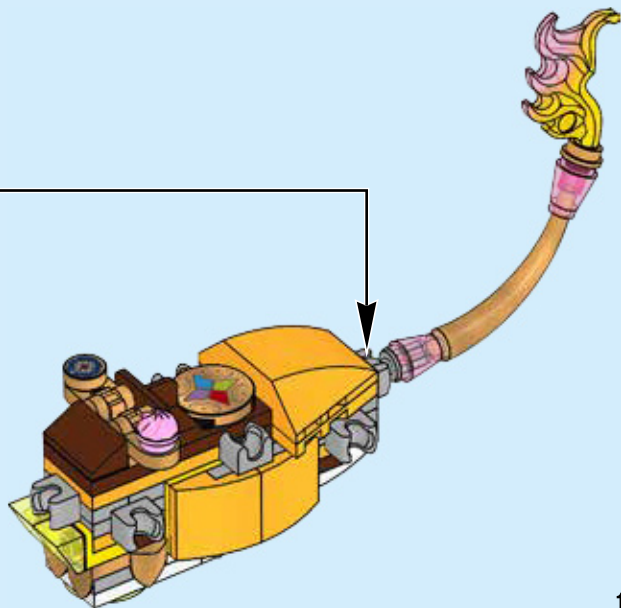



# 25

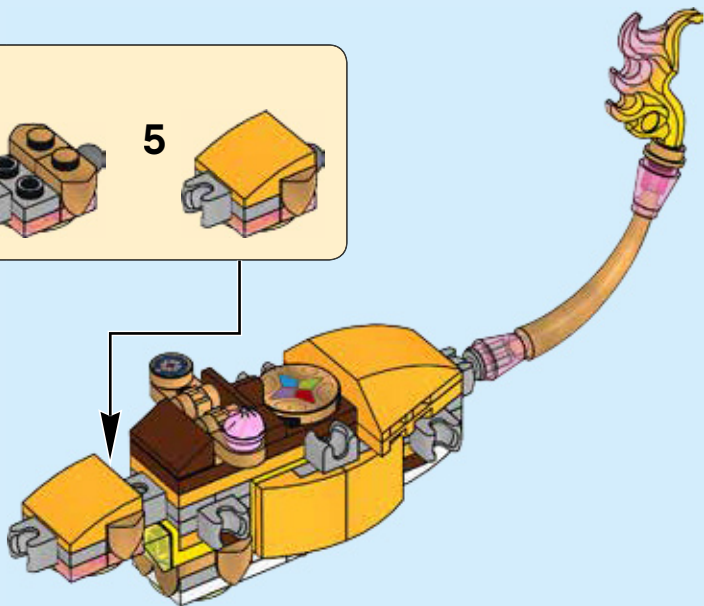



26

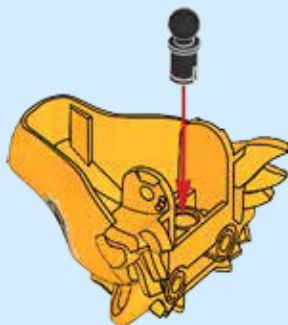



1x

27

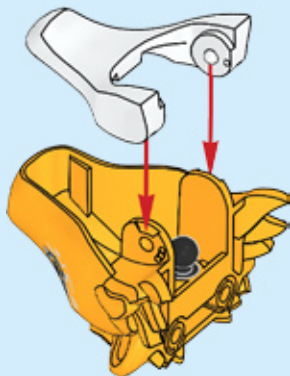

22



1x

28

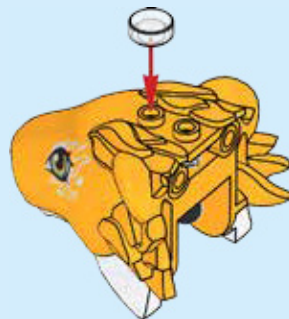
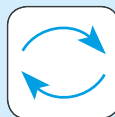



1x

29

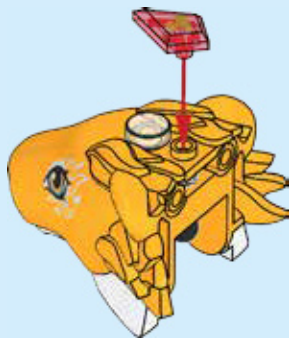

2x

30

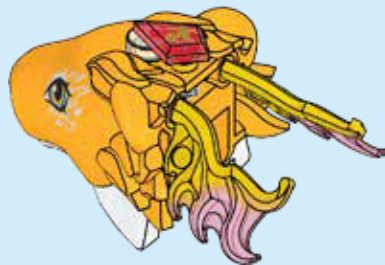

31

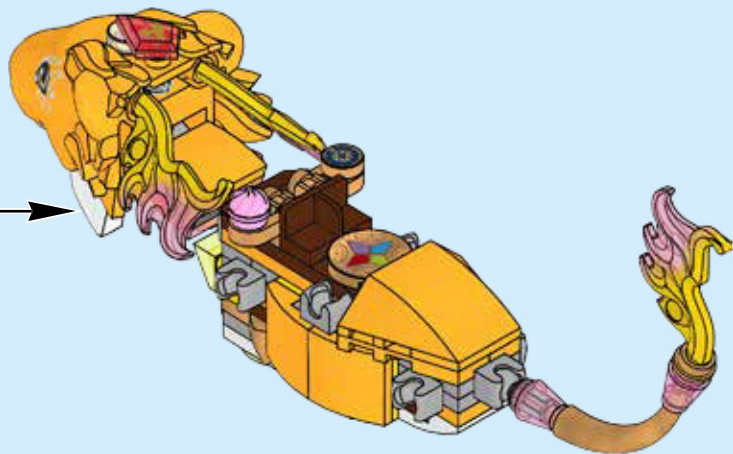



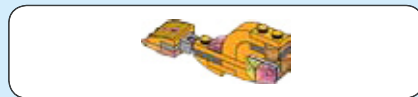

32

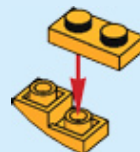



1x

# 33

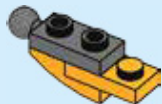

1x



1x

# 34

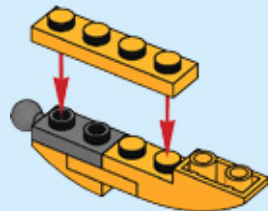

1x

# 35





# 36

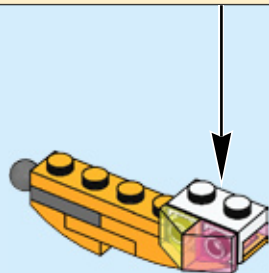

# 37

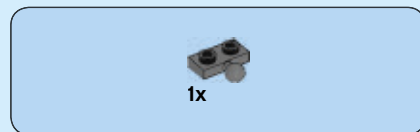

# 38

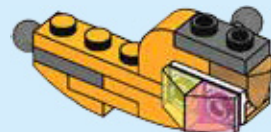



39

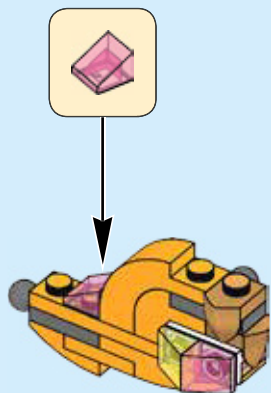

40





# 41

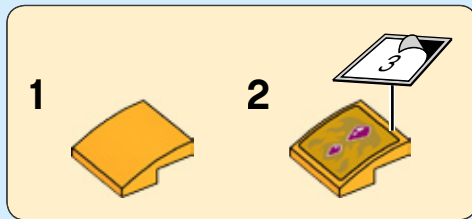

1



2



3

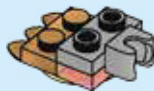

4

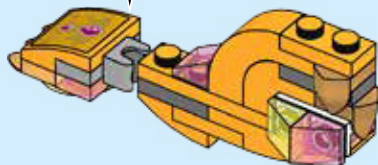

42

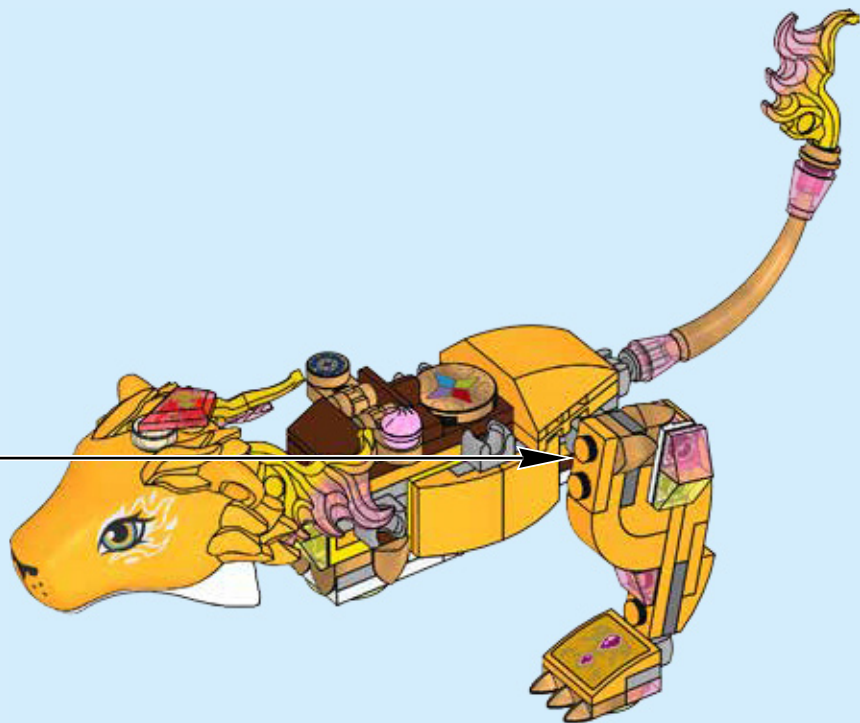

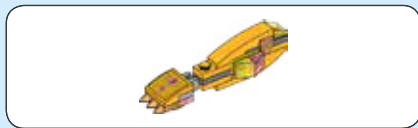

43



44

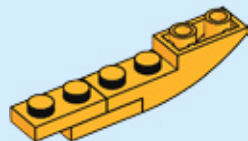

45

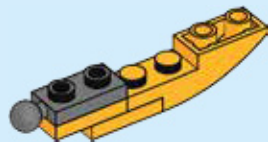



46

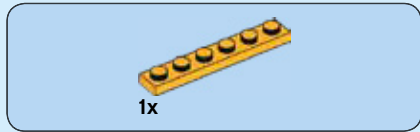
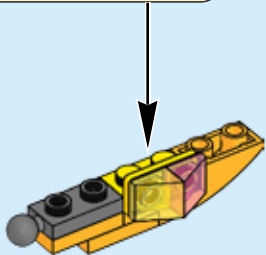

47

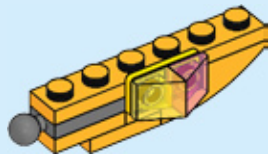





48

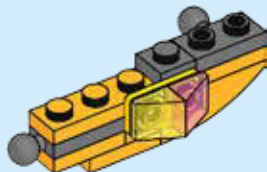

49

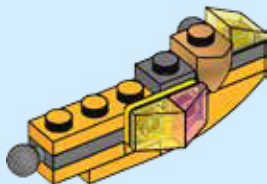

50

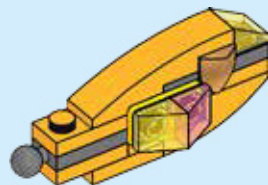



51

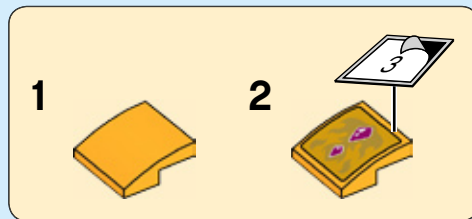

1



2



3



4

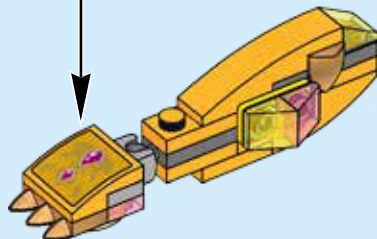

52

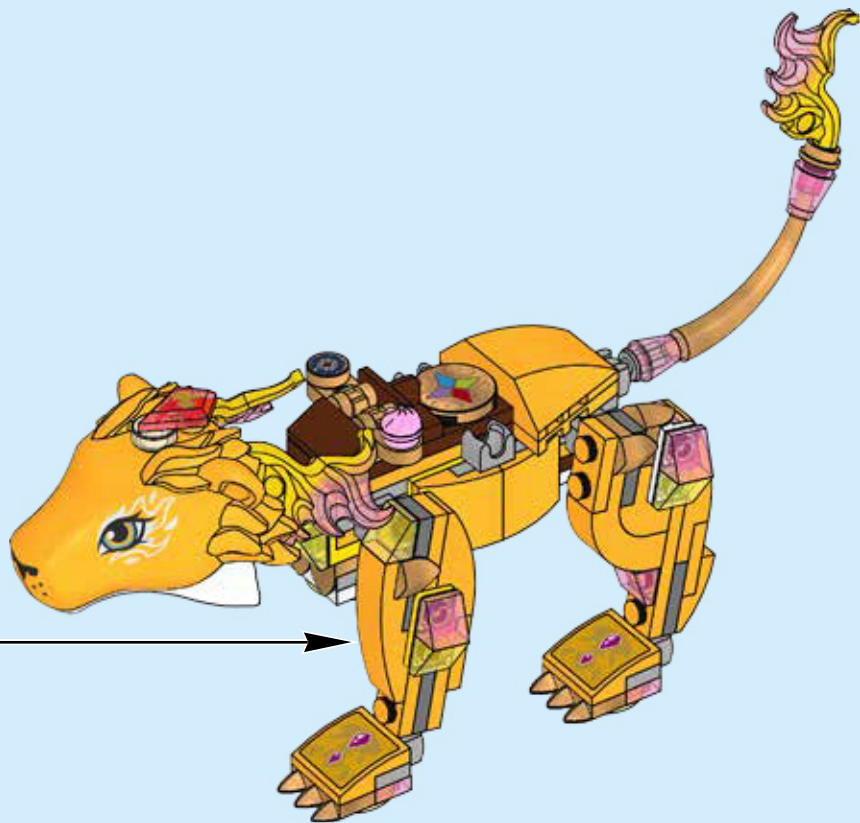



53

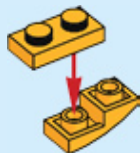

54

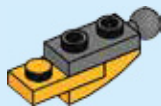

55

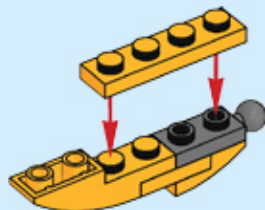

56





57

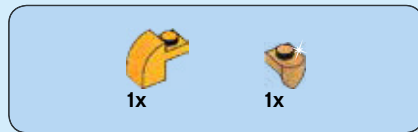
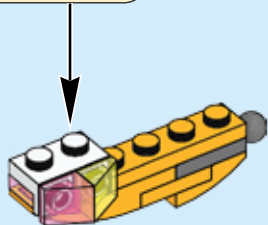
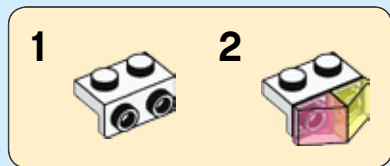

58



59





60

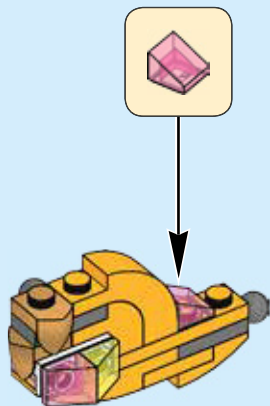

61





# 62

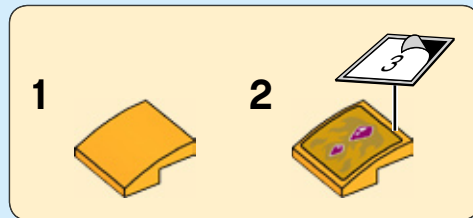

1



2



3



4

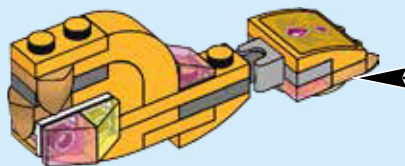

63

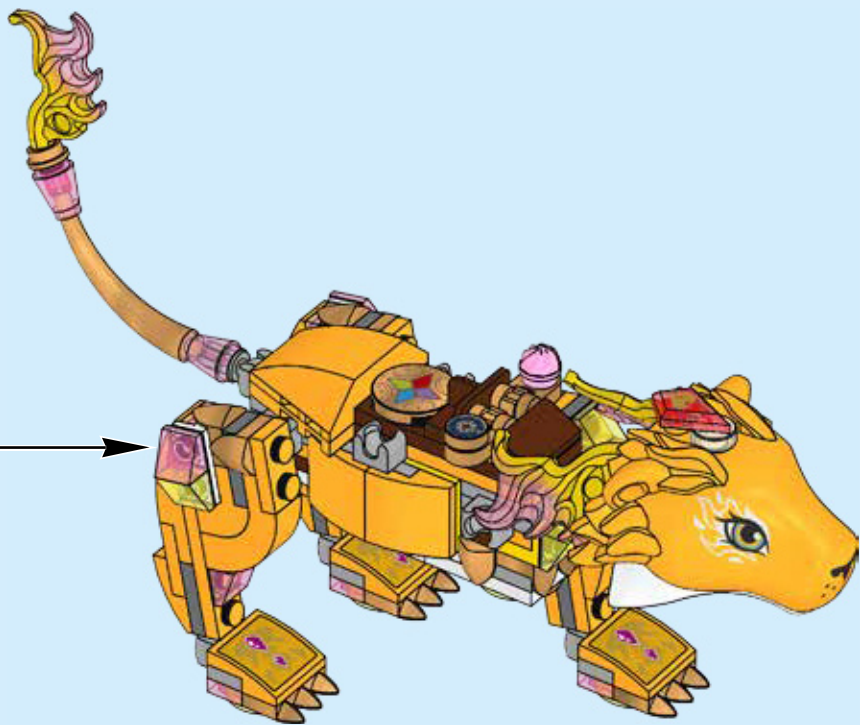
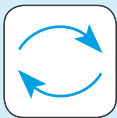





64



65

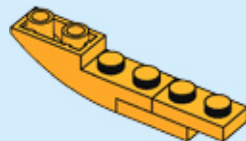

66

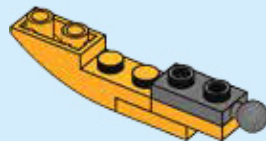



1x



1x



1x

# 67

1



2

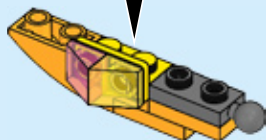

1x

# 68

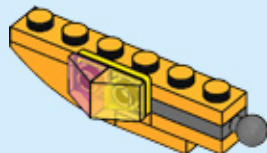



1x



1x

# 69

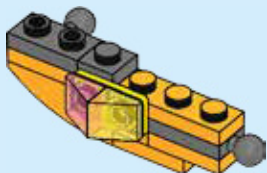

1x



1x

# 70

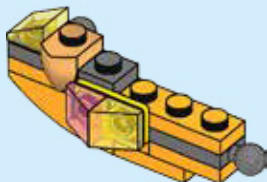

1x

# 71

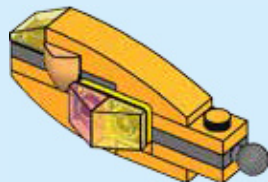



72

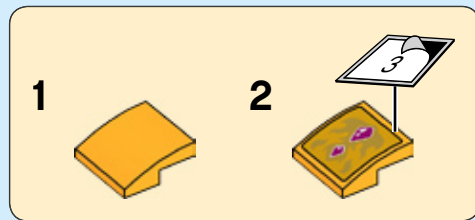

1



2



3

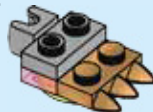

4

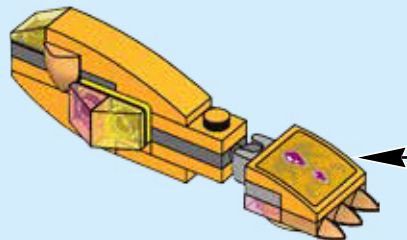

73

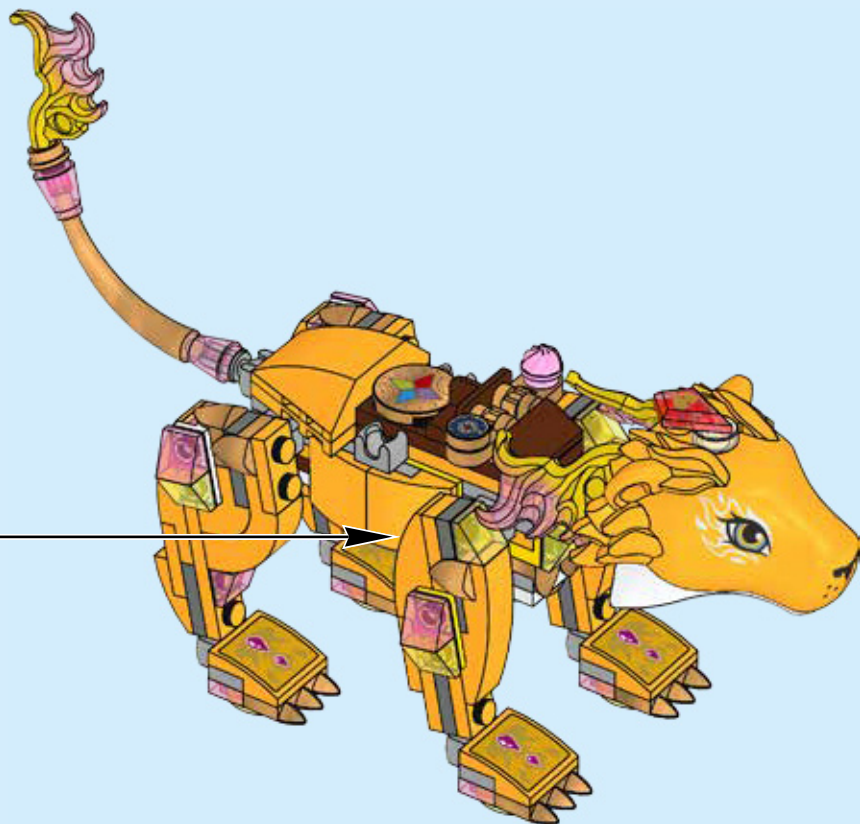



2x



2x



2x



4x



2x



2x

# 74

1



2



3



4



2x

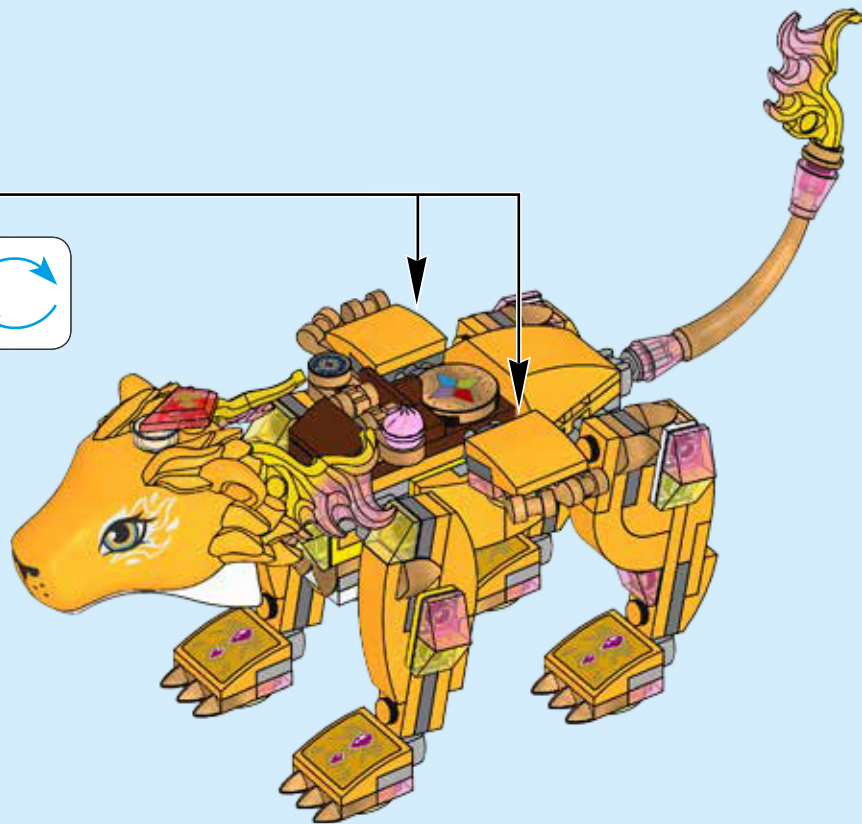
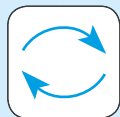



4x



4x

# 75

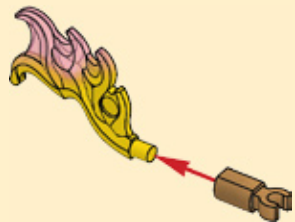

4x

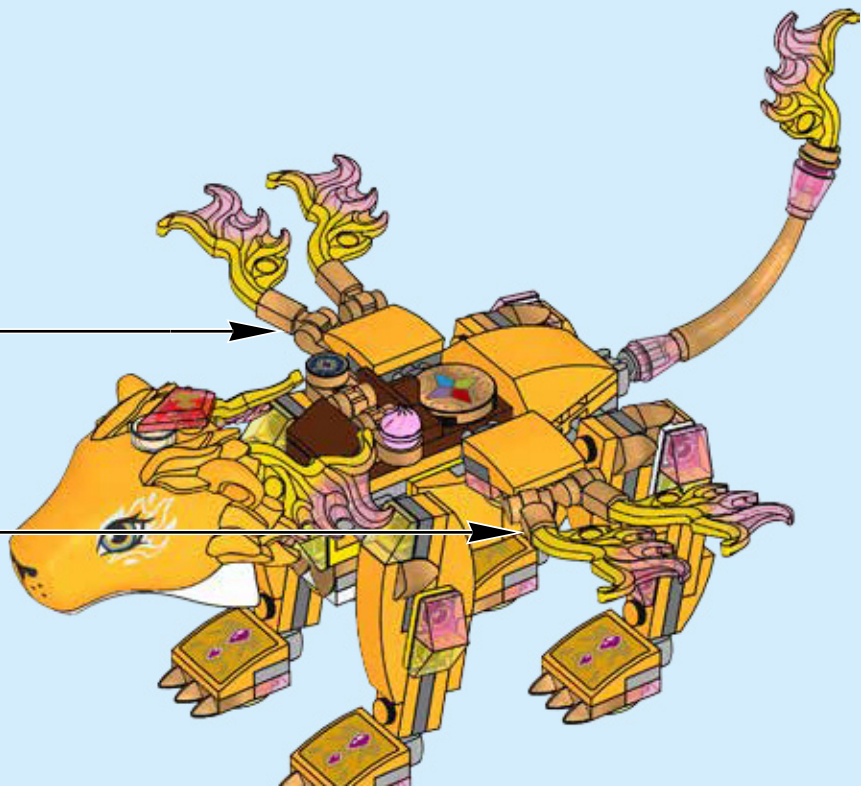



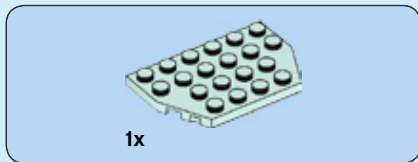

**1**

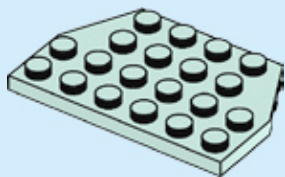

**2**

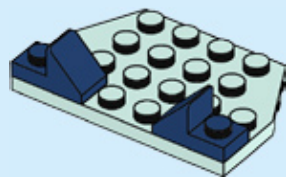

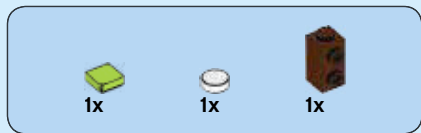

3



4



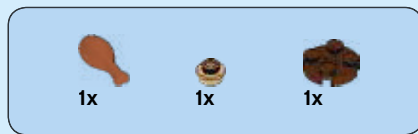

5

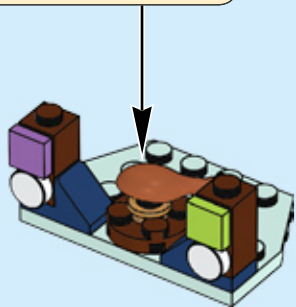
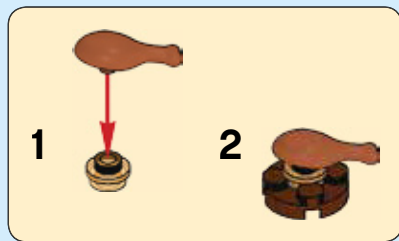

6

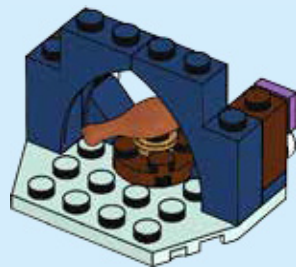
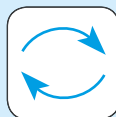



2x

7

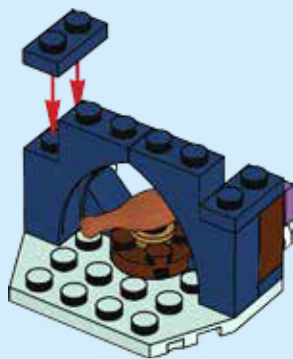

1x

8

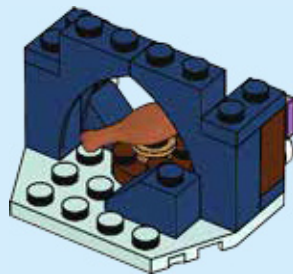



1x



1x



1x

# 9

1

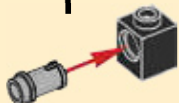

2

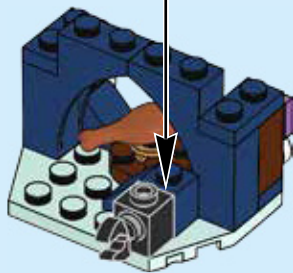

1x



2x

# 10

1



2

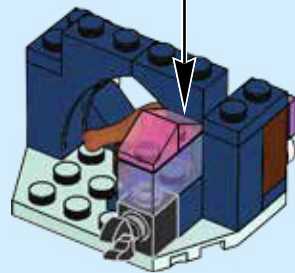



11

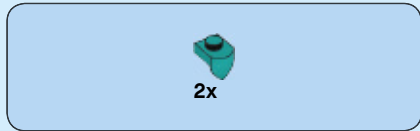
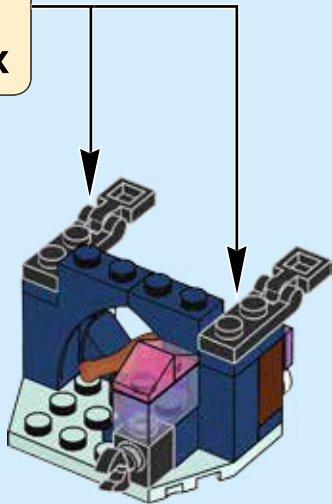
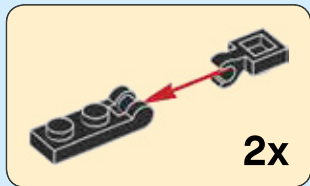

12

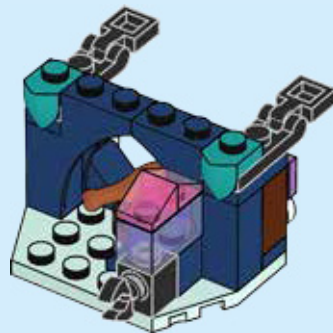



13

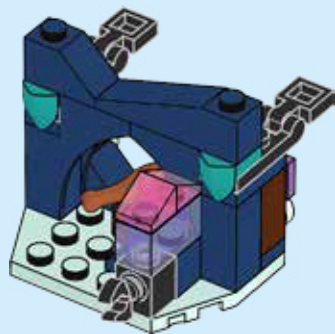

14

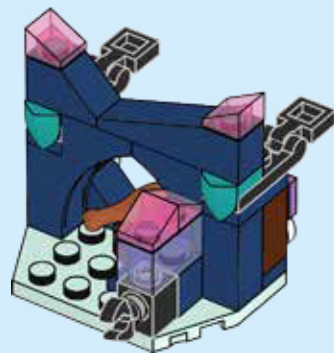

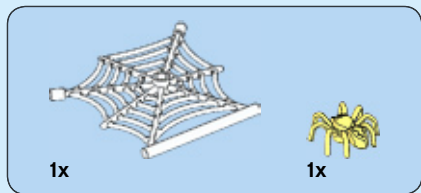

15

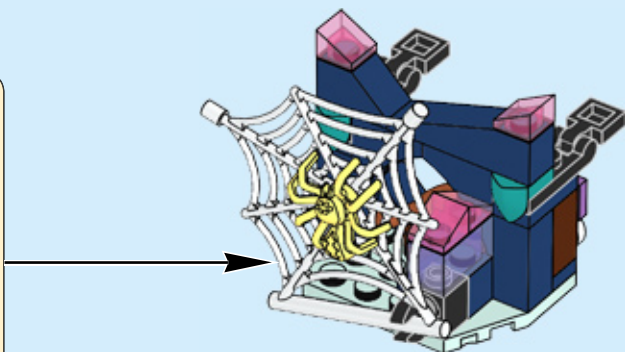
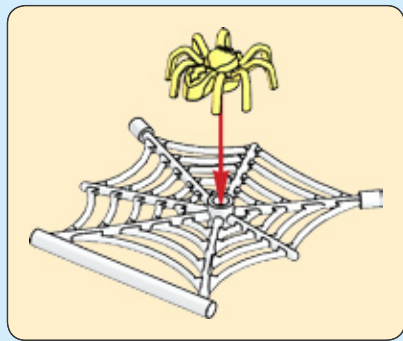





1x

16

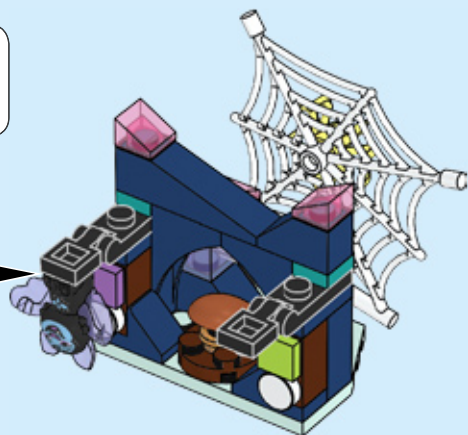
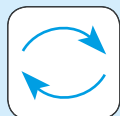

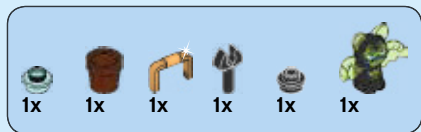

17



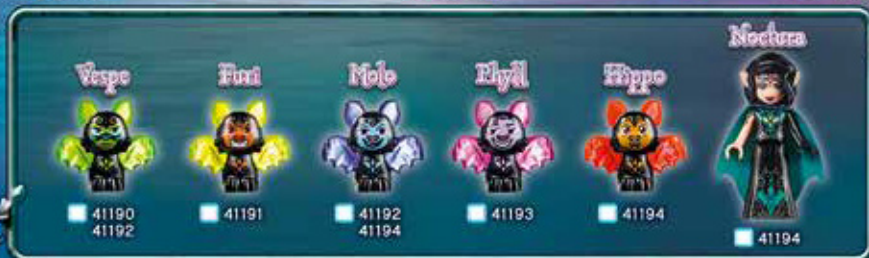
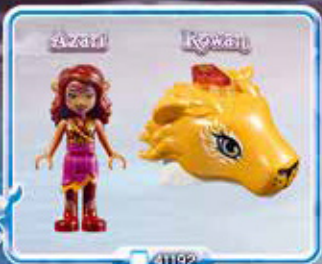

# WIN

GO TO [WWW.LEGO.COM/PRODUCTFEEDBACK](http://WWW.LEGO.COM/PRODUCTFEEDBACK) AND  
GIVE US YOUR SHORT **FEEDBACK** ABOUT THIS  
LEGO® SET FOR A CHANCE TO WIN  
A COOL LEGO PRIZE.

Terms & Conditions apply



## LEGO.com/productfeedback

### GEWINNE

Erzähle uns auf  
[www.LEGO.com/productfeedback](http://www.LEGO.com/productfeedback)

etwas über die Erfahrungen, die du mit  
diesem LEGO® Set gemacht hast, und  
sichere dir die Chance auf einen coolen  
LEGO Preis!

Es gelten die Teilnahmebedingungen

### GAGNE

Rends-toi sur  
[www.LEGO.com/productfeedback](http://www.LEGO.com/productfeedback)

et donne-nous quelques commentaires sur  
ce produit LEGO® pour avoir une chance  
de gagner un prix LEGO !

Voir Conditions Générales

### GANAN

Visita  
[www.LEGO.com/productfeedback](http://www.LEGO.com/productfeedback)

y envíanos tu opinión acerca de este set  
LEGO®. ¡Participarás en el sorteo de un  
premio LEGO!

Términos y Condiciones aplicables

### 获取奖品

登录  
[www.LEGO.com/productfeedback](http://www.LEGO.com/productfeedback)

给出关于此乐高®套装的简短反馈，  
就有机会获得炫酷乐高奖品

《条款及条件》适用

LEGO and the LEGO logo are trademarks of the LEGO Group. ©2018 The LEGO Group.

6232289



# ELVES

41192



[LEGO.com/elves](http://LEGO.com/elves)



3

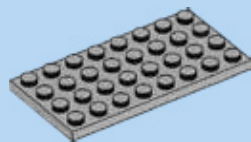
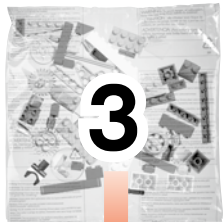

1x

1

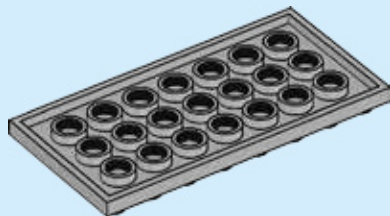



4x

2

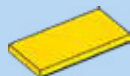
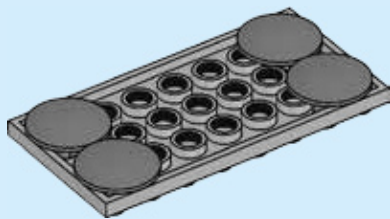

2x



2x

3

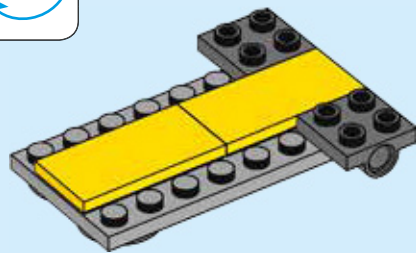
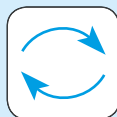

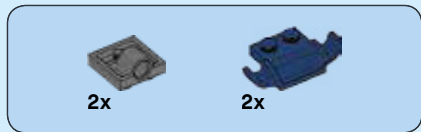

4

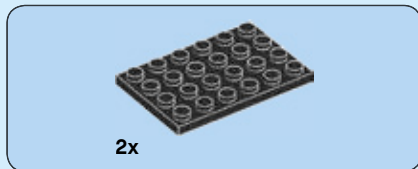
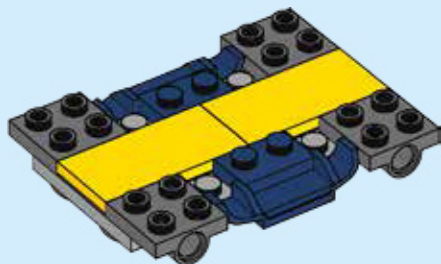

5

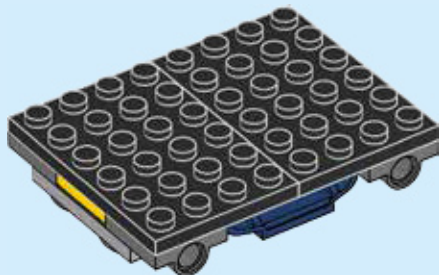





6

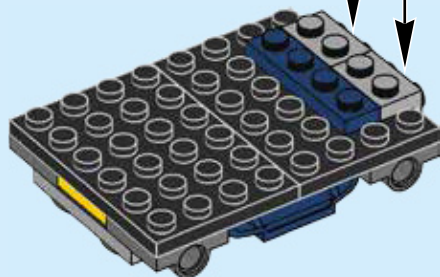

7

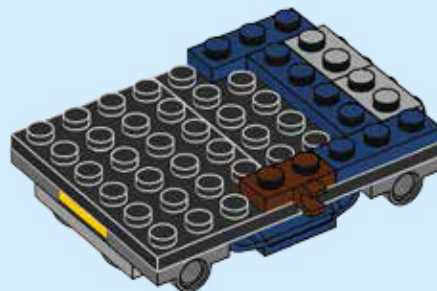



12

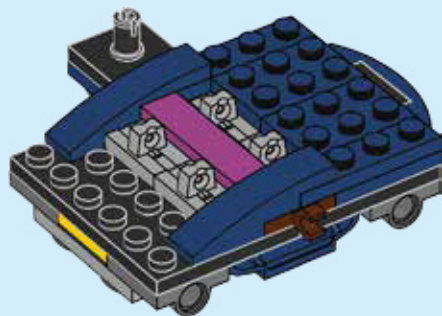

13

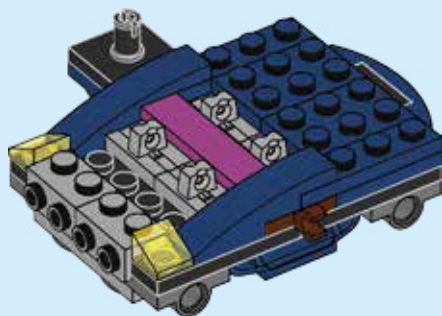



4x

10

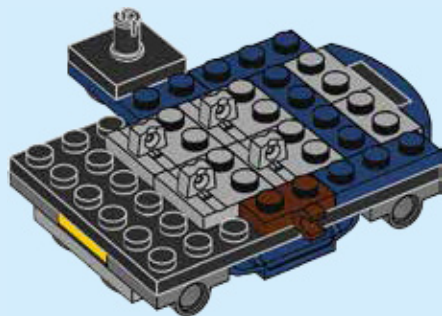

2x



2x

11

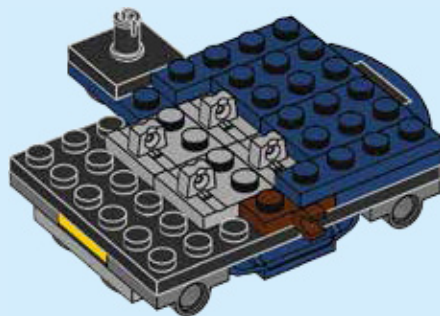



2x



1x

# 12

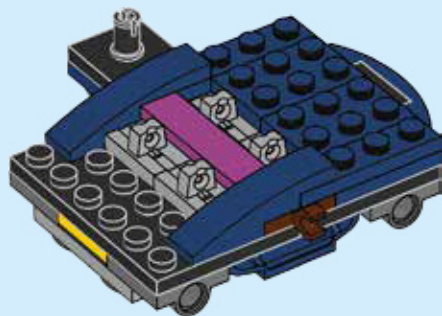

8



2x



2x

# 13

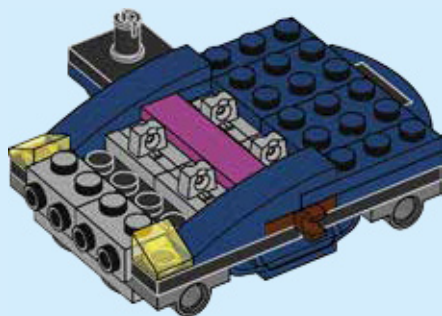



2x

# 14

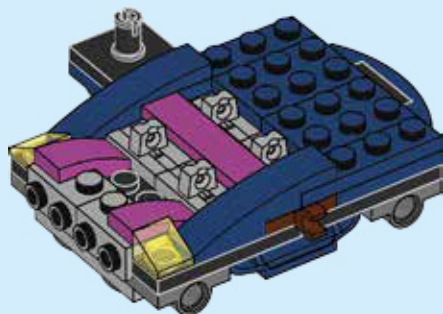

1x



1x

# 15

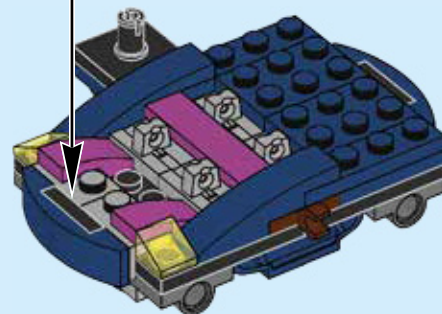
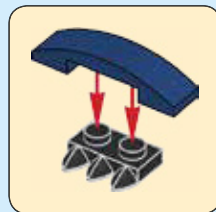



1x

# 16

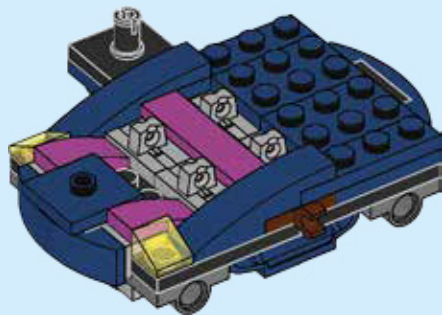

1x



2x



1x

# 17

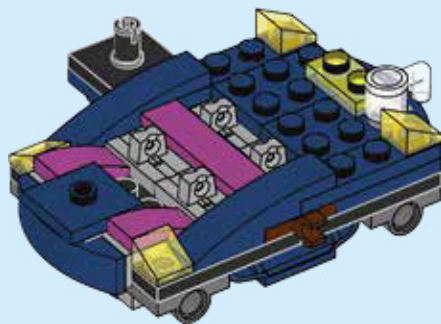



2x

18

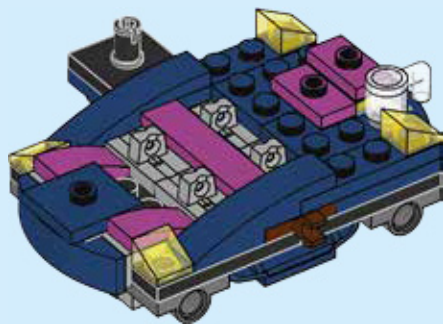

1x



2x

19

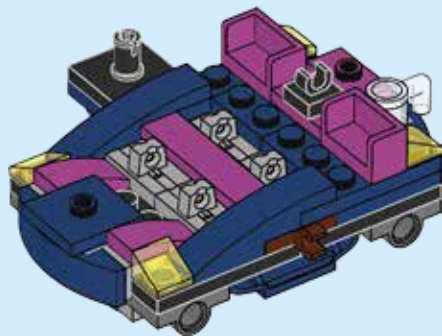



2x

20

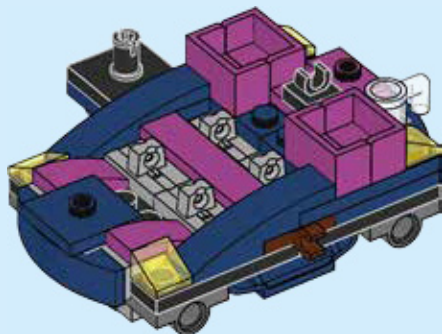

1x



1x

21

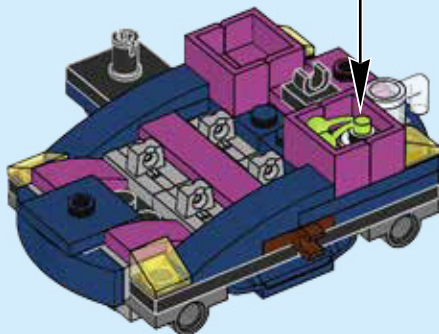
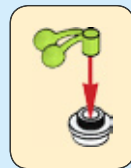





22

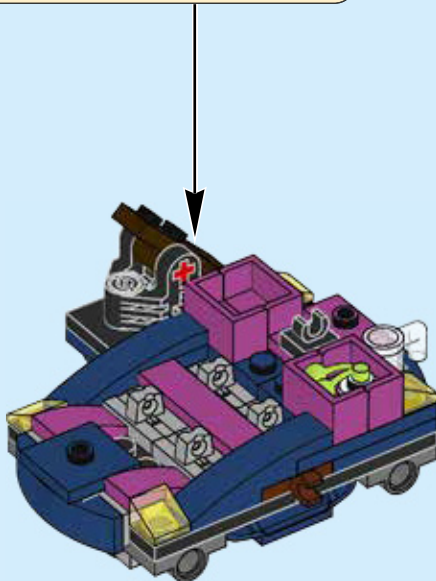



23

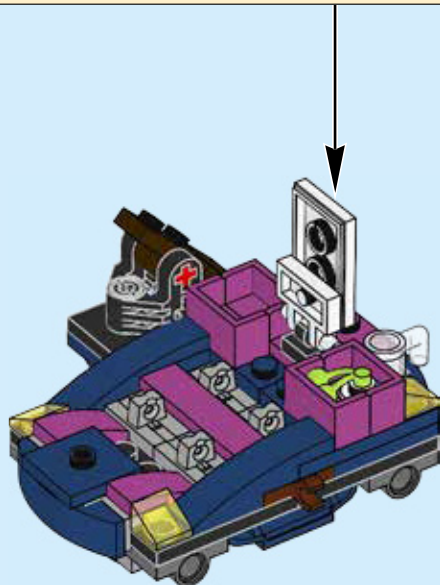
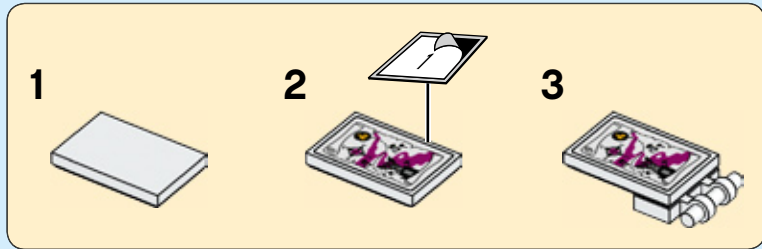

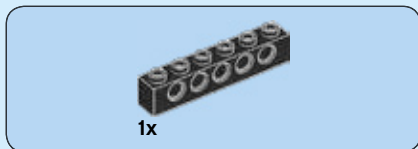
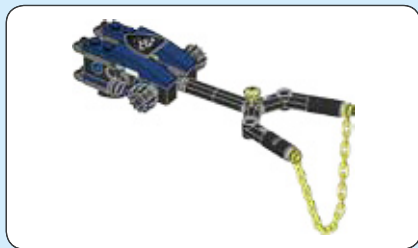

1x

24

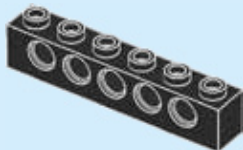

2x

25

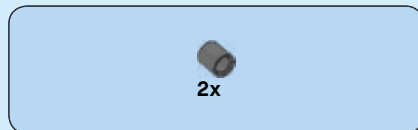
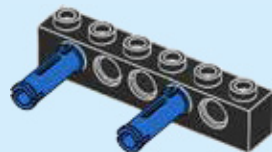

2x

26

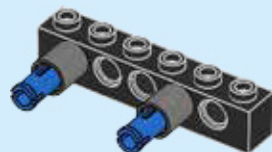

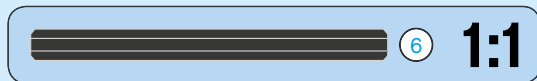
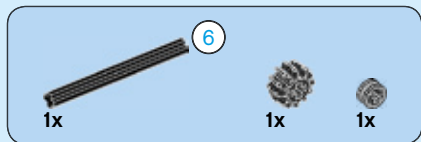

**27**

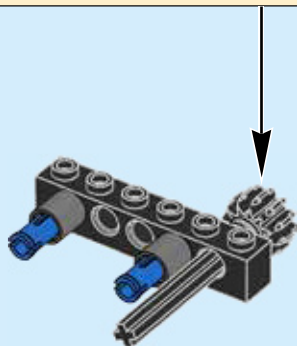
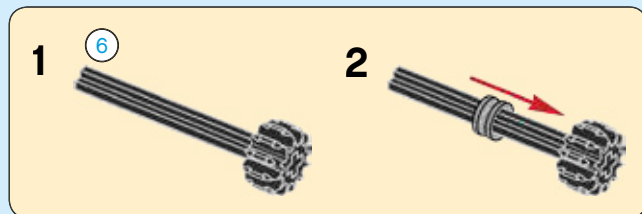



1x



1x

# 28

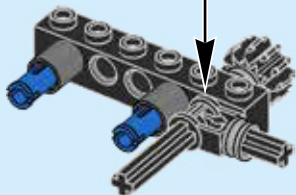
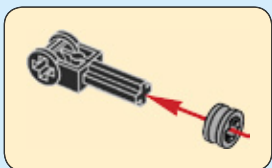

1x

# 29

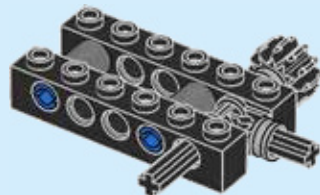



1x



1x

# 30

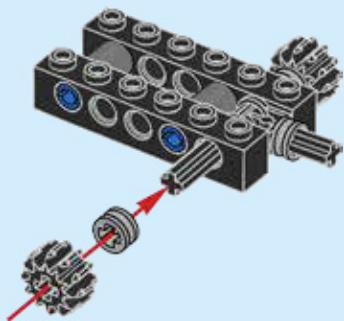

1x



1x

# 31

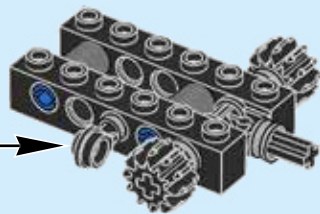
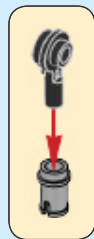



2x

32

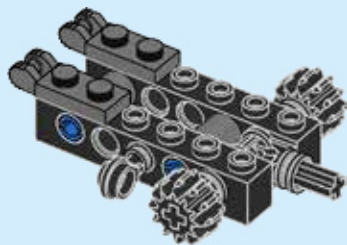

1x



1x



1x

33

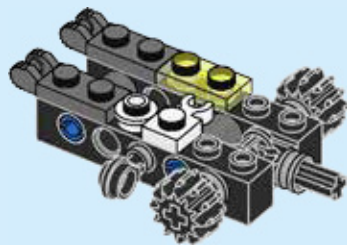



2x

34

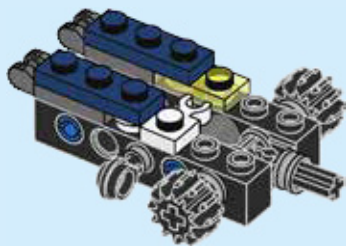

2x



1x

35

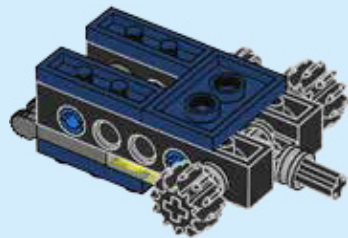
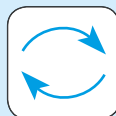





2x

36

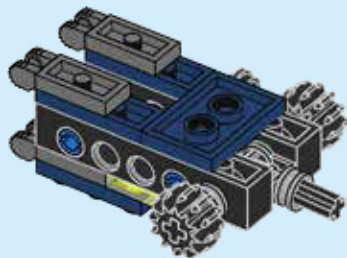

2x

37

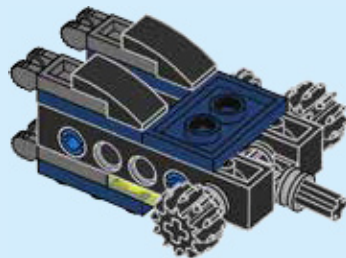



2x

# 38

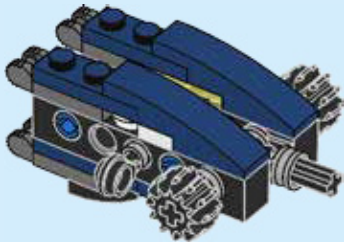
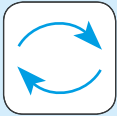

22



1x

# 39

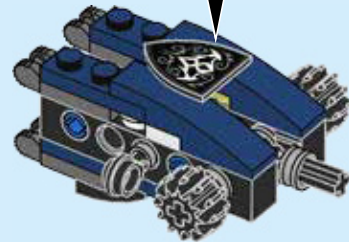
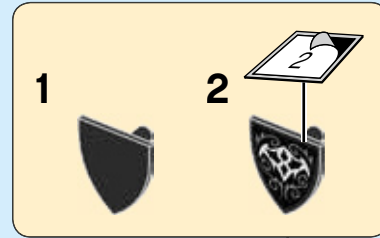



40



41

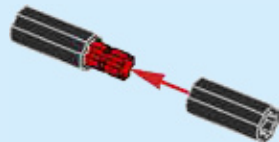

42

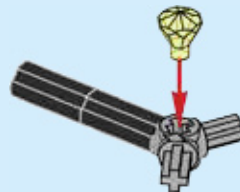

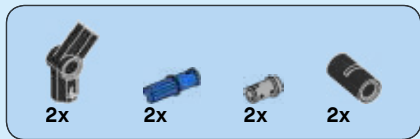

43

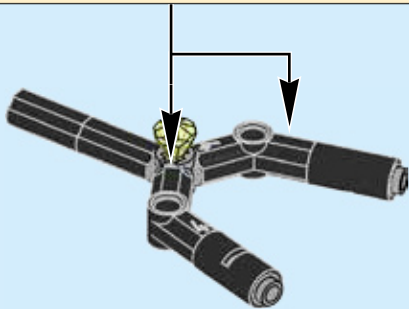
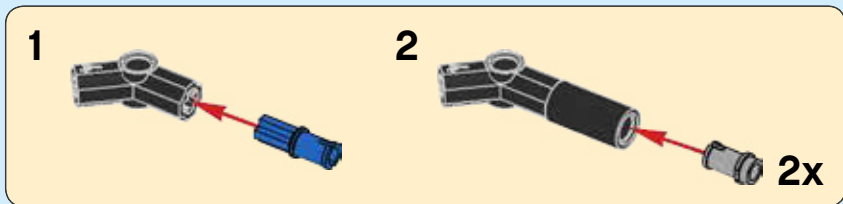

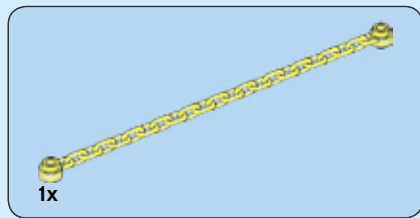

44

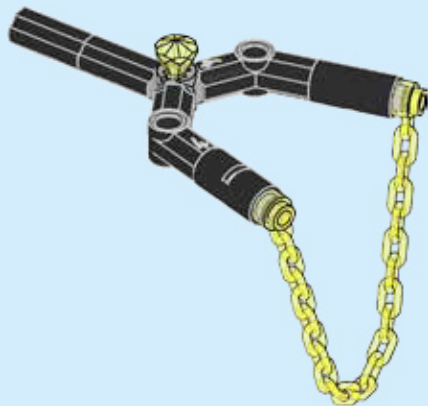

45

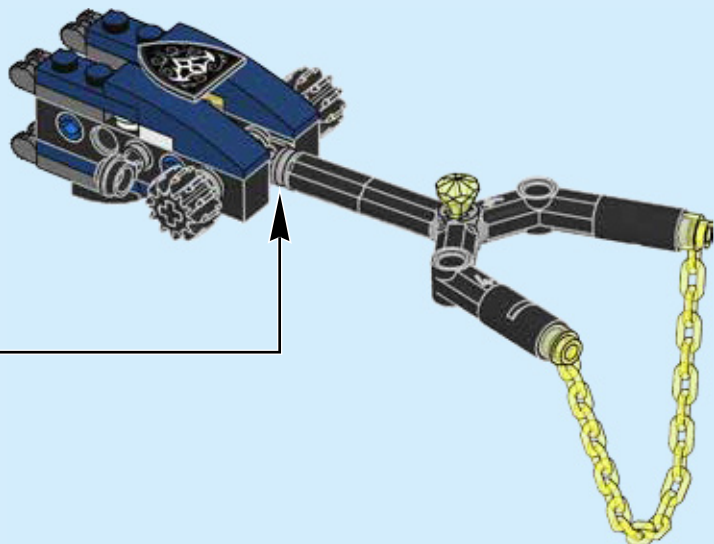

46

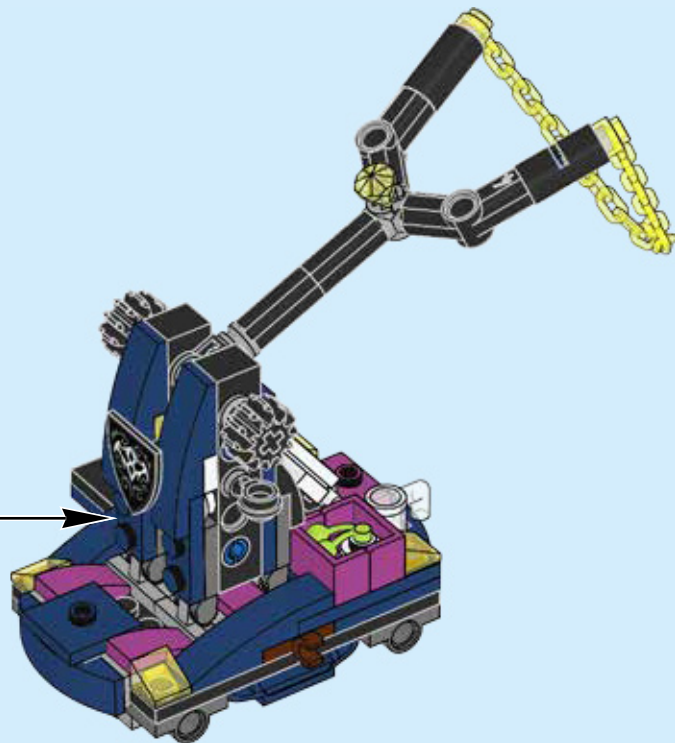



4x



4x



4x

# 47



4x

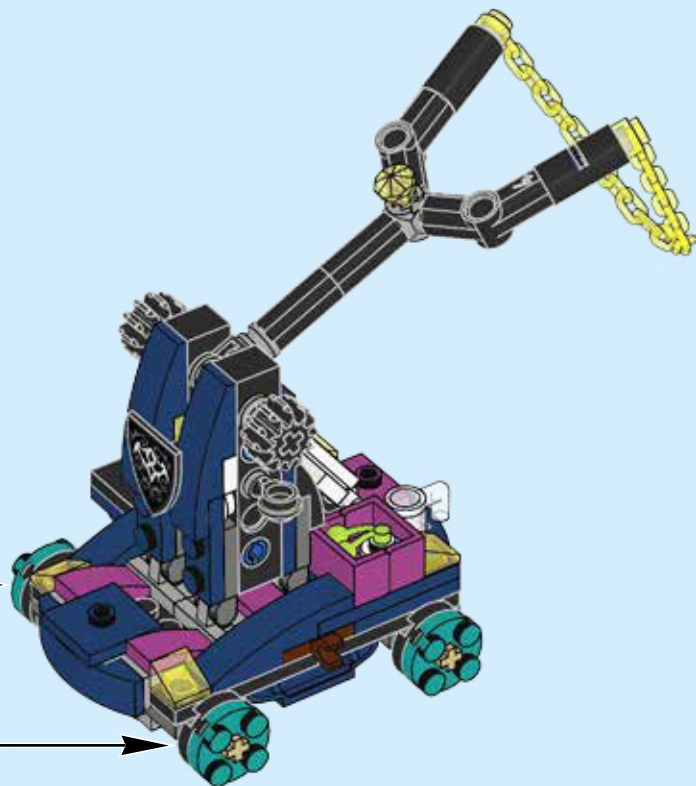



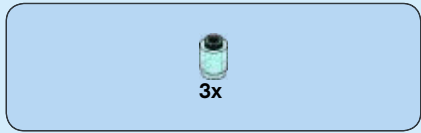

48

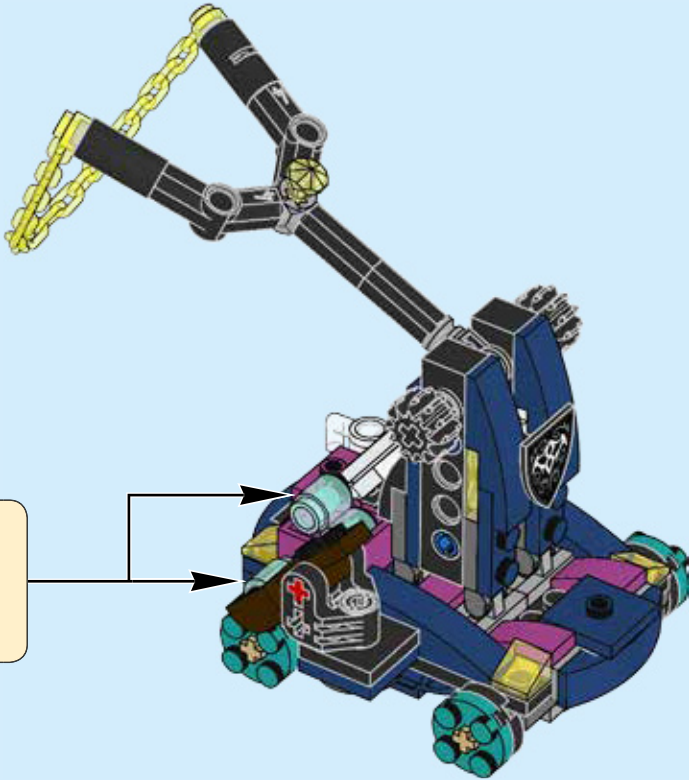
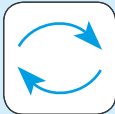

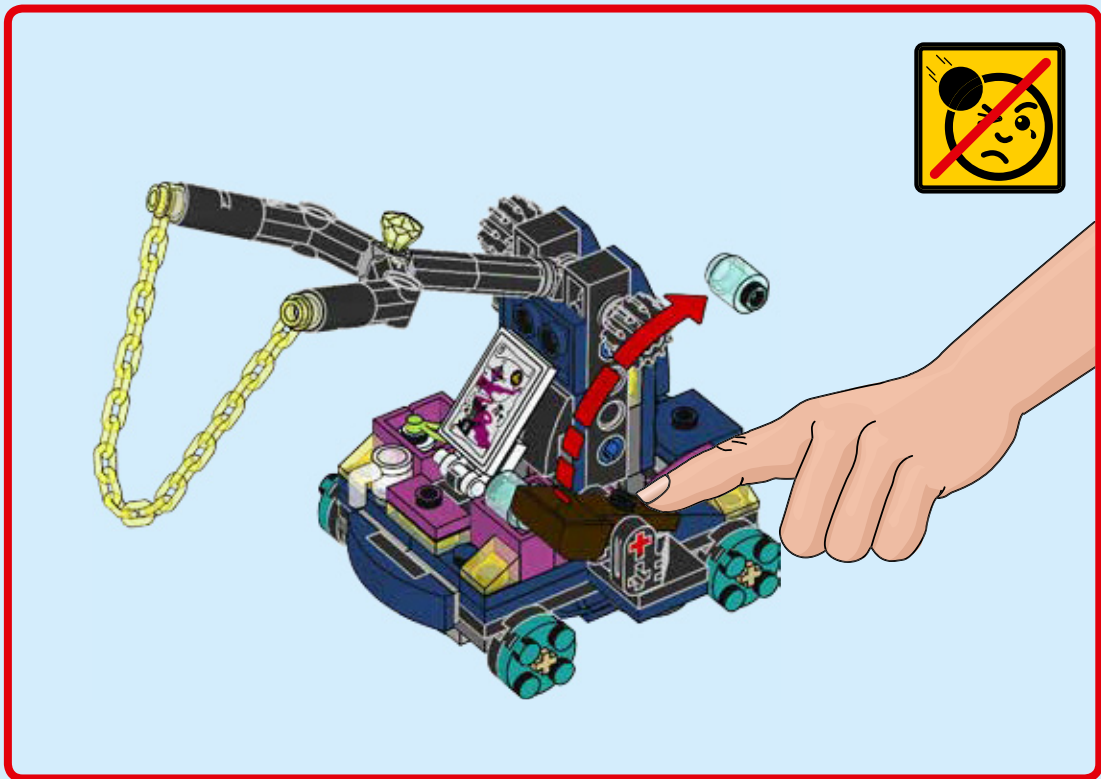

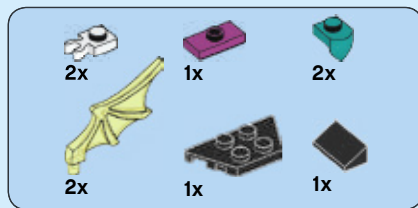

# 49

1



2



3

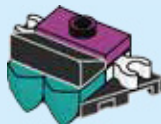

4

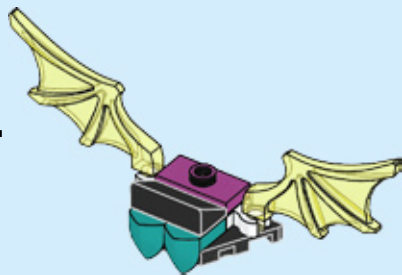

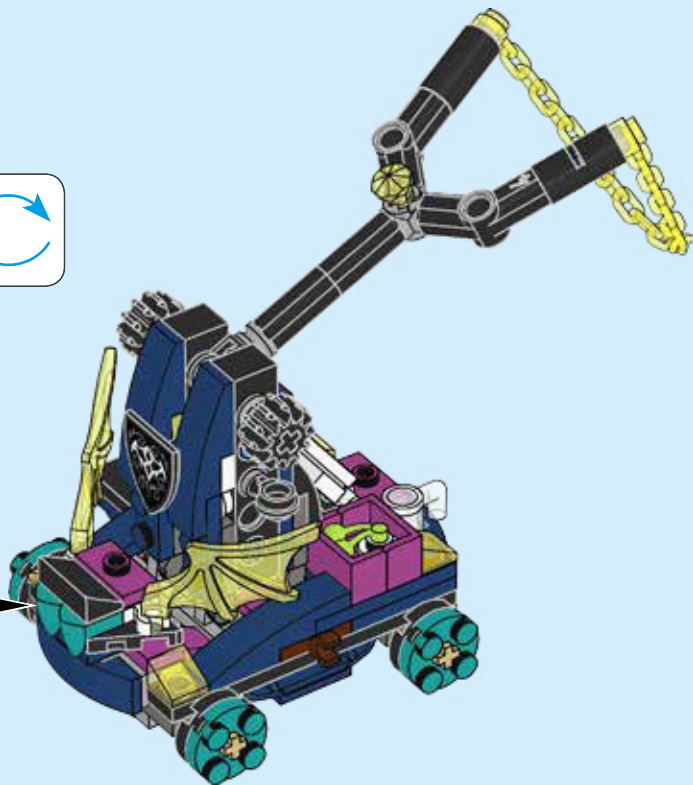
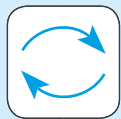



2x 6168642	1x 302001	2x 6145215	2x 6173585	2x 4517925	1x 4610371	1x 6210454	1x 4163917	2x 6100030
2x 4646844	1x 6146947	11x 6099730	1x 6020145	1x 6196548	1x 4258354	2x 6118828	3x 4183544	2x 4210719
1x 4111971	1x 6146947	2x 6175161	1x 6020146	2x 4121610	2x 4515368	2x 6118828	1x 4568951	5x 4278274
3x 4613256	1x 6006221	2x 6175161	1x 6020146	2x 4121610	2x 4515368	2x 6118828	1x 4568951	7x 6039479
2x 6018774	1x 6006221	2x 6020073	1x 6020146	2x 4121610	1x 4107765	2x 6118828	1x 4568951	4x 6039479
1x 4140583	1x 6213396	2x 6045944	2x 4289538	1x 4107765	1x 4531412	3x 6057458	1x 6214351	4x 6123814
1x 6210385	1x 6213396	4x 6146940	1x 6066102	1x 4548180	1x 4531412	1x 4650498	1x 6136548	4x 6047417
1x 302101	1x 6133817	1x 6133930	1x 654126	4x 403226	1x 370626	1x 626440	1x 6213535	4x 4210884
1x 6156667	2x 6020074	8x 6028736	1x 6175576	2x 4512363	2x 389426	2x 6125698	1x 6097301	4x 6210445
2x 6034675	1x 6097511	2x 6023185	2x 4177431	2x 6147050	2x 303226	10x 6172367	1x 6087084	4x 6210400
			1x 4184169	2x 6094141		10x 6172369	1x 4537251	1x 4278013

  
4x  
6078364

  
2x  
6190252

  
1x  
6141970

  
2x  
6071259

  
12x  
6083975

  
1x  
4654247

  
6x  
6212377

  
1x  
6213336

  
6x  
6207764

  
1x  
6147169

  
1x  
6189274

  
2x  
4528981

  
2x  
6186683

  
2x  
6103405

  
1x  
4565320

  
6x  
4177735

  
2x  
6097484

  
4x  
4530028

  
2x  
6176709

  
4x  
6042956

  
3x  
4502089

  
2x  
6037886

  
1x  
6101304

  
1x  
6213544

  
3x  
6101073

  
2x  
6070763

  
4x  
6131870

  
1x  
6078305

  
7x  
6210578

  
4x  
4666579

  
2x  
4142865

  
2x  
4206482

  
2x  
4514553

  
1x  
6134722

  
1x  
6129855

  
1x  
6060795

  
1x  
6209946

  
1x  
6103036

  
1x  
6214355

  
1x  
4626196

  
2x  
6201911

  
1x  
4211159

  
1x  
6035291

  
1x  
6133860

  
1x  
6185998

  
1x  
4211150

  
2x  
4211247

  
3x  
4211573

  
4x  
4211483

  
1x  
4211375

  
13x  
6043656

  
4x  
4654582

  
1x  
4502595

  
4x  
4211397

  
4x  
4666449

  
1x  
4211407

  
1x  
6035495

  
1x  
6104419

  
3x  
4646864

  
1x  
6213349

  
8x  
4260942

  
8x  
4278415

  
1x  
6206297

  
1x  
4114505

  
4x  
6076751

  
2x  
6102038

  
2x  
6209982

  
1x  
6206297



**Customer Service**

**Kundenservice**

**Service Consommateurs**

**Servicio Al Consumidor**

**LEGO.com/service or dial**



**: 00800 5346 5555**

**: 1-800-422-5346**

The land of  
*Mjølverdale*  
— a Shadow World —



SHADOW WORLD

Azur Bay

Rainlight Forest

The Everstar Inn

The River Courts

Windswept Isles

Summer Range







41190

41194

41191

41193

41192



41190

41191

41192

41193

41194

Welcome to  
**HEARTLAKE  
CITY**

41332

41334

41333

41330

41335

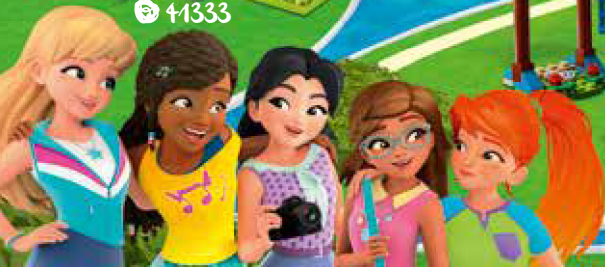

**LEGO** ELVES



LEGO Elves

LEGO and the LEGO logo are trademarks of the LEGO Group. ©2018 The LEGO Group.

6224791

