



Architecture

Shanghai

China

上海

中国

21039

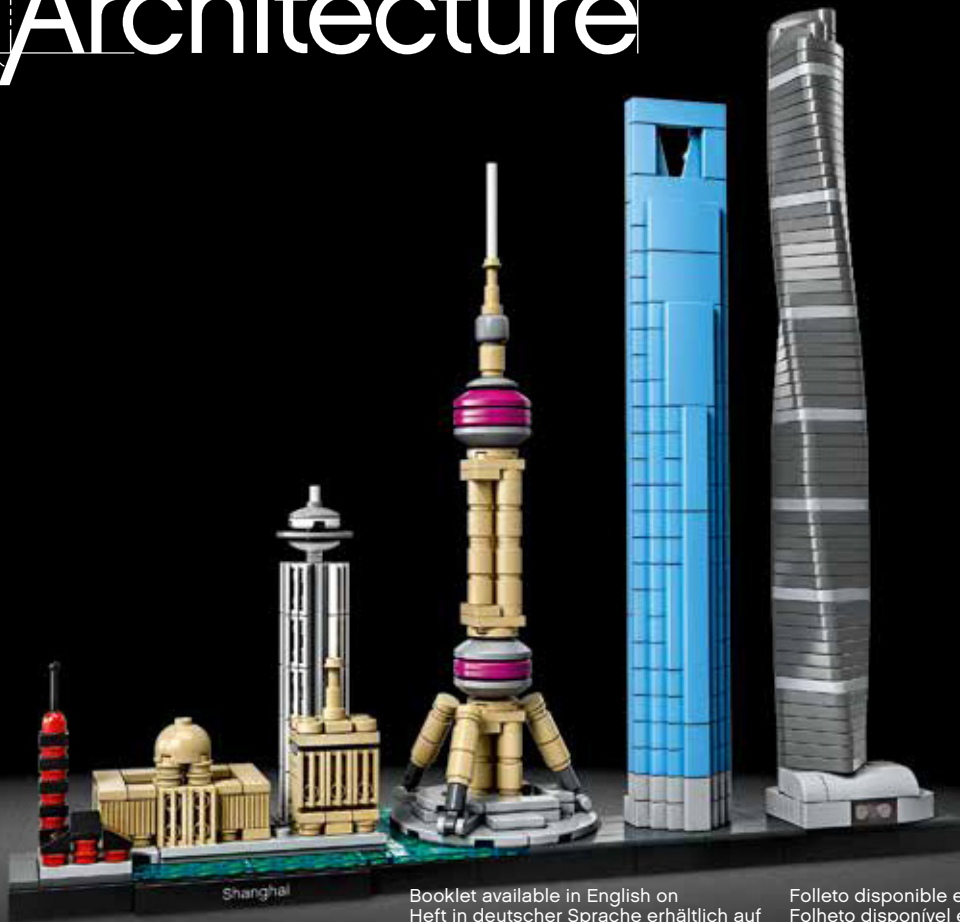

Booklet available in English on
Heft in deutscher Sprache erhältlich auf
Livret disponible en français sur
Libretto disponibile in italiano su

Folleto disponible en español en
Folheto disponível em português em
A füzet magyarul ezen a honlapon olvasható:
如需中文版手册, 请访问



[LEGO.com/architecture/booklet](https://www.lego.com/architecture/booklet)

The Pearl of the Orient

Sitting on the Yangtze River and bordered by the East China Sea, the city of Shanghai has re-emerged over the past decades to become one of the biggest cities and the busiest port in the world.

Nowhere is this dramatic development more evident than in the city's architecture. Shanghai's rich collection of Art Deco buildings from the 1920s and 1930s now stand side-by-side with an ever-increasing number of awe-inspiring, contemporary structures.

This is a city where the skyline is constantly evolving and every new structure appears to be an attempt to out-do previous ones in size, choice of materials or ambitious design. In an ever-changing world, Shanghai's architecture is stepping confidently into the future.

"New York may be the city that never sleeps, but Shanghai doesn't even sit down"

Patricia Marx





Chenghuang Miao Temple



There's a popular saying in Shanghai that states, "if you want to know the city well, you must visit the Chenghuang Miao Temple". The temple sits in one of the most popular traditional areas of the city and is the site of Shanghai's largest and oldest monastery, dating back to the 10th century. The present version of the temple dates from the 15th century and although much restored, is still considered the most authentic one in the city.

Longhua Pagoda



The Longhua Pagoda stands in Longhua Park at the south end of the city and is where the modern Shanghai meets its traditional past. The classical pagoda is the best known of the 16 historic pagodas that still stand within the city. The seven-story structure consists of a hollow, tube-like brick core surrounded by a wooden staircase. The exterior is decorated with balconies, banisters and upturned eaves. The original structure dates back to 977 AD and due to the fragile nature of its wooden components, is no longer open to the public.







The Bund

Originally a waterfront area outside the old walled city of Shanghai, The Bund was home to numerous international banks and trading houses. Many of the magnificent Beaux Arts buildings were constructed in the early part of the 20th century as the area developed into a major financial center.



HSBC Building (No. 12, The Bund)

This six-floor, neo-classical style building was designed by a British architecture firm and completed in 1923. At the time, it was called “the most luxurious building between the Suez Canal and the Bering Strait”. Its central dome was famously decorated with frescos depicting the twelve signs of the zodiac. It served as the HSBC headquarters until 1955, when it then became known as the Municipal Government Building. Today the building houses the Shanghai Pudong Development Bank.

Customs House (No. 13, The Bund)

Built in 1927 on the site of a traditional Chinese-style customs house, the building cost 4.3 million taels of silver to construct and still functions as a customs house today. The eastern section is eight stories tall, faces the Huangpu River and is topped by a 300 ft. (90 m) clock tower. The clock tower offers views over the entire Bund and Shanghai city center. The clock and bell itself were built in England and are an imitation of Big Ben.



"To my child's eyes, which had seen nothing else, Shanghai was a waking dream where everything I could imagine had already been taken to its extreme."

J. G. Ballard

Radisson Blu Hotel Shanghai New World

This 682 ft. (208 m) tall hotel stands in the city's Huangpu district. The original structure was completed in 2001, while the dome was added in 2005. The building is known for its revolving restaurant on the 45th floor and the bar at the top of the dome that sits under the hotel's iconic glass ceiling.



Oriental Pearl Tower

Situated on The Bund, this 1,535 ft. (468 m) tall TV and radio tower has become an iconic landmark for the city, especially as its futuristic style stands out against the area's other diverse architectural styles. Completed in 1994, the tower is made up of 11 bigger and smaller spheres, the largest one with a diameter of 164 ft. (50 m) that is supported by legs that reach far into the ground. The tower sits on the edge of the riverbank and has 15 observatory levels, the highest of which is at 1,148 ft. (350 m).

"And Shanghai is amazing. I'm a fan of science fiction so when you're there in the night with all the lights and all this modernity, it's like a set in a movie."

Berenice Marlohe







Shanghai World Financial Center

Given the task of creating a building that would symbolize Shanghai's emergence as a global capital, the architect, William Pedersen, chose to make a bold statement using two sweeping arcs and a square prism – shapes that also represent ancient Chinese symbols of heaven and earth.

Known locally as “the Bottle Opener,” the 1,614 ft. (492 m) tall structure is a mini vertical city containing 62 office floors, conference facilities, retail and dining spaces, and a 174-room five-star Hotel at the top. The Center's design has received much critical acclaim since its completion in 2008, with one architectural judging committee stating the building is “nothing short of genius”.





Shanghai Tower

Building tall in Shanghai comes with its own set of challenges: the city sits upon sandy river delta soil and is often buffeted by tropical typhoons. So when the architects and engineers wanted to build the tallest building in China, they had to be innovative. They placed the entire structure upon massive 200 ft. (70 m) long concrete piles to provide the perfect foundation, while the tower's elegant spiralling cylindrical shape is also aerodynamic, reducing wind loads by 24%.

With a height of 2,073 ft. (632 meters), Shanghai Tower is the second tallest building in the world, but has the world's highest observation deck at 1,840 ft. (561 m) and the fastest elevators that can speed up and down the building at 40 mph (65 km/h).





东方之珠

上海北界长江，东濒东海，在过去的数十年中重新崛起，成为全球最大城市之一和最繁忙的港口。

这座城市在建筑方面的发展尤为瞩目。上海本身就拥有众多建于20世纪20年代至30年代具有装饰派风格的建筑，而如今，大量令人叹为观止的现代化高楼如雨后春笋般出现在这些建筑周侧。

这是一座天际线不断变化的城市，每一座新建筑都想在高度、用材或宏伟设计方面有所突破。在这个日新月异的世界中，上海的建筑已自信满满地跨入了未来。

“纽约是不夜城，而夜色下的上海比纽约还要喧嚣”

派翠西亚·马克斯 (Patricia Marx)





城隍庙



上海有一句俗语，“如果想了解这个城市，你必须去拜拜城隍庙”。这座神庙坐落于上海最为繁华最负盛名的区域，是上海最大和最古老的寺院，可追溯到第10世纪。当前的神庙始建于15世纪，尽管经过大部分修复，但仍被认为是该城市中古迹保留程度最好的寺庙。

龙华塔



龙华塔坐落于上海市南端的龙华公园内，是现代上海与其传统历史的交汇处。这座古式宝塔是上海市内16座现存的历史宝塔中最著名的一座。七层塔身由一个中空、砖砌的芯柱和围绕其盘旋而上的木制楼梯组成。塔的外部饰有阳台、栏杆和面翘飞檐。这座宝塔的前身可追溯到公元977年，由于其木质结构组件在强度方面的缺陷，已不再向公众开放。







外滩

外滩原是上海古城墙外的滨江区域，后成为众多国际银行和贸易商行的所在地。在发展为主要金融中心的过程中，该区域于20世纪早期建造了许多具有古典风格的宏伟建筑。



汇丰大楼 (外滩12号)

这座六层的新古典主义风格的建筑由英国建筑设计公司设计，于1923年建成。当时，它被称为“从苏伊士运河到远东白令海峡最讲究的建筑”。这座建筑的中央穹顶饰有著名的壁画，其中绘有黄道十二宫的标志。在1955年之前，它是汇丰银行的总部驻地，之后成为著名的“市府大楼”。目前，该建筑是上海浦东发展银行的总部。

海关大楼 (外滩13号)

1927年，该大楼建在一座中国官衙式海关的旧址上，耗资430万两白银，目前仍作为海关大楼。大楼东部面向黄浦江，共有八层，顶部有一座300英尺（90米）高的钟楼。从该钟楼可以俯瞰整个外滩和上海市中心。钟楼的钟面和大钟仿照大本钟样式，在英国制造



A vertical strip on the left side of the page shows a nighttime cityscape of Shanghai, with illuminated buildings and streets against a dark sky.

“在我孩子的眼中, 别无他物, 上海就像一场醒梦, 凡是我所能想象到的, 在那里都已达到了极致。”

J. G. 巴拉德

上海新世界丽笙大酒店

这座682英尺(208米)高的大酒店矗立于上海市的黄浦区。它的原始结构于2001年完成, 而其圆顶在2005年加盖。这座大酒店以其位于45楼的旋景餐厅和圆顶顶部的星空酒吧闻名于世, 该酒吧正好处在酒店标志性的玻璃天花板之下。



东方明珠塔

东方明珠塔坐落于外滩，这座1535英尺（468米）高的广播电视塔已成为上海市的地标性建筑，尤其是该塔的未来主义建筑风格，使其从本区域内的多种建筑风格中脱颖而出。该塔于1994年完工，由11个大小不一的球体组成，最大一个球体的直径为164英尺（50米），并由深入地下的支柱支撑。它位于黄浦江畔，设有15个观景层级，其中最高一级位于1148英尺（350米）处。

“上海令人叹为观止！我是一个科幻小说迷，夜晚里，当你身处于五彩霓虹之中，体验着现代化气息，一切好像在电影中一样。”

贝纳尼丝·玛尔洛







上海环球金融中心

建筑师威廉·佩德森肩负重任，被要求建造一座大厦，以象征着上海发展成为了一个世界金融中心，他大胆选用两个扫弧和一个正方棱柱形元素，它们代表了中国古代符号：天和地。

这座被当地人称为“开瓶器”的大楼高1614英尺（492米），是一座迷你的垂直城市，内设62个办公室楼层、会议设施及零售和餐饮区，还包括一家位于顶楼的五星级酒店，其拥有174套客房。该中心自2008年建成以来，备受赞誉，一个建筑评审委员会甚至将其誉为“天才的杰作”。





上海中心大厦

在上海建造高楼也面临着自身带来的一系列挑战：上海建于长江三角洲砂质土壤之上，并常受热带台风袭扰。因此，若建筑师和工程师们想建造出中国的最高建筑，必须要创新。他们将整座大厦建造在200英尺（70米）长的混凝土加固层上，以为其提供最佳的基底，大厦优美的螺旋式圆柱外形也符合空气动力学设计，可将风负荷减少24%。

上海中心大厦总高为2073英尺（632米），是世界第二高楼，但其拥有世界最高的观景台（高1840英尺（561米））和最快的电梯，电梯最大运行速度可达40英里/小时（65公里/小时）。





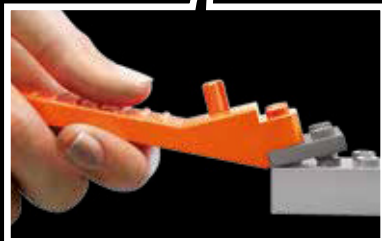
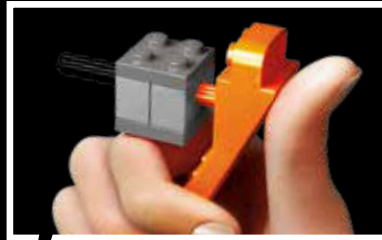
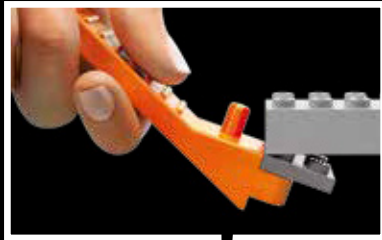

LEGO.com/brickseparator

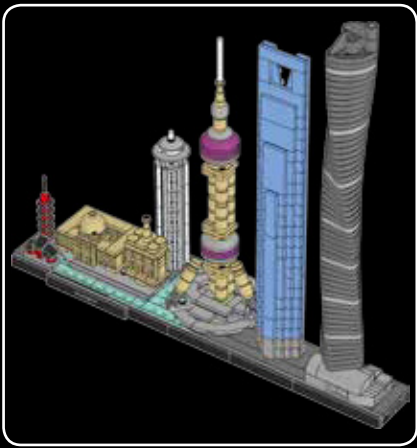

1

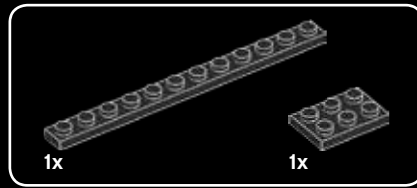
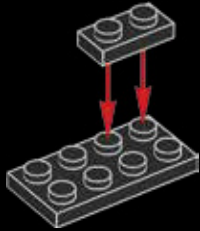

2

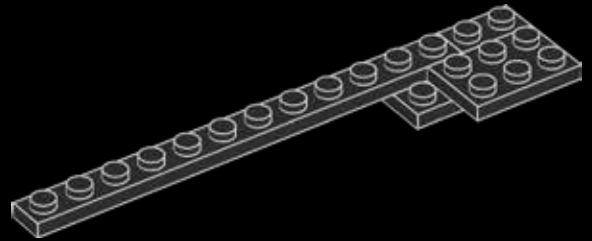



2x

3

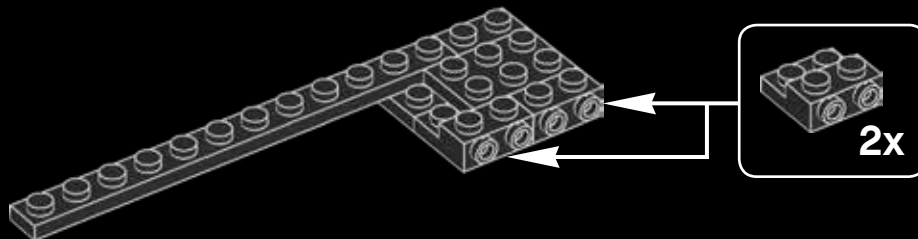

2x

4

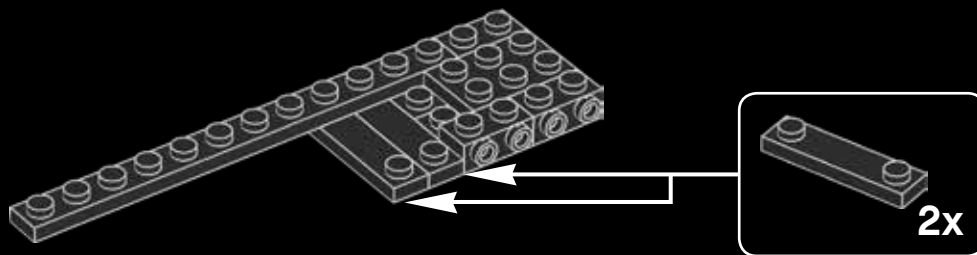

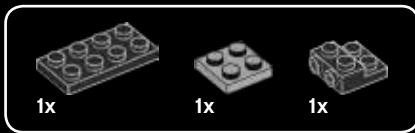

5

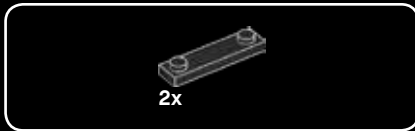
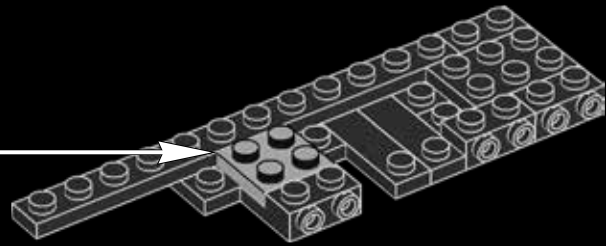
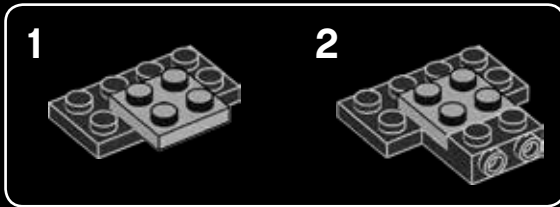

6

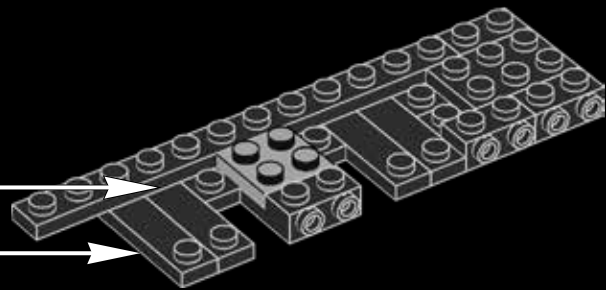
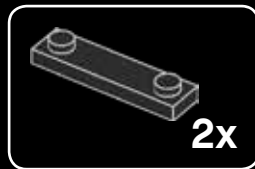



7

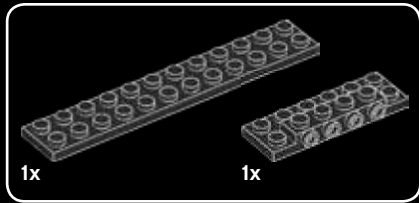
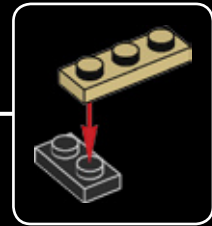
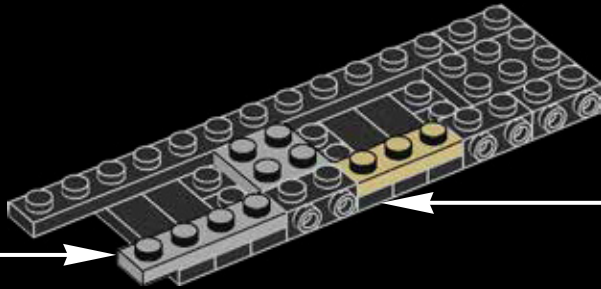
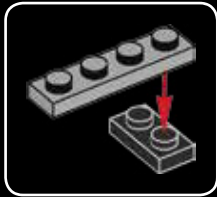

8

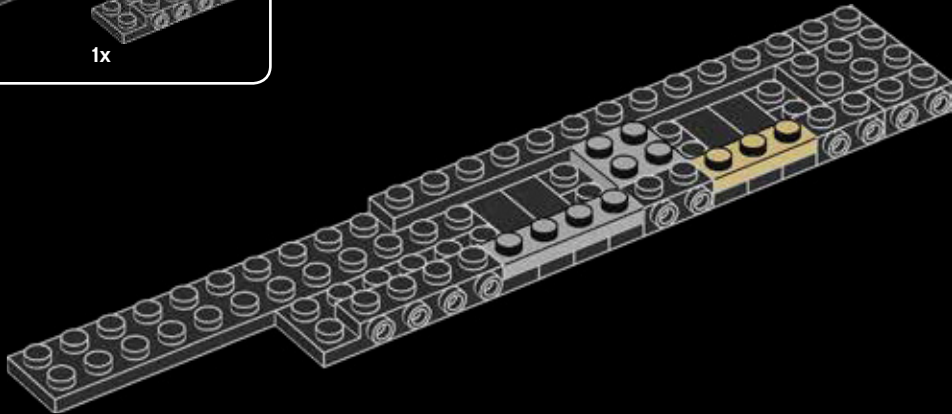

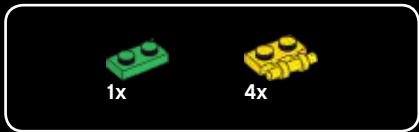

9

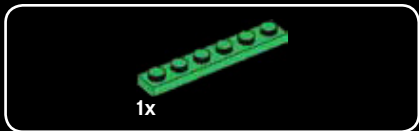
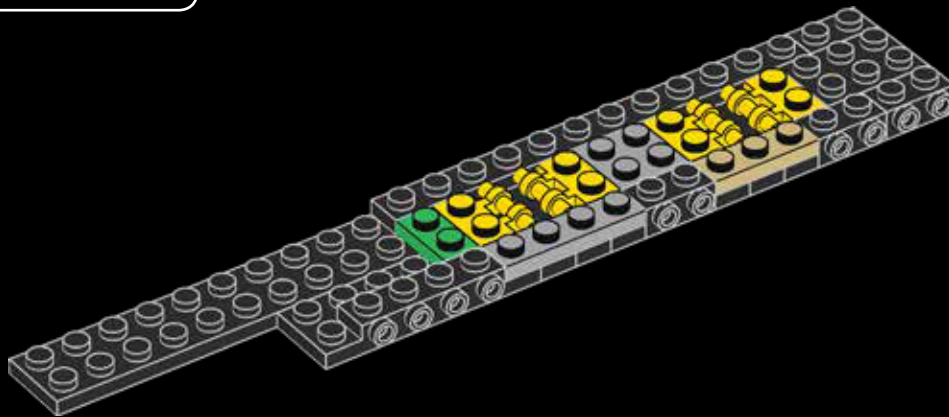

10

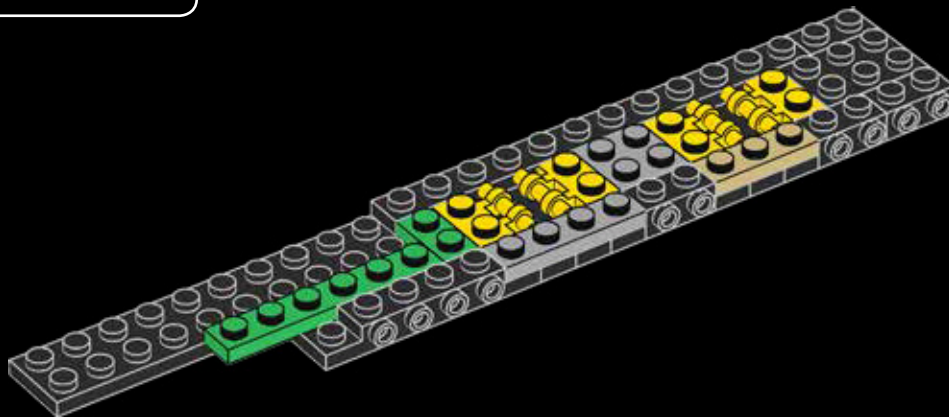

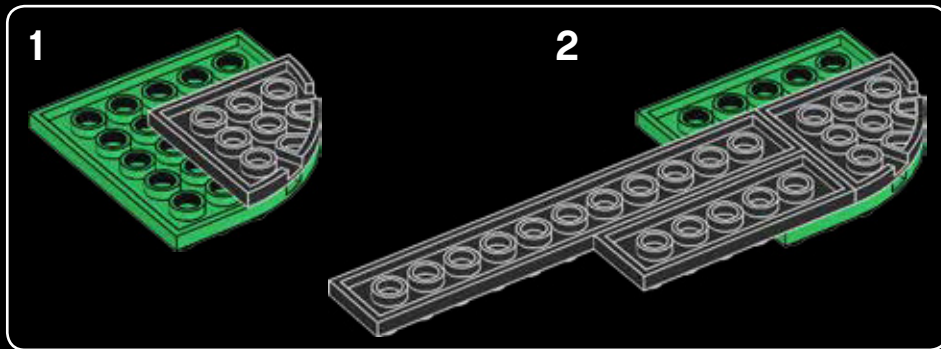
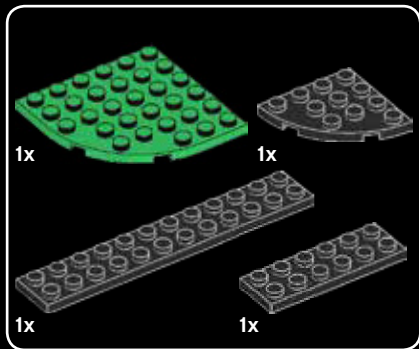

11

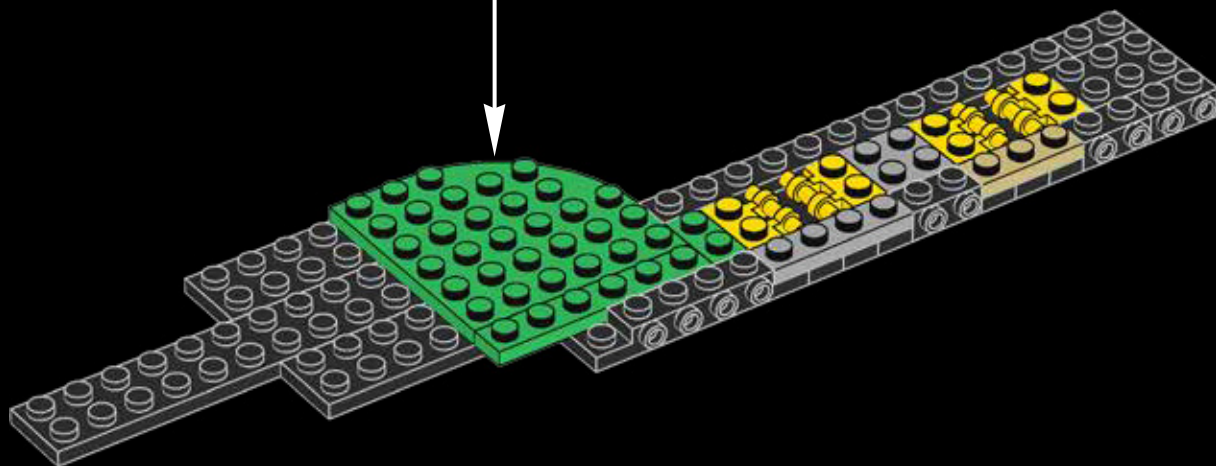

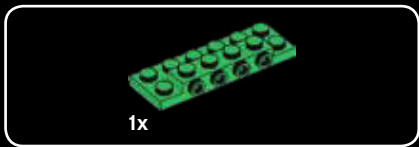

12

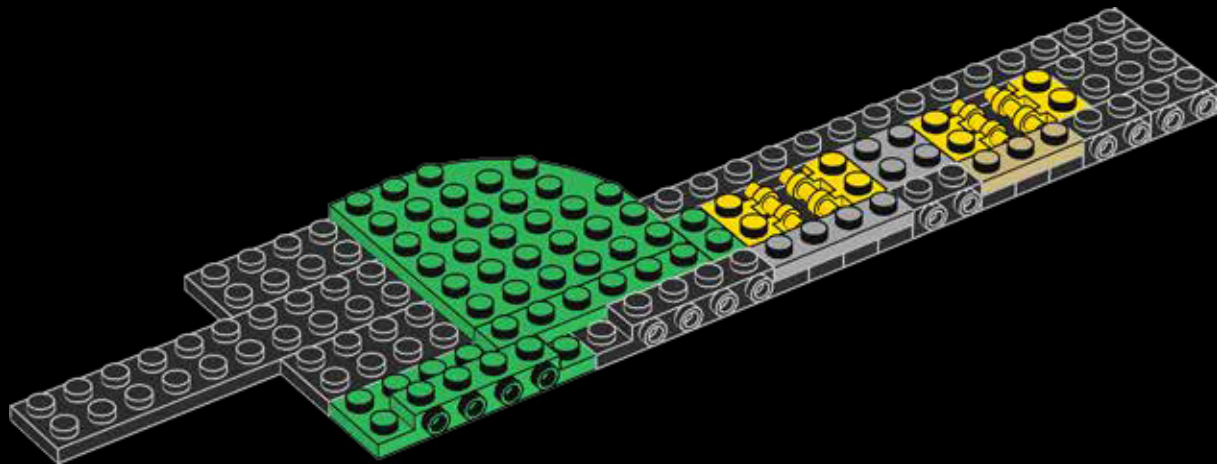

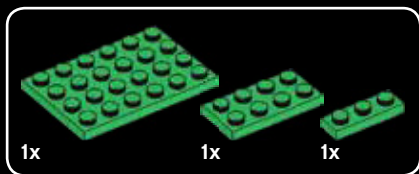

13

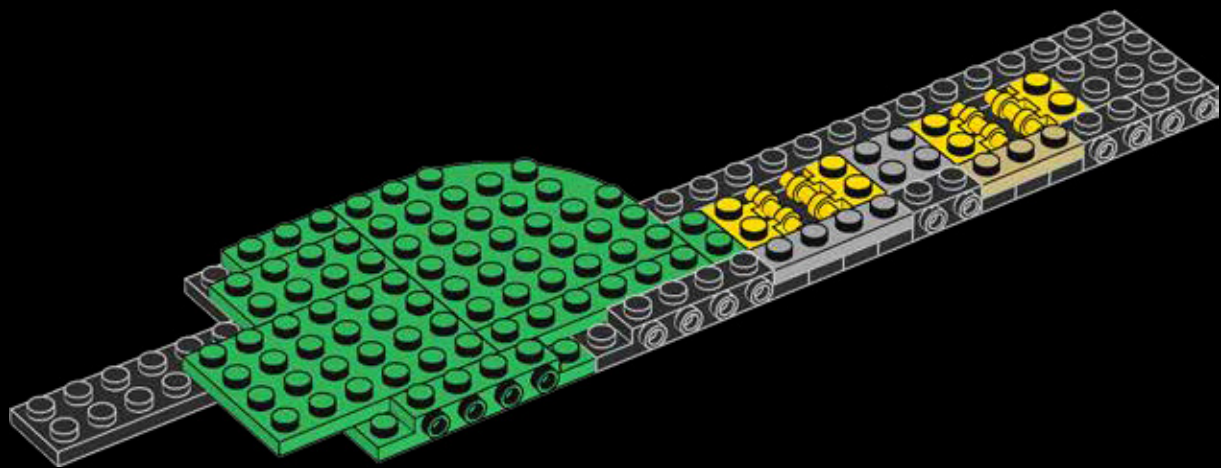

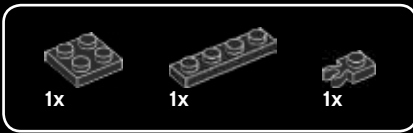

14

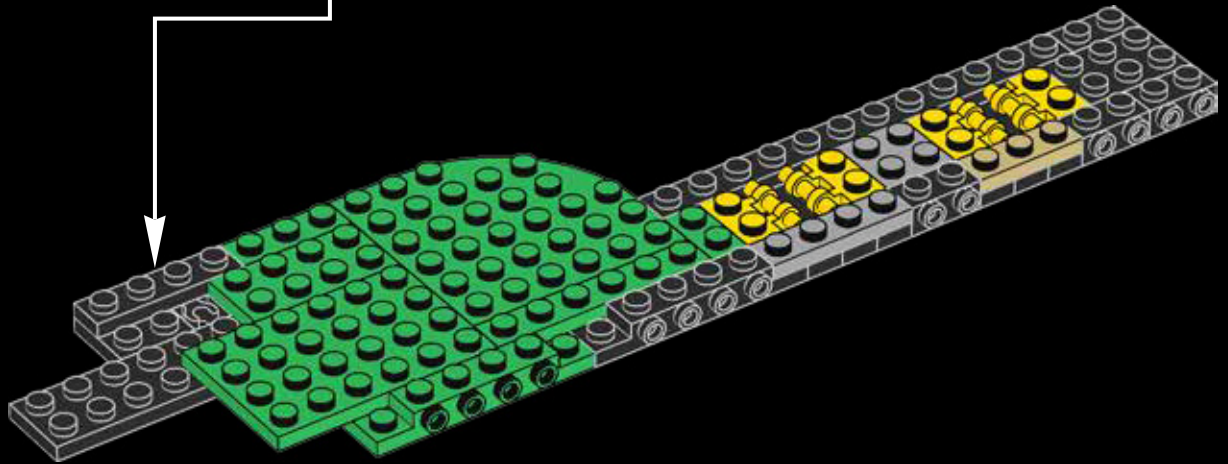
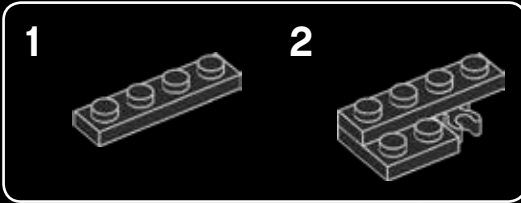



1x



1x

15

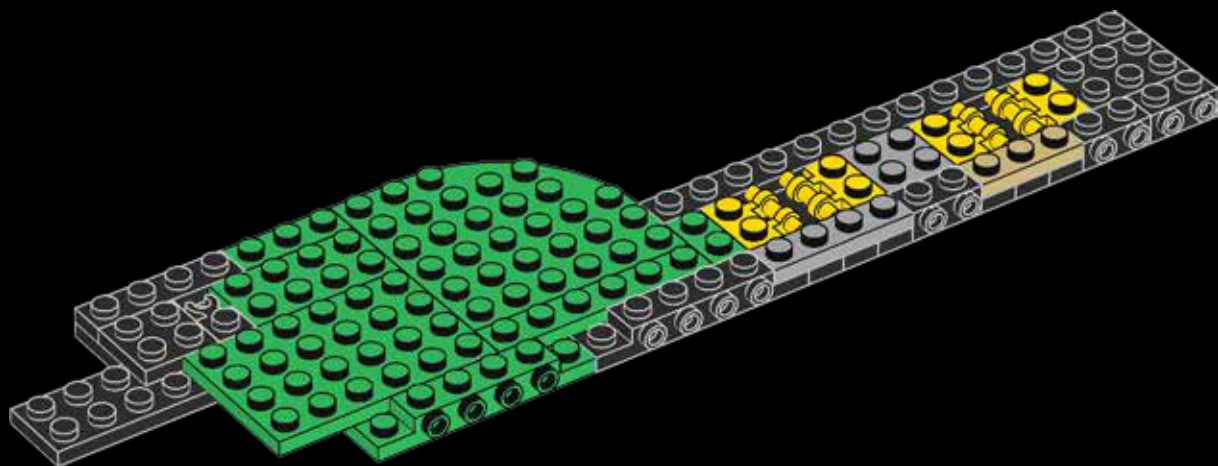

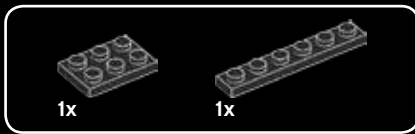

16

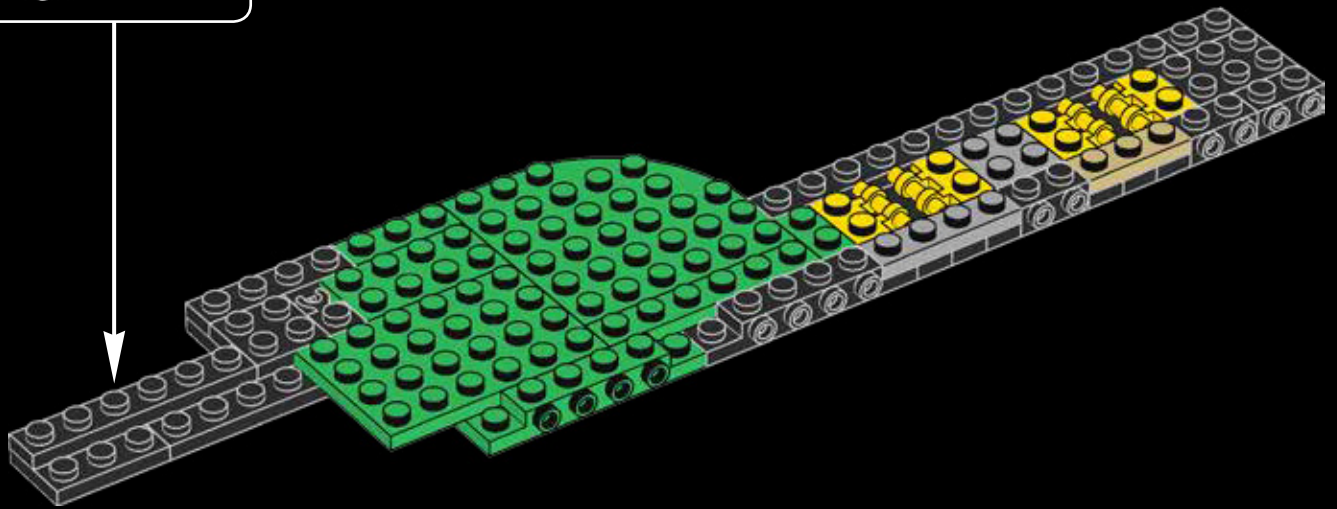
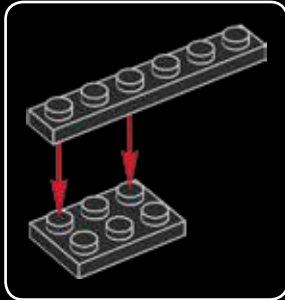

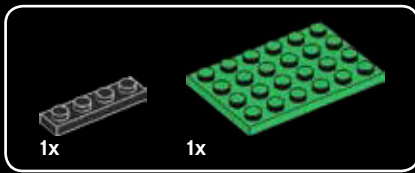

18

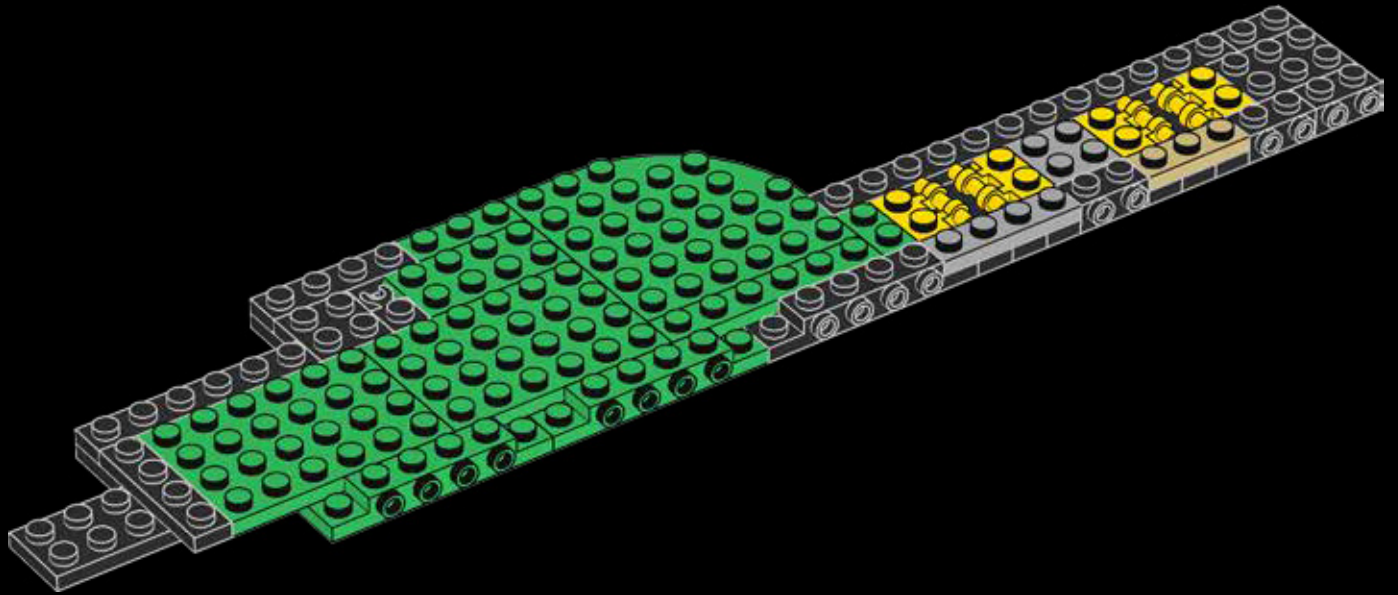



19

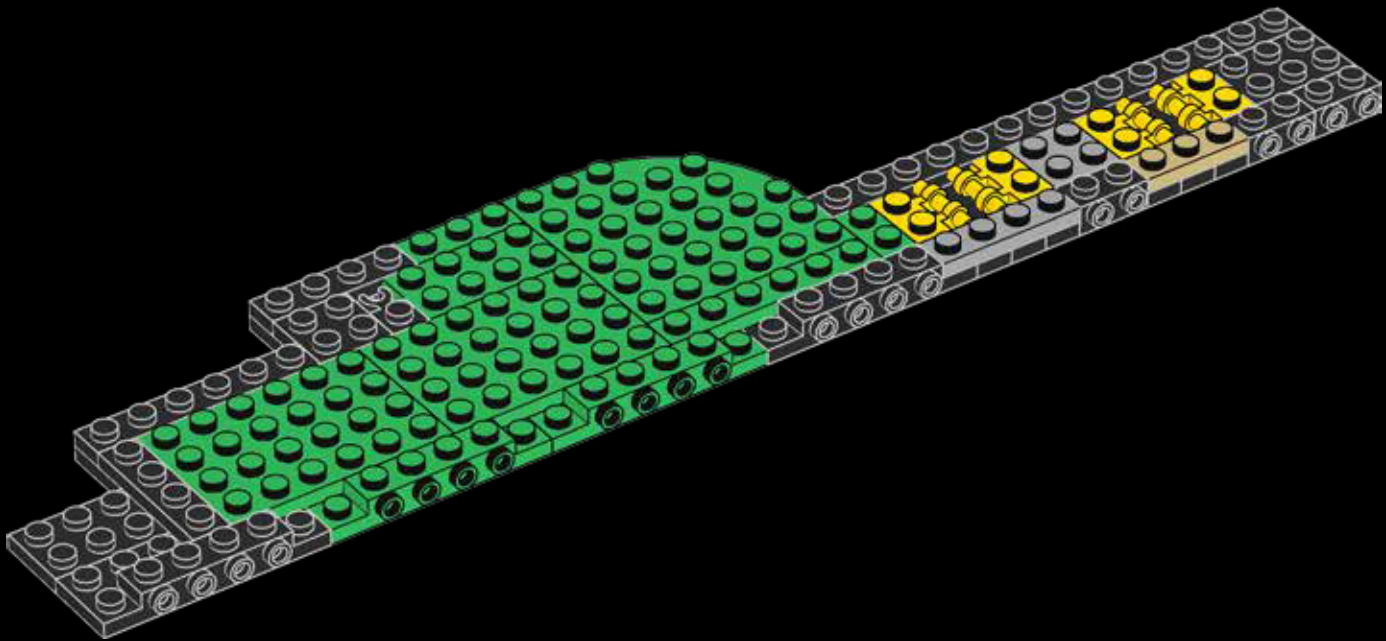

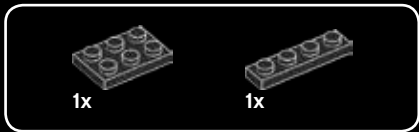

20

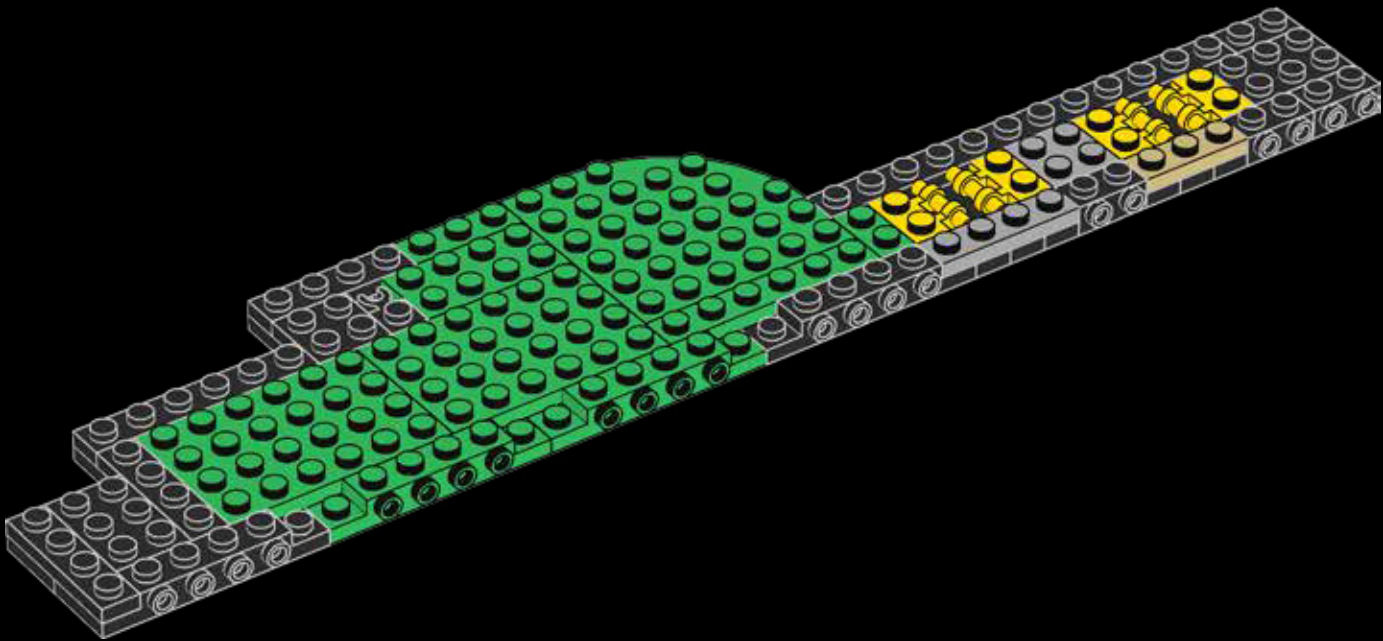

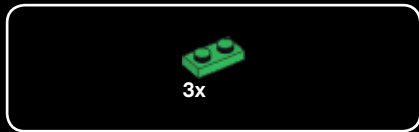

21

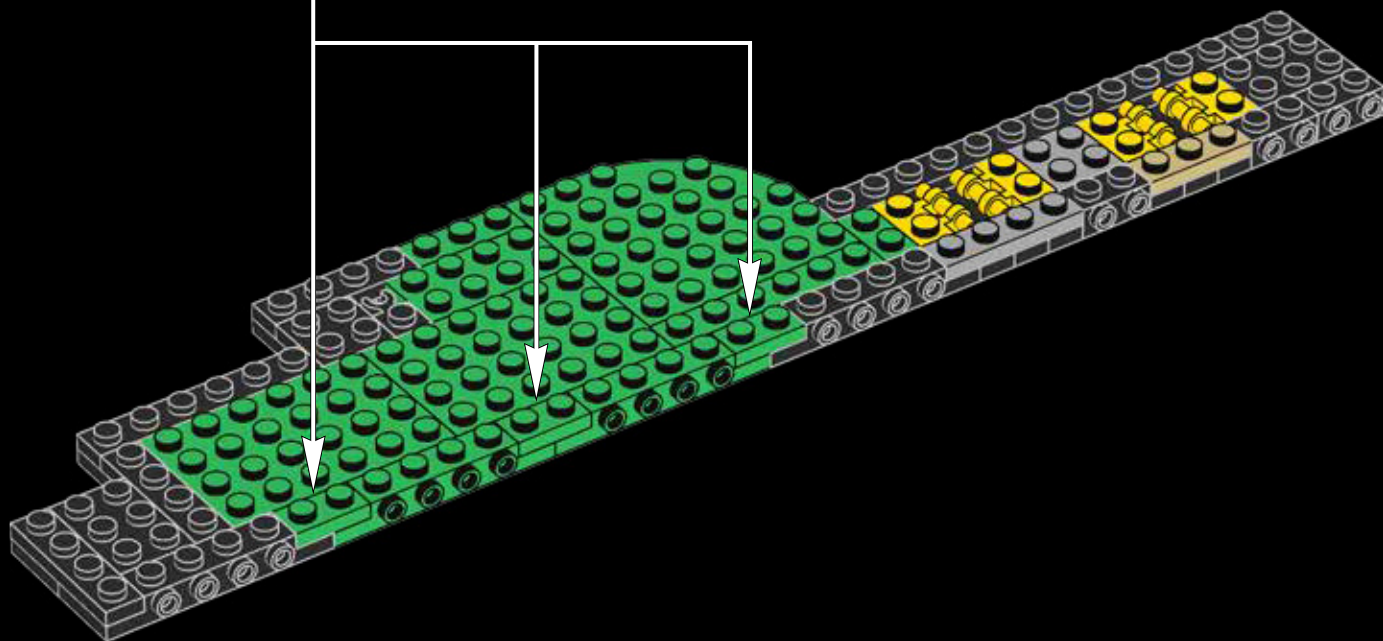
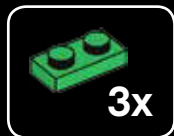

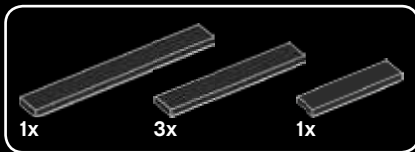

22

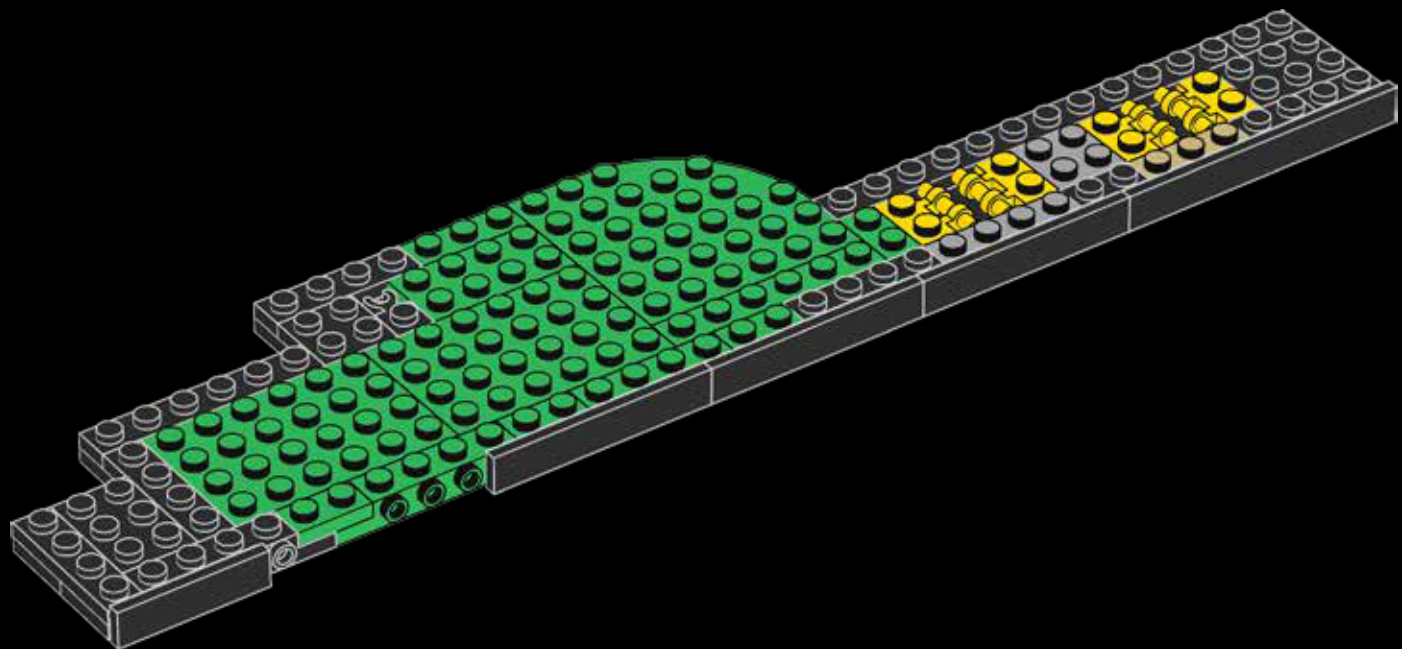

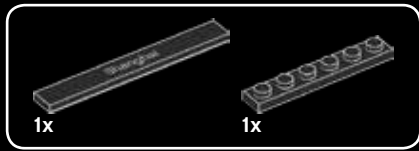

23

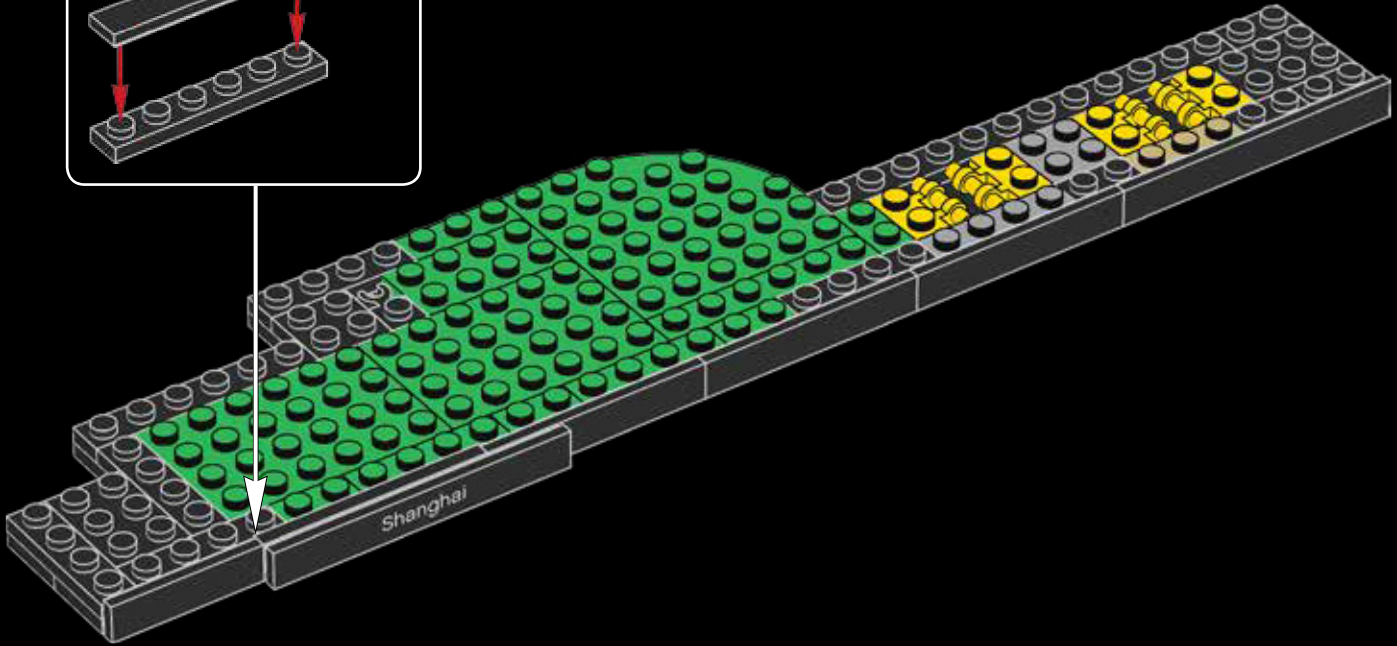
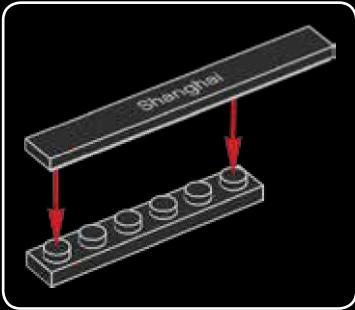

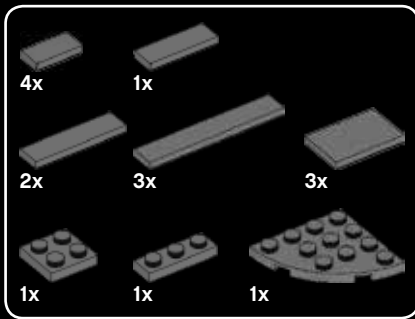

24

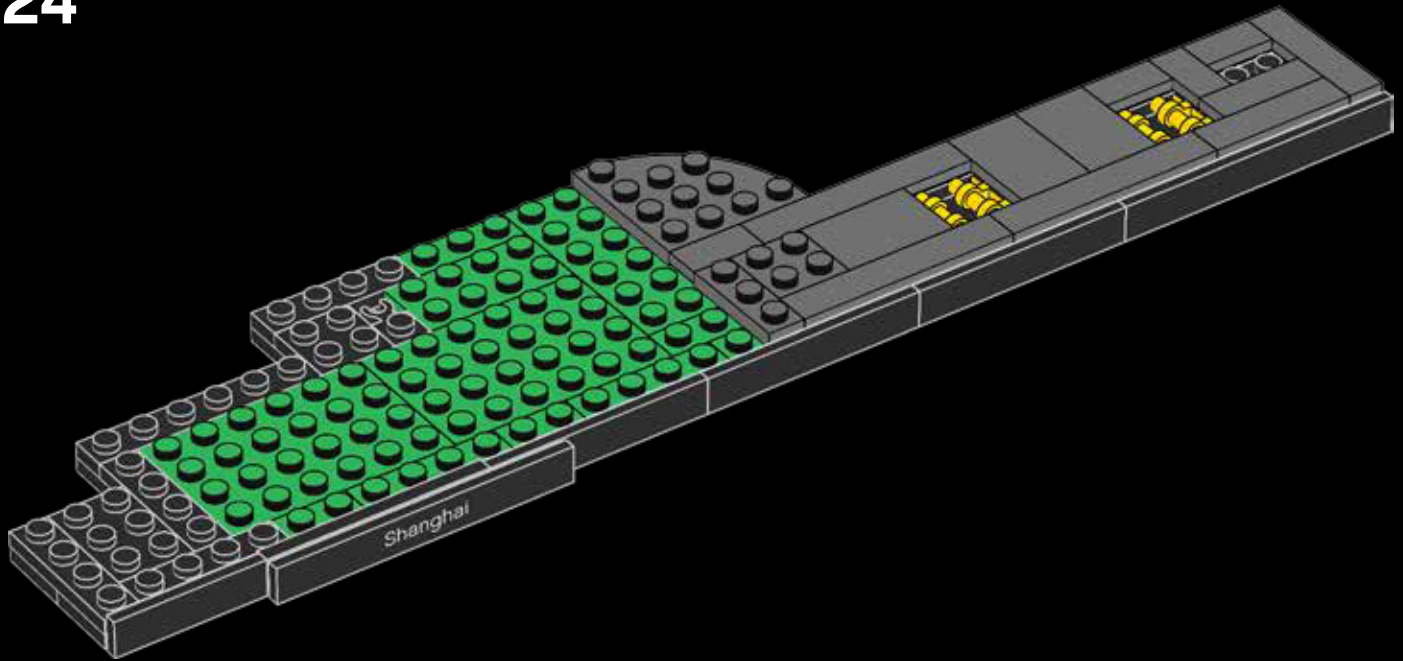



25

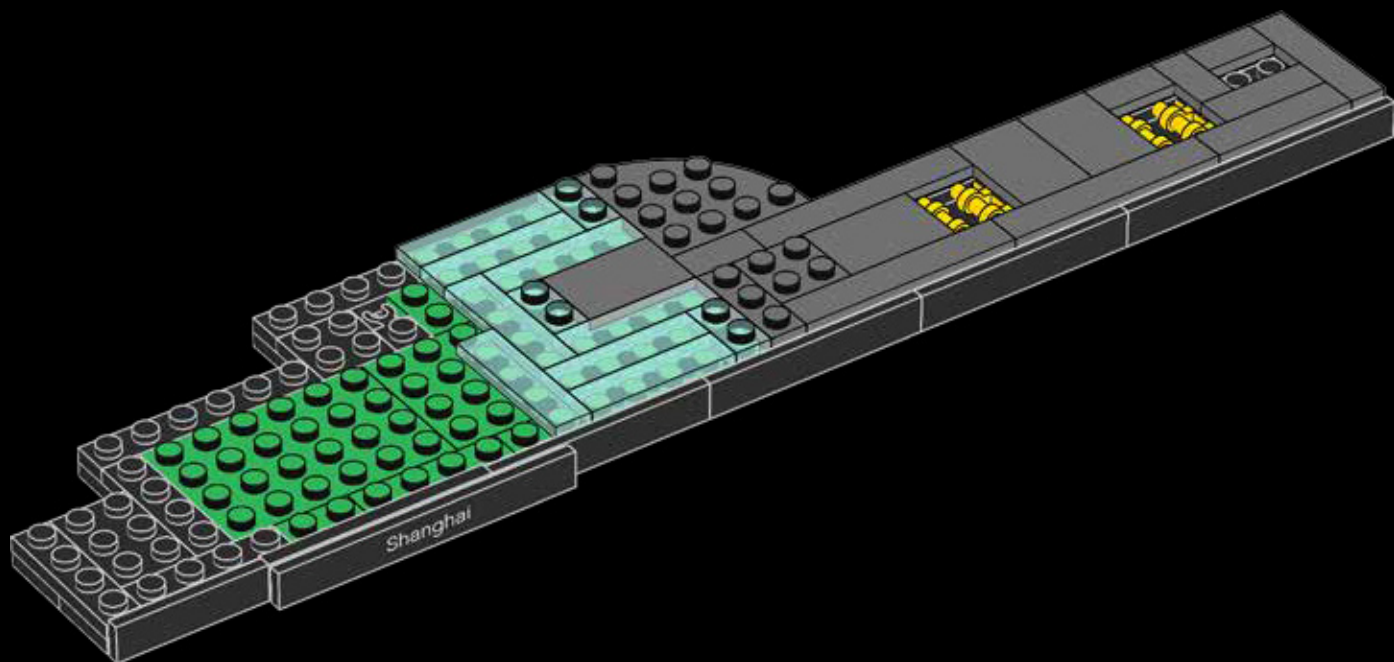

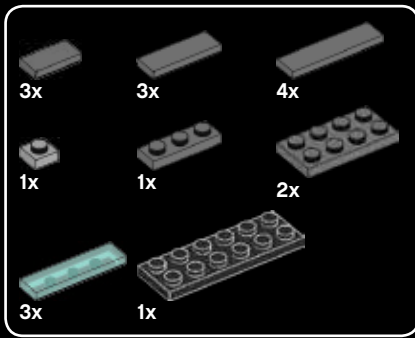

26

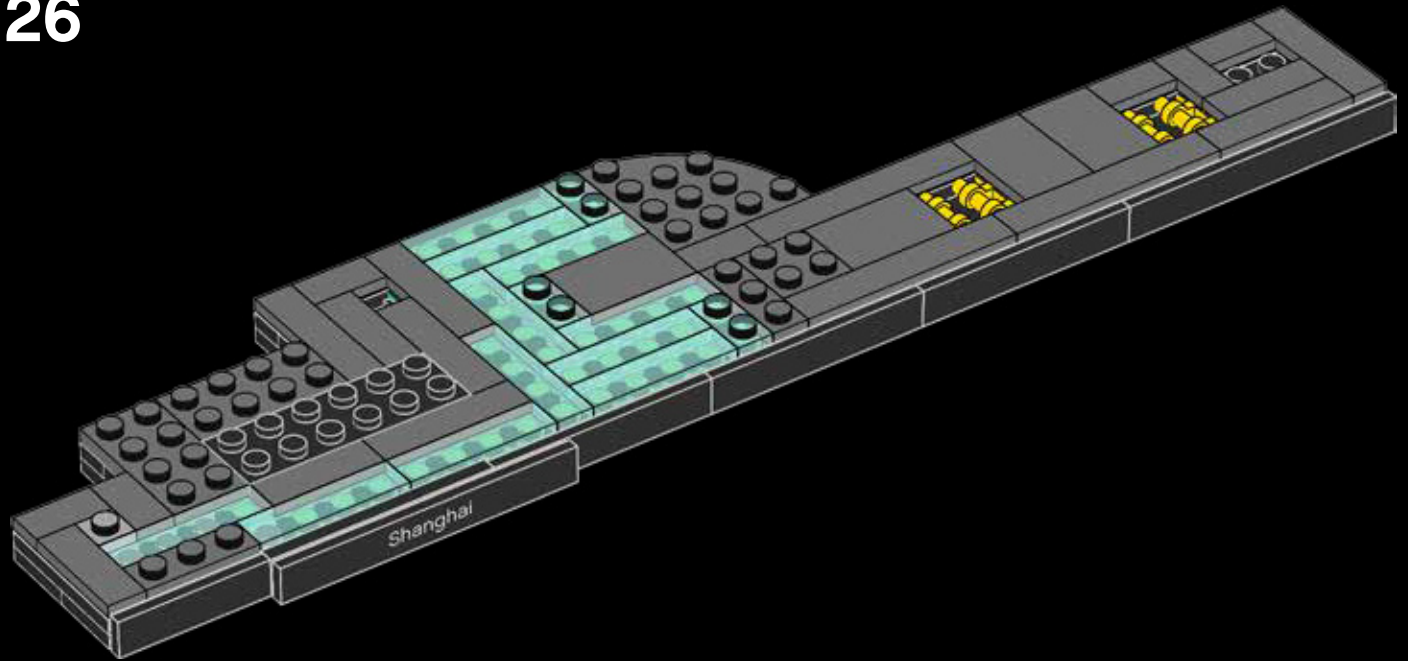

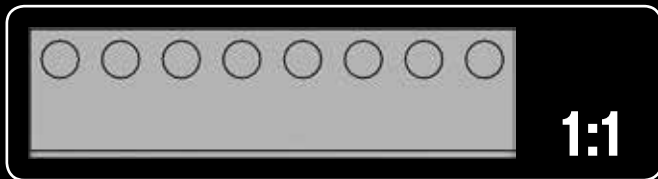
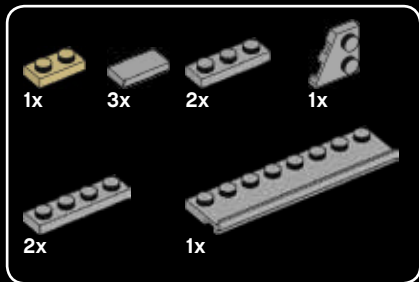

27

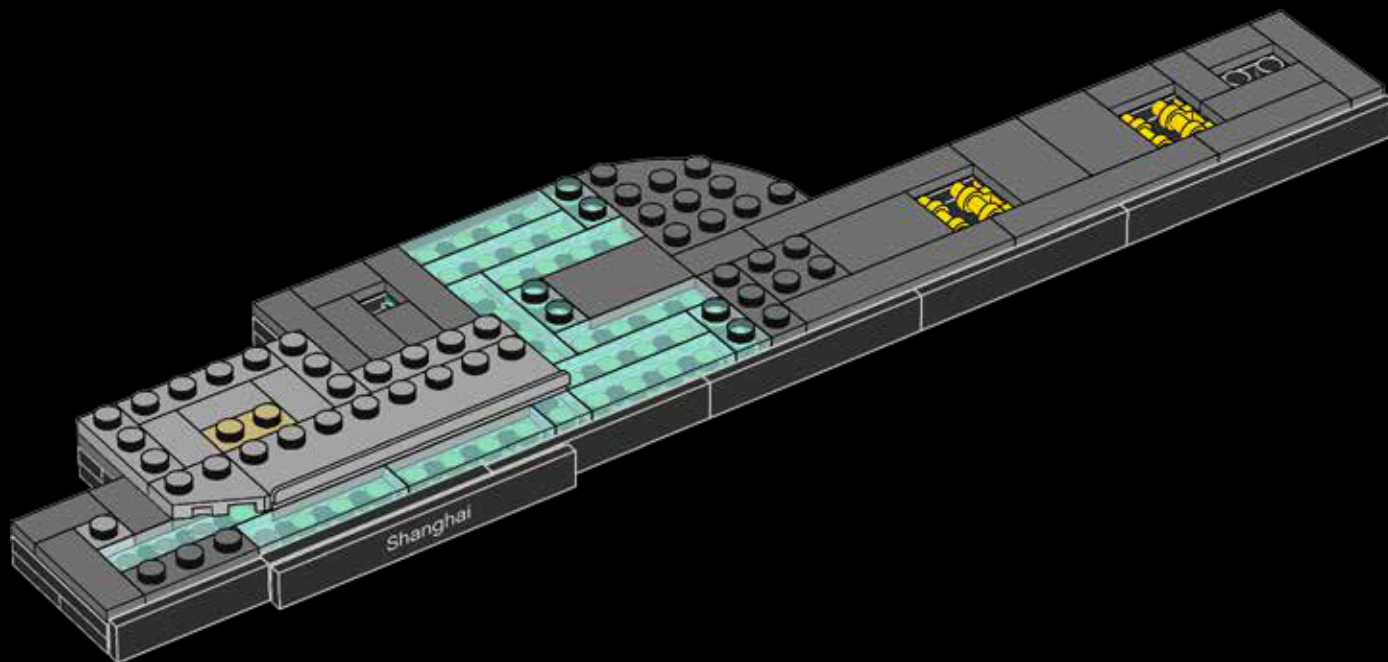



28

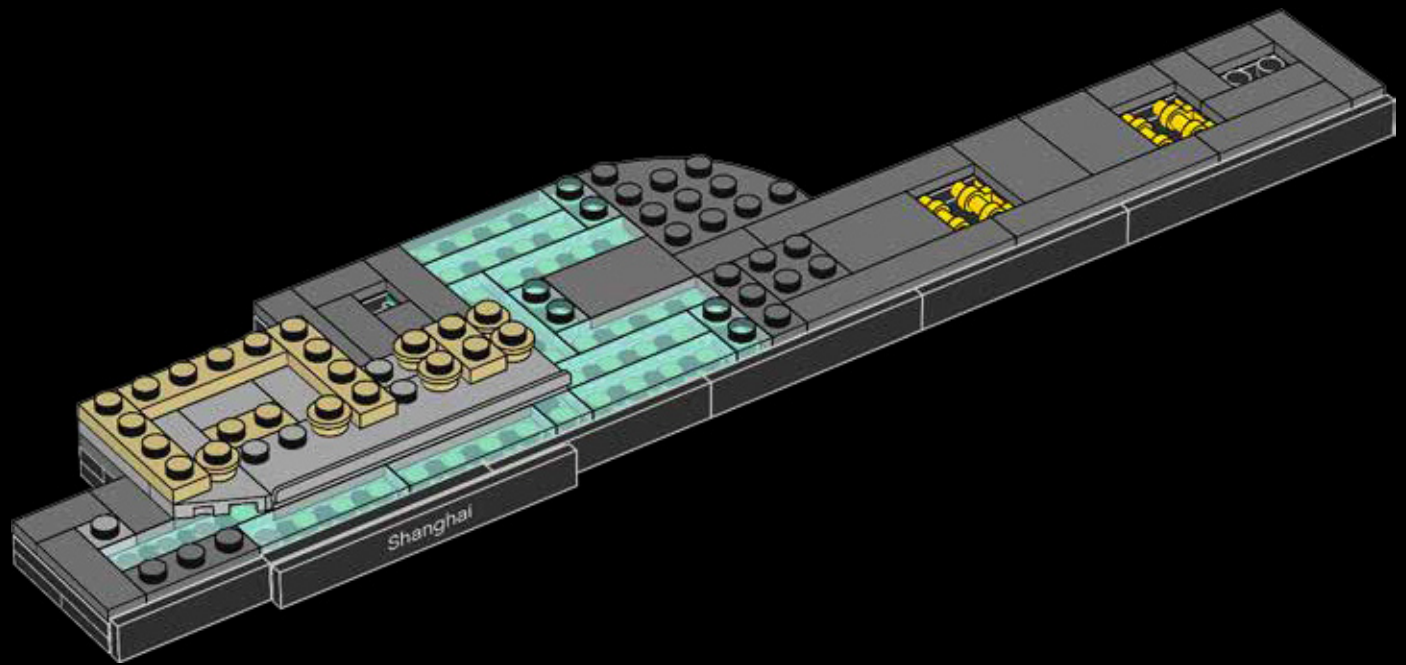



3x

29

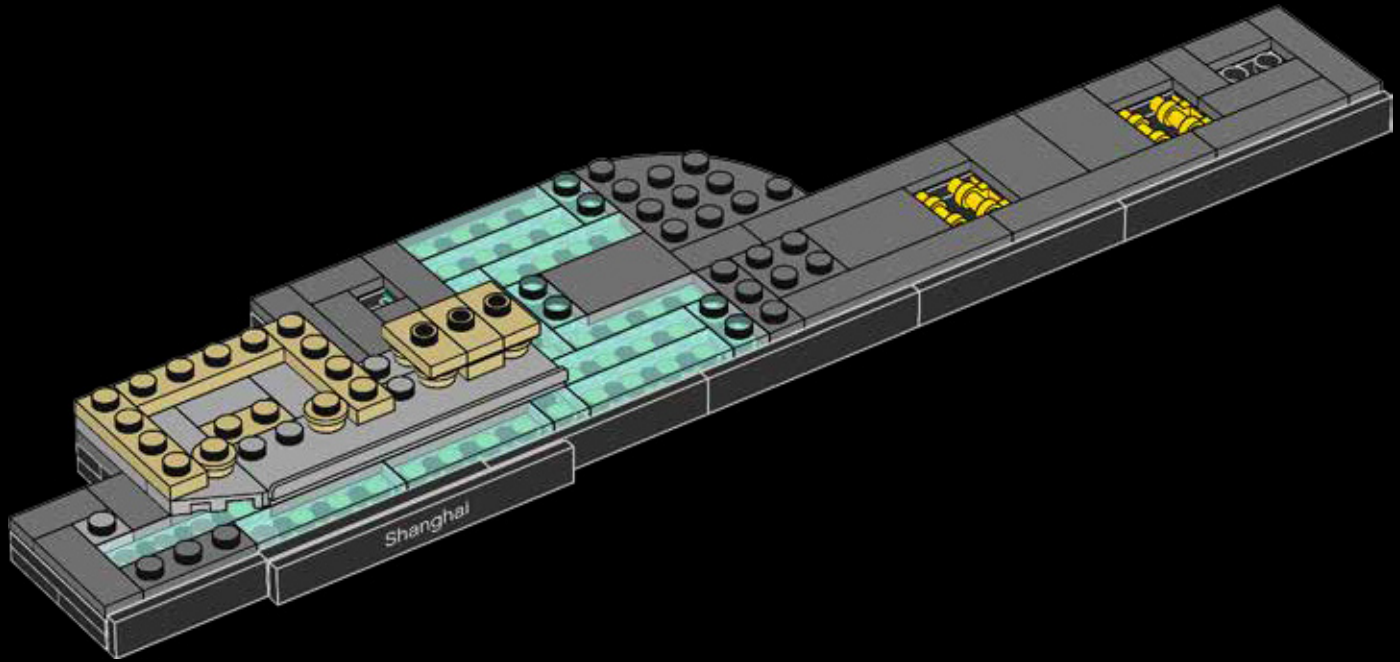



3x

30

The Customs House clock remains
the largest one in Asia today.

海关大楼的大钟至今仍为亚洲最大。

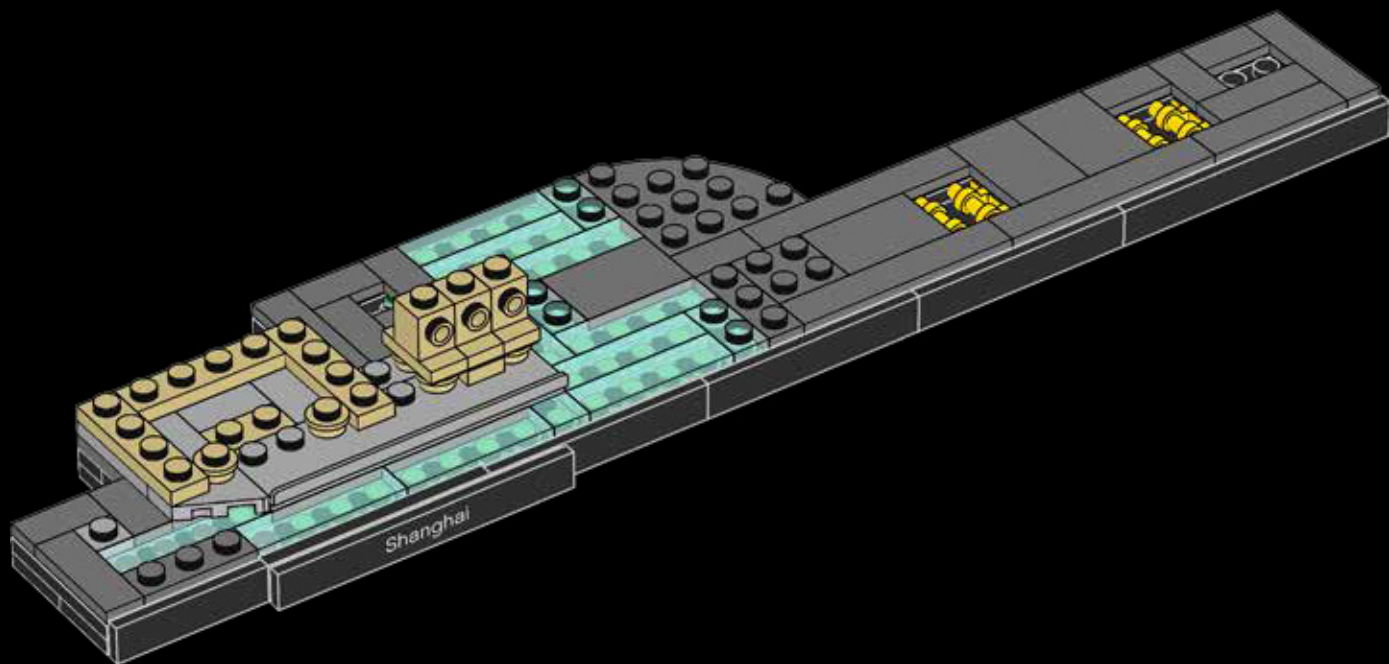

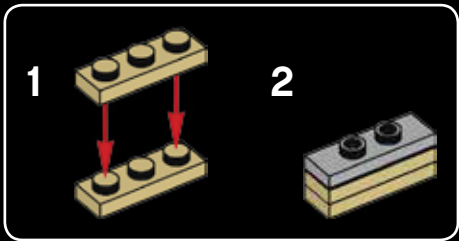

31

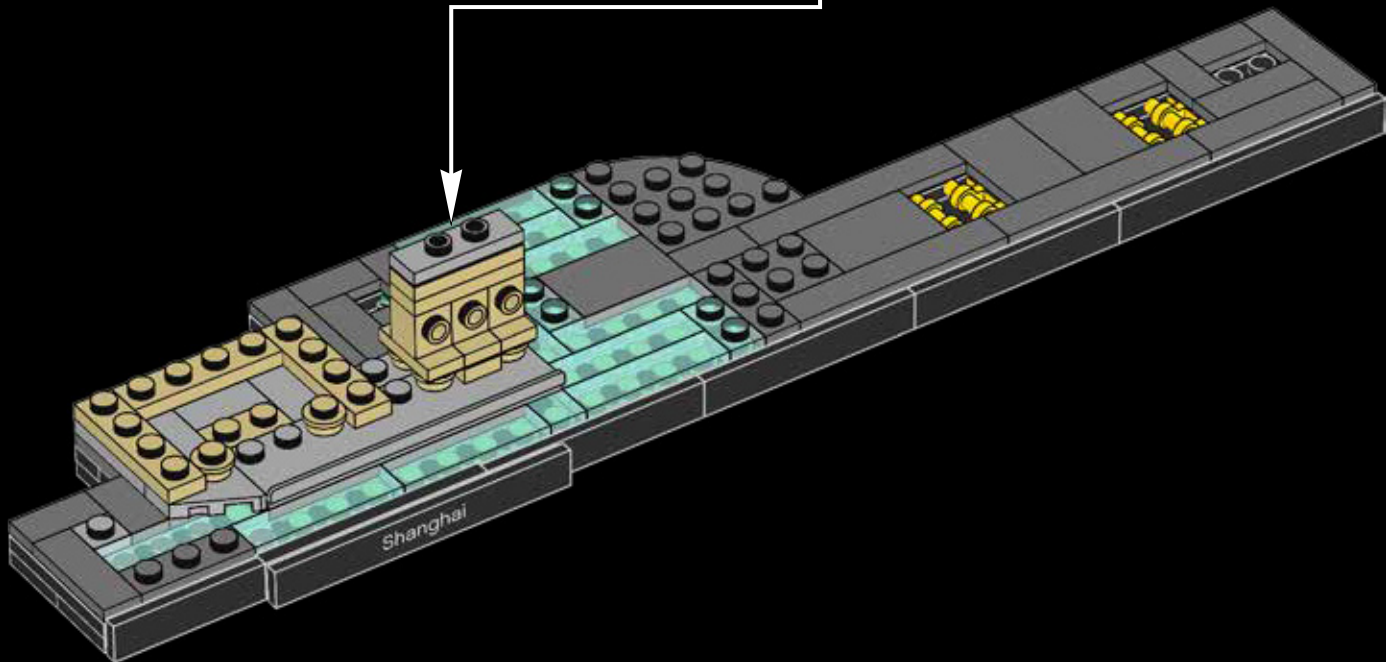



32

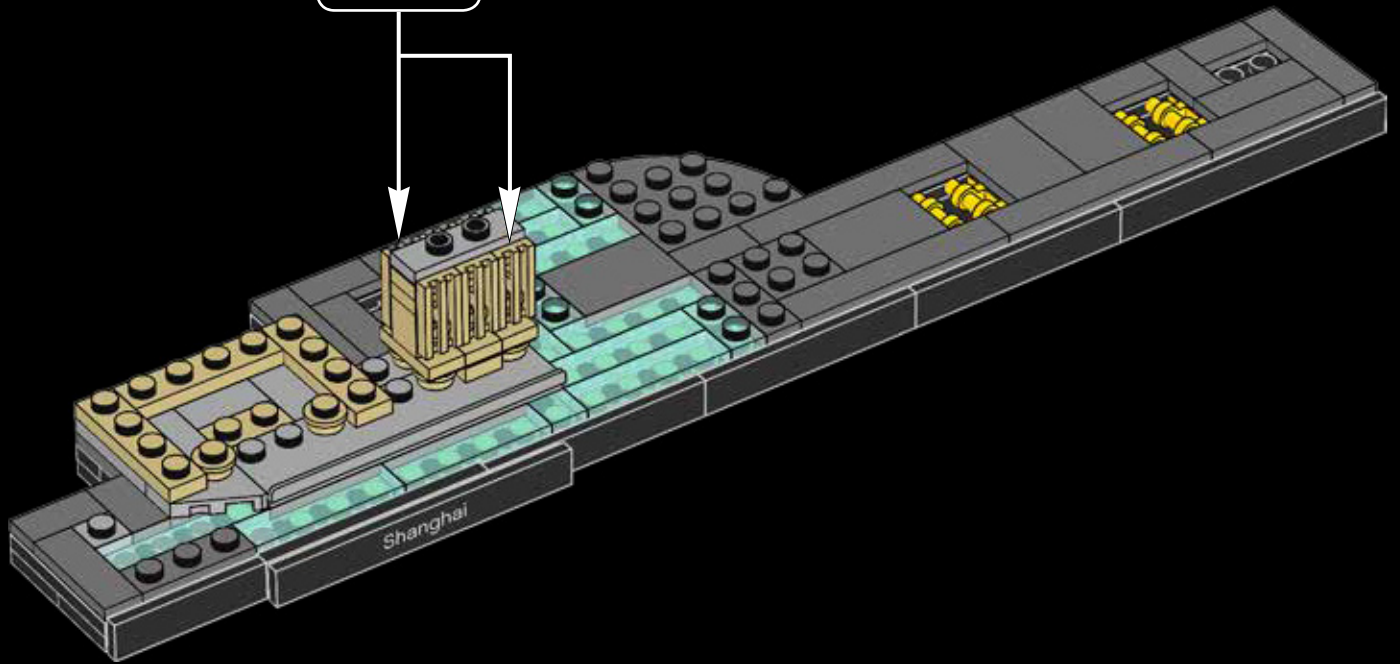

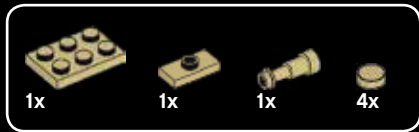

33

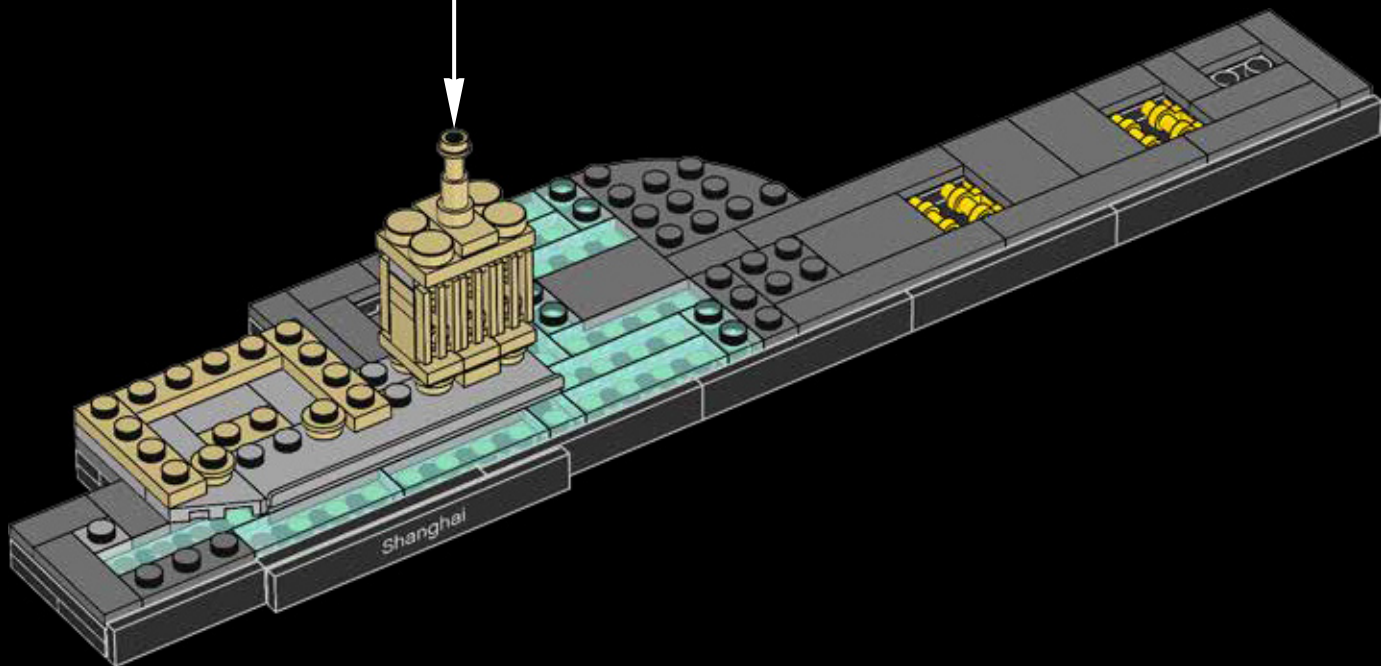
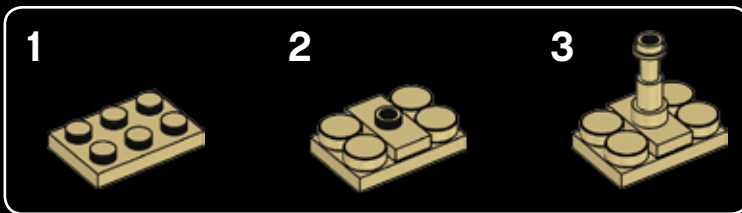

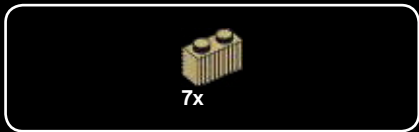

34

Each of the four clock faces in the clock tower has a diameter of 17 ft. (5.3 m) and is made up of 100 pieces of glass.

外滩——海关大楼
钟楼四周四个钟面，每面直径为17英尺（5.3米），
由100块玻璃拼成。

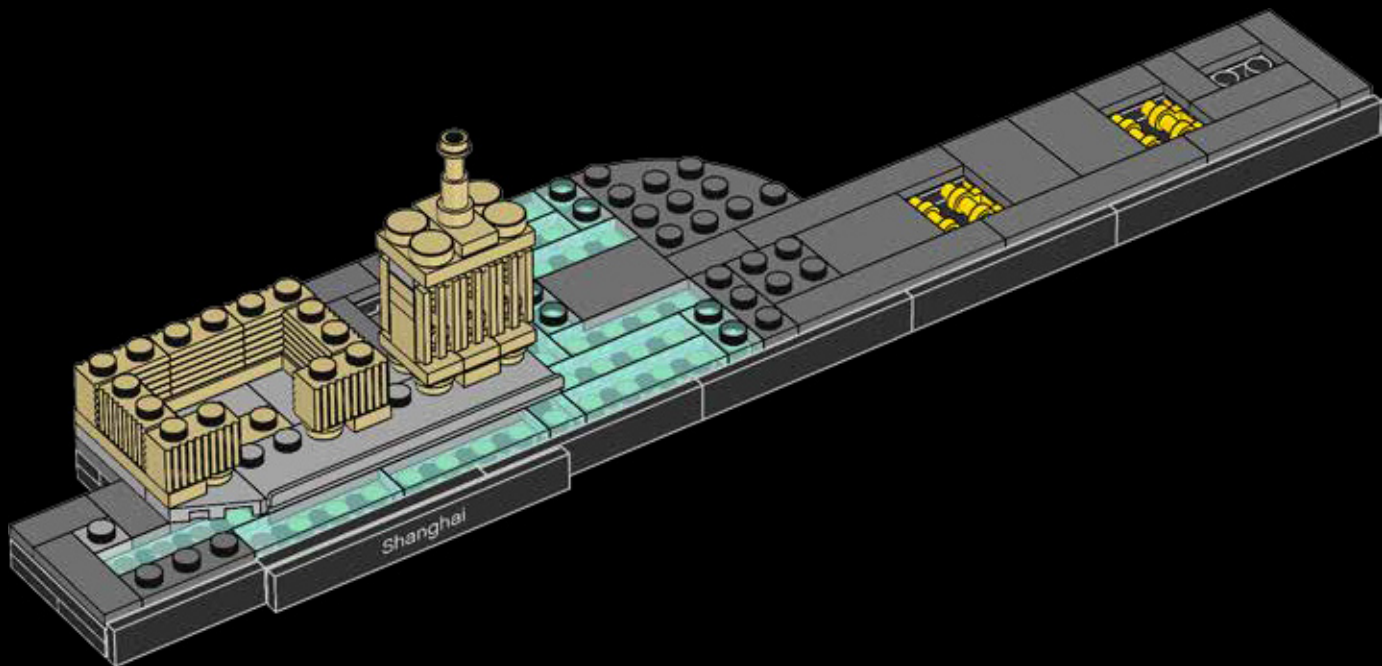



35

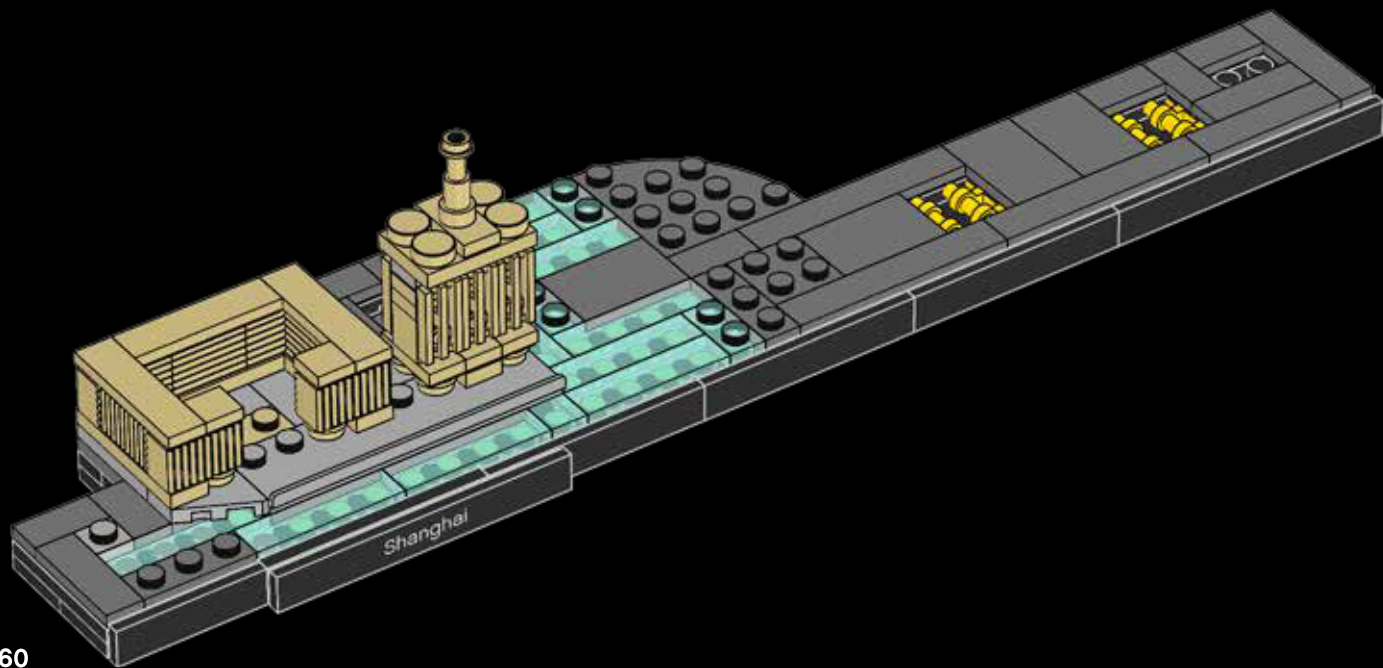

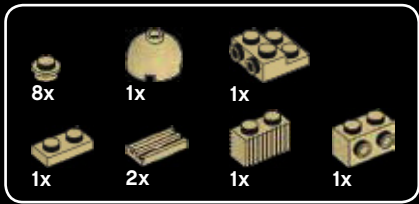

36

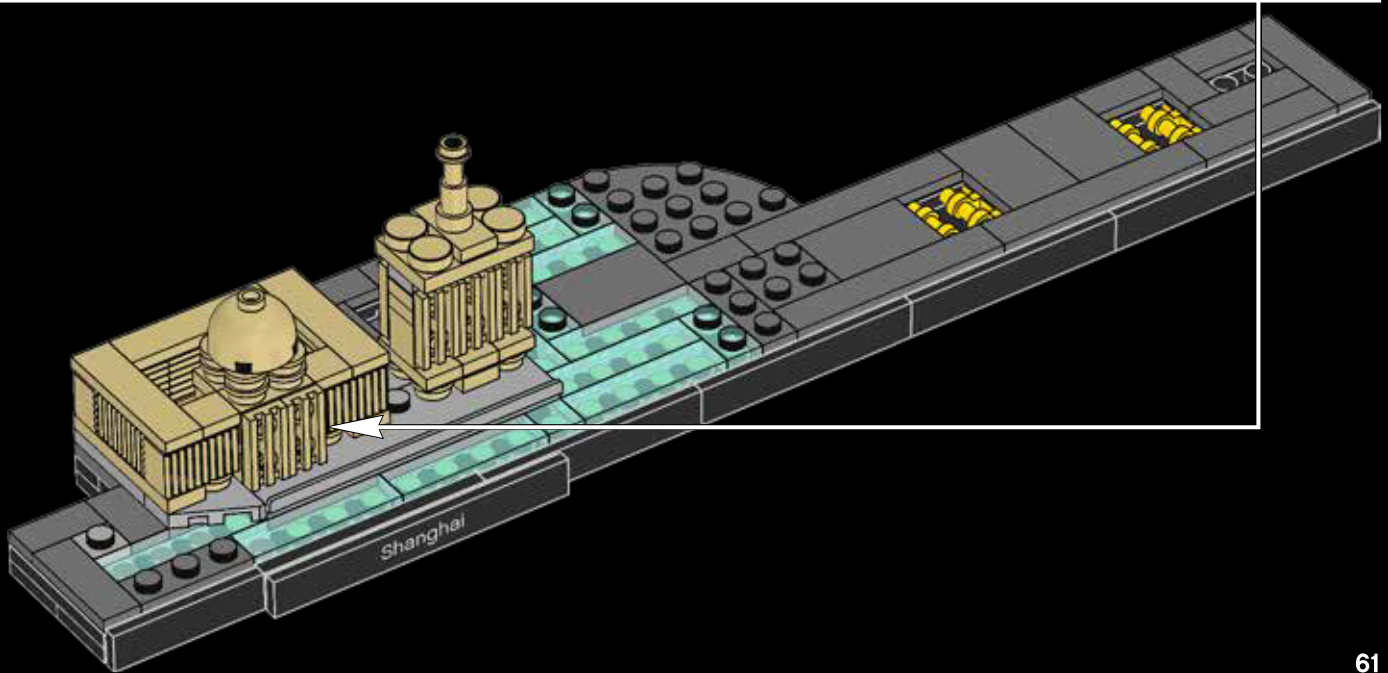
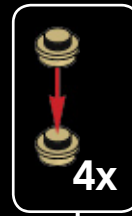
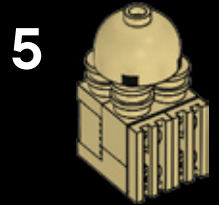
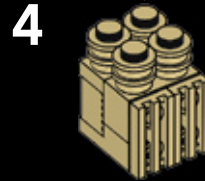
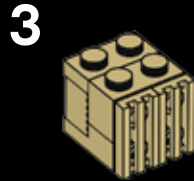
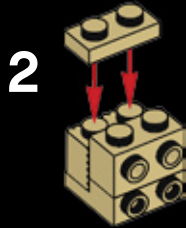
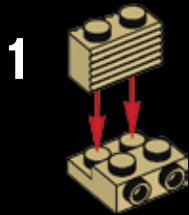

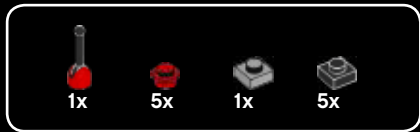

37

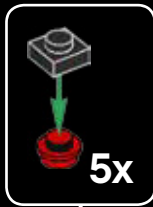

1



2



3

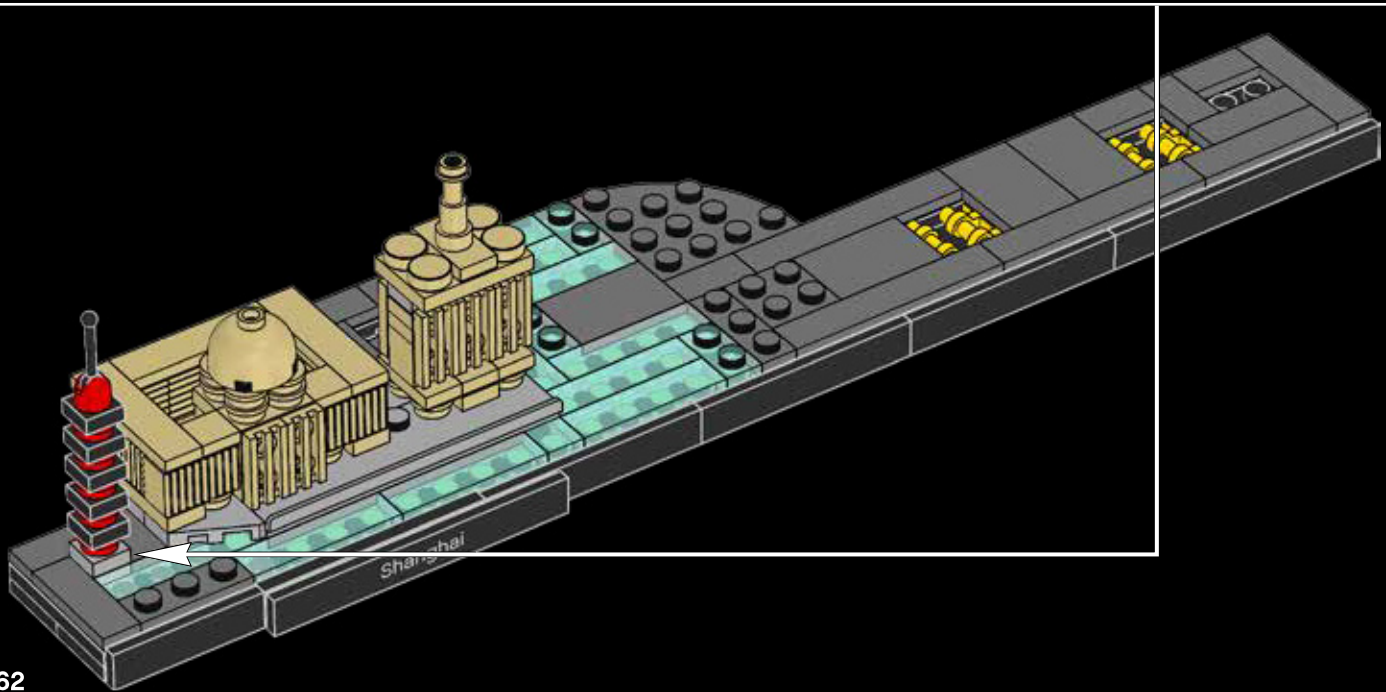



Many Shanghai residents frequent the temple to offer incense before their favorite local god, hoping for good fortune in return.

龙华塔
众多上海居民常到寺庙里为当地最喜爱的神上香, 祈望获得好运。



38

1



2



3



4

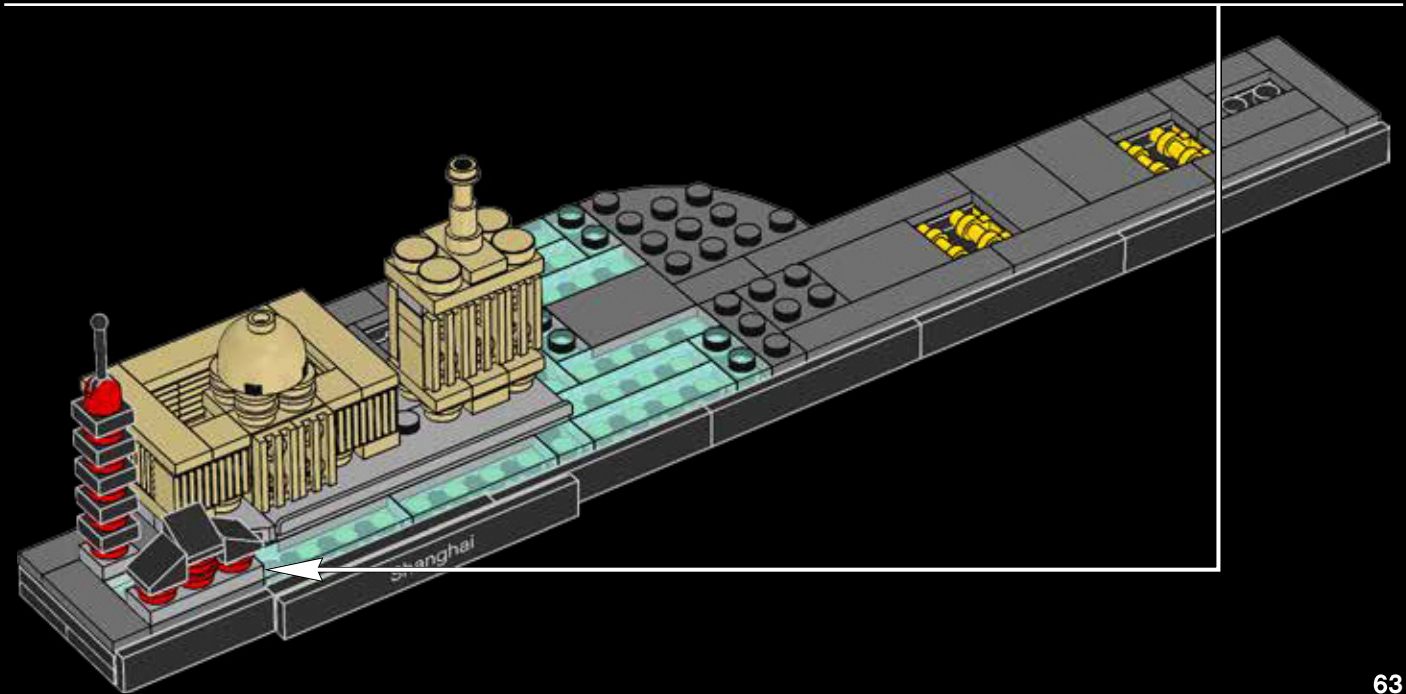

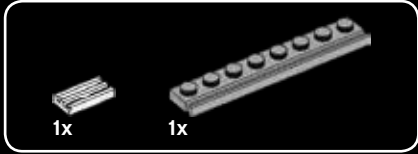

39

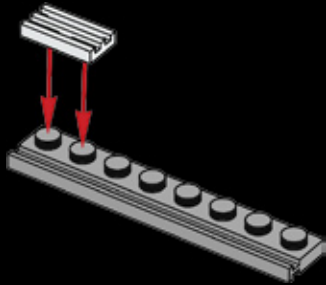

40

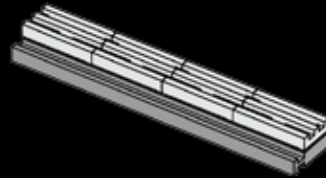



41

1



2



3



4



5



6

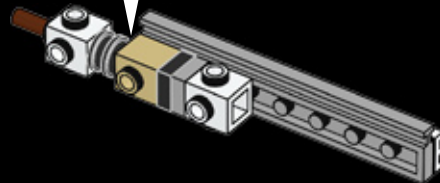
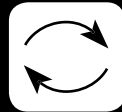



42

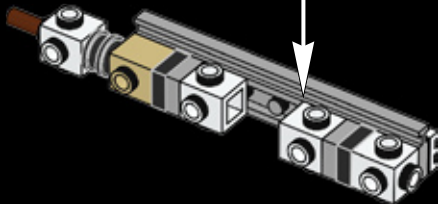
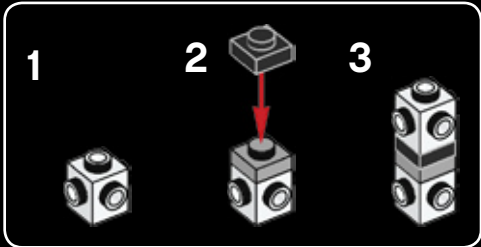



43

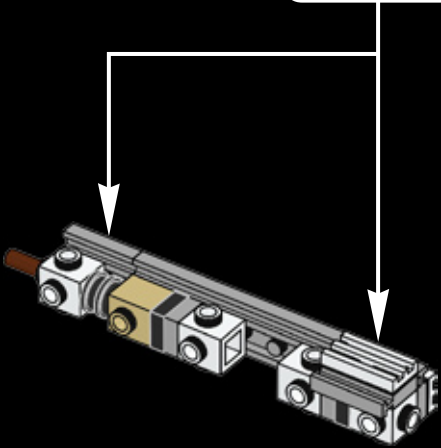
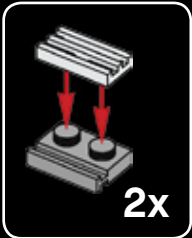

44

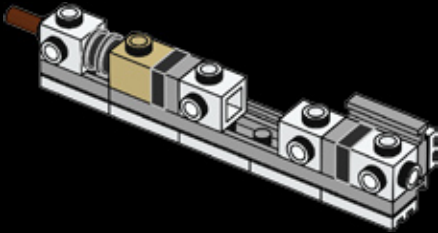

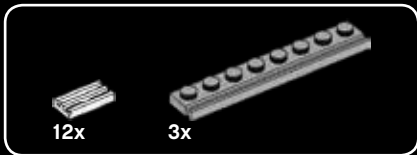

45

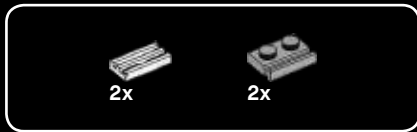
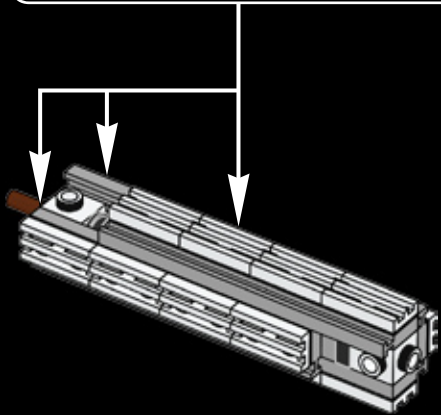
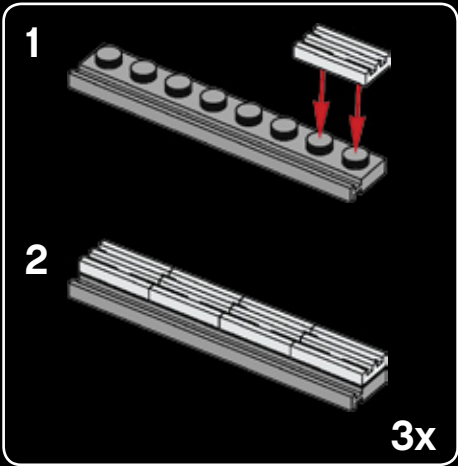

46

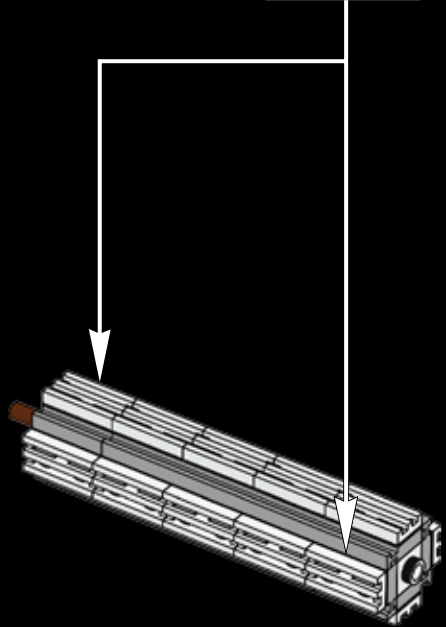
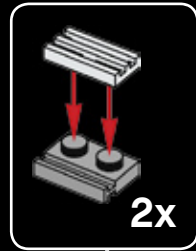

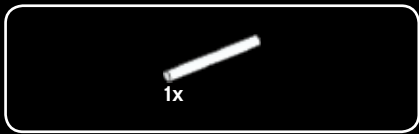

47

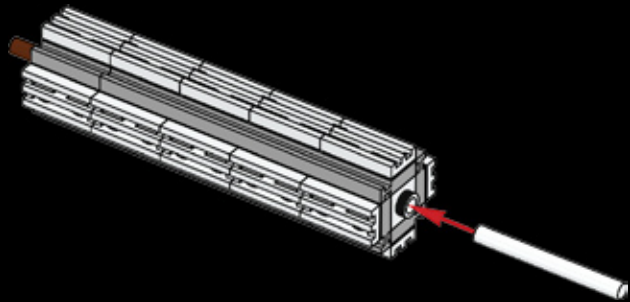

48

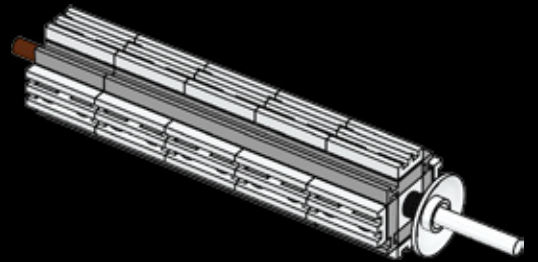

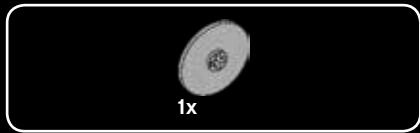

49

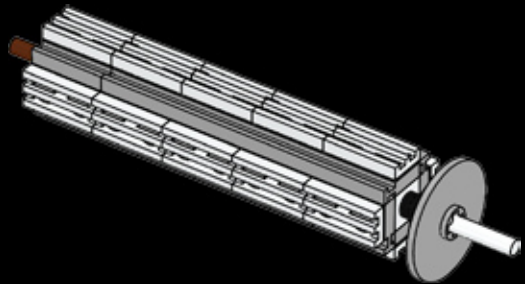

50

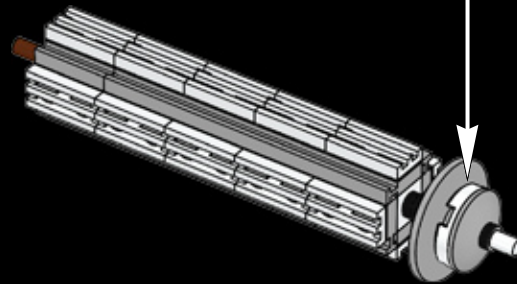

51

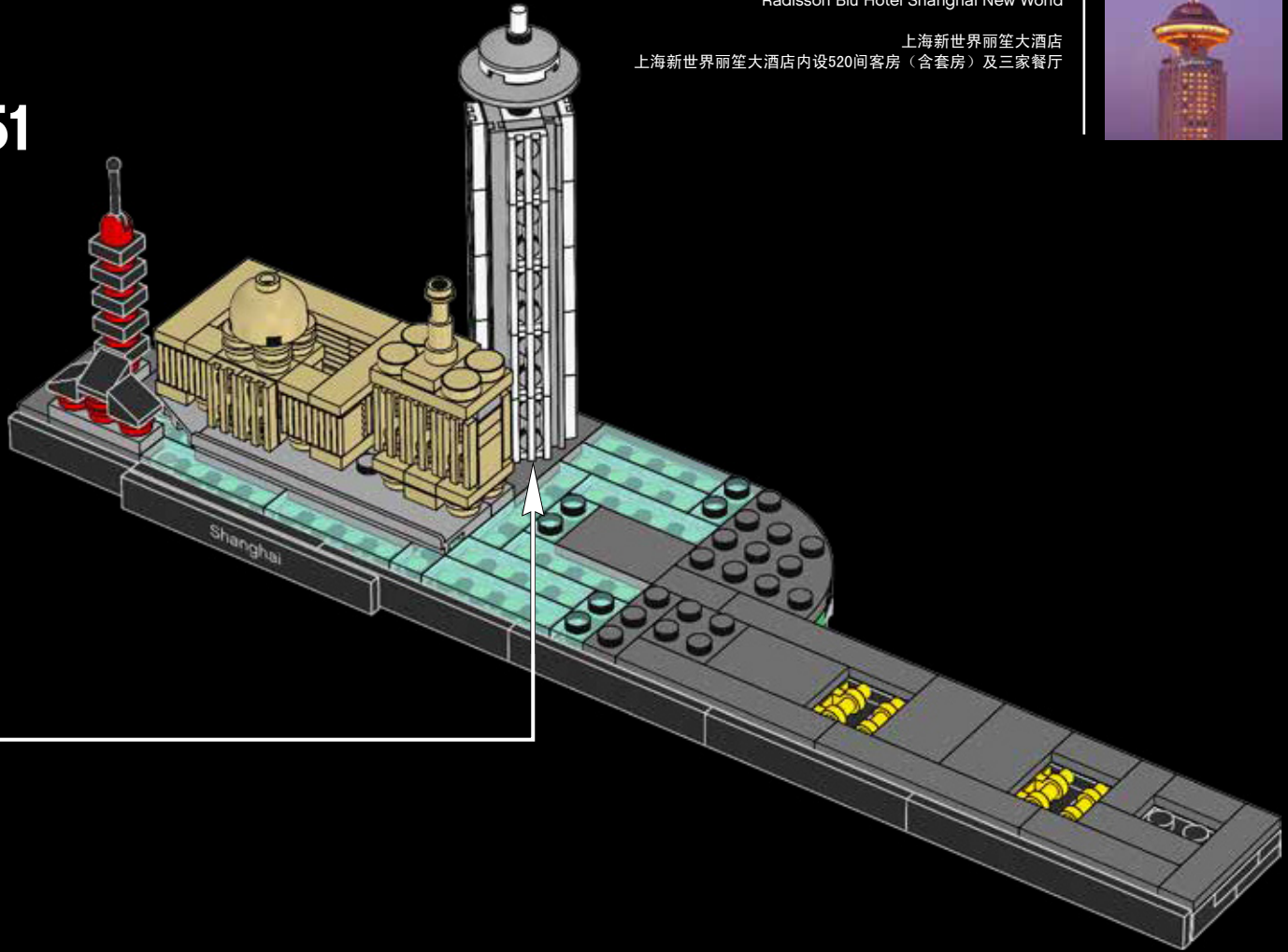

There are 520 rooms and suites, plus three restaurants in the Raddison Blu Hotel Shanghai New World

上海新世界丽笙大酒店
上海新世界丽笙大酒店内设520间客房（含套房）及三家餐厅





4x

52

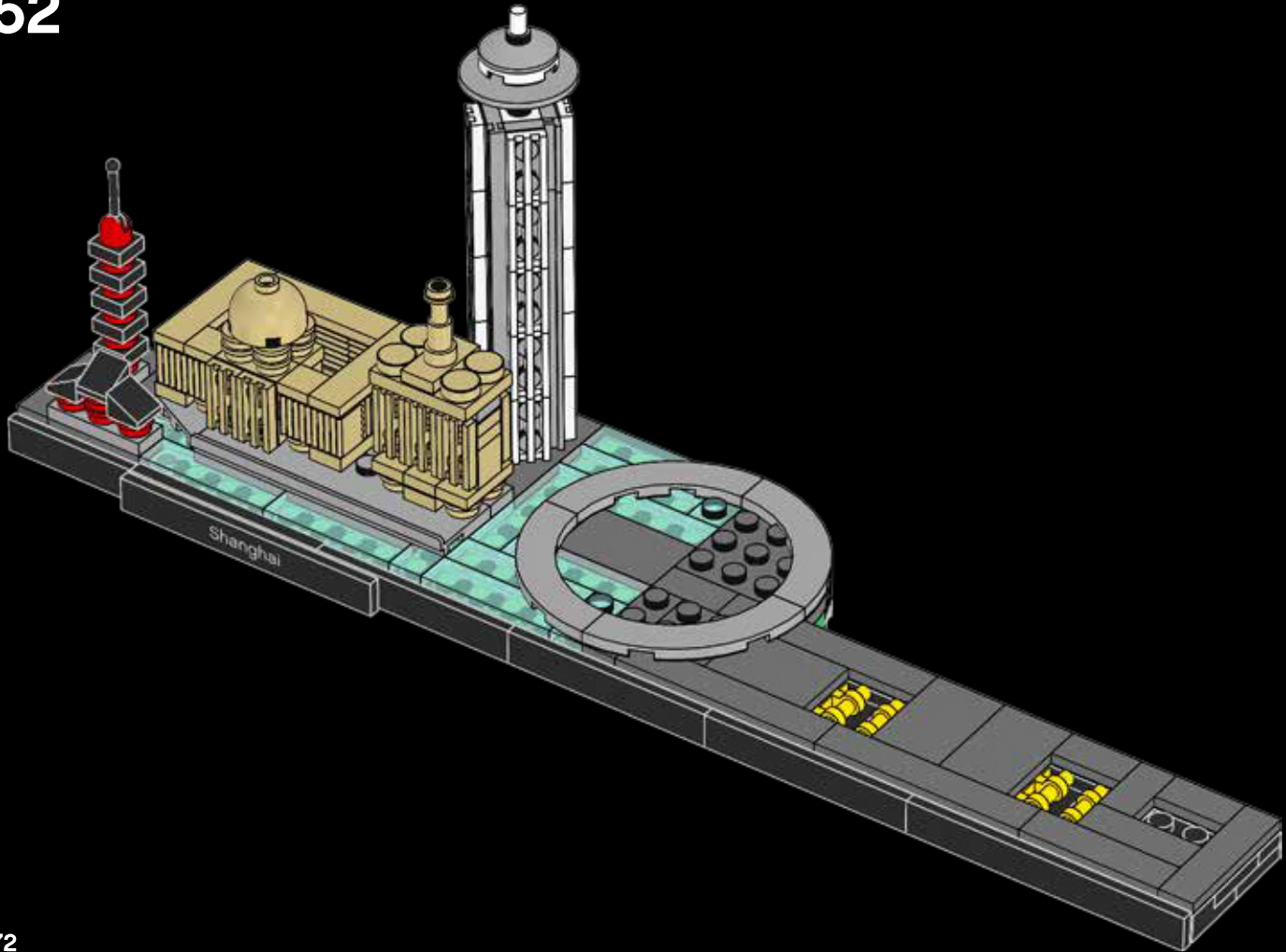

72

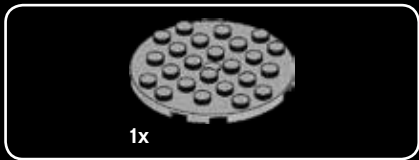

53

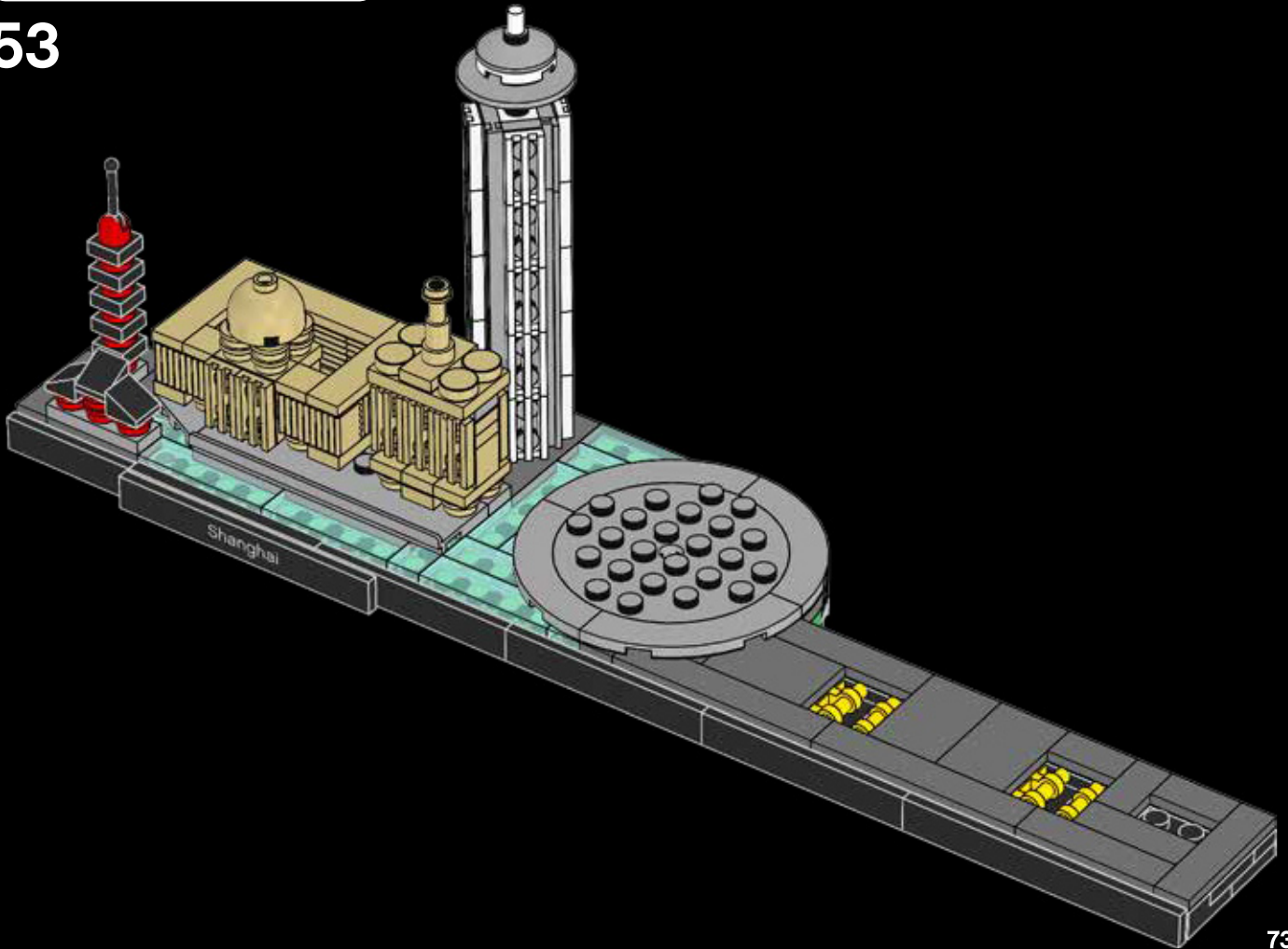

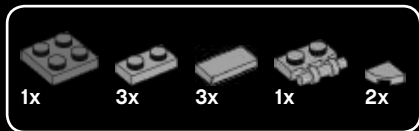

54

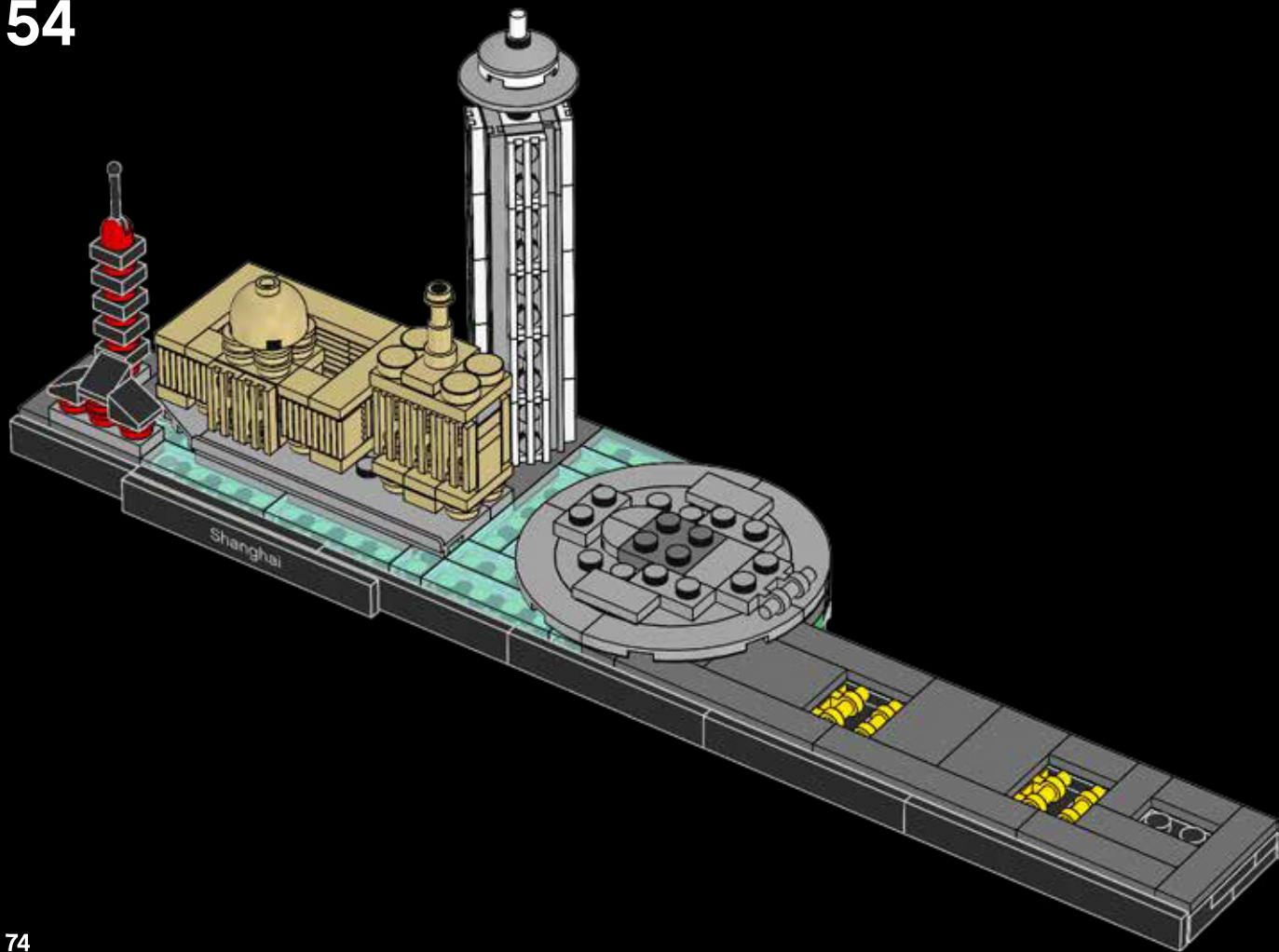



55

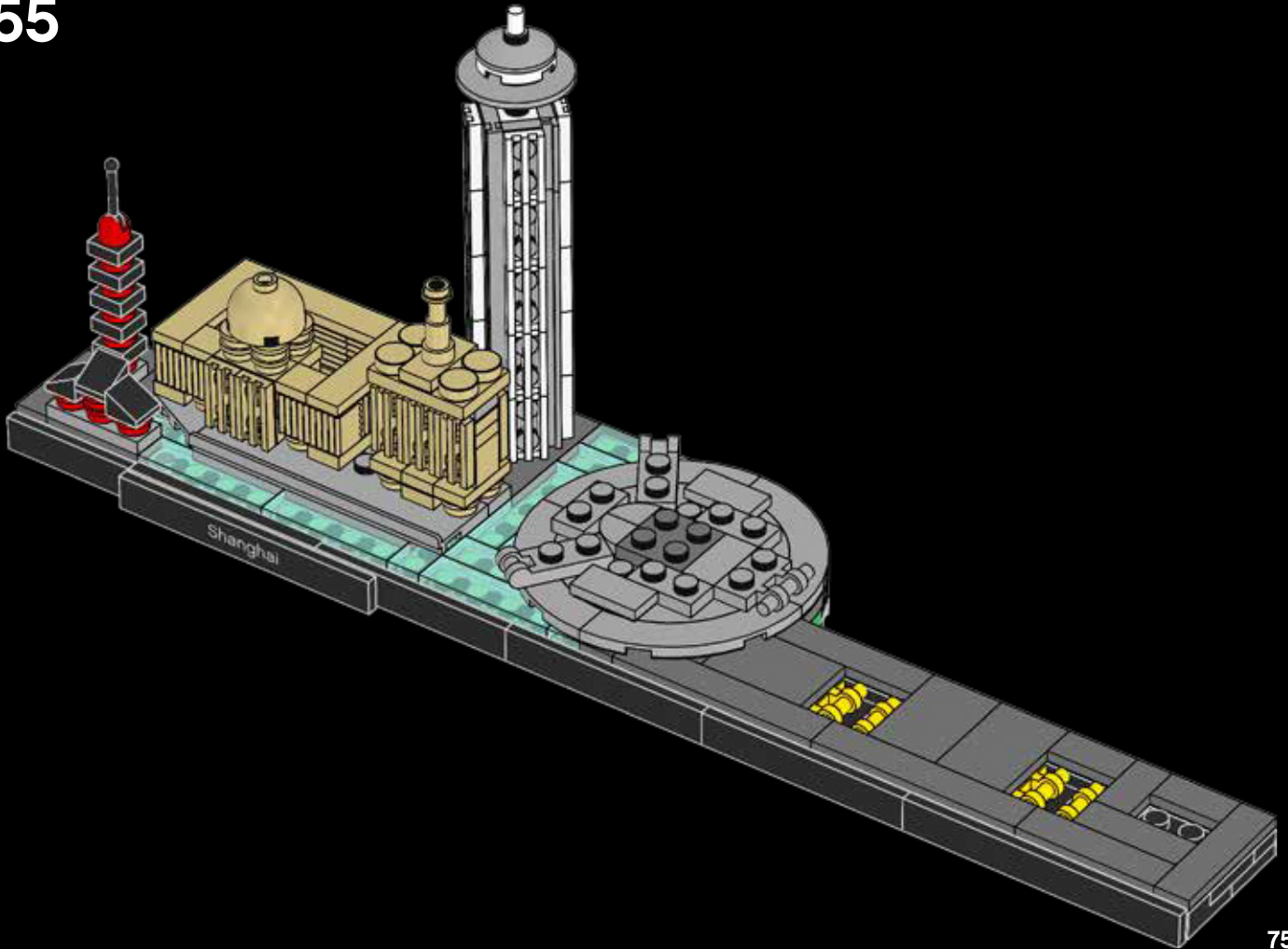

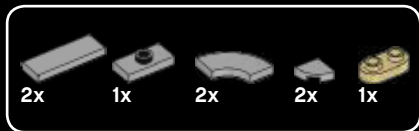

56

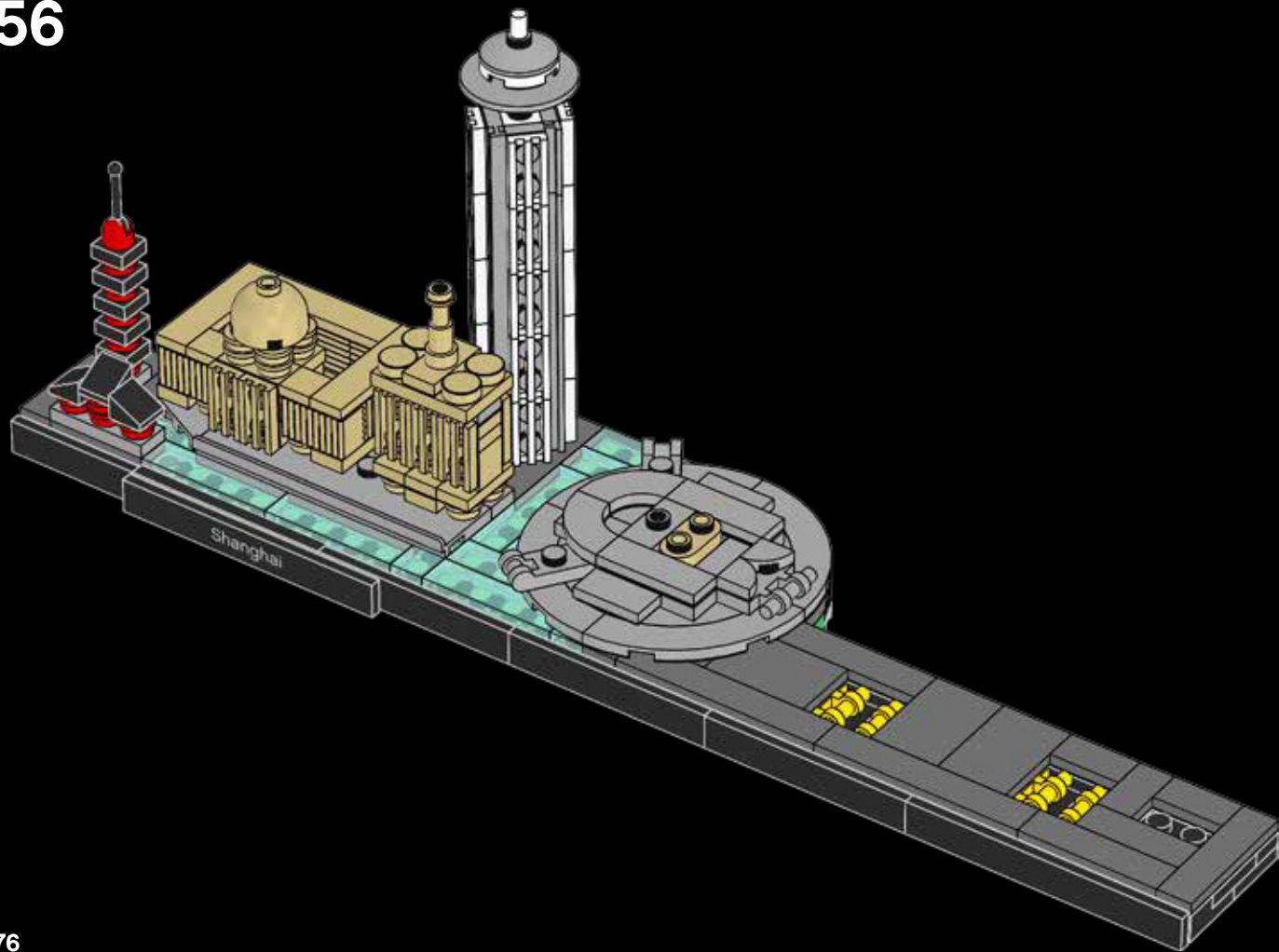



57

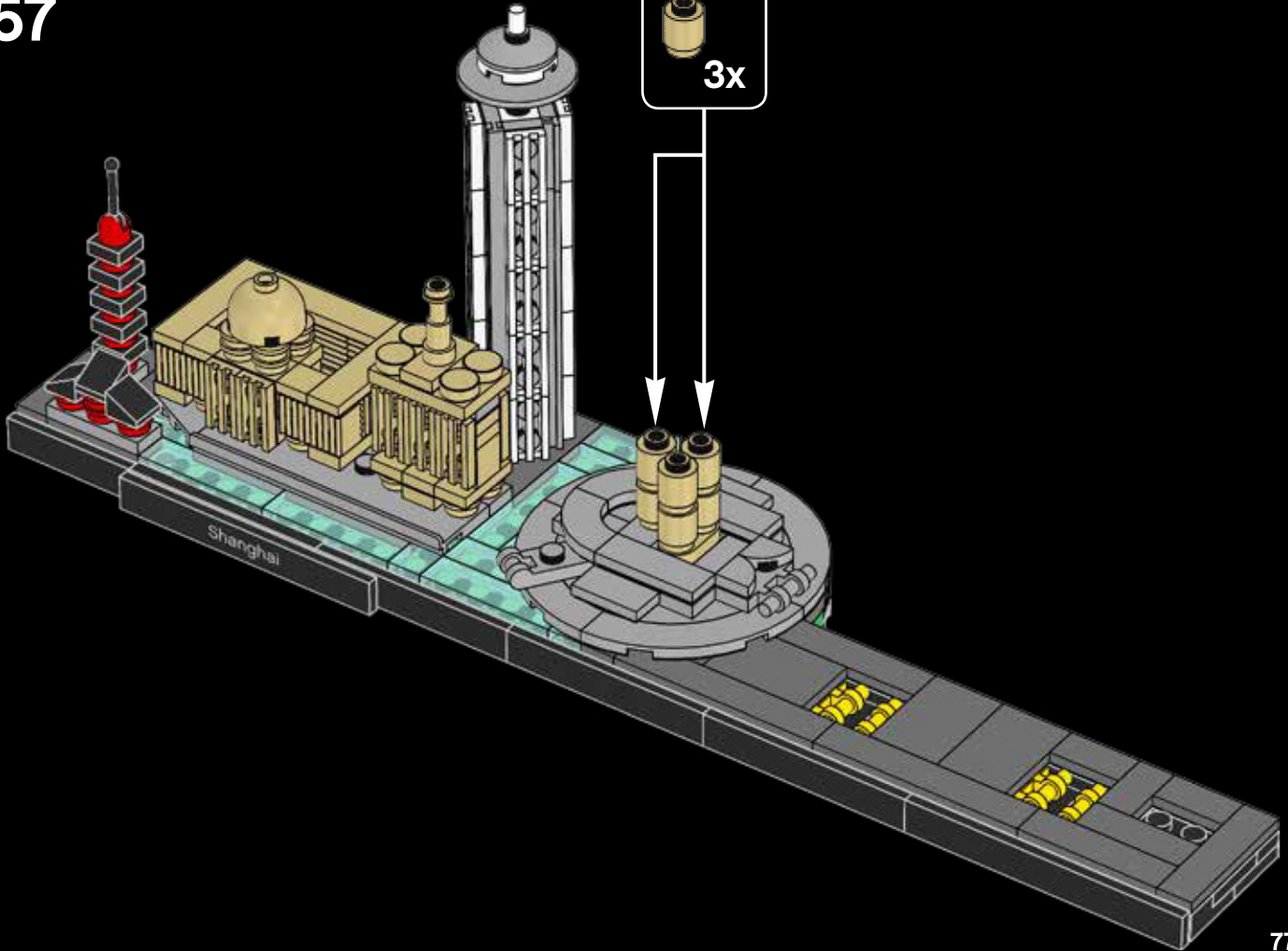
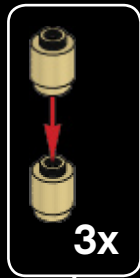

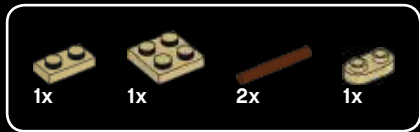

58

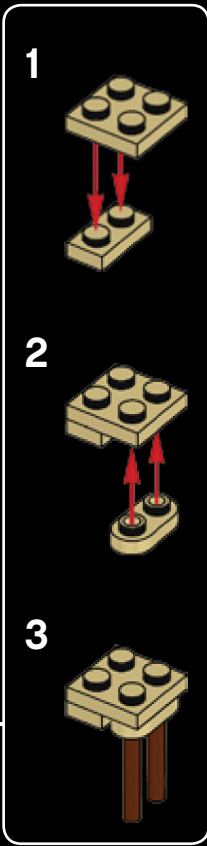
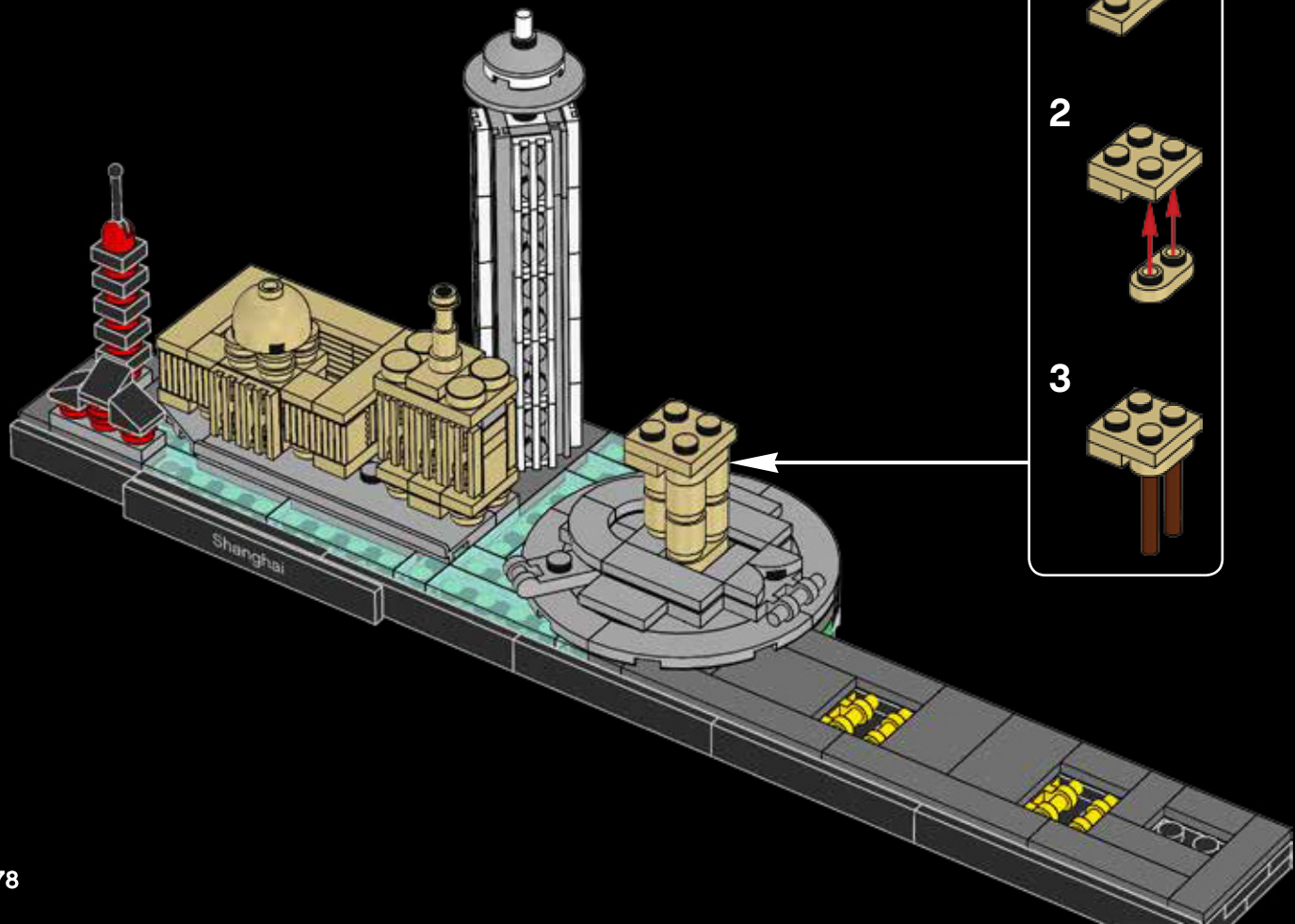



59

The Tower contains a revolving restaurant, an exhibition center and a small 20-room hotel.

塔内配有一家旋转餐厅、一个展览中心和一个内设20套客房的小旅馆。



1



2

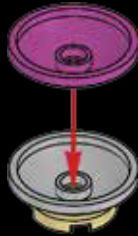

3



4



5



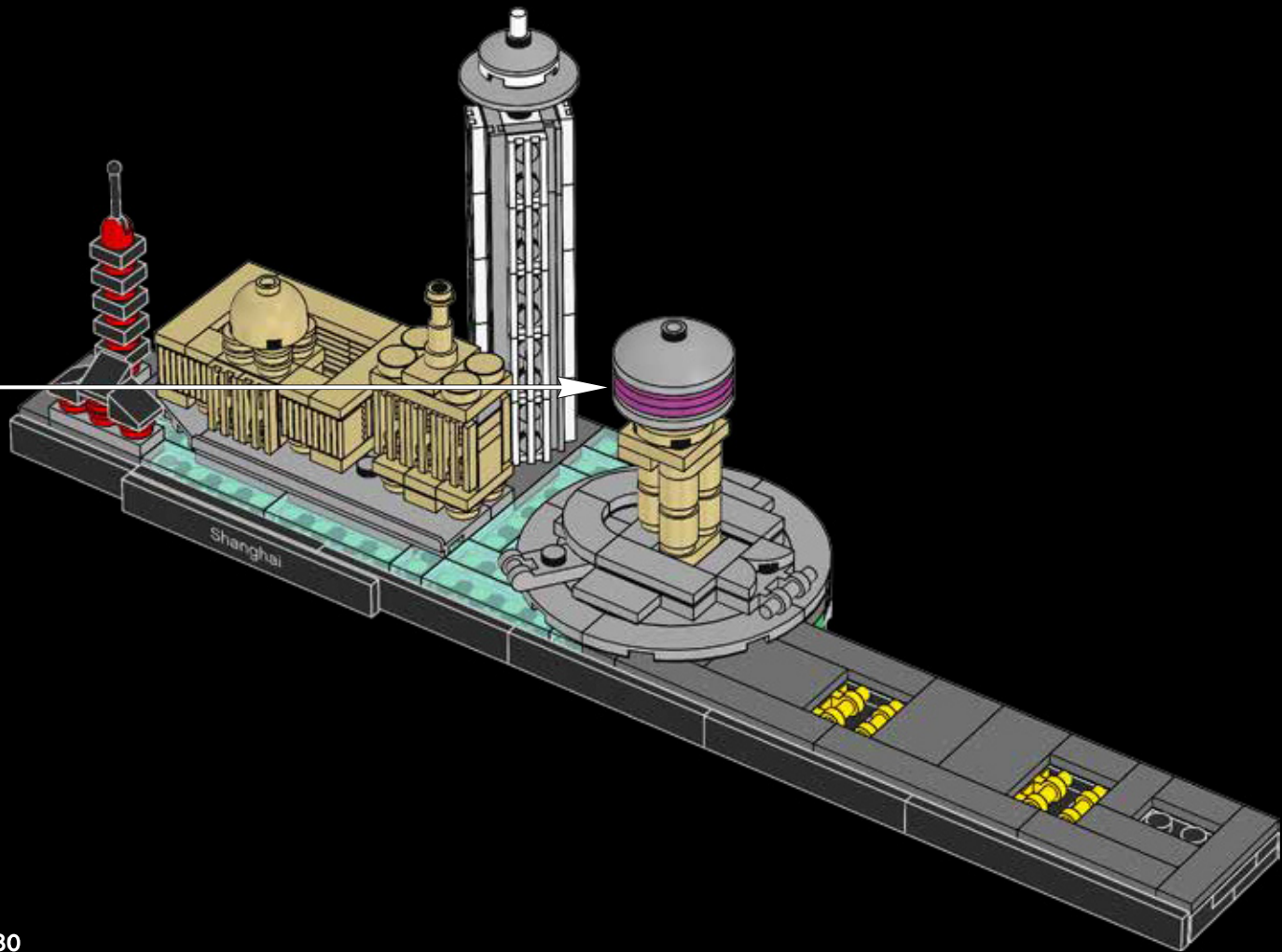



60

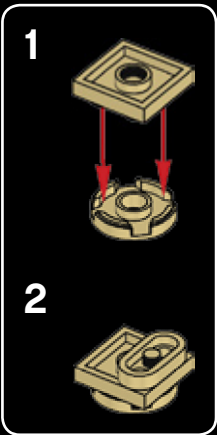
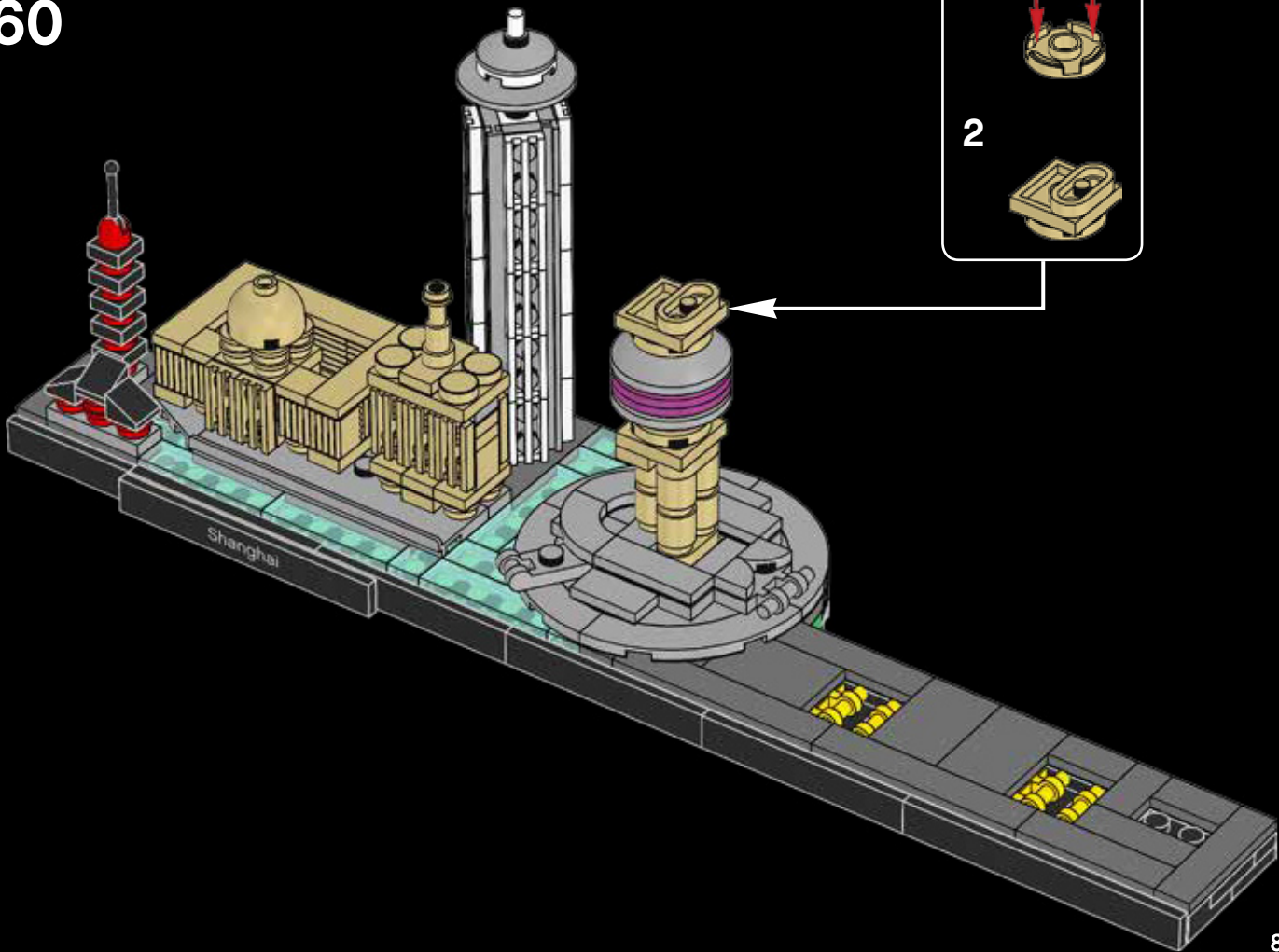



61

1



2



3



4



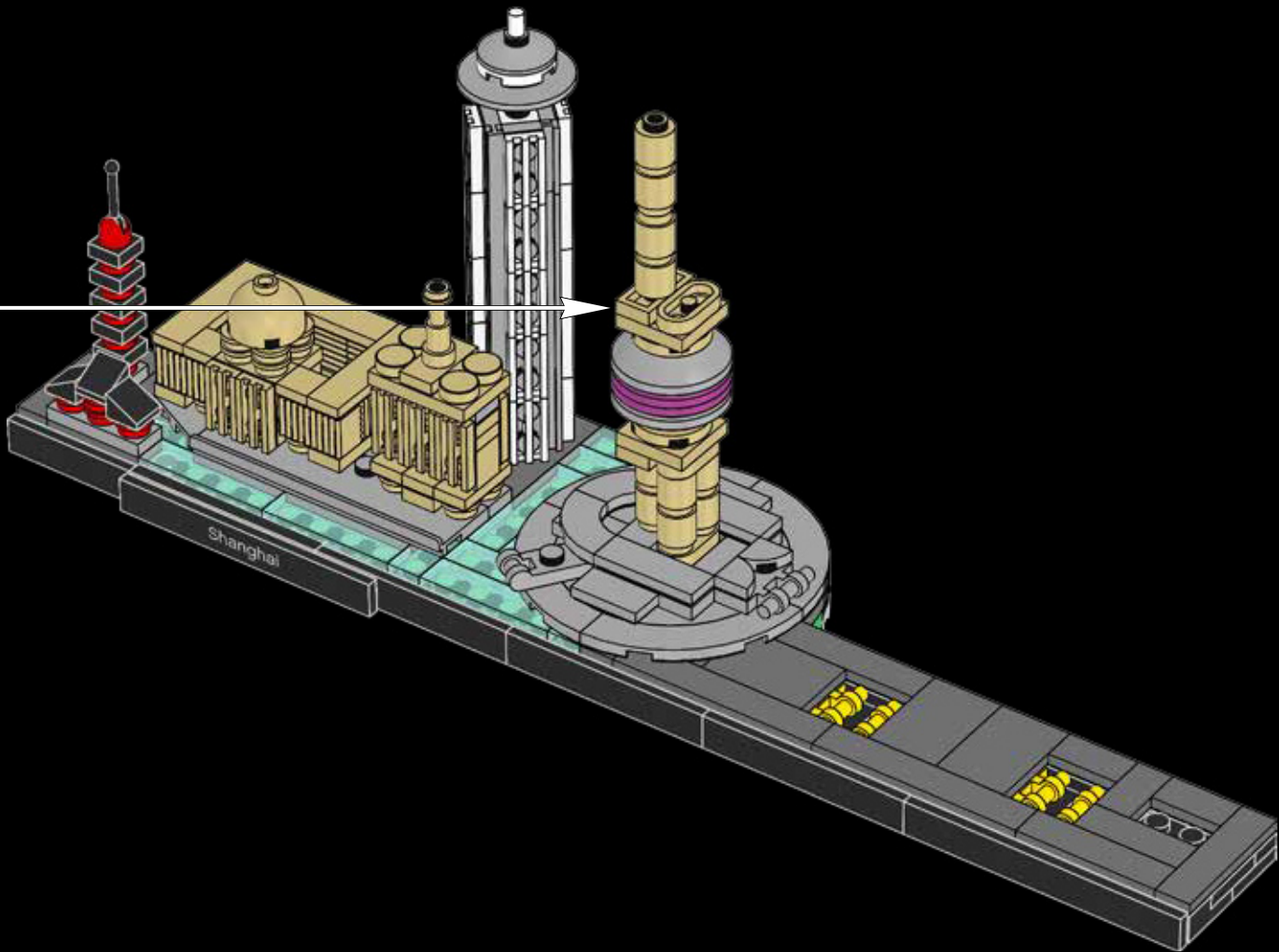

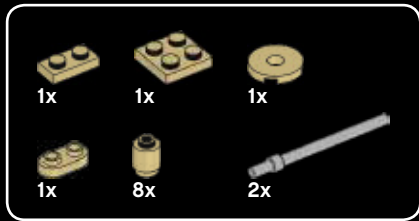

62

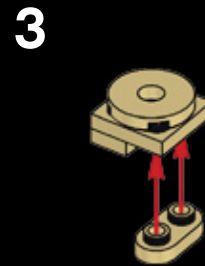
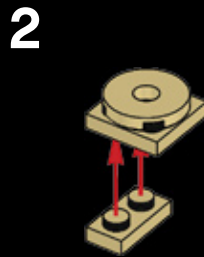
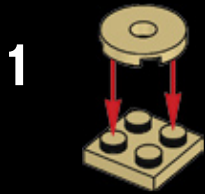

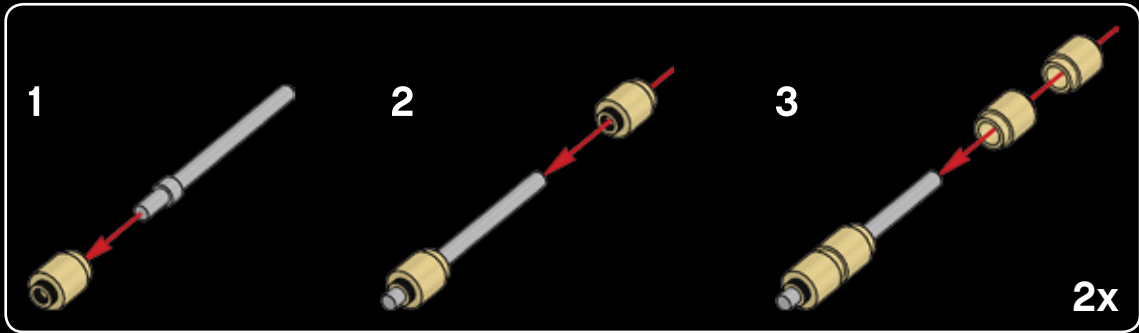

4

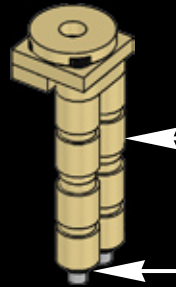

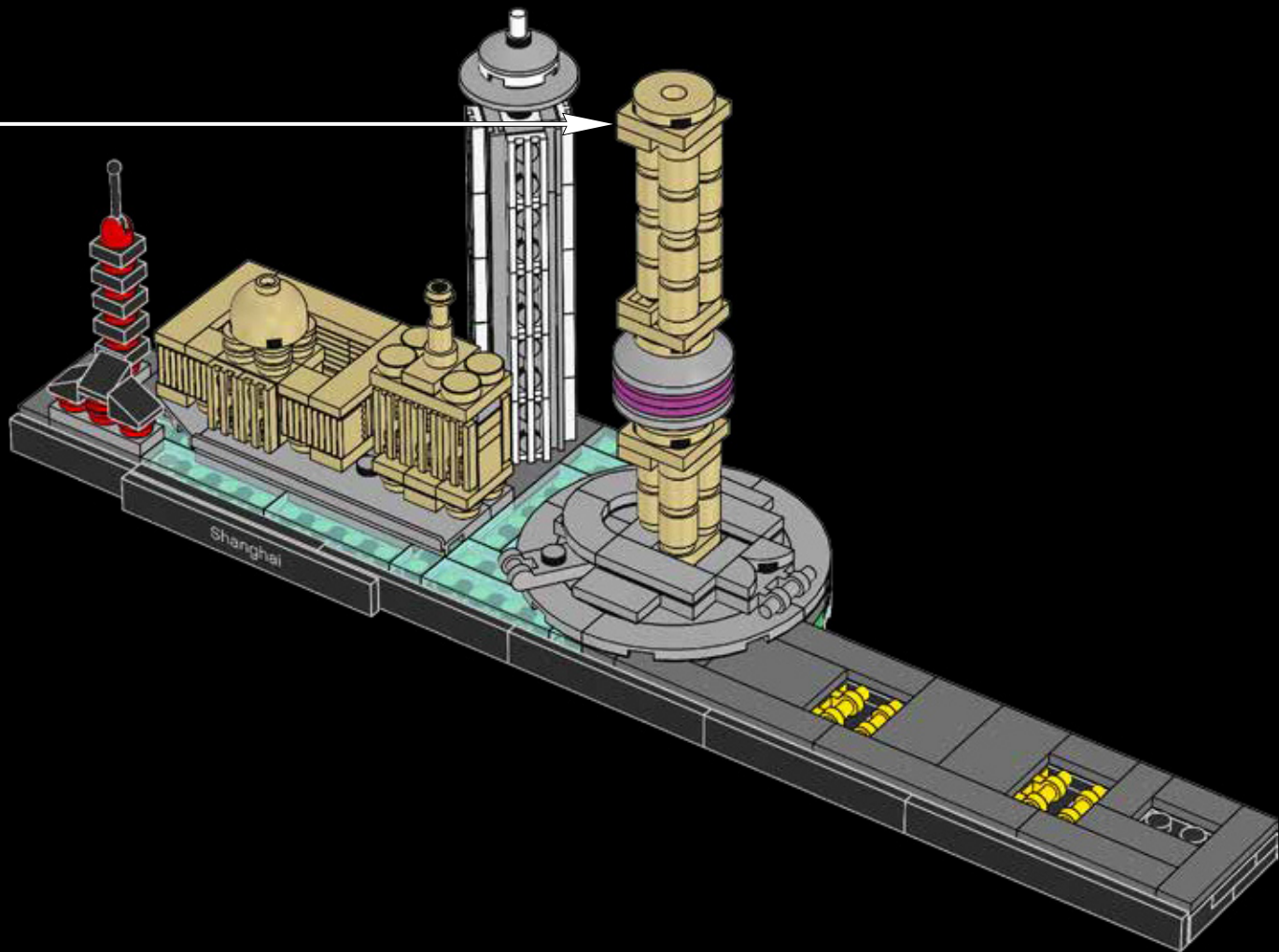

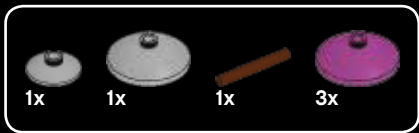

63

1

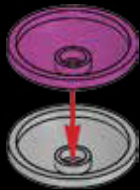

2



3



4



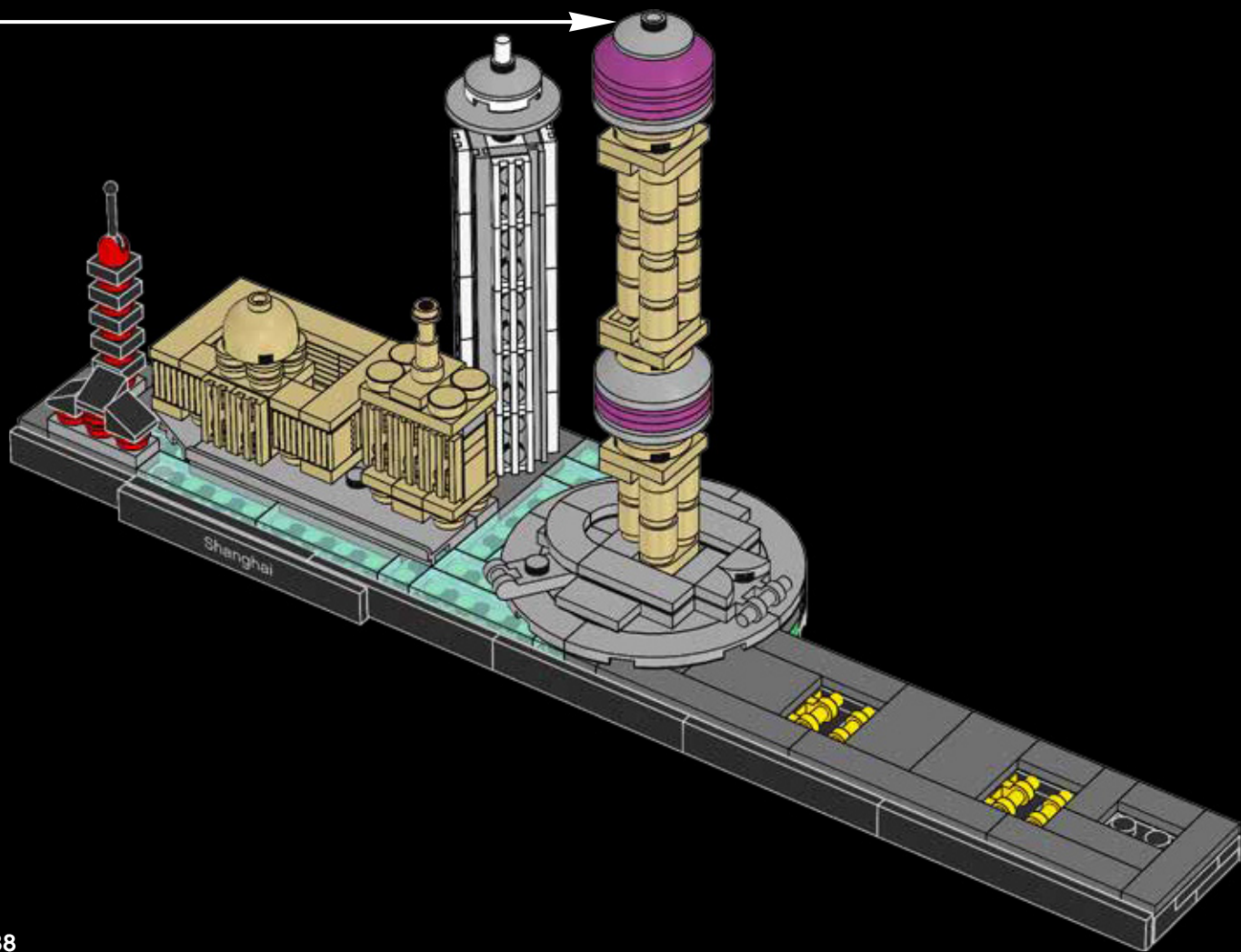



64

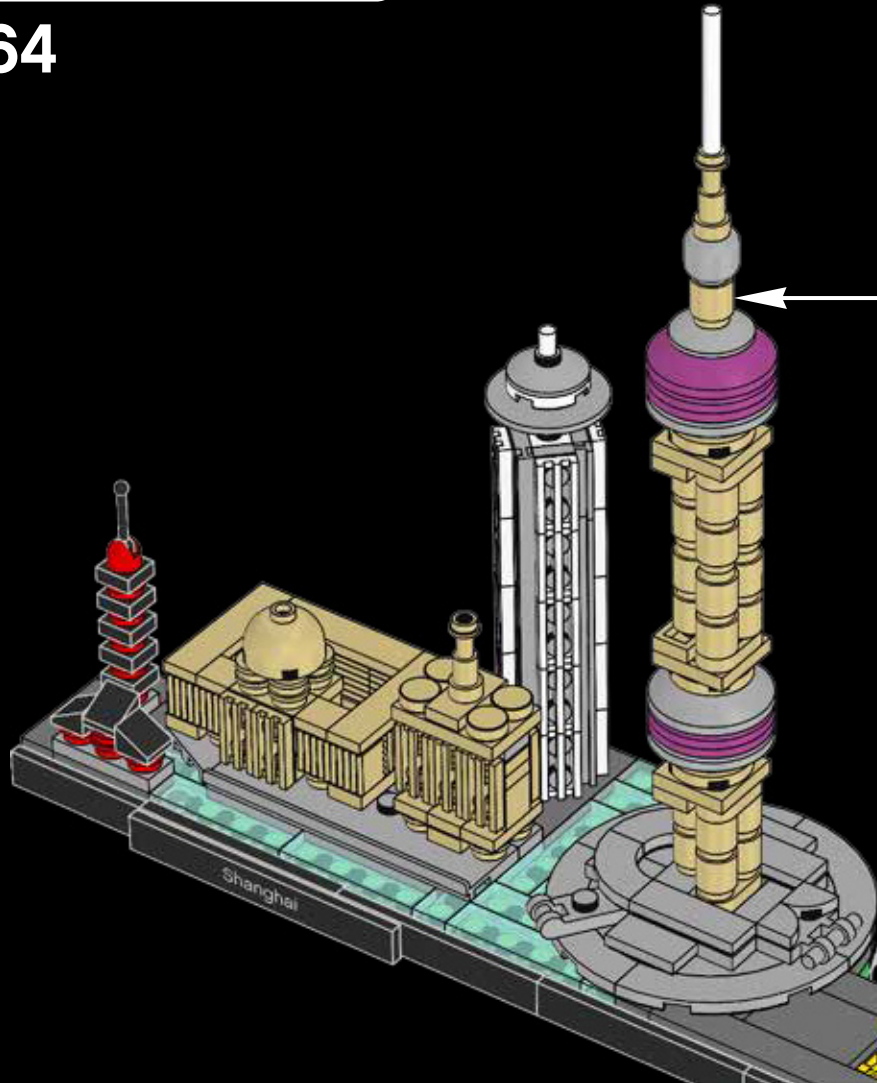
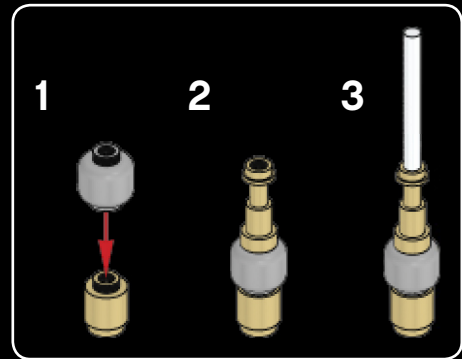



65

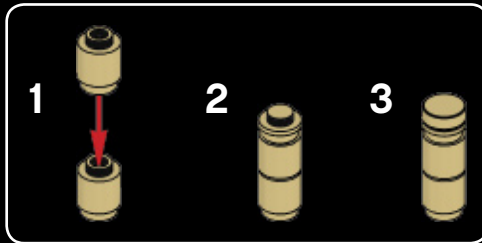

1



2

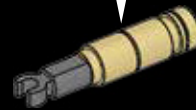

3x

The Oriental Pearl Tower was the tallest structure in China until 2007.

东方明珠塔
2007年之前，东方明珠塔是中国最高的建筑。



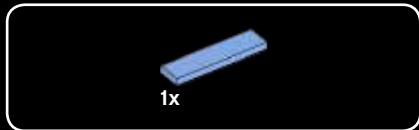
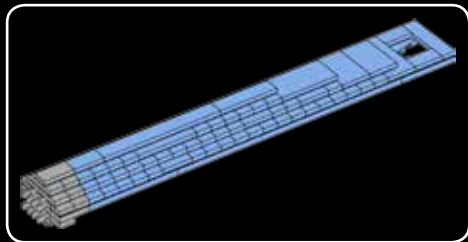

1x

66

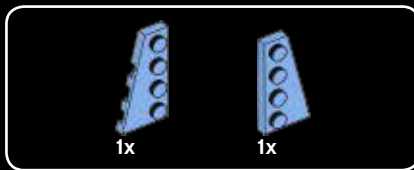
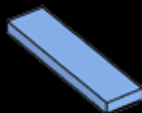

1x

1x

67

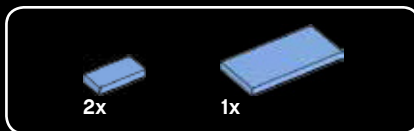

2x

1x

68

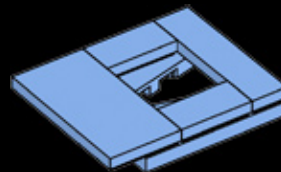

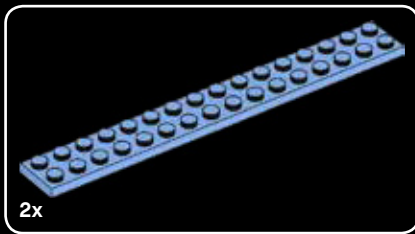

69

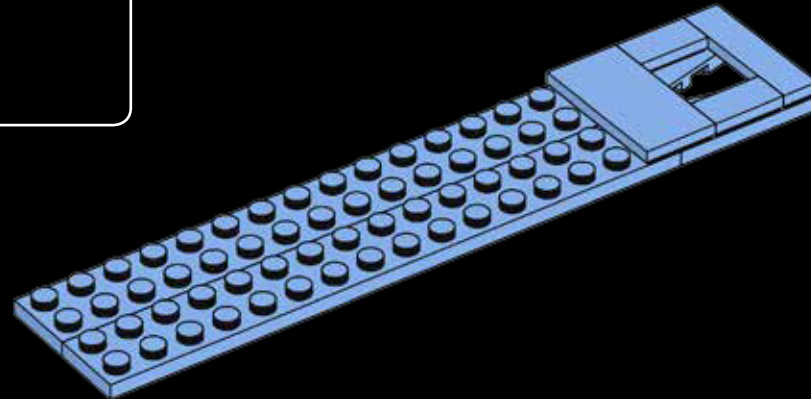

The square aperture at the top was originally designed to be circular

上海环球金融中心
在原设计中，建筑顶端为圆形开口，后改为方形。

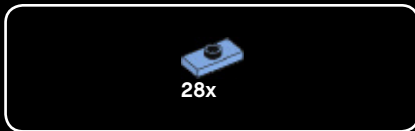

70

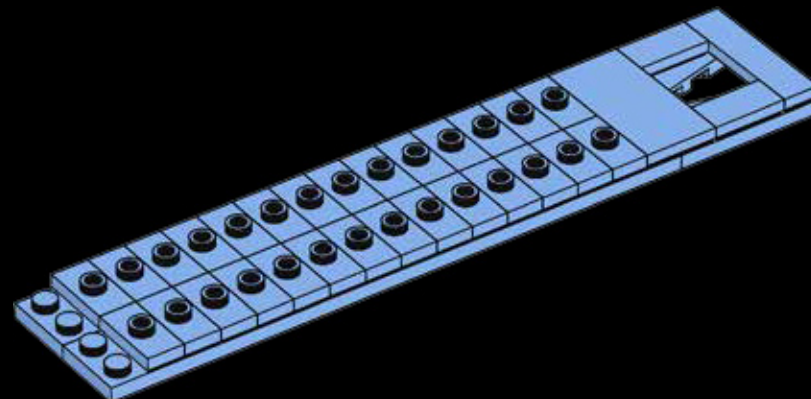



73

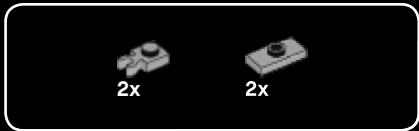
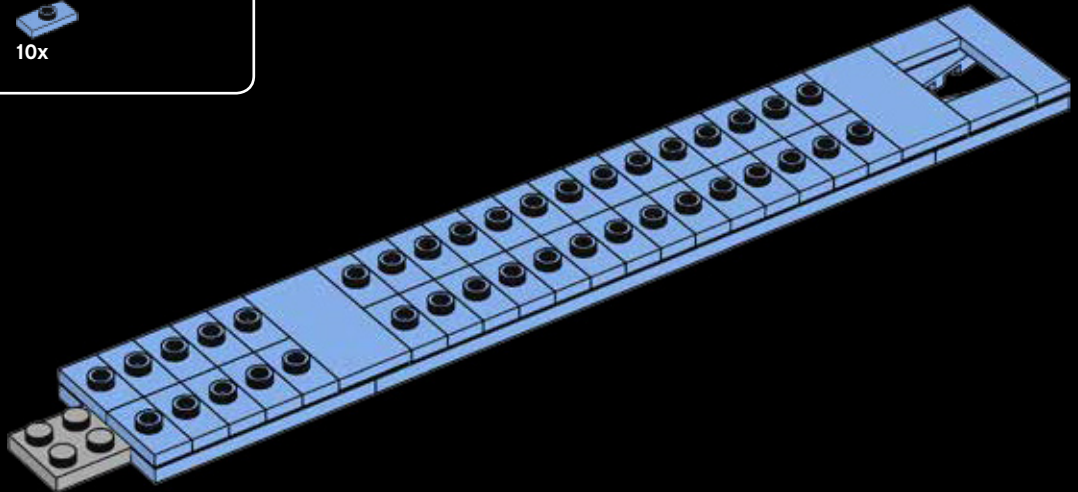

74

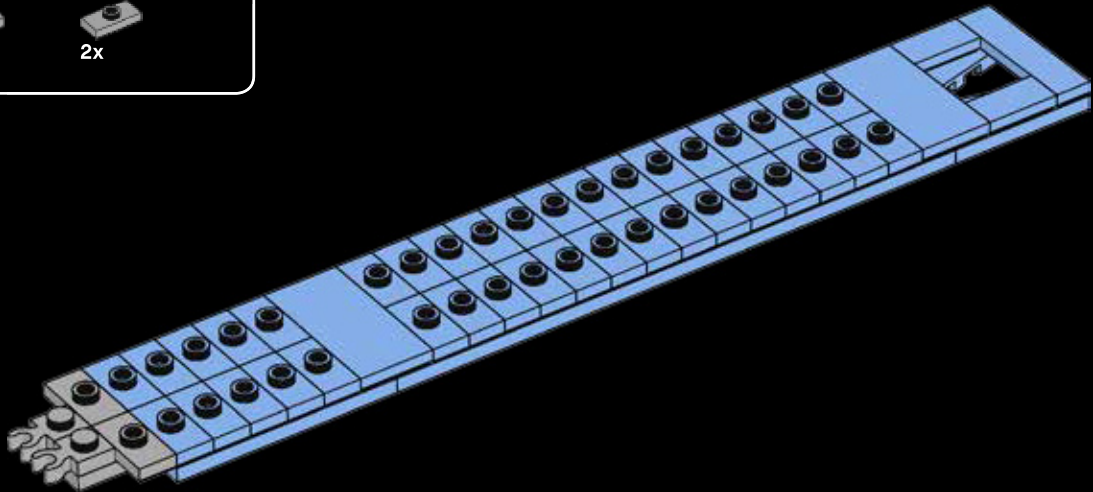



75

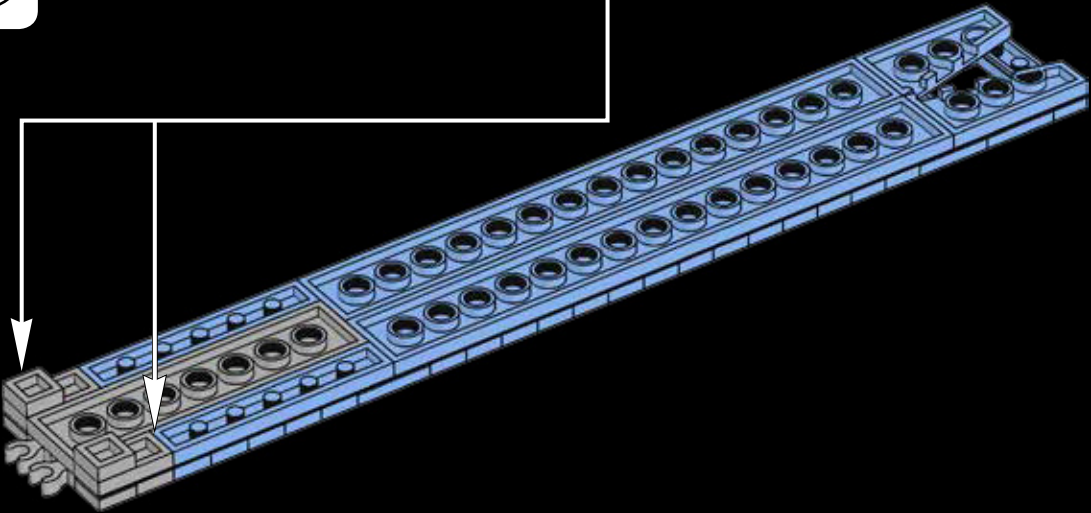
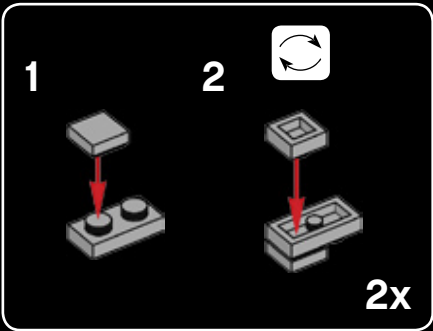



76

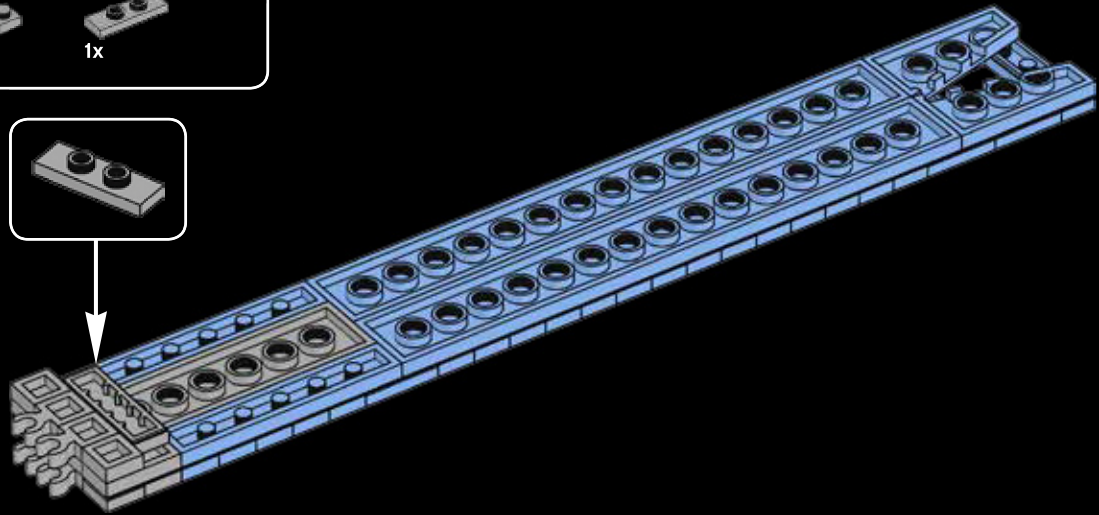
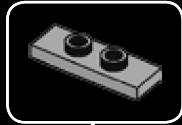

77

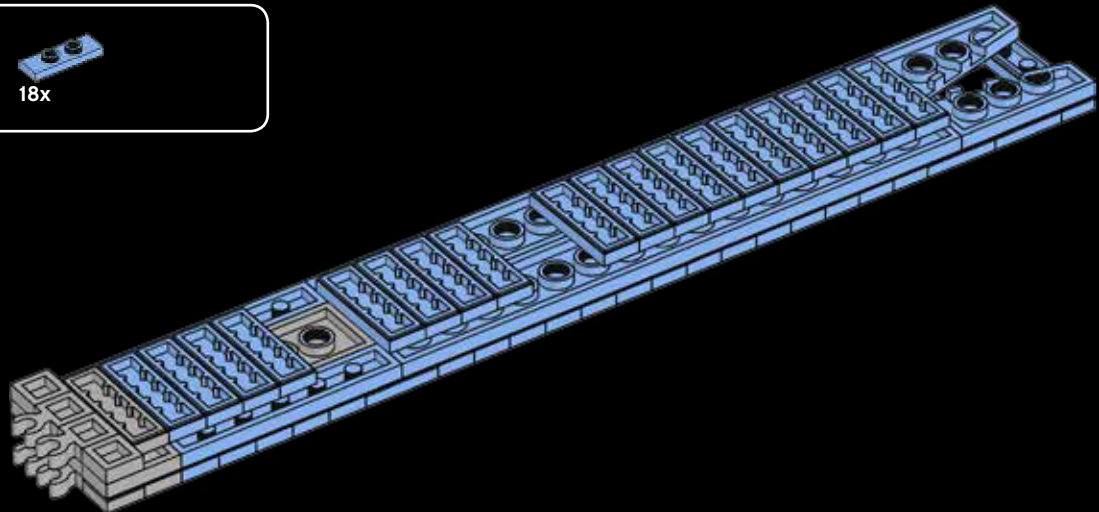



78

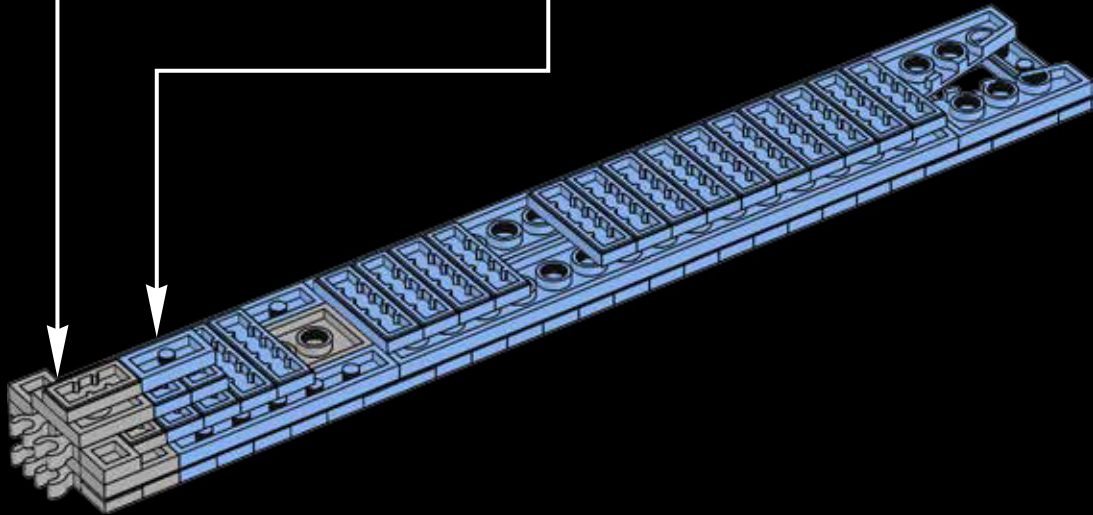
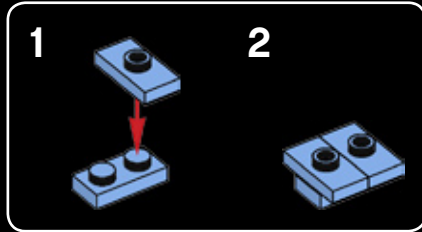
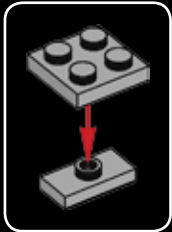



79

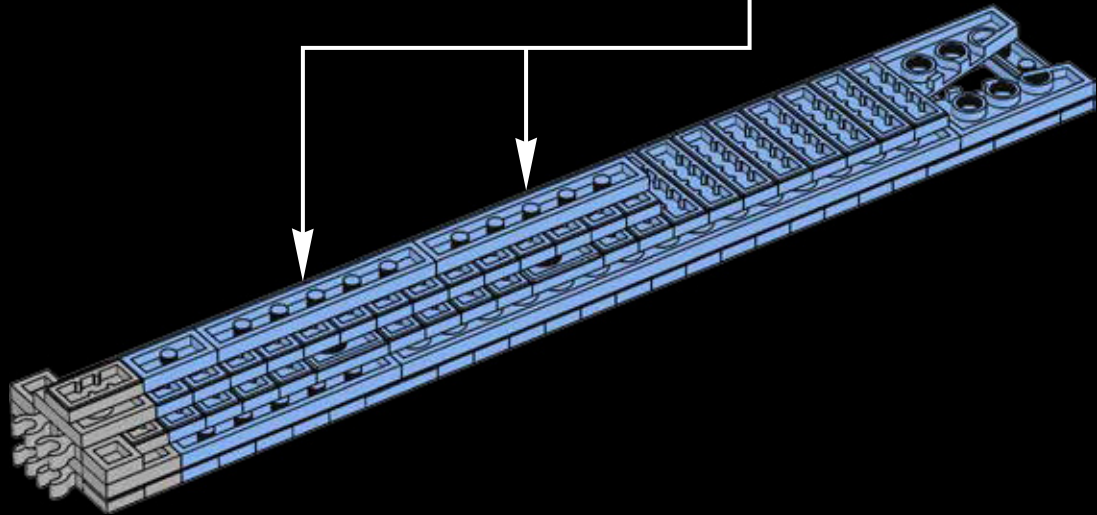
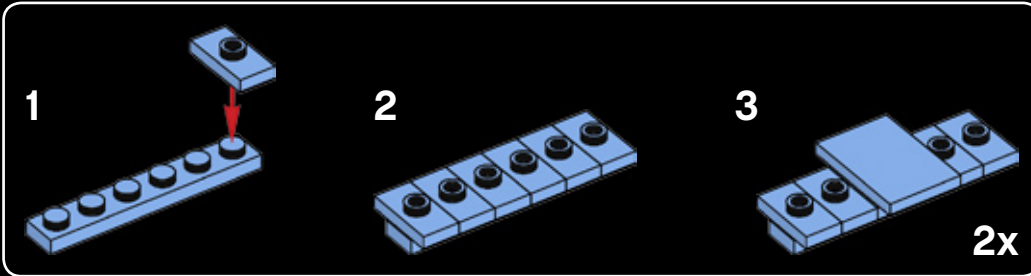



2x

80

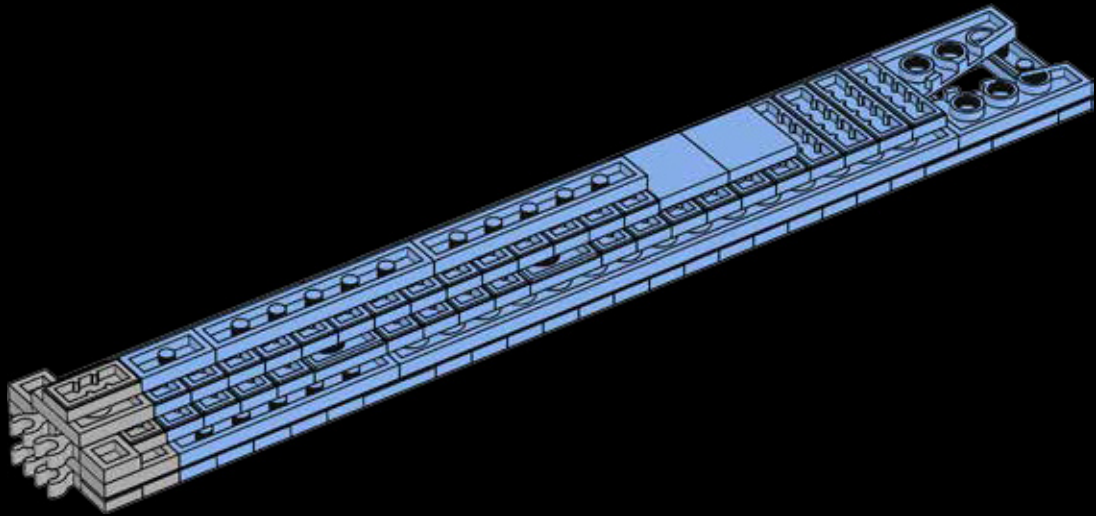



81

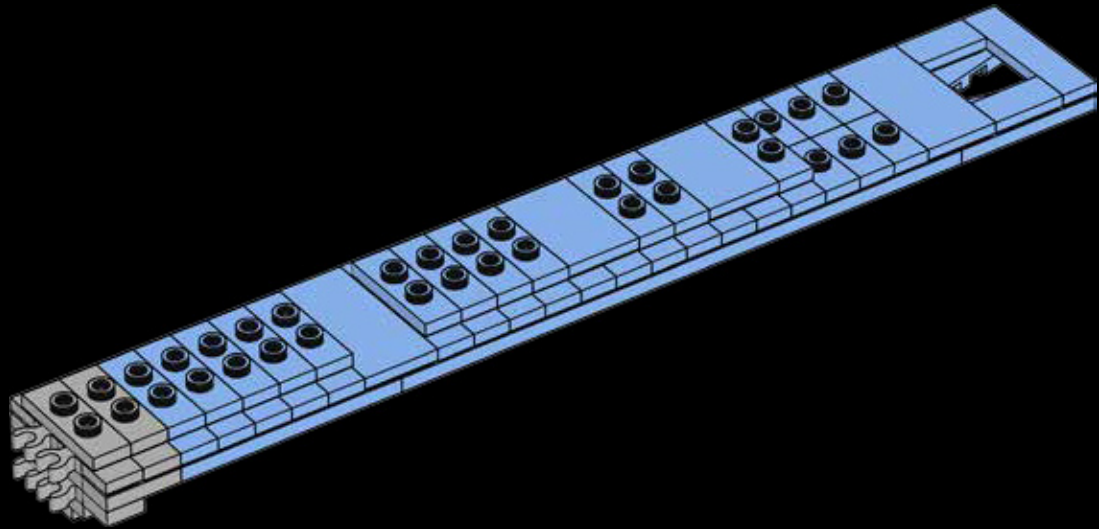

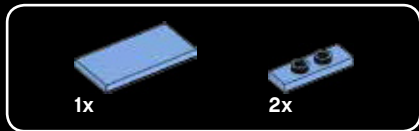

82

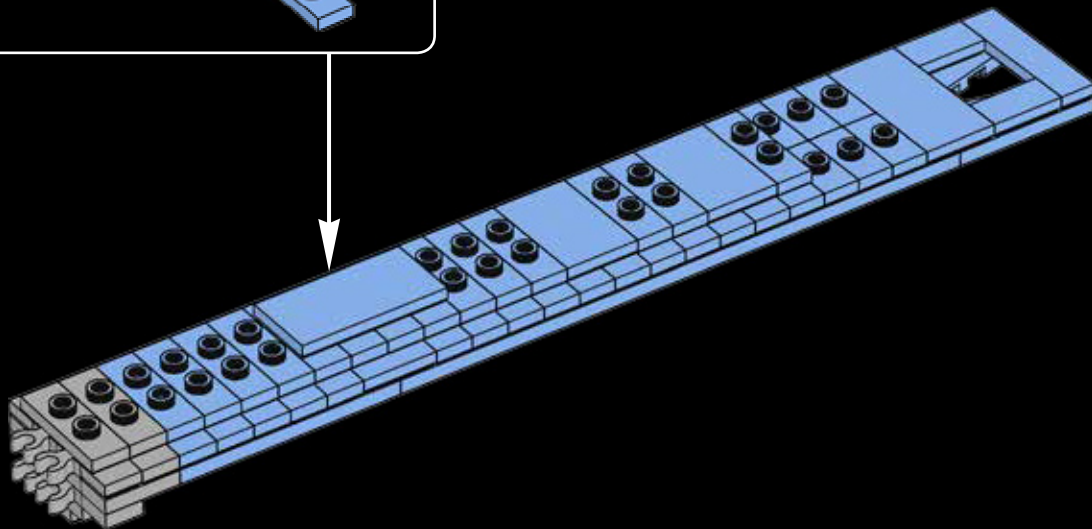
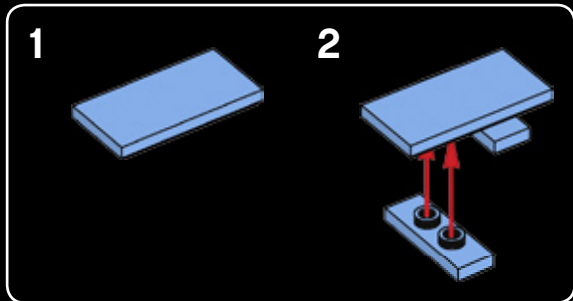

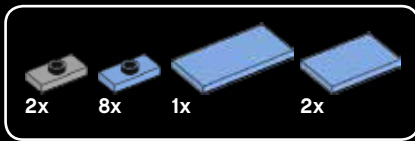

83

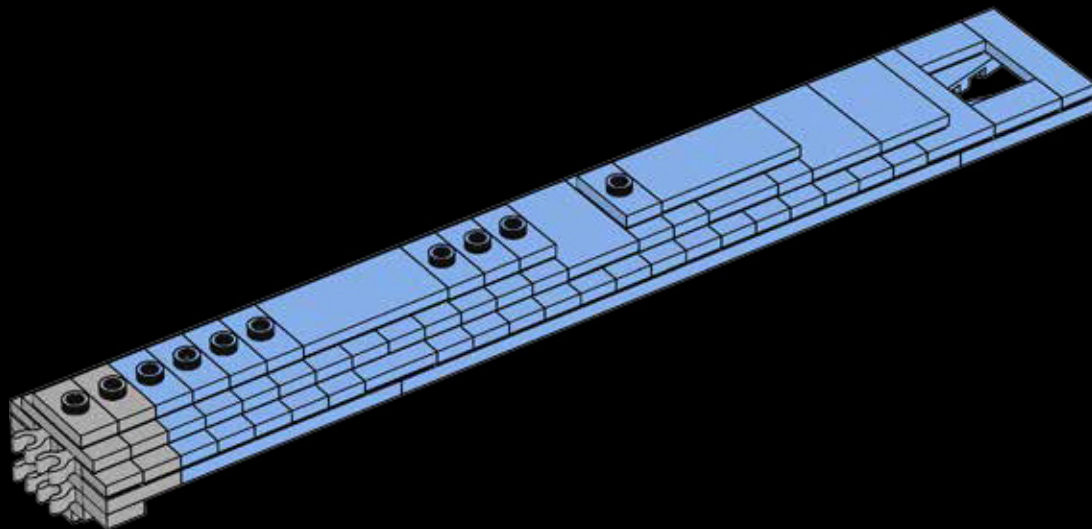

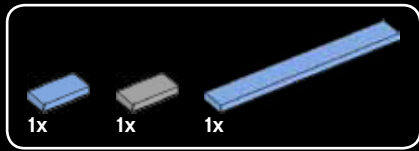

The building was designed in a modular system that repeats itself after every 13 floors.

该建筑为模块化设计, 结构每13层重复一次。



84

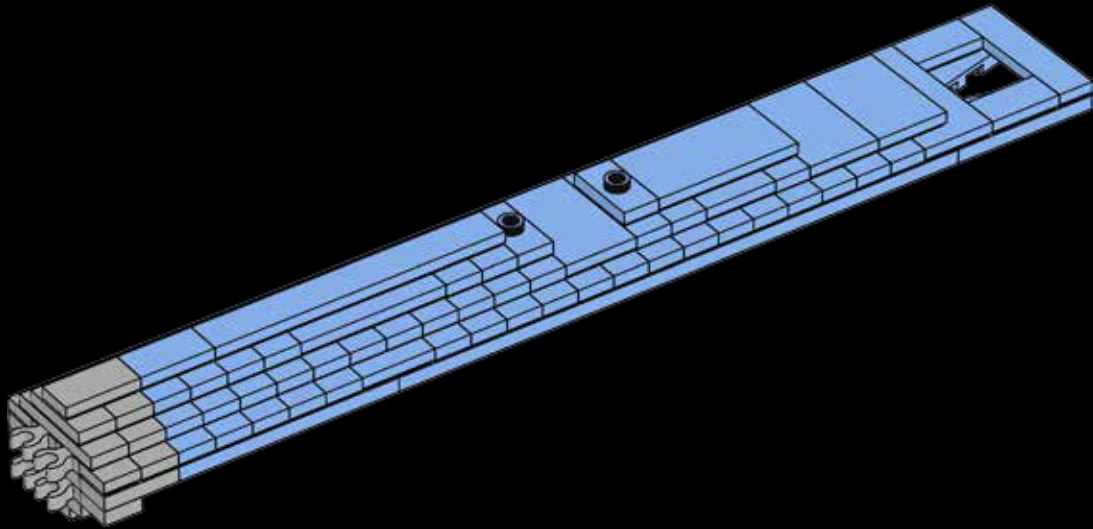

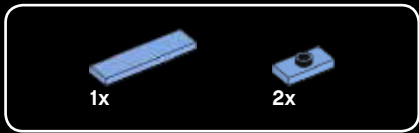

85

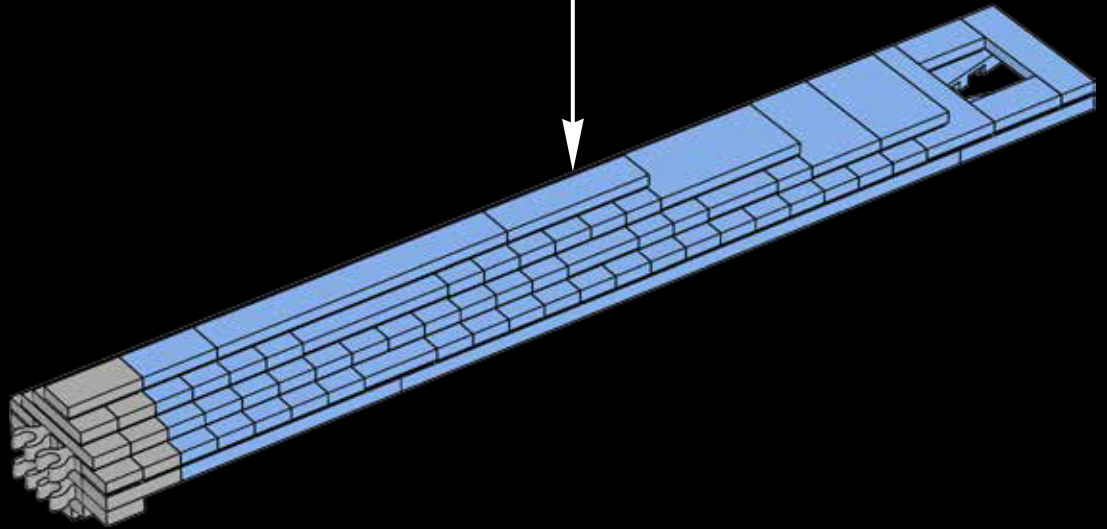
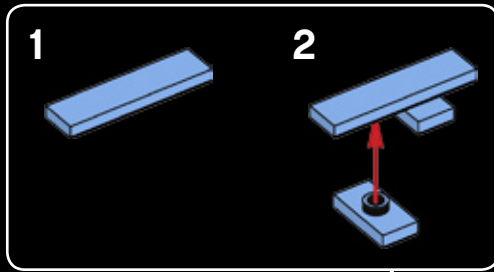

86

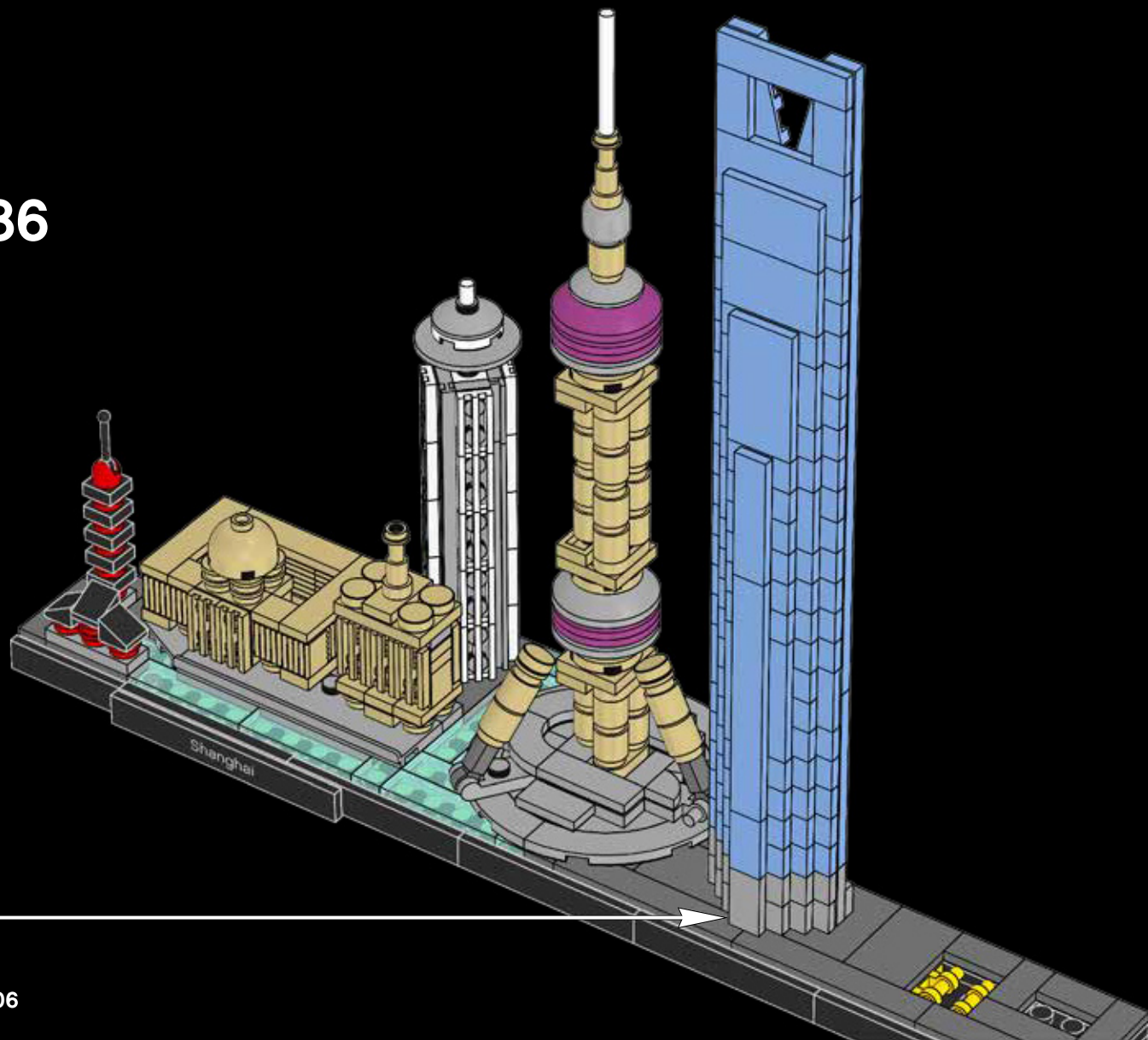

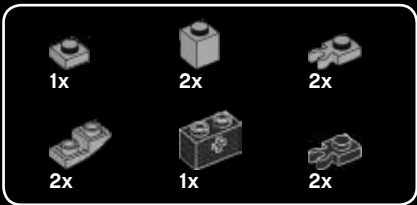

87

1



2



3

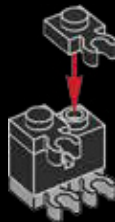

4

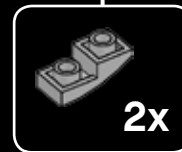
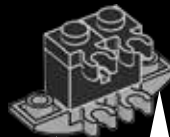

5

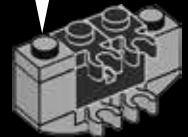
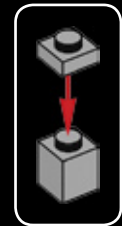

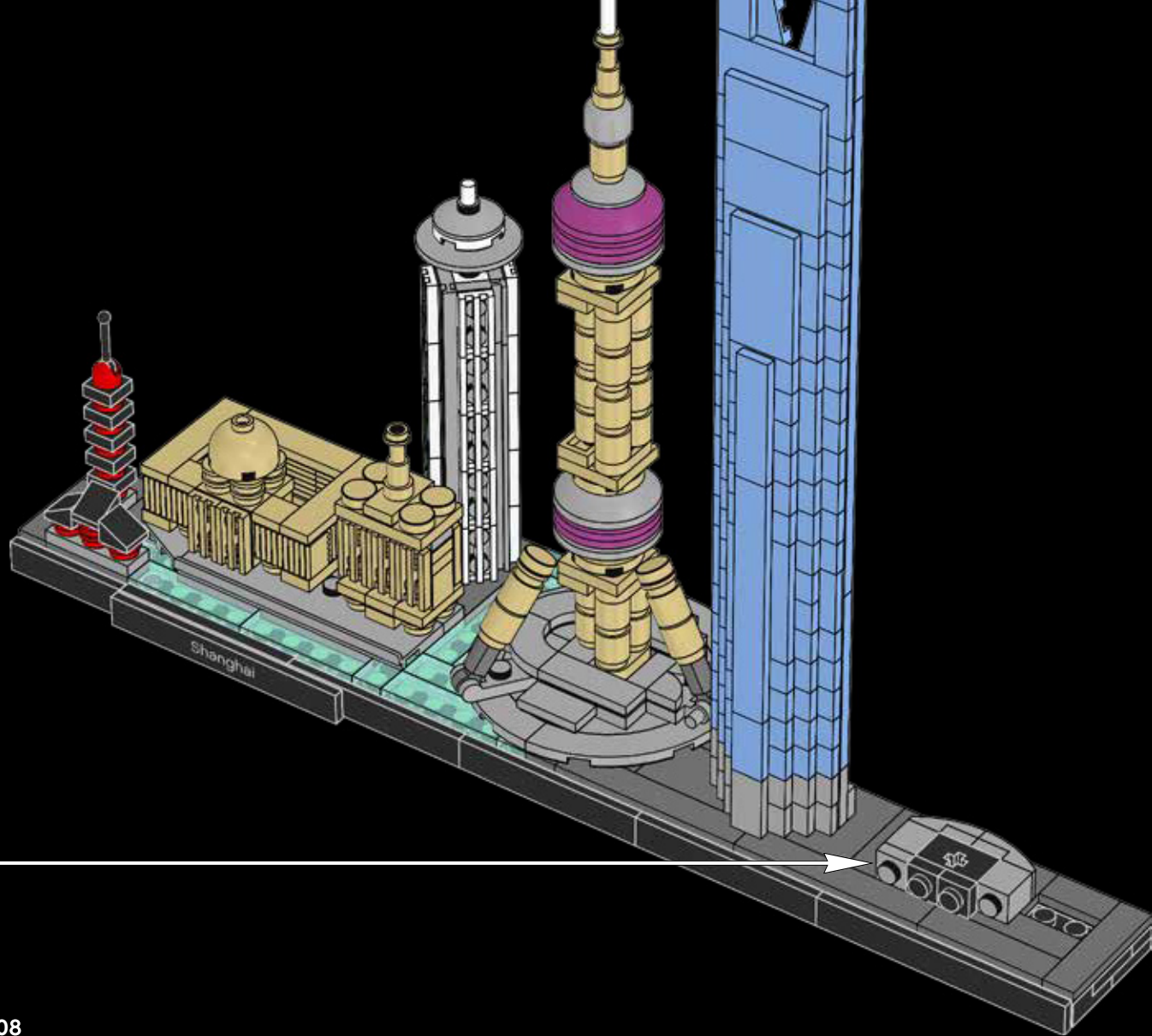

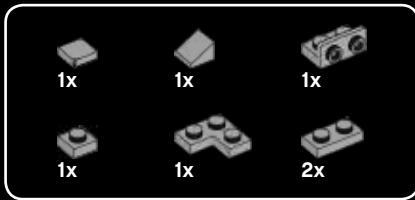

88

1

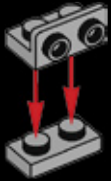

2

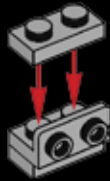

3



4



5



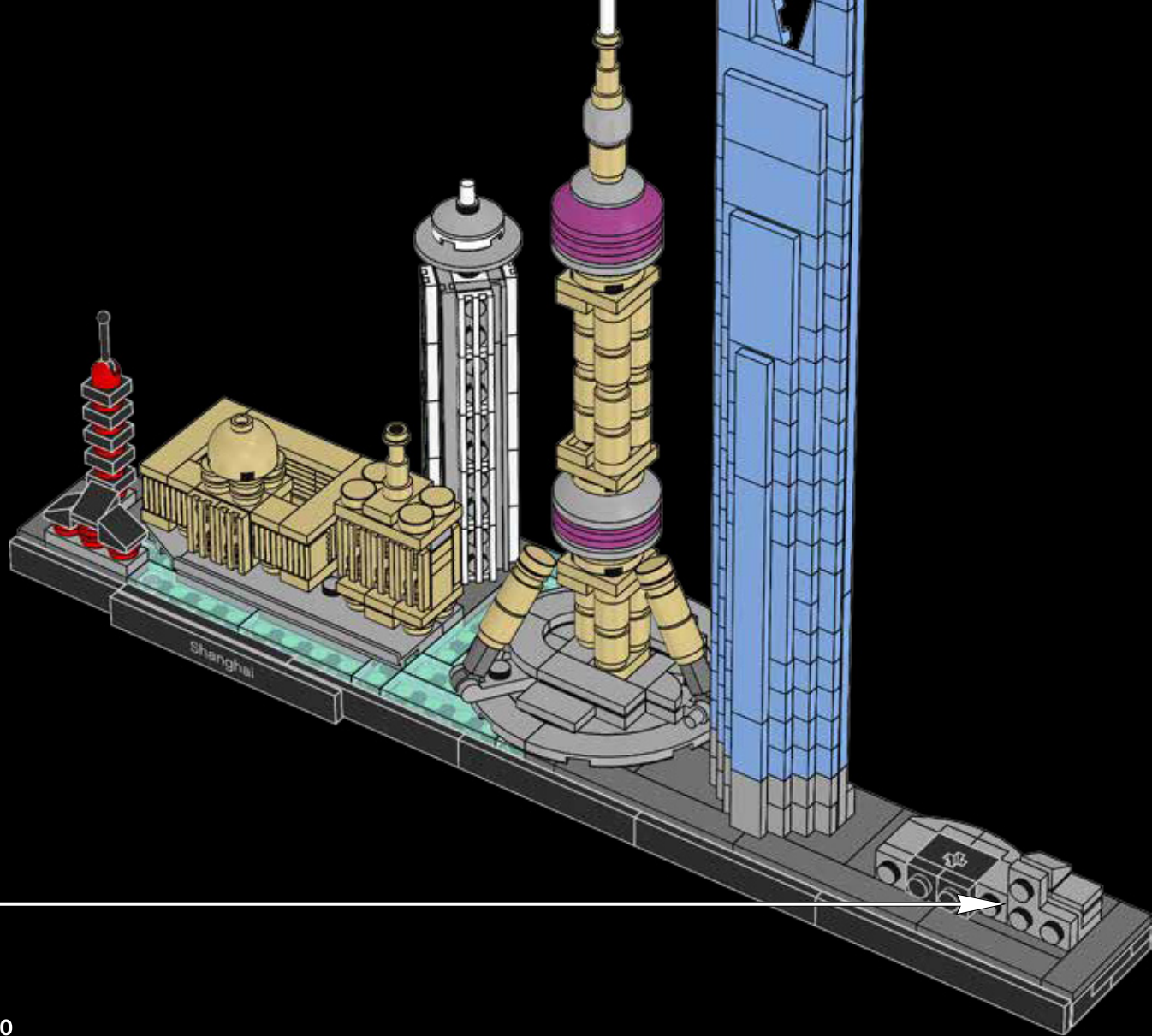

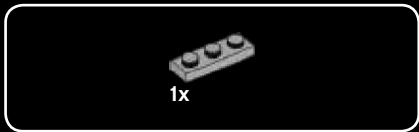

89

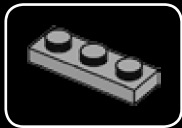
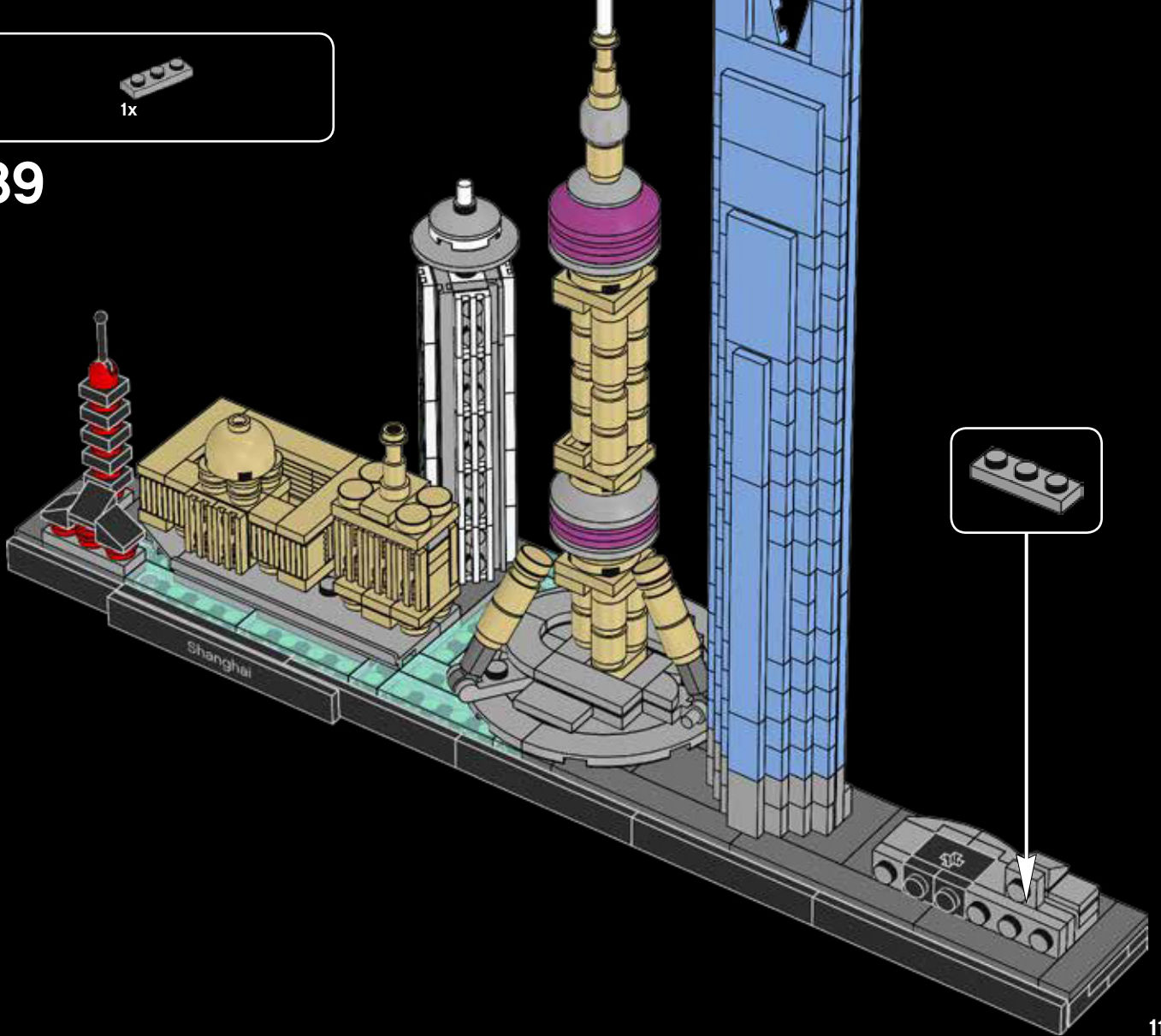

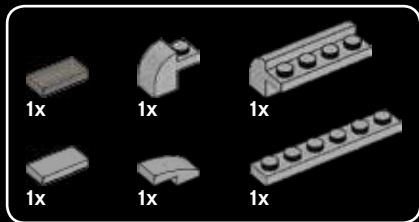

90

1



2

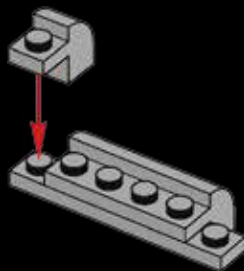

3

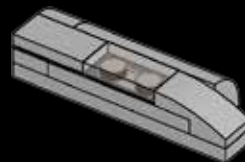

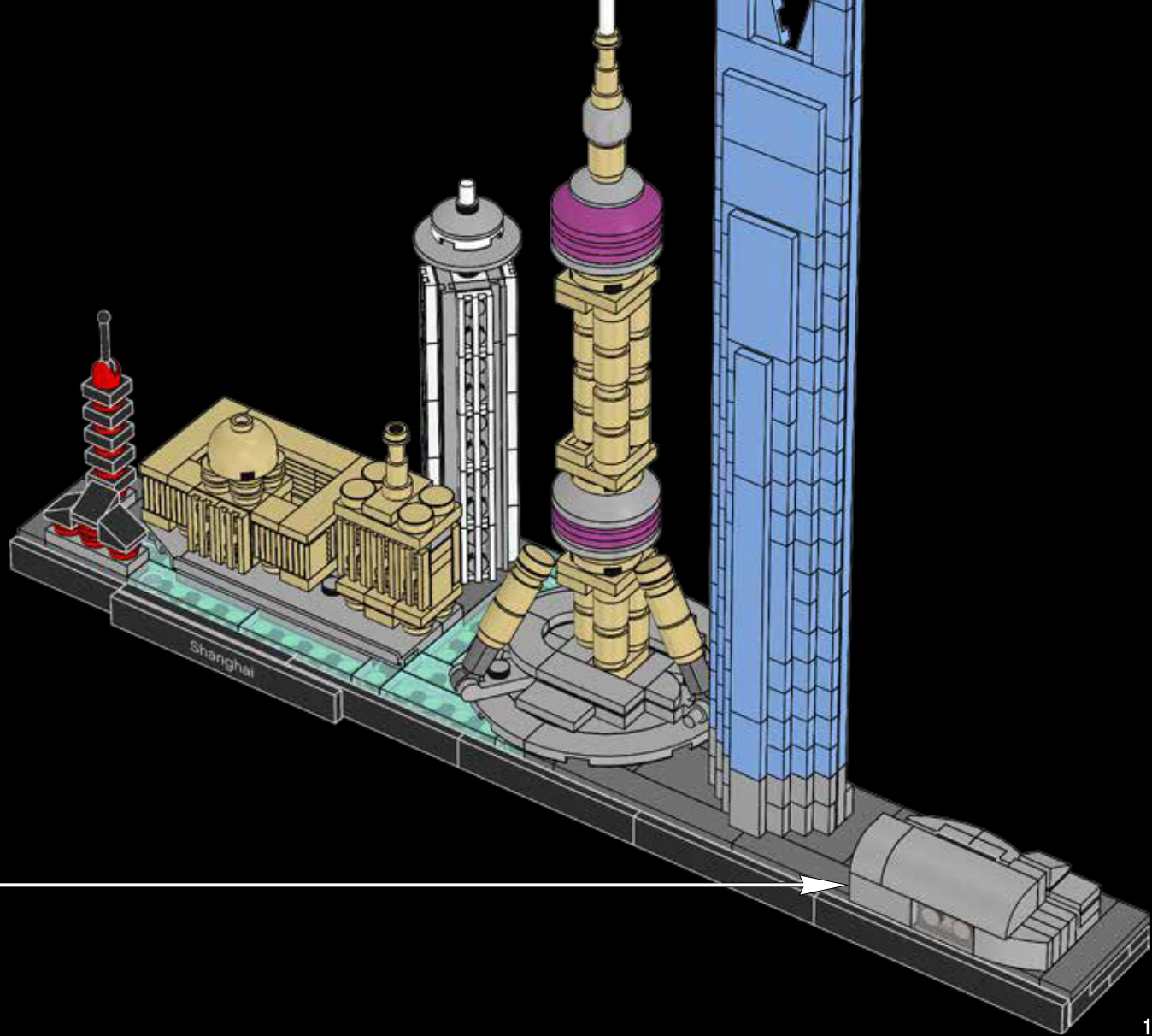

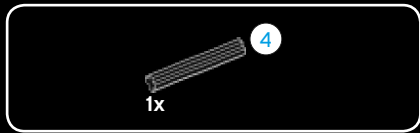

91

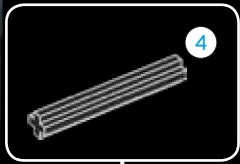
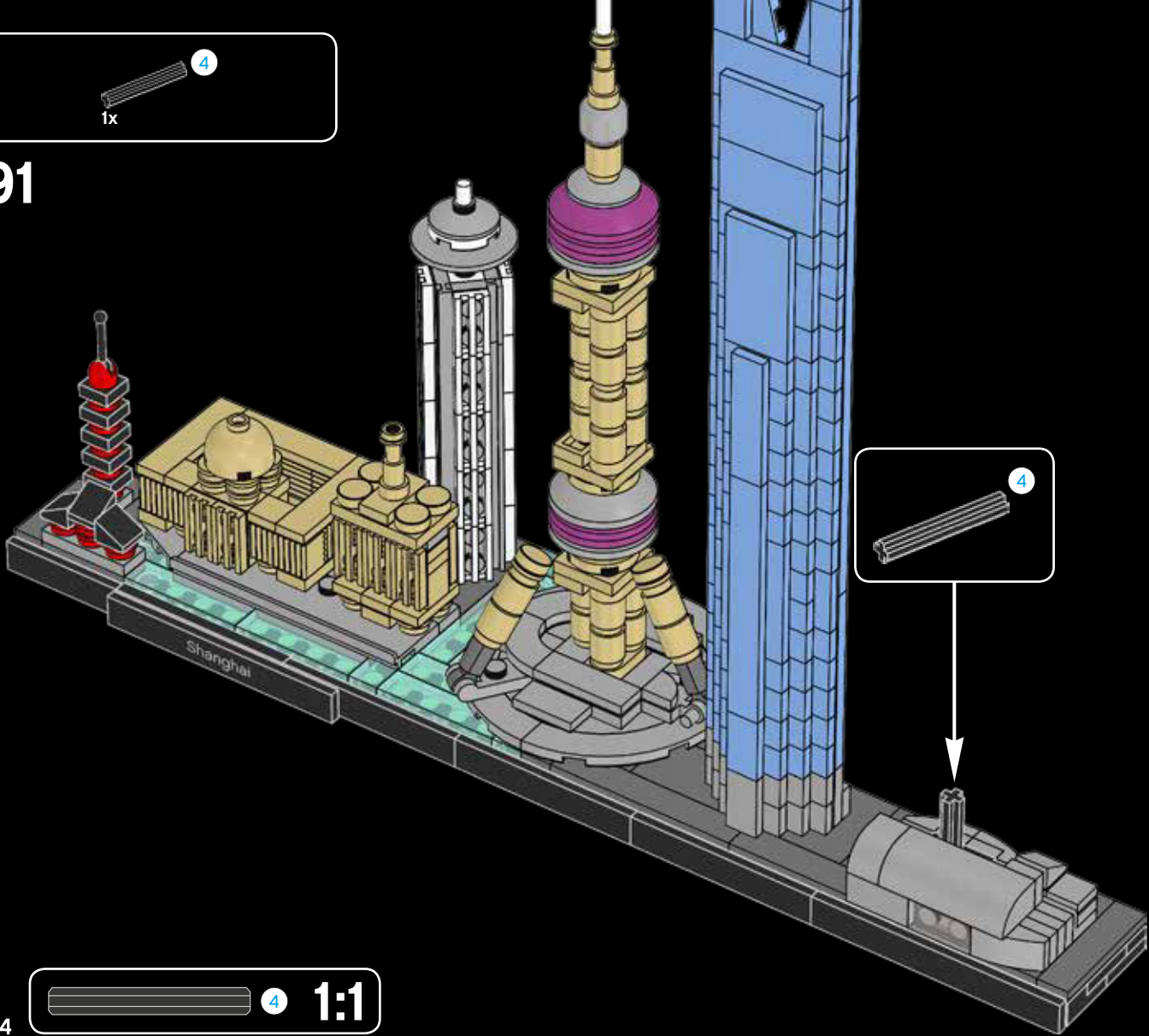



92

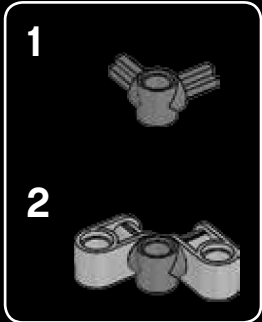
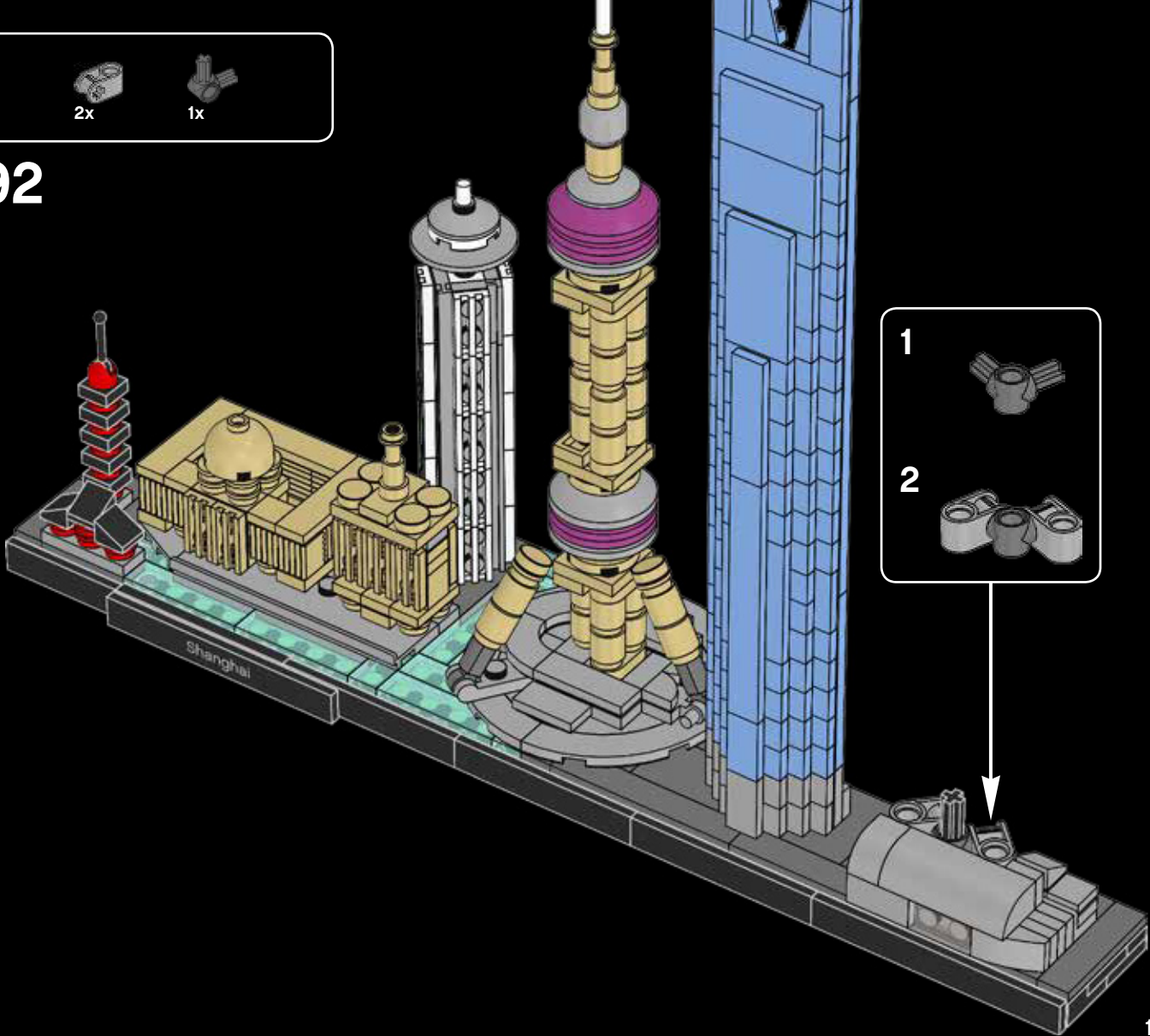



93

1

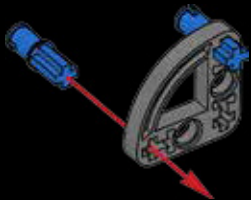

2

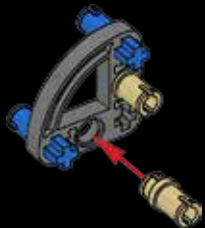

3



4



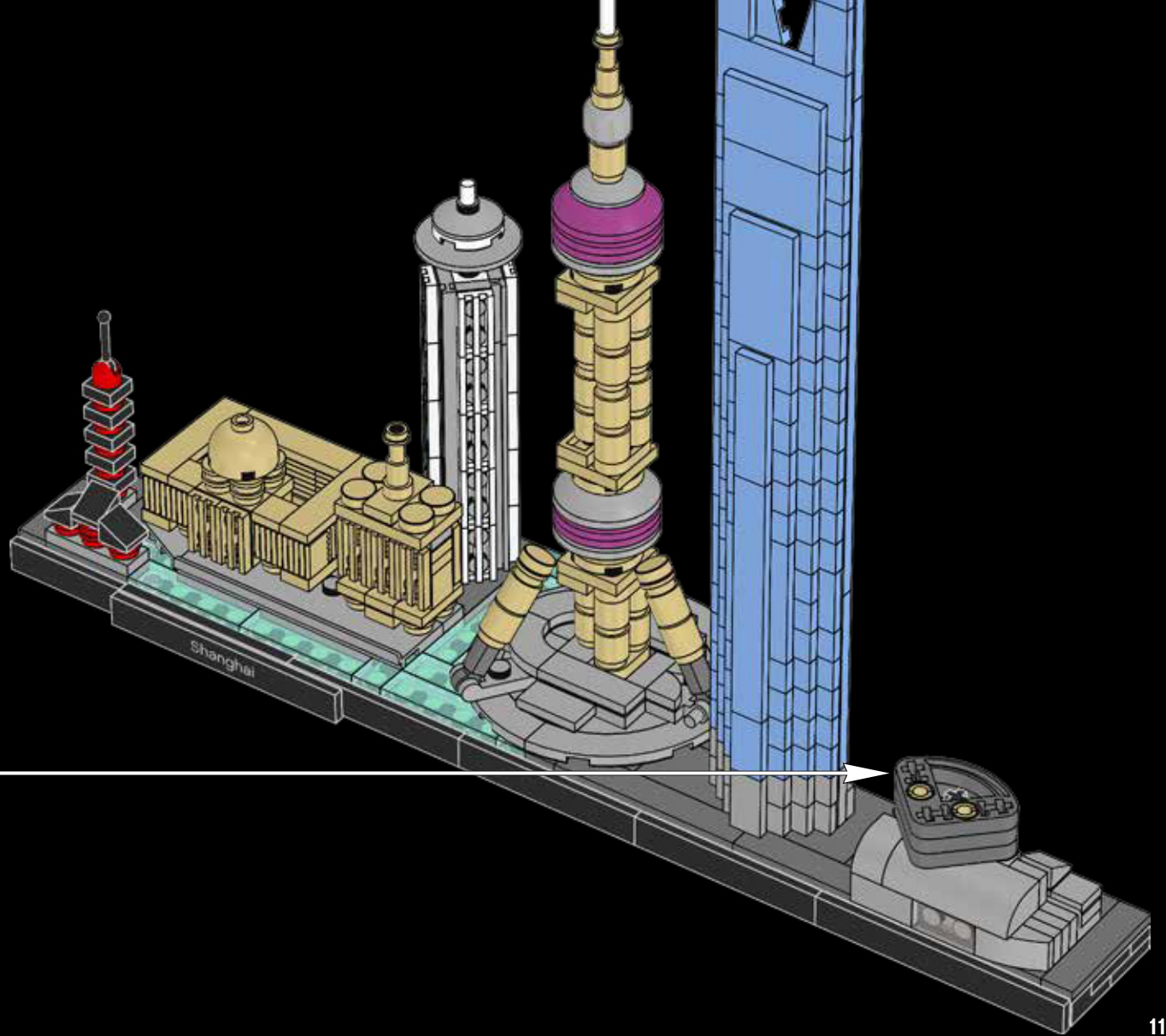

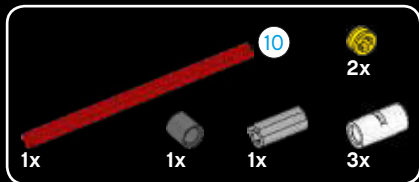

94

1



2



3

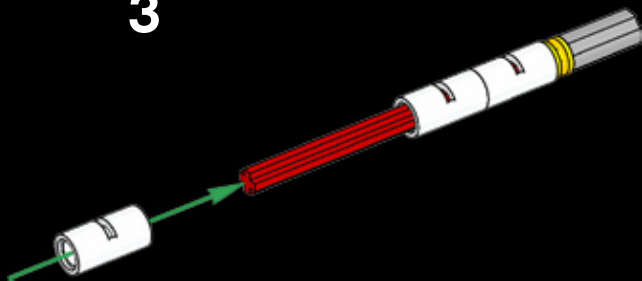

4

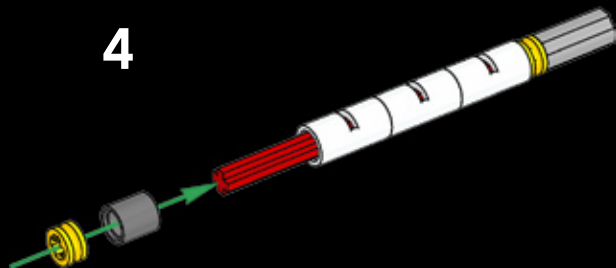

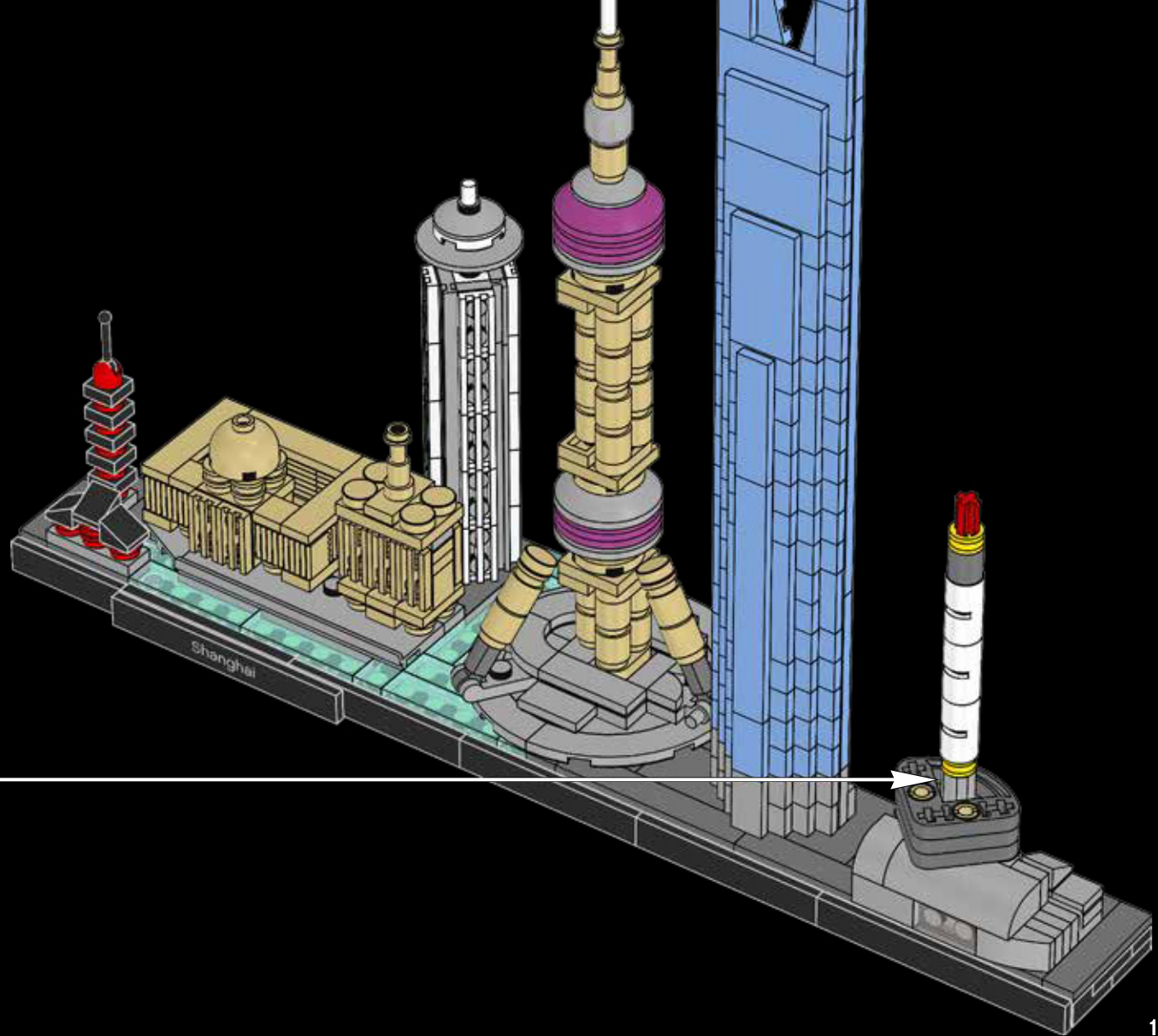

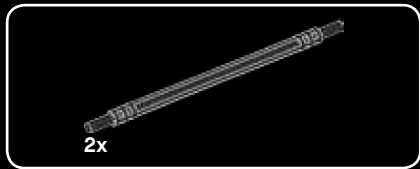

95

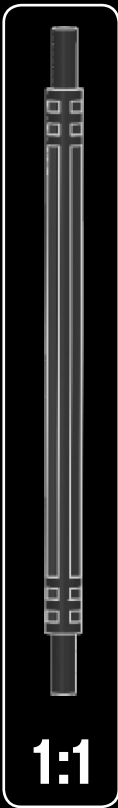
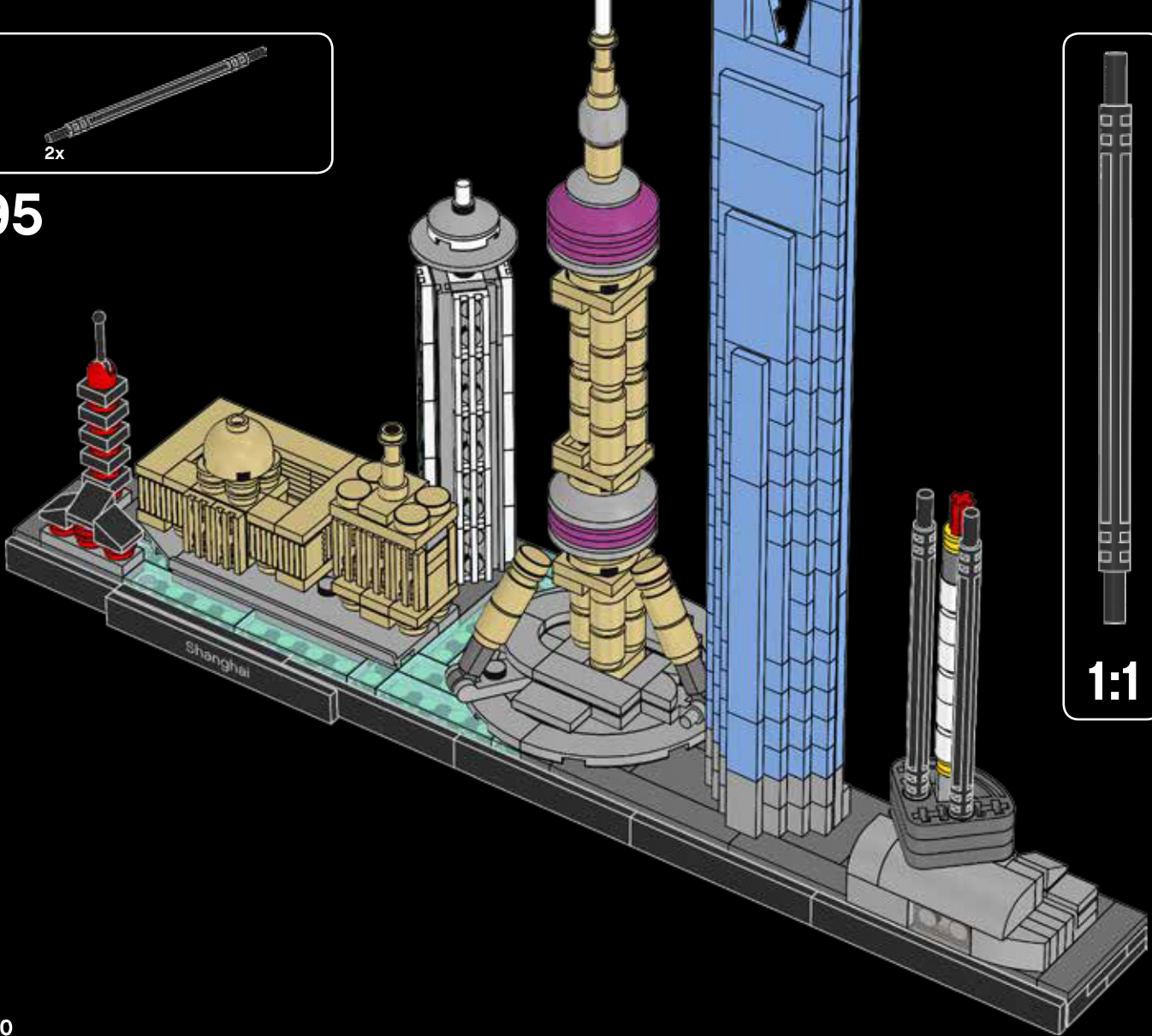

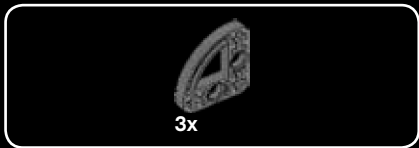

96

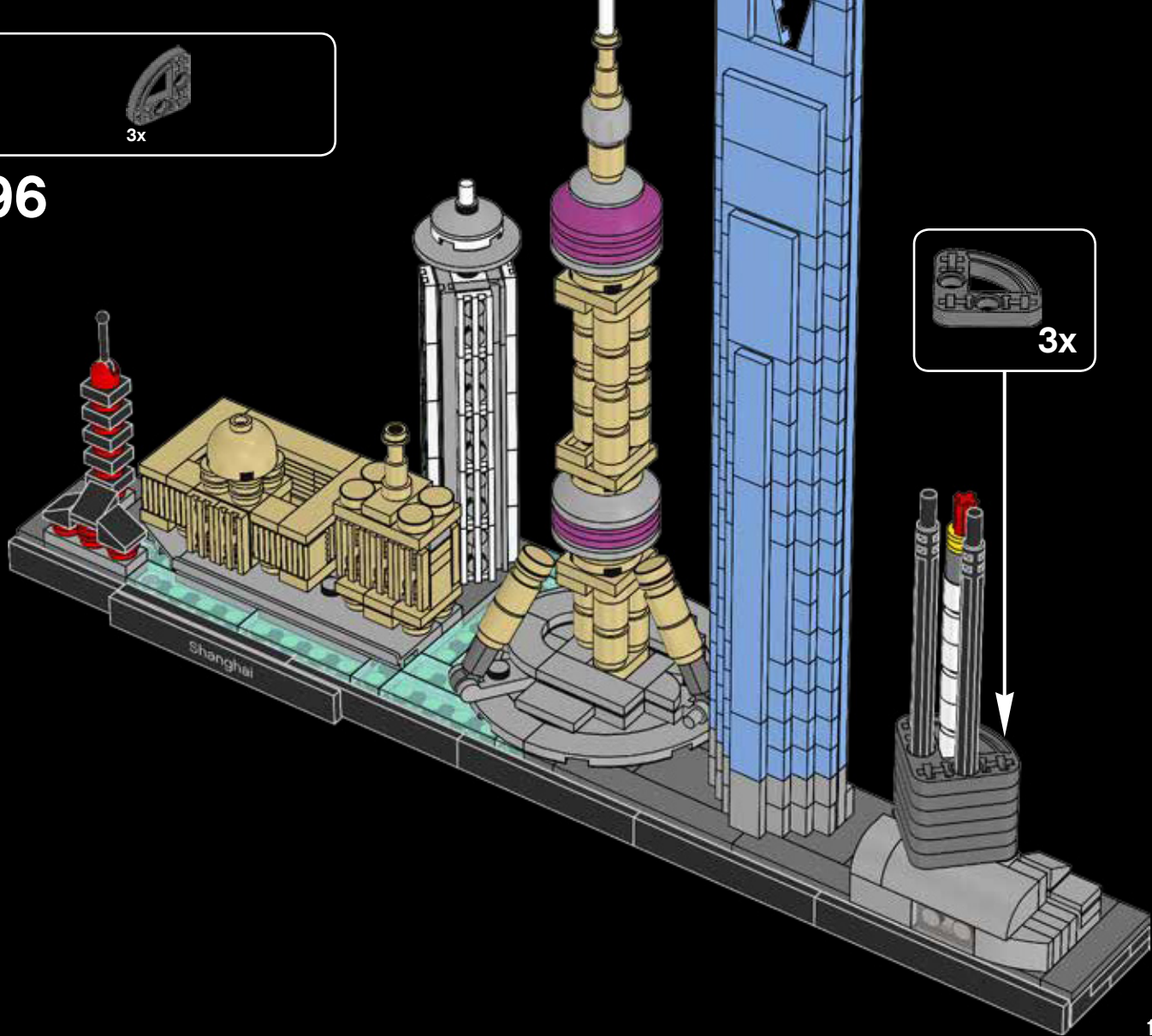

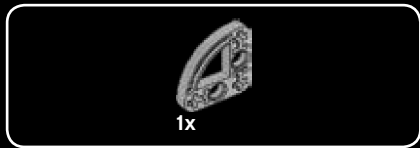

97

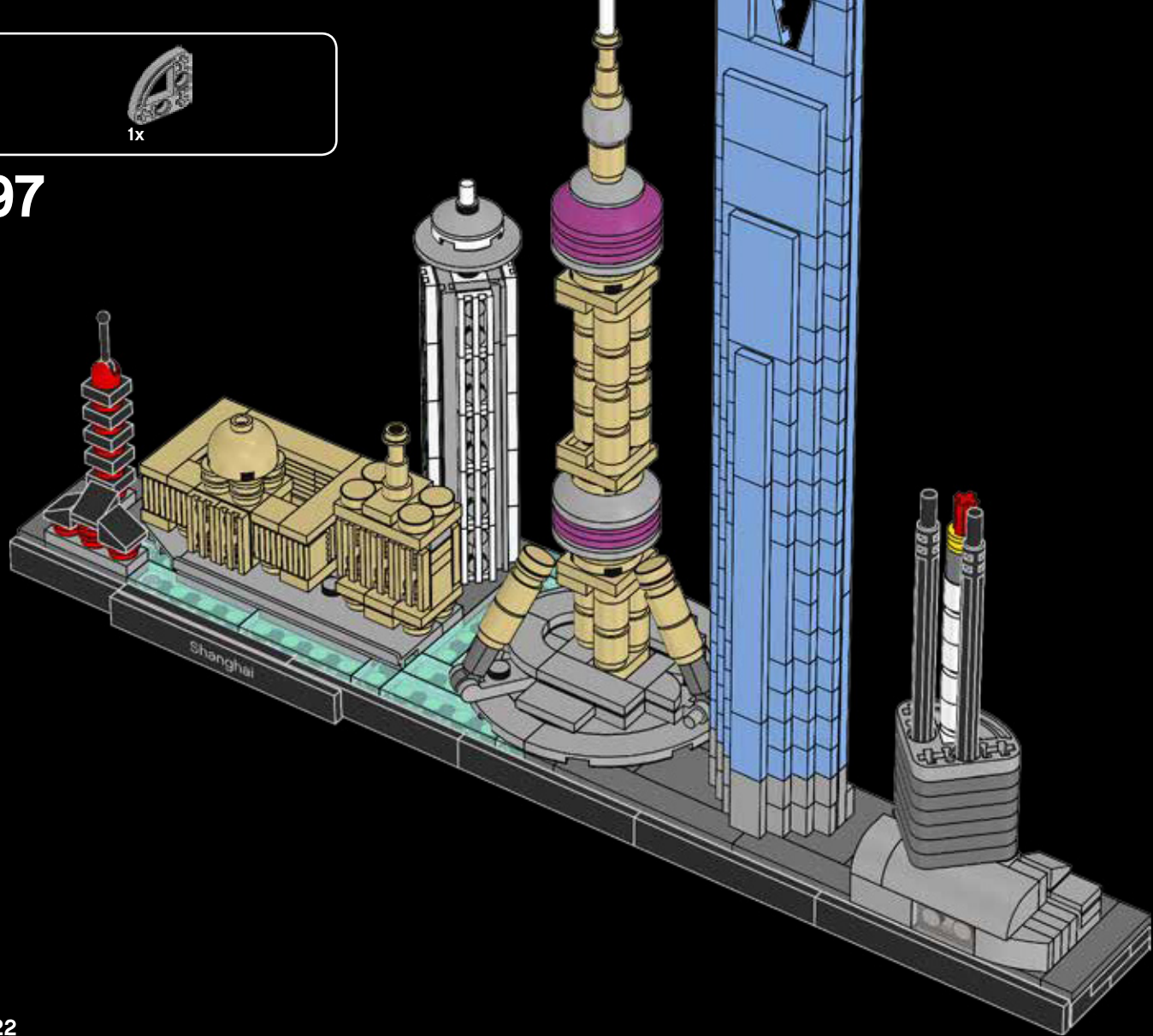

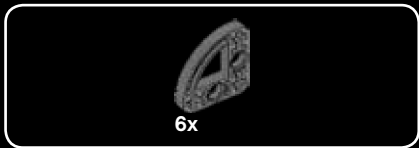

98

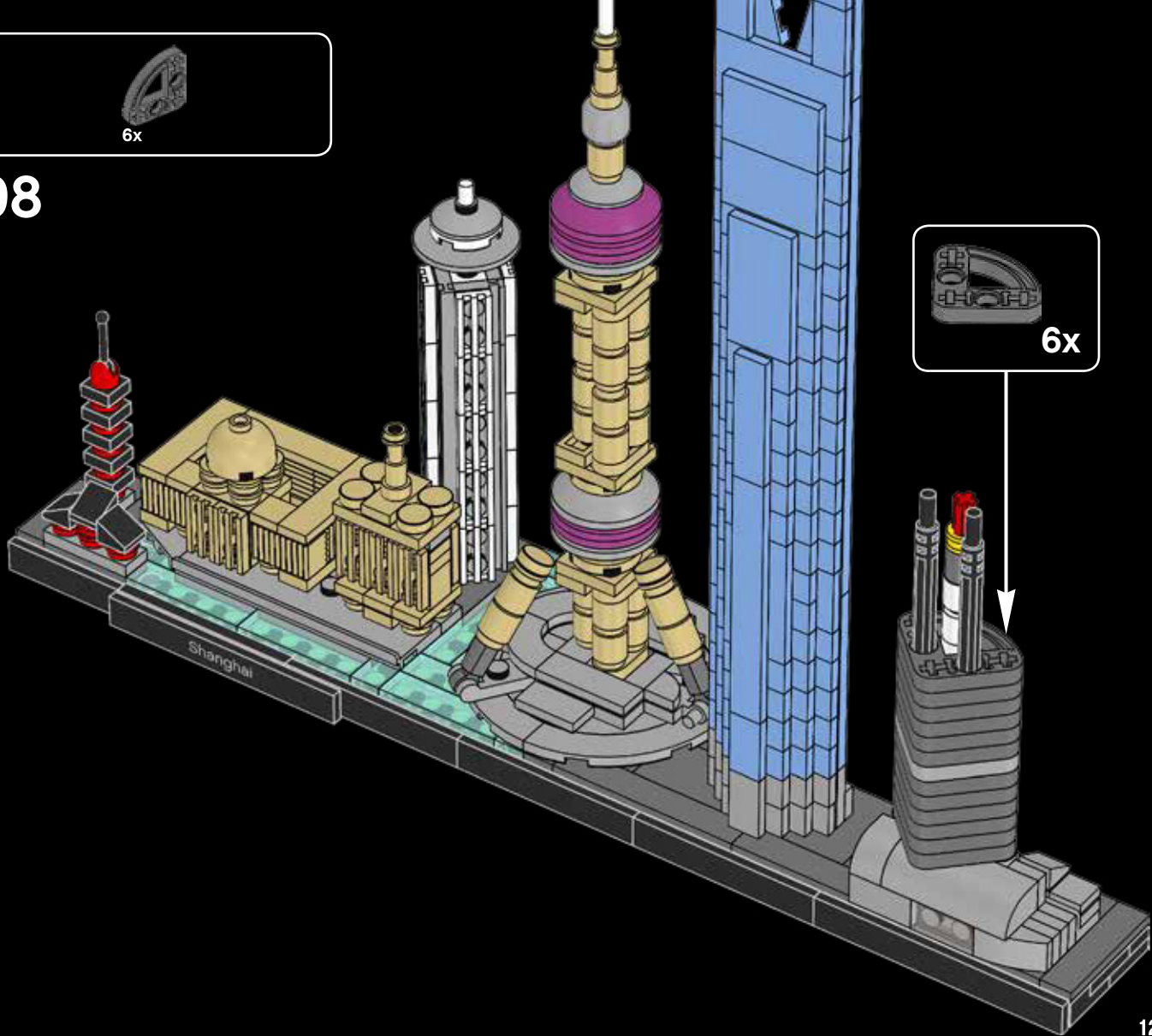

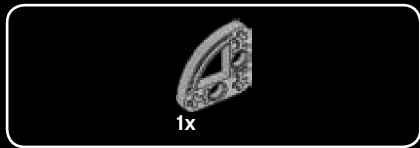

99

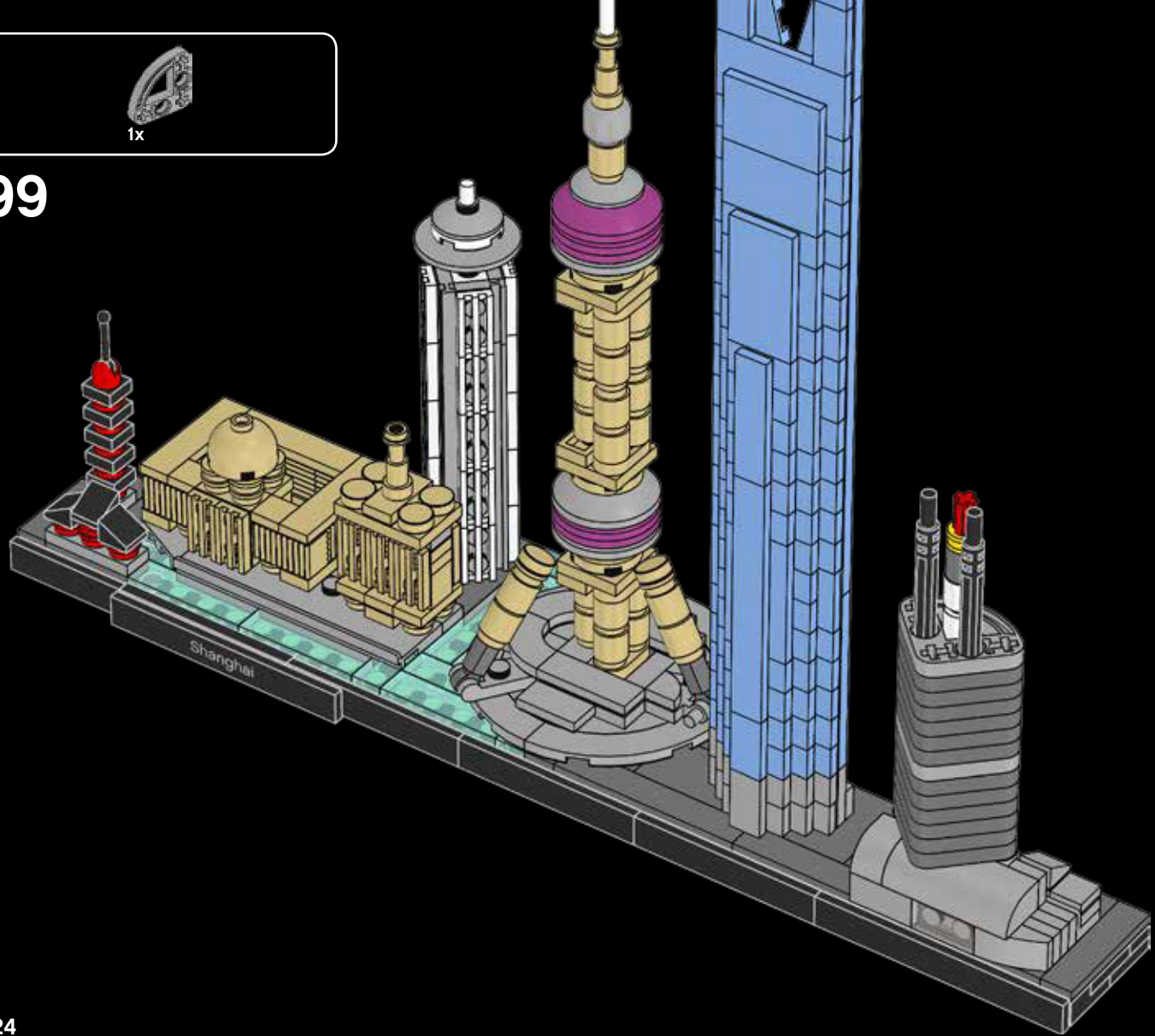

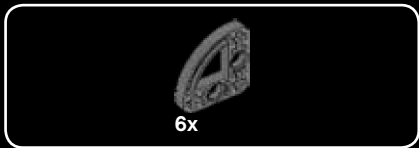

100

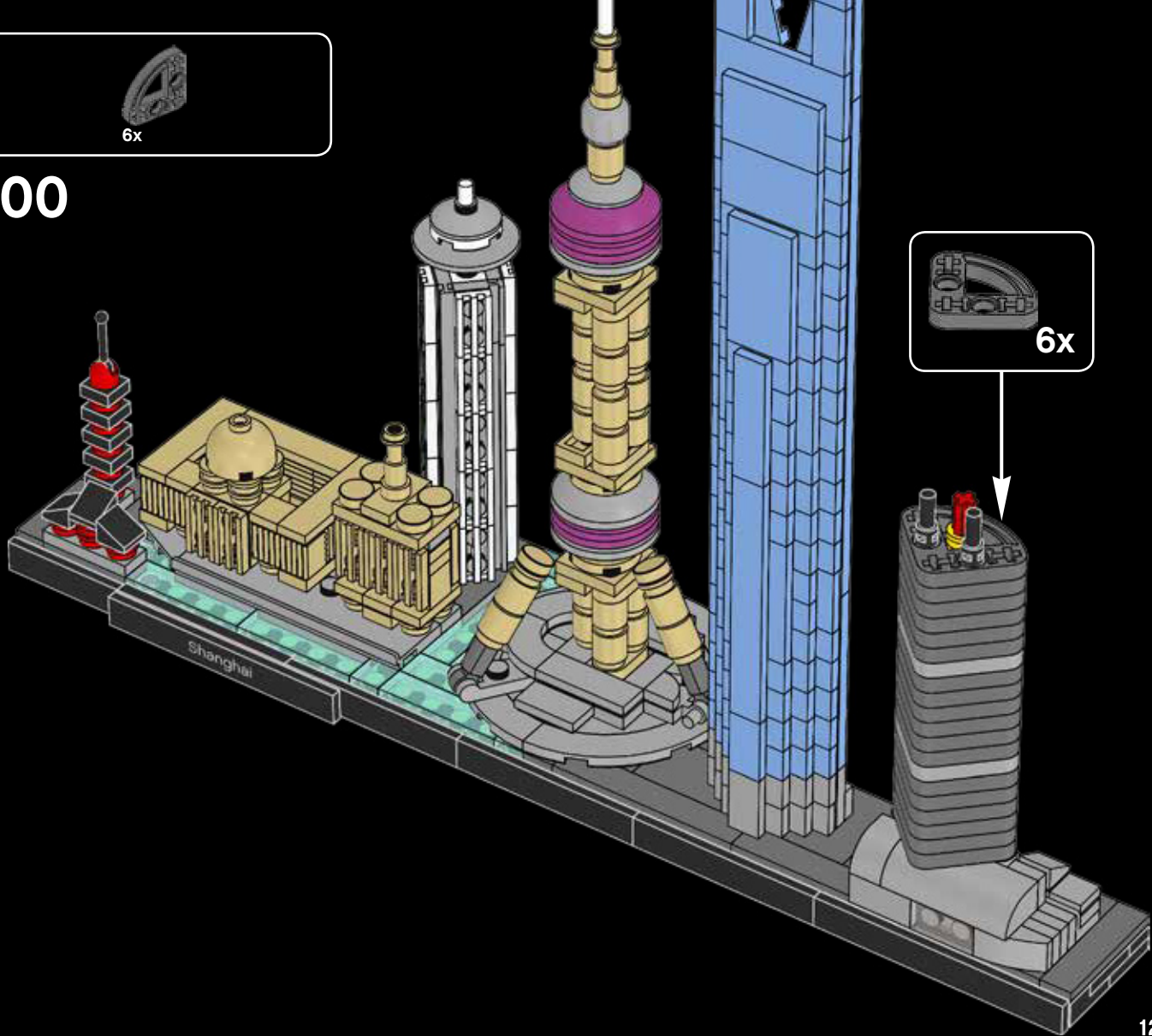

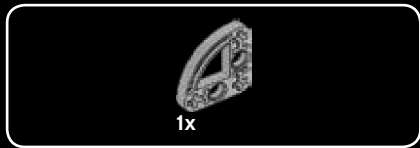

101

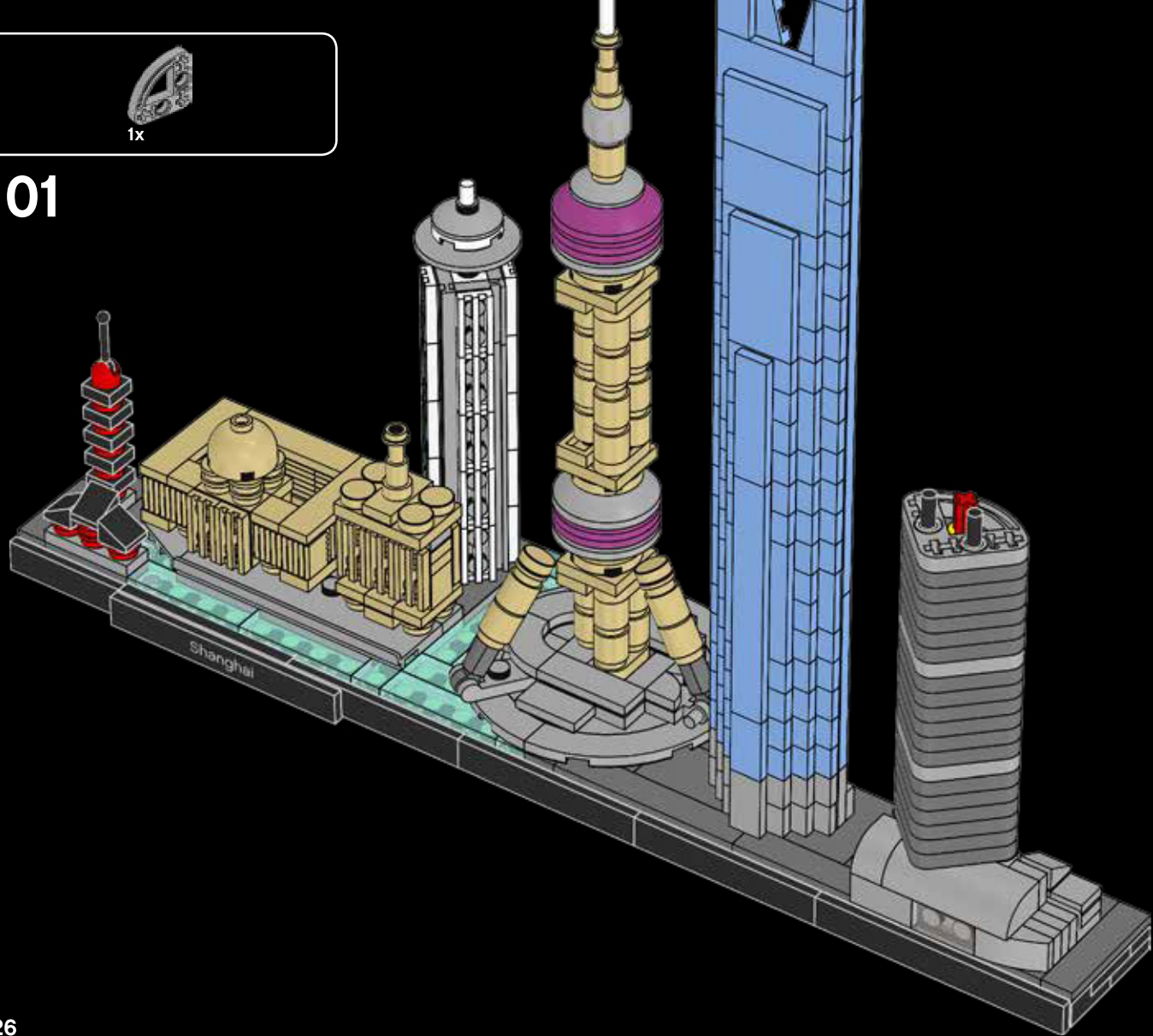

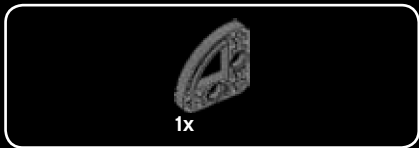

102

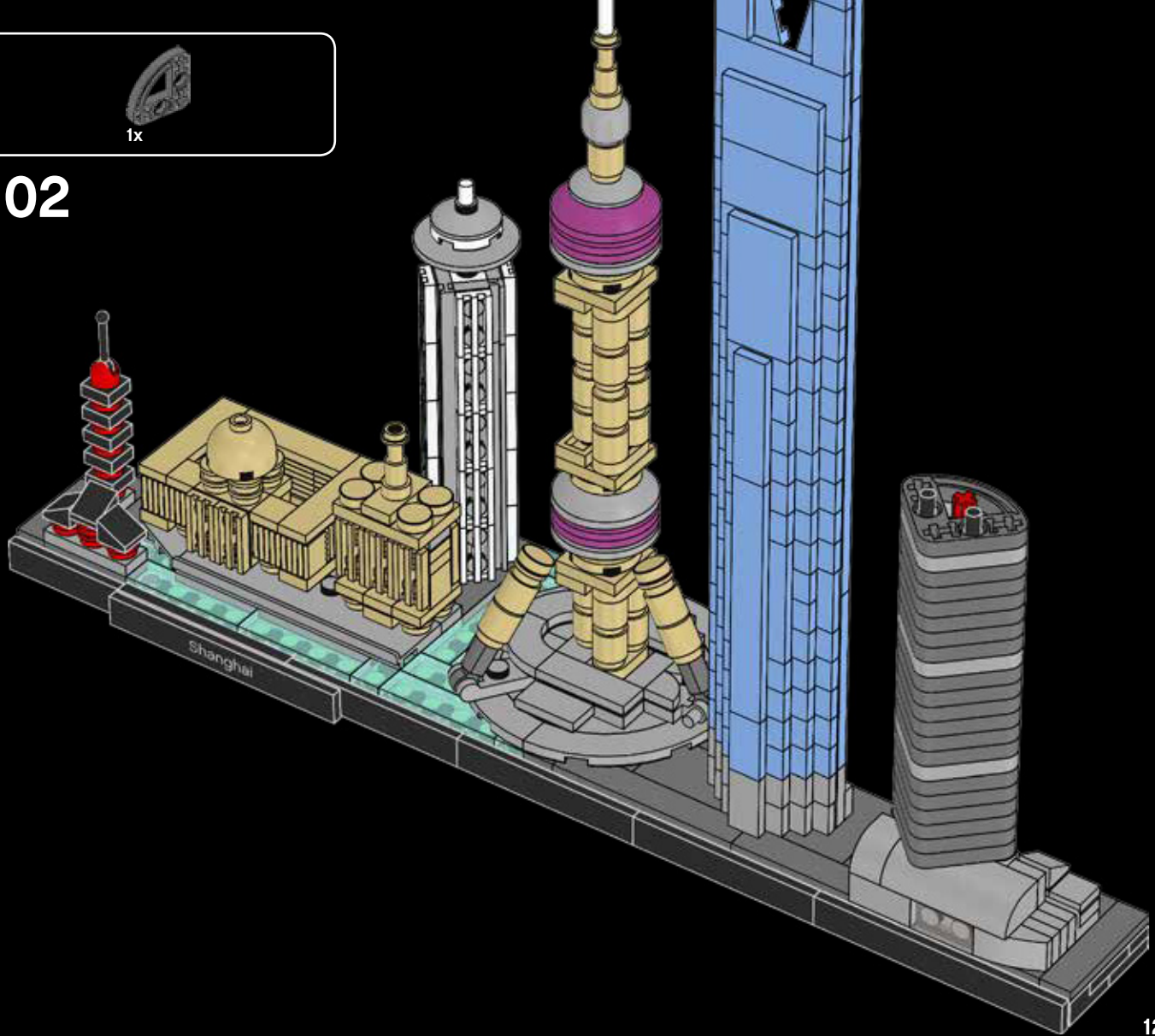



1x

103

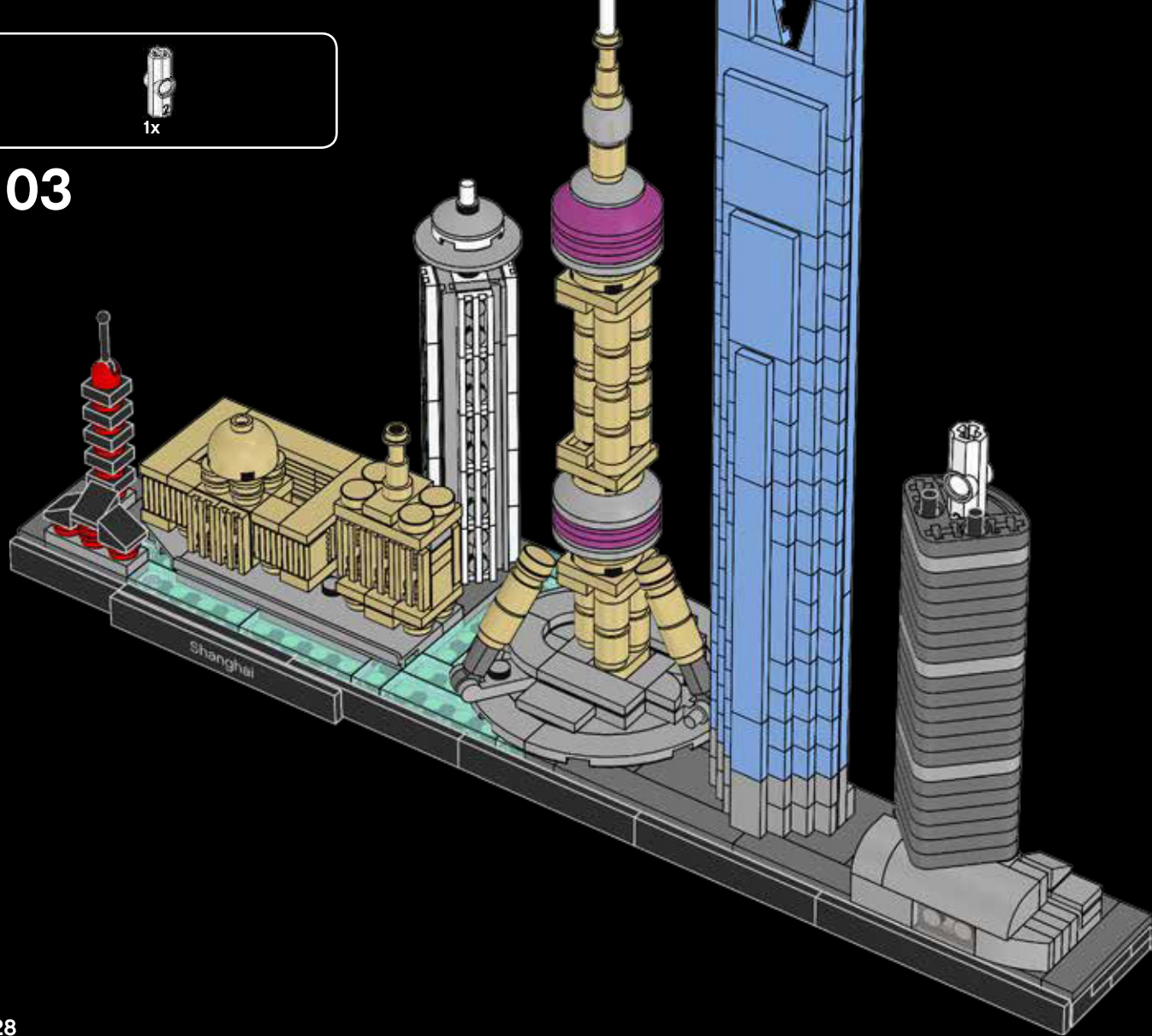

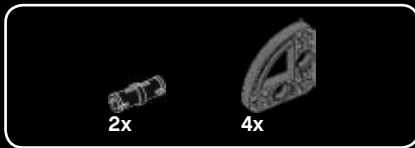

104

The Shanghai Tower is the second tallest building in the world. 127 floors of the tower are above ground and five below ground.

上海中心大厦
上海中心大厦是全球第二高的摩天大楼。地上127层，地下5层。



1



2



3



4

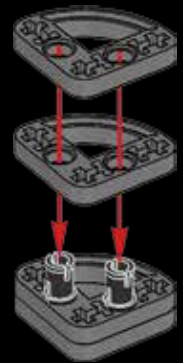

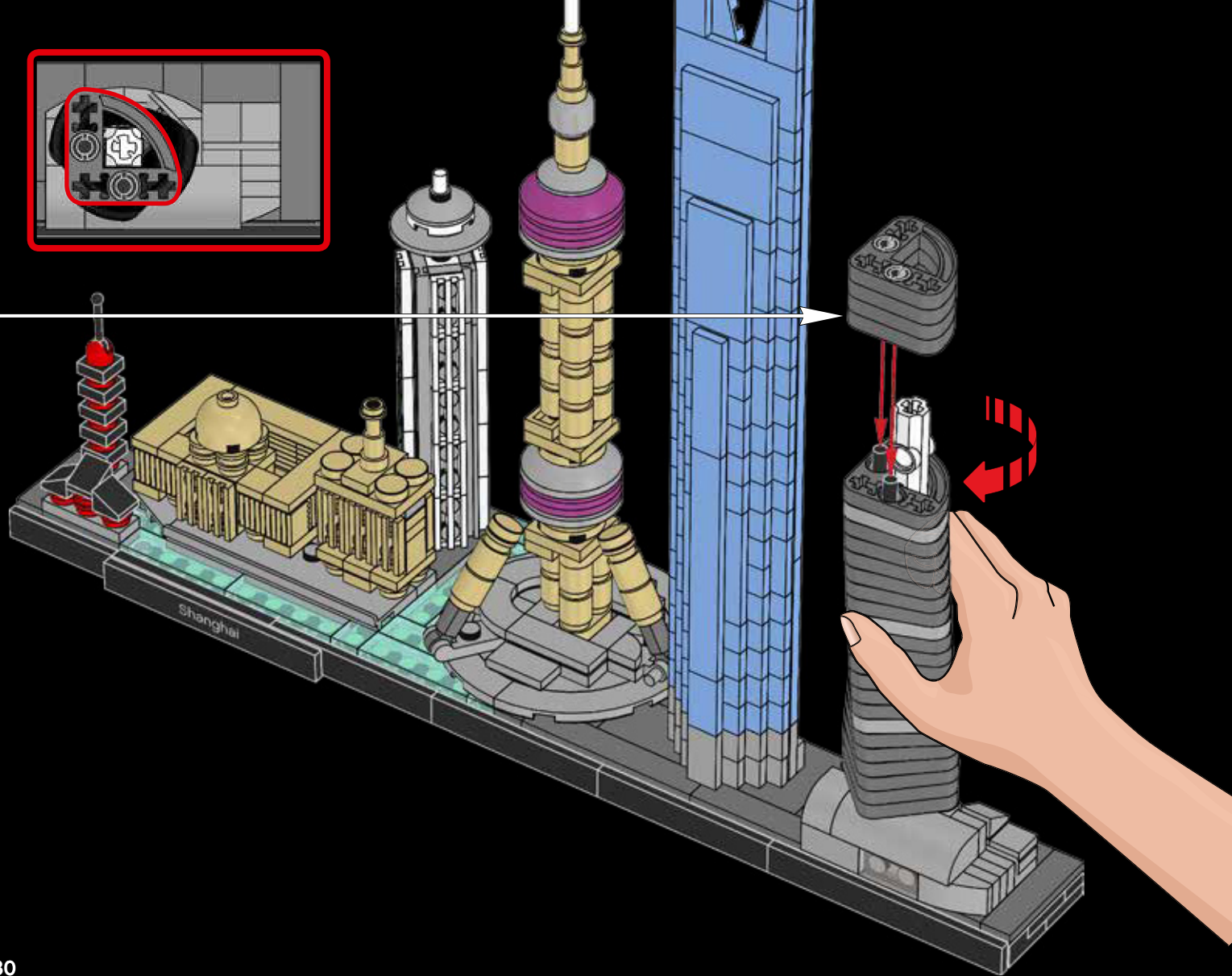
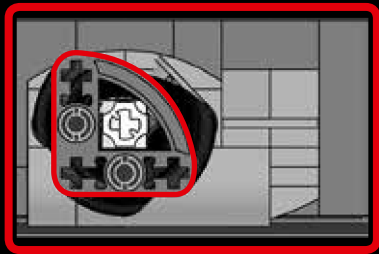

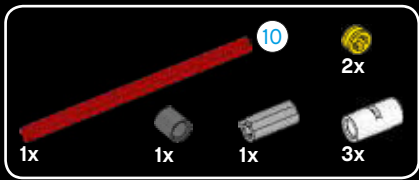

105

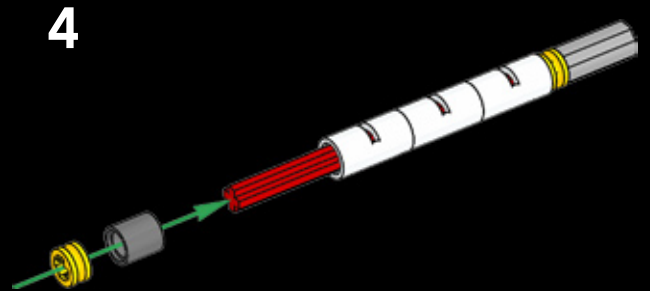
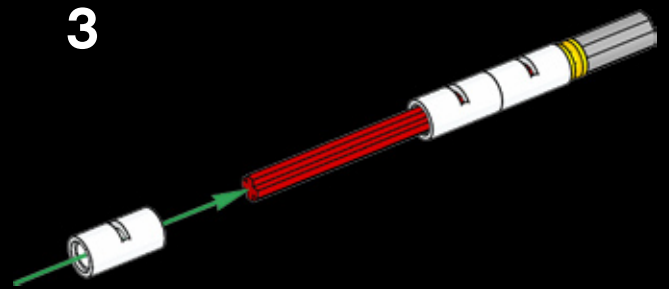
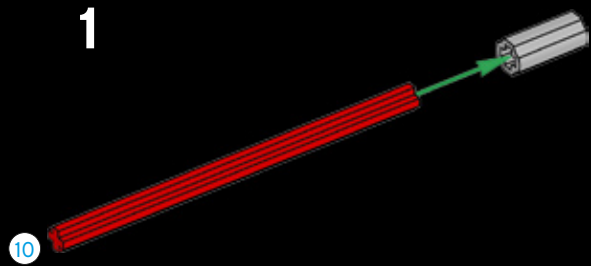

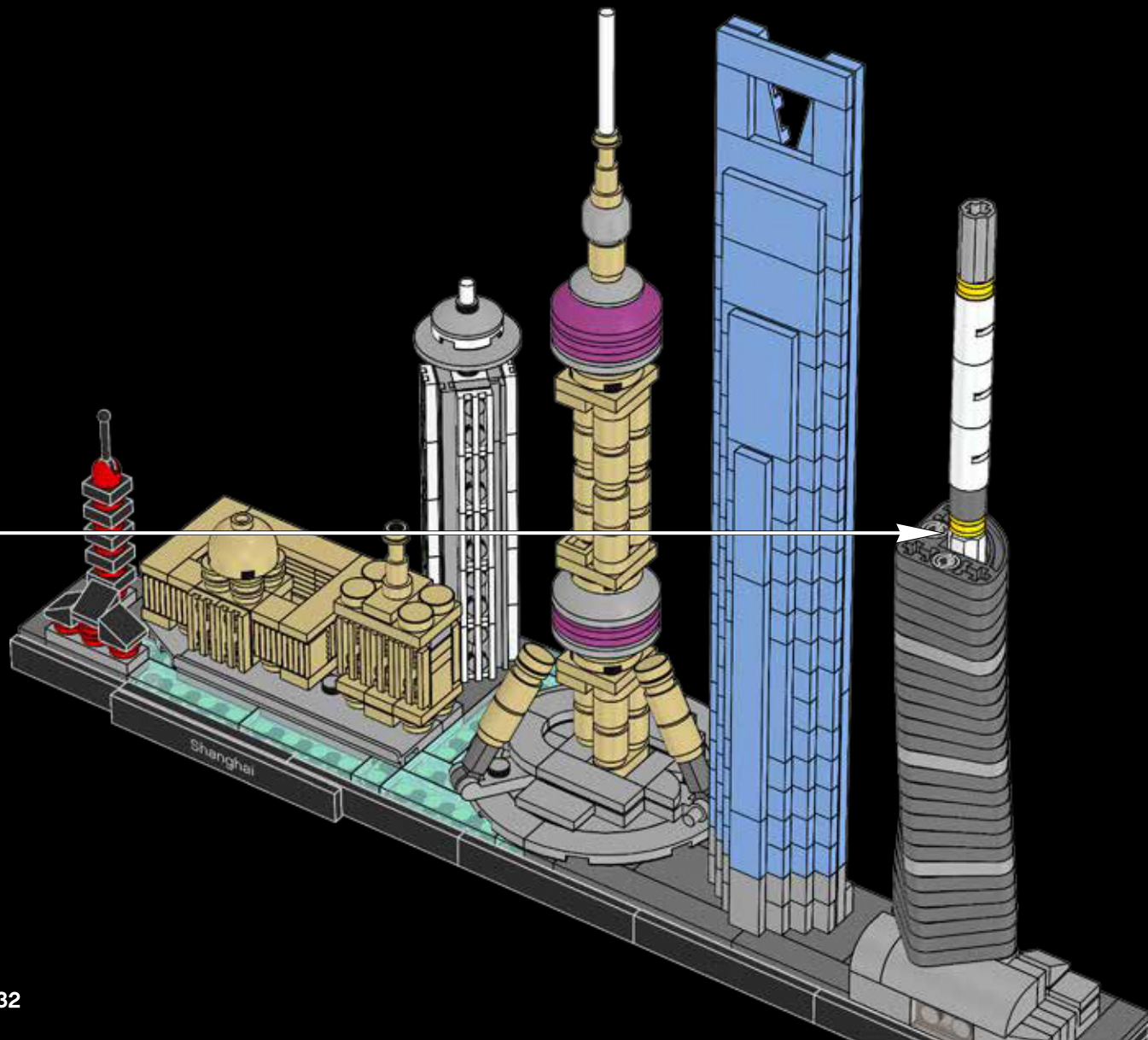

Shanghai

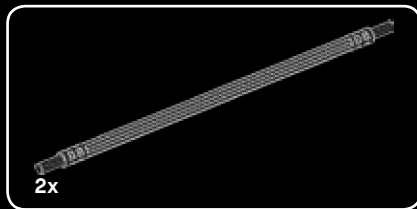

106

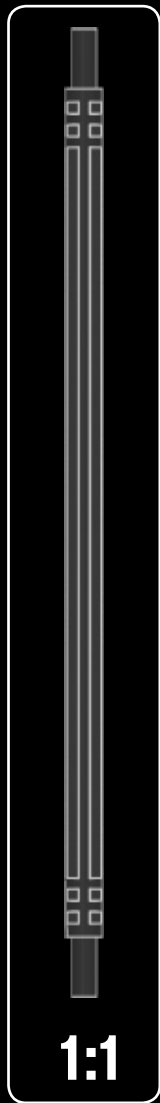
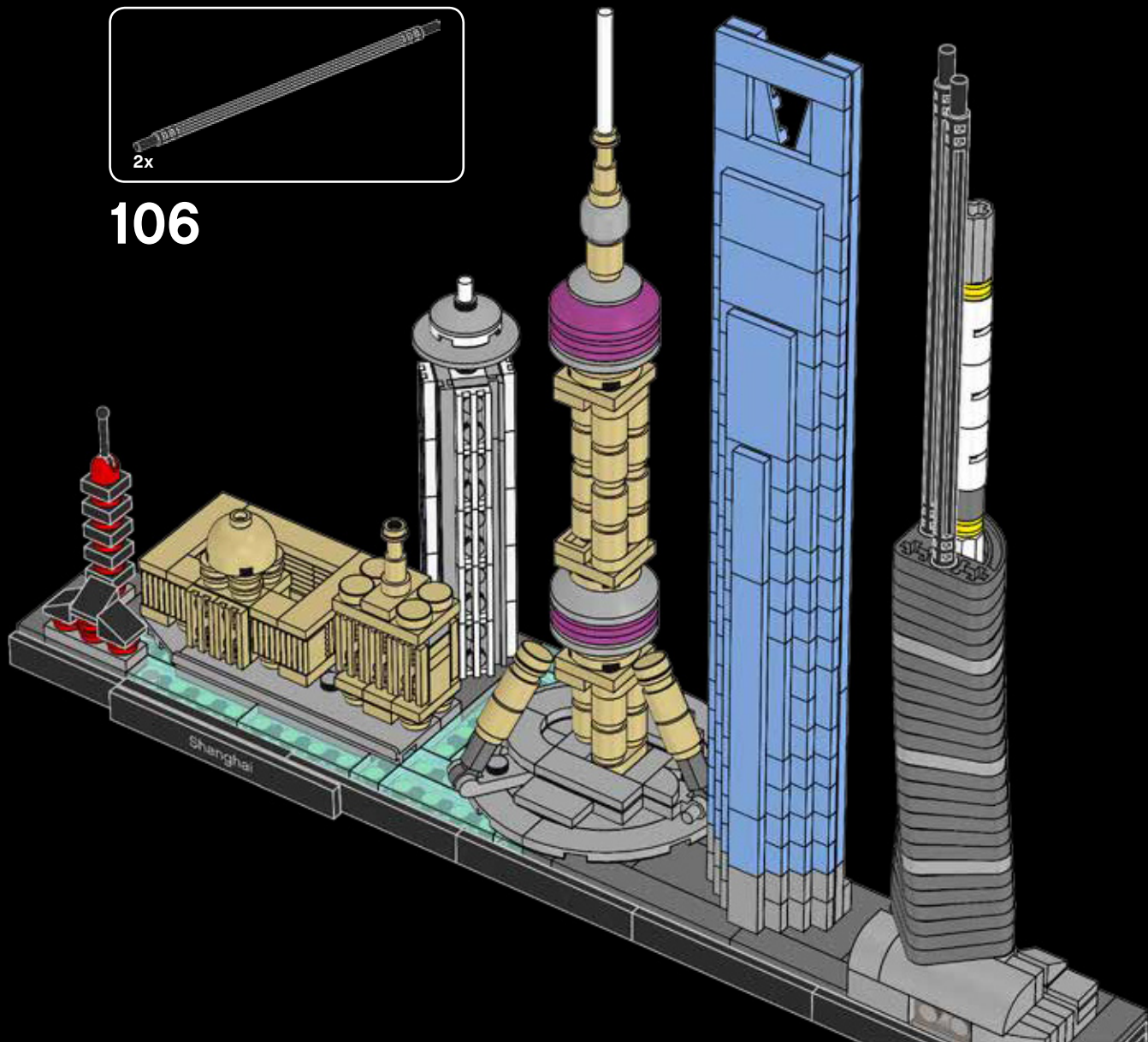

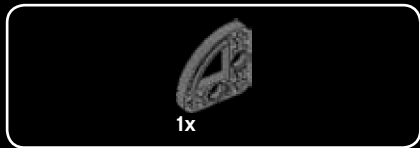

107

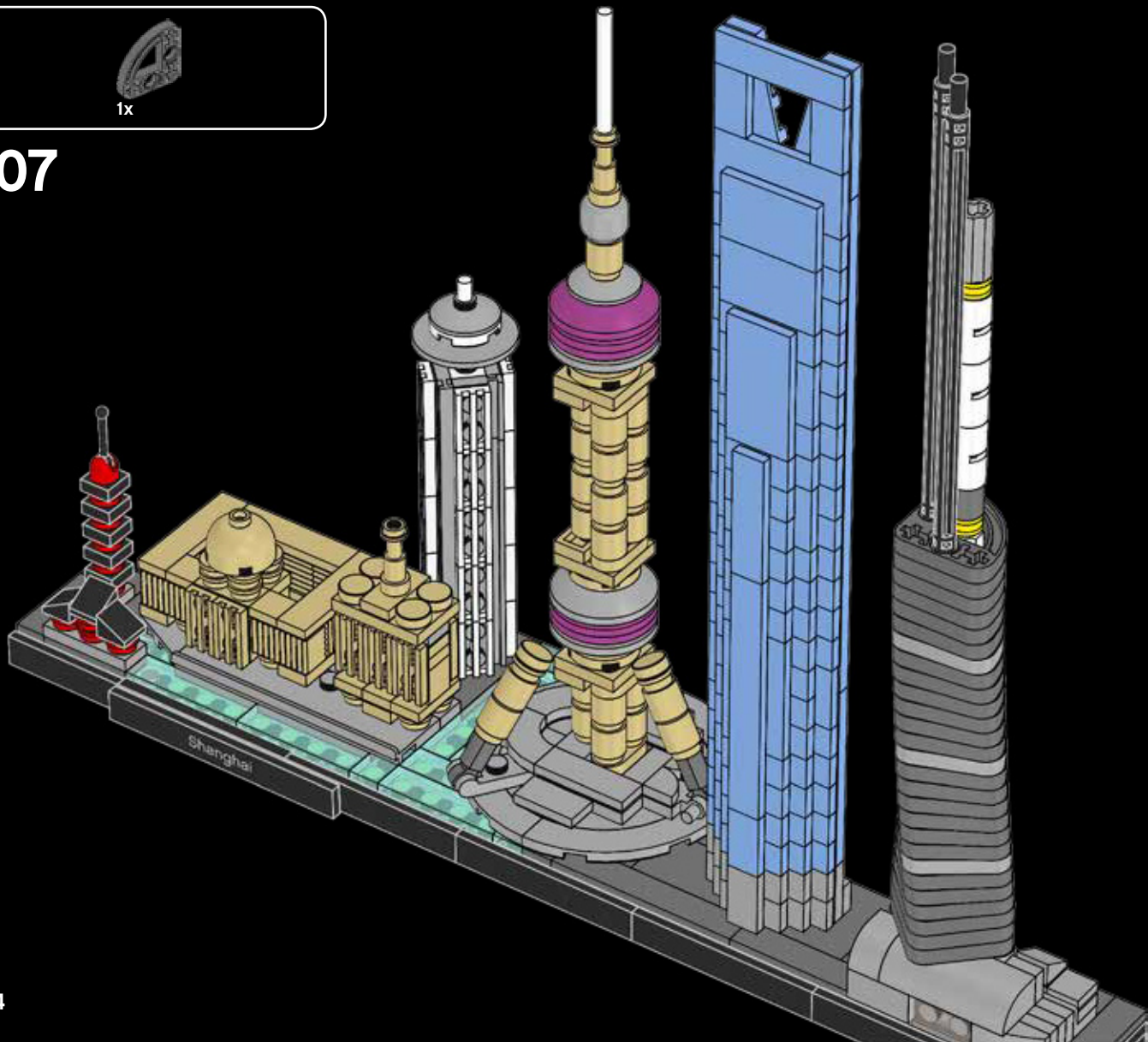

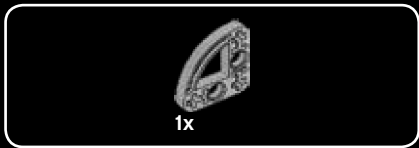

108

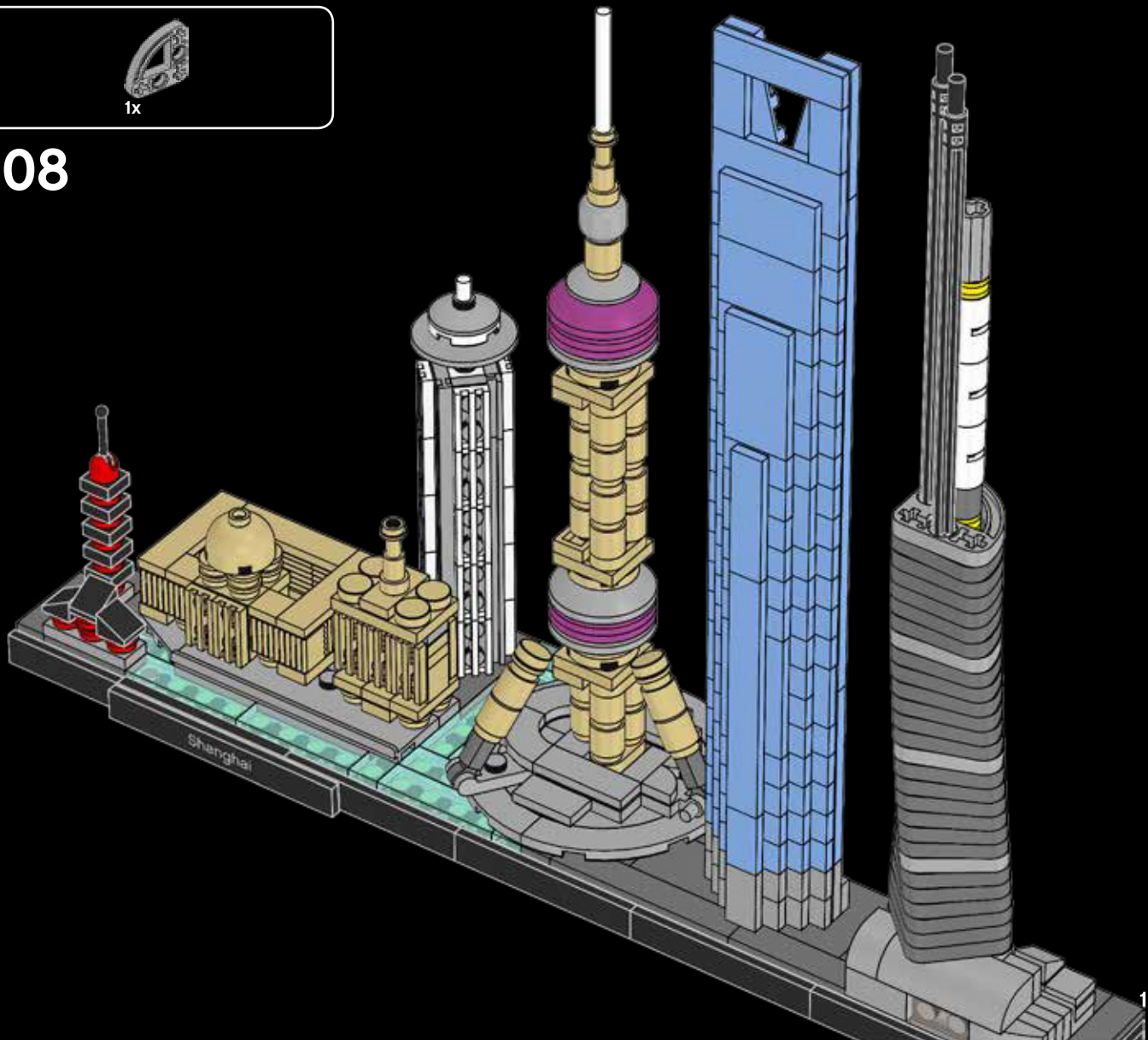



109

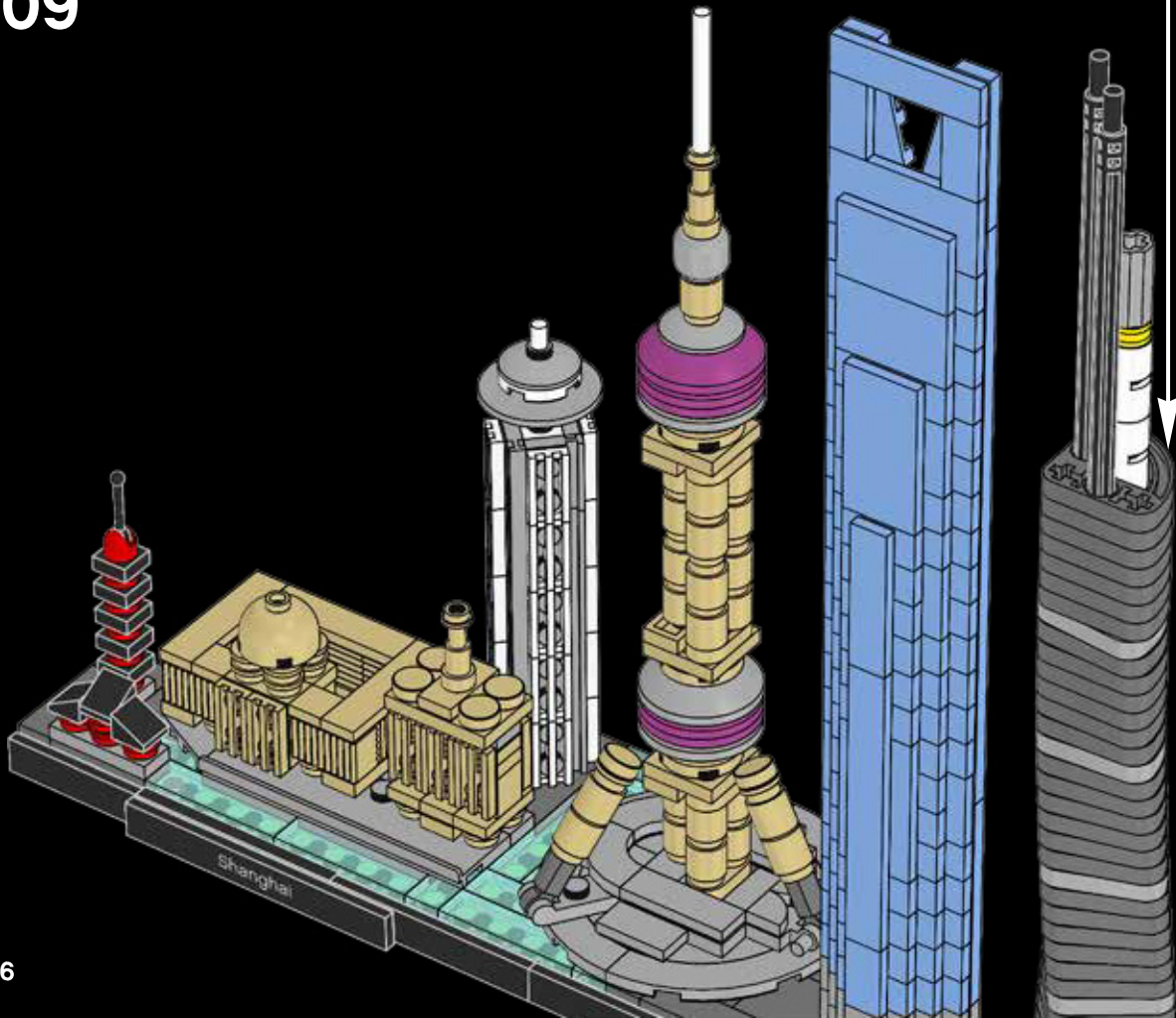



110

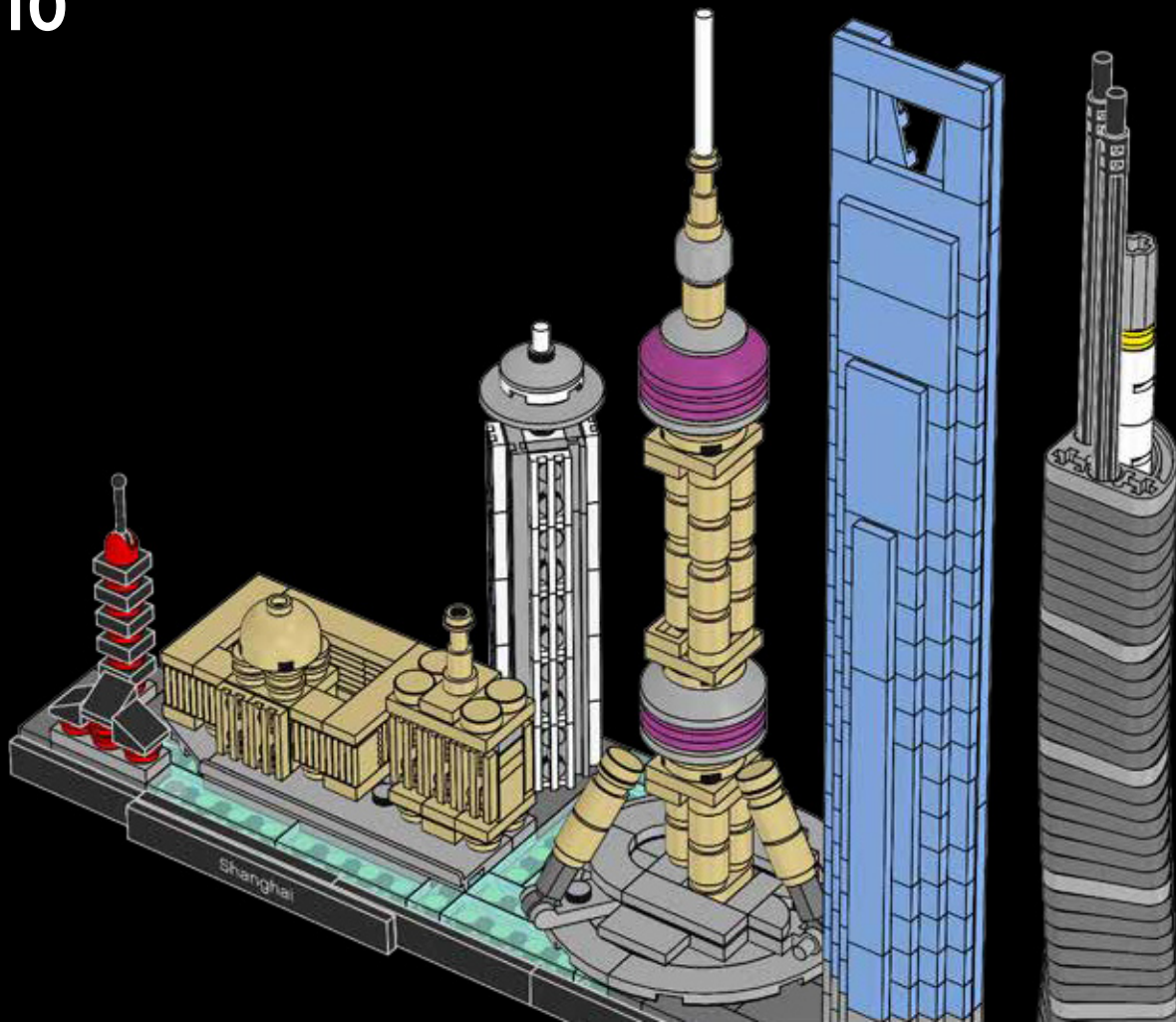

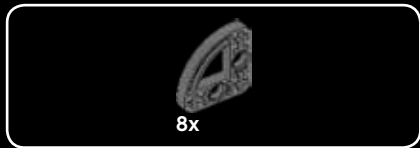

111

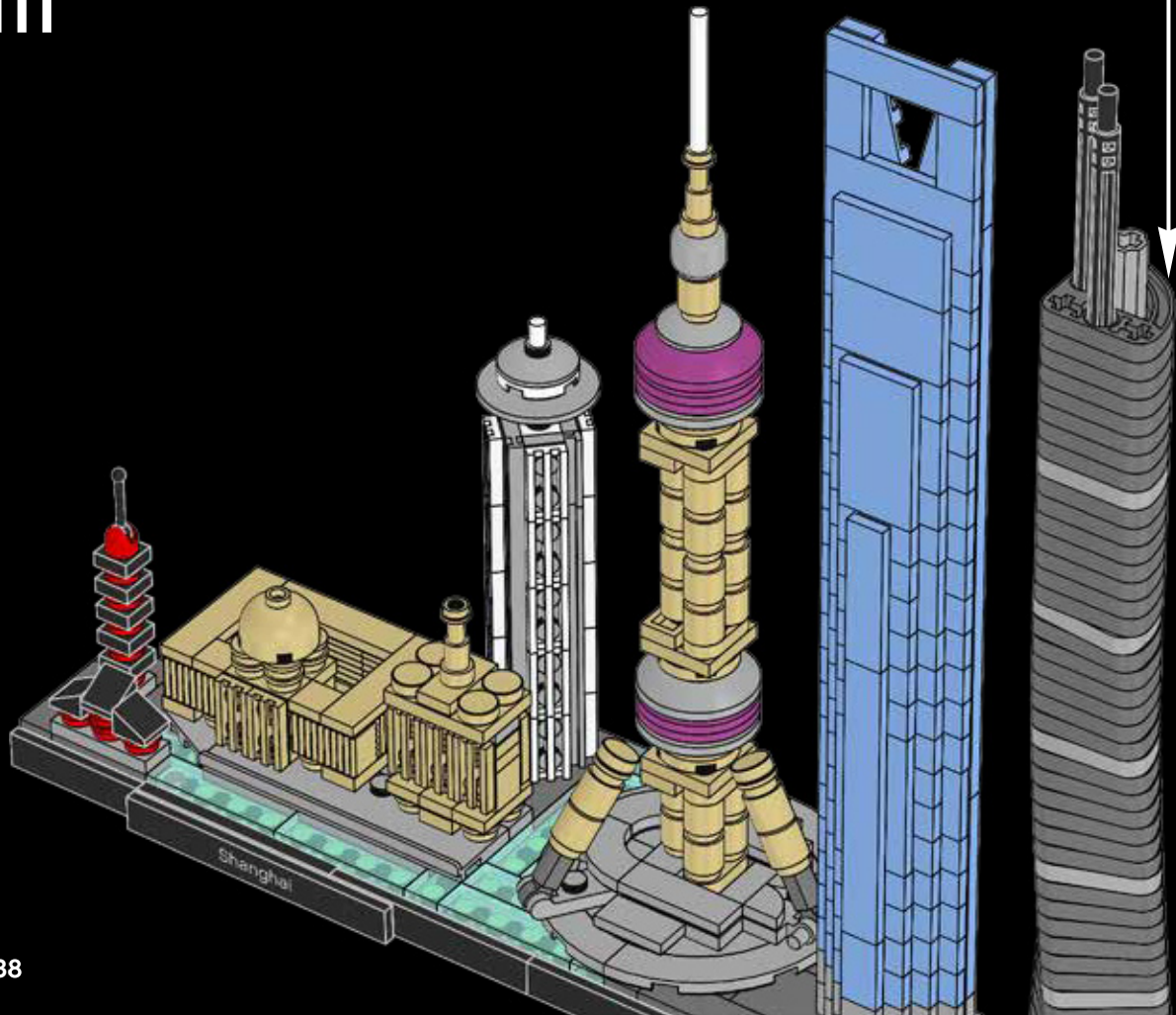



112

Instead of the traditional steel girder framework for a skeleton, the tower is constructed around a thick concrete core.

该大厦未采用传统的钢梁框架结构，而选用了钢筋混凝土芯柱结构，大厦的其它部分环绕芯柱而建。

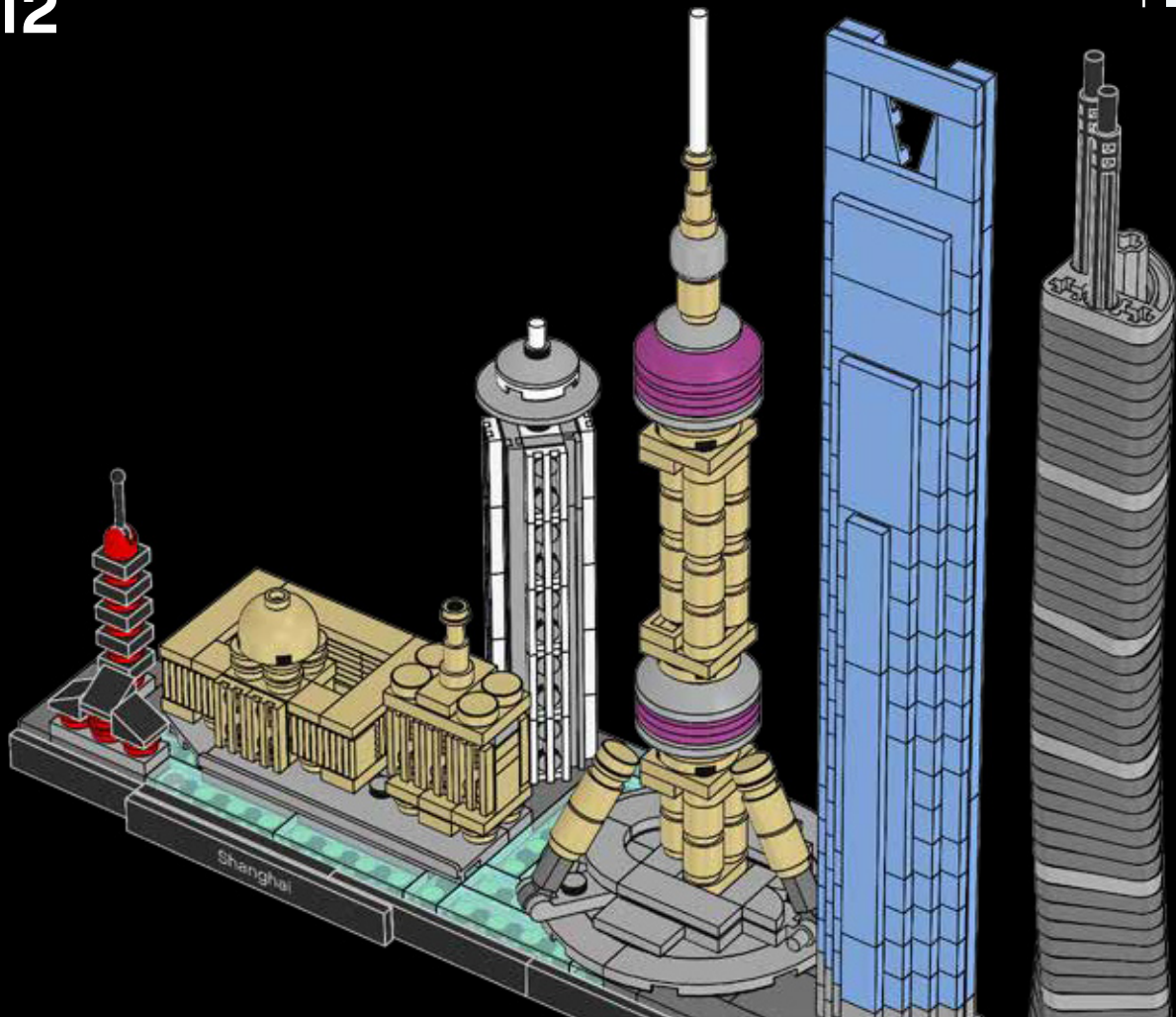

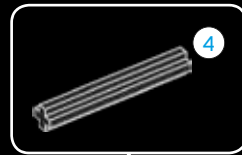
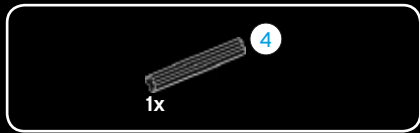

113

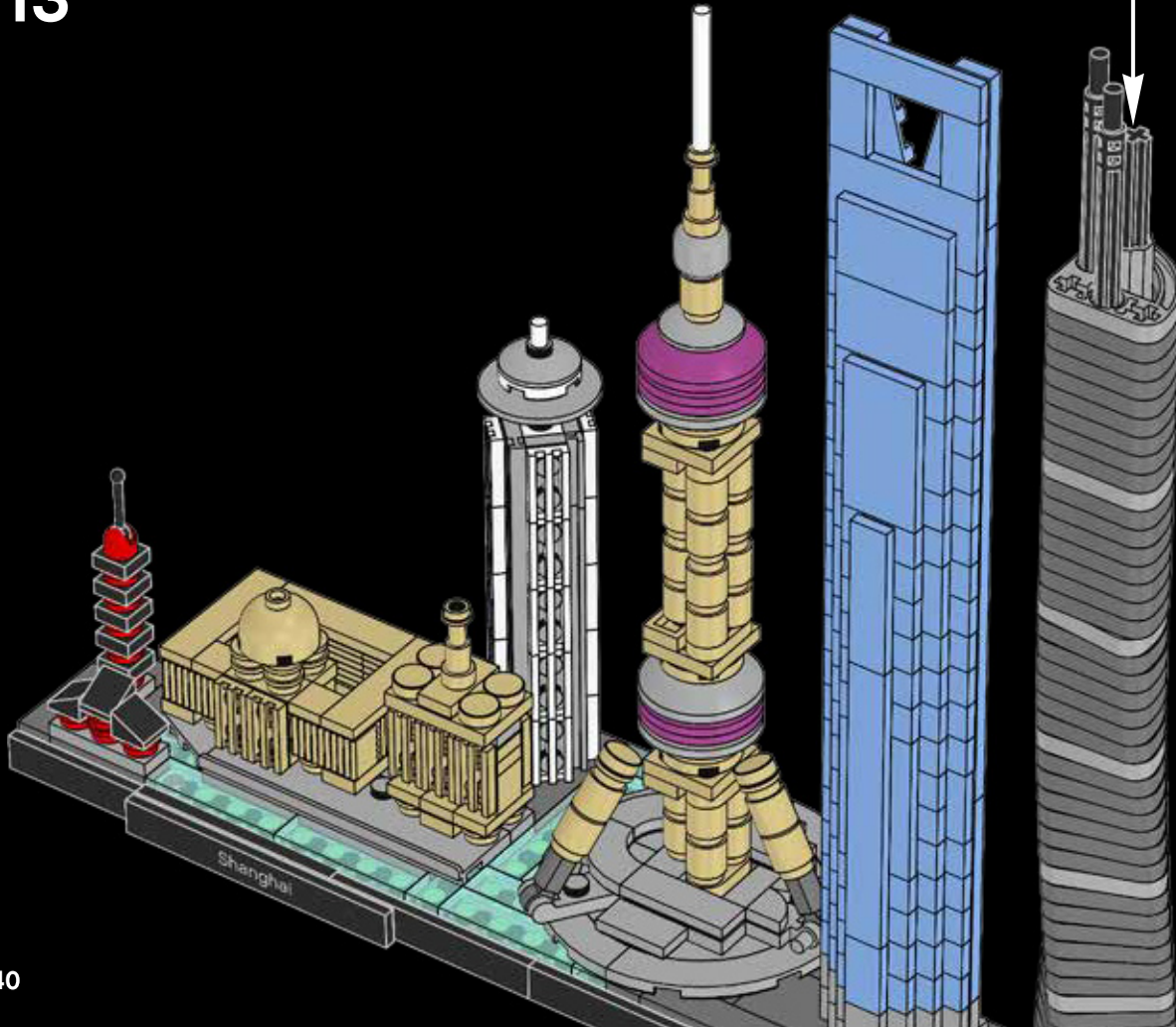



114

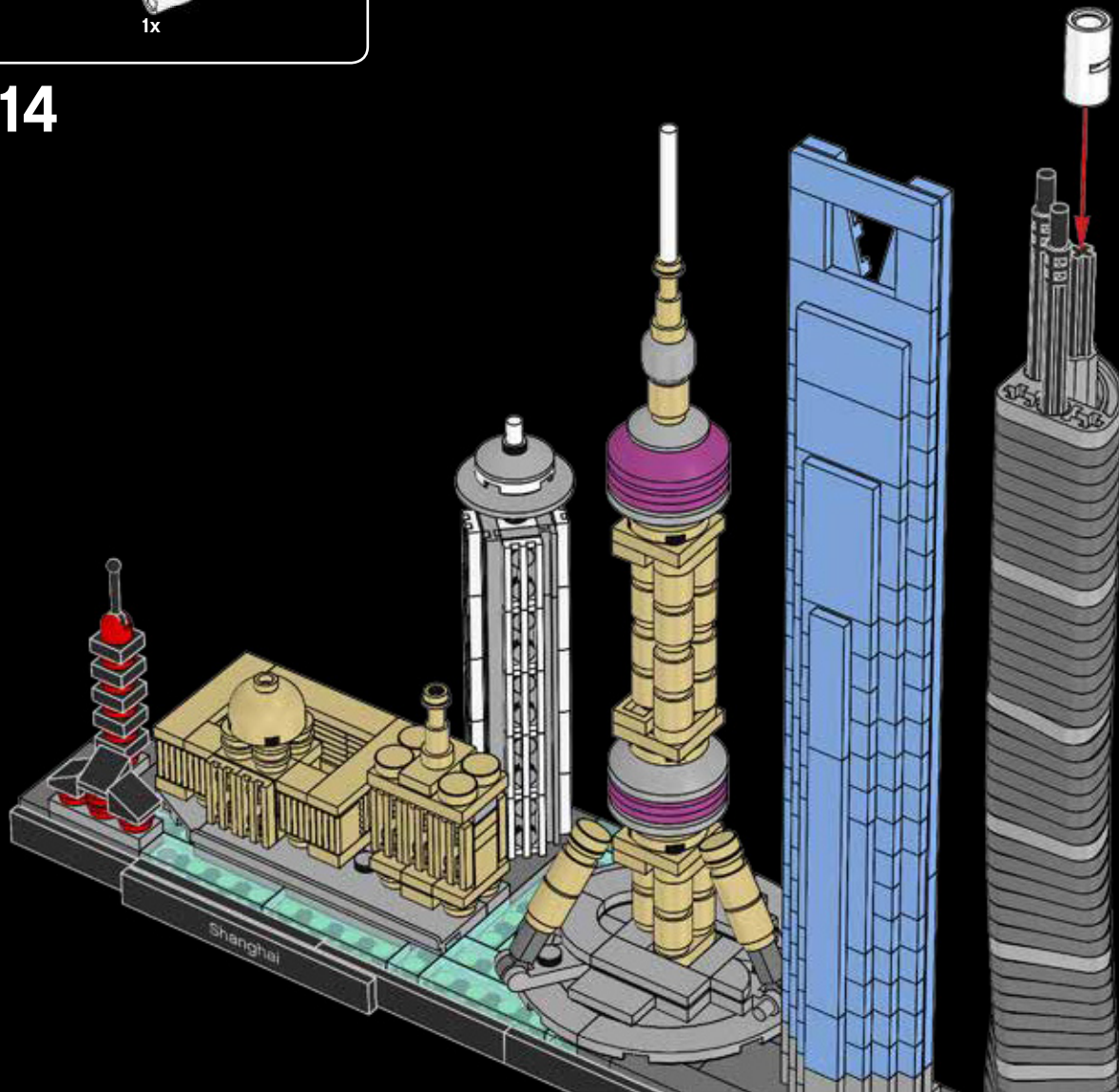



1x

115

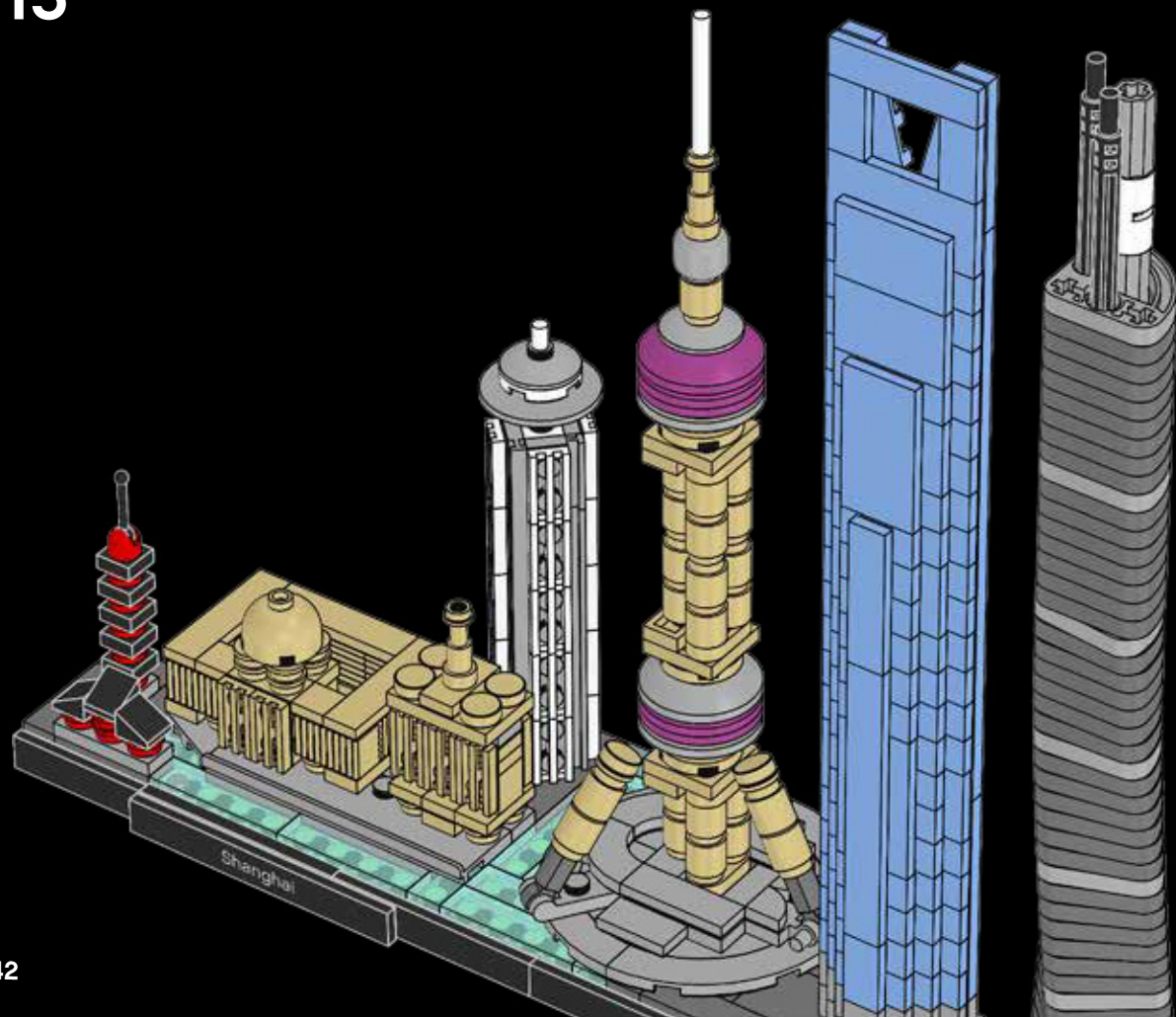

142



116

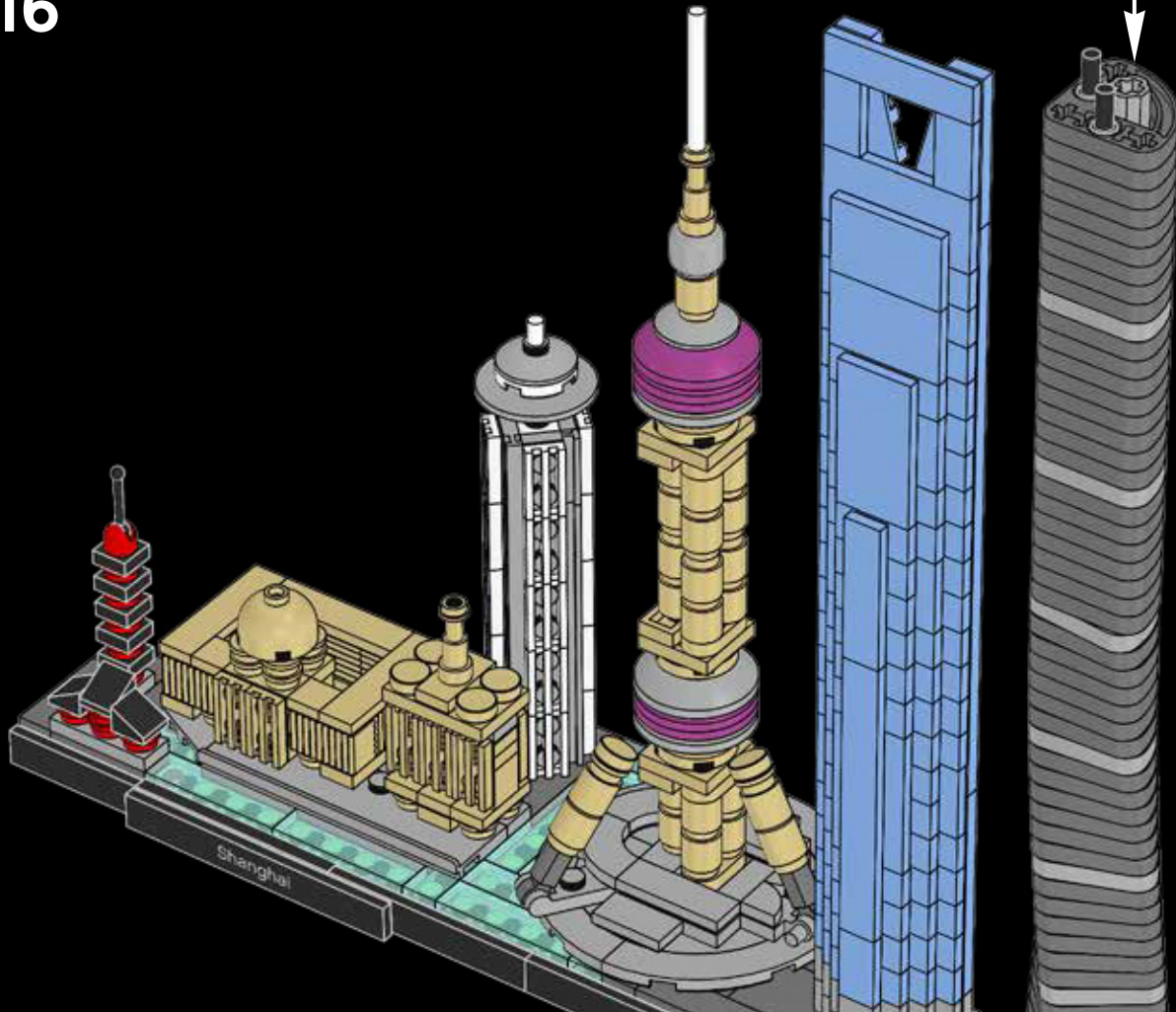



1x

117

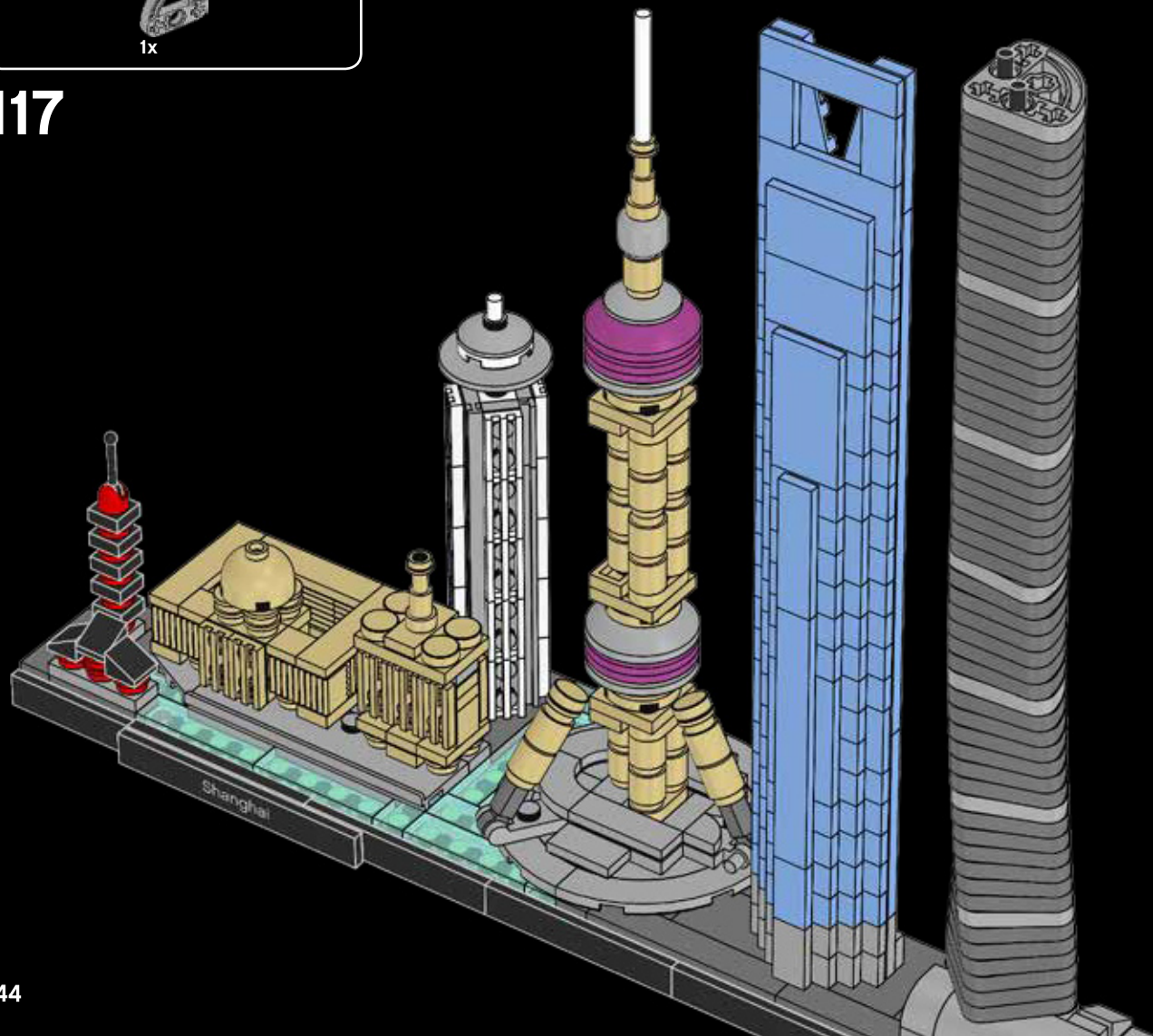



118

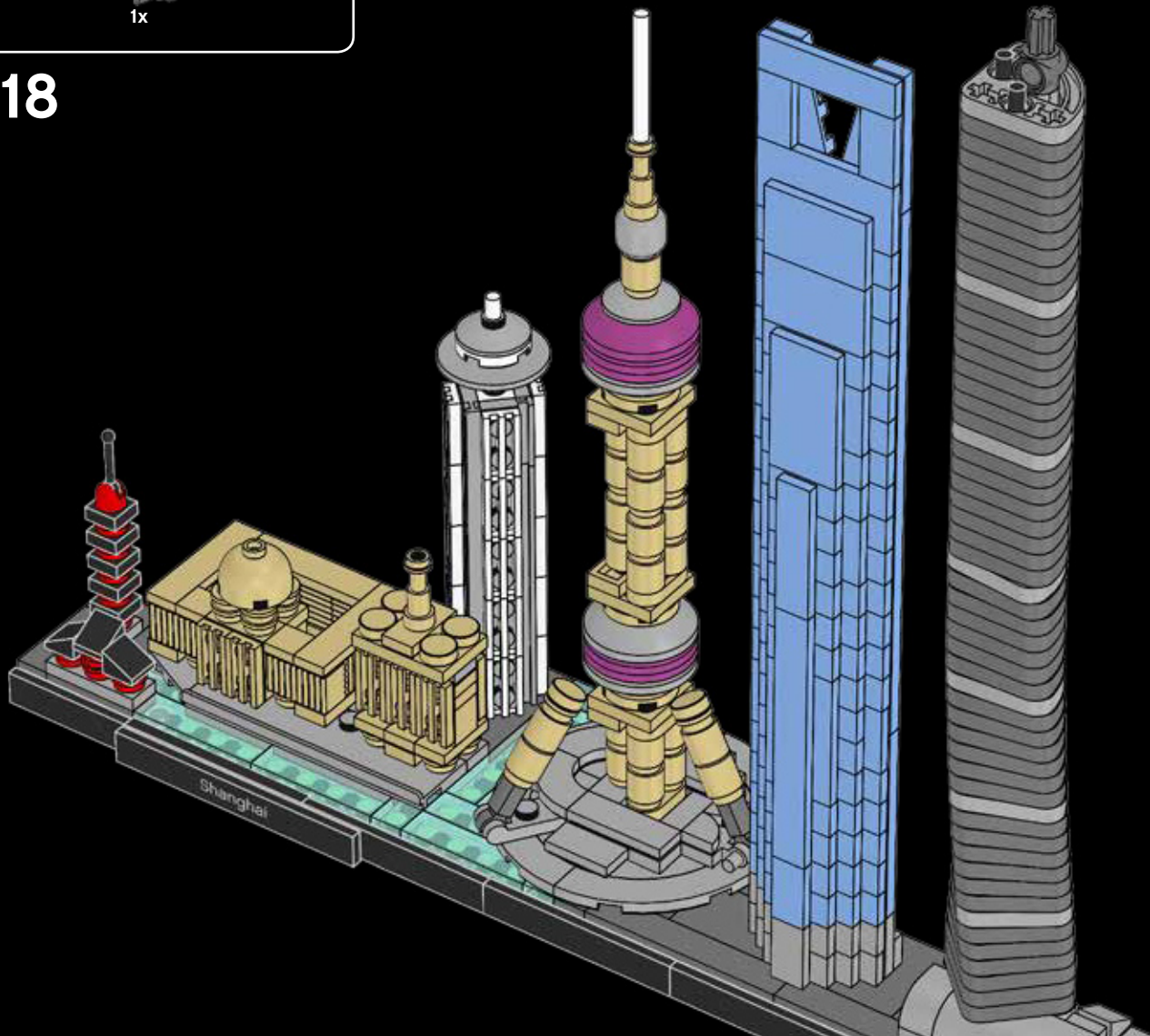

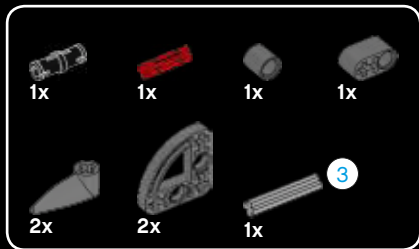

119

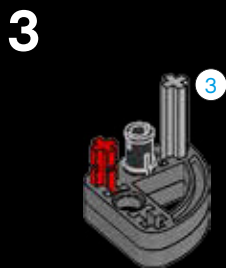
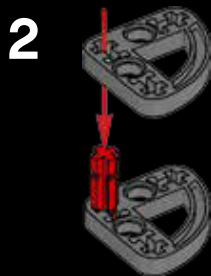

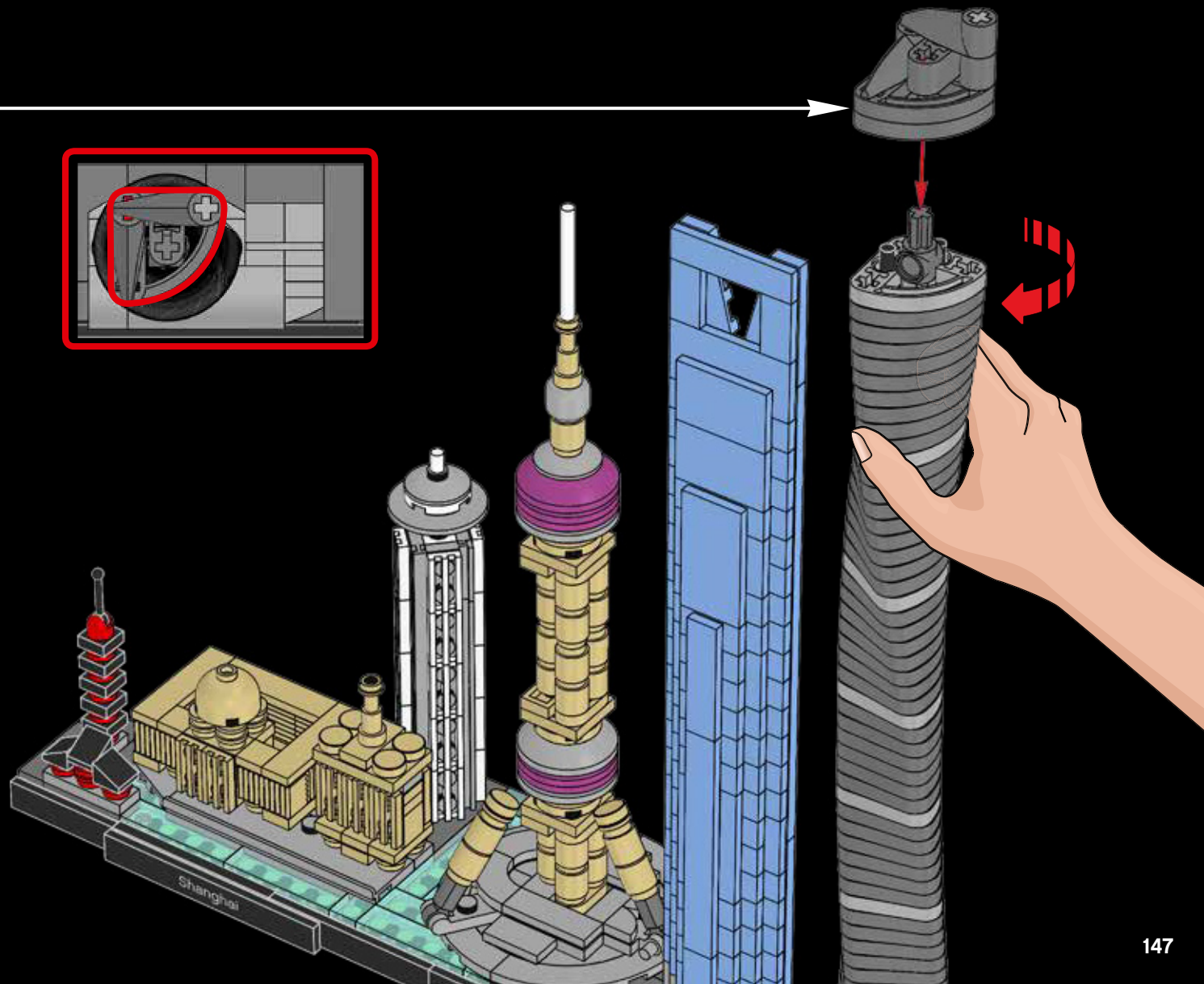

Shanghai

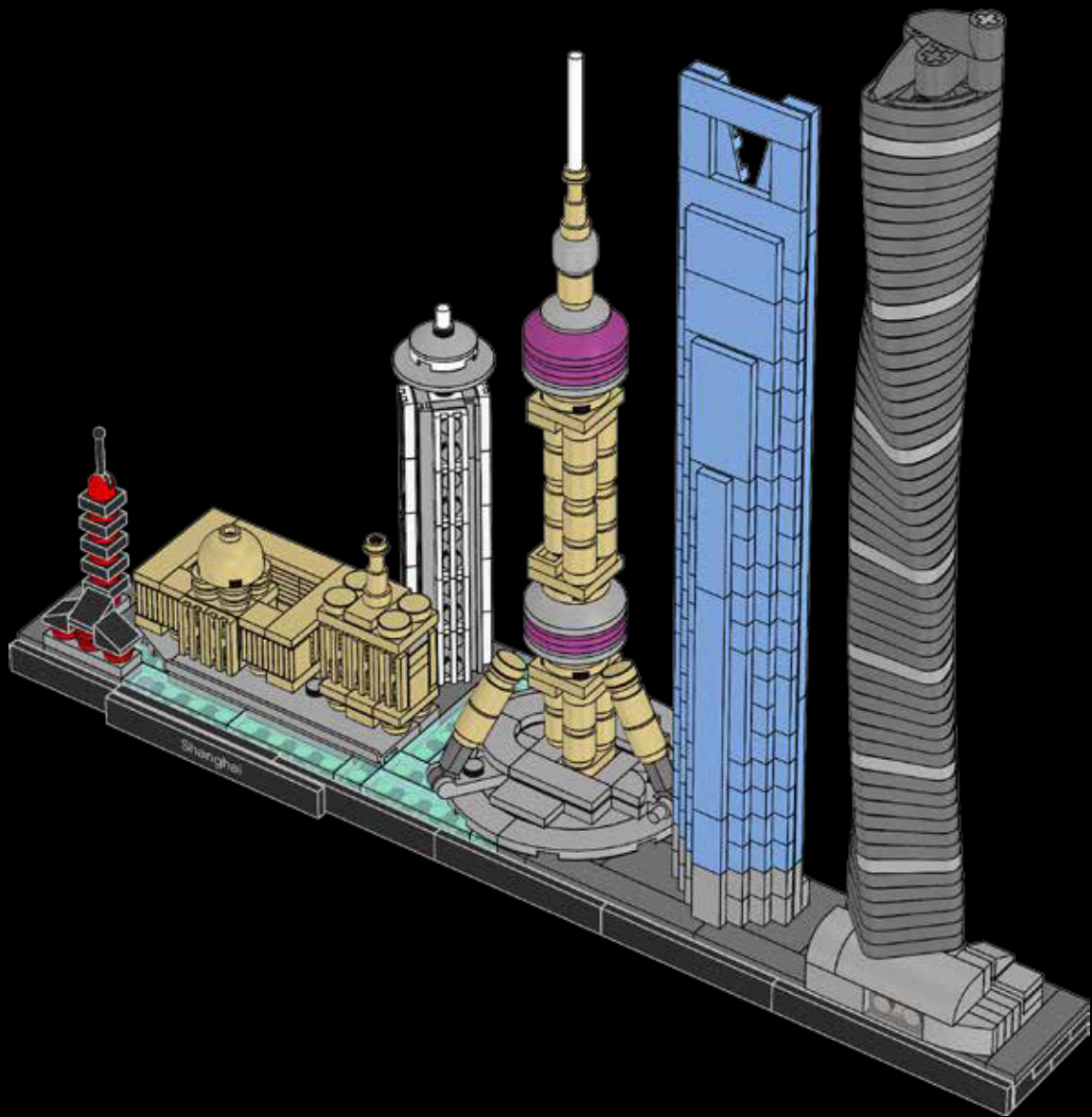



LEGO® Architecture – do you like it?

The LEGO Group would like your opinion on the new product you have just purchased. Your feedback will help shape the future development of this product series. Please visit:

[LEGO.com/productsurvey](https://www.lego.com/productsurvey)

By completing our short feedback survey, you will be automatically entered into a drawing to win a LEGO® prize.

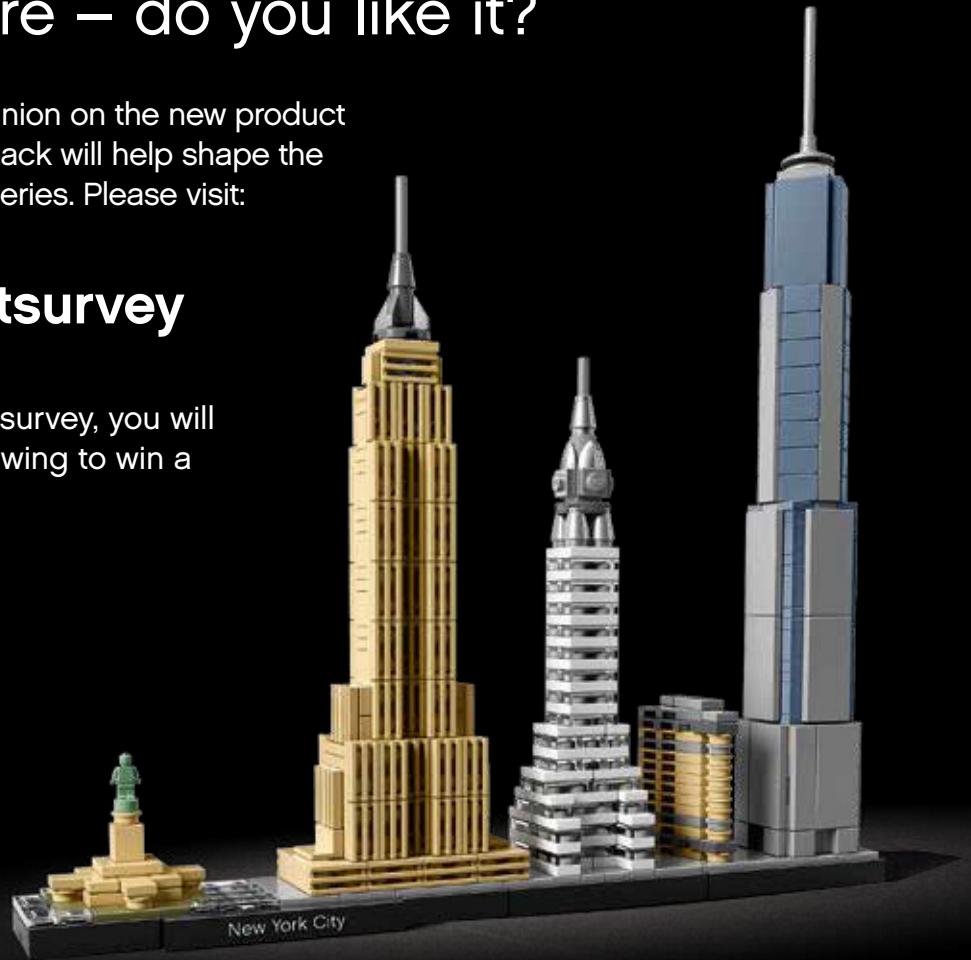

See website for official rules and details. Open to all countries where not prohibited.

乐高®建筑系列——您喜欢吗？

乐高集团期待您就所购买的新产品发表看法。
您的宝贵意见将帮助我们在今后改进本款产品系列。
请访问：

LEGO.com/productsurvey

完成我们简短的反馈调查，即可自动进入抽奖，
赢取乐高®奖品





适用条款和条件。

LEGO® Architecture

The LEGO® Architecture series creatively captures the essence of many of the world's most iconic landmarks while giving you an enjoyable and engaging LEGO building experience.

Whether your interest is in travel, design, history or architecture, these sets are a physical memento of a great trip abroad, a famous building you know well, or a city you still dream of visiting.

Every LEGO Architecture set is designed to be displayed. Much more than just a photo, building and displaying your model on your desk, in the bookcase or on the shelf, lets you be transported every time you admire the view.

Follow us on  



Adam Reed Tucker is the co-developer of the LEGO Architecture product line.

乐高®建筑系列

乐高®建筑系列深得众多世界标志性地标建筑的神韵，同时还为您带来有趣欢乐的乐高拼搭体验。

无论您钟情于旅行、设计、历史，还是建筑，这些套装均可作为超赞的纪念品，以怀念一次超棒的国外旅行、一座您所熟知的著名建筑，或者一座您十分向往的城市。

每款乐高建筑套装都适合展示。这不仅仅是一张照片、一座建筑，或将模型摆放到办公桌上、书柜里或者架子上，每当您欣赏它们时，都会令您身临其境、如醉如痴。

请关注我们： 

亚当·里德·塔克（Adam Reed Tucker）是乐高建筑产品线的合作开发者。





References

Pictures -

© Shutterstock

© Offset

@ Radisson Blu Hotel Shanghai New World

@ Shanghai World Financial Center

@ Shanghai Tower

Text -

www.china.org

www.swfc-shanghai.com

Customer Service
Kundenservice
Service Consommateurs
Servicio Al Consumidor
LEGO.com/service or dial



00800 5346 5555 : 

1-800-422-5346 : 

Celebrate the world of architecture and collect all the models

纵览世界著名建筑，集齐所有乐高建筑系列模型

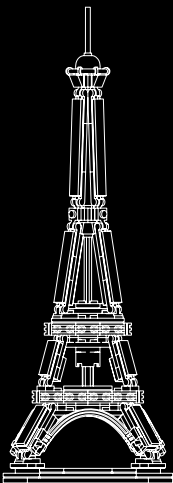

21019
The Eiffel Tower
埃菲尔铁塔

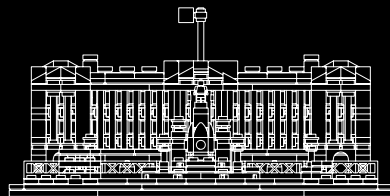

21029
Buckingham Palace
白金汉宫



21028
New York City
纽约



21032
Sydney
悉尼

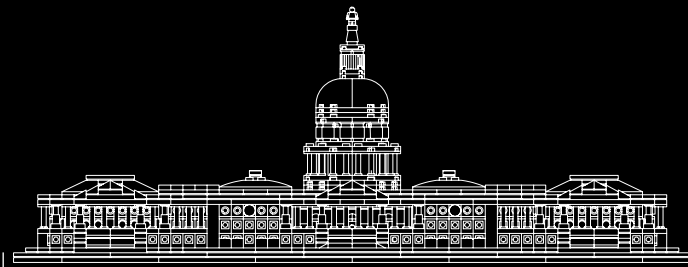

21030
United States Capitol Building
美国国会大厦



21033
Chicago
芝加哥

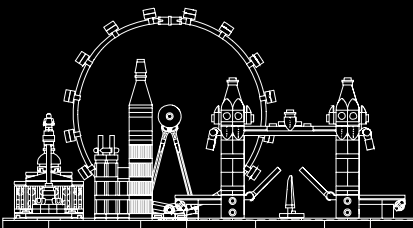

21034
London
伦敦

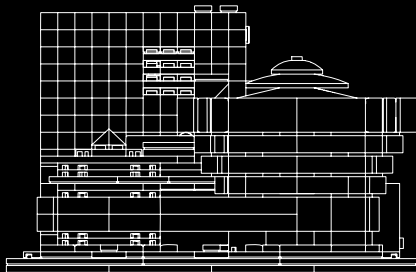

21035
Solomon R. Guggenheim Museum®
古根海姆博物馆®

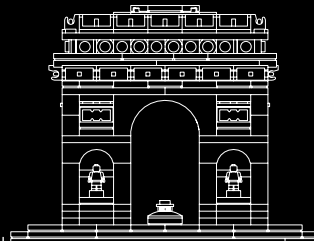

21036
Arc De Triomphe
凯旋门

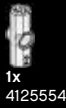

1x
4125554



4x
4111971



1x
474001



1x
6093053



20x
241201



7x
6173116



3x
6116602



25x
4117070



17x
4161734



7x
6139649



4x
4213568



2x
6013938



4x
6212758



3x
6115248



2x
4125253



1x
6191654



8x
4655900



8x
4124456



4x
6092587



1x
6024495



6x
4113917



2x
6060850



3x
4114084



1x
6132769



3x
4121921



1x
4118790



3x
4113233



3x
4550324



9x
614121



1x
4142865



2x
6130005



2x
4206482



4x
4239601



4x
4140587



1x
74335



3x
6188646



3x
4504382



7x
302426



4x
4550017



3x
4121715



1x
6178922



3x
302326

10

2x
302226

3x
6052126

3x
302126

2x
370526

1x
243126

4x
4599499

3x
371026

2x
302026

2x
366626

3x
663626

1x
6101857

2x
379526

4

2x
4653049

1x
6215388

1x
416226

2x
4234438

1x
4514845

3x
244526

2x
6057525

1x
4654448

4x
302328

1x
4107758

1x
302028

1x
366628

2x
6000070

2x
4116671

1x
6021999

5x
6217587

7x
6075208

3x
6051918

11x
4586557



1x
6172408



1x
6172410



1x
4179825



3x
4168345



62x
6092601



2x
6133855



32x
6211970



6x
6211973



2x
4597999



4x
6146503



4x
4179829



1x
6117716

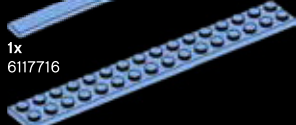

2x
6024127



1x
4211585



4x
6176433



1x
4521921



8x
4211399



2x
4211389



3x
4211415



1x
4211508



1x
6163478



6x
4594238



2x
4211512



2x
4211775



3x
4512360



2x
6144138



1x
6028813



6x
6066097



1x
4211519



7x
4211398



8x
4211414



1x
6004990



4x
4211568



1x
4667578



1x
4211632



7x
4531184



1x
4211353



2x
4211397



2x
6163990

3



1x
4211815



2x
4515369



3x
6070564



4x
6211969



4x
4211429



2x
4558169



3x
4211445



1x
4260409



2x
6081975



1x
4211438



4x
6163989



1x
6015349



4x
4211498



1x
4211406



1x
4222019



3x
6015890



3x
6100030



1x
6005331



1x
6006141



7x
4211052



2x
6217813



50x
6093835



2x
4211094



1x
6167281



2x
4211133



4x
4568734



4x
6187008



6x
4211053



2x
4211065



3x
4210651



1x
4222042



1x
4529685

Customer Service

Kundenservice

Service Consommateurs

Servicio Al Consumidor

LEGO.com/service or dial



: 00800 5346 5555

: 1-800-422-5346

