

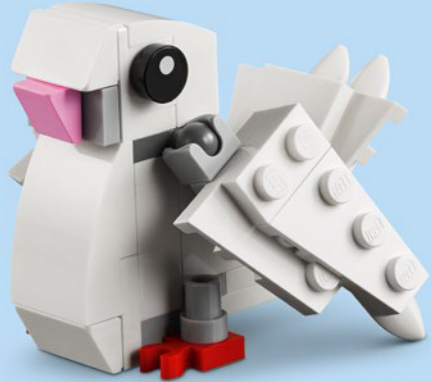

6+  
40406



6324898/6324903

- |            |            |            |            |
|------------|------------|------------|------------|
| 4x 4558952 | 6x 302301  | 2x 362301  | 2x 6043639 |
| 4x 4224792 | 1x 6097637 | 1x 6132212 | 1x 4654577 |
| 3x 4179875 | 2x 4535737 | 1x 6156667 | 1x 6302648 |
| 3x 4179874 | 1x 6047220 | 2x 4588003 | 2x 6039479 |
| 2x 4547489 | 1x 302201  | 2x 6284072 | 1x 4599538 |
| 1x 4234525 | 2x 300401  | 2x 4278273 |            |
|            | 2x 4515364 | 1x 6066097 |            |

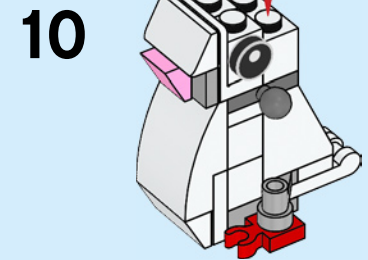
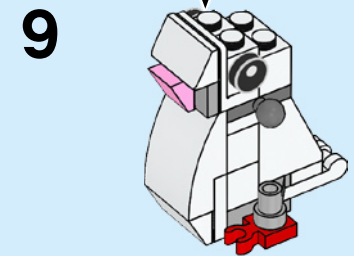
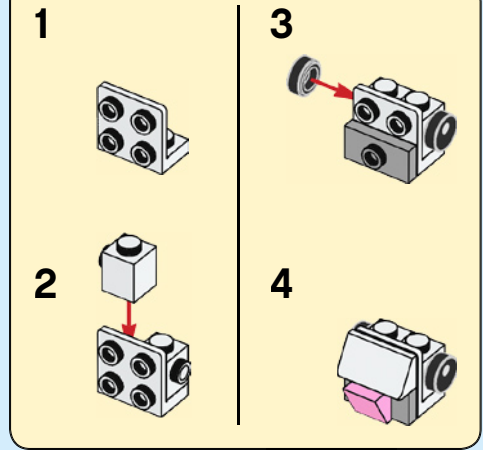
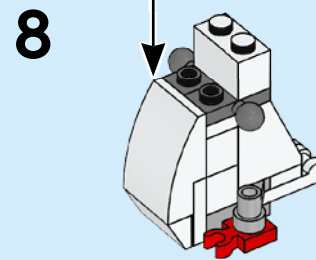
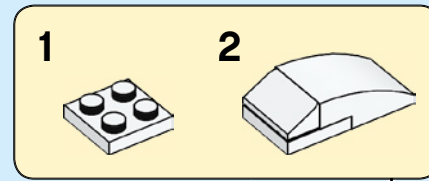
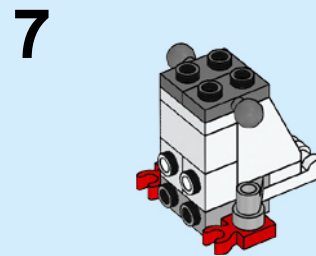
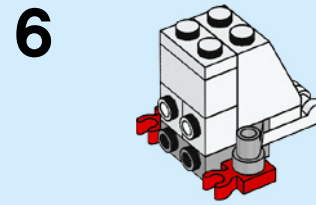
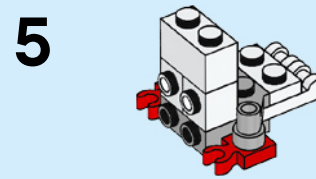
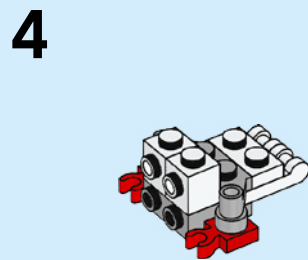
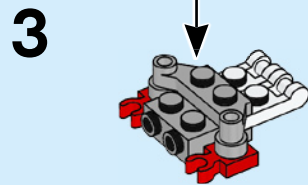
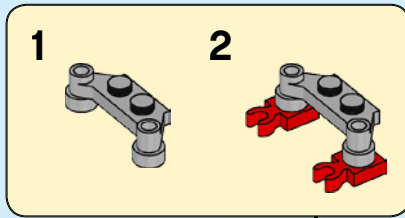
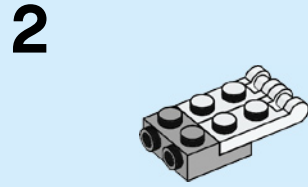
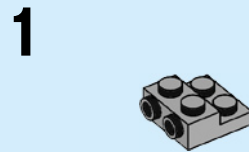

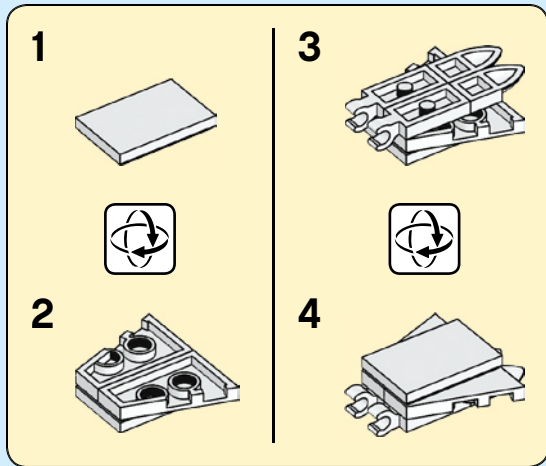

11

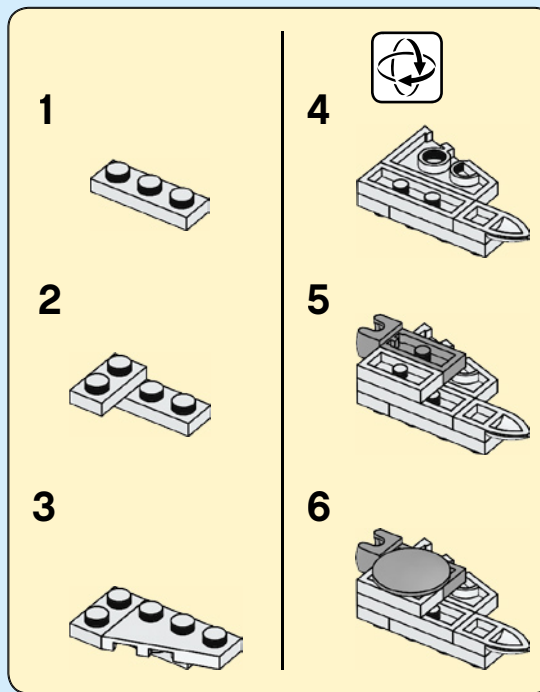
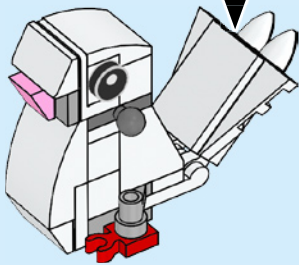

12

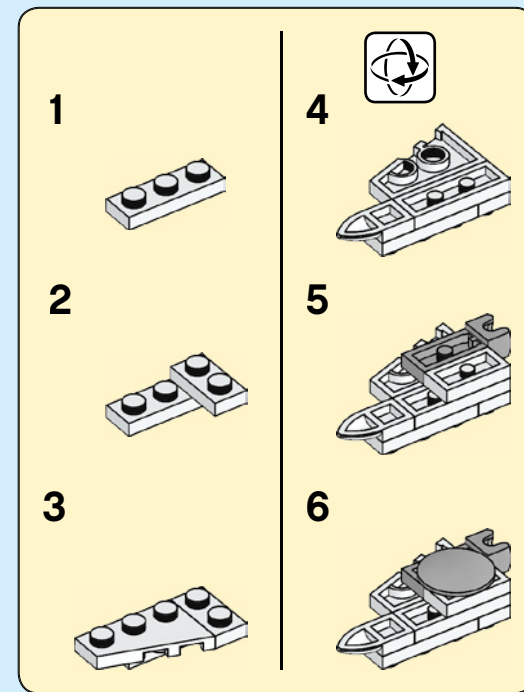
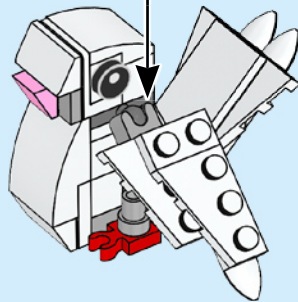

13

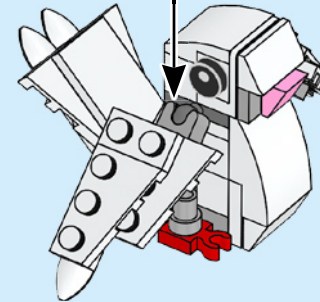

Warning! Choking hazard. Small parts.  
 Achtung! Erstickungsgefahr. Kleine Teile.  
 Attention! Danger d'étouffement. Petits éléments.  
 Avvertenza! Rischio di soffocamento. Piccole parti.  
 Waarschuwing! Verstikkingsgevaar. Kleine onderdelen.  
 ¡Advertencia! Peligro de atragantamiento. Partes pequeñas.  
 Advarsel! Kvælningsfare. Små dele.  
 Viðvörðun! Köfnunarahætta. Litlir hlutir.  
 Varoitus! Tukehtumisvaara. Pieniä osia.  
 Varning! Kvävningrisk. Små delar.  
 Advarsel! Kvelningsfare. Små deler.  
 Atenção! Risco de asfixia. Pequenas partes.  
 Προειδοποίηση! Κίνδυνος πνιγμού. Μικρά μέρη.  
 警告! 小部品があります。誤飲・窒息の危険があります。  
 警告! 小心窒息。当心小物件。  
 경고! 질식 위험. 작은 부품 포함.  
 Внимание! Риск удушения. Мелкие детали.

Ostrzeżenie! Niebezpieczeństwo udławienia się. Małe części.  
 Upozornění! Nebezpečí zalknutí. Malé části.  
 Upozornenie! Nebezpečnosť dusenia. Malé časti.  
 Figyelmeztetés! Fulladásveszély. Kis alkatrészek.  
 Попередження! Ризик задухи. Дрібні деталі.  
 Urožorenje! Orasnost od gušenja. Sitni dijelovi.  
 Upozoreње! Opasnost od gušeња. Mali delovi.  
 Предупређување! Опасност од задушување. Мали делови.  
 Orozorilo! Nevarnost zadušitve zaradi tujka. Majhni deli.  
 Avertisment! Pericol de sufocare internă. Părți mici.  
 Внимание! Опасност от задавяне. Малки части.  
 Brīdinājums! Aizrīšanās risks. Sikas detaļas.  
 Hoiatatus! Lämbumisohot. Väikesed osad.  
 Jspéjimas! Pavojus užspringti. Smulkios detalės.  
 Uyari! Boğulma Tehlikesi (Havasızlıktan). Küçük Parçalar.  
 تحذیر! خطر الاختناق. أجزاء صغيرة.  
 Peringatan! Bahaya tersedak. Bagian kecil.  
 Avaran! Bahaya tercekik. Bahagian kecil.

