

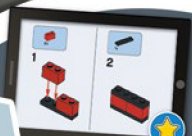

CLASSIC

11009





- 1 Scan the code on the front cover
Scanne den Code auf der Titelseite
Scanne le code sur la page couverture
Scanner le code sur la page couverture
Scansiona il codice sulla copertina
Escanea el código de la portada
Faz scan do código na frente da capa
Olvasd be a borítón látható kódot!
Noskenë kodu uz priekšējā vāka
扫描封面上的二维码

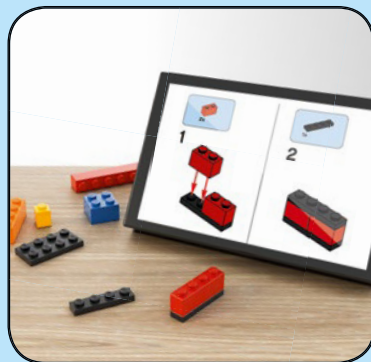

- 2 Get the Building Instructions
Hol dir die Bauanleitung
Hol dir die Bauanleitung
Obtiens les instructions de montage
Obtenir les instructions de montage
Scarica le istruzioni per la costruzione
Consulta las instrucciones de construcción
Obtém as Instruções de Construção
Szerezd be az építési útmutatókat!
Saņem būvēšanas instrukcijas
获取拼搭说明

LEGO.com/apps

Check for compatibility
Kompatibilität prüfen
Vérifier la compatibilité
Controlla la compatibilità
Comprueba tu compatibilidad

Verificar a compatibilidade
Ellenőrizd a kompatibilitást
Pārbaudīt saderību
检查兼容性

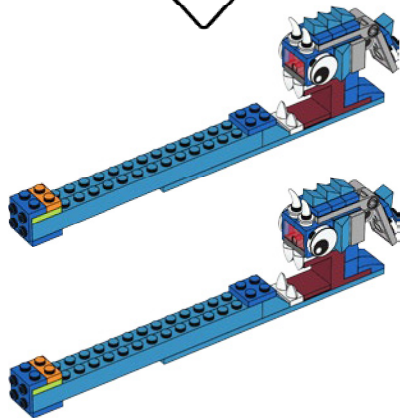
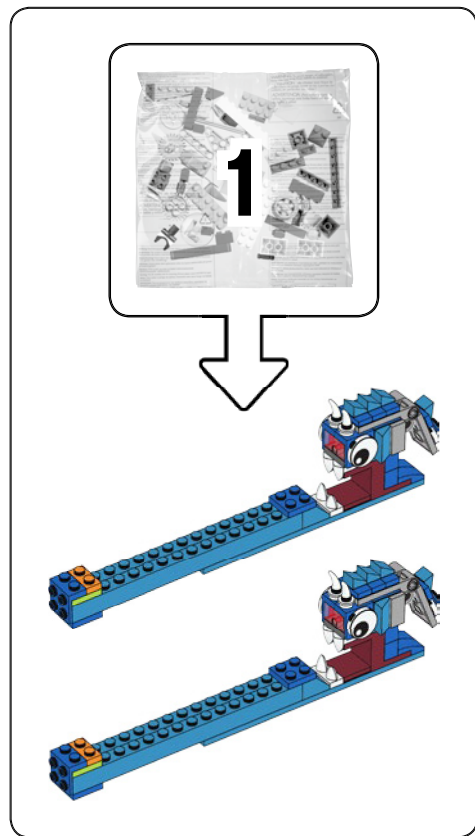



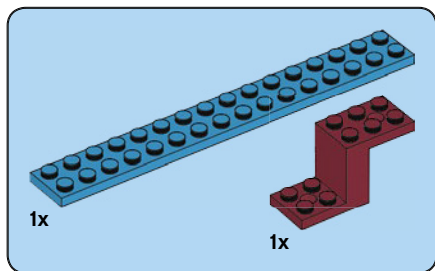

1

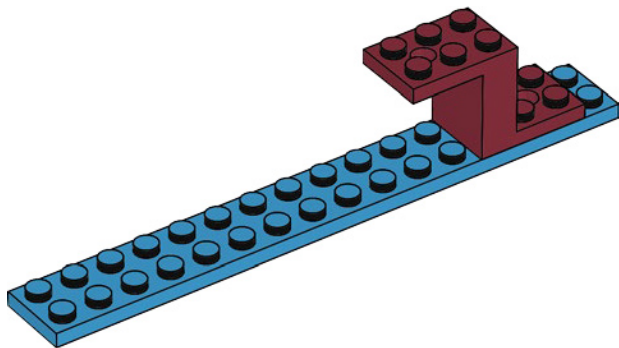



2x

2

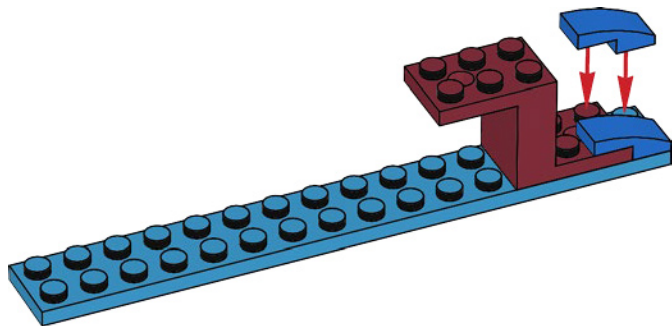

6



1x

3

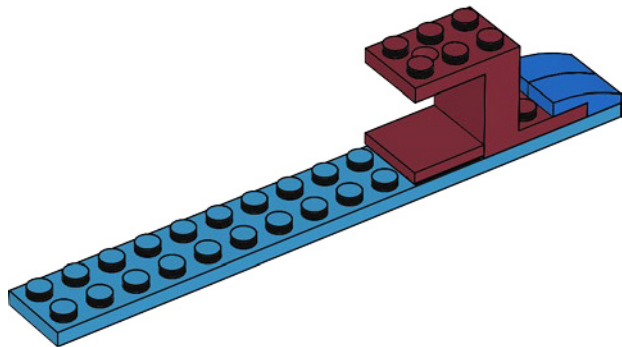

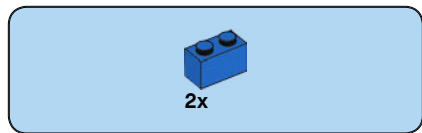

4

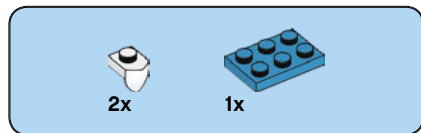
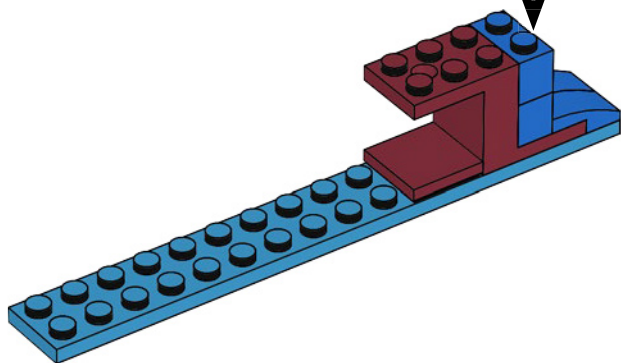
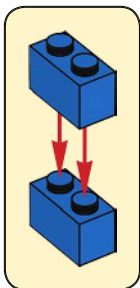

5

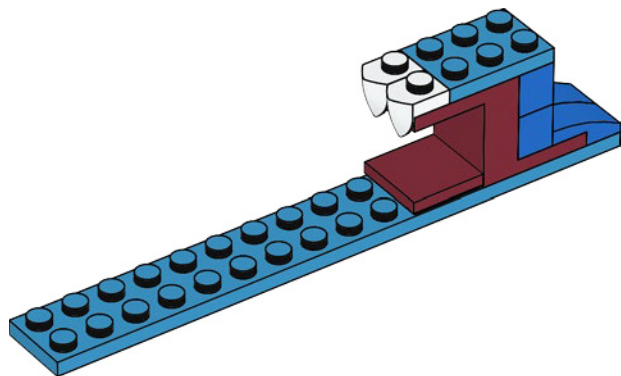

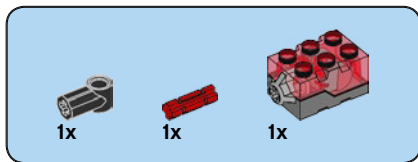

6

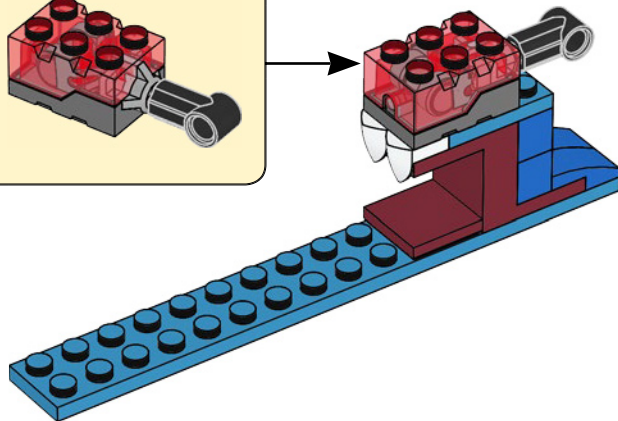
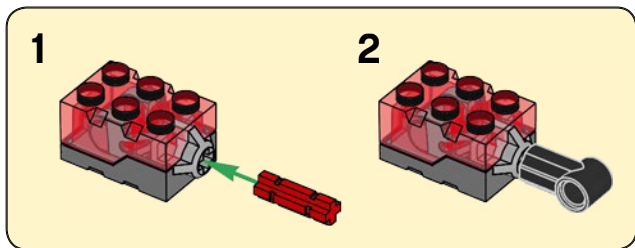
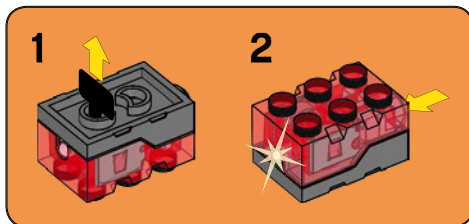



4x

7

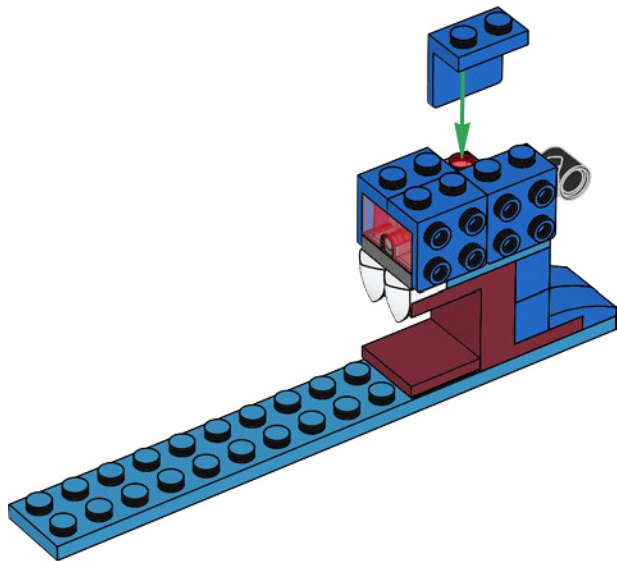

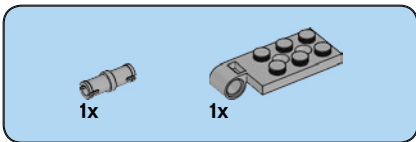
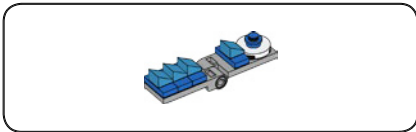

8

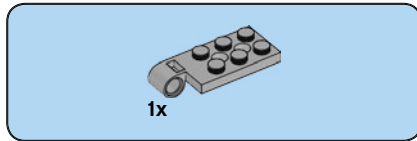
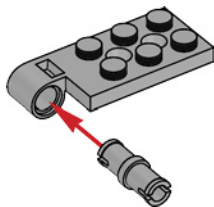

9

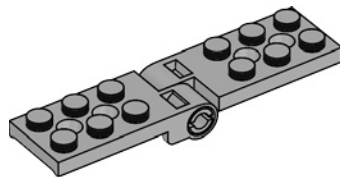



4x



1x

10

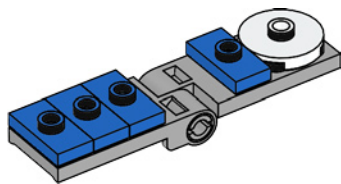

1x



4x

11

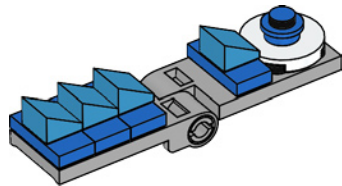

12

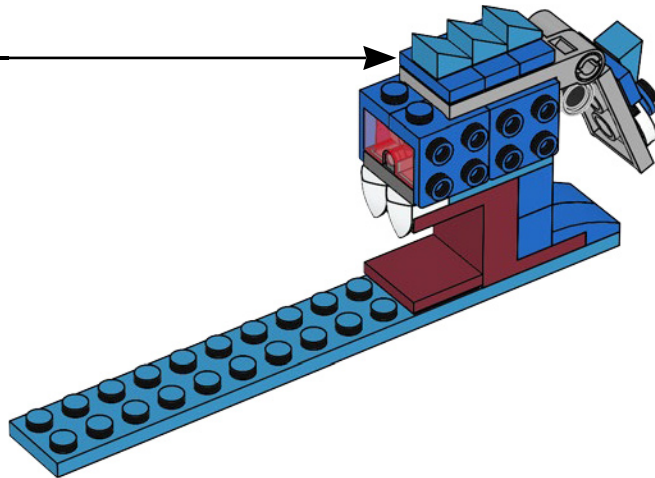



13

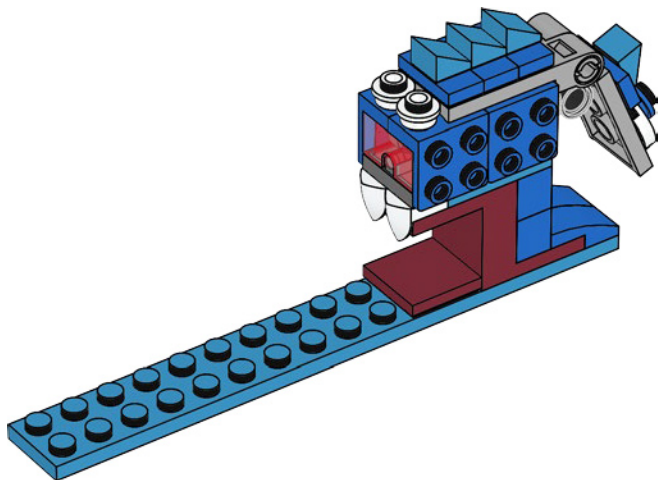

14



2x

14

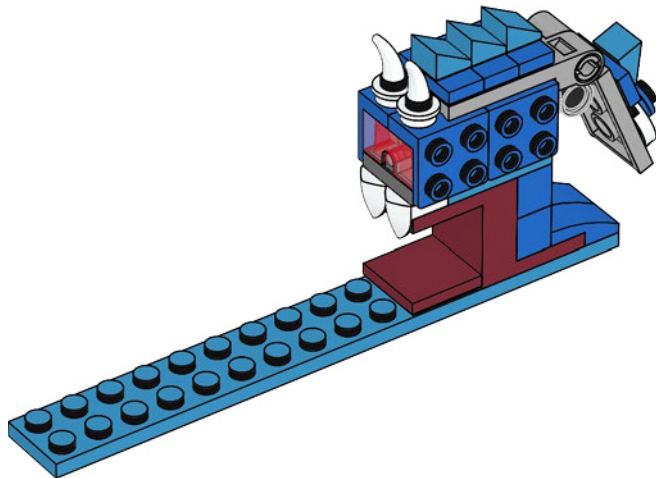



1x



1x



1x

15

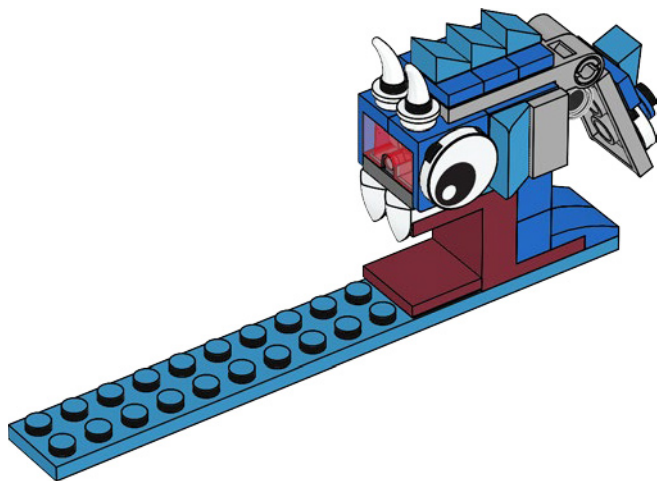

16

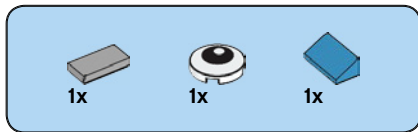

16

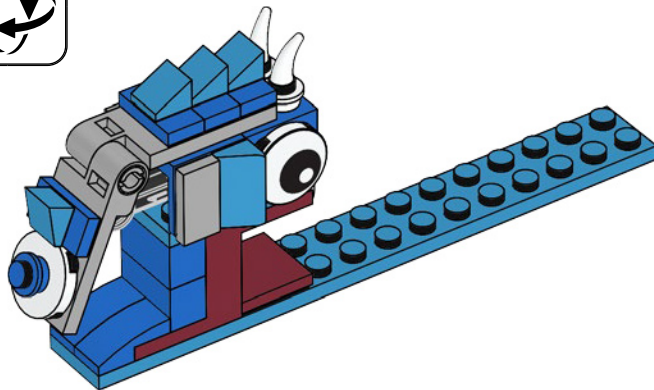



1x

17

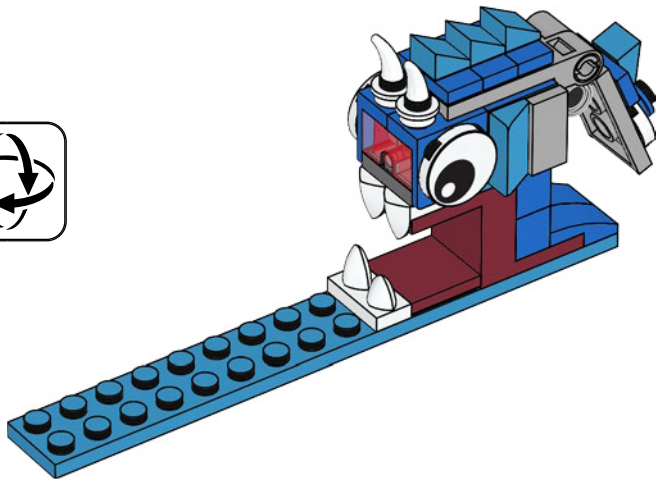

18



2x

18

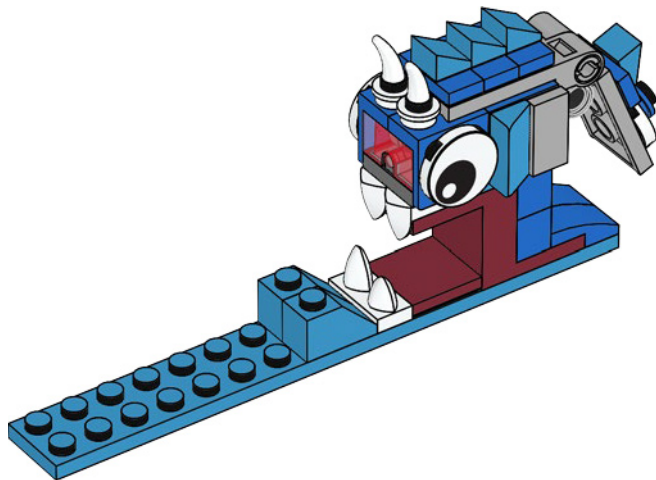

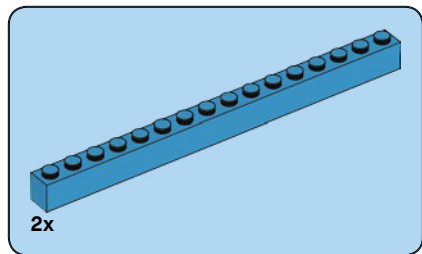

19

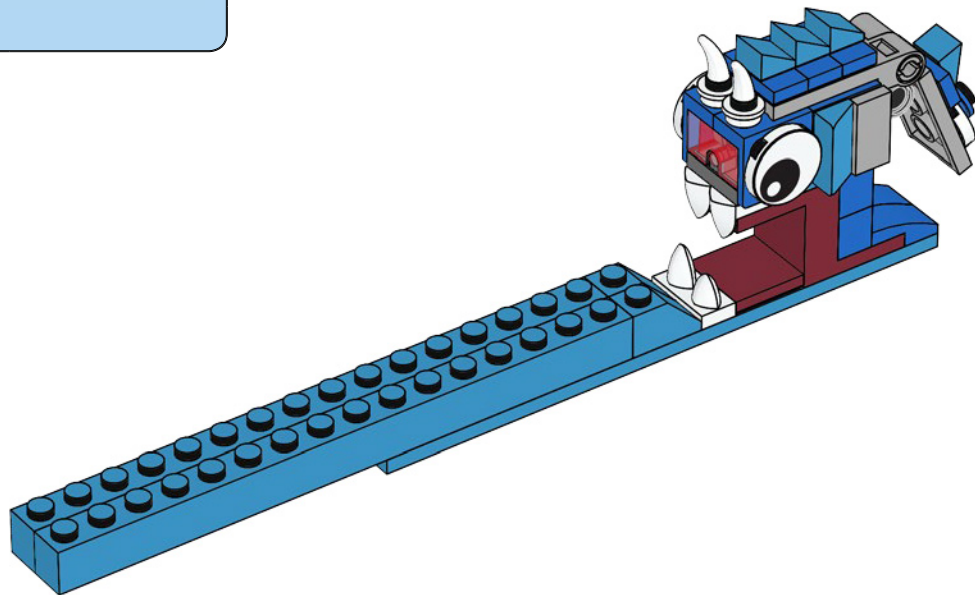

20



1x

20

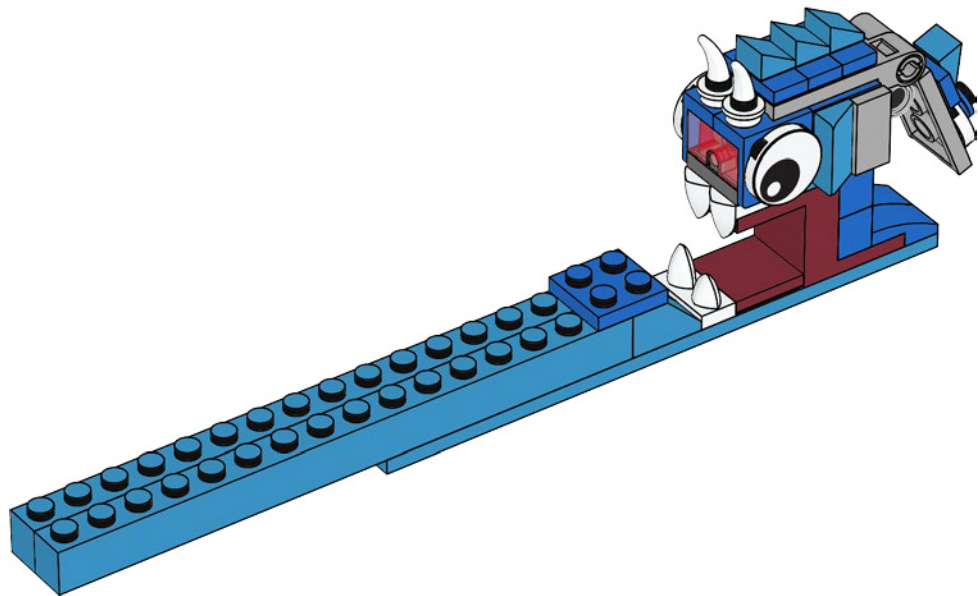



1x



1x

21

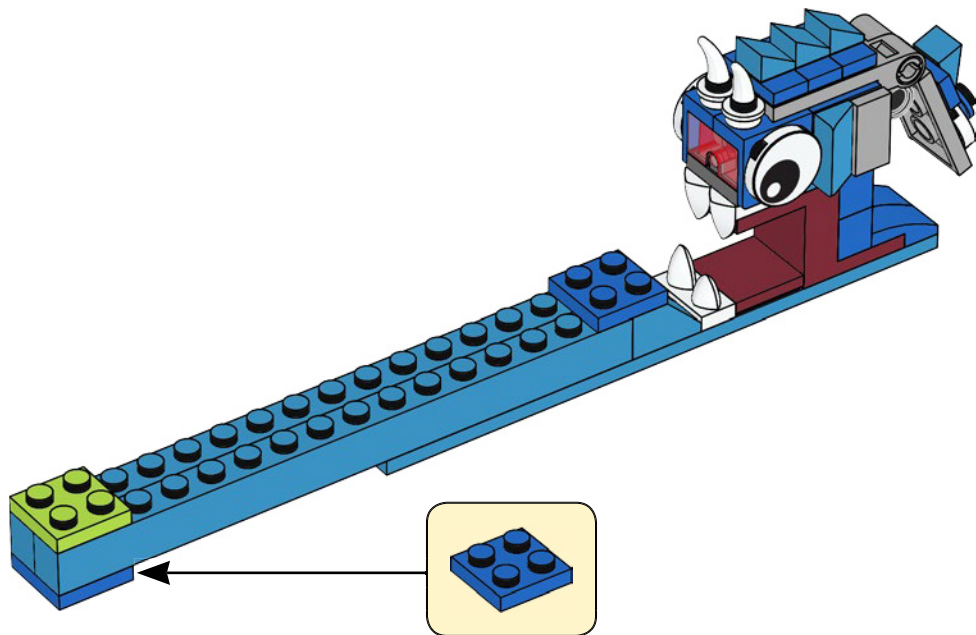

22



2x

23

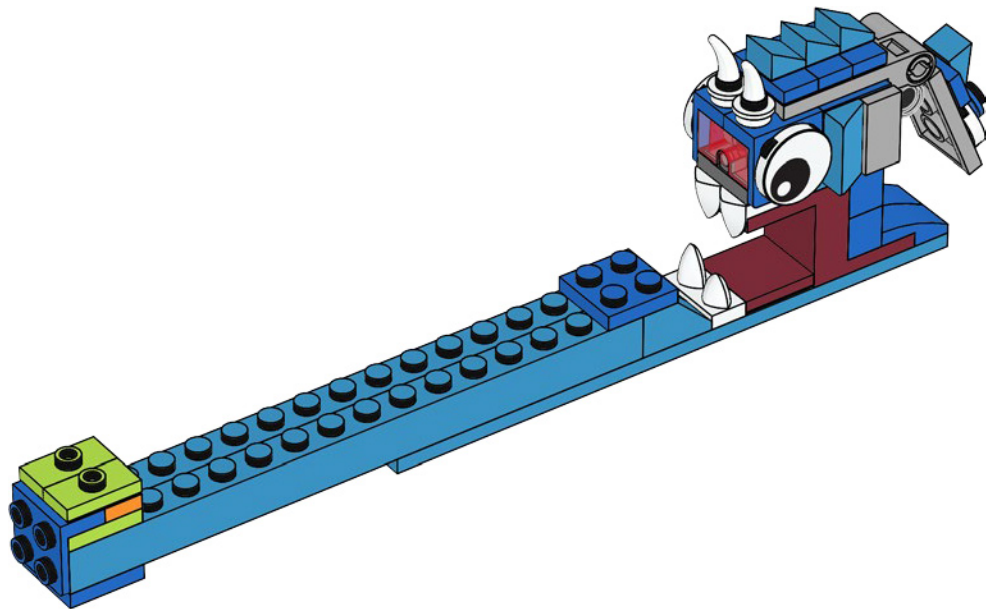

2x

24



CLASSIC

11009





Page
05



Page
08



Page
12



Page
16



Page
22



Page
28



Page
34

Page
Seite
Pagina
Página
Oldalszám
Lpp.
页码



Page
40



Page
48



Page
54



Page
62



Page
70



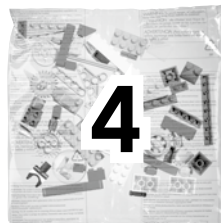
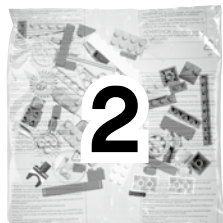

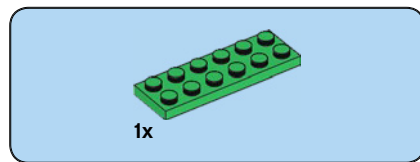
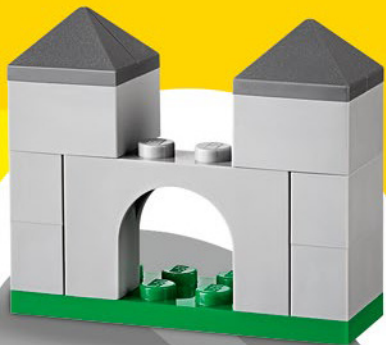

1

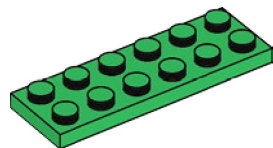

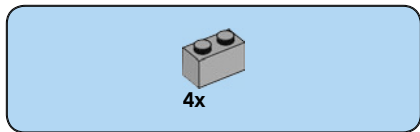

2

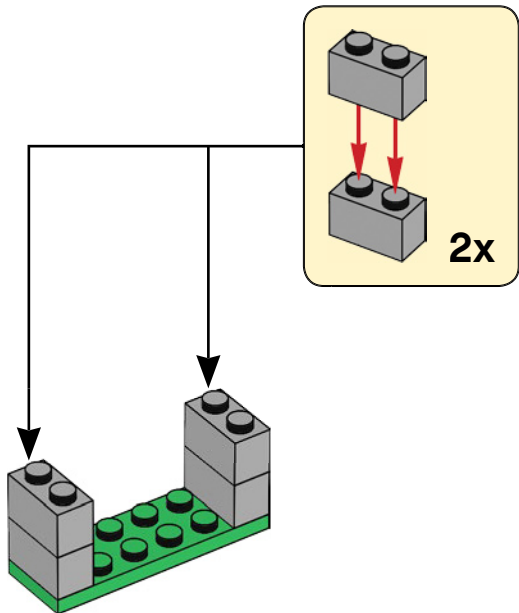

6

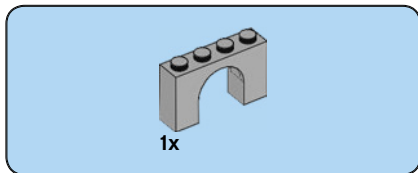

3

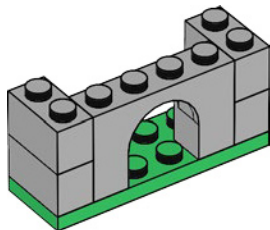

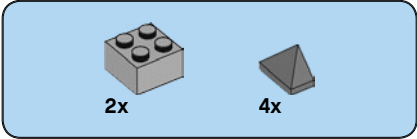

4

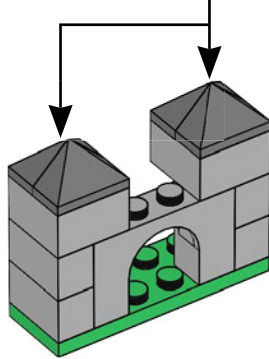
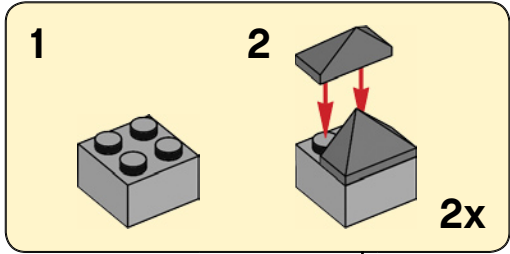



1

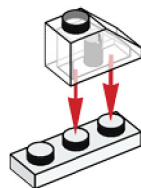



1x

2

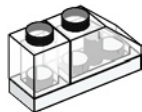

1x

3





2x

4

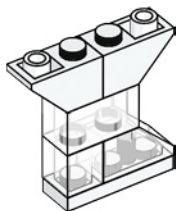

1x

5

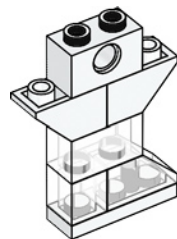



2x

6

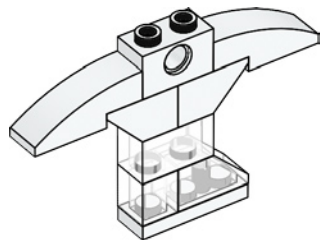

1x



1x

7

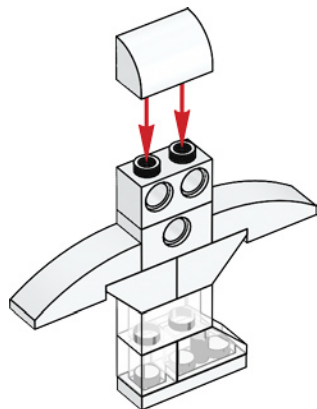

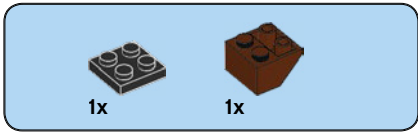

1

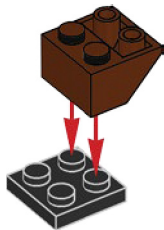



2x

2



1x

3





4

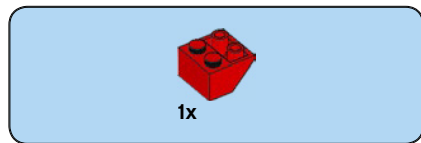
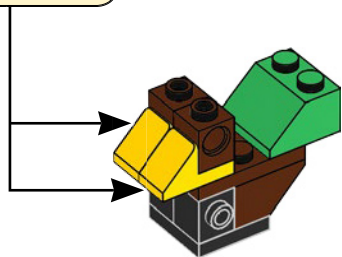
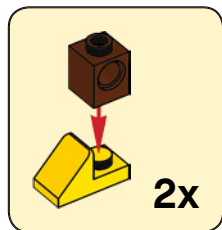

5

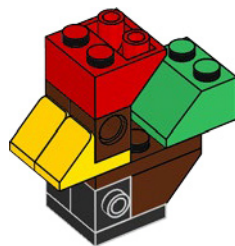



2x

6

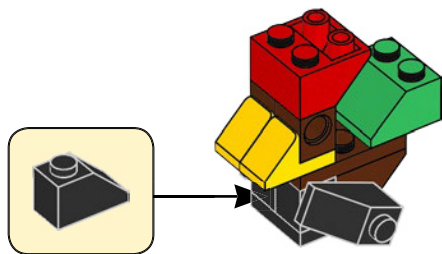

1x

7

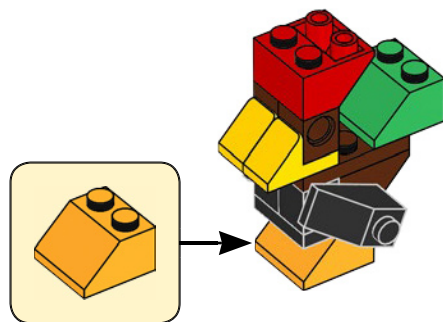

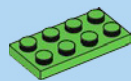

1x

1

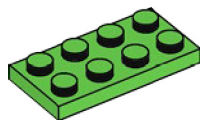



2x

2

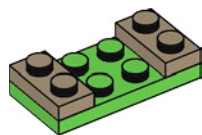

2x

3

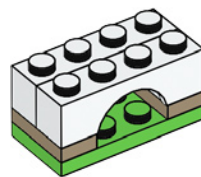

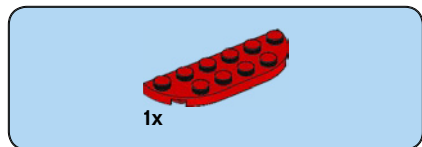

4

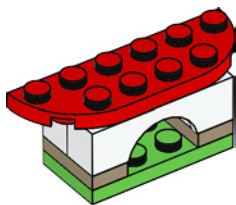

5

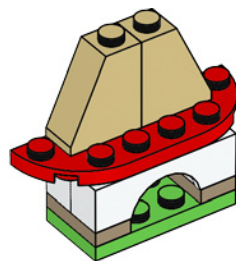



1x

6

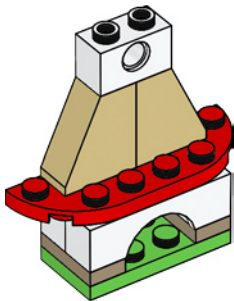

1x

7

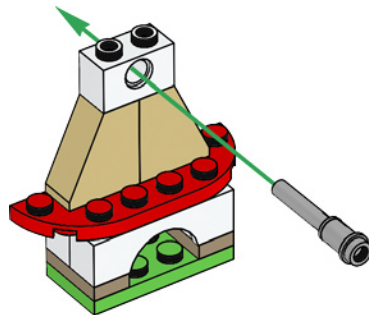



2x

8

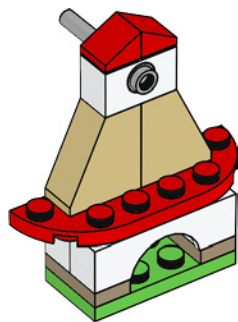



9

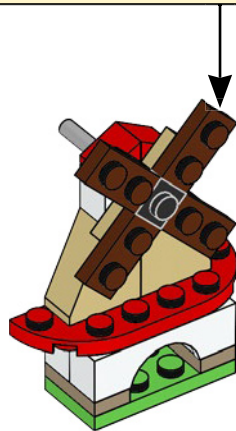
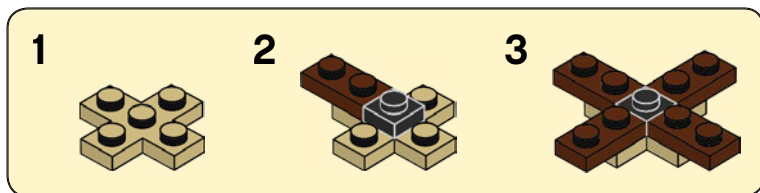

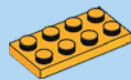

1x

1

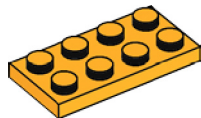



2x

2

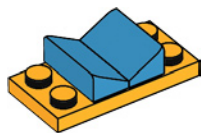

2x

3

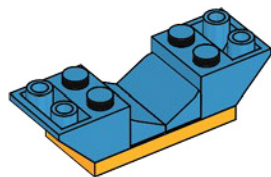

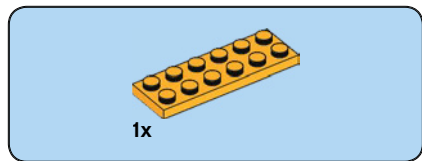

4

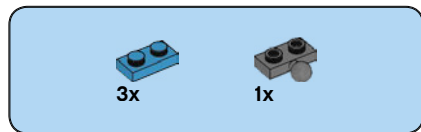
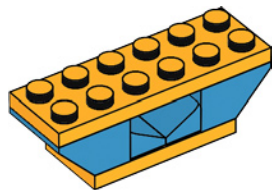

5

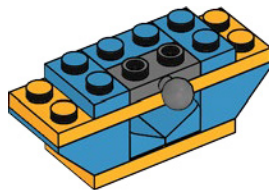

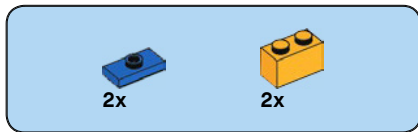

6

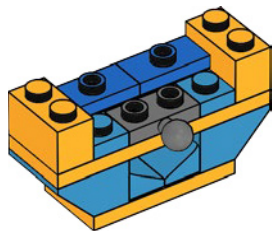

7

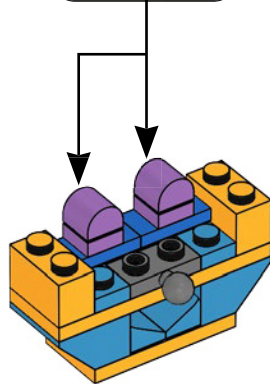
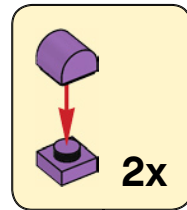



2x

8

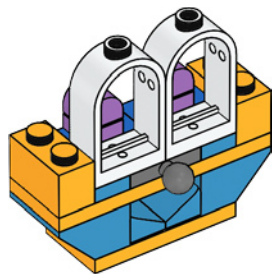

26



2x

9

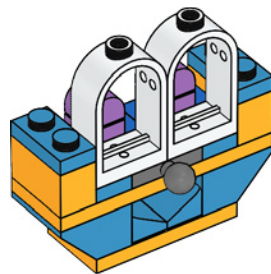



2x

10

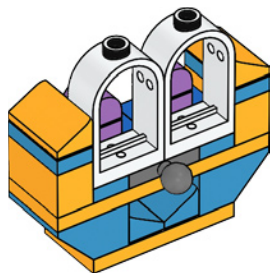

2x

11

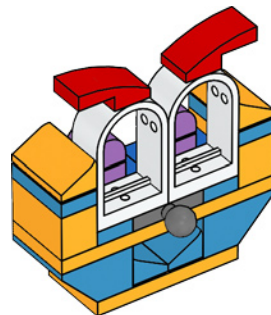

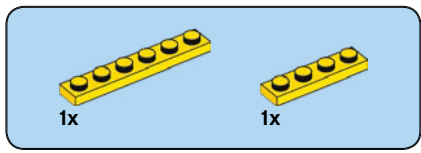

1

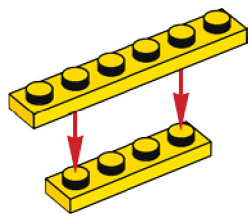

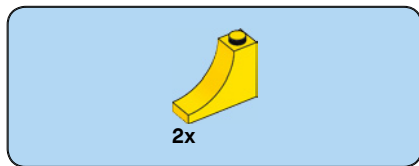

2

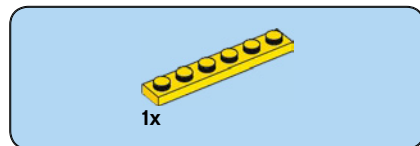
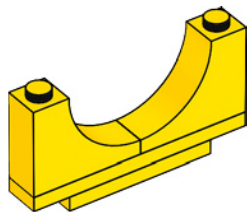

3

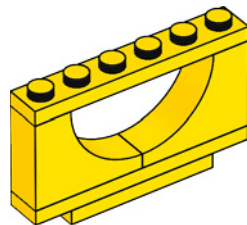



2x

4

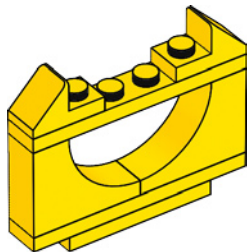

30



1x

5

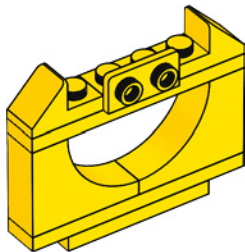



1x

6

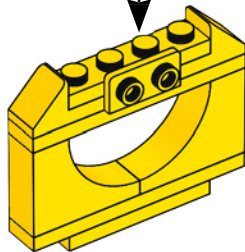
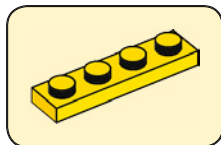

2x

7

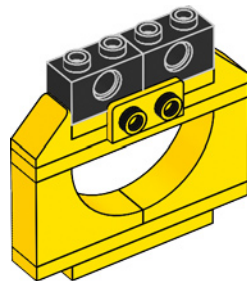



1x



1x

8

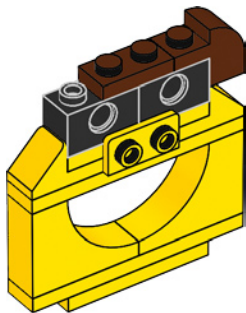

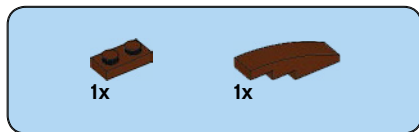

9

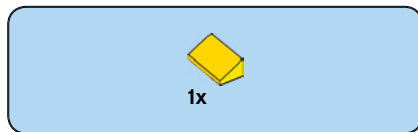
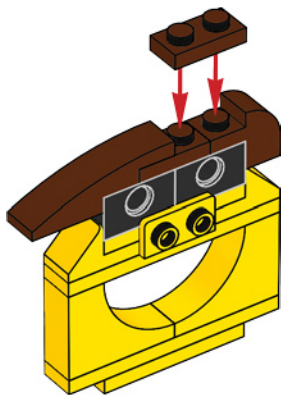

10

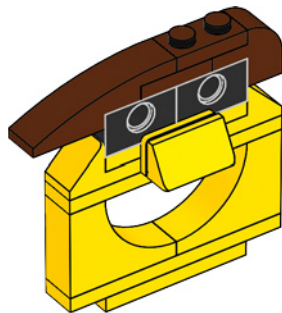



1x

1

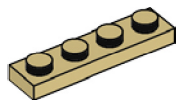



2

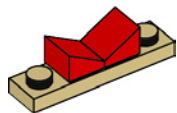

3

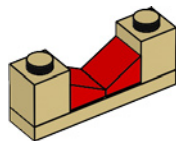

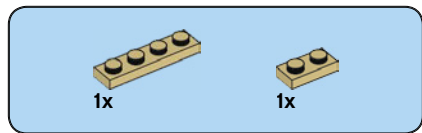

4

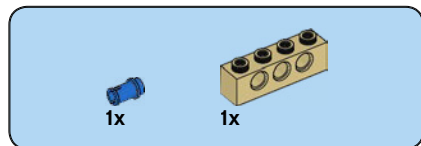
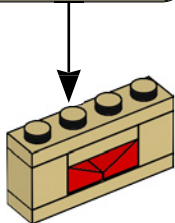
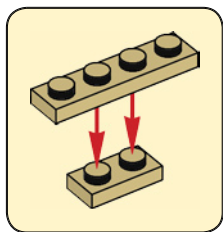

5

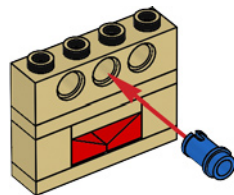



1x



2x

6

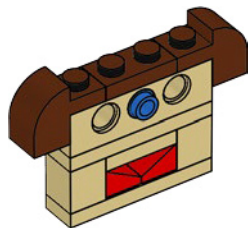

1x

7

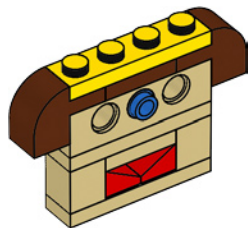



1x



2x

8

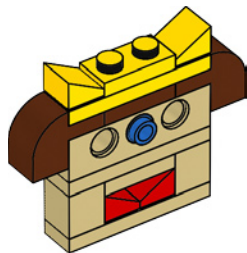

1x



1x

9

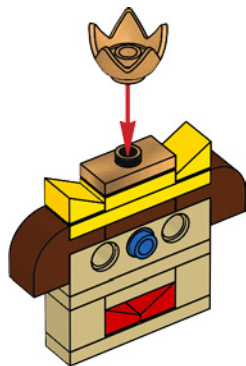



2x



2x

10

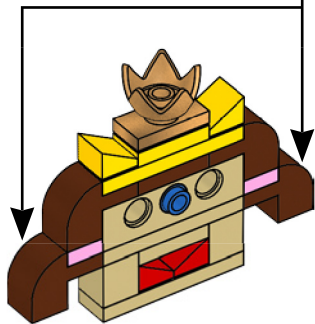
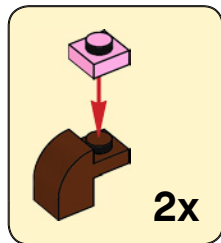

1x



1x

11

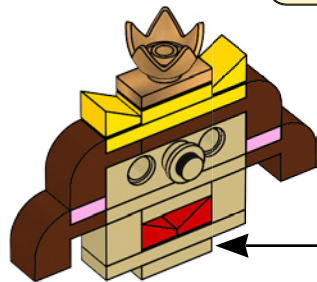
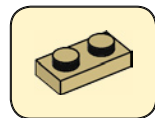

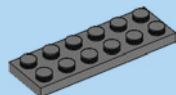

1x

1

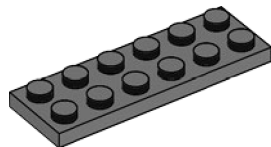



2x

2

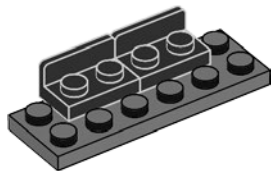

2x

3

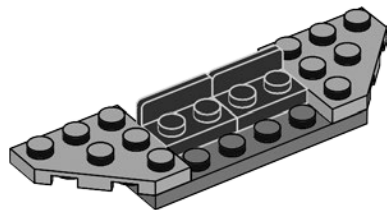



1x

4

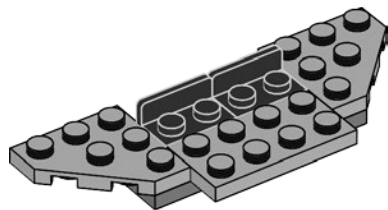

42



2x



1x

5

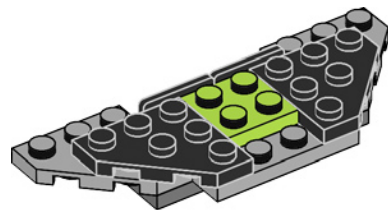



2x

6

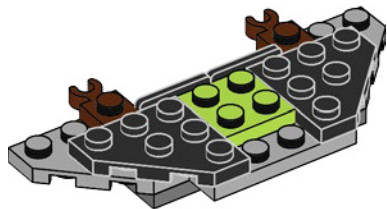

2x

7

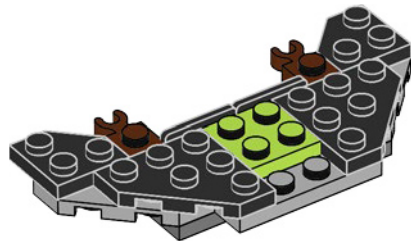



1x

8

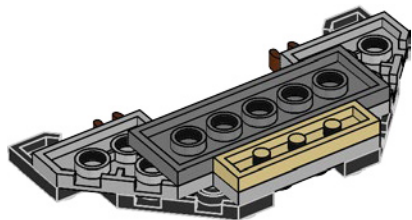
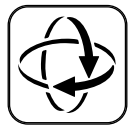

44



2x

9

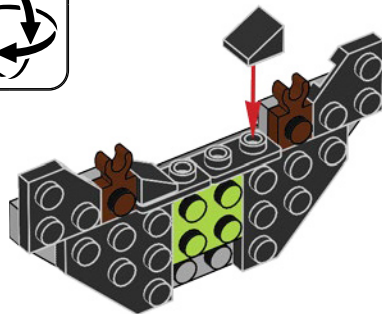



10

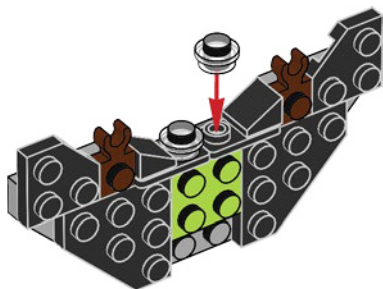

11

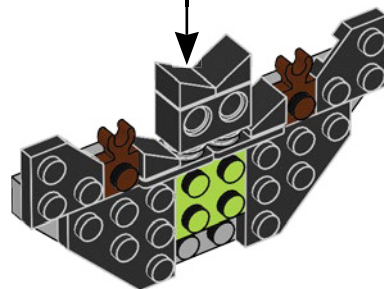
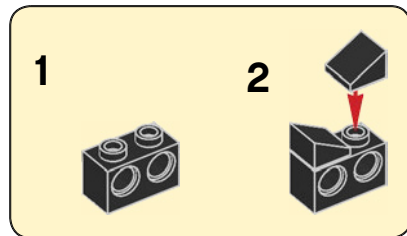



2x

12

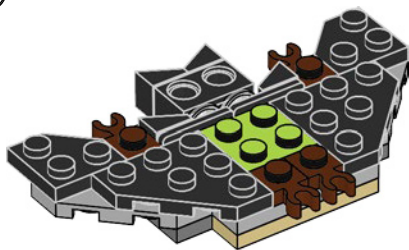



2x

13

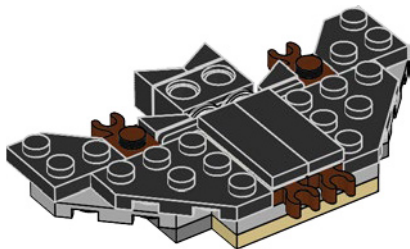

1x

14

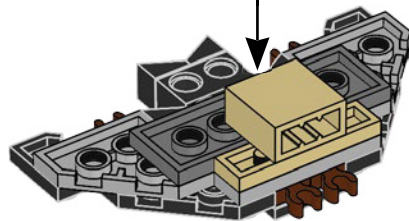
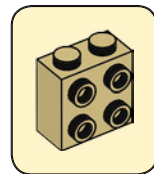

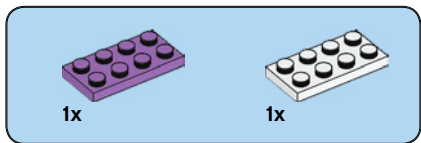

1

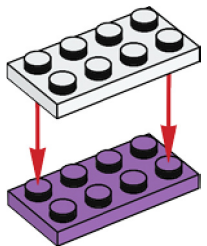



2x



2x

2

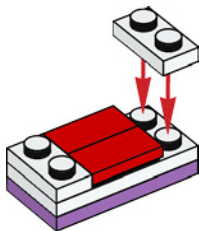

2x



2x

3

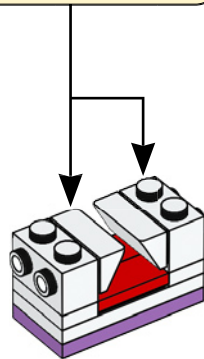
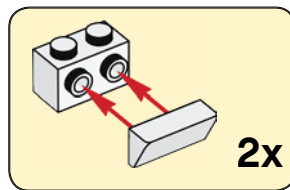



1x

4

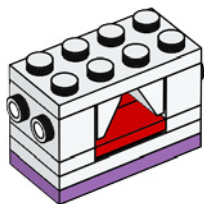



1x



1x

5

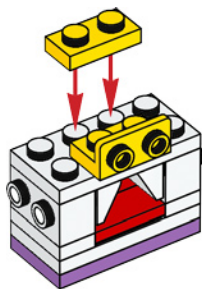

2x

6

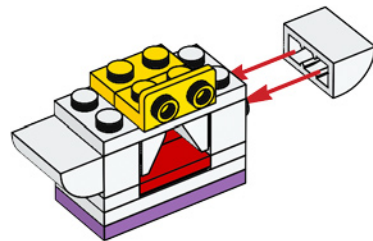

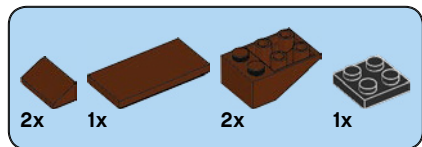

7

1



2

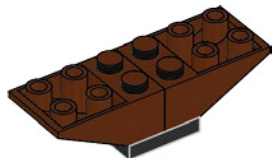

3

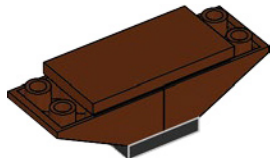

4



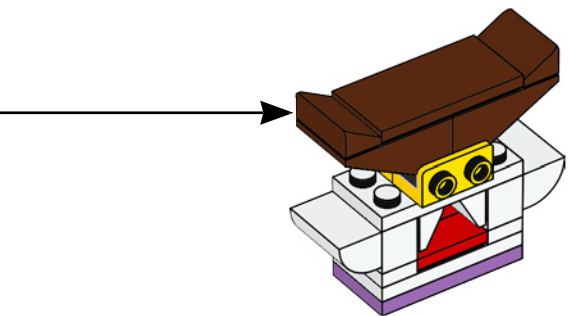

8

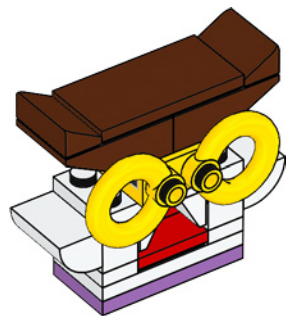

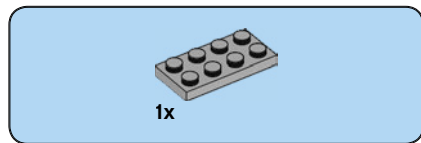

1





2x

2

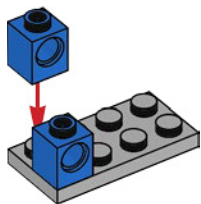

1x

3

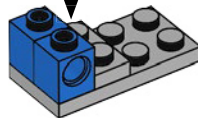
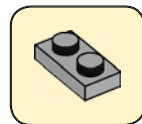



4

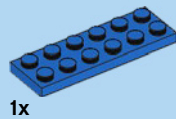
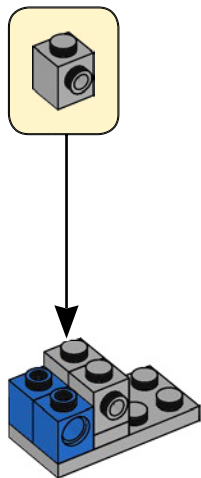

5

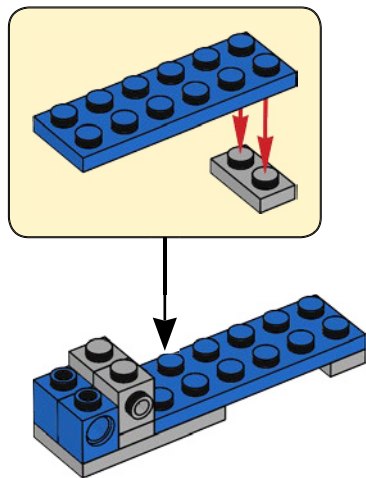

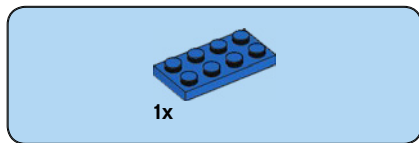

6

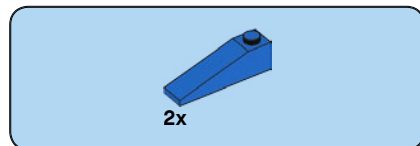
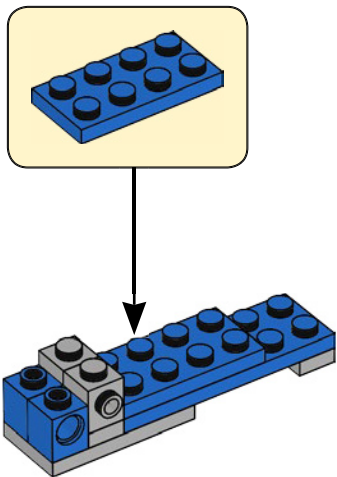

7

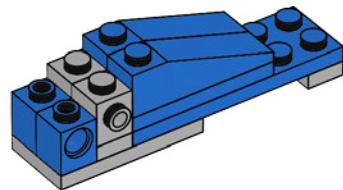



1x

8

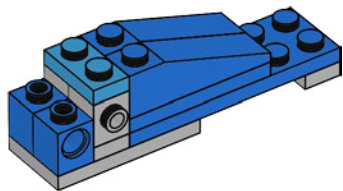

58



2x

9

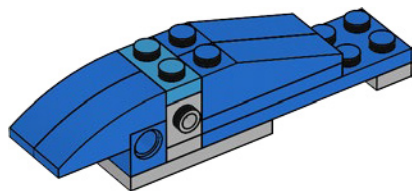



2x

10

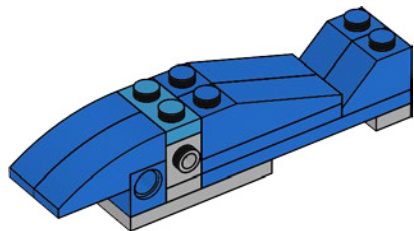

3x

11

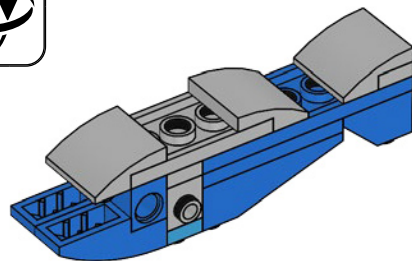



1x

12

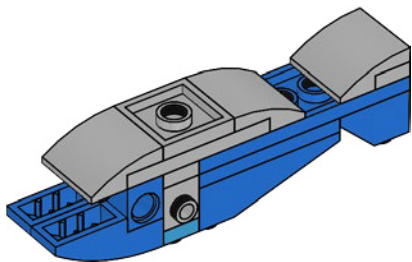



2x

13

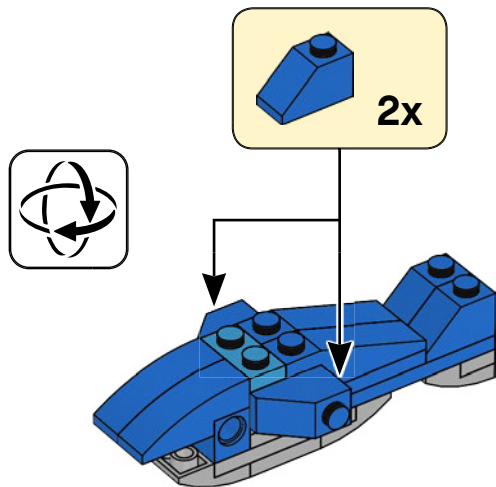

2x

14

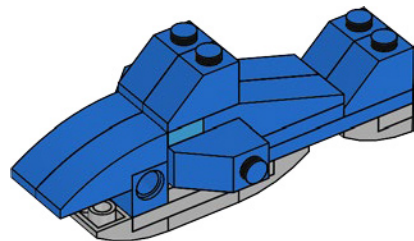

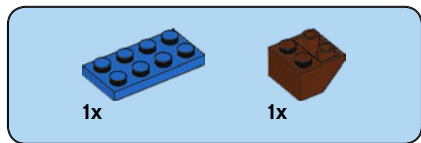

1

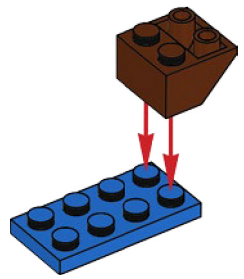

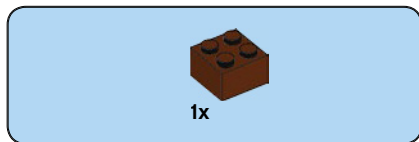

2

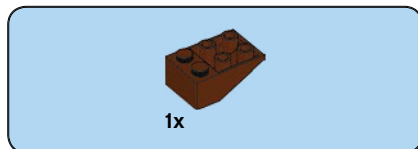
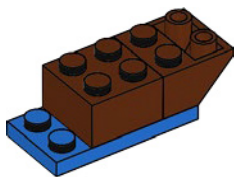

3

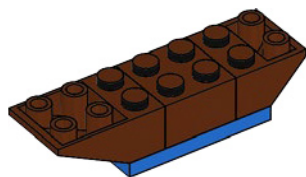

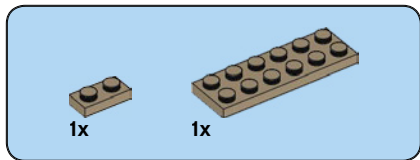

4

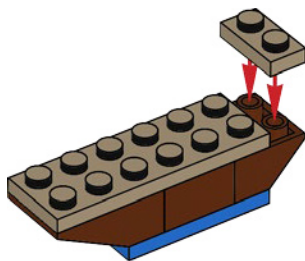



1x



2x

5

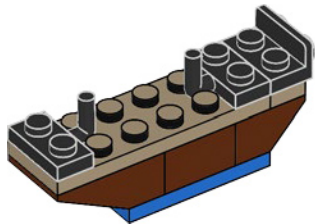

2x

6

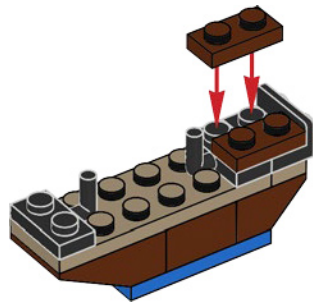



1x



1x

7

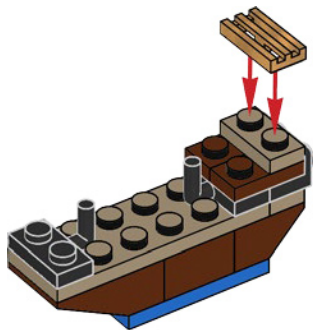



8

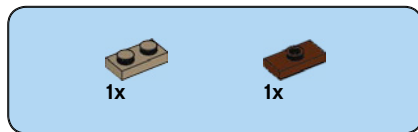
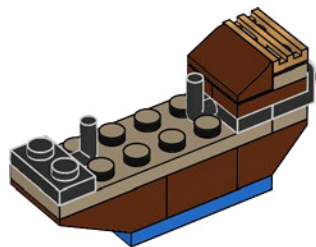

9

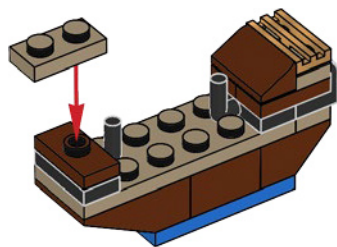

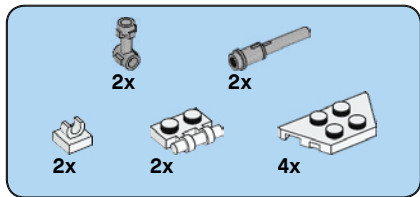
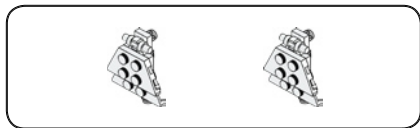

10

1

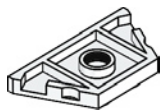

2

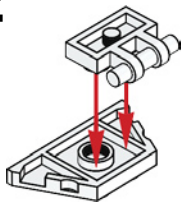

3

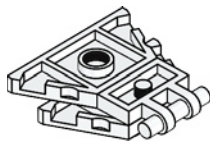

4

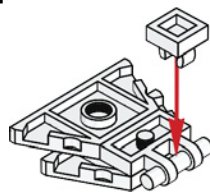

5

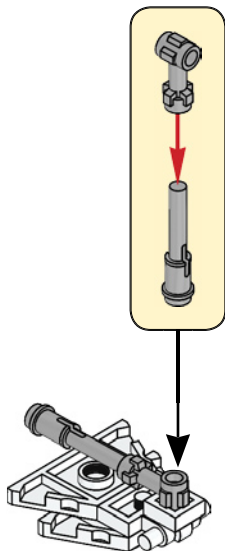

6

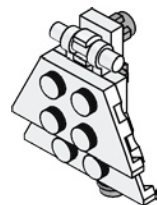

2x

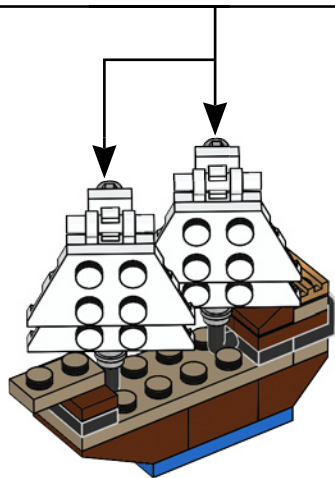

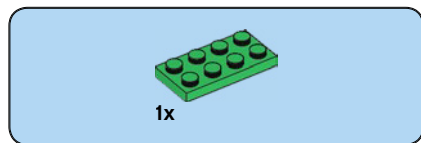

1

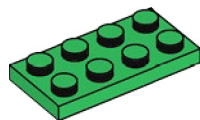

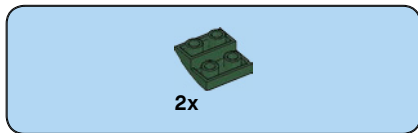

2

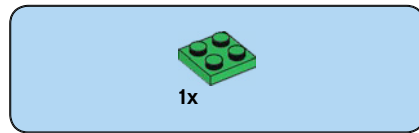
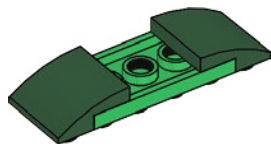

3

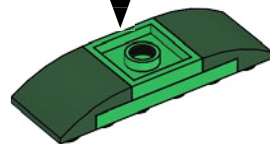
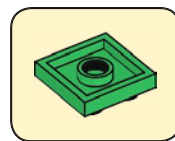

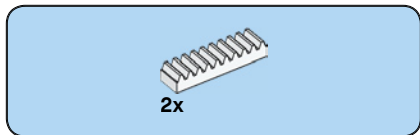

4

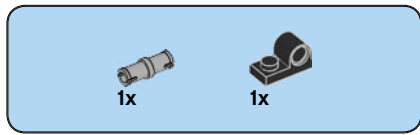
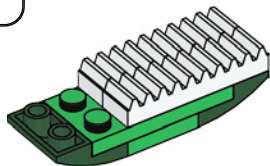

5

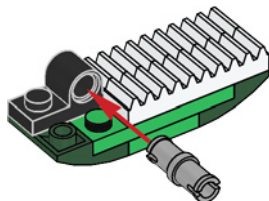

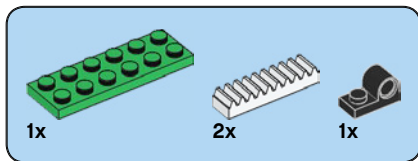

6

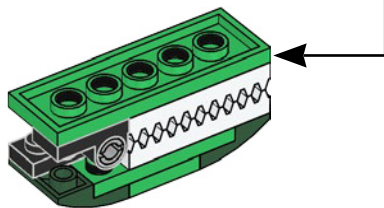
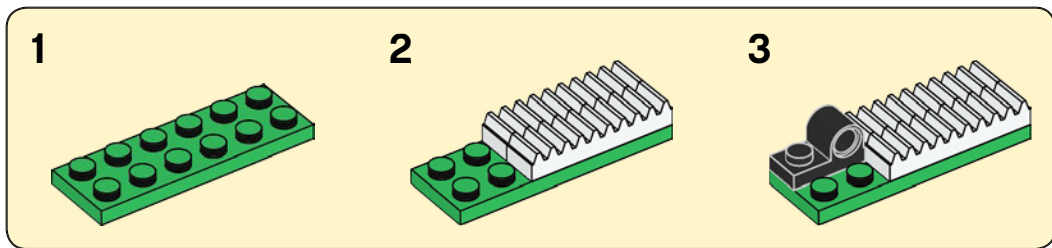



1x

7

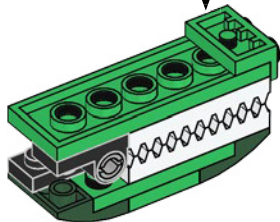
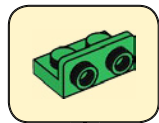

1x

8

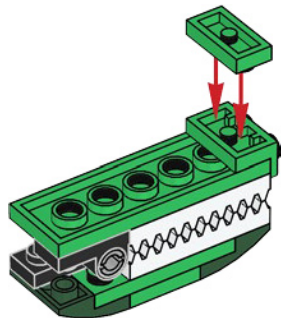



1x

9

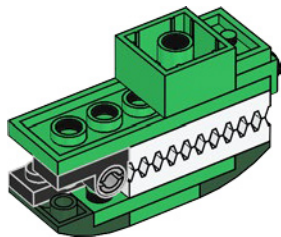

2x

10

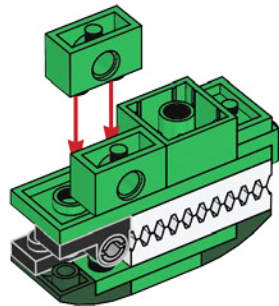



1x



1x

11

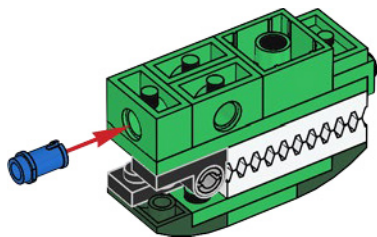

76



1x

12

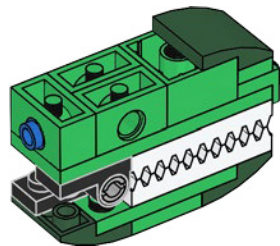



1x



1x

13

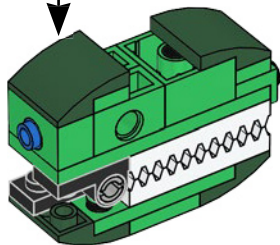
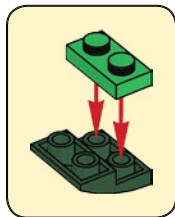

2x

14



2x

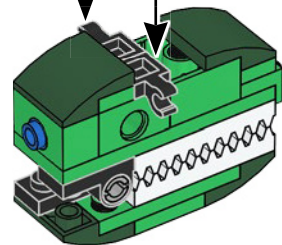

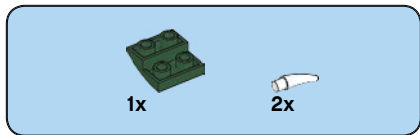

15

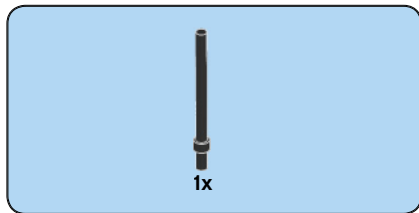
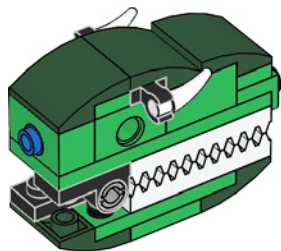

16

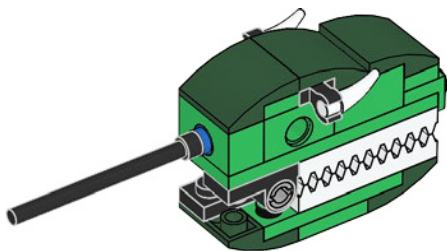



- 1** Scan the code on the front cover
Scanne den Code auf der Titelseite
Scanne le code sur la page couverture
Scanner le code sur la page couverture
Scansiona il codice sulla copertina
Escanea el código de la portada
Faz scan do código na frente da capa
Olvasd be a borítón látható kódot!
Noskenë kodu uz priekšējā vāka
扫描封面上的二维码

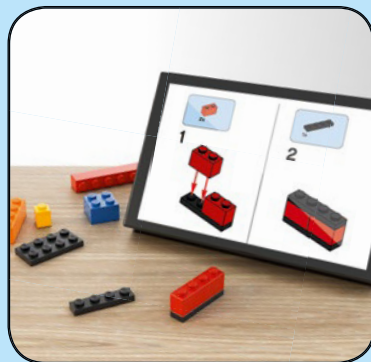

- 2** Get the Building Instructions
Hol dir die Bauanleitung
Hol dir die Bauanleitung
Obtiens les instructions de montage
Obtenir les instructions de montage
Scarica le istruzioni per la costruzione
Consulta las instrucciones de construcción
Obtém as Instruções de Construção
Szerezd be az építési útmutatókat!
Saņem būvēšanas instrukcijas
获取拼搭说明

LEGO.com/apps

Check for compatibility
Kompatibilität prüfen
Vérifier la compatibilité
Controlla la compatibilità
Comprueba tu compatibilidad

Verificar a compatibilidade
Ellenőrizd a kompatibilitást
Pārbaudīt saderību
检查兼容性



What shadows can you build?
Was für Schatten werfen deine Modelle?
Quelles ombres vas-tu créer ?
Quali ombre riuscirai a costruire?
¿Qué sombras puedes construir?
Que sombras consigues construir?
Milyen árnyékokat tudsz építeni?
Kādas ēnas tu vari uzbūvēt?
你可以拼搭出哪些皮影呢？



What shadows
can you build?



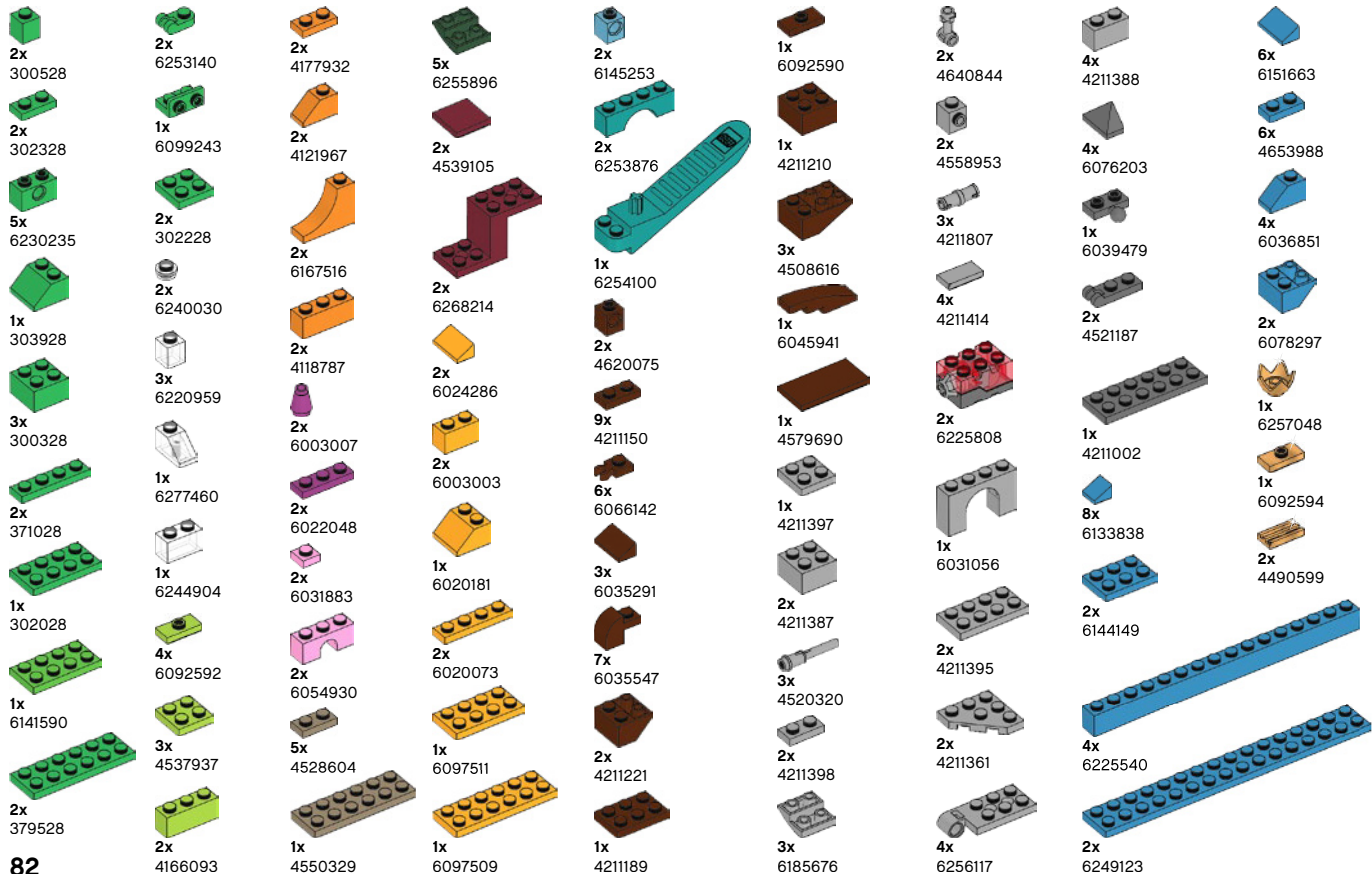

 4x 4504381	 2x 614123	 2x 4583862	 2x 4558886	 1x 4161734	 6x 6168642	 3x 6046384	 2x 6114987	 1x 6170421	 4x 4517925
 1x 4550348	 2x 4143005	 10x 6092582	 4x 4504379	 2x 4113915	 2x 302401	 2x 6057414	 2x 4121966		 2x 4619521
 4x 6069170	 2x 4119014	 6x 6055065	 2x 4142865	 2x 4516055	 4x 6046905	 4x 370001	 3x 6020193	 2x 6284699	 4x 6261546
 2x 302324	 6x 4121936	 6x 300423	 2x 306921	 2x 4179771	 6x 6270106	 2x 302301	 4x 302226	 2x 4558954	 2x 4623598
 2x 6057458	 10x 6117968	 2x 6029946	 2x 302321	 2x 4113917	 2x 4547489	 3x 6248827	 2x 4558170	 2x 370026	 1x 4619516
 2x 4527354	 4x 302223	 2x 300421	 2x 4626200	 2x 6054551	 2x 4667575	 2x 4140583	 2x 6174243	 1x 3200026	 1x 4655173
 2x 362324	 2x 4543998	 2x 4597713	 2x 6214334	 2x 4249112	 4x 6060734	 1x 362301	 2x 4227684		
 2x 6297316	 2x 6297327	 1x 366021	 1x 6061575	 2x 365901	 2x 6093053	 4x 4504382			
 3x 371024	 4x 302023	 2x 301021	 3x 4113233	 4x 4250465	 1x 3200001	 2x 302426			
 2x 366624	 1x 379523	 1x 6108802	 1x 4234365	 2x 302001	 2x 4247139				



Customer Service

Kundenservice

Service Consommateurs

Servicio Al Consumidor

LEGO.com/service or dial



: 00800 5346 5555

: 1-800-422-5346

WIN

GO TO WWW.LEGO.COM/PRODUCTFEEDBACK AND
GIVE US YOUR SHORT **FEEDBACK** ABOUT THIS
LEGO® SET FOR A CHANCE TO WIN
A COOL LEGO PRIZE.

Terms & Conditions apply

LEGO.com/productfeedback



GEWINNE

Erzähle uns auf
www.LEGO.com/productfeedback

etwas über die Erfahrungen, die du mit
diesem LEGO® Set gemacht hast, und
sichere dir die Chance auf einen coolen
LEGO Preis!

Es gelten die Teilnahmebedingungen

GAGNE

Rends-toi sur
www.LEGO.com/productfeedback

et donne-nous quelques commentaires sur
ce produit LEGO® pour avoir une chance
de gagner un prix LEGO !

Voir Conditions Générales

GANAN

Visita
www.LEGO.com/productfeedback

y envíanos tu opinión acerca de este set
LEGO®. ¡Participarás en el sorteo de un
premio LEGO!

Términos y Condiciones aplicables

获取奖品

登录
www.LEGO.com/productfeedback

给出关于此乐高®套装的简短反馈，
就有机会获得炫酷乐高奖品

《条款及条件》适用

LEGO and the LEGO logo are trademarks of the LEGO Group. ©2020 The LEGO Group.

6314490