

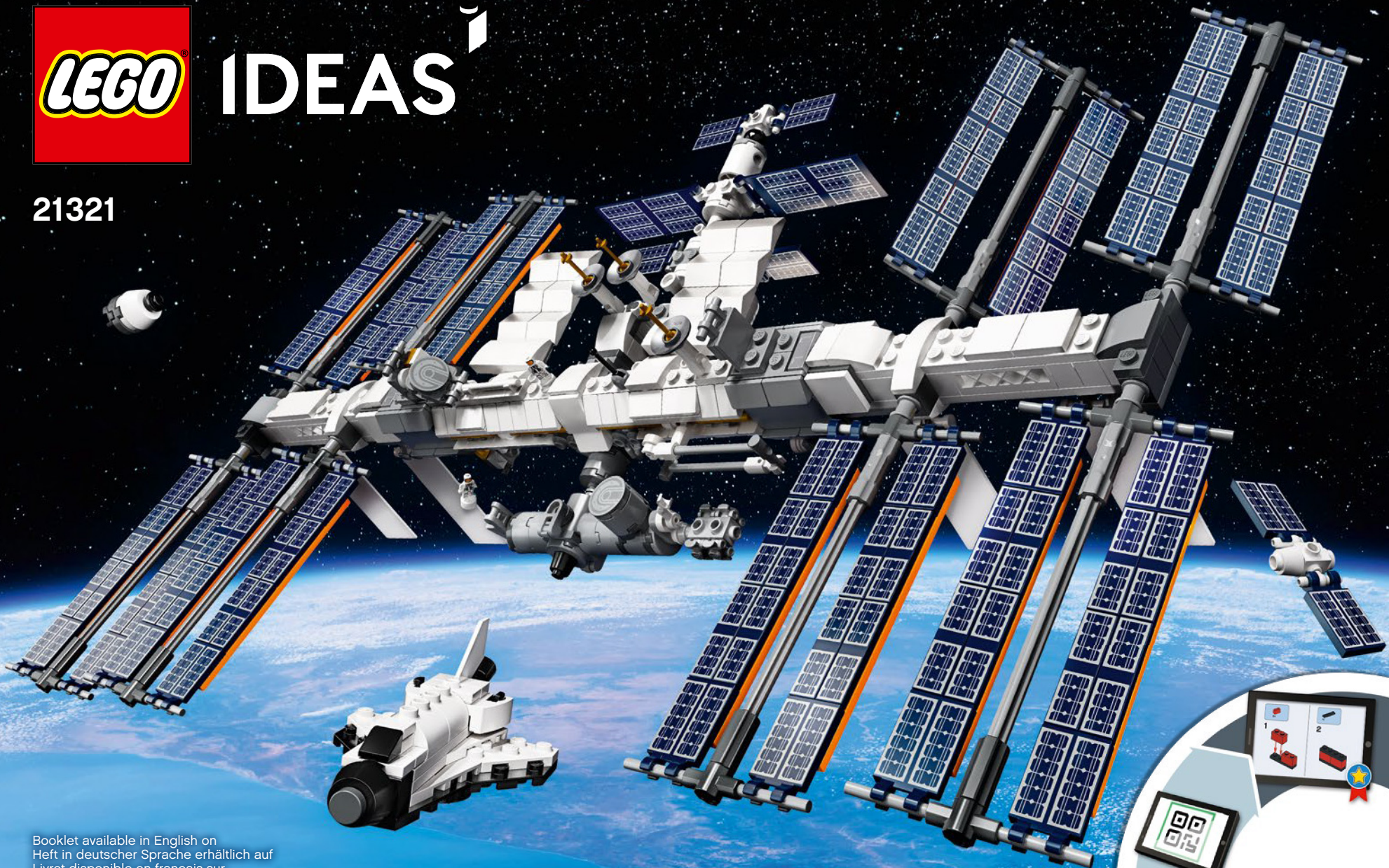

IDEAS

21321



Booklet available in English on
Heft in deutscher Sprache erhältlich auf
Livret disponible en français sur
Libretto disponibile in italiano su
Folleto disponible en español en
如需中文版手册，请访问

LEGO.com/service/buildinginstructions



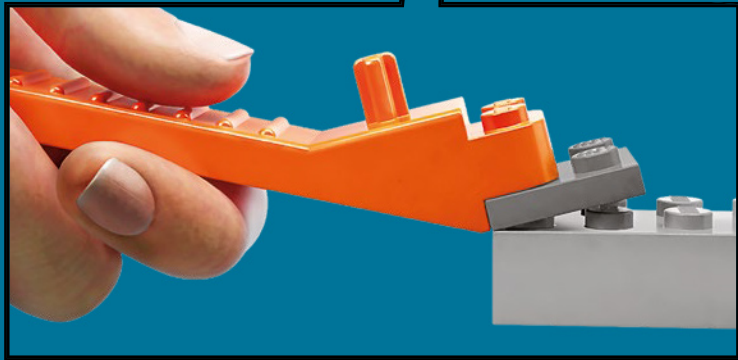
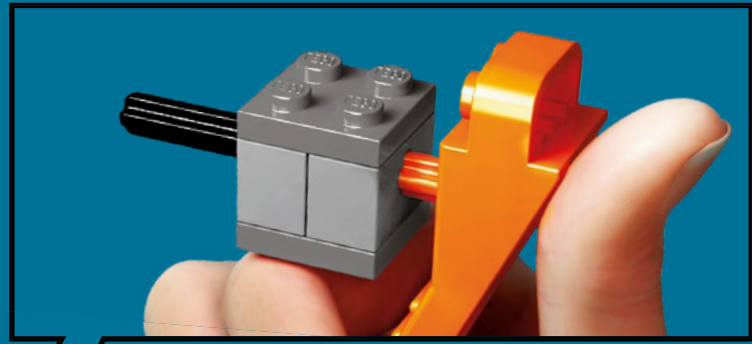
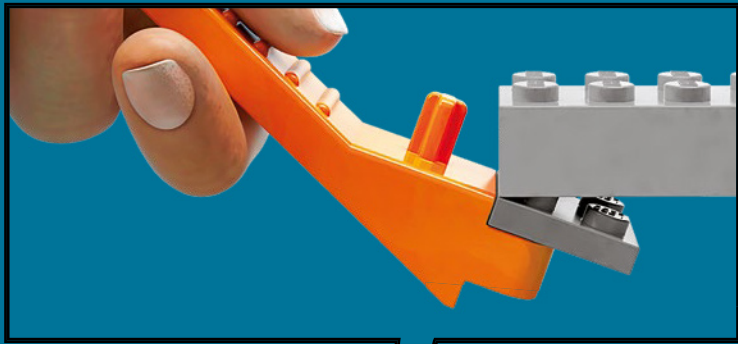

LEGO.com/brickseparator



- 1 Scan the code on the front cover
 Scanne den Code auf der Titelseite
 Scanner le code sur la page couverture
 Scansiona il codice sulla copertina
 Escanea el código de la portada
 Faz scan do código na frente da capa
 Olvasd be a borítón látható kódot!
 Noskenē kodu uz priekšējā vāka
 扫描封面上的二维码



- 2 Get the Building Instructions
 Hol dir die Bauanleitung
 Obténir les instructions de montage
 Scarica le istruzioni per la costruzione
 Consulta las instrucciones de construcción
 Obtém as Instruções de Construção
 Szerezd be az építési útmutatókat!
 Saņem būvēšanas instrukcijas
 获取拼搭说明

[LEGO.com/apps](https://www.lego.com/apps)

Check for compatibility
 Kompatibilität prüfen
 Vérifier la compatibilité
 Controlla la compatibilità
 Comprueba tu compatibilidad

Verificar a compatibilidade
 Ellenőrizd a kompatibilitást
 Pārbaudīt saderību
 检查兼容性



Many nations. Shared intentions.



It is truly astounding to think that nearly 16 times a day, the International Space Station orbits Earth on a continuous path of discovery. The space station is a truly international collaboration between five space agencies: NASA (United States), Roscosmos (Russia), JAXA (Japan), ESA (Europe), and CSA (Canada). Utilizing their technological strengths, the participating countries work together under the umbrella of the International Space Station program to achieve common goals that benefit all humankind.

Benefits

The 15 nations involved provide global leadership to advance human exploration, enable scientific research that benefits humanity, and establish a robust low-Earth orbit economy. In parallel to achieving these goals, the partnership also utilizes the space station's unique platform to provide science, technology, engineering, and mathematics (STEM) resources to educate the next generation of leaders and space explorers.



Research in Space

What happens onboard this space station is also astonishing. The station has maintained a continuous human presence in space since November 2000. The astronauts onboard have performed thousands of investigations dedicated to areas of earth and space science, biology, human physiology, physical sciences and technology demonstrations. As NASA states "The International Space Station is a state-of-the-art microgravity laboratory that is unlocking discoveries not possible on Earth and helping us push further into deep space." Research on this immense orbiting laboratory, the largest spacecraft ever built, is investigating how we can send humans farther into space to the Moon and Mars to explore the frontiers of knowledge.



Christoph Ruge, Fan Designer

Meet the Fan Designer Christoph Ruge

"In 2014, I got the idea to model the International Space Station using the LEGO® Digital Designer. Since I didn't have the bricks to build it myself, I thought it would be cool if the LEGO Group would do that instead!

Once it was ready, I set up an entry on LEGO Ideas. The project was well appreciated in the community and had a good start. Nevertheless, it was a long way to reach 10,000 votes. That gave me time to build other space-related models and continue my research about the station itself. So, I refined my model over and over again.

In the end it looked nothing like the first version I posted. I continued and didn't stop, even after the project finally reached the goal and got reviewed by the LEGO Group.

All in all, I had worked for more than three years on the first model and probably knew everything about the space station at that time. This research and knowledge became very handy when the Women of NASA (21312) set came onto the market. That was the moment I got the idea to do another version of the space station in the same scale as the shuttle included in this set. So, I built a new model and set it up on LEGO Ideas.

Again, it took a while to gather support and reach the review phase. Again, it got there. And again, it was rejected.

But then, I got news that my earlier model had passed the special anniversary review to celebrate the 10th anniversary of LEGO Ideas and that there would be a fan vote to determine which model would be built! That was very exciting.

I can be very resourceful in terms of being patient and waiting for something when I think it is a good idea... but I can be impatient as well. I think it is worth fighting for your dreams!"



"I was overwhelmed when I got the news! Since the fan vote was a blind vote, I was only able to imagine how my chances were progressing. I felt sorry for the other three contestants; I would have loved to see Stitch produced as well! All in all, it felt quite unreal."



LEGO® designers Samuel Johnson, Crystal Fontan and Corvin Alexander Stichert were the team who helped take the already awesome ISS design to the finish line: refining the design, working on the graphics and ensuring that the original design met the LEGO requirements for stability and quality.



More than a decade of amazing LEGO® Ideas!

The bubbling hive of creativity that is LEGO® Ideas turned ten years old at the end of 2018. Originally called LEGO CUUSOO, this creativity crowdsourcing concept has evolved and expanded over the years, finding new ways of collaborating with the many talented and passionate LEGO fans around the world.

Along LEGO Ideas' journey we have encountered many incredible stories while working with amazing LEGO fans, that have resulted in the launch of some of the most unique LEGO sets ever produced.

For the 10-year anniversary review, we dug into the LEGO Ideas archive of unlaunched 10K product ideas to rediscover concepts that still had the potential of becoming an official LEGO Ideas set. We then involved the LEGO Ideas Community in a special vote to make the final choice.

We're proud to present the winner: this brilliant replica of the International Space Station, the largest human-made structure that exists off the Earth.

Enjoy and keep creating!

© 2020 Mojang AB and Mojang Synergies AB. MINECRAFT is a trademark or registered trademark of Mojang Synergies AB.

Back to the Future Films are trademarks and copyrights of Universal Studios and U-Drive Joint Venture. Licensed by Universal Studios Licensing LLC. All Rights Reserved.



© 2014 Columbia Pictures Industries, Inc. All rights reserved.

THE BIG BANG THEORY and all related characters and elements are trademarks of and © Warner Bros. Entertainment Inc.



WB SHIELD: TM & © Warner Bros. Entertainment Inc.

© Disney/Pixar

BBC, DOCTOR WHO (word marks, logos and devices), TARDIS, DALEKS, CYBERMAN and K-9 (word marks and devices) are trademarks of the British Broadcasting Corporation and are used under license. BBC logo © BBC 1996. Doctor Who logo © BBC 2009. Dalek image © BBC/Terry Nation 1963. Cyberman image © BBC/Kit Pedler/Gerry Davis 1966. K-9 image © BBC/Bob Baker/Dave Martin 1977.

BBC

© 2016 Subafilms Ltd. A Yellow Submarine™ product. ™ Trade Mark of Subafilms Ltd © 1968. Authorised Beatles™ merchandise.

Produced under license of Caterham Cars Ltd. The CATERHAM logo, name SEVEN and the 7 device are trademarks used with the approval of the owner; Caterham Cars Lt.

ADVENTURE TIME, CARTOON NETWORK, the logos, and all related characters and elements are trademarks of and © Cartoon Network.

TM & © World Events Productions, Ltd. Under license to Classic Media, LLC.

© Disney





LEGO® Ideas and Space

The concept of space is one that has a universally fascinating appeal to LEGO® brick fans, and people of all ages worldwide, which is why there have already been some truly iconic LEGO Ideas sets based around the theme.

The International Space Station (ISS) is an amazing addition to this category of LEGO Ideas sets. Check out some of the earlier models and be prepared to be spaced out!

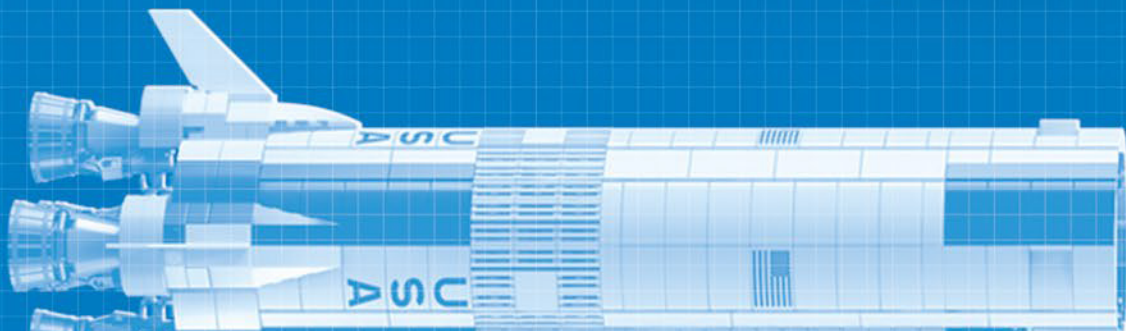

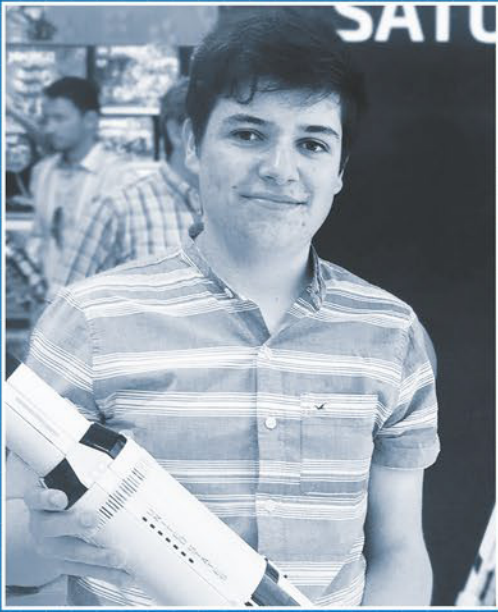

Felix Stiessen, Co-Fan Designer

NASA Apollo Saturn V

At a mind-blowing 3+ feet high, this majestic model was packed with details and features. These included the three rocket stages, as well as the lunar lander and orbiter, all of which really do justice to the ground-breaking space mission of the Moon landing. A great job done by Valerie Roche and Felix Stiessen, the Co-Fan designers of the model.

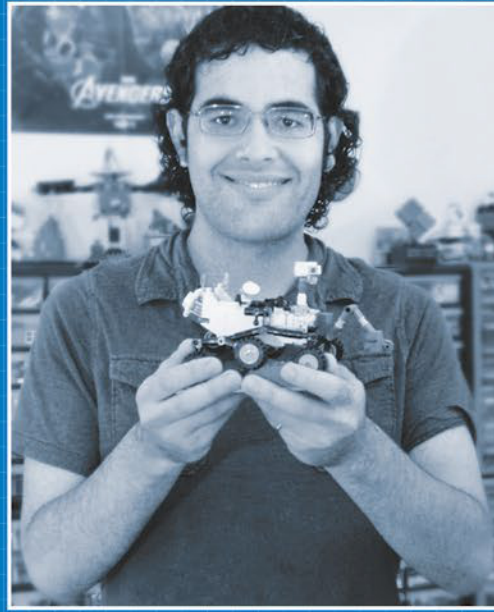

Stephen Pakbaz, Fan Designer

NASA Mars Science Laboratory Curiosity Rover

Designed by real Curiosity Rover engineer, Stephen Pakbaz, this little LEGO® brick buggy represents all the innovation and expertise that was packed into the advanced mobile laboratory that had a key role in the history of space exploration.



Maia Weinstock, Fan Designer

Women of NASA

A tribute to some of the most ground-breaking women in science, technology, engineering and mathematics (STEM), this set honored the work of four female space pioneers: astronomer and educator Nancy Grace Roman, computer scientist and entrepreneur Margaret Hamilton, astronaut, physicist and entrepreneur Sally Ride and astronaut, physician and engineer Mae Jemison.

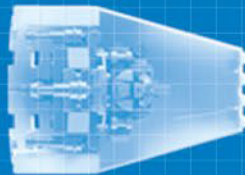

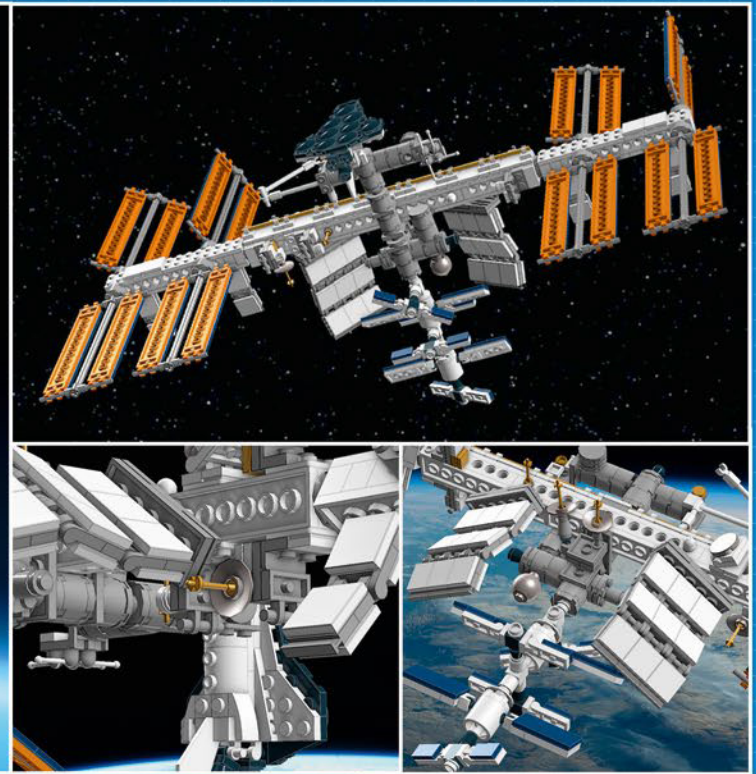
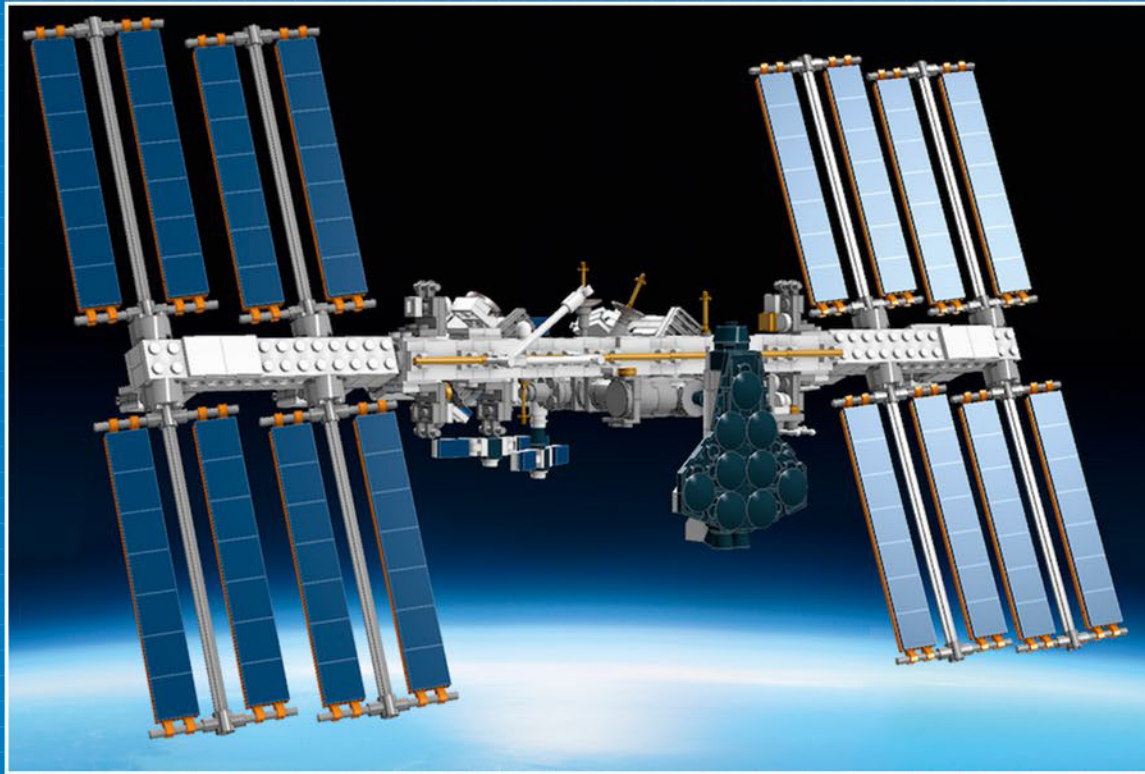

The 10 Year Anniversary Special Review

The International Space Station was chosen as the winning LEGO® Ideas set via a slightly different selection process than the normal LEGO Ideas sets...

“To celebrate 10 years of crowdsourcing and collaboration between LEGO Ideas (called LEGO CUUSOO until 2014) and LEGO fans around the world, we decided to dive into the archives of LEGO Ideas projects that had gathered 10,000 supporters but hadn’t made it into production. There were over 130 projects which met that criteria and that we believed could still make great LEGO Ideas products, as circumstances around their initial rejection had changed.”



Hasan Jensen,
Engagement Manager

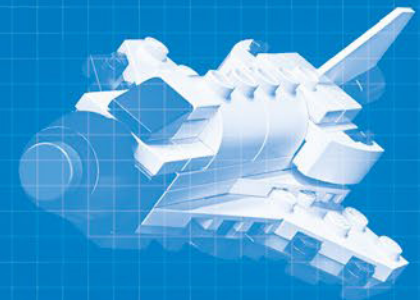

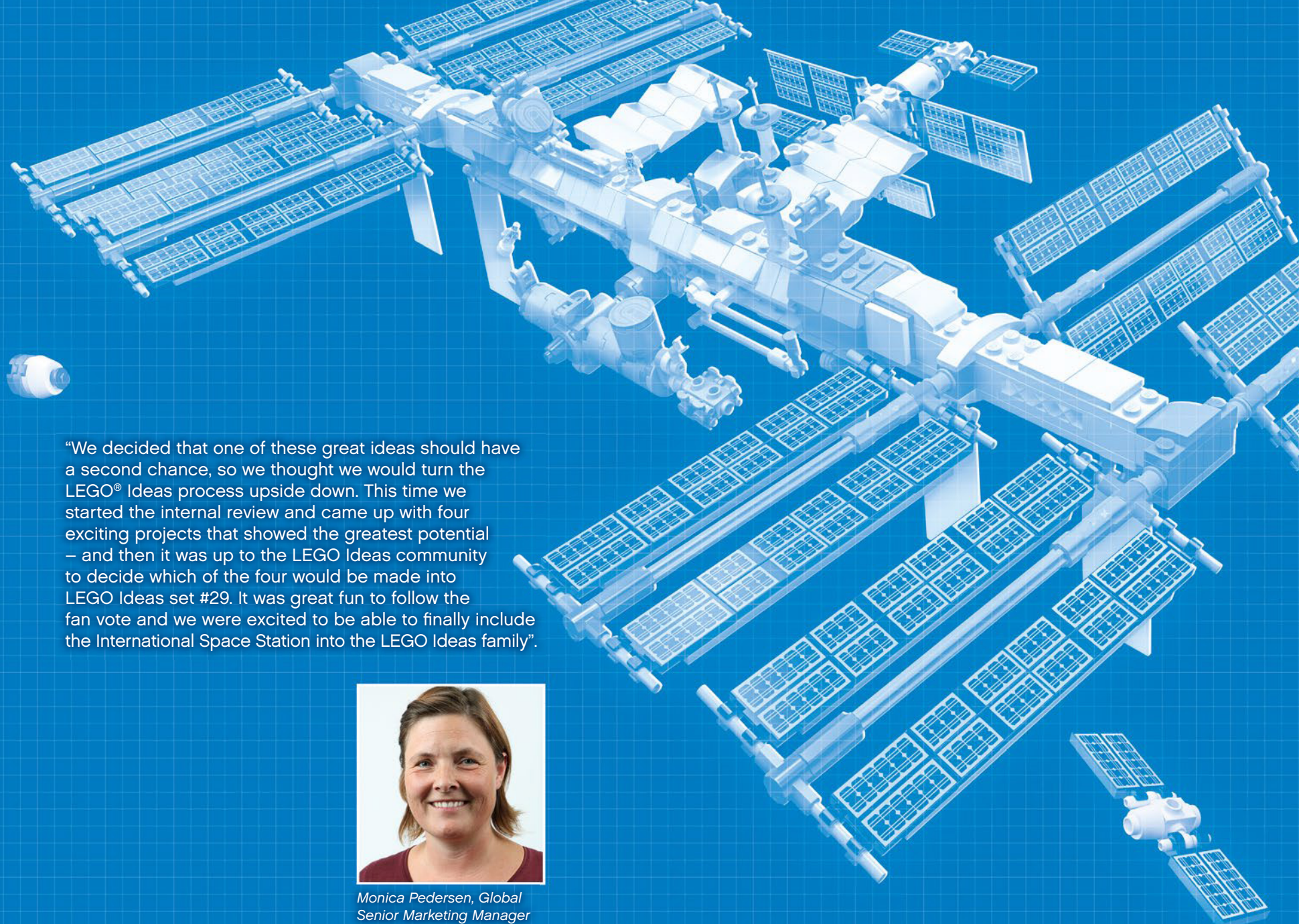

“We decided that one of these great ideas should have a second chance, so we thought we would turn the LEGO® Ideas process upside down. This time we started the internal review and came up with four exciting projects that showed the greatest potential – and then it was up to the LEGO Ideas community to decide which of the four would be made into LEGO Ideas set #29. It was great fun to follow the fan vote and we were excited to be able to finally include the International Space Station into the LEGO Ideas family”.



Monica Pedersen, Global Senior Marketing Manager

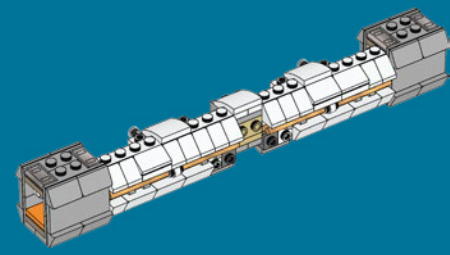
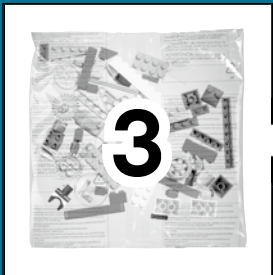
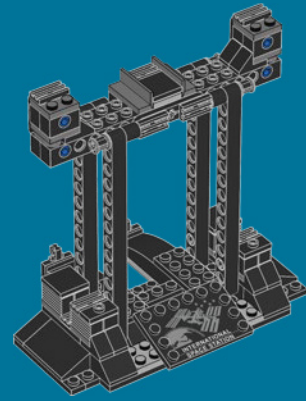
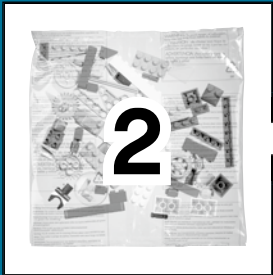
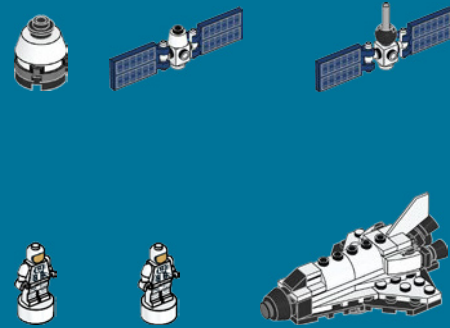

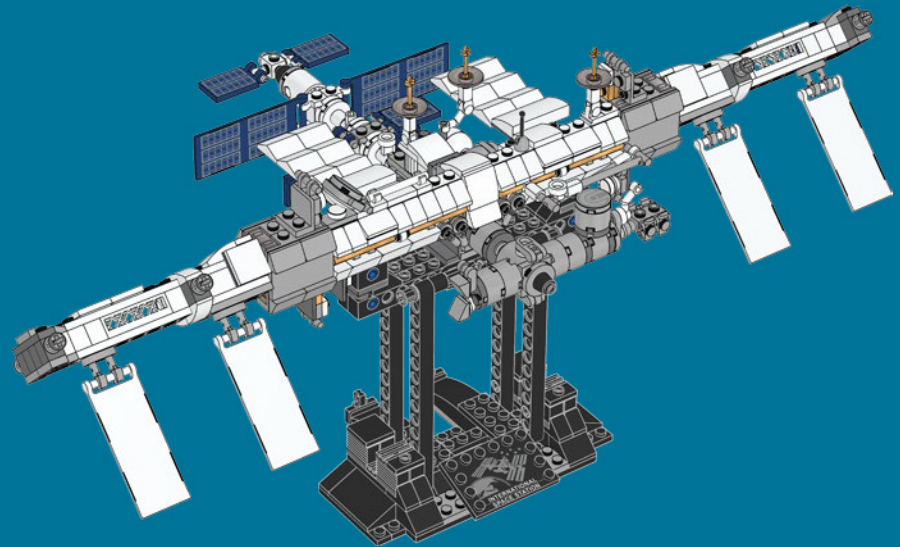
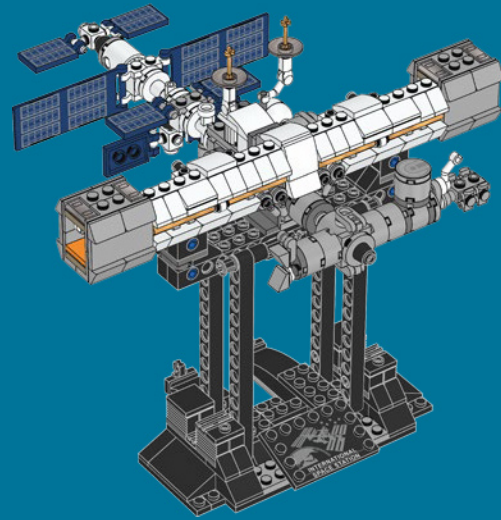
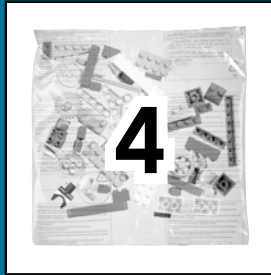

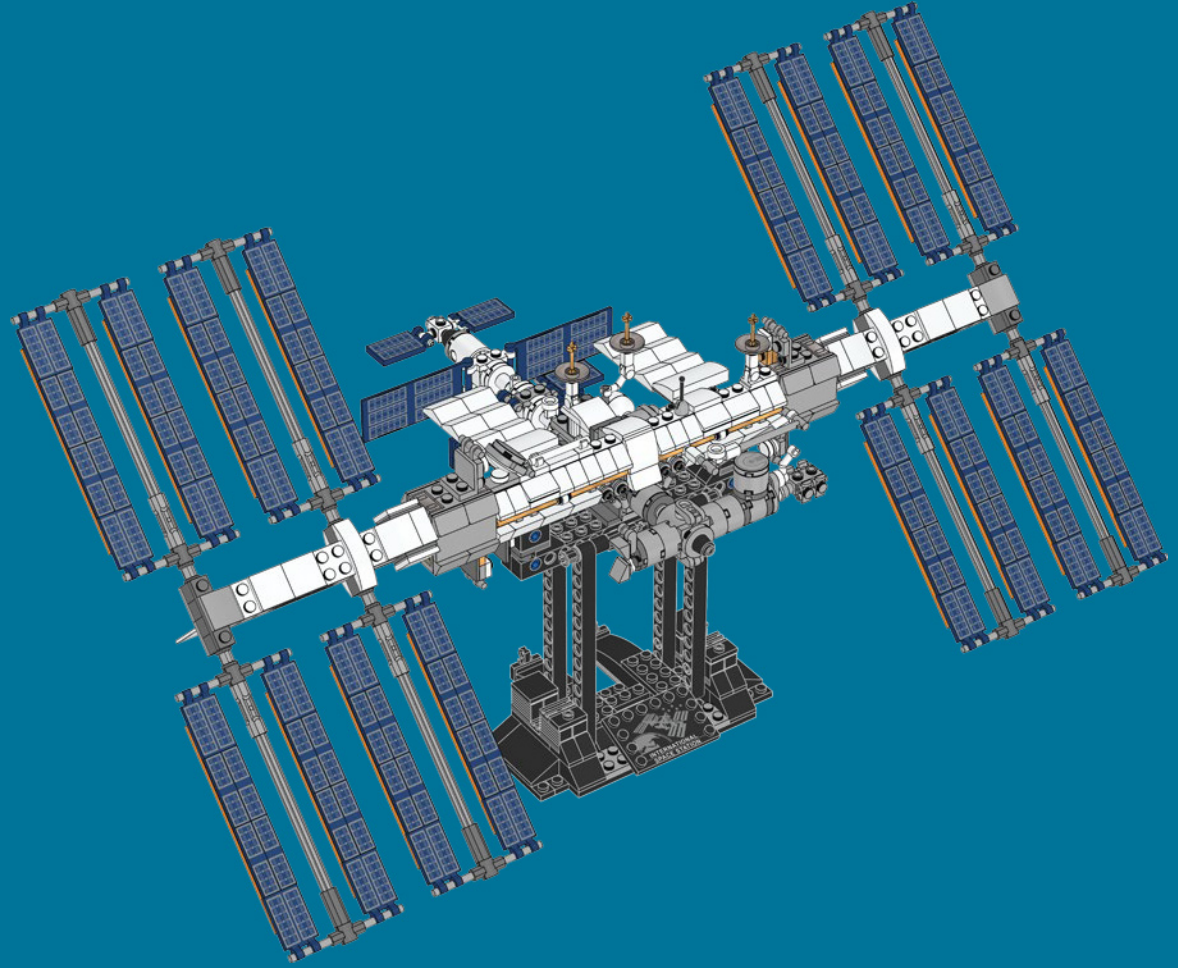
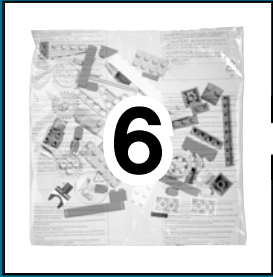

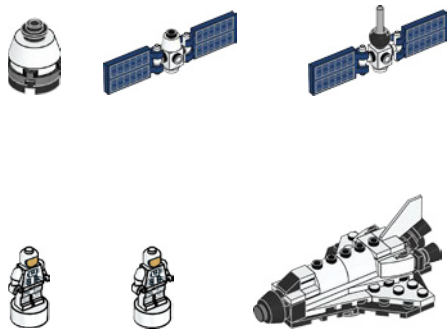
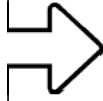

2x



1x



1x



1x



1x

1

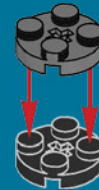

2



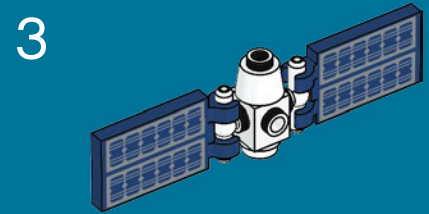
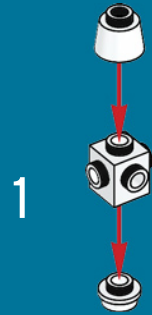
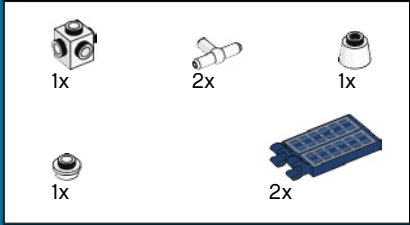

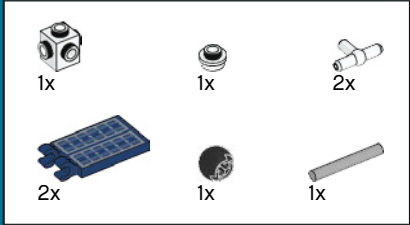

1

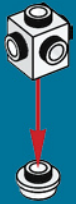

2

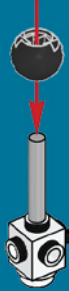

3



4

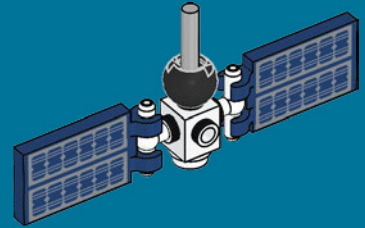

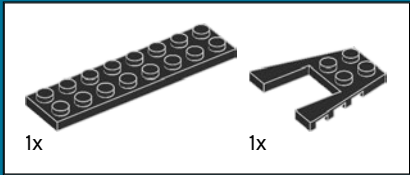

1

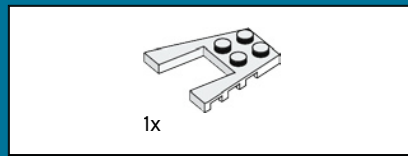
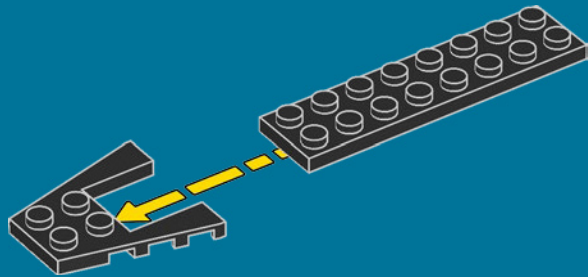

2

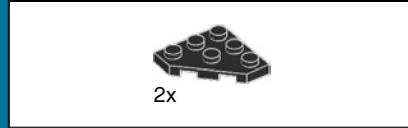
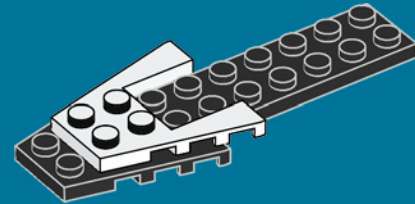

3

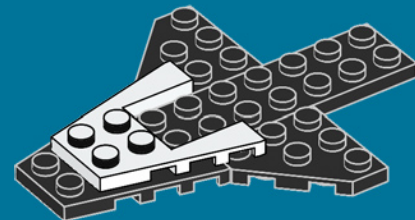

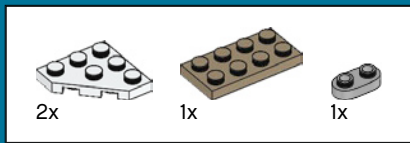

4

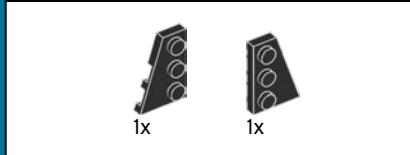
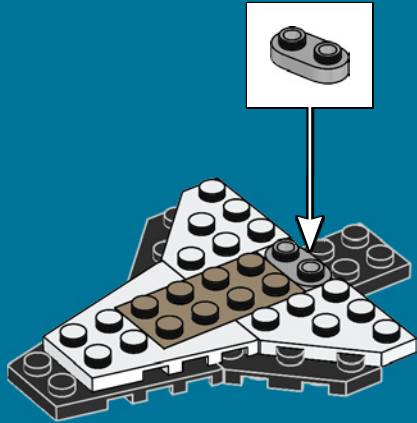

5

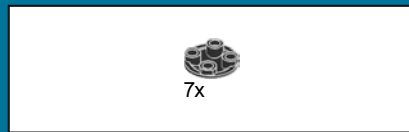
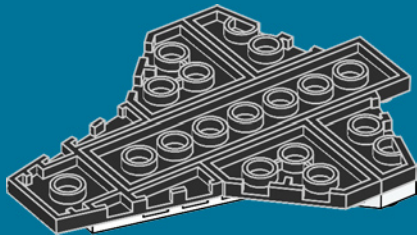

6

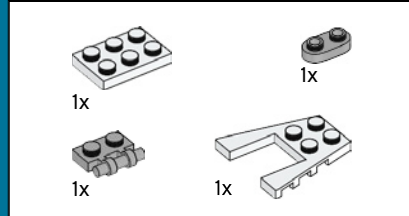
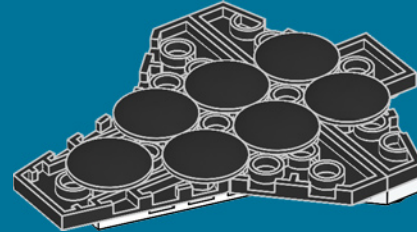

7

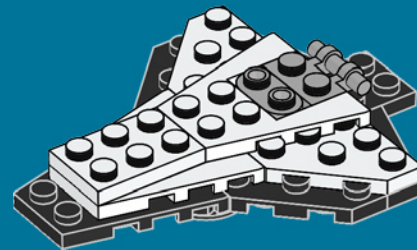

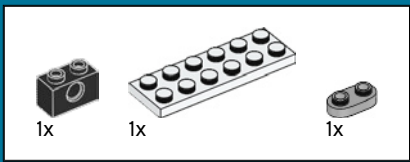

8

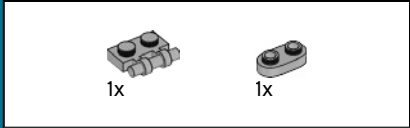
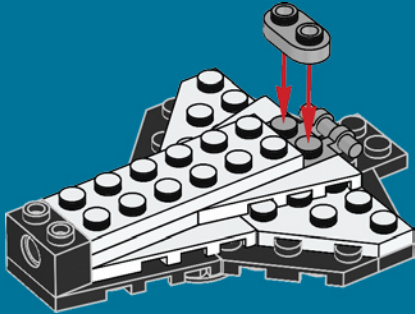

9

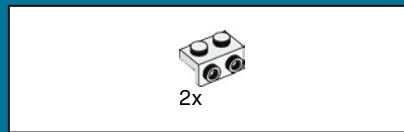
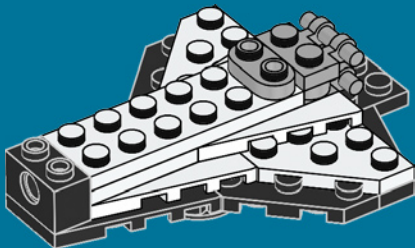

10

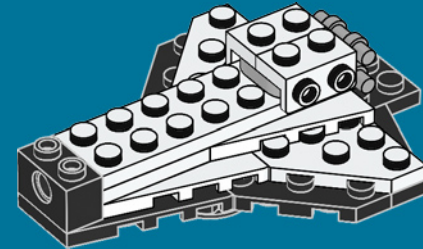

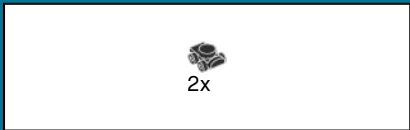

11

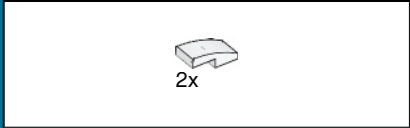
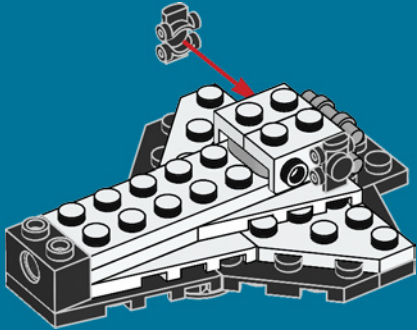

12

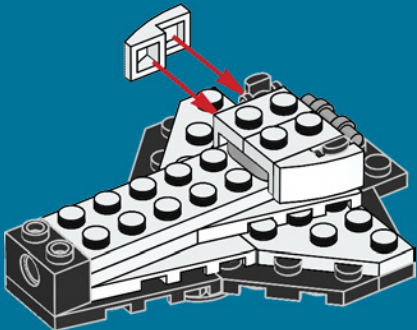

13

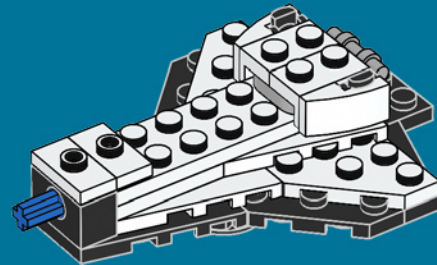

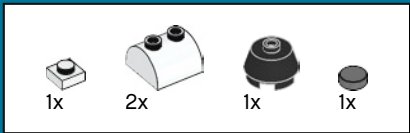

14

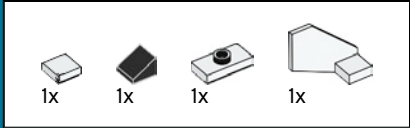
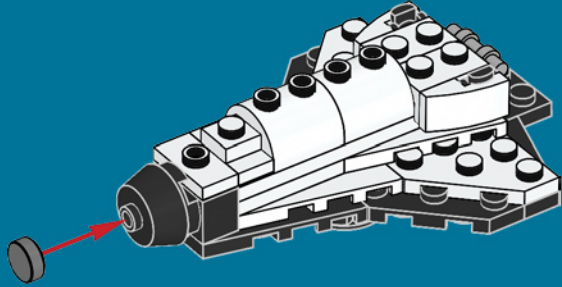

15

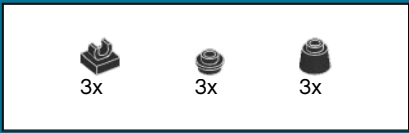
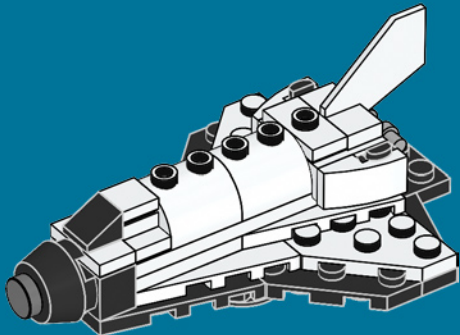

16

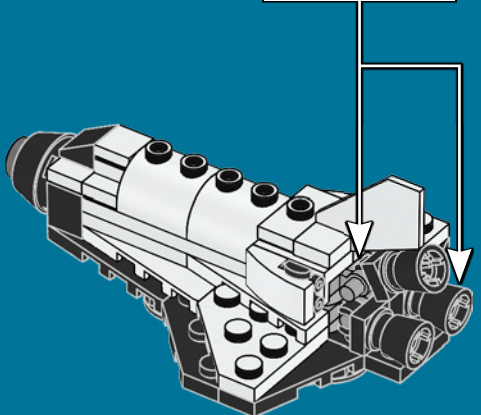
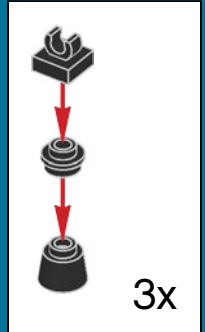

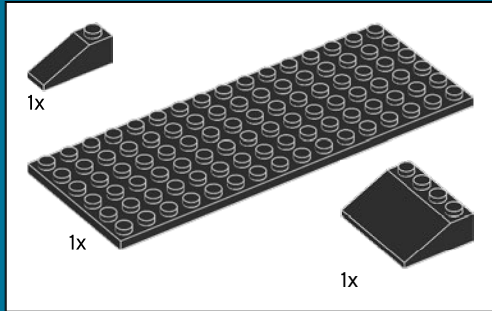
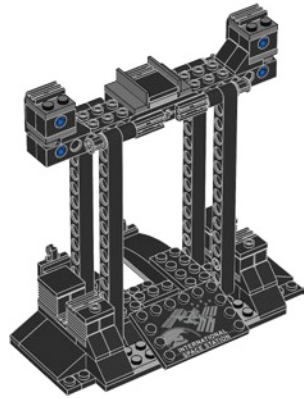

1

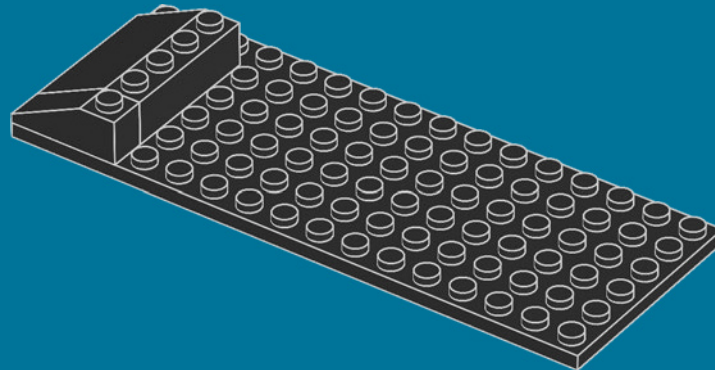

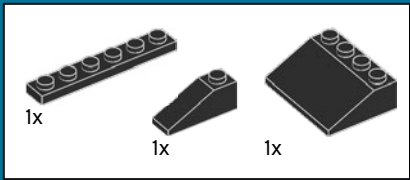

2

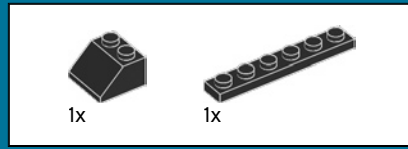
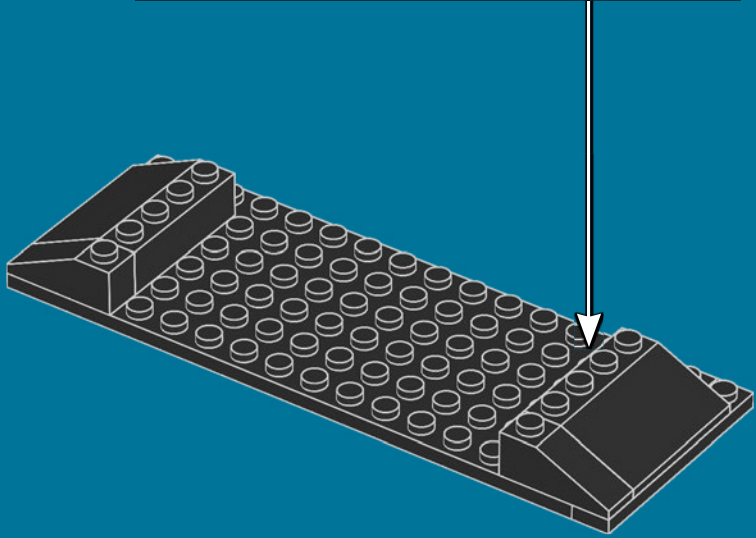
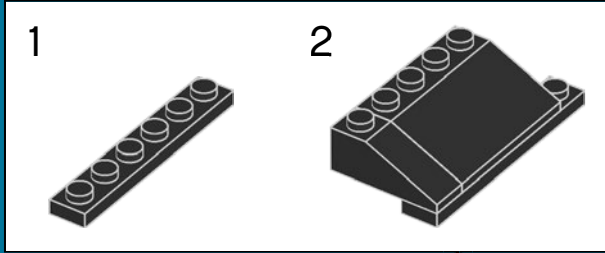

3

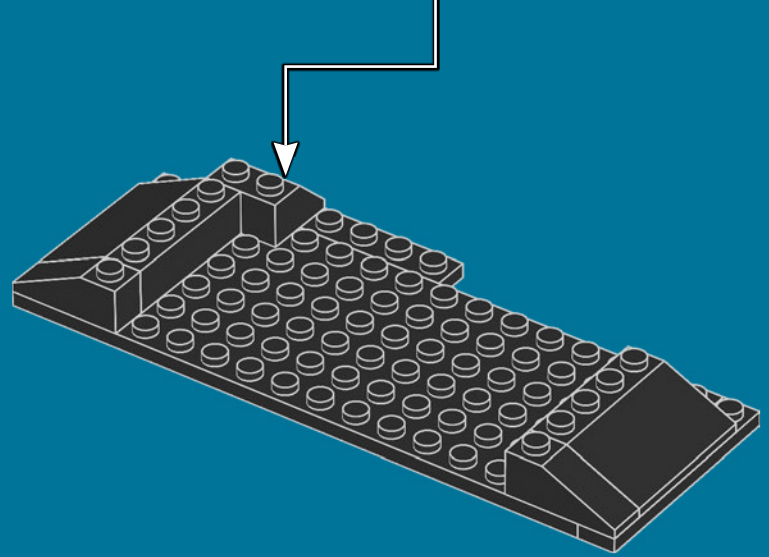
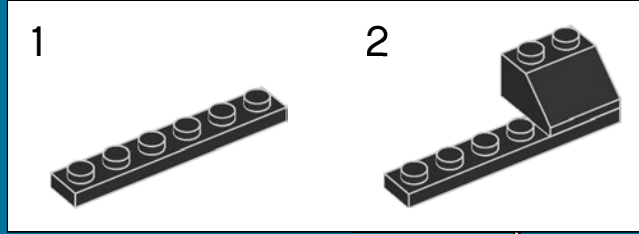

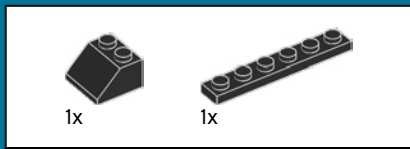

4

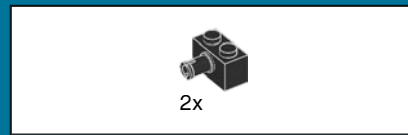
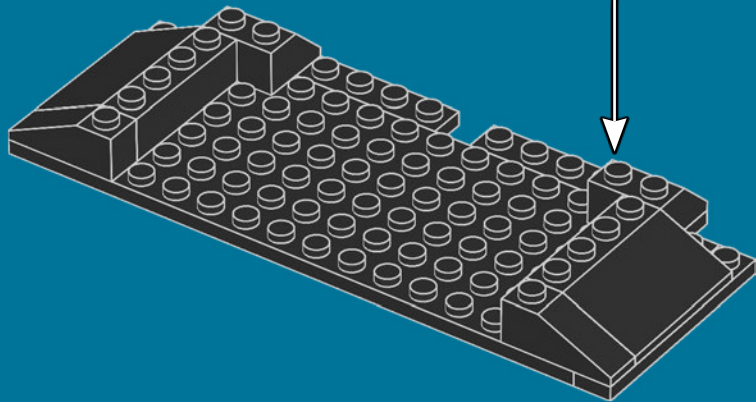
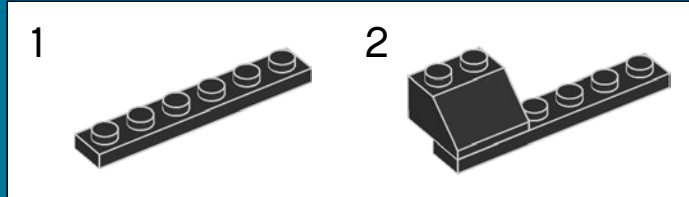

5

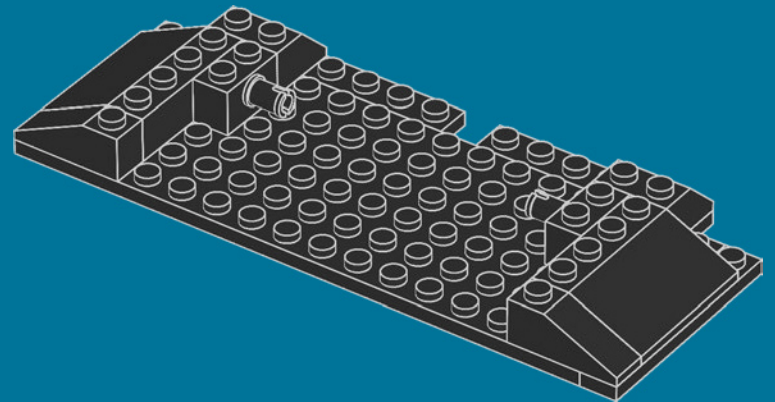

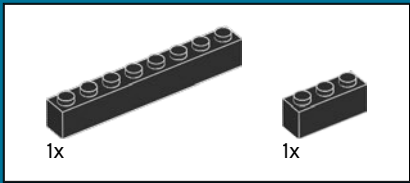

6

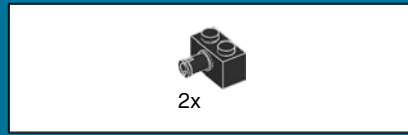
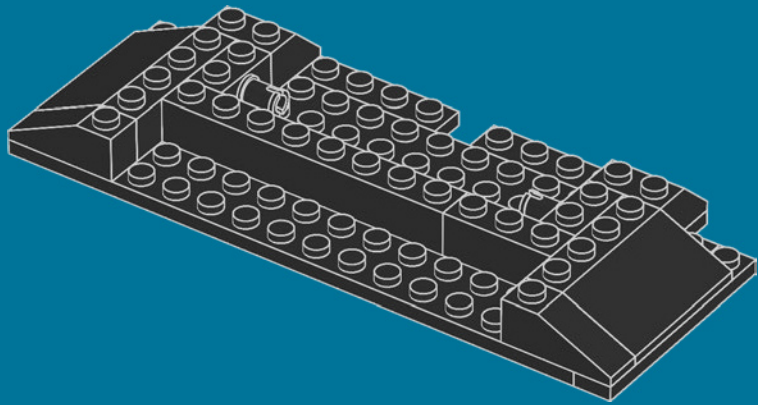

7

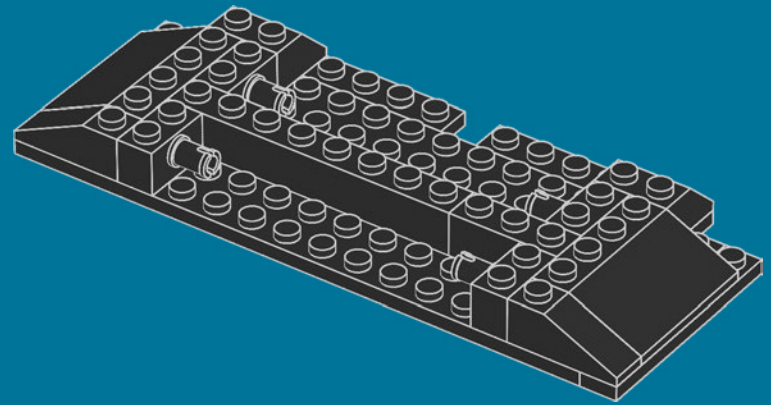

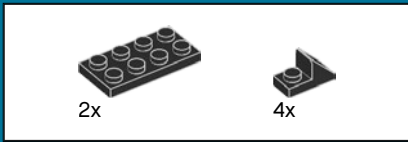

8

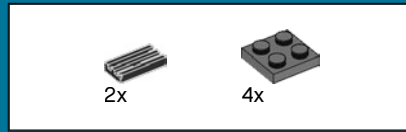
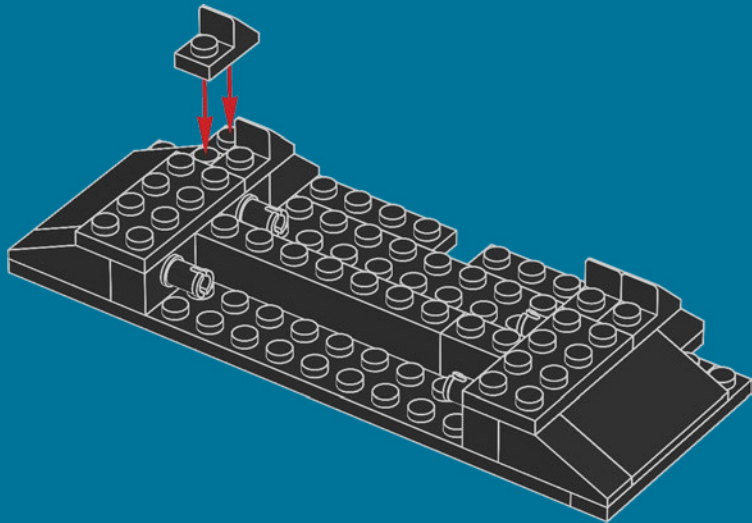

9

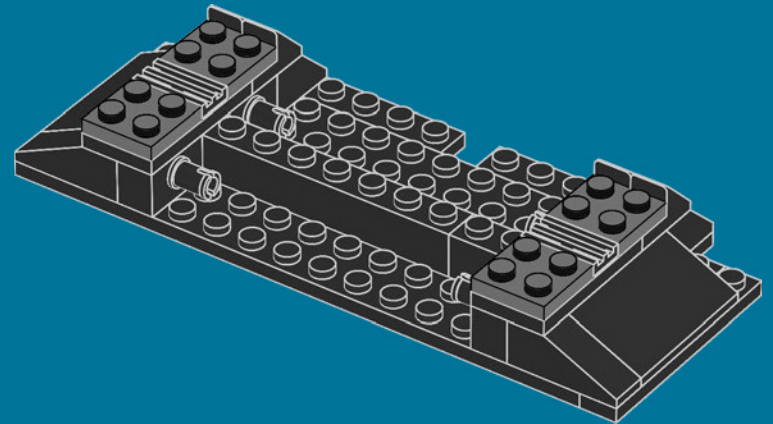



4x



4x

10

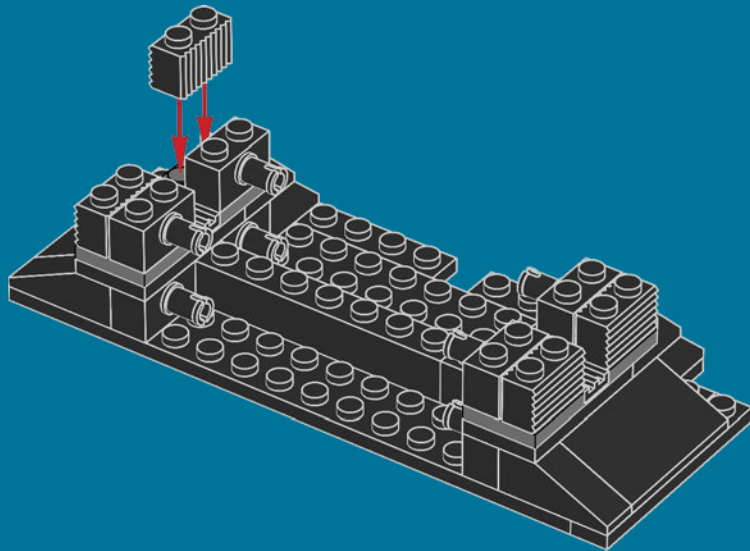

2x



2x



2x

11

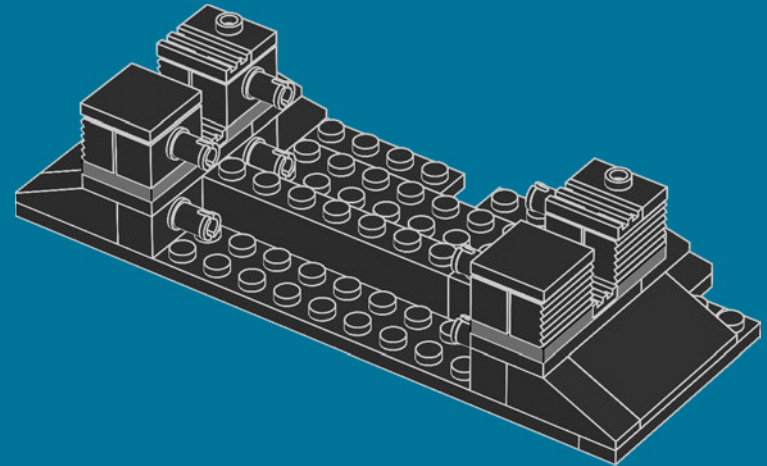

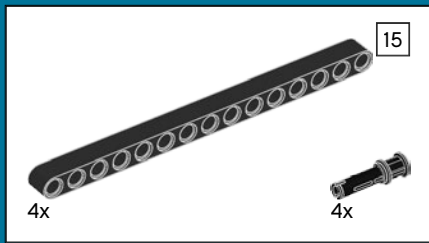

12

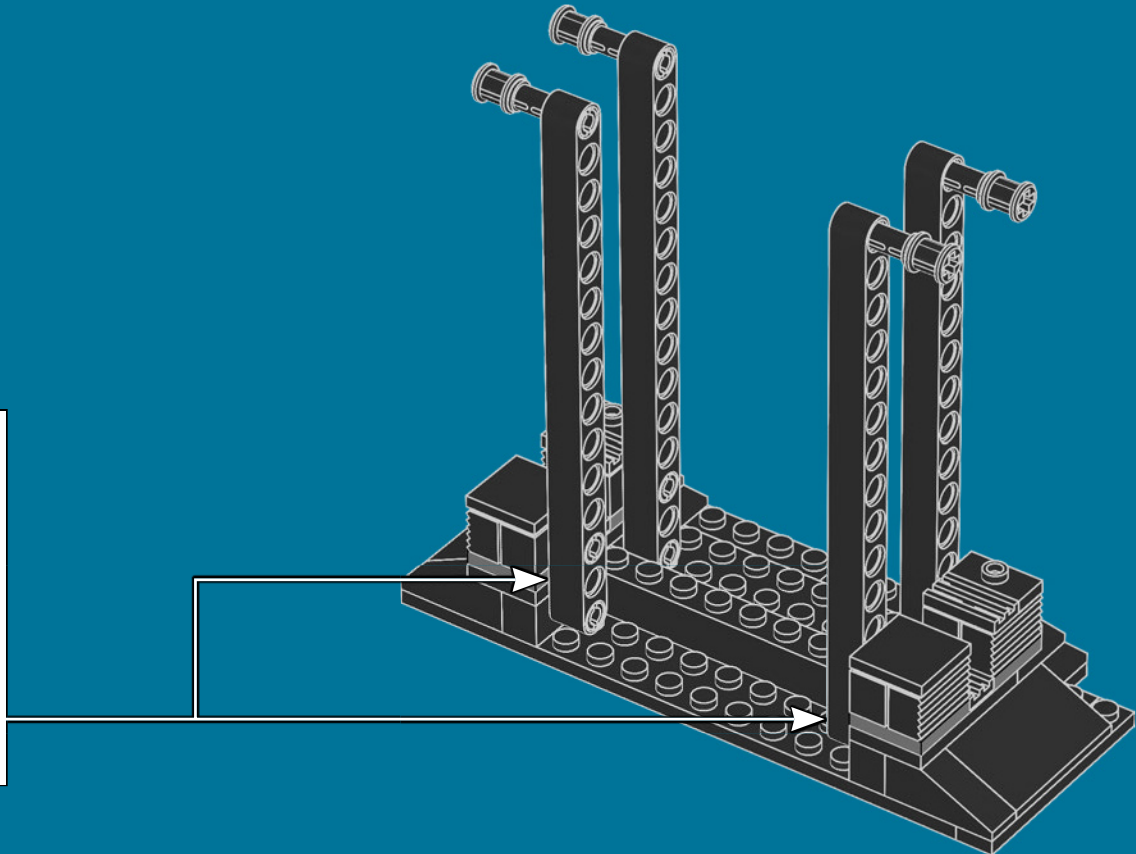
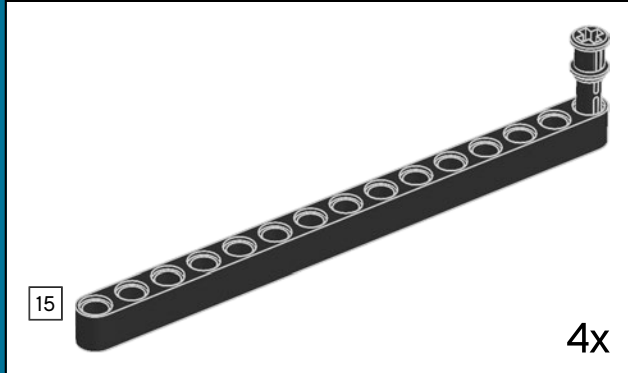

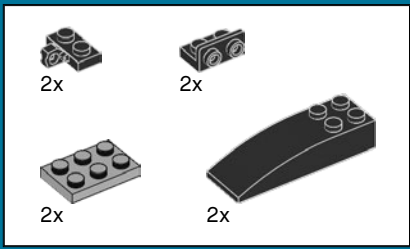

13

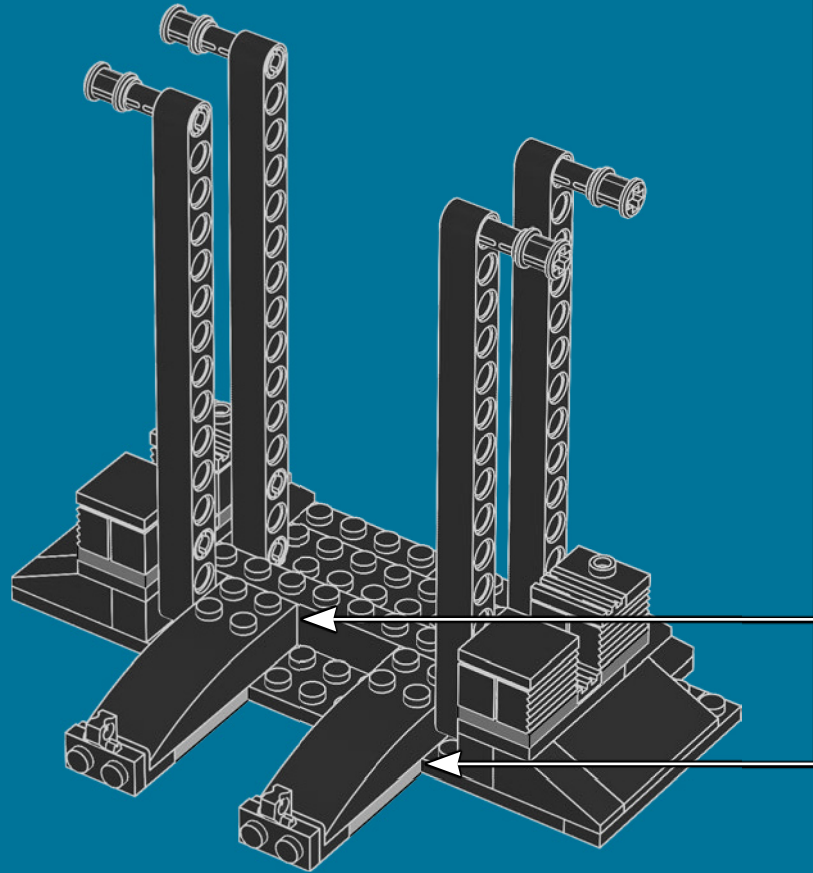
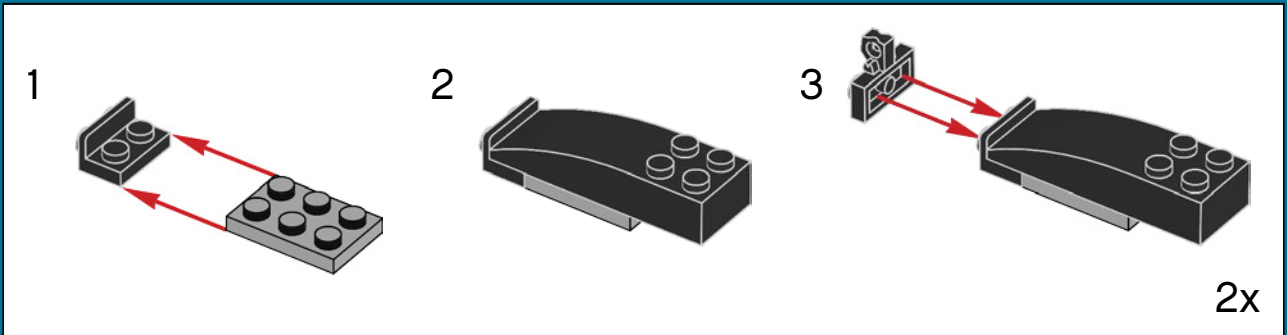

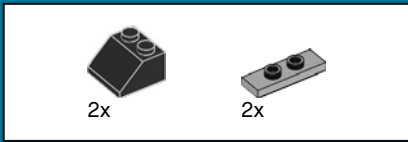

14

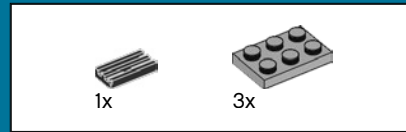
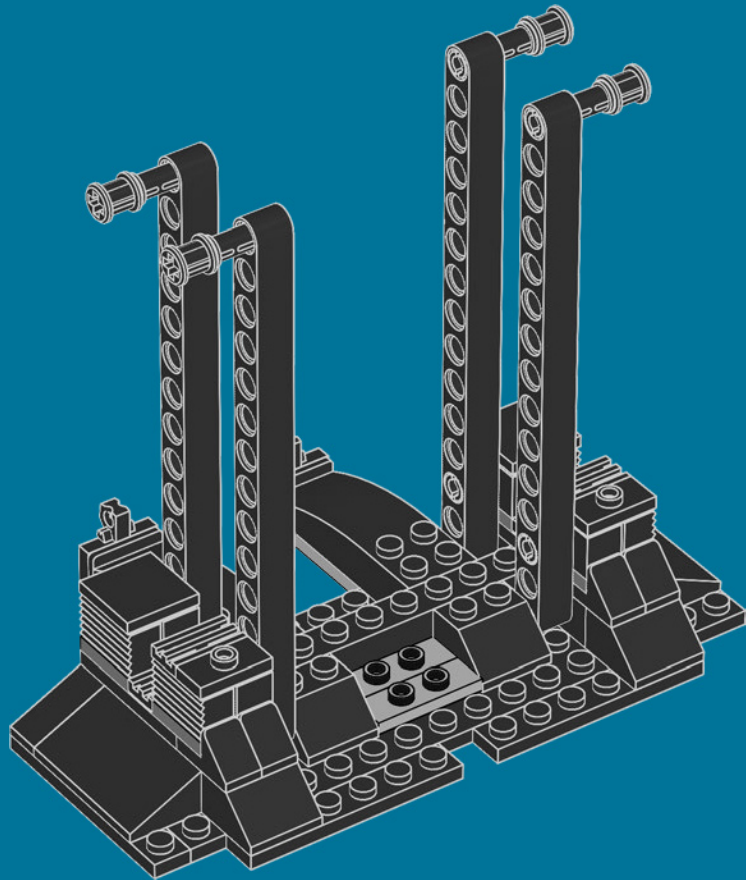

15

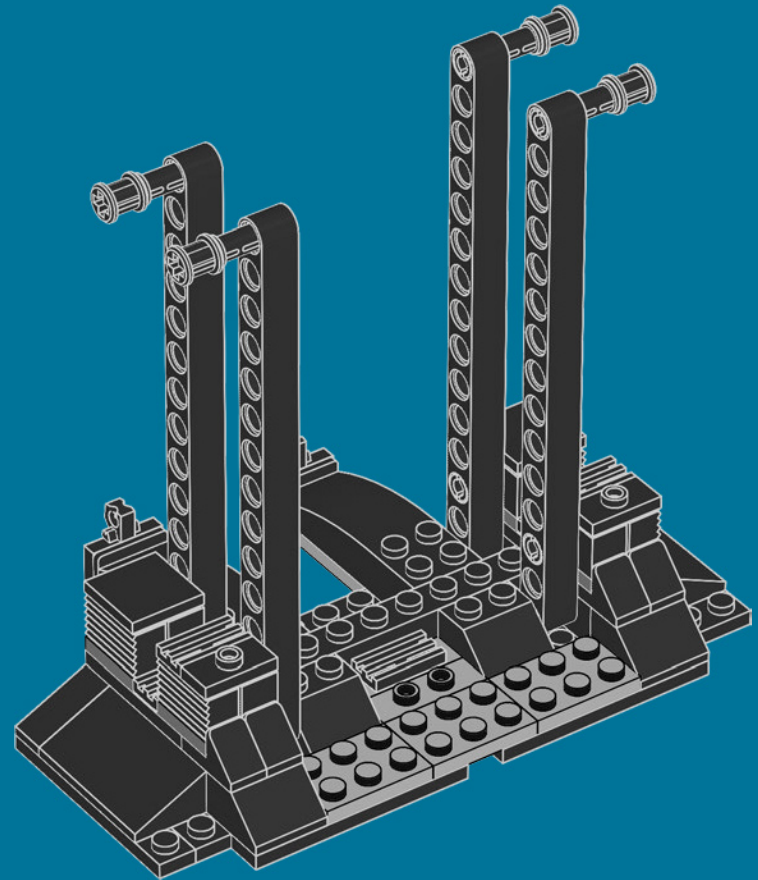

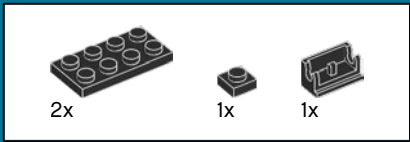

16

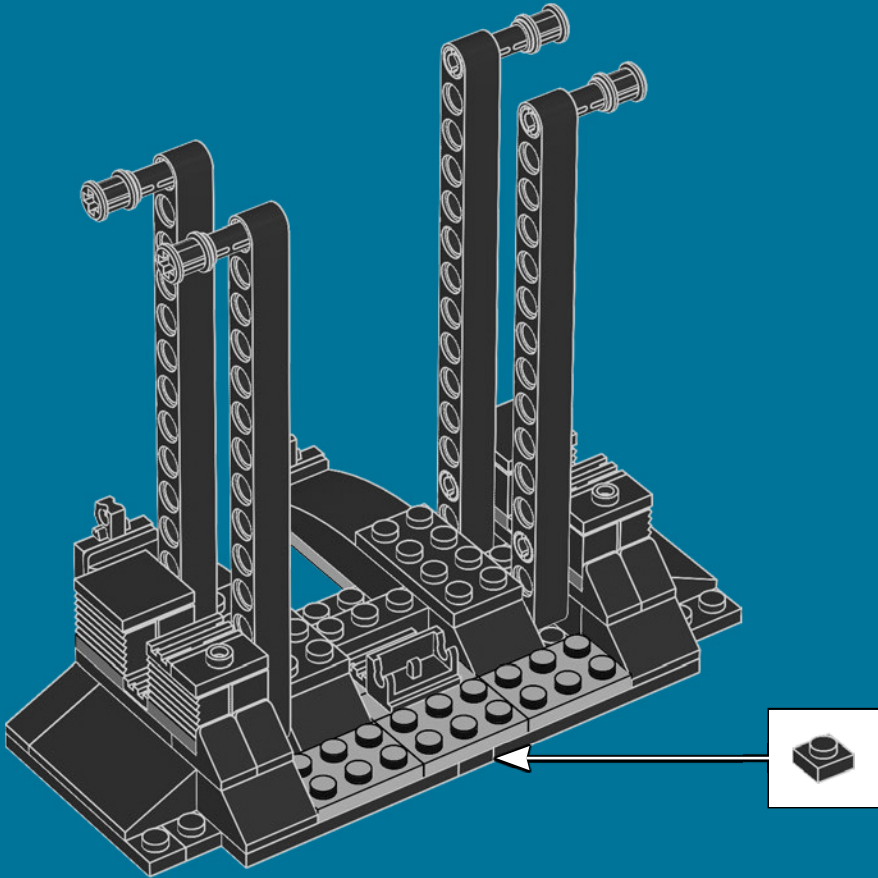

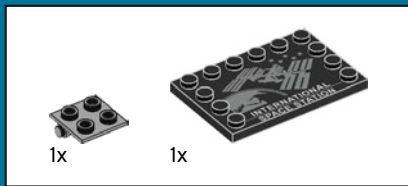

17

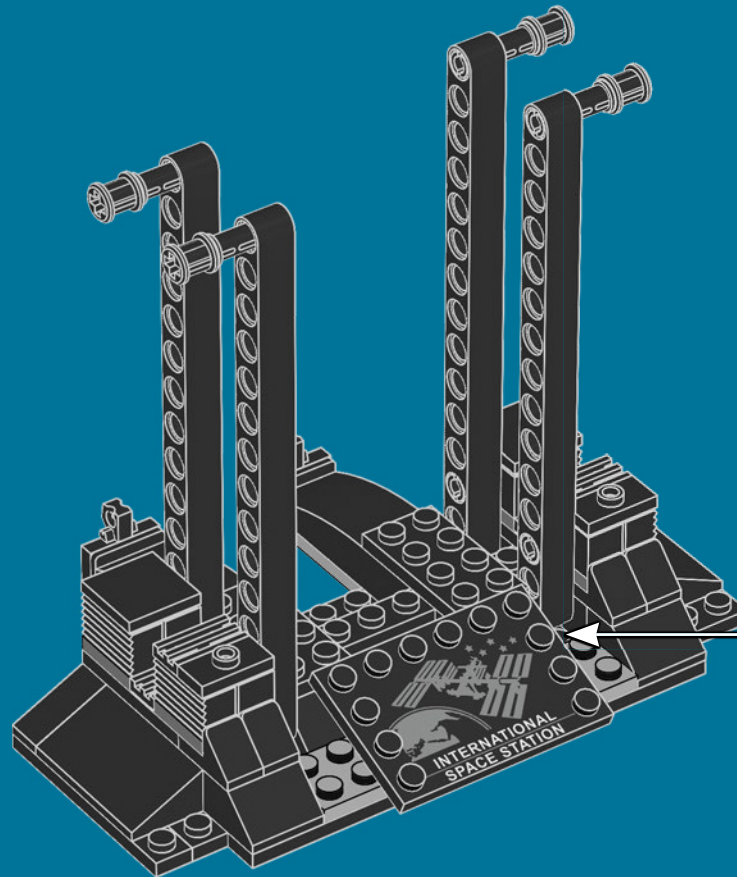
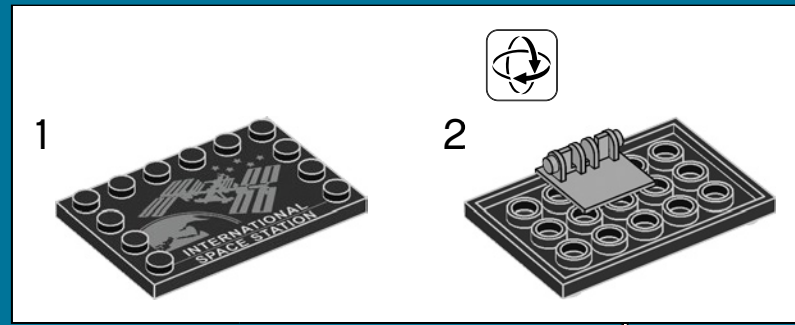

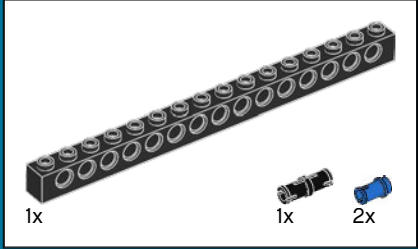
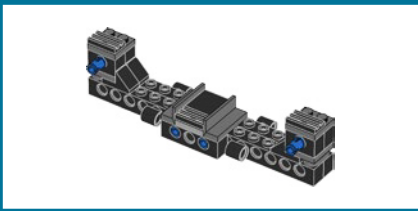

18

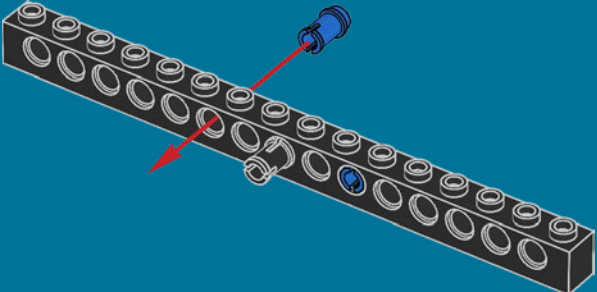

19

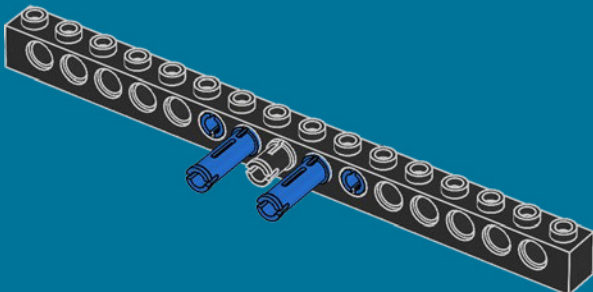

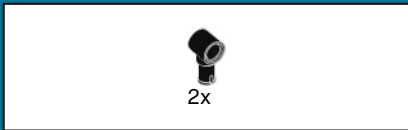

20

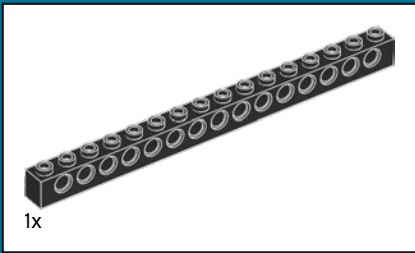
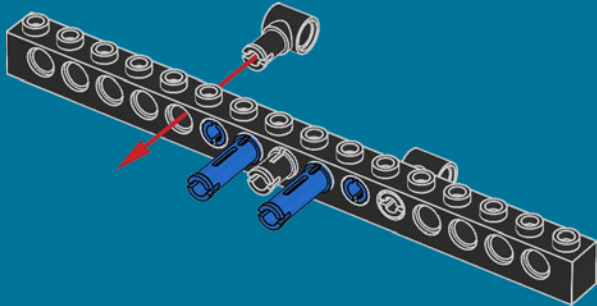

21

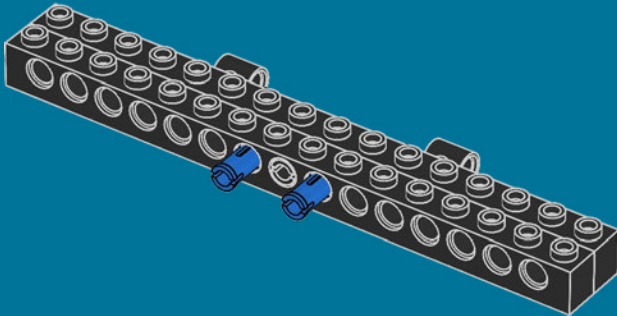

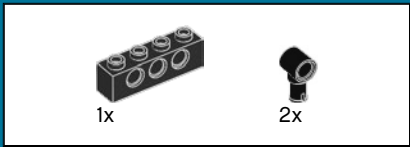

22

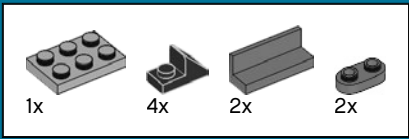
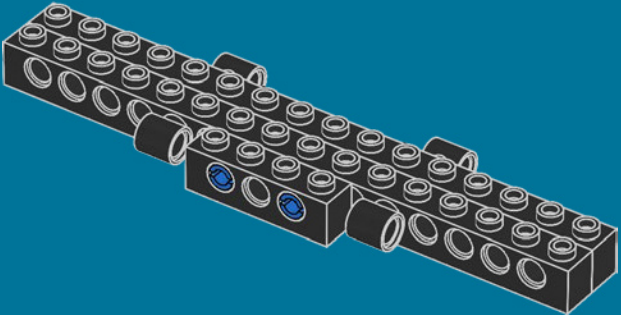

23

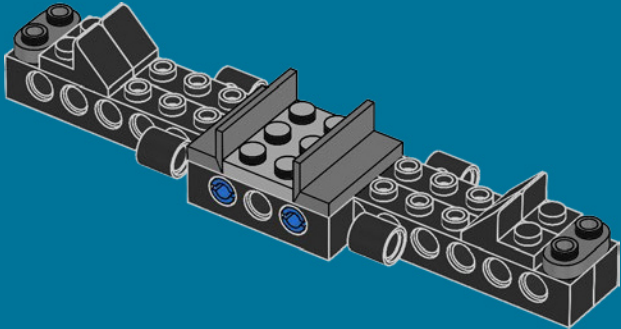



24

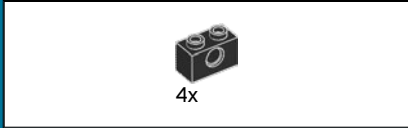
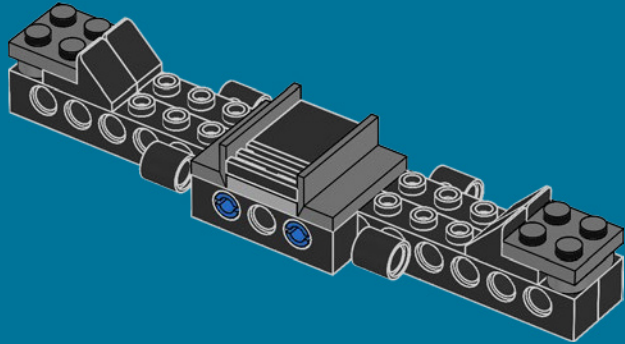

25

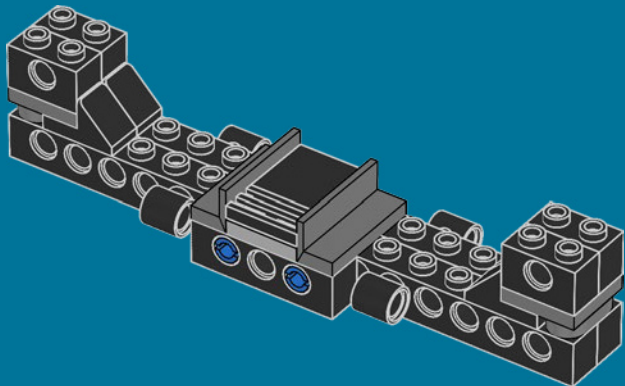

26

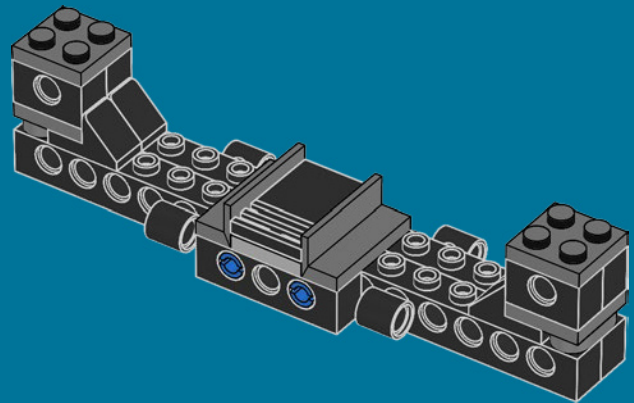

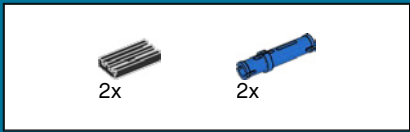

27

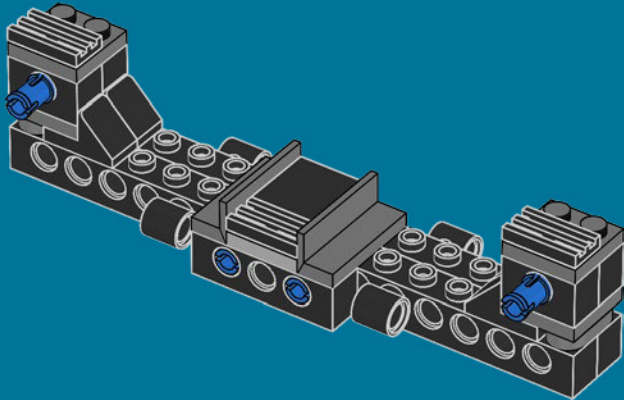

28

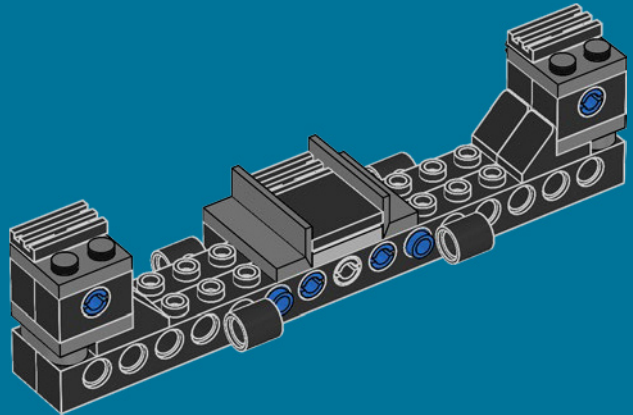

29

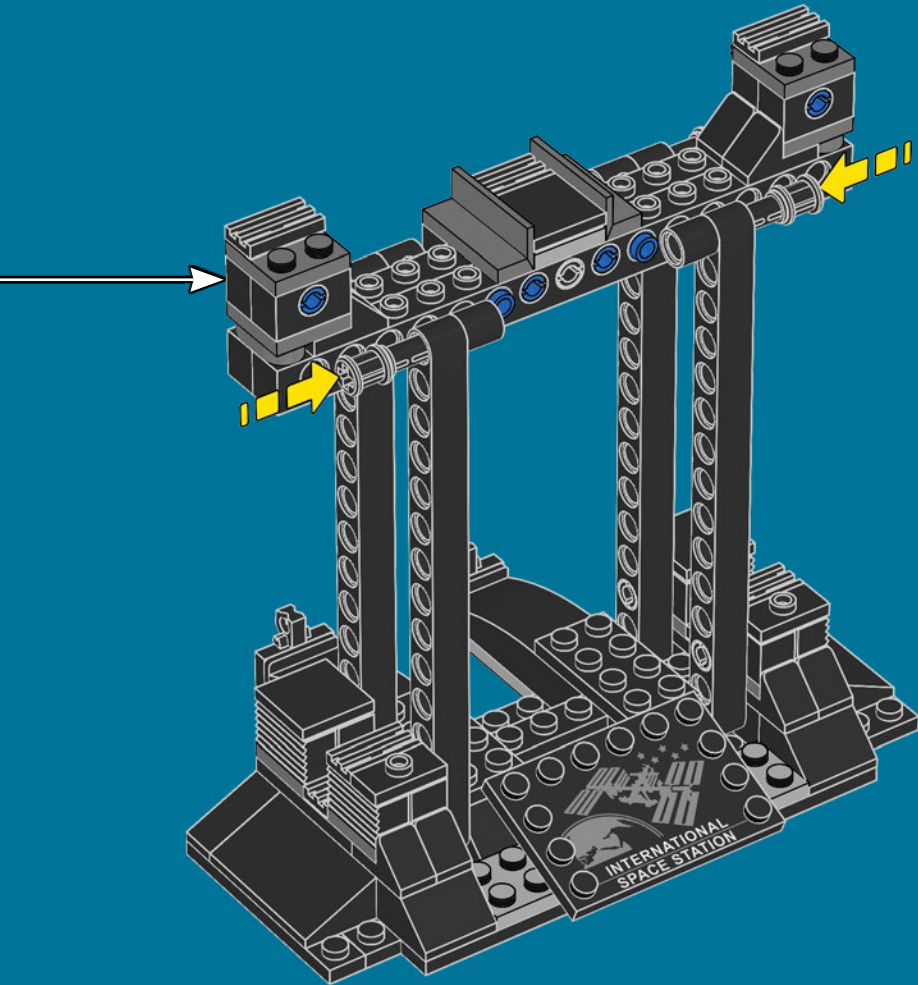

30

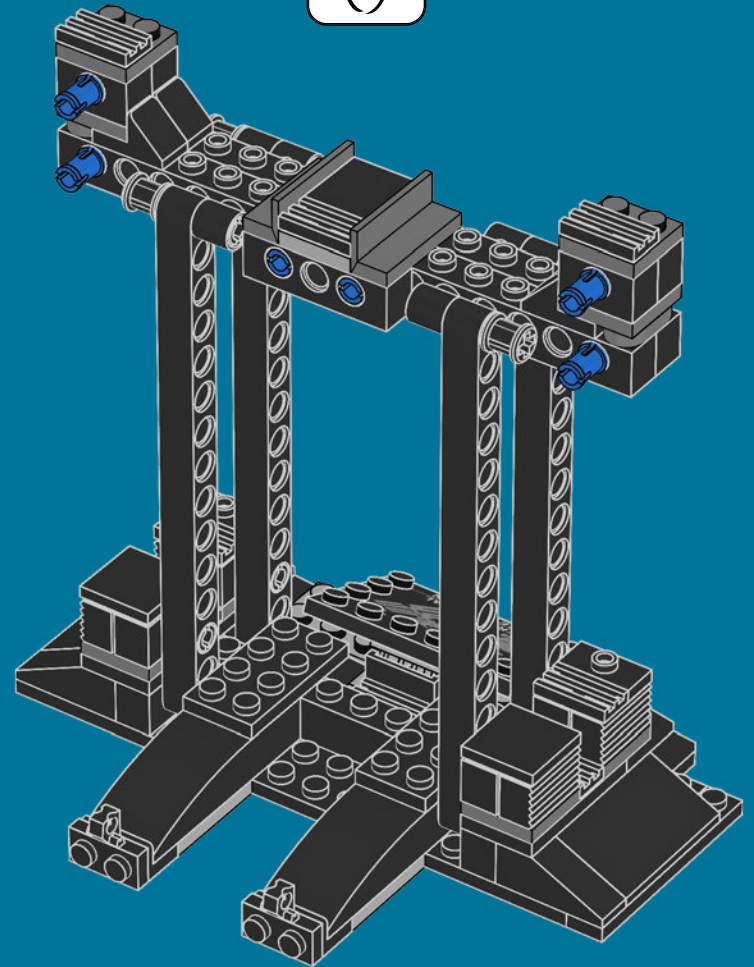
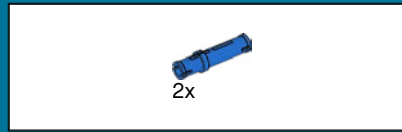

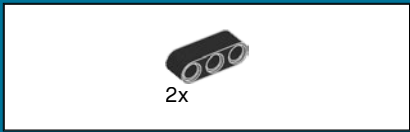

31

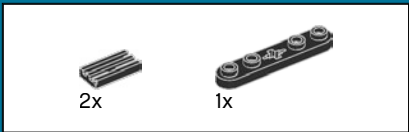
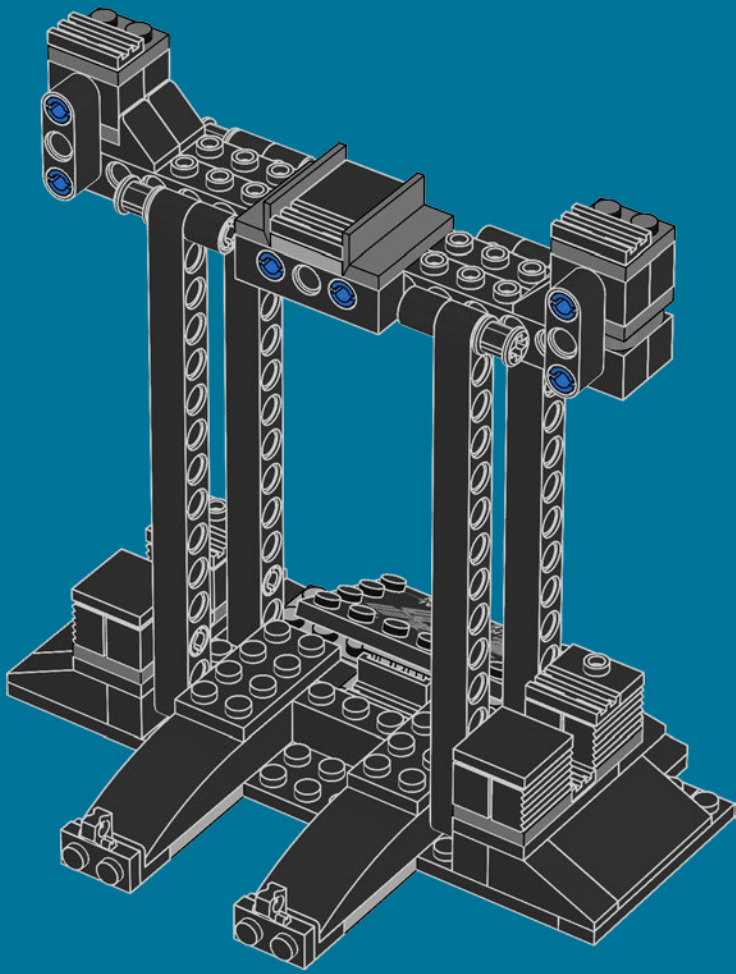

32

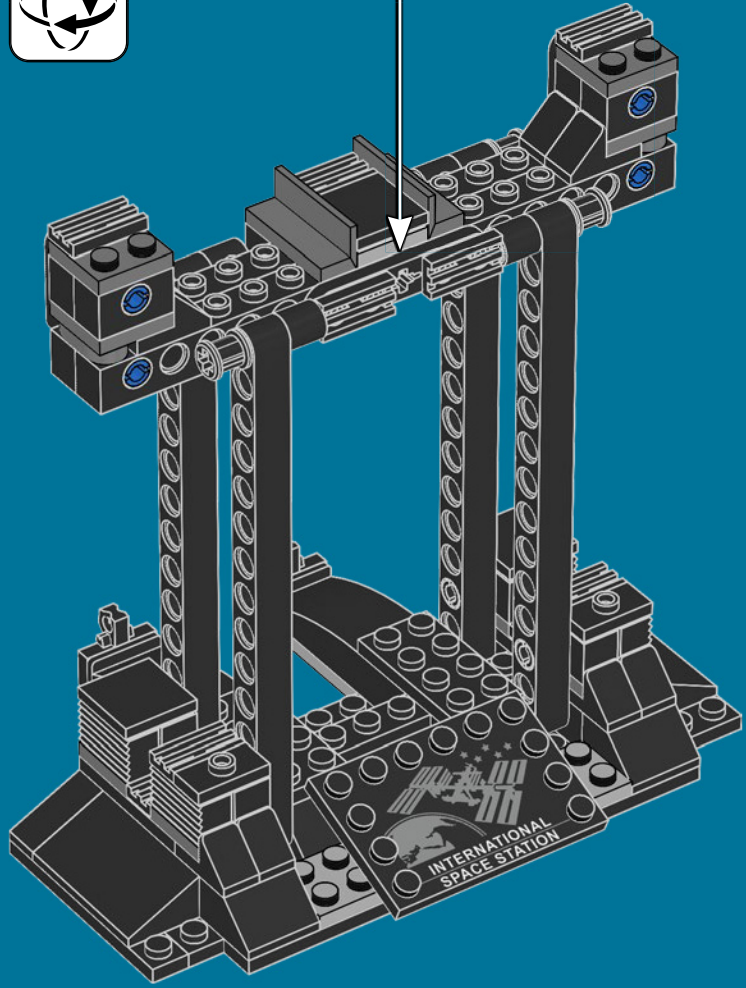
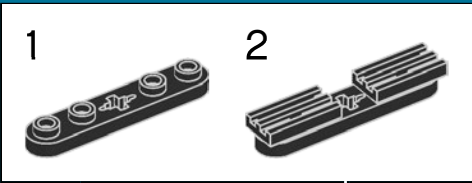

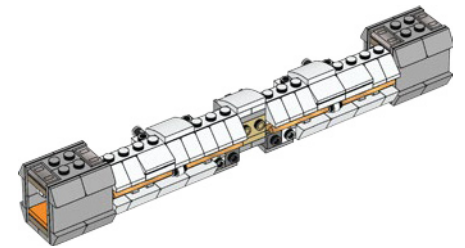
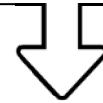
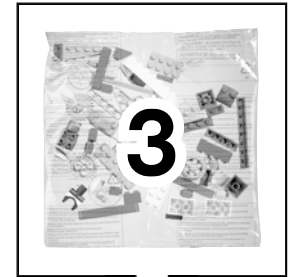
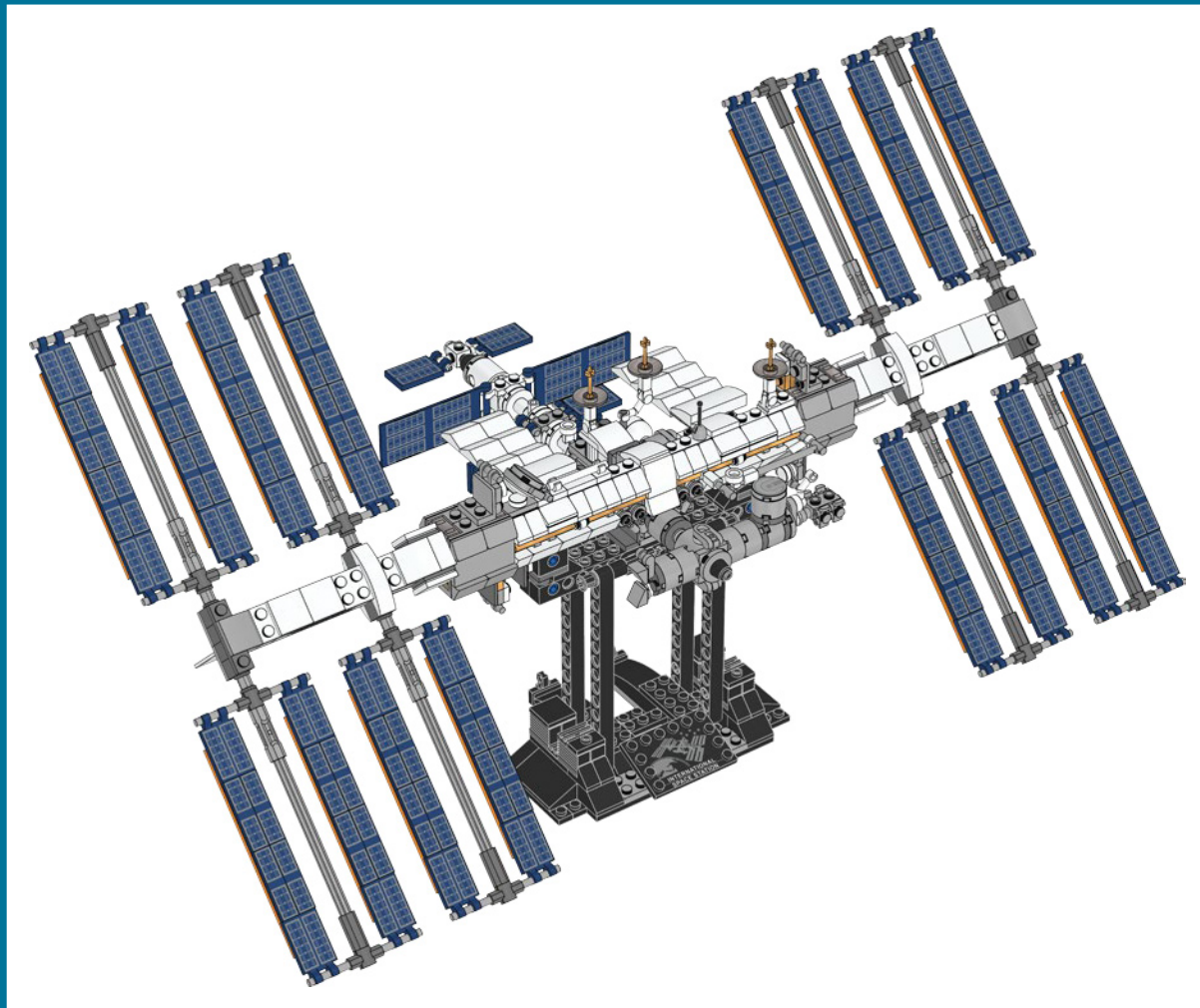

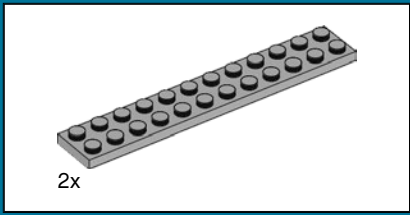

1

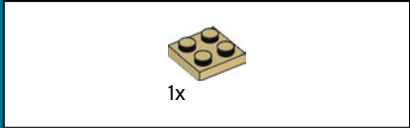
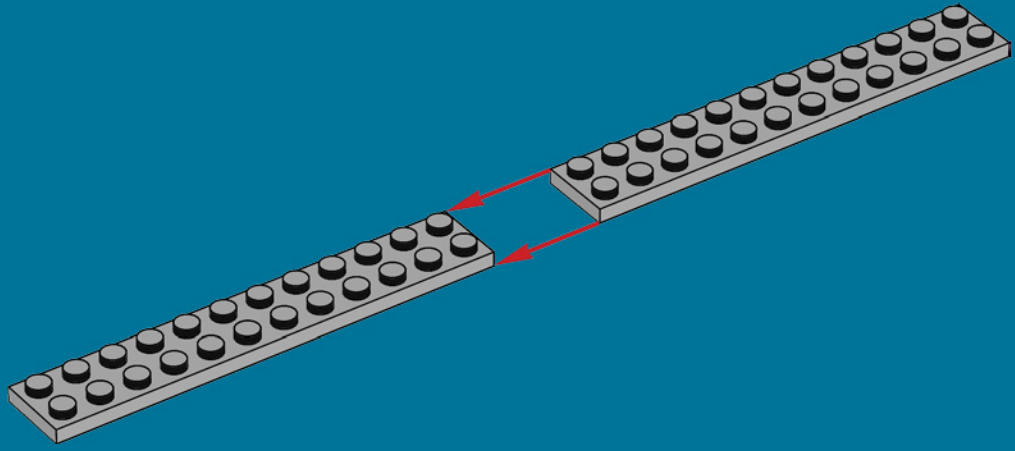

2

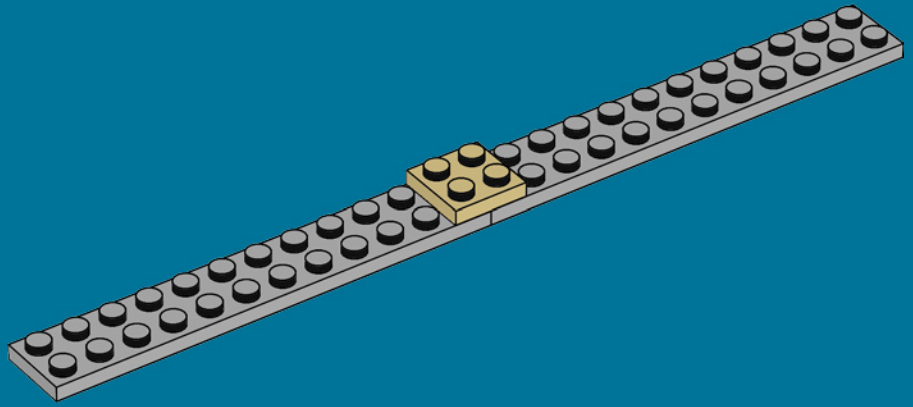

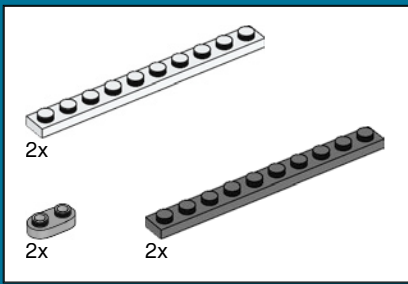

3

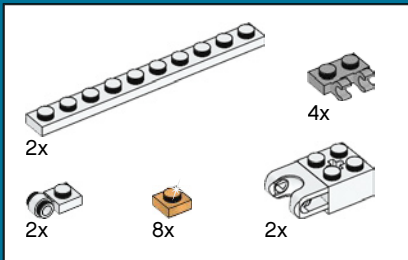
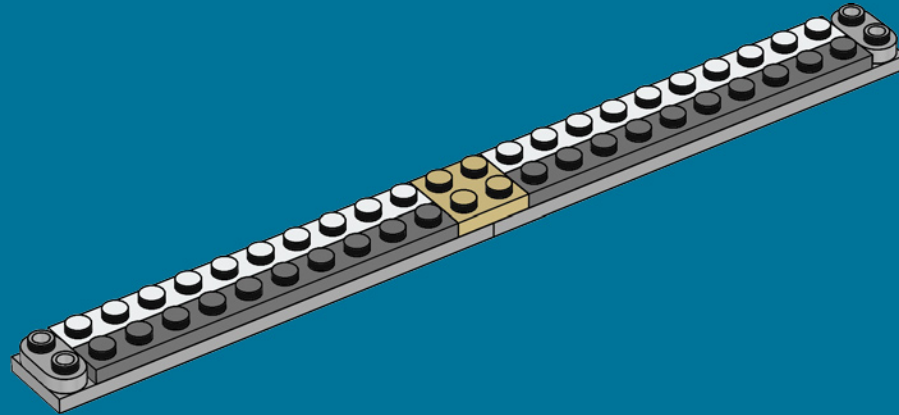

4

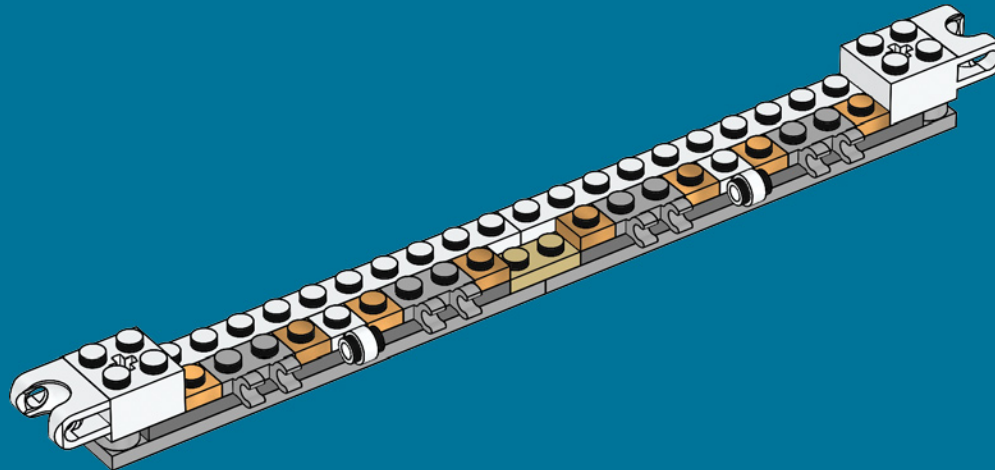

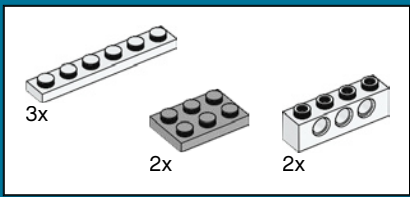

5

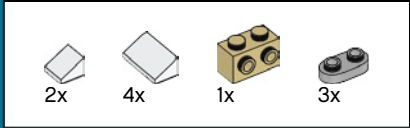
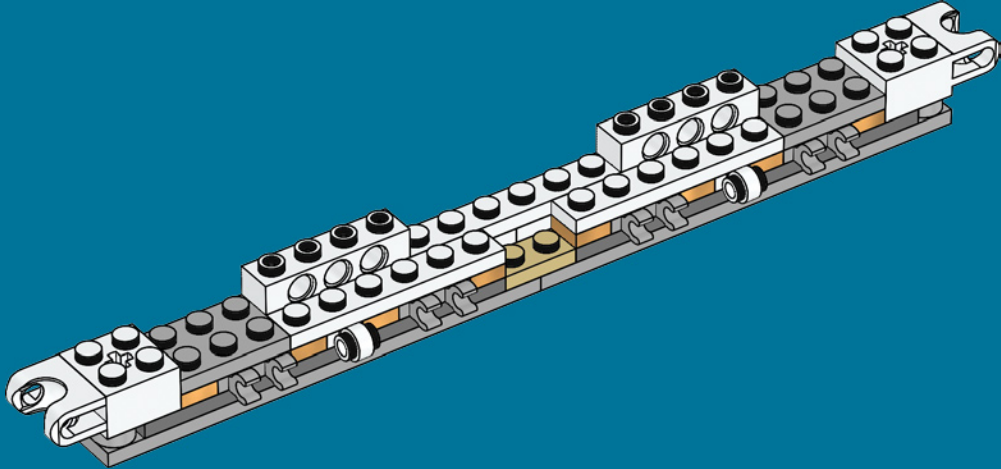

6

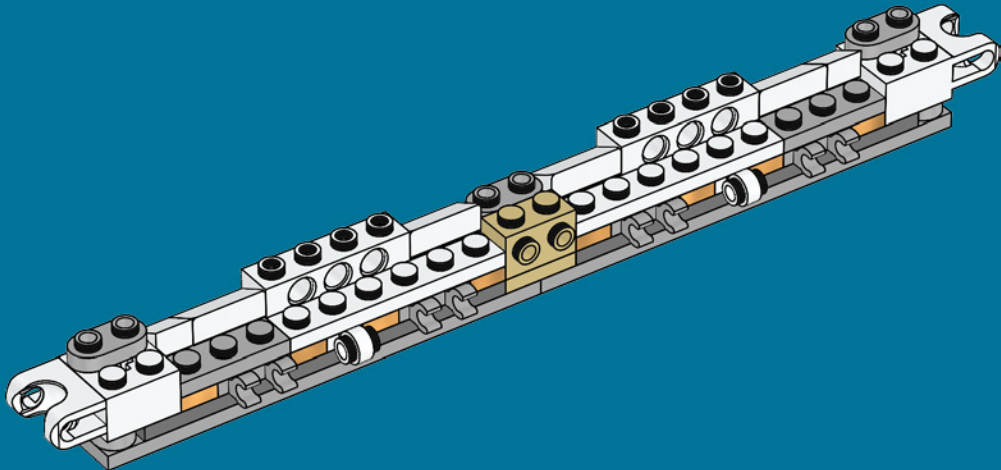

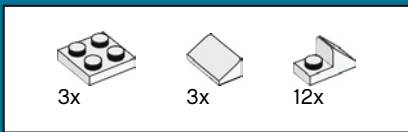

7

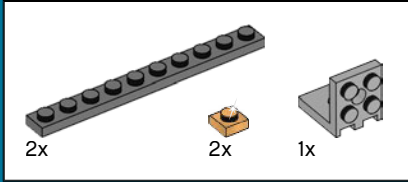
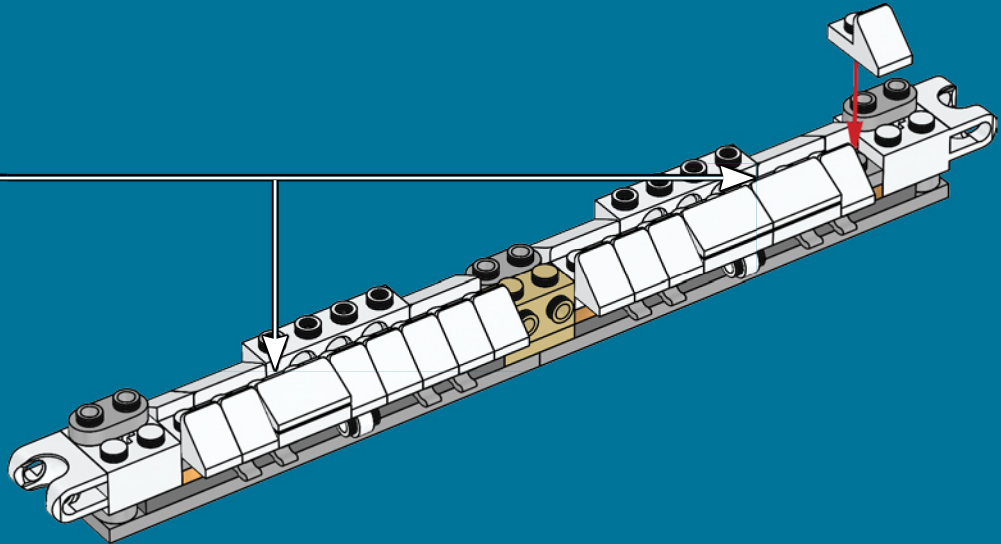
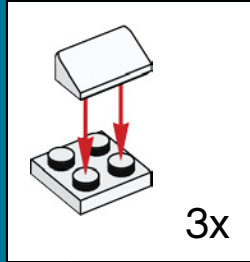

8

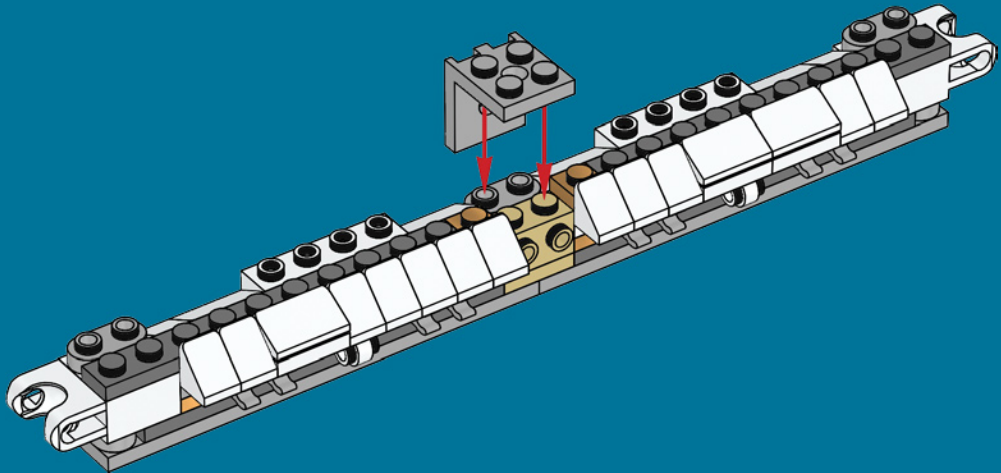

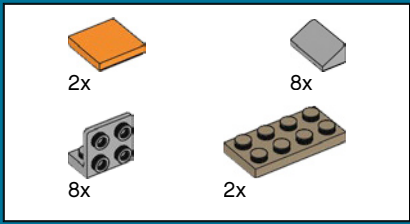

9

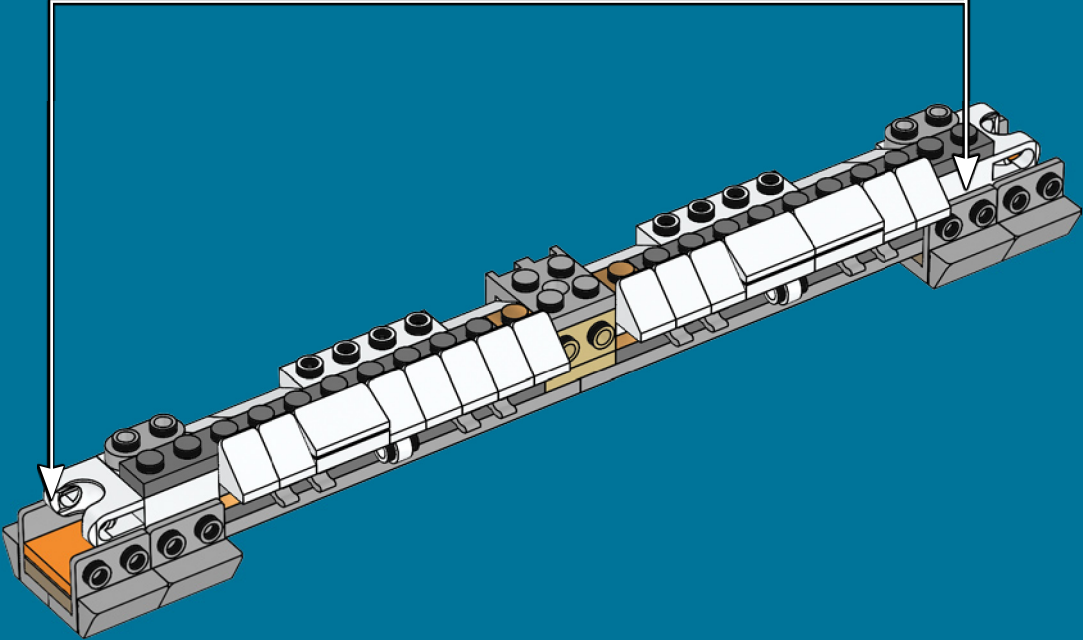
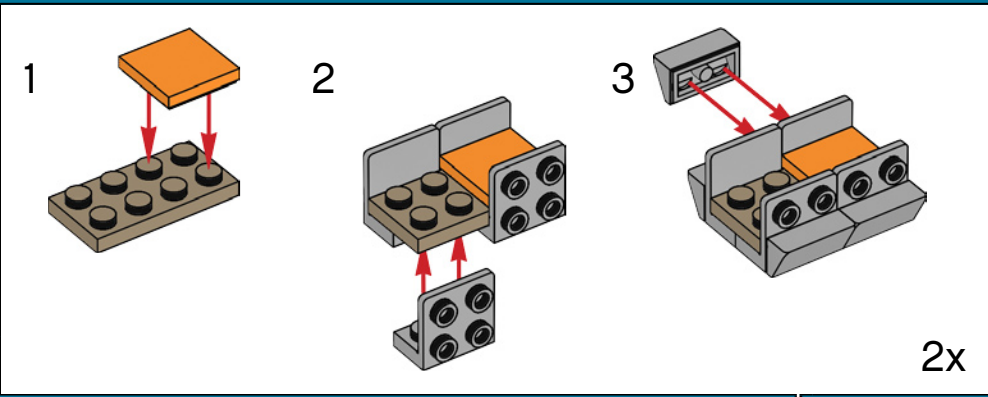

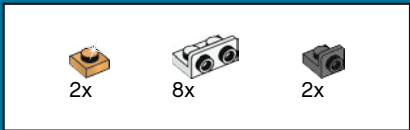

10

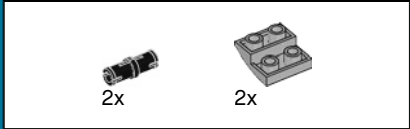
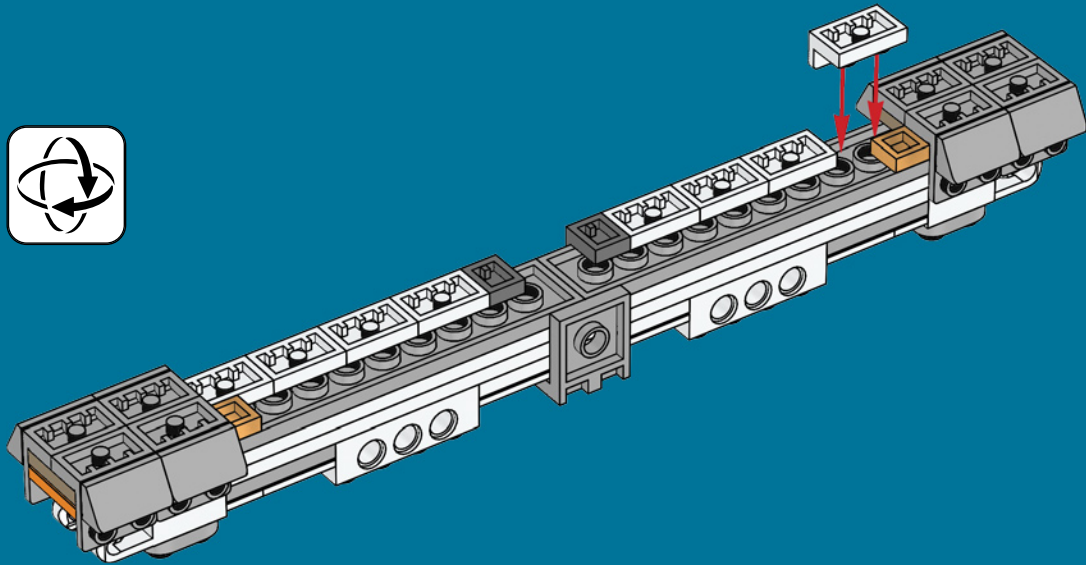

11

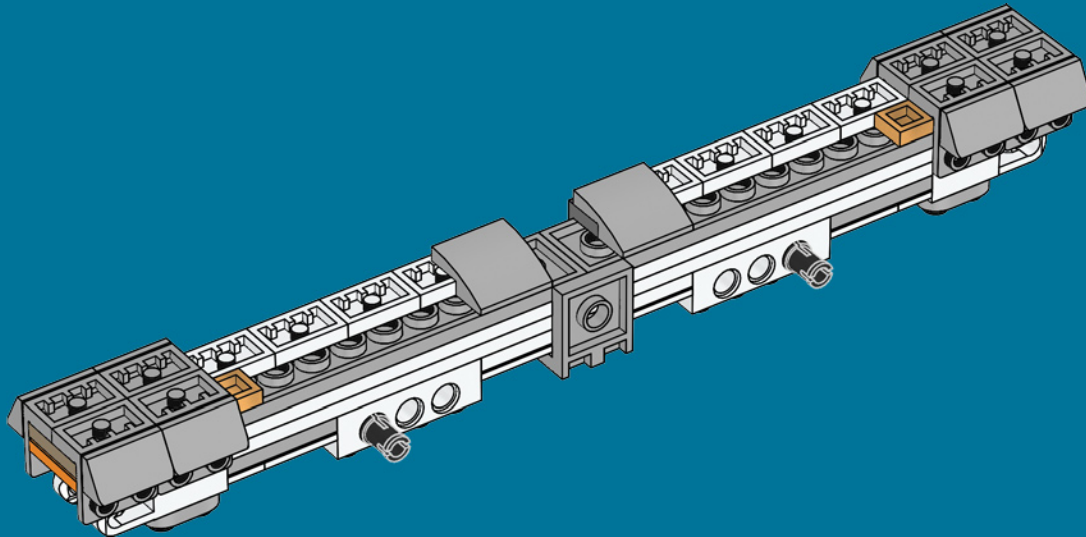

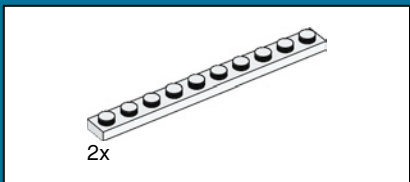

12

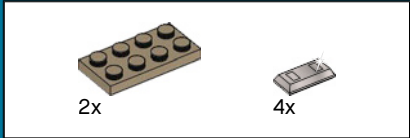
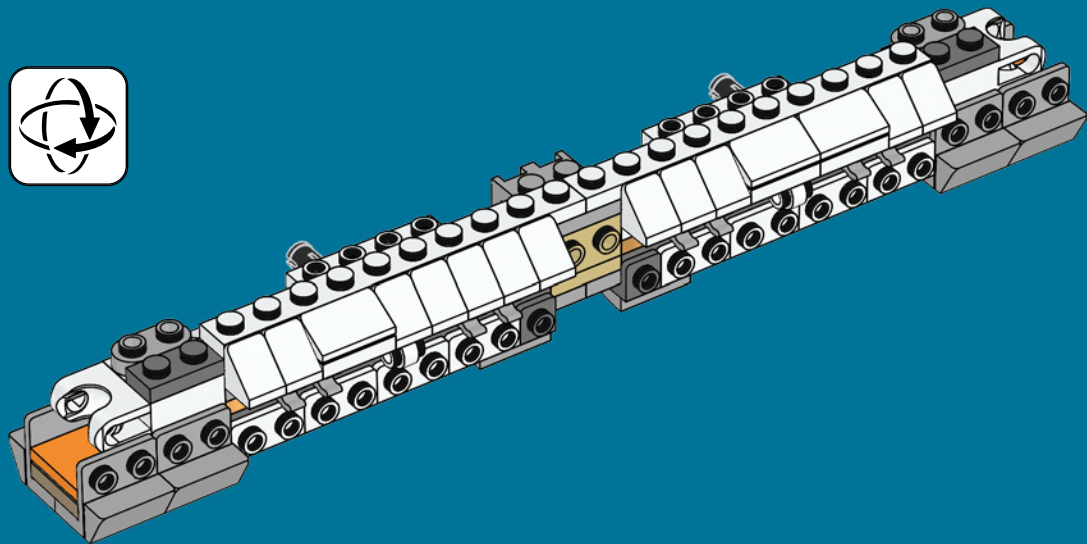

13

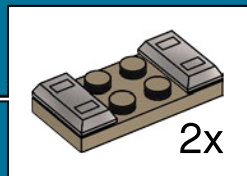
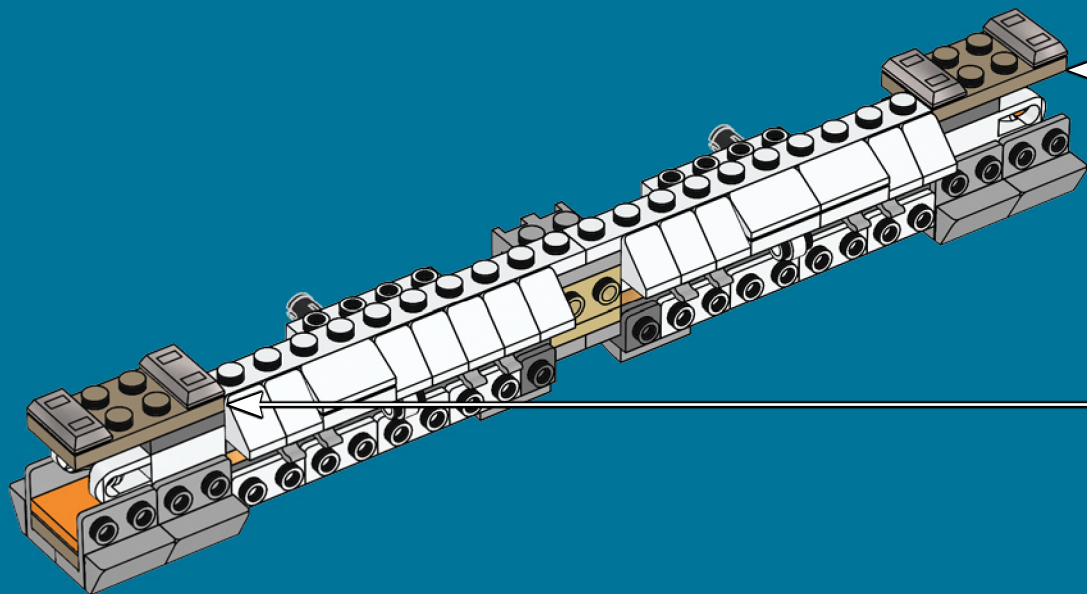

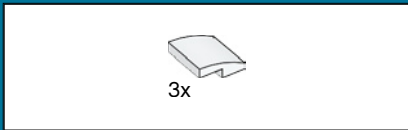

14

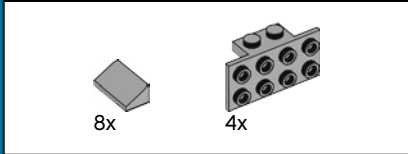
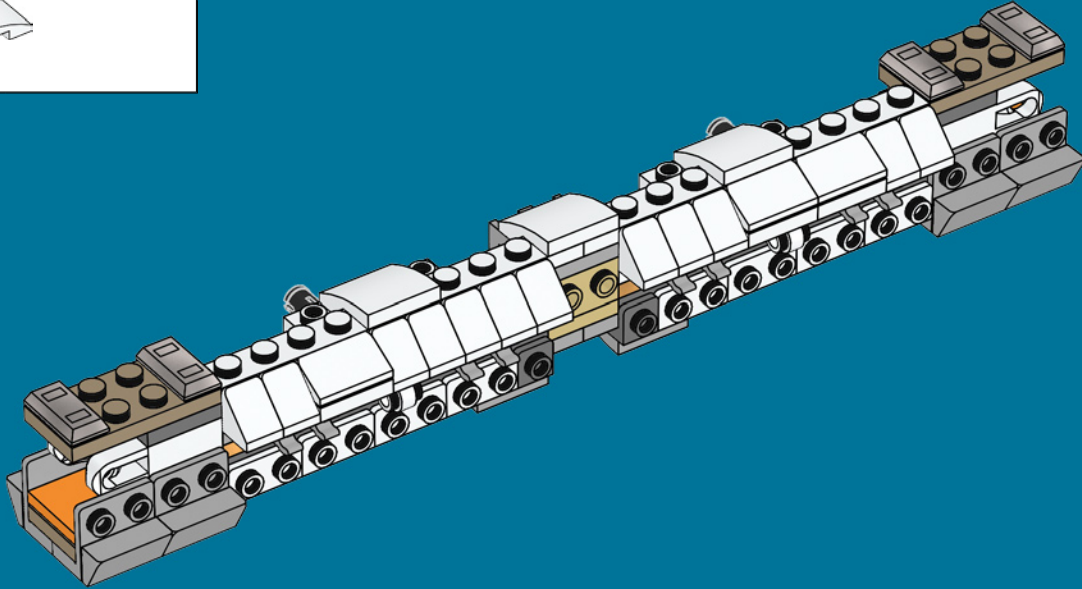

15

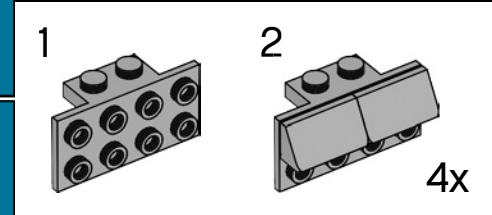
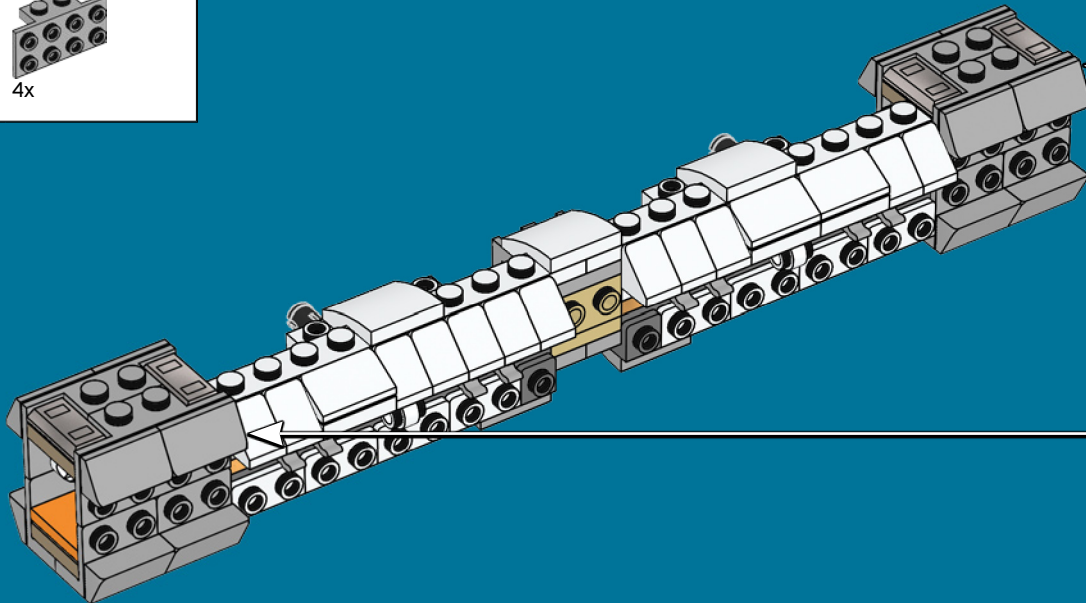

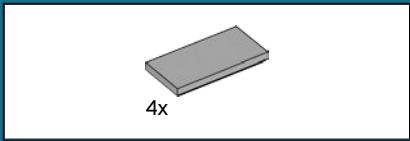

16

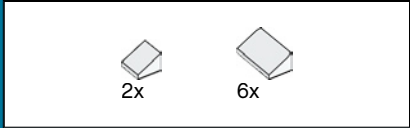
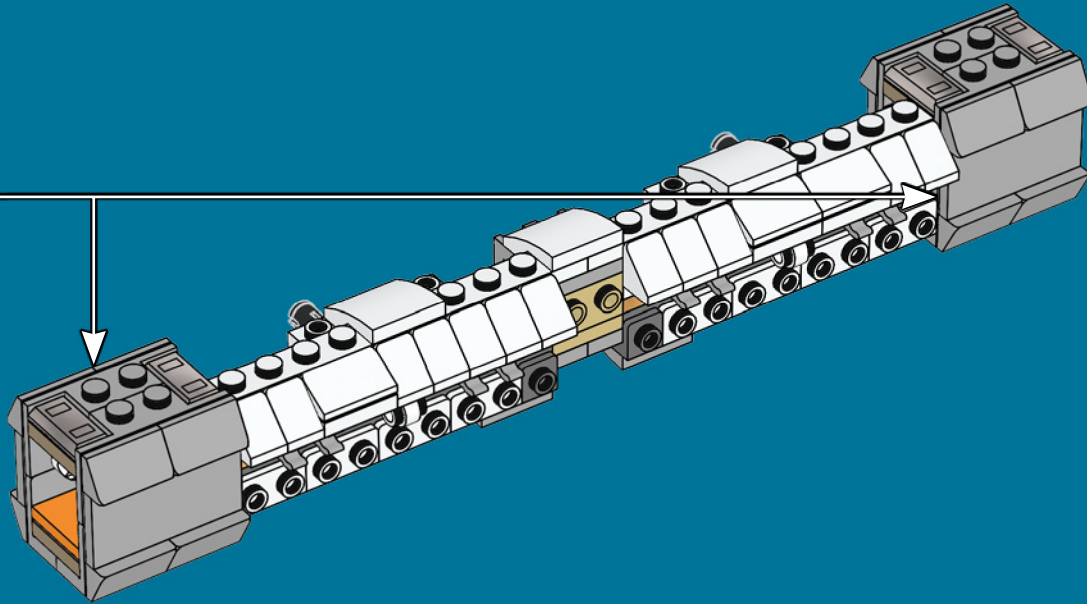
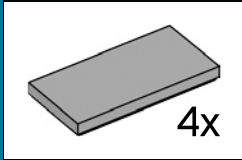

17

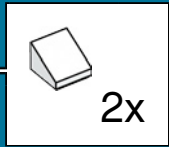
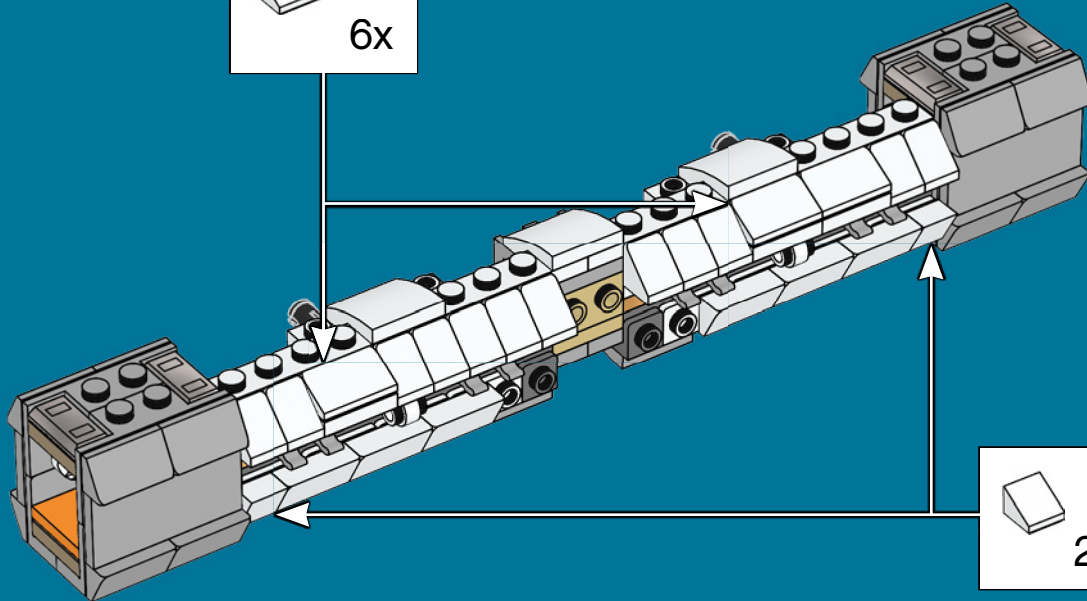
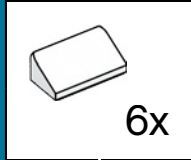



18

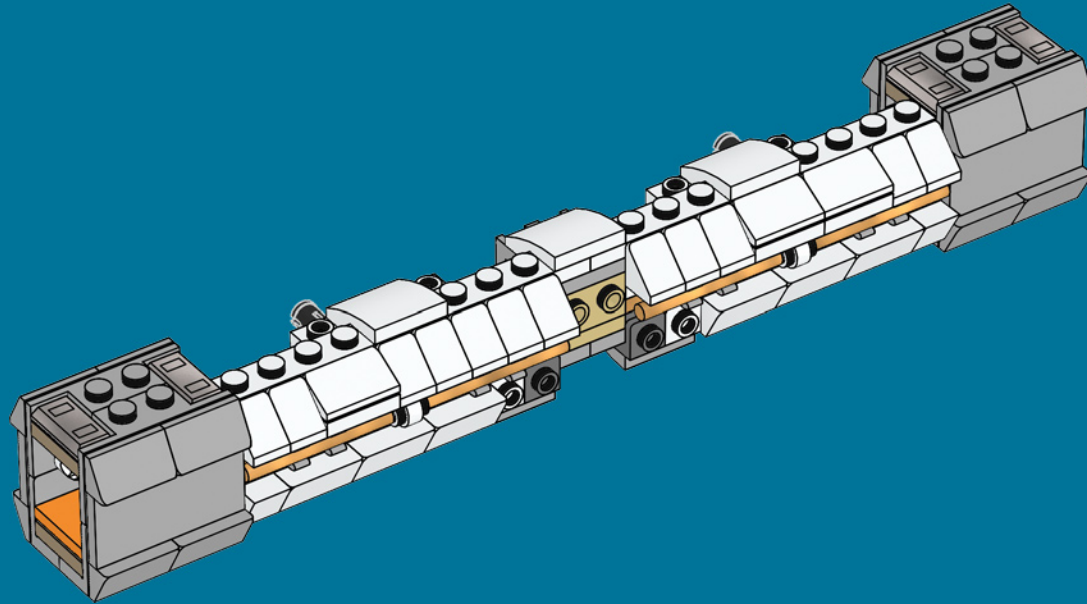

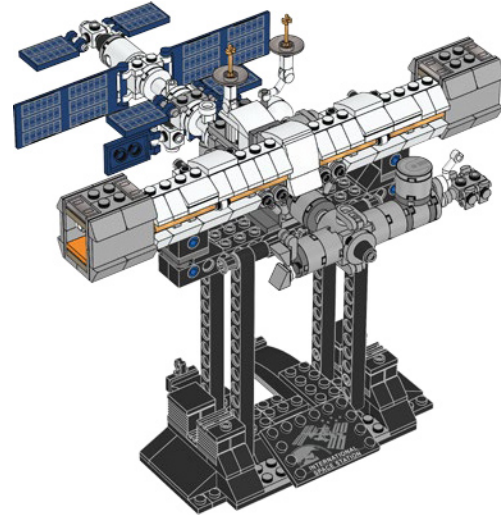
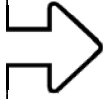

4x

19

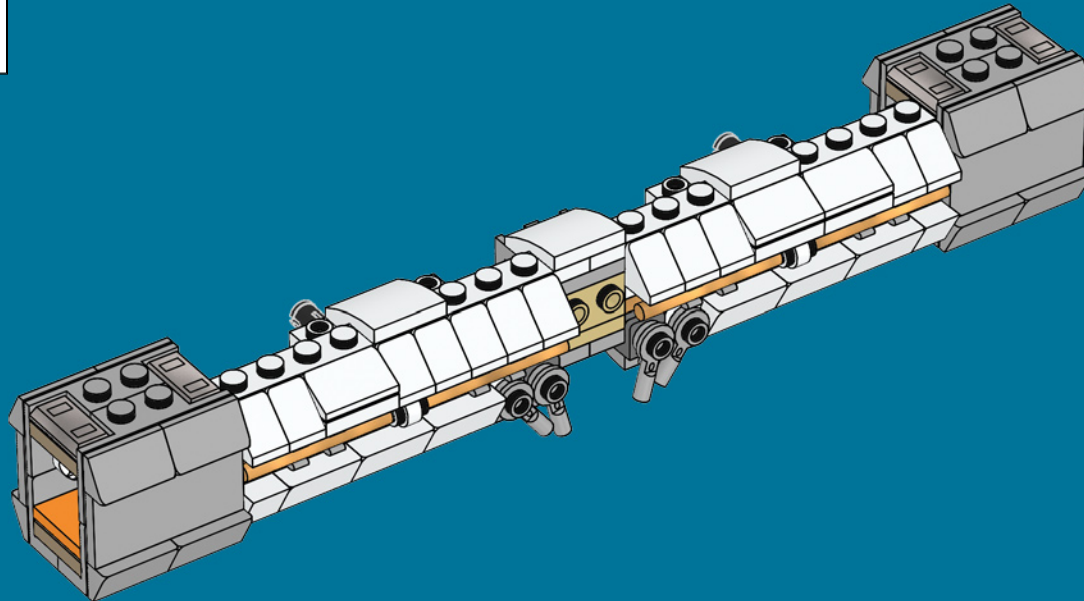

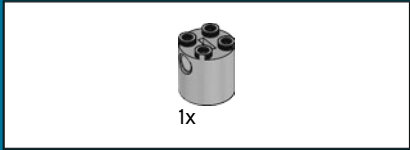
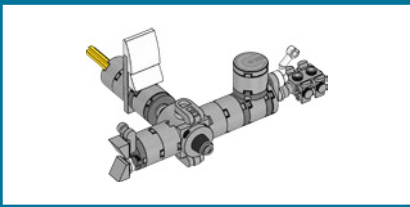

20

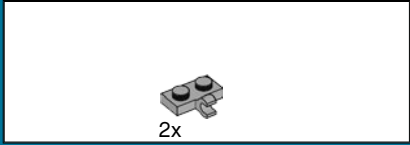

21

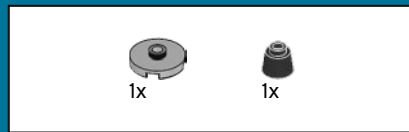
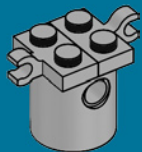

22

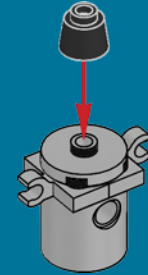

23

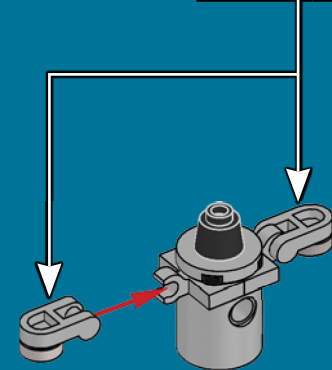
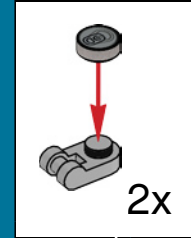

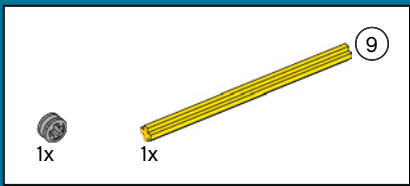

24

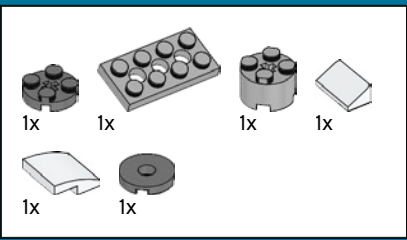
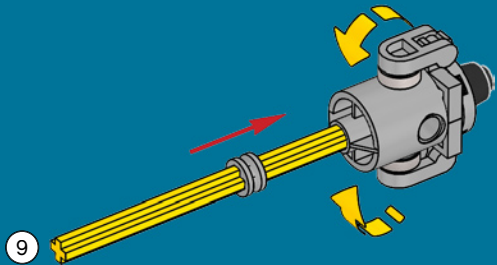

25

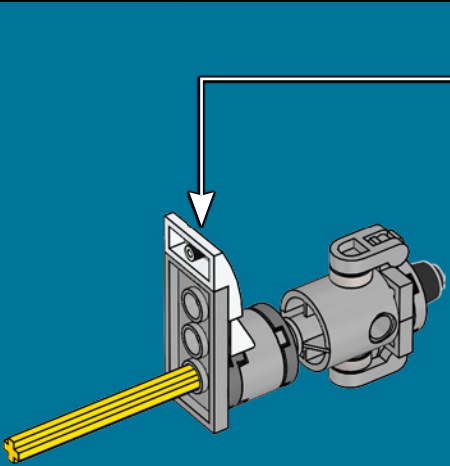
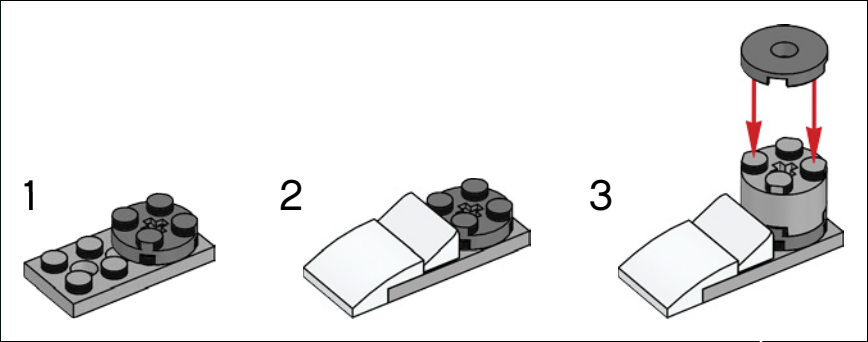



2x

26

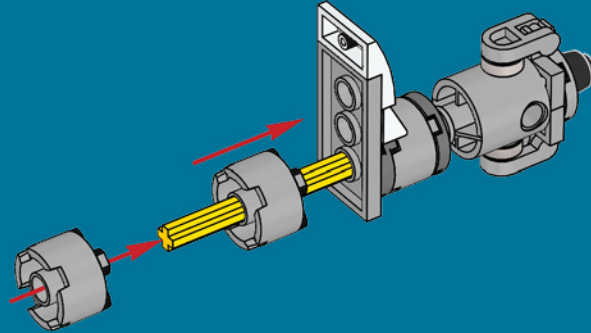

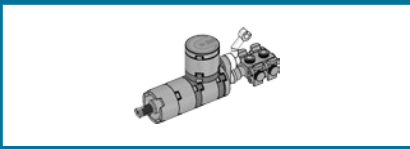

27

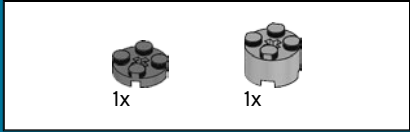
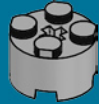

28

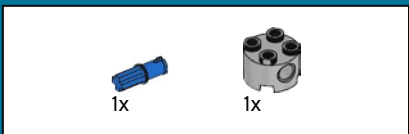
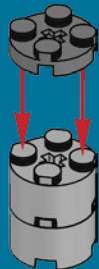

29

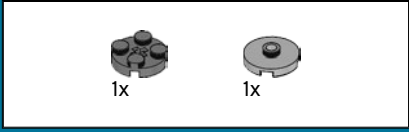
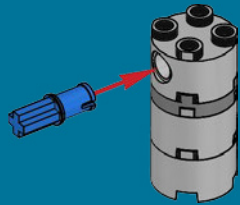

30

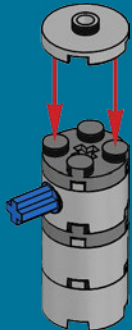

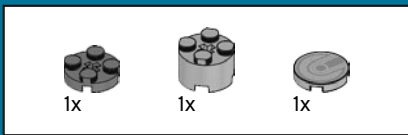

31

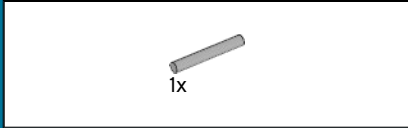
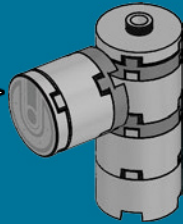
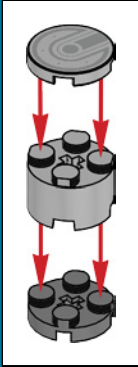

32

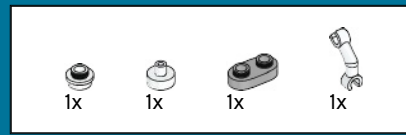
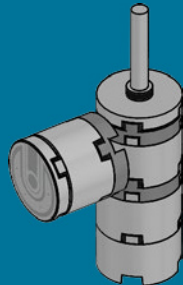

33

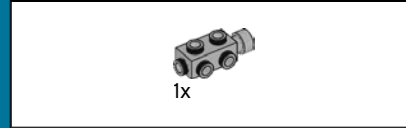
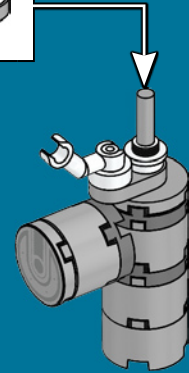

34





4x

35

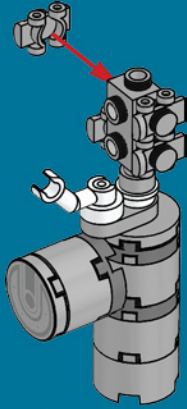

1x

36

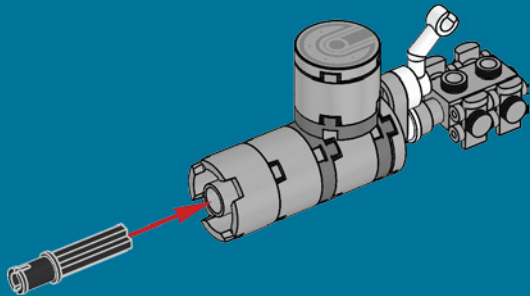

37

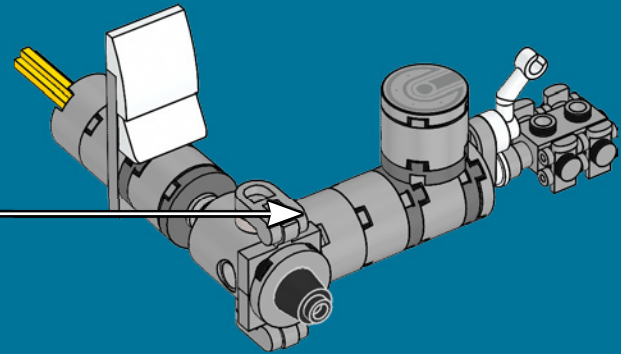

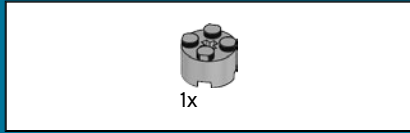
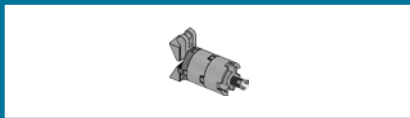

38

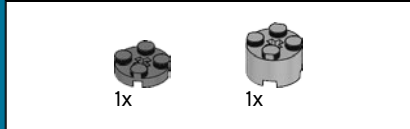
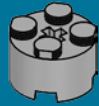

39

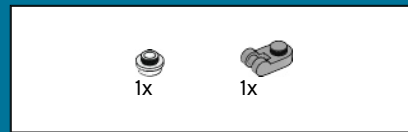
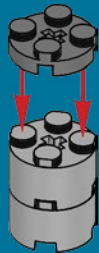

40

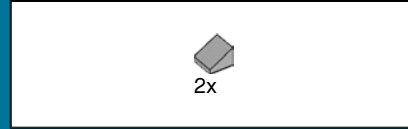
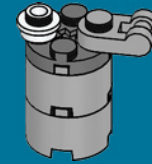

41





42

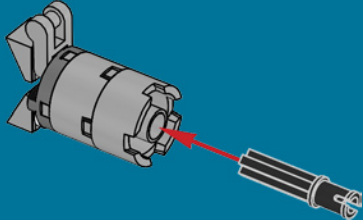

43

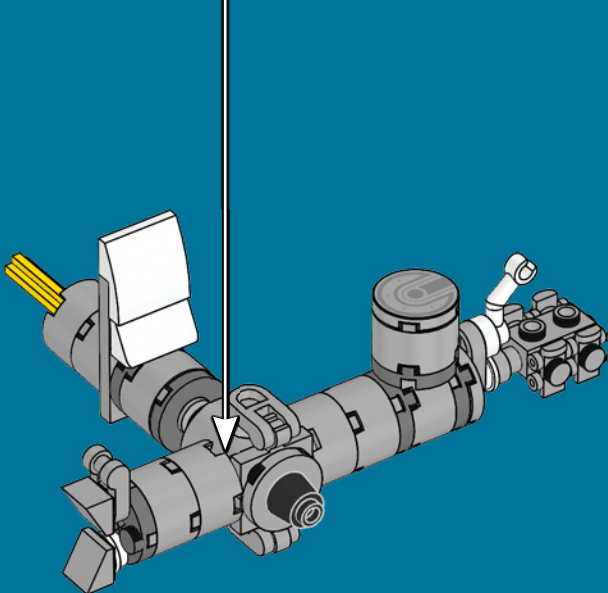

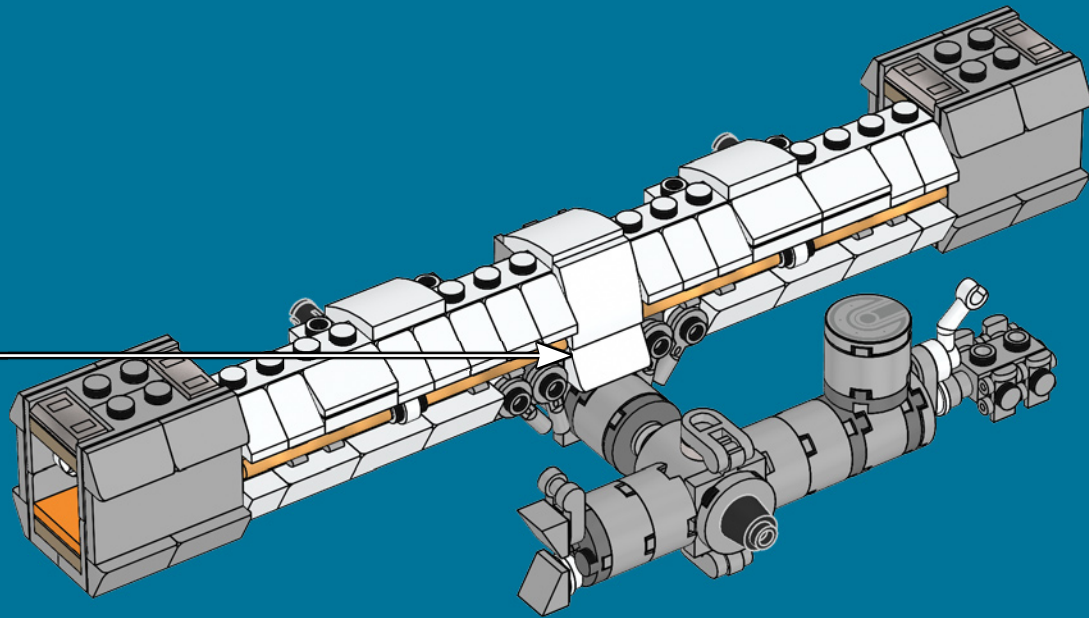

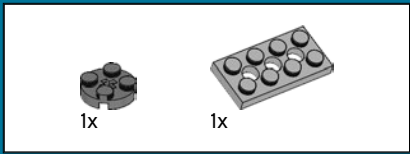

45

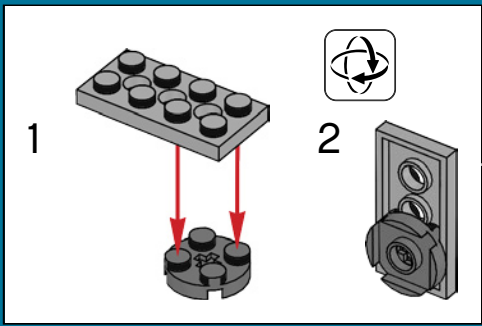
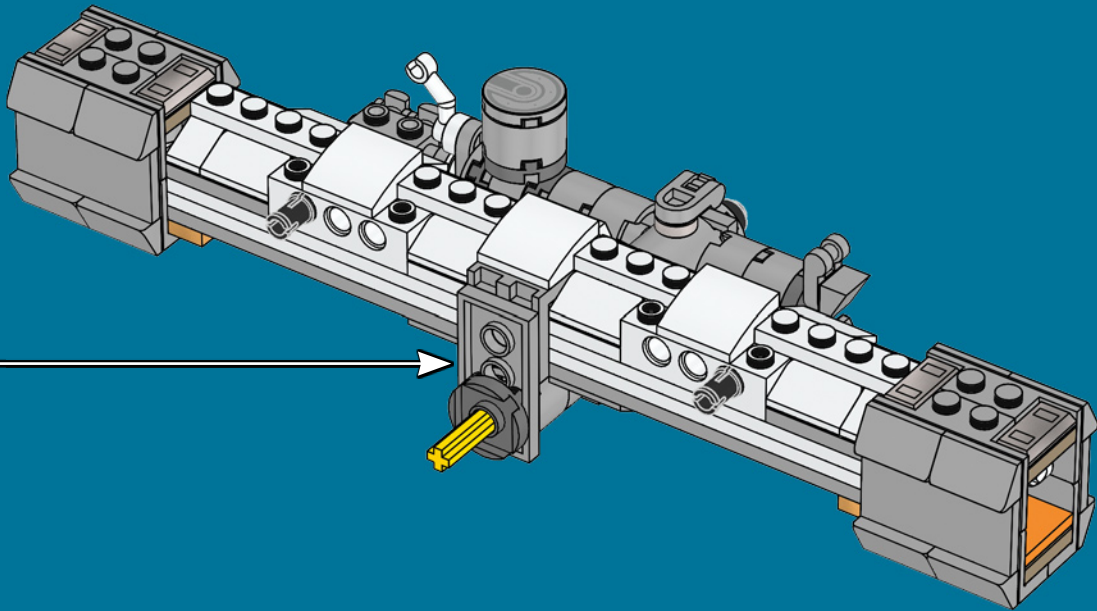

46

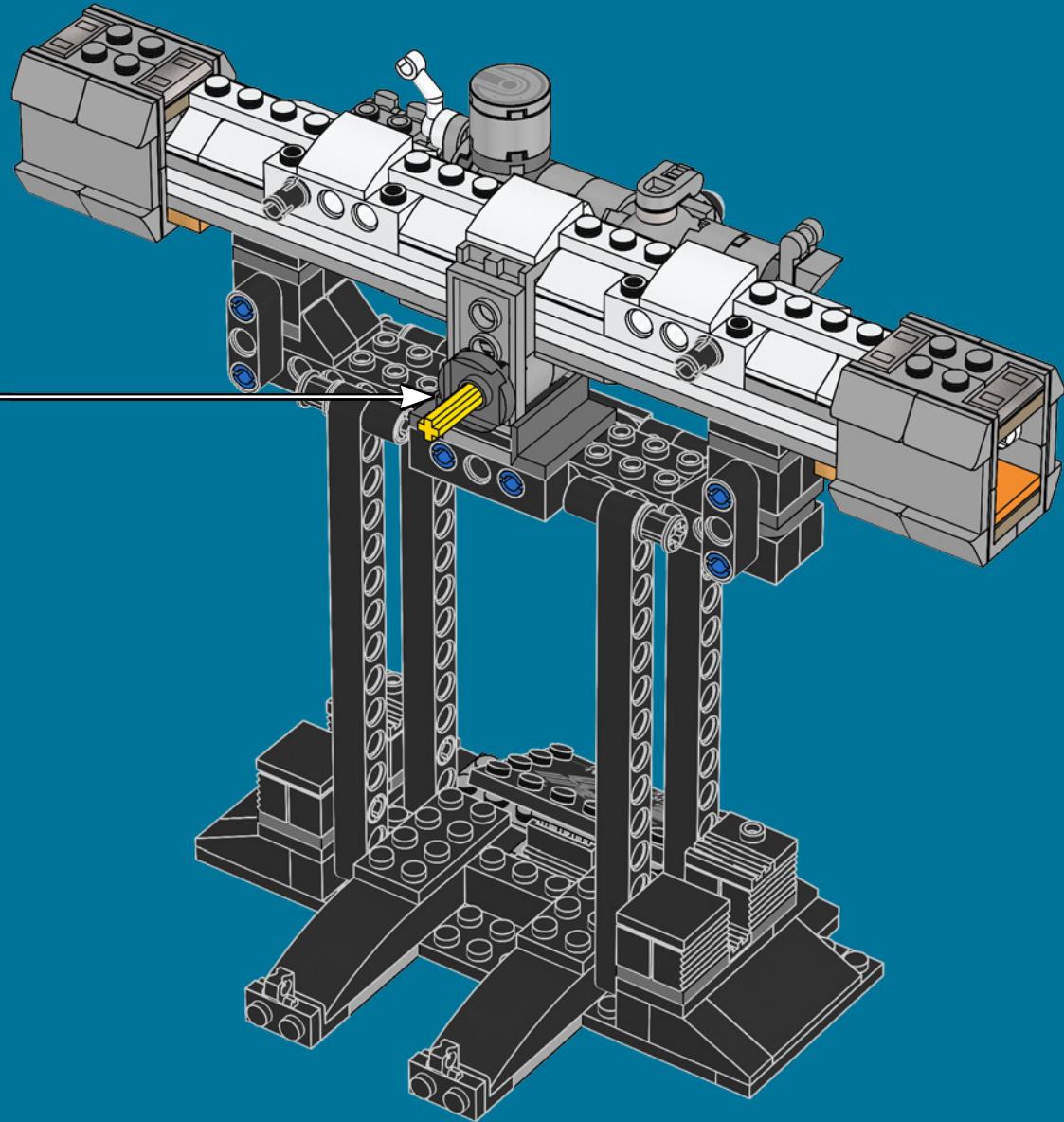

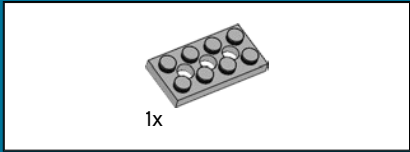
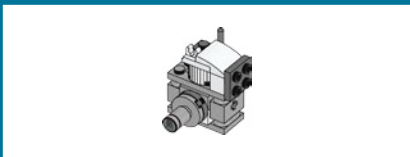

1x

47

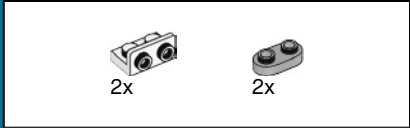
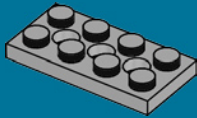

2x

2x

48

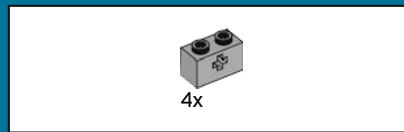
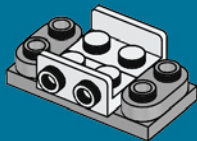

4x

49

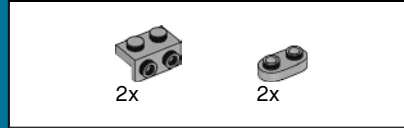
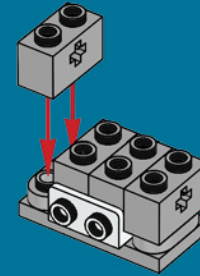

2x

2x

50

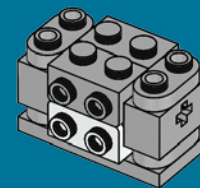

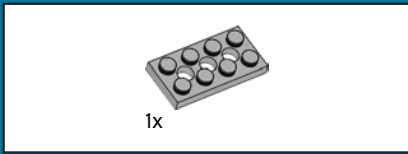

51

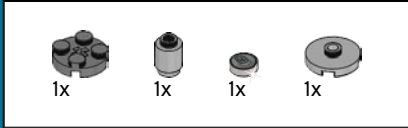
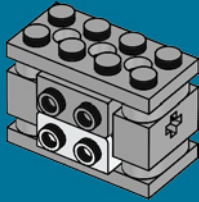

52

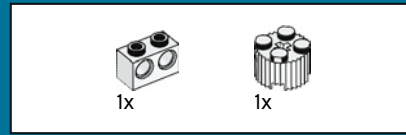
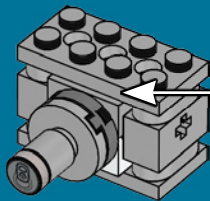
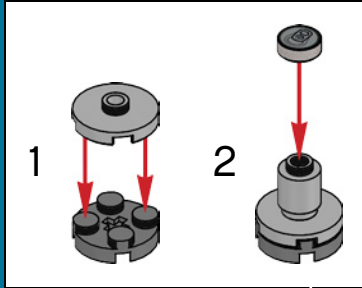

53

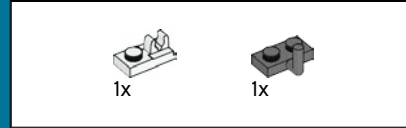
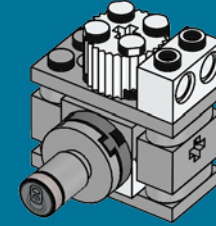

54

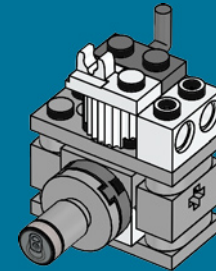

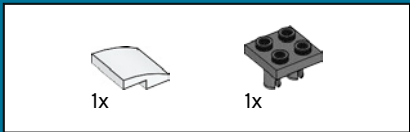

55

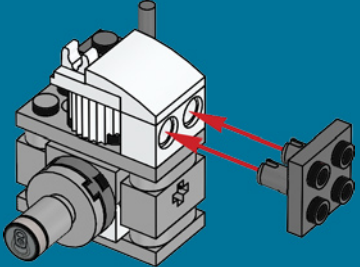

56

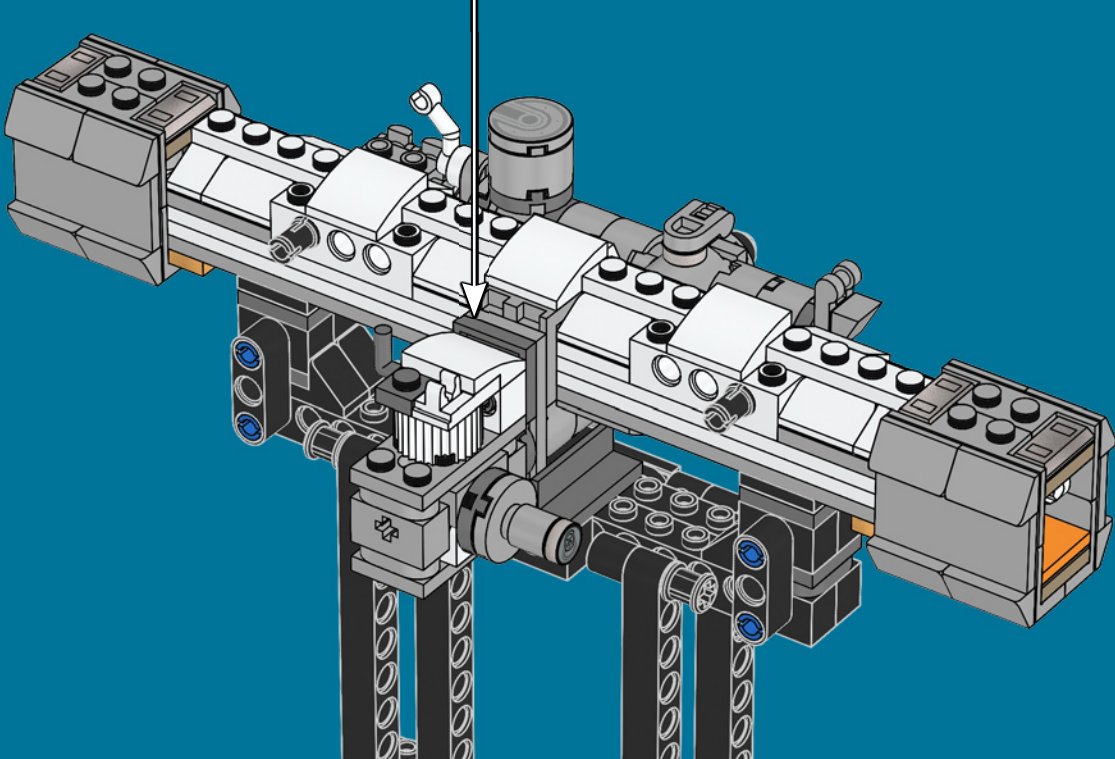

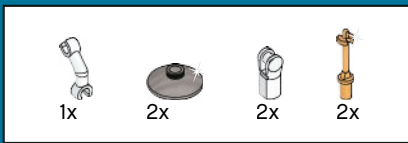

57

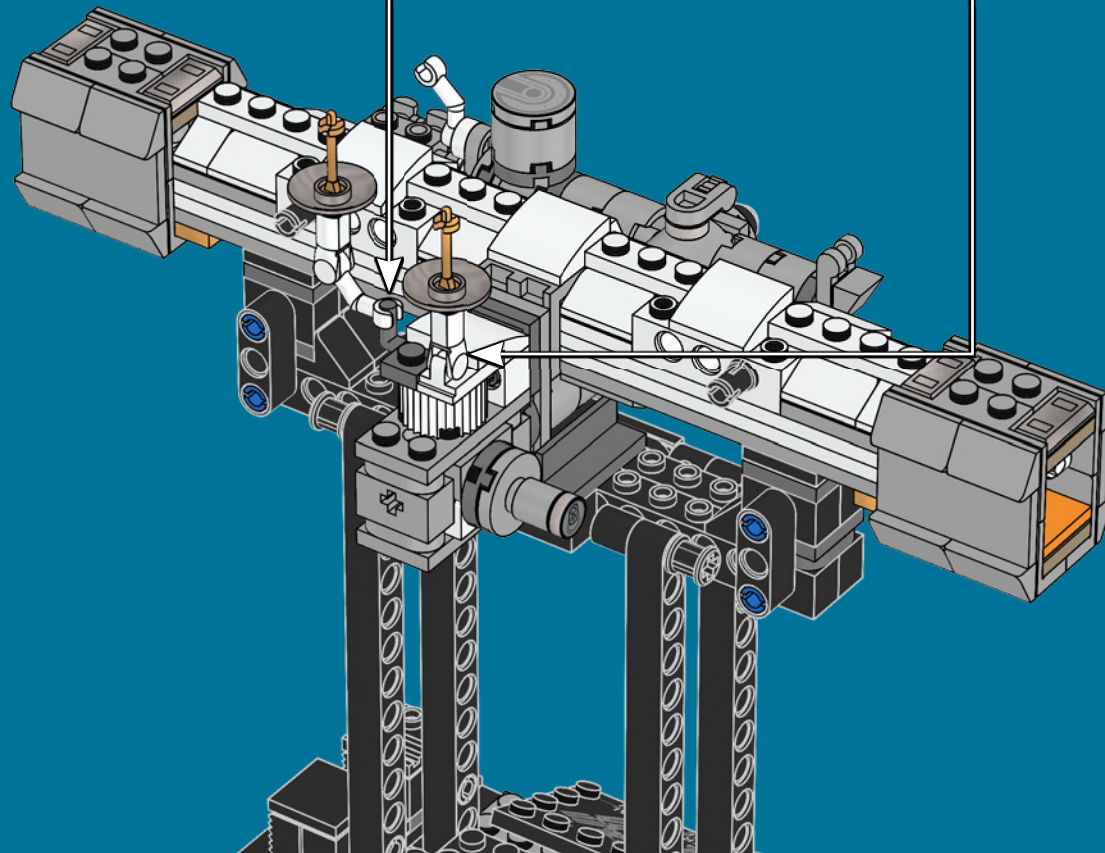
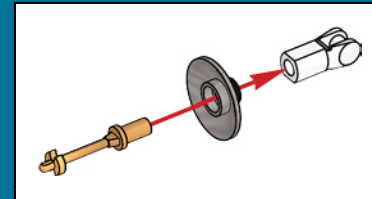
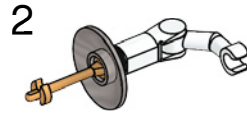
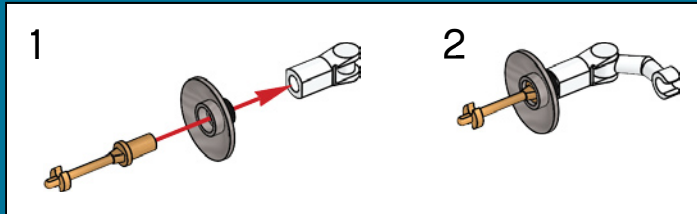

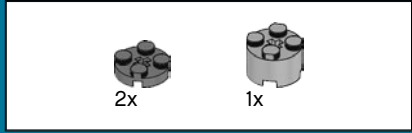

58

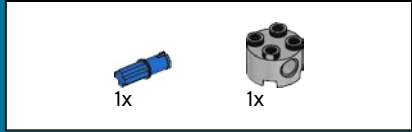
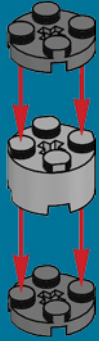

59

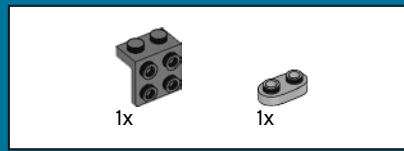
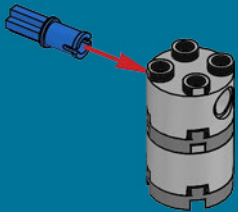

60

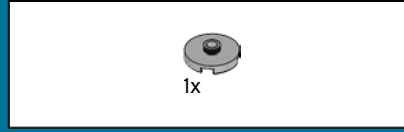
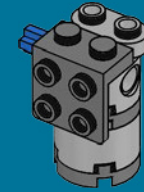

61

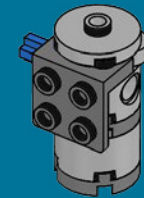

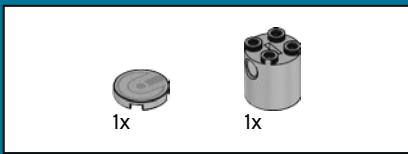

62

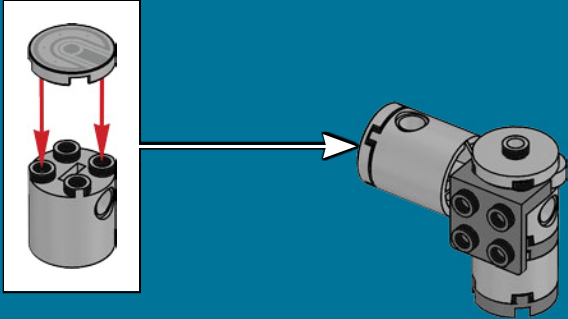

63

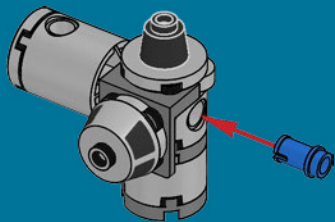

64

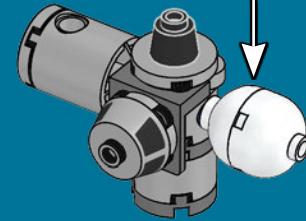
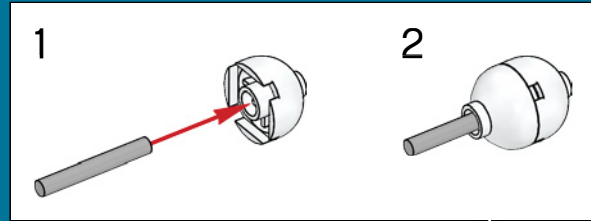

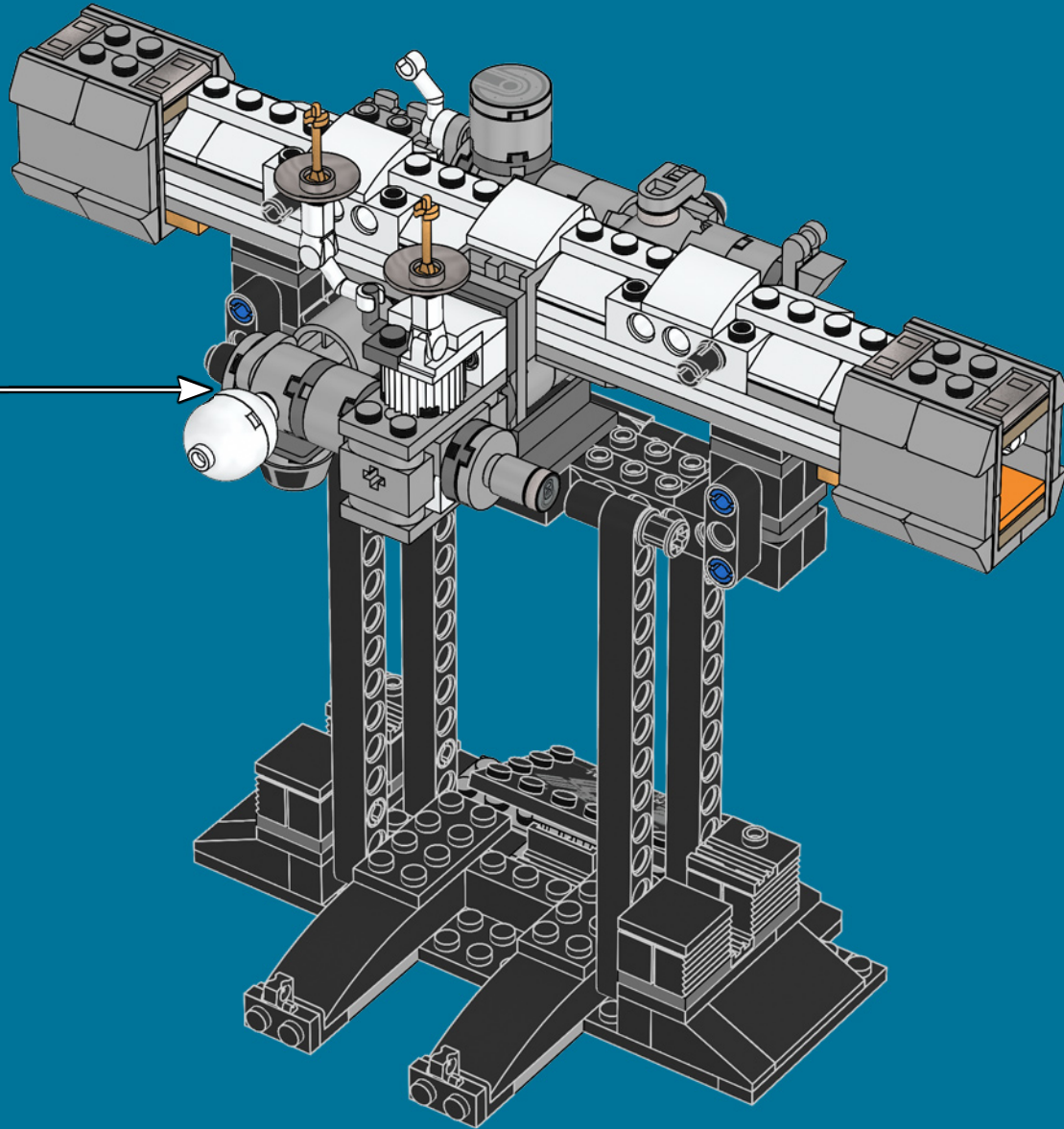

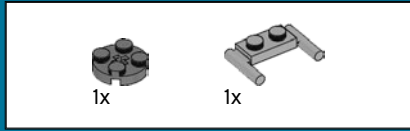

66

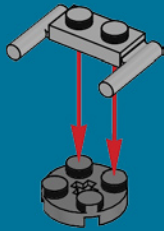

67

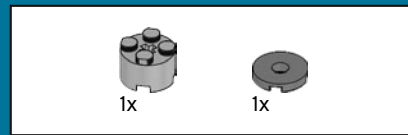

68

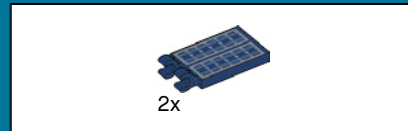
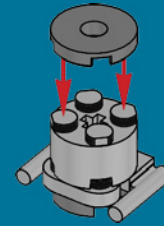

69

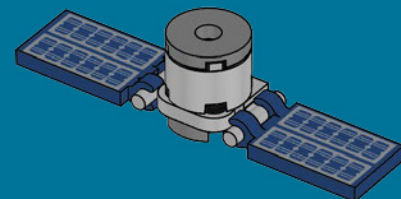

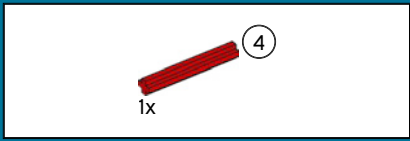

70

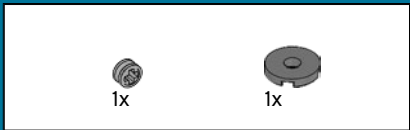
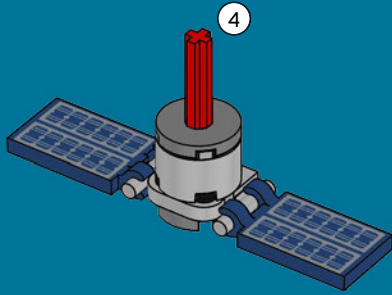

71

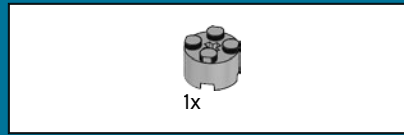
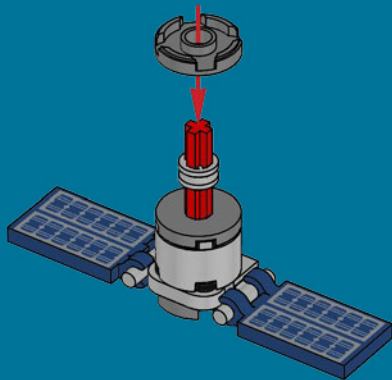

72

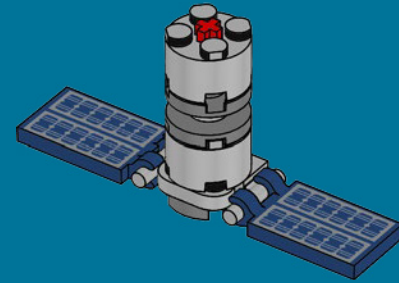

73

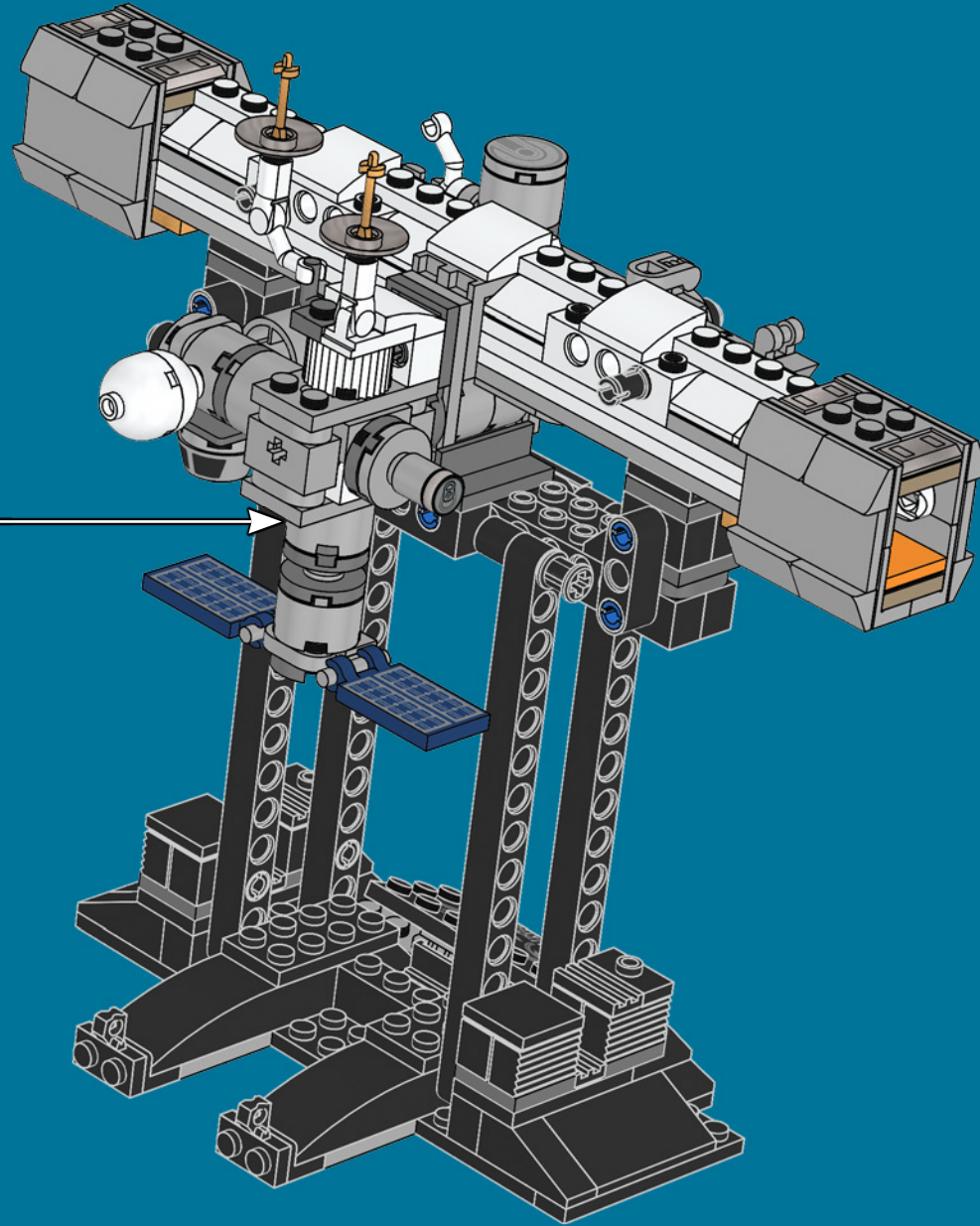

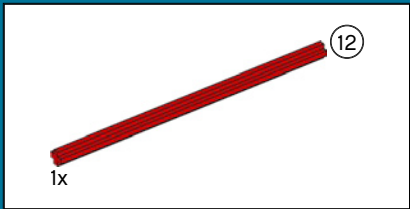

74

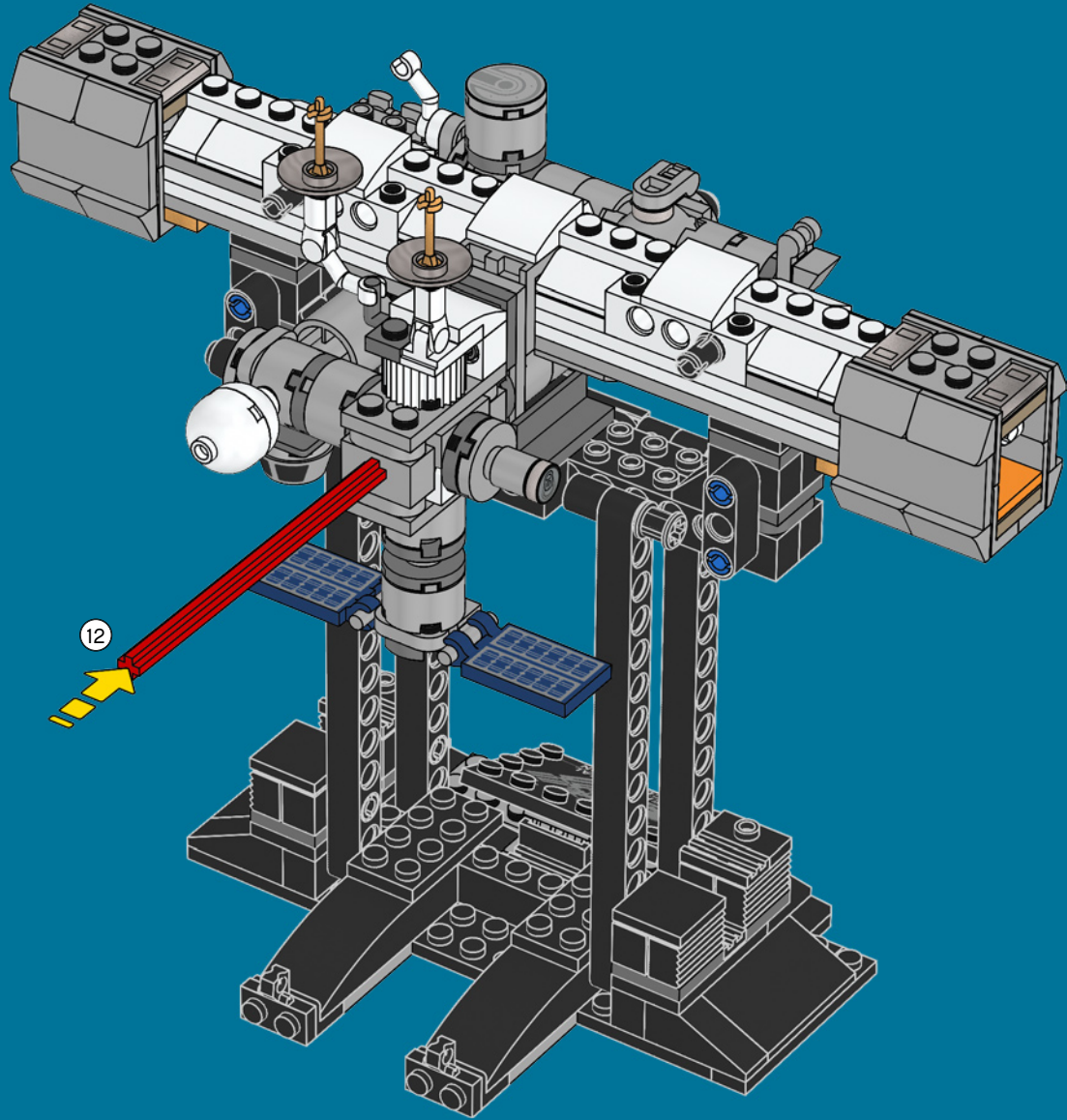

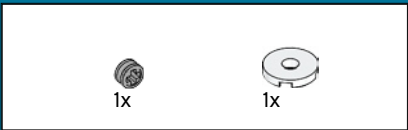

75

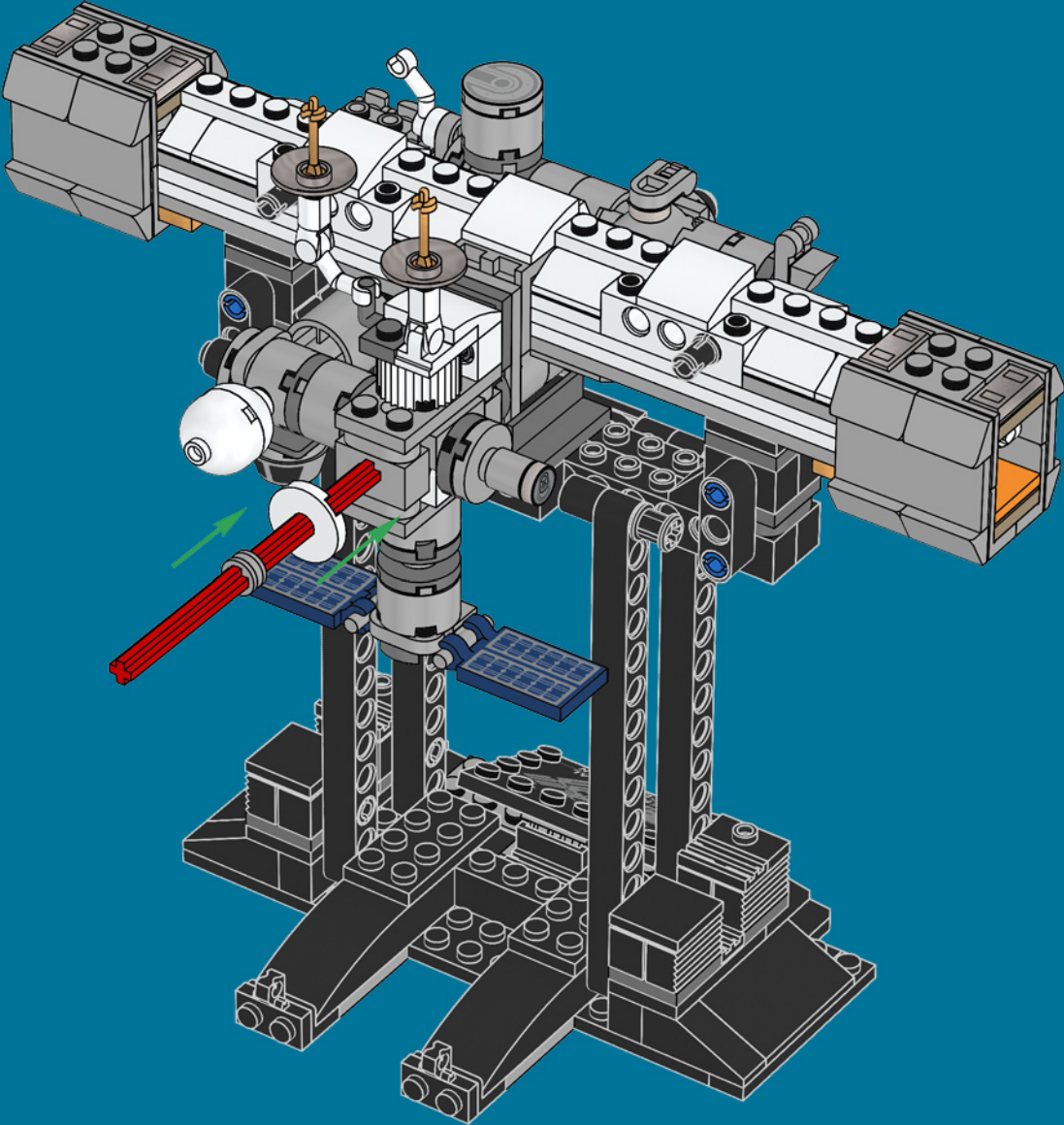

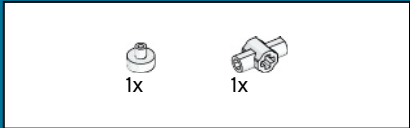

76

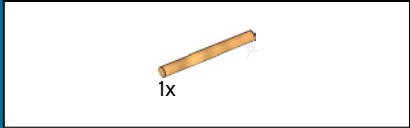
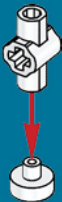

77



78



79





80

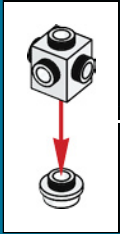

81

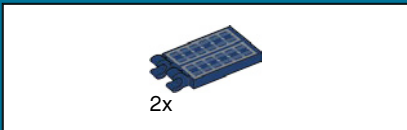

82

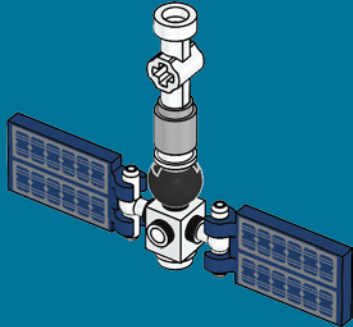

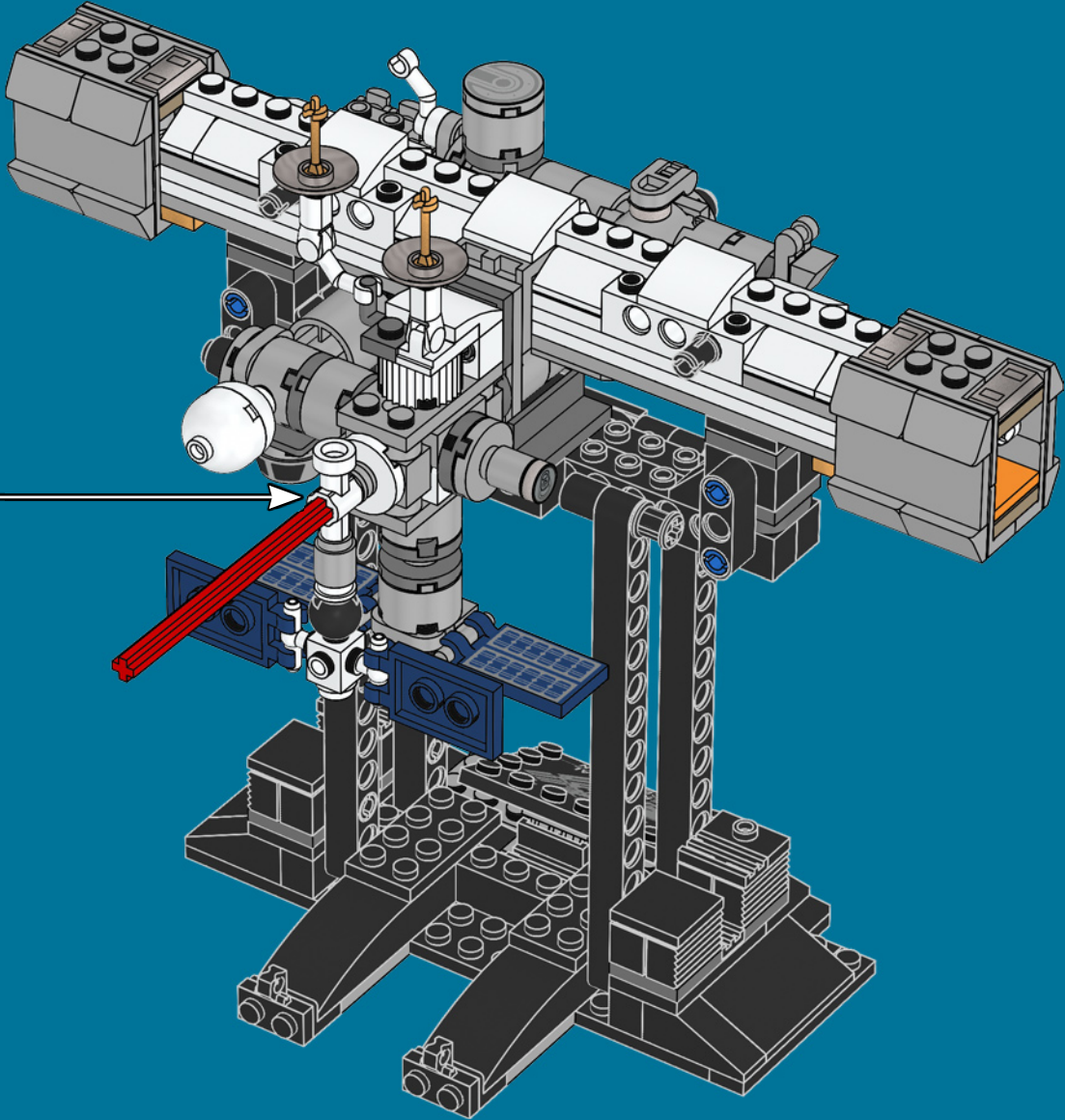



1x



1x

84

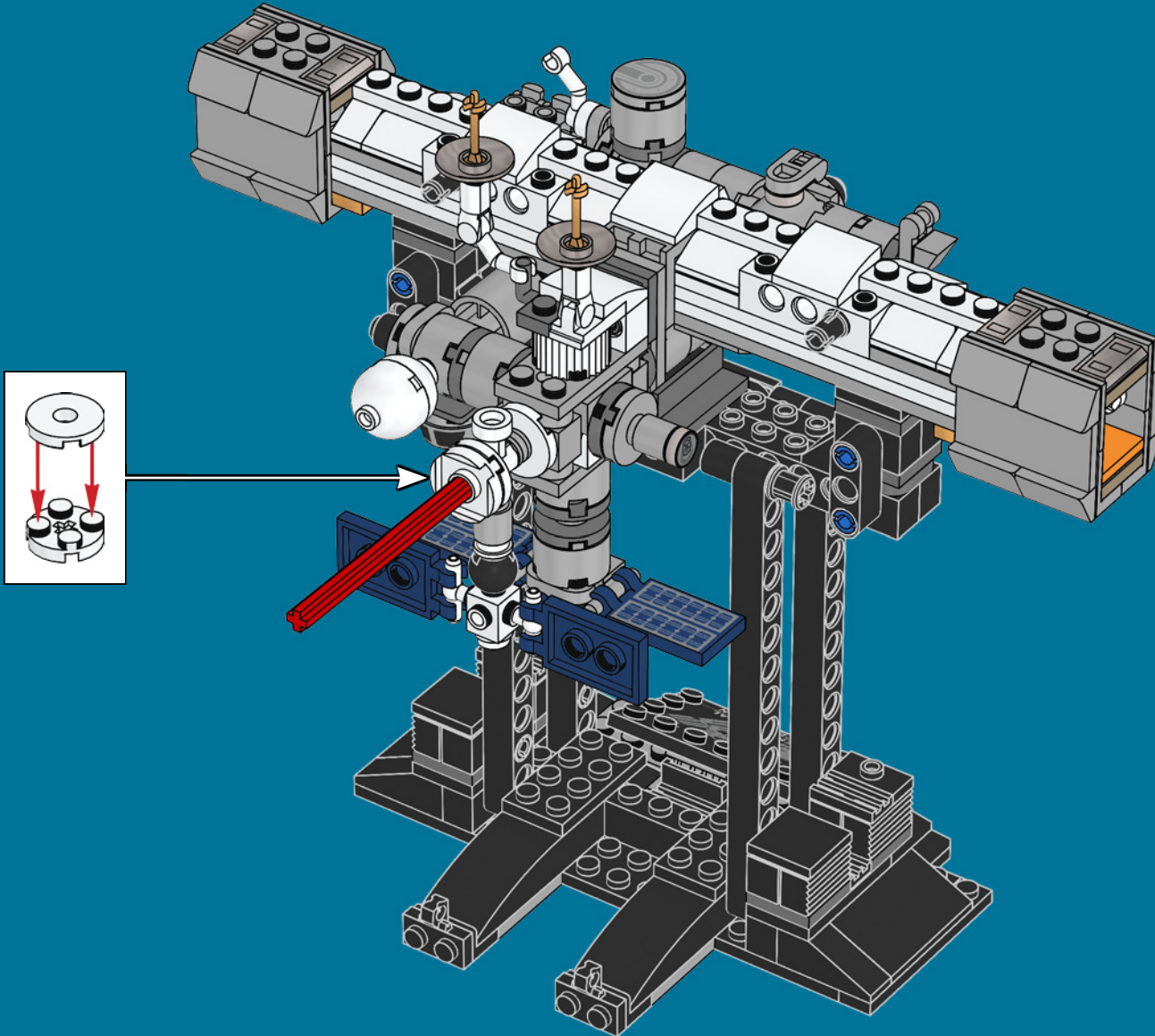

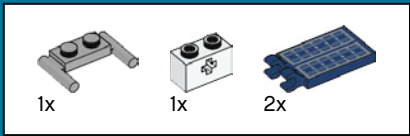

85

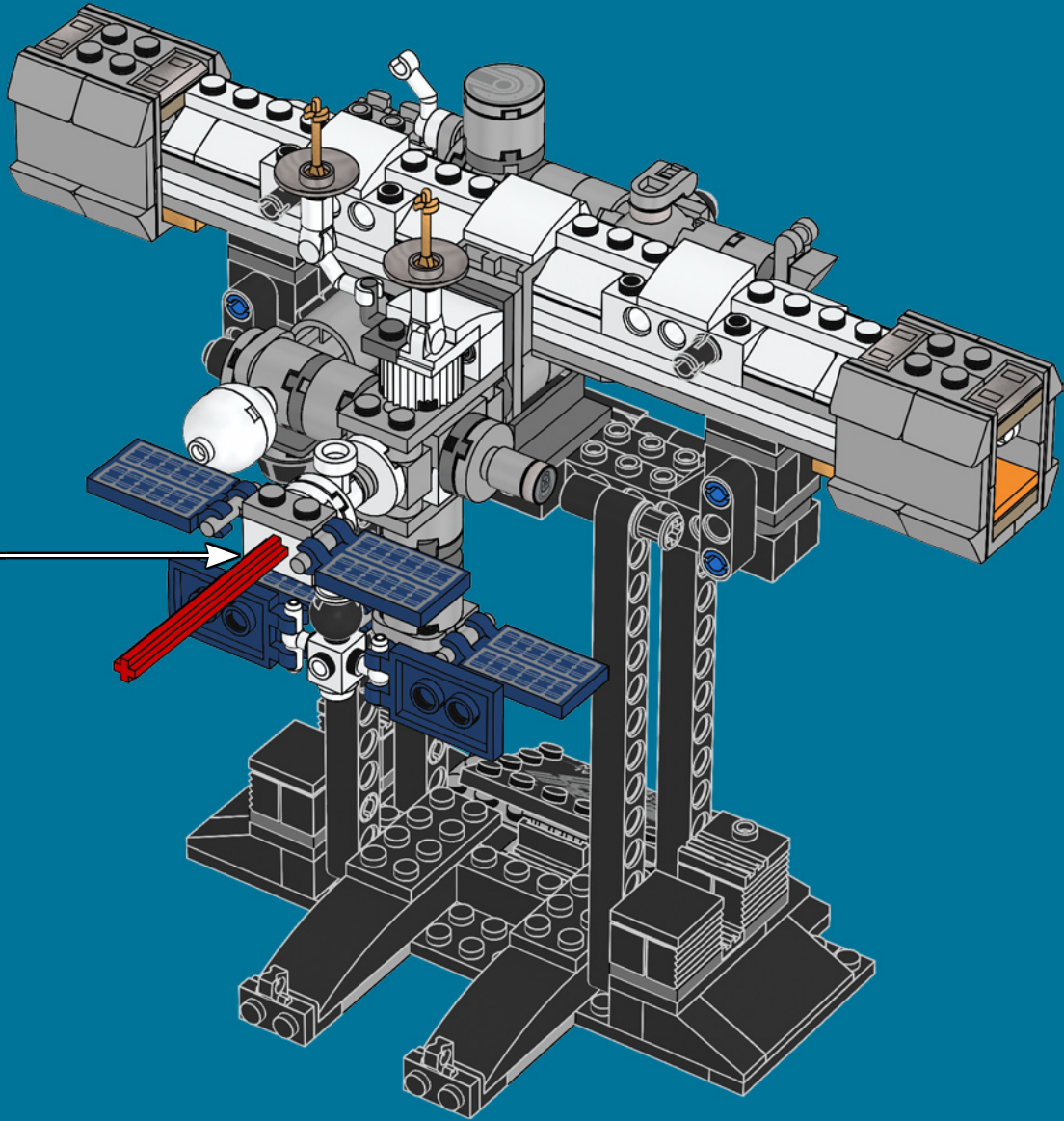
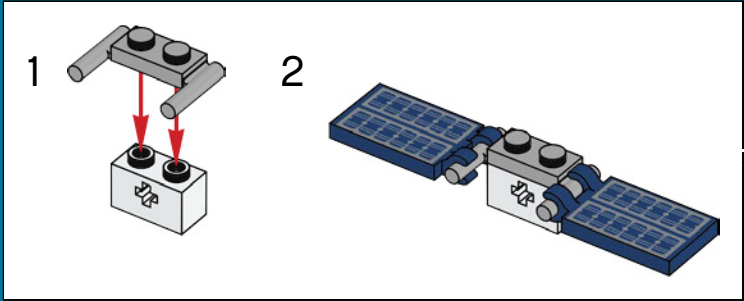



1x



1x

86

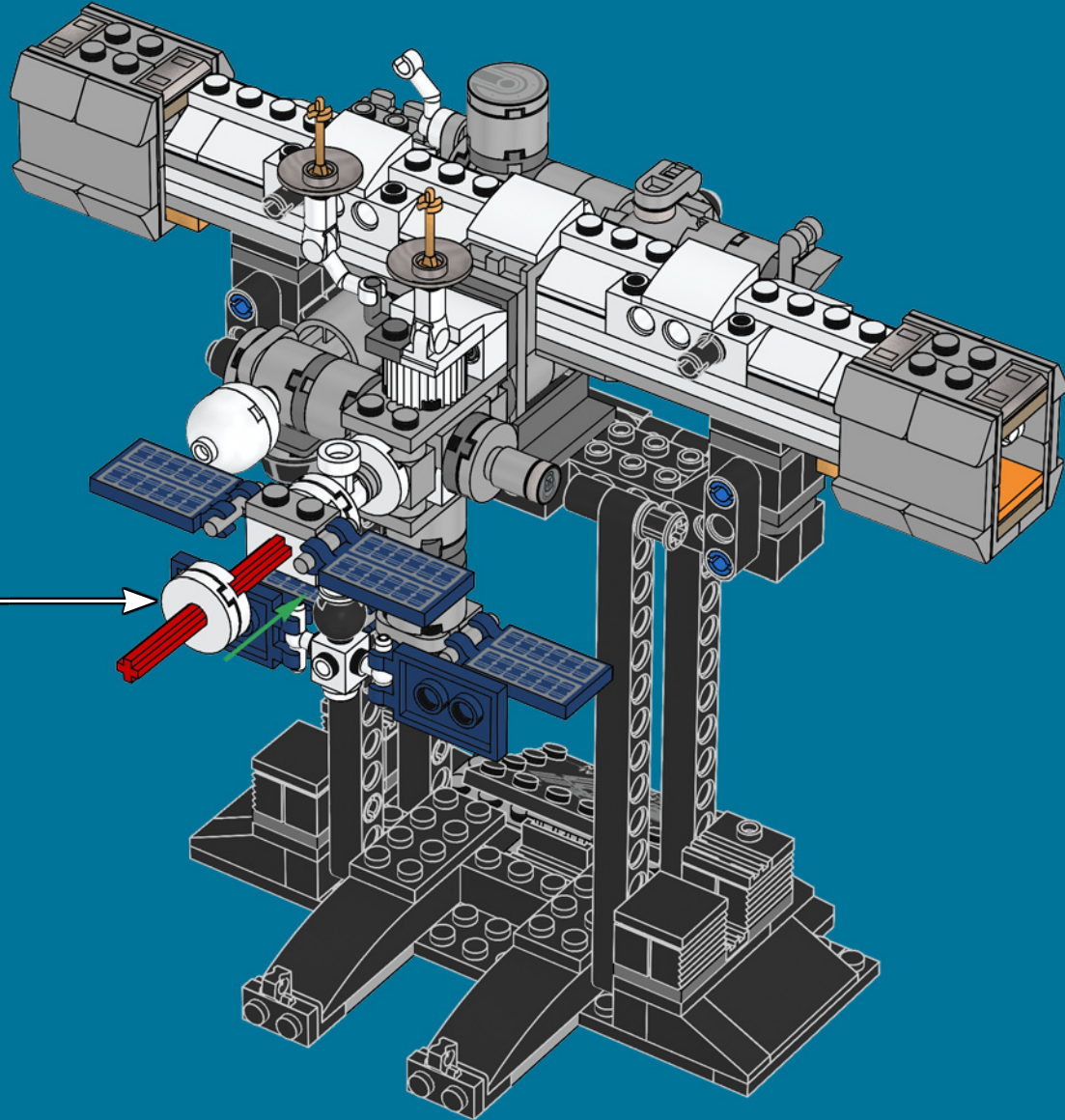
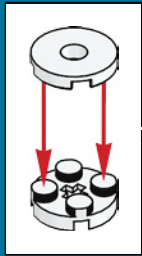

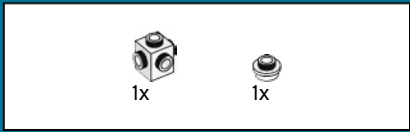

87

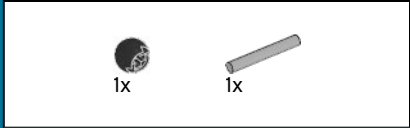
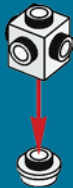

88

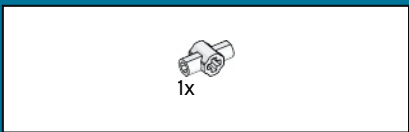
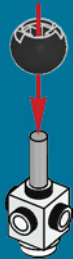

89



90





91

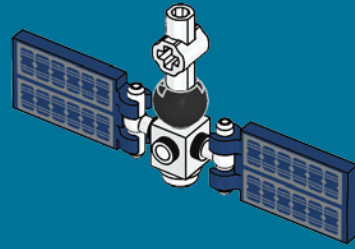

92

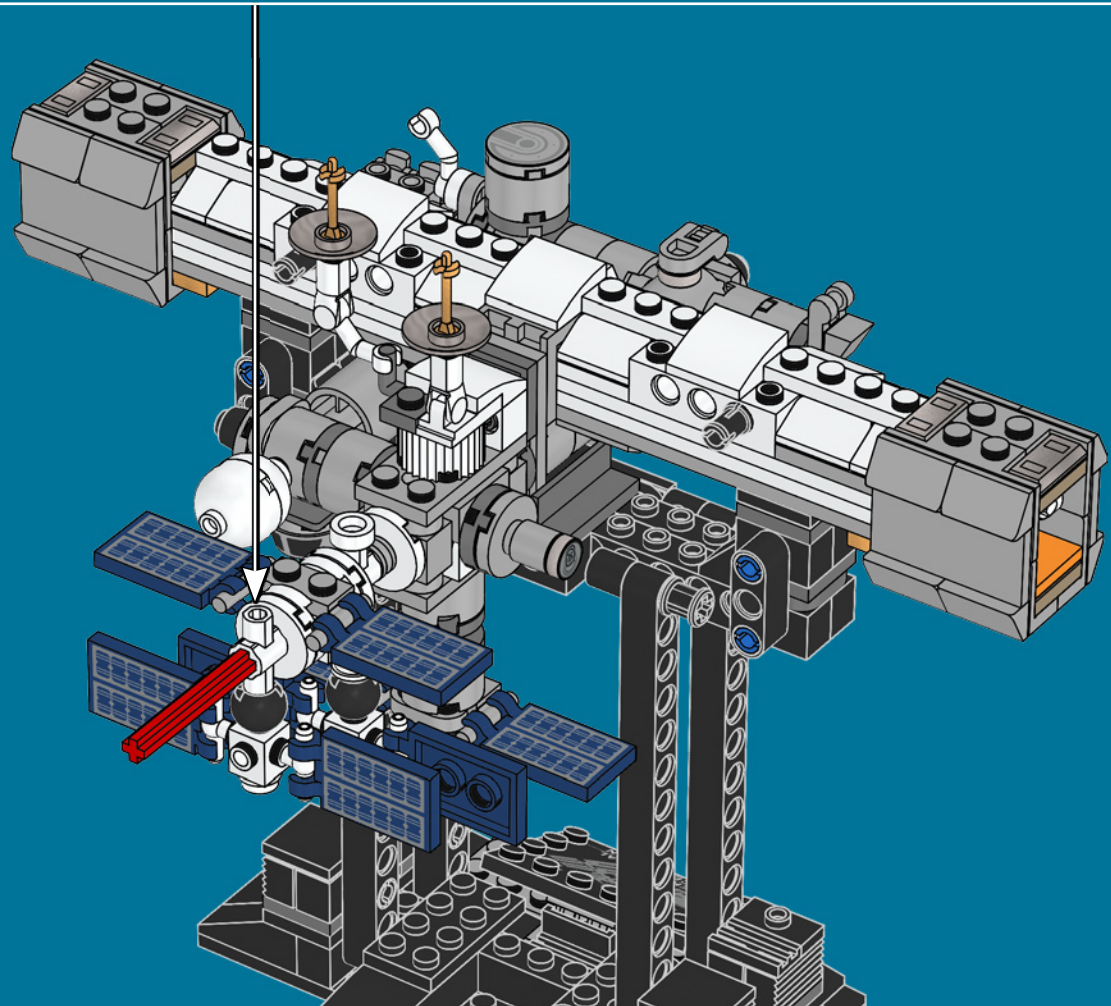



1x



1x



1x

93

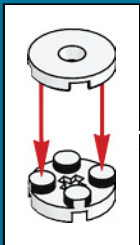
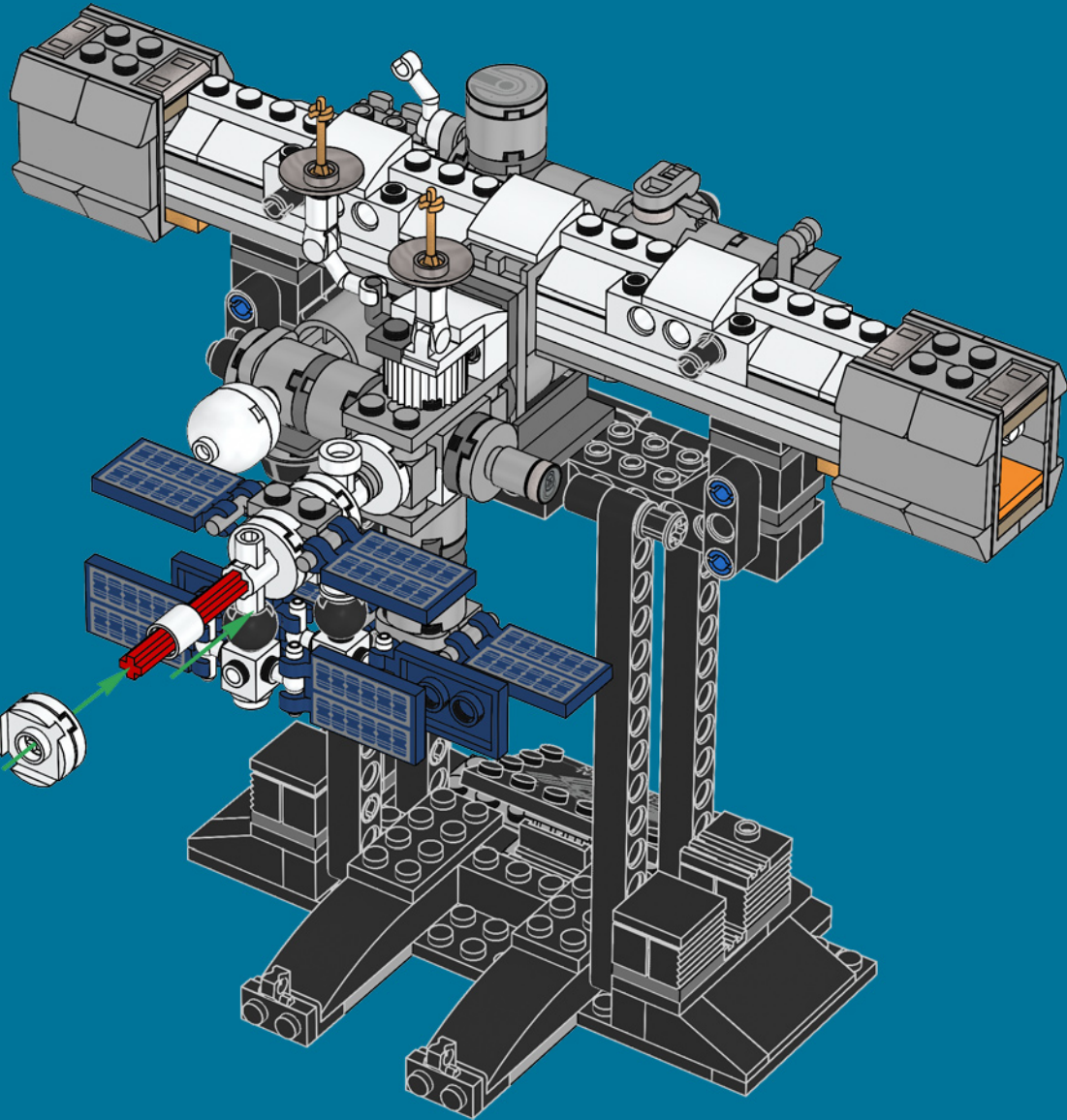

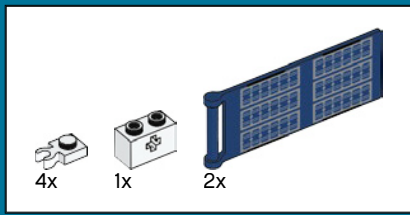

94

1



2

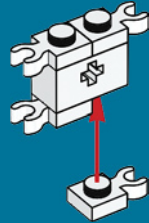

3

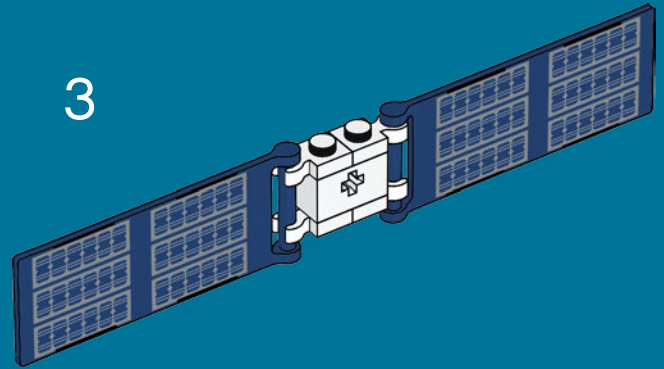

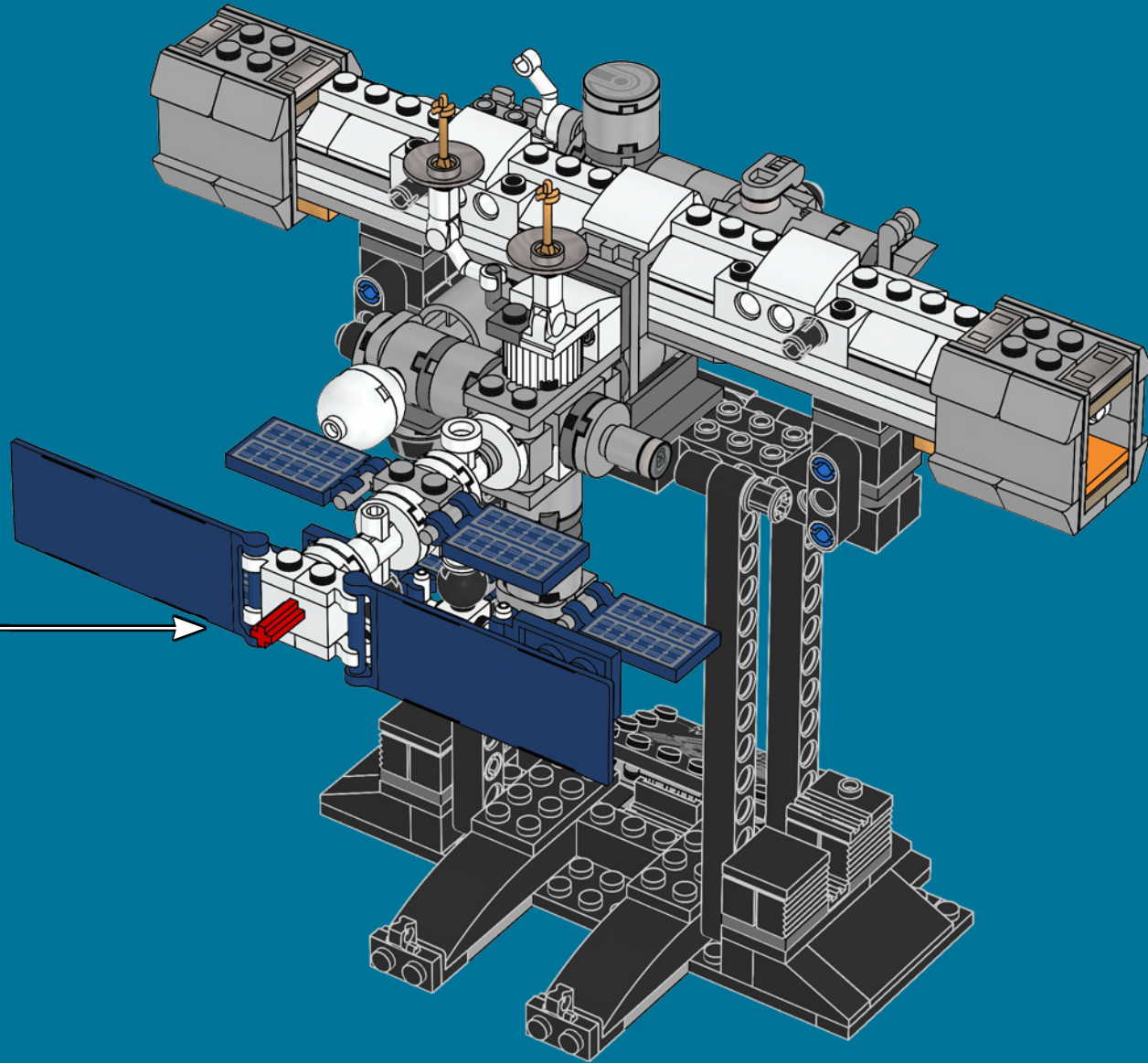

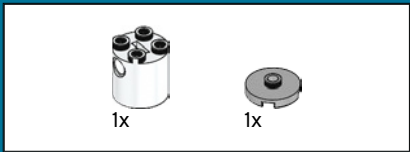

95

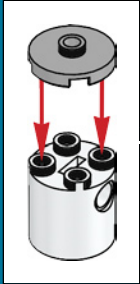
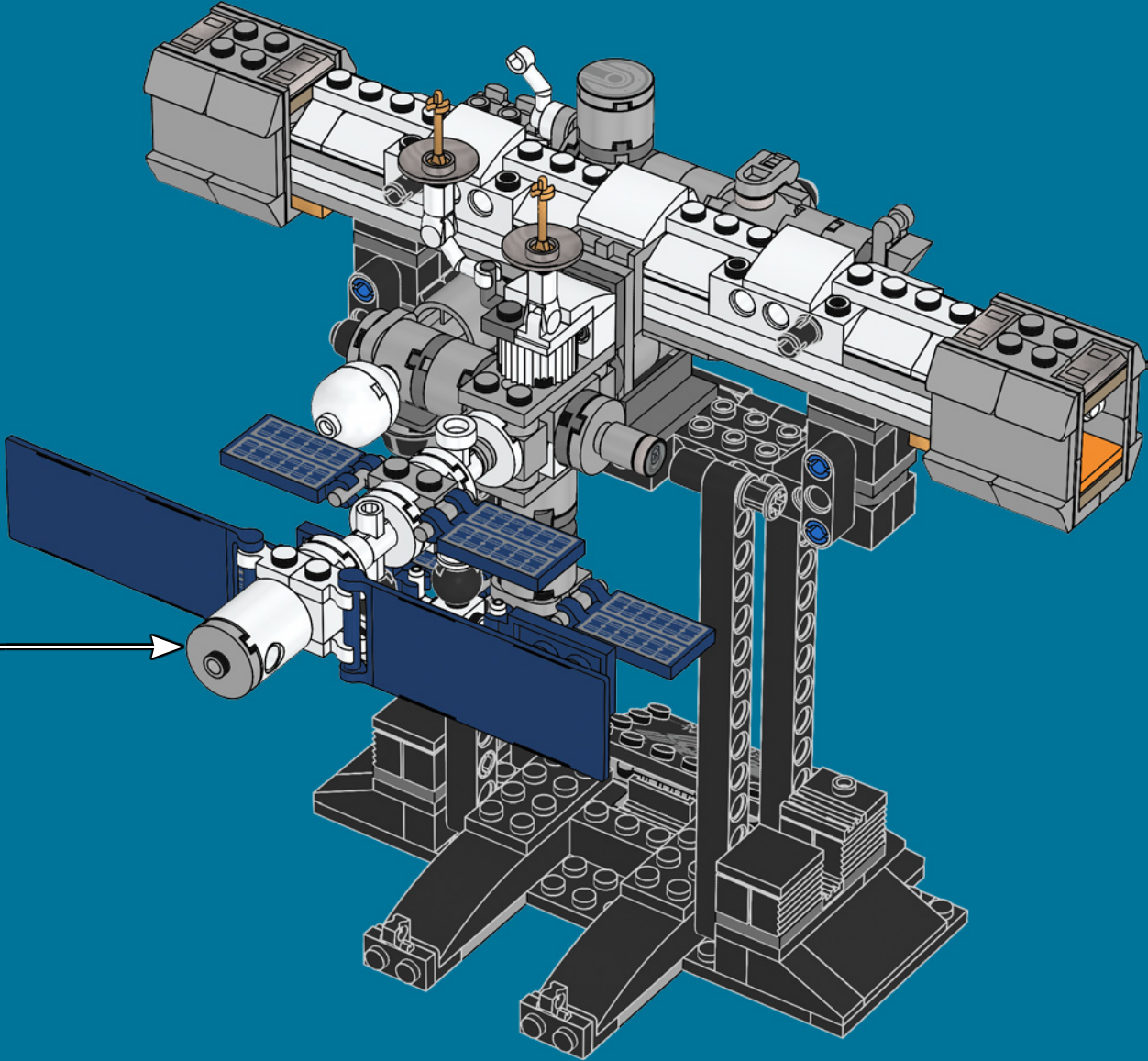



96

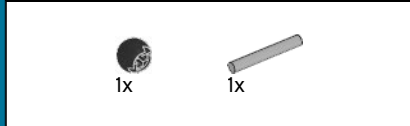
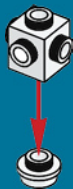

97

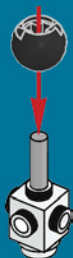

98

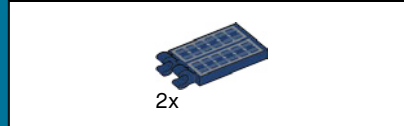

99

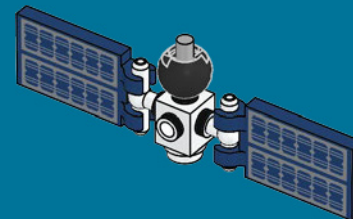

100

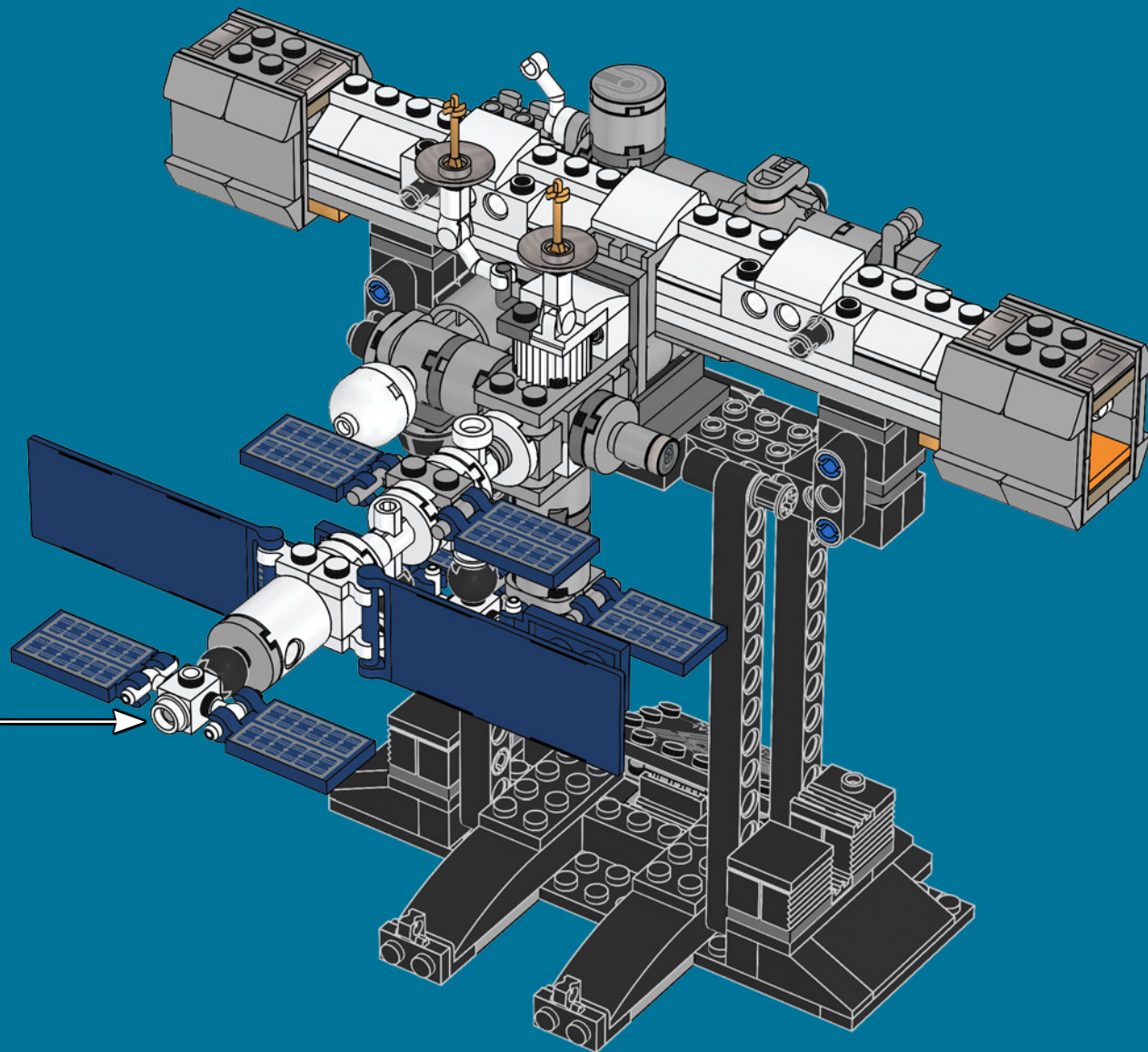

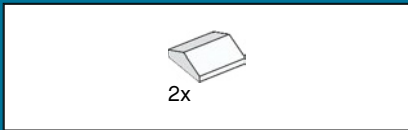

103

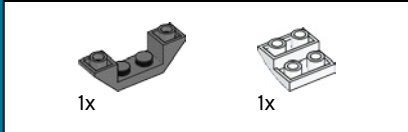
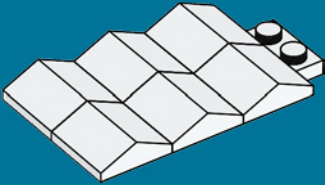

104

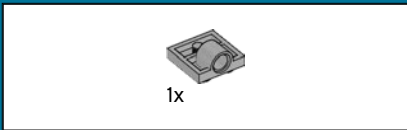
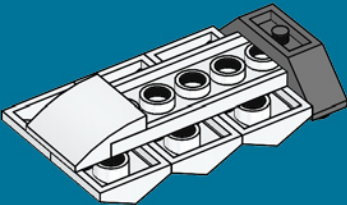

105

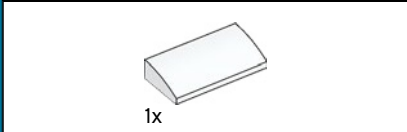
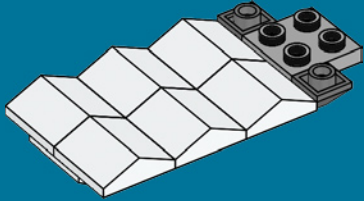

106

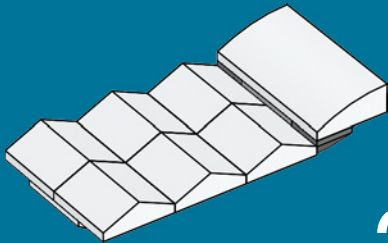

2x

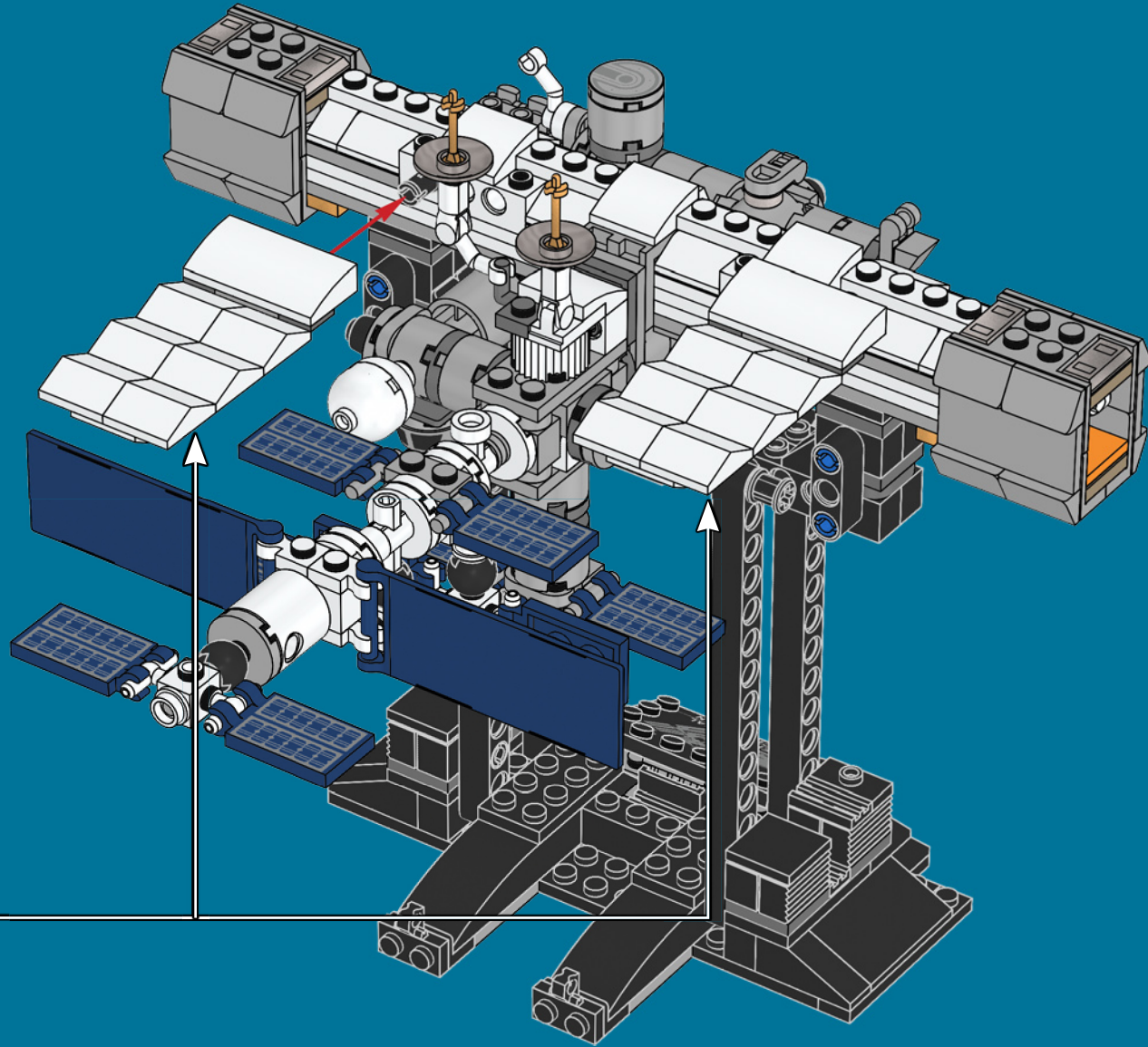



1x



1x

108

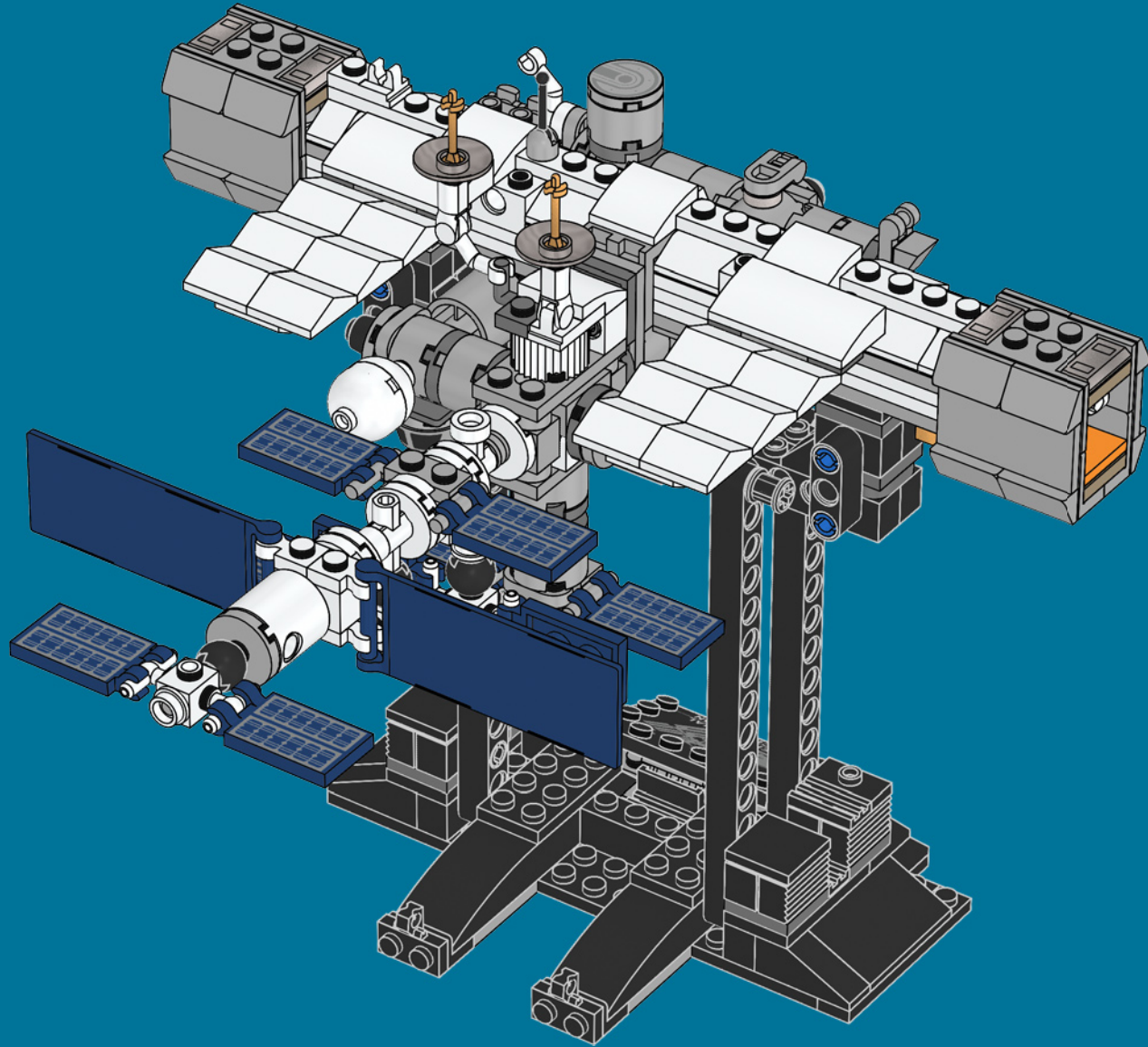

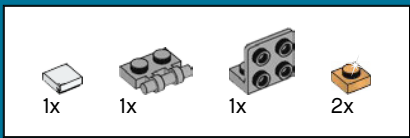

109

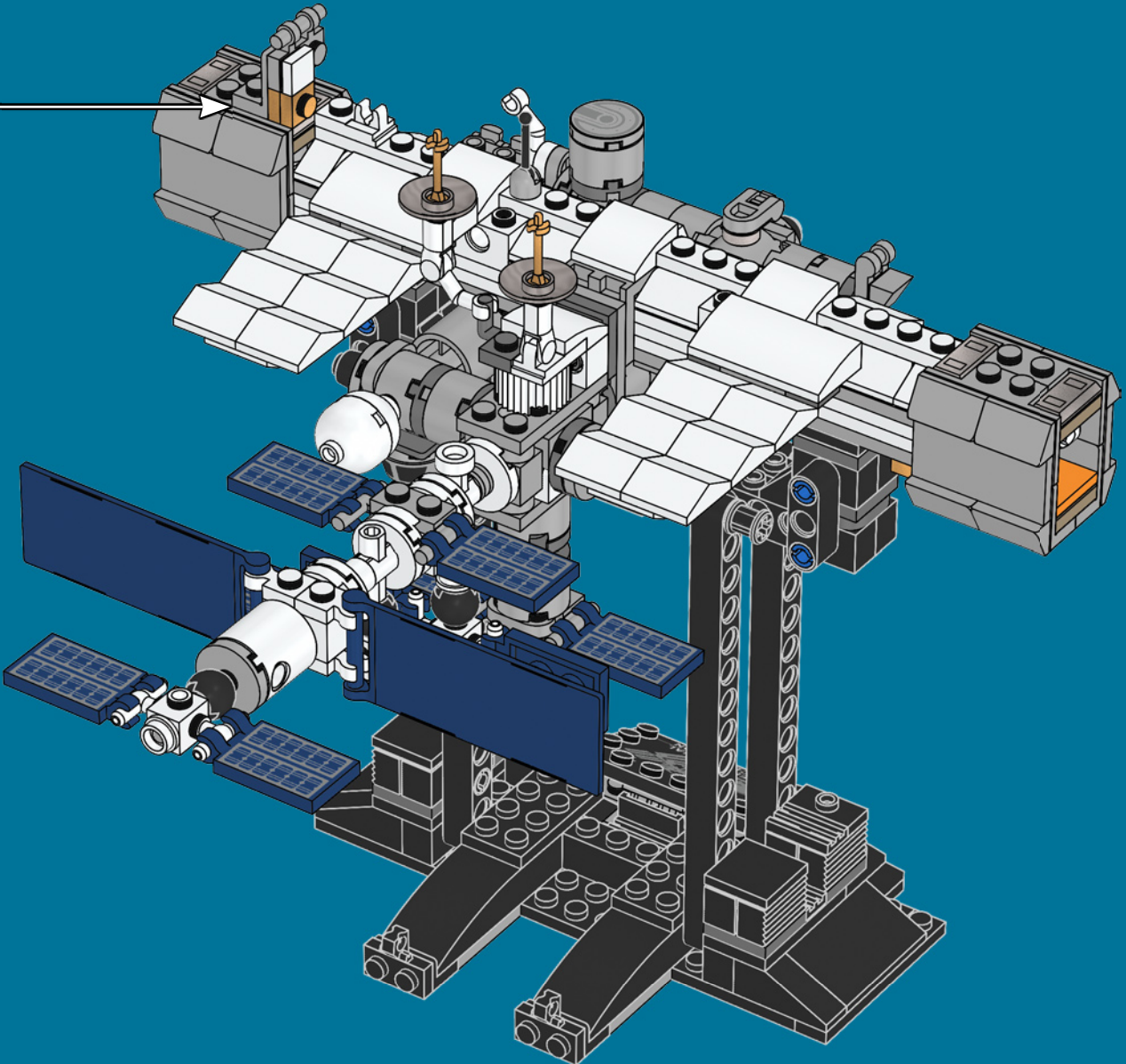
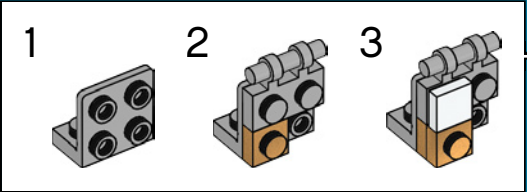

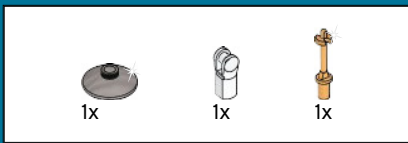

110

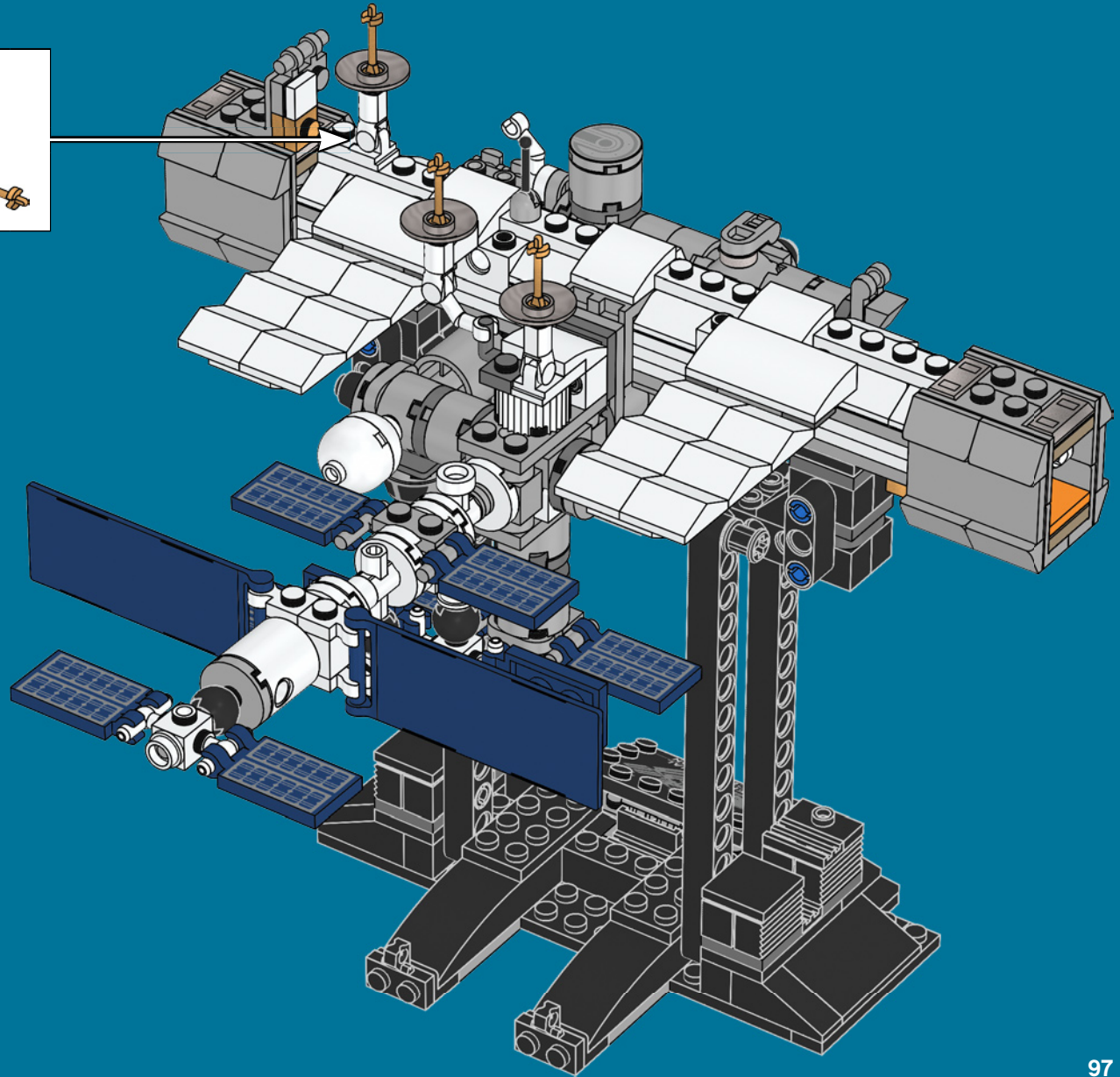
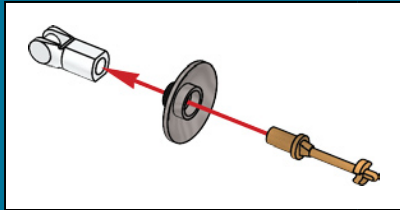



3x



1x



1x

111

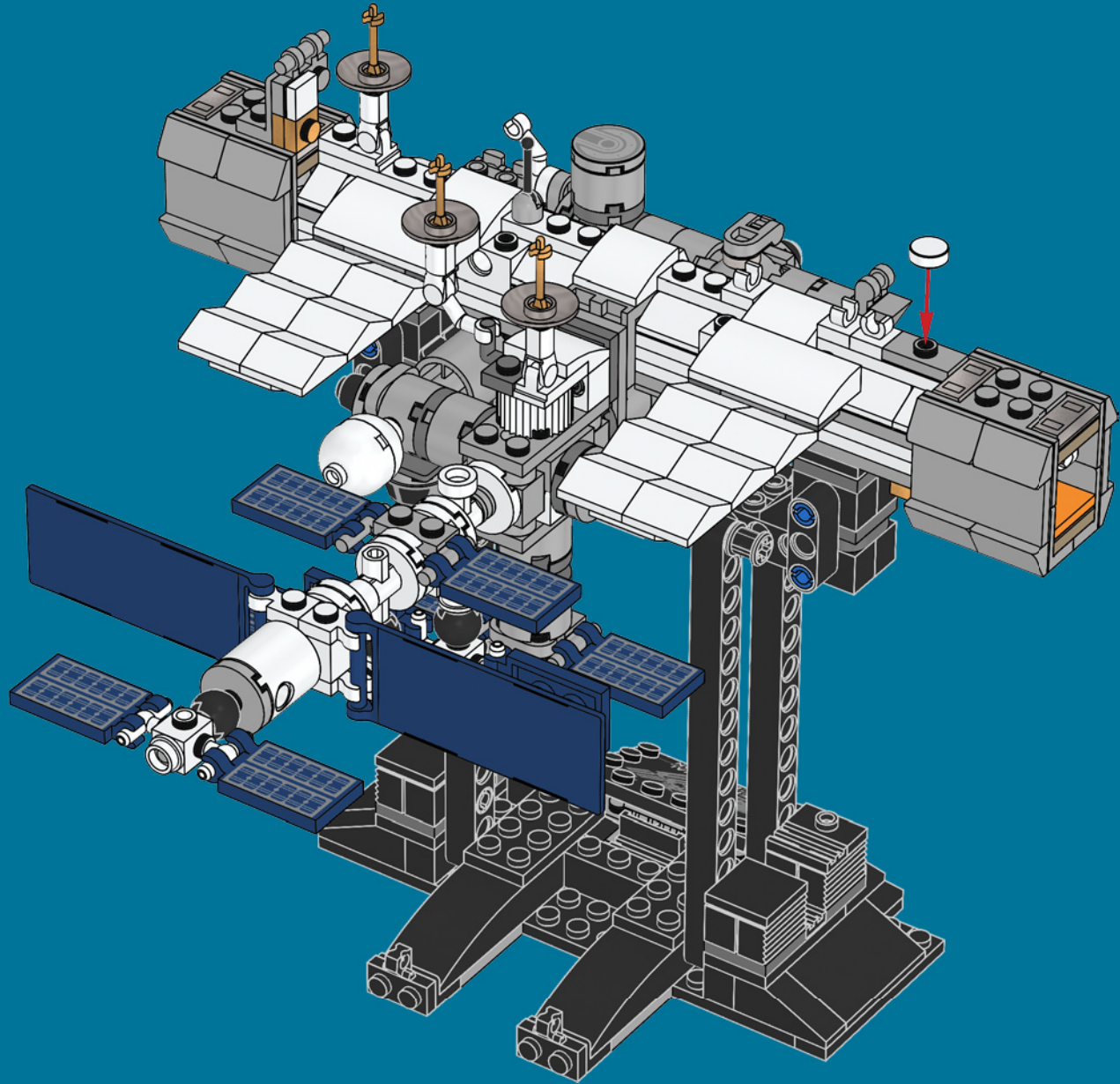

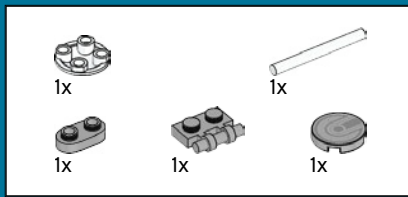

112

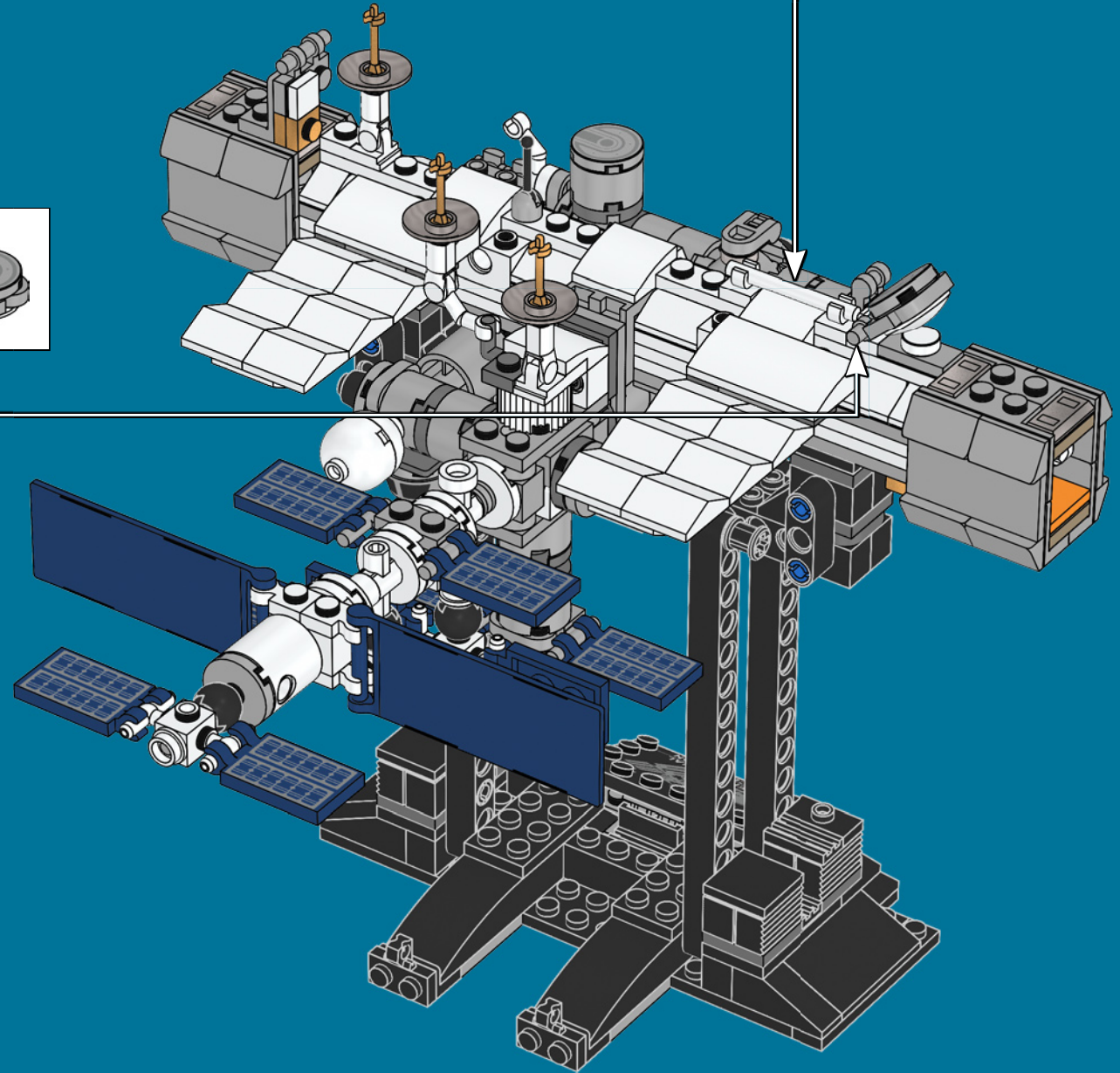
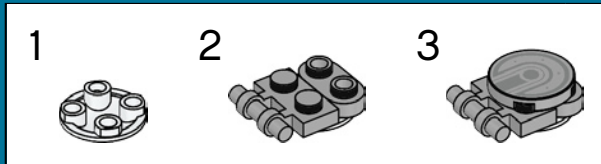

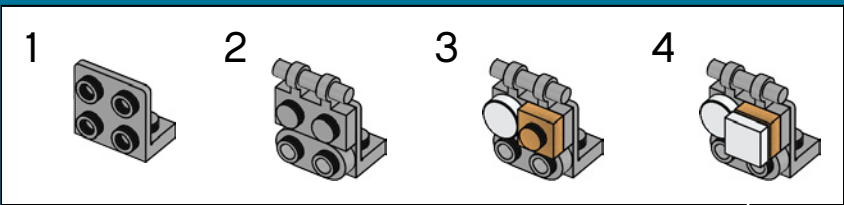
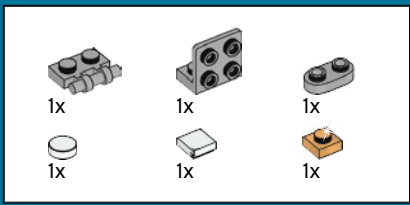

113

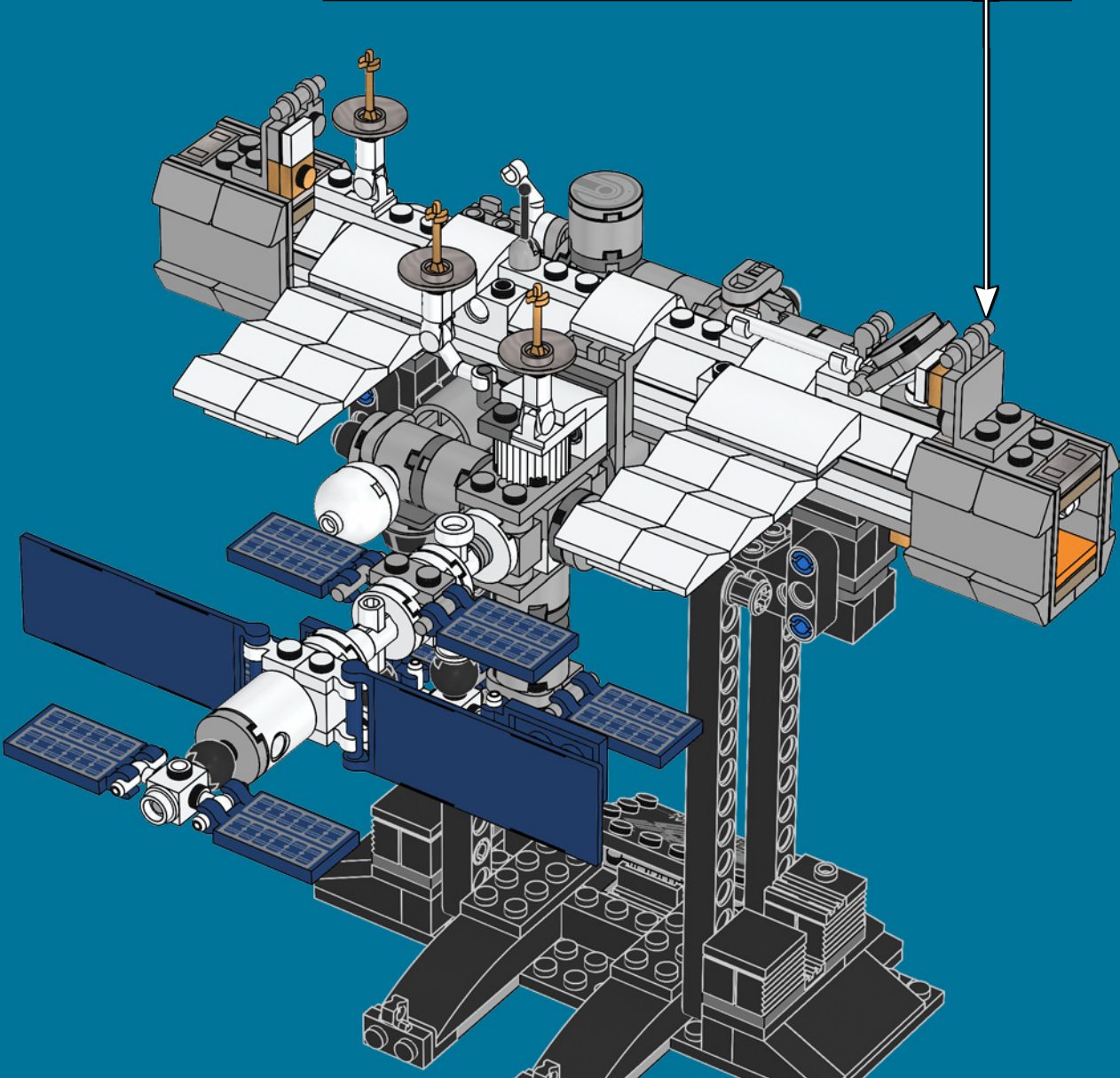

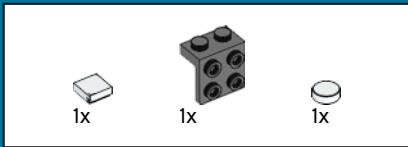

114

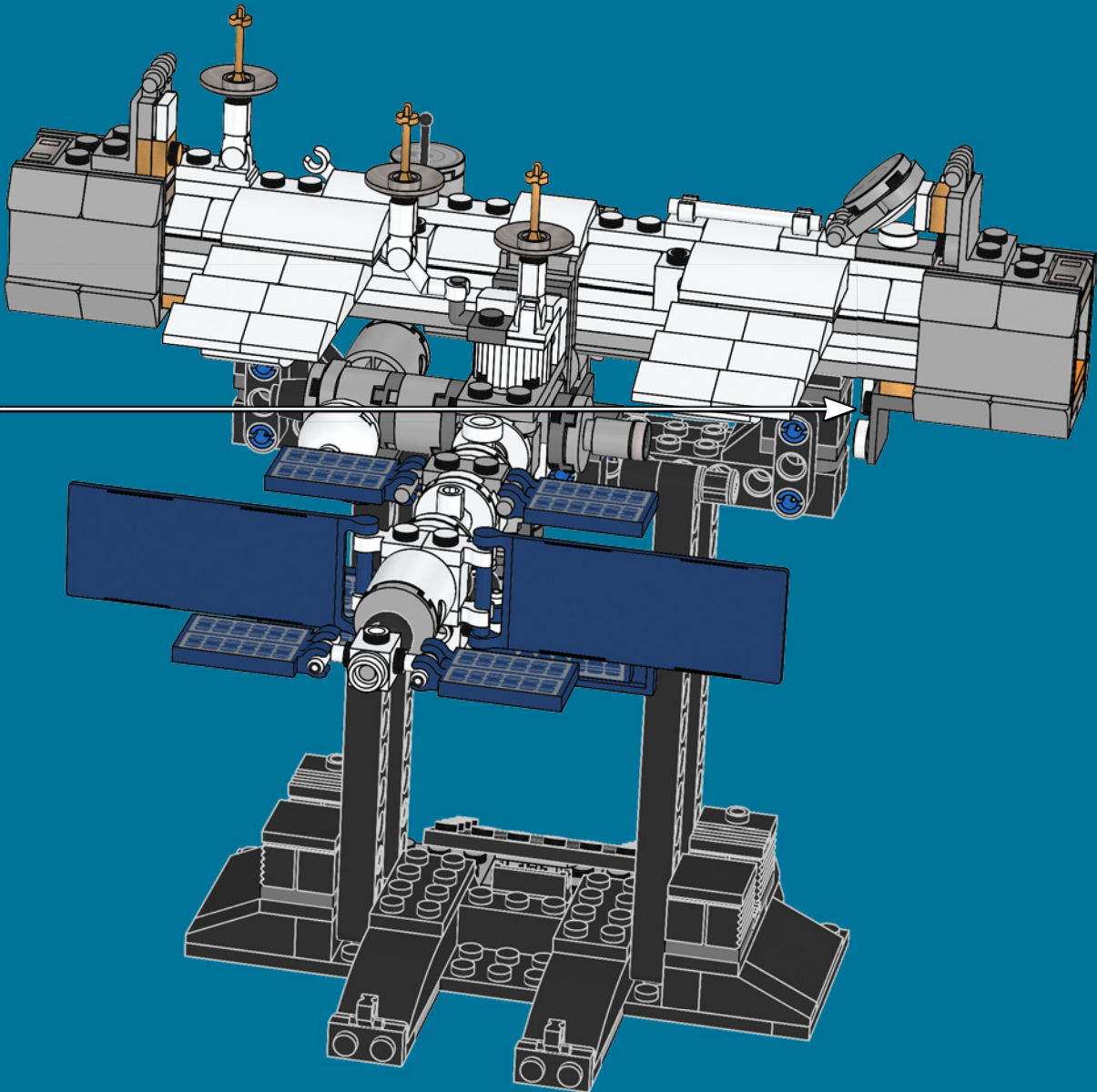
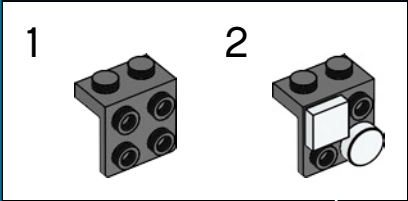

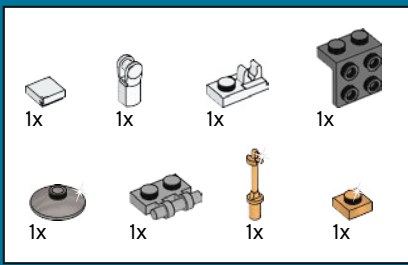

115

1

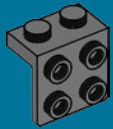

2

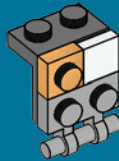

3

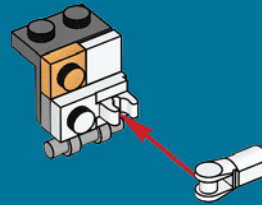

4

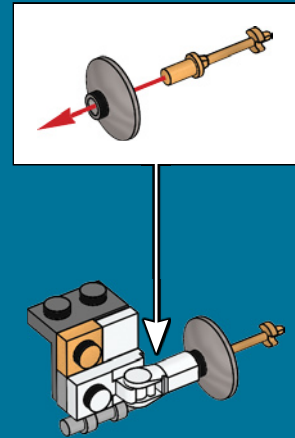

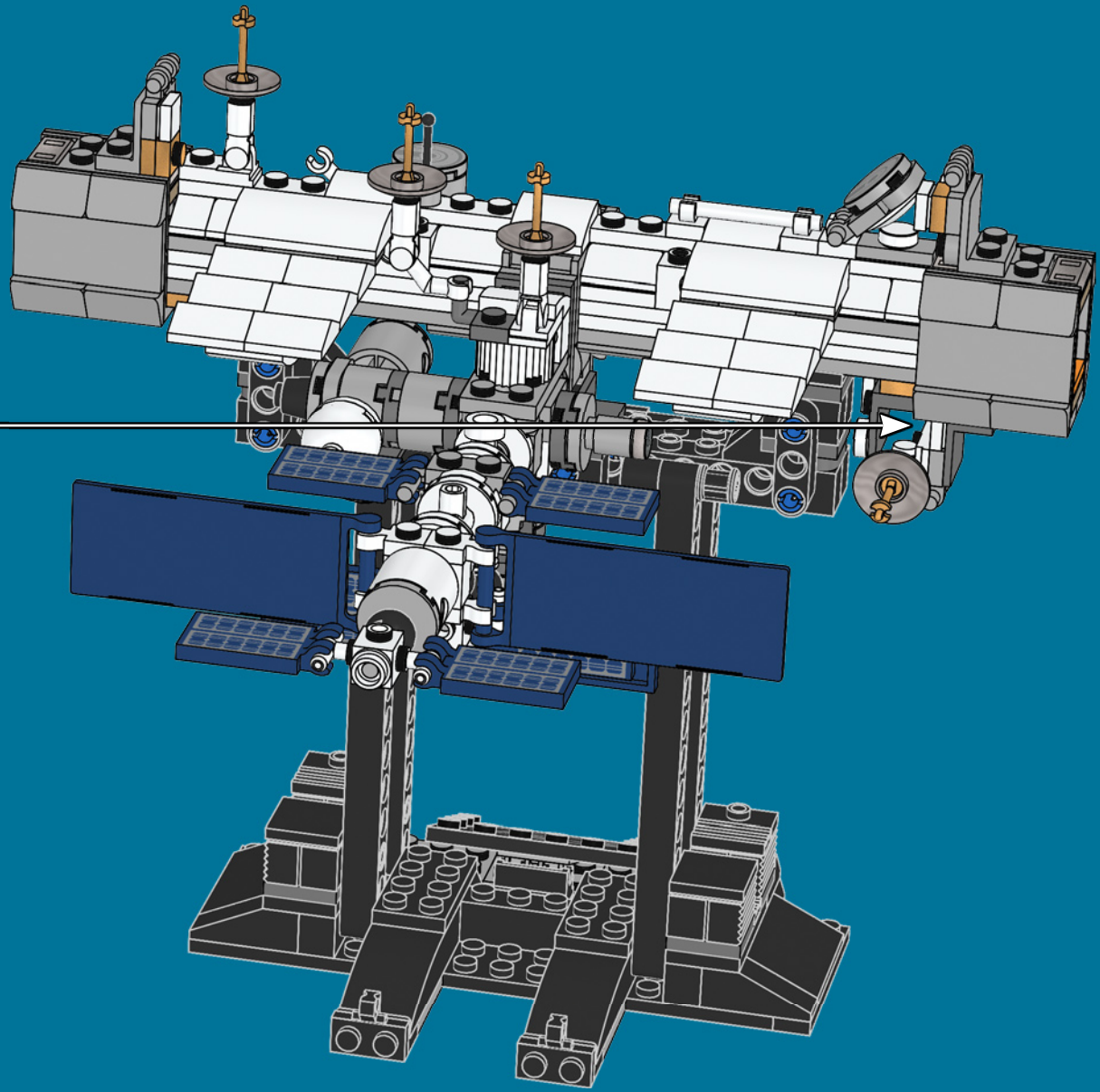

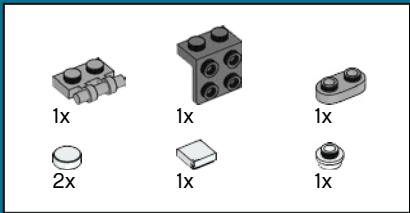

116

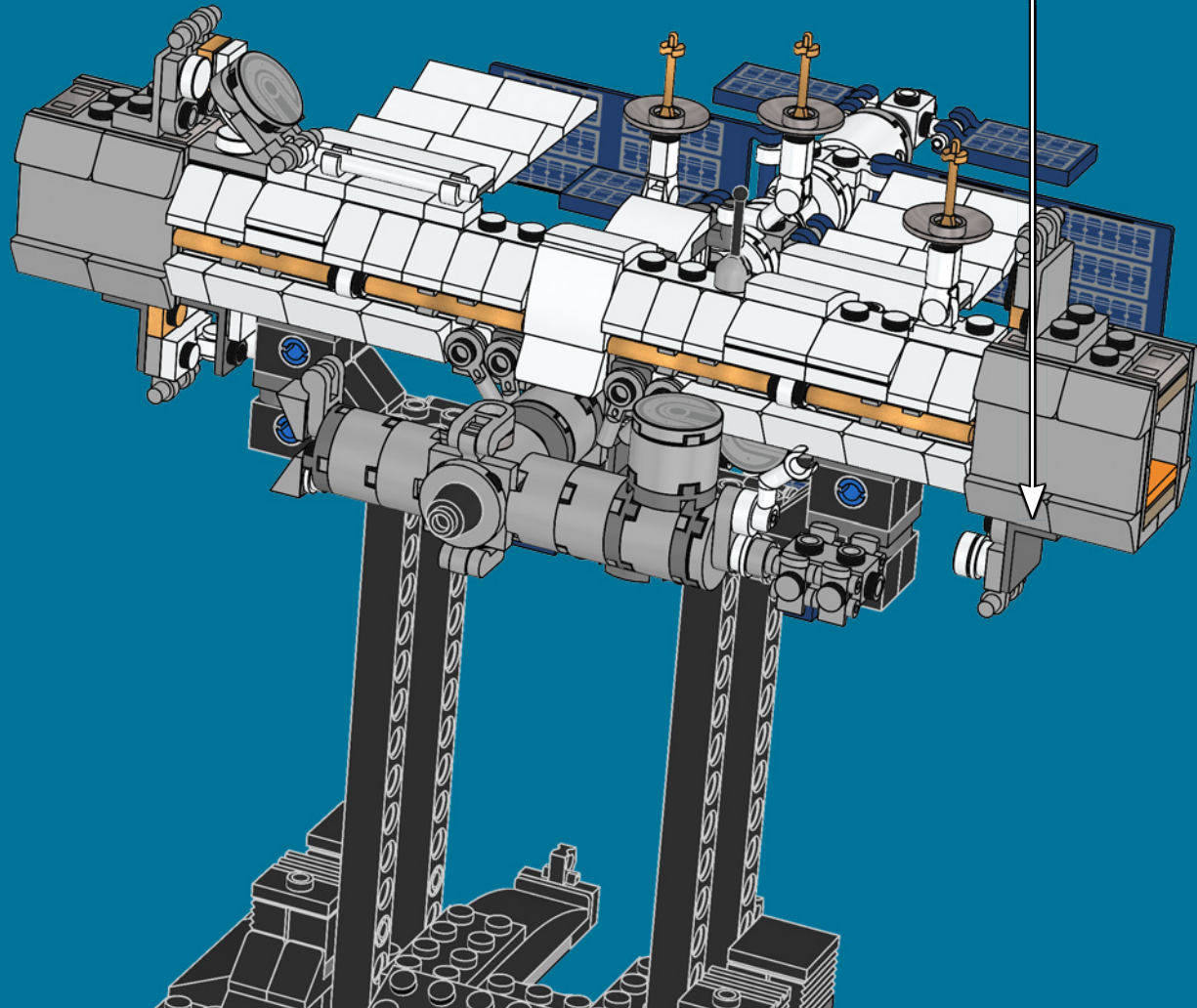
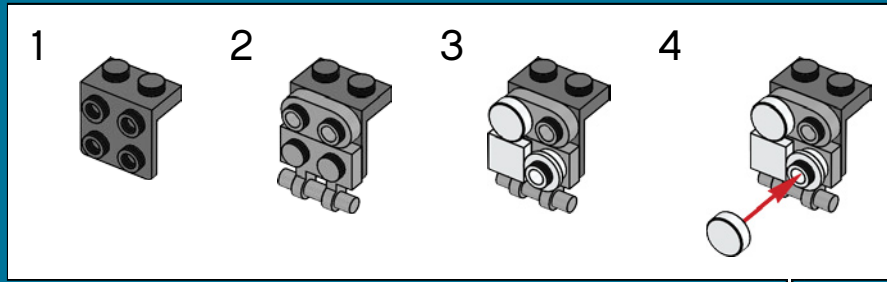

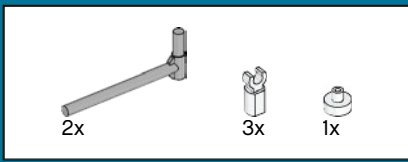

117

1

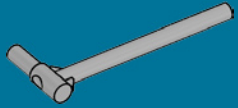

2

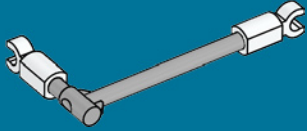

3

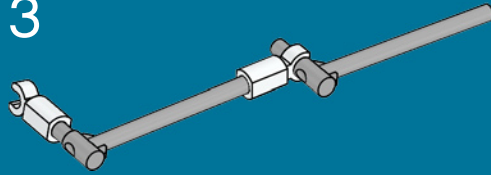

4

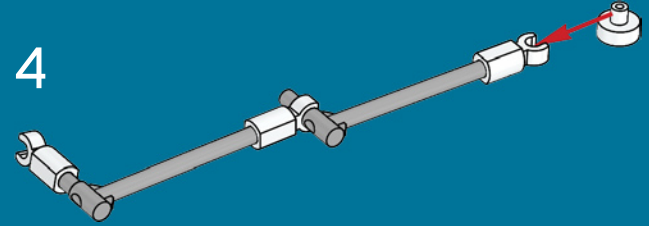

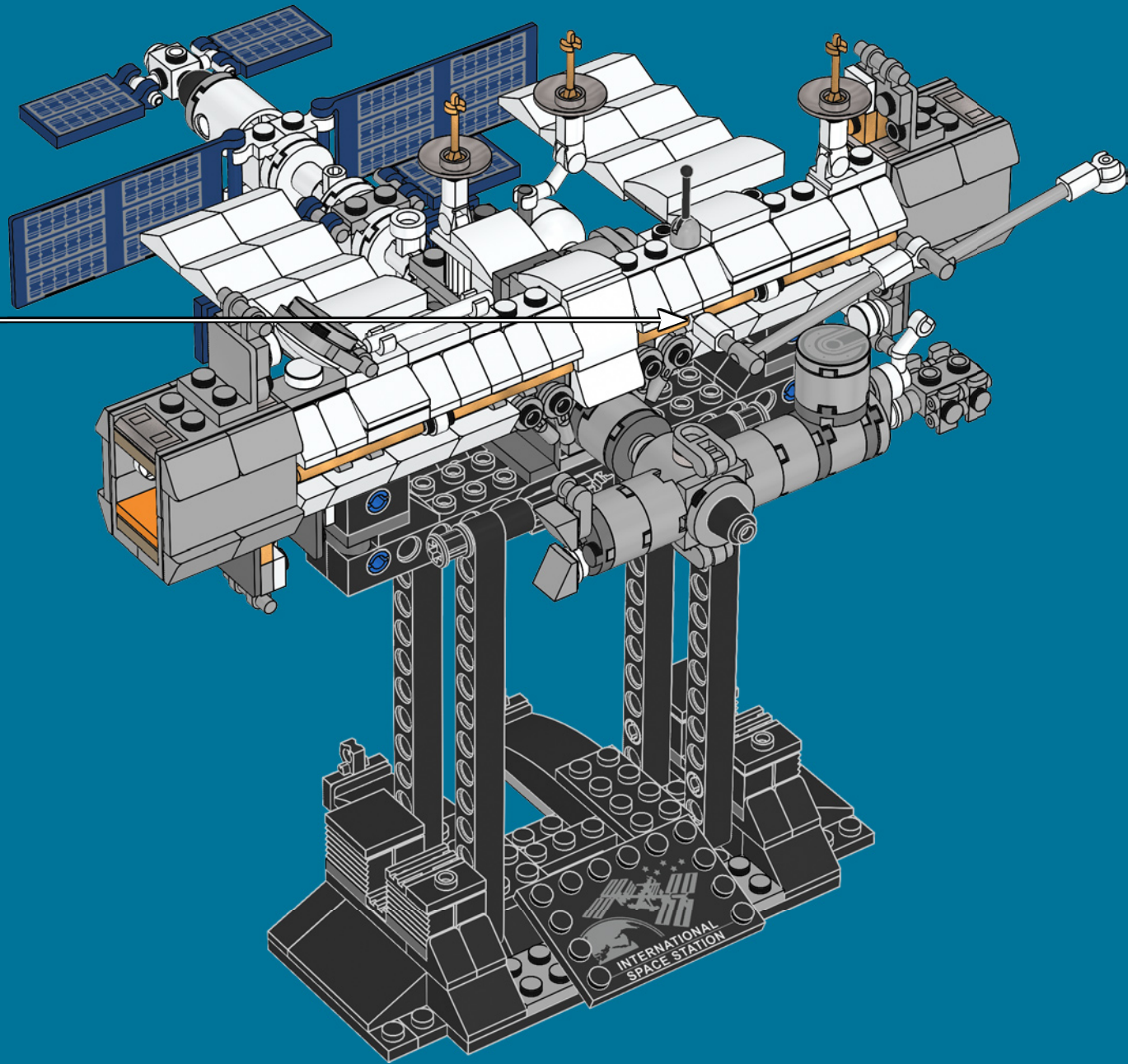

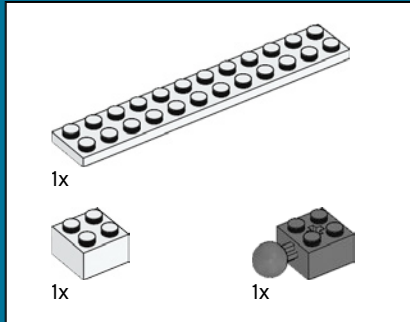
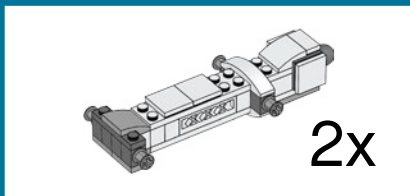

118

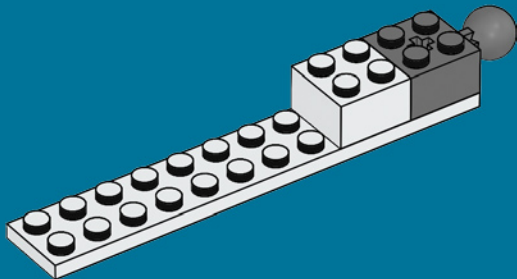

119

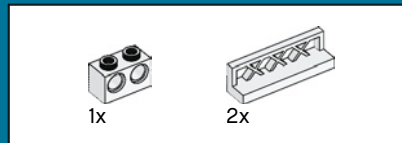
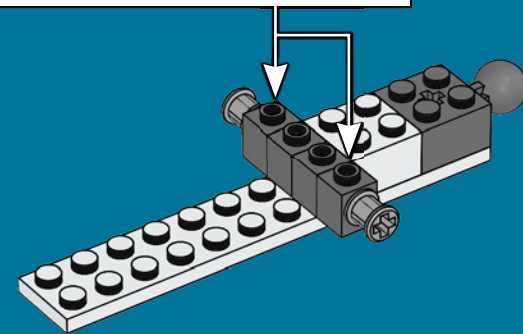
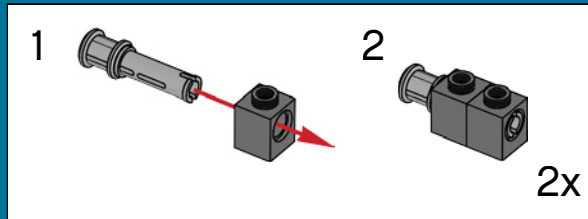

120

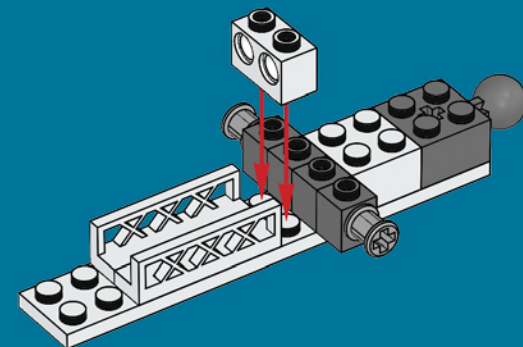



121

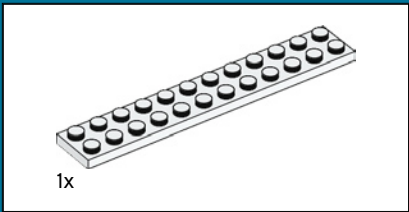
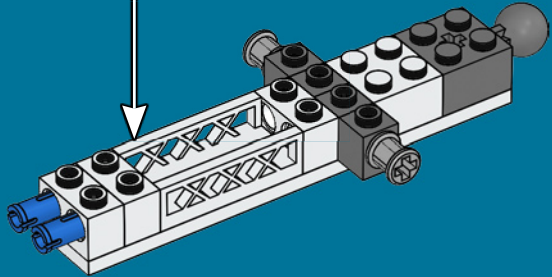
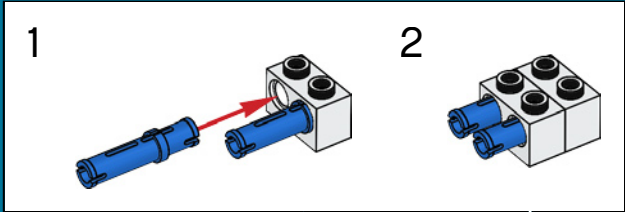

122

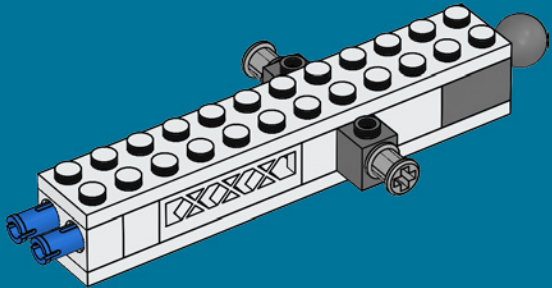

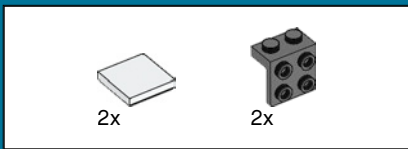

123

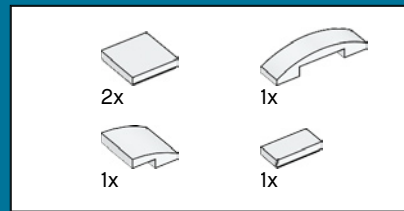
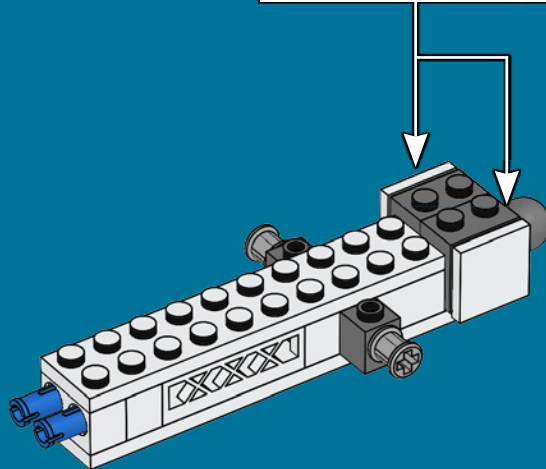
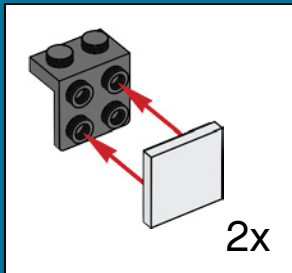

124

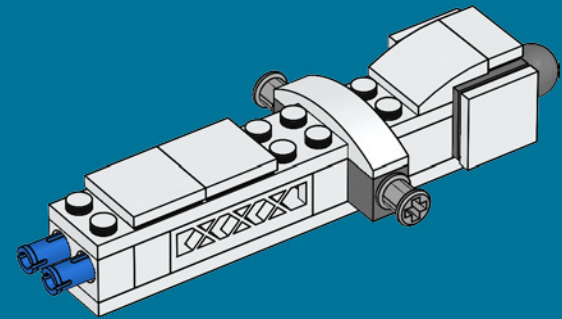

125

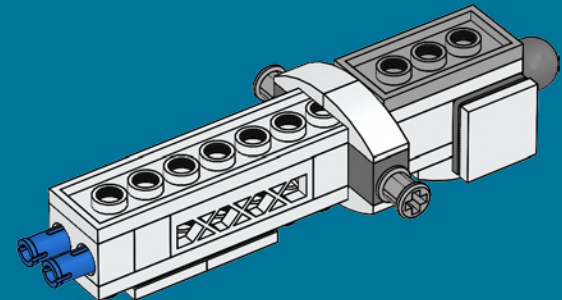



1x



1x

126

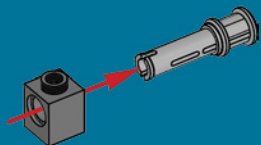

1x

127

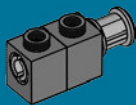

1x

128

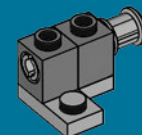

1x

129

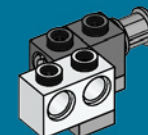

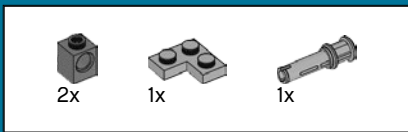

130

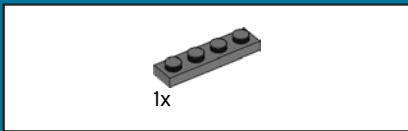
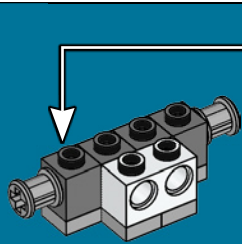
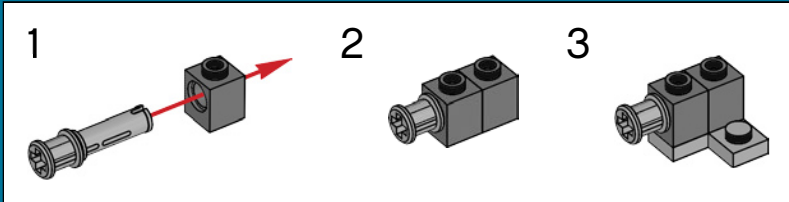

131

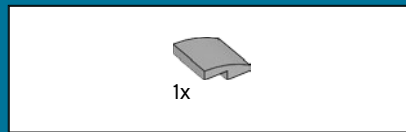
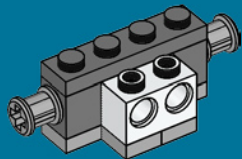

132

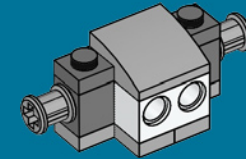

133

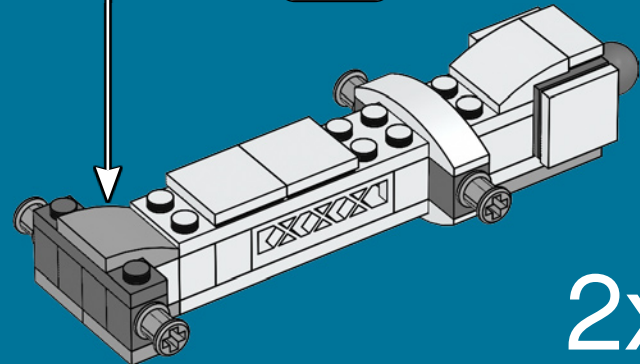

2x

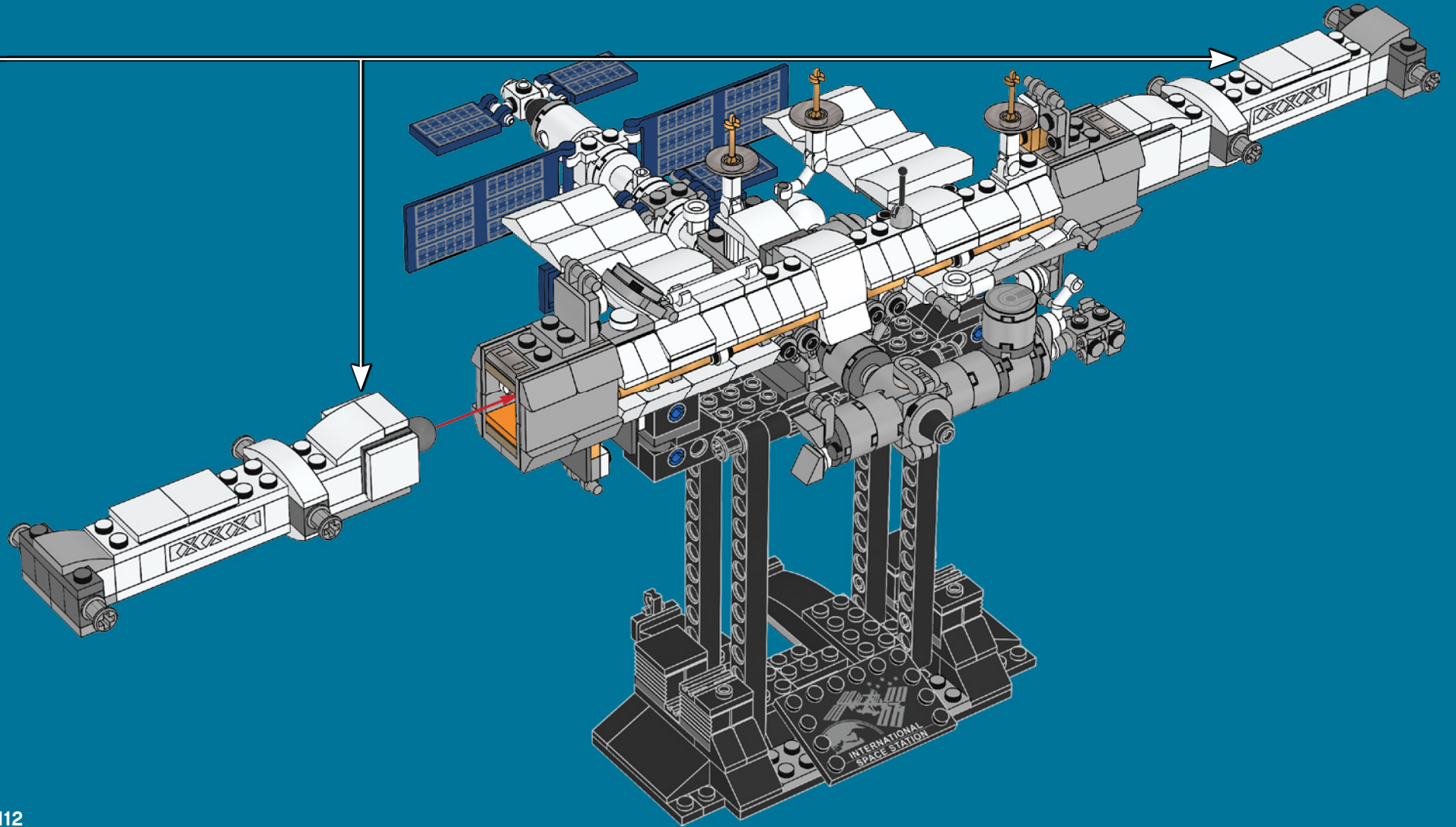



4x

135

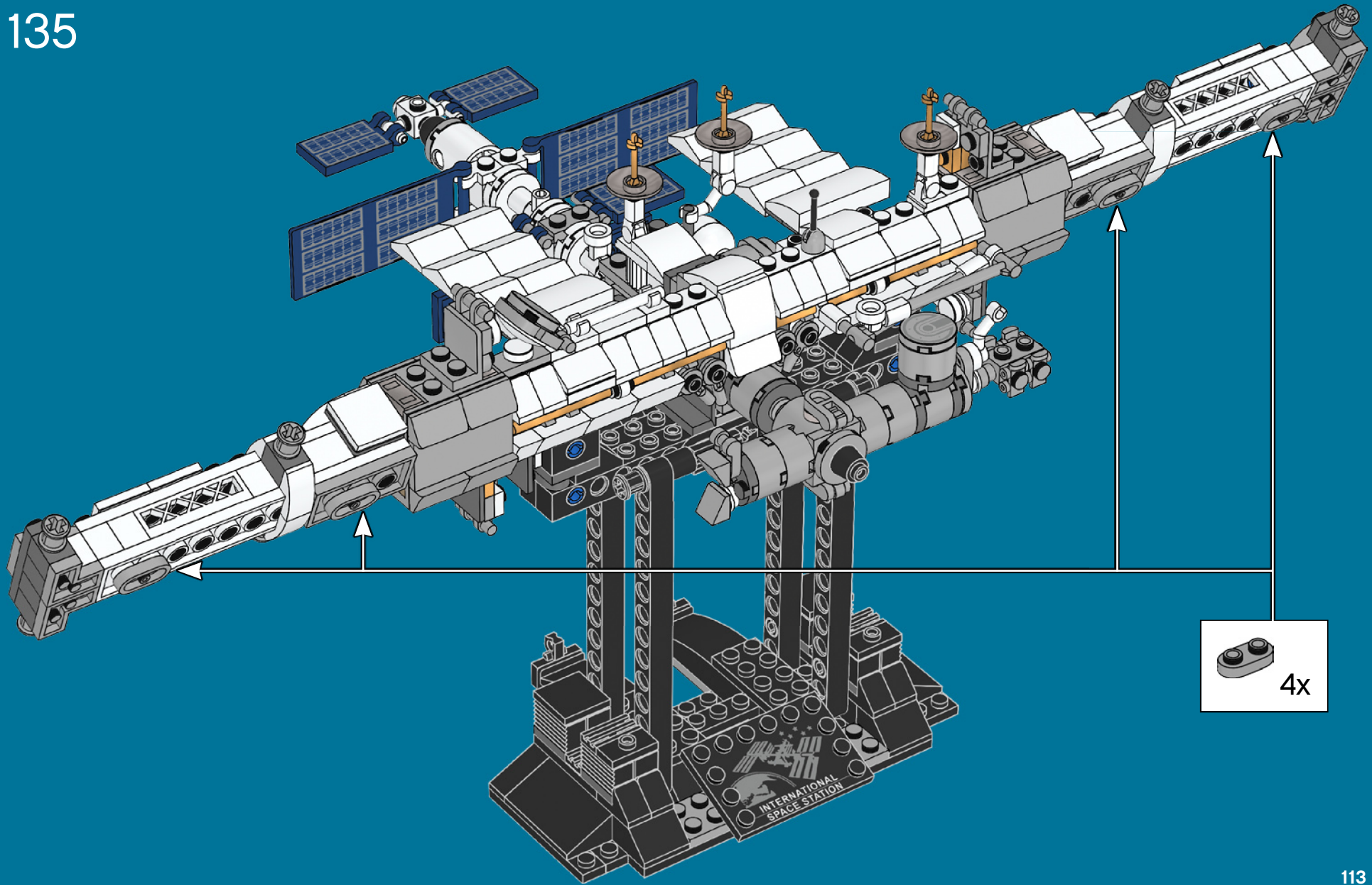

4x



8x

136

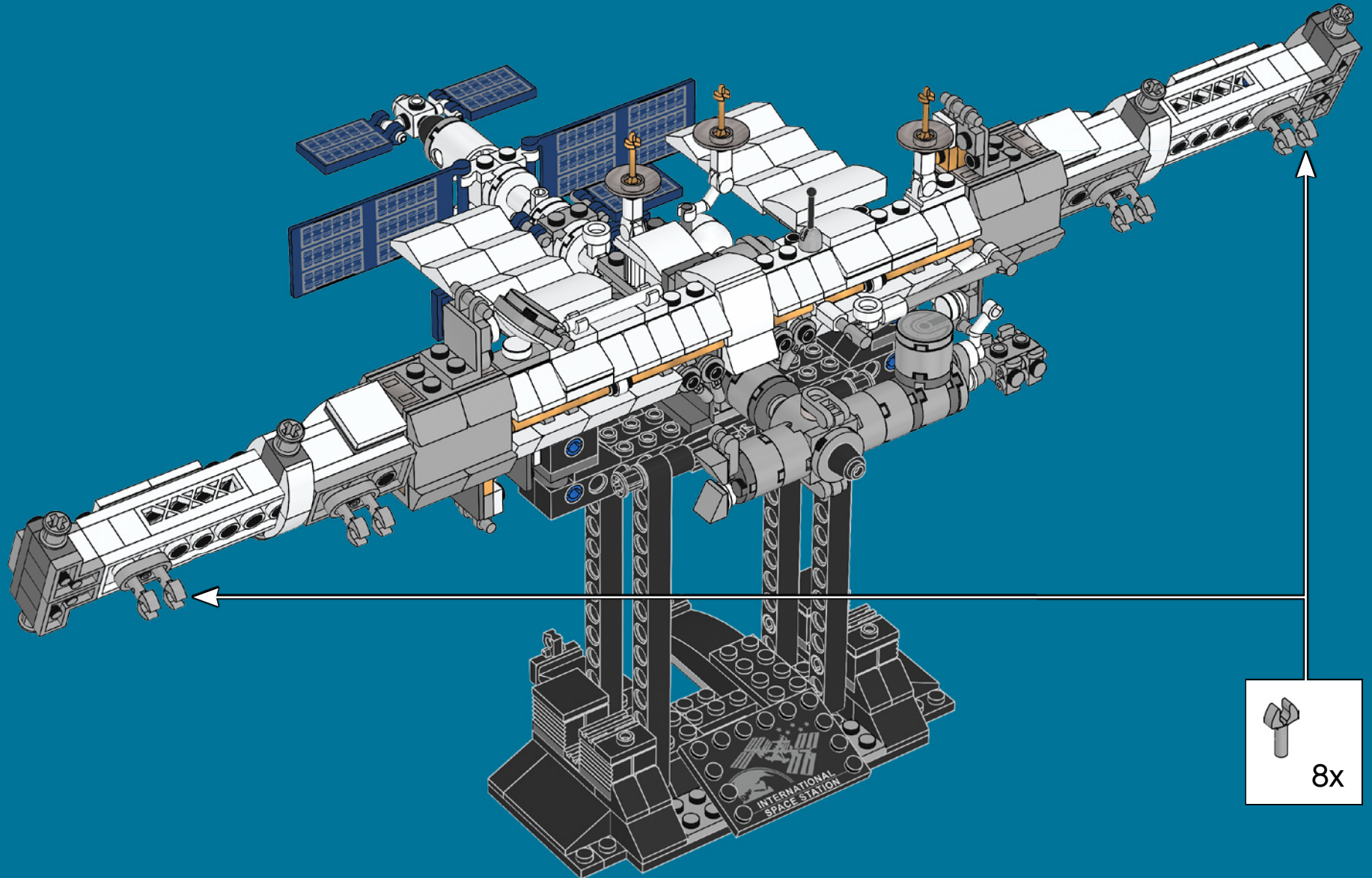

8x

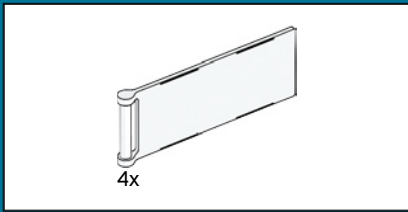

137

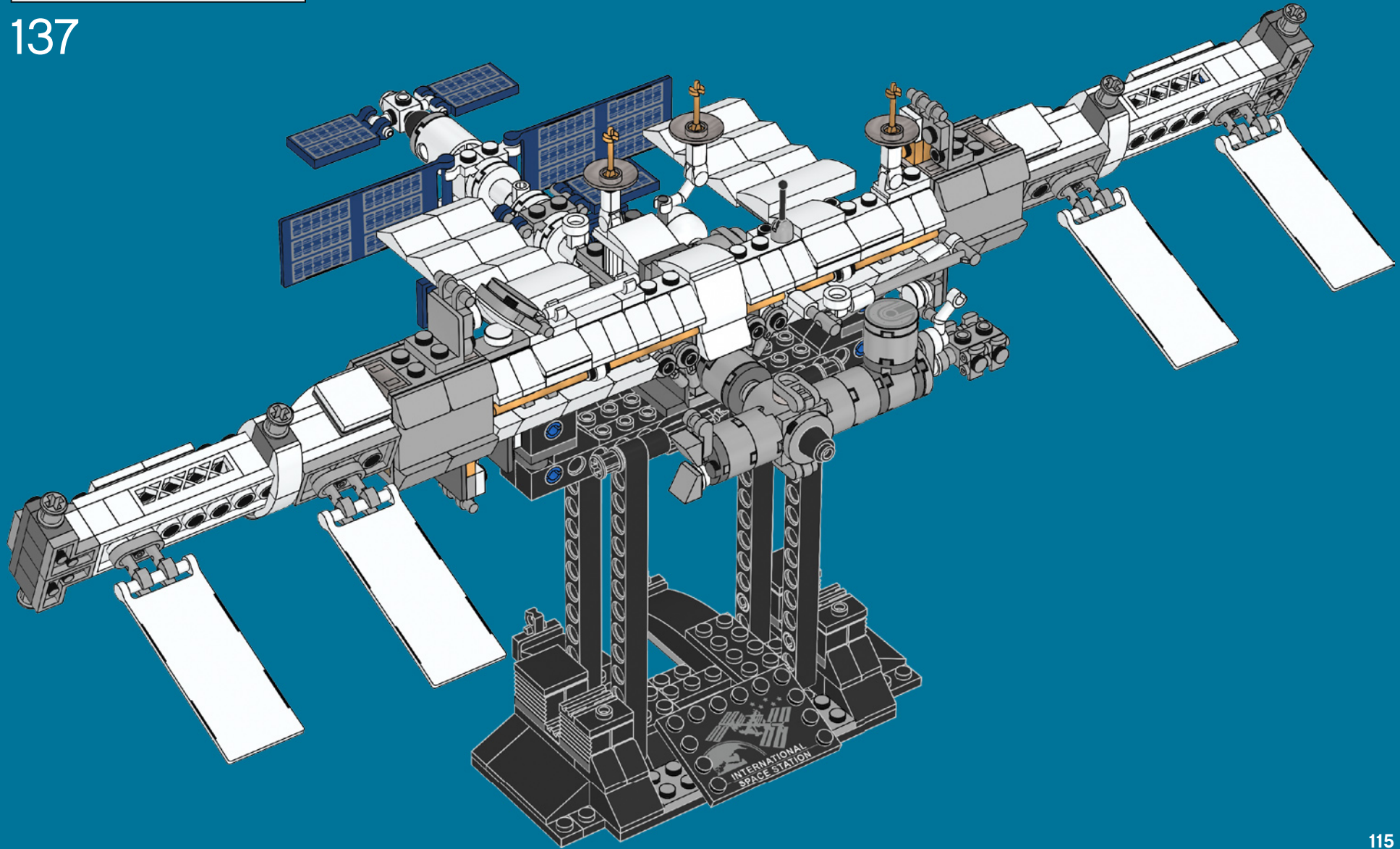

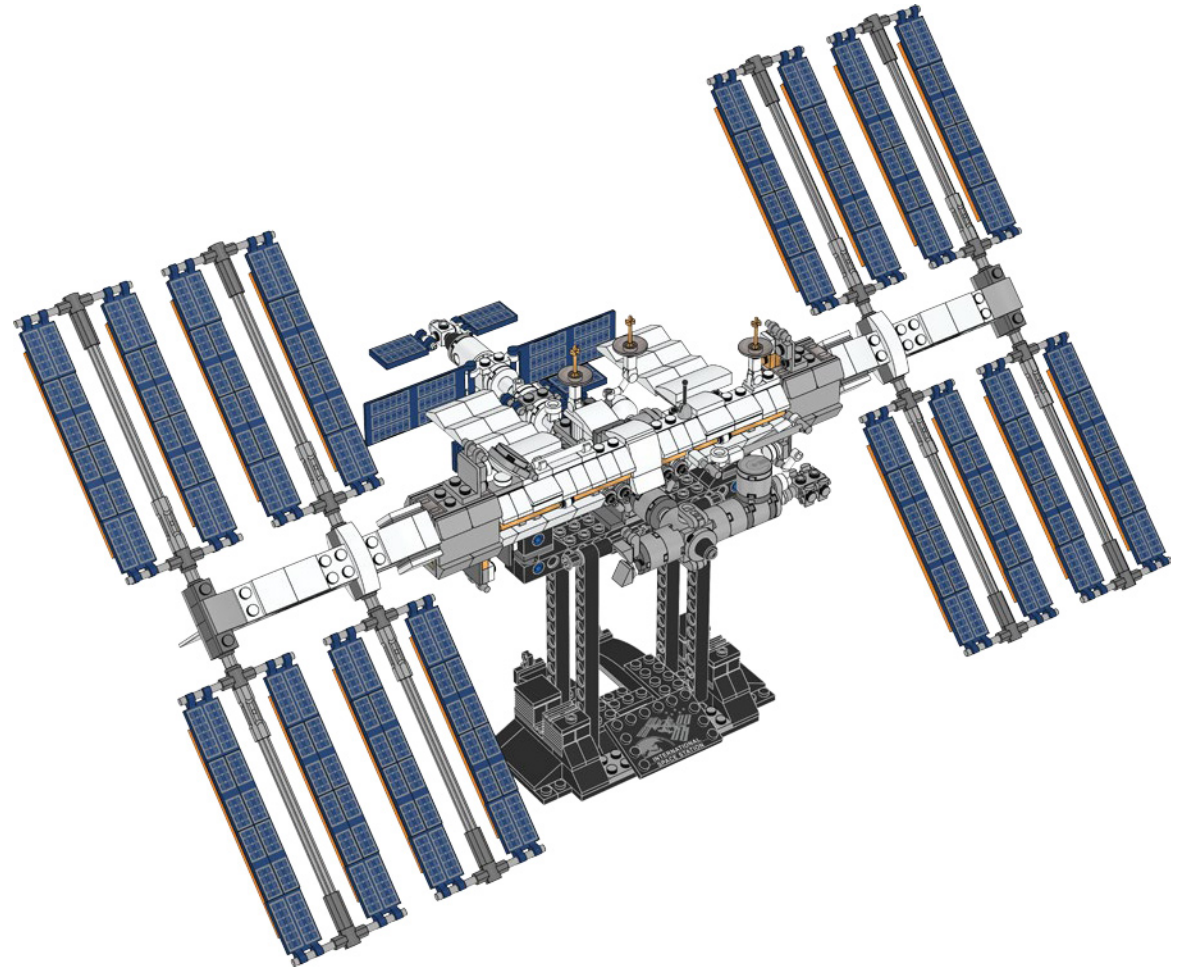
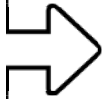

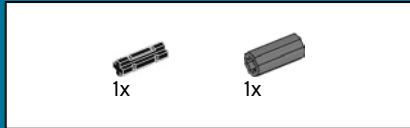

138

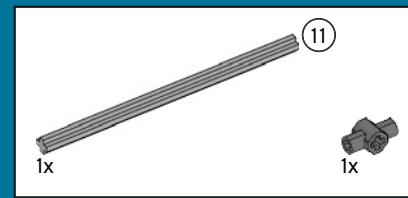
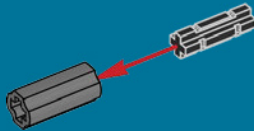

139

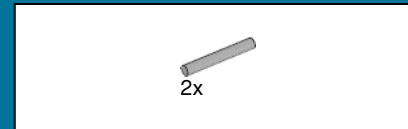
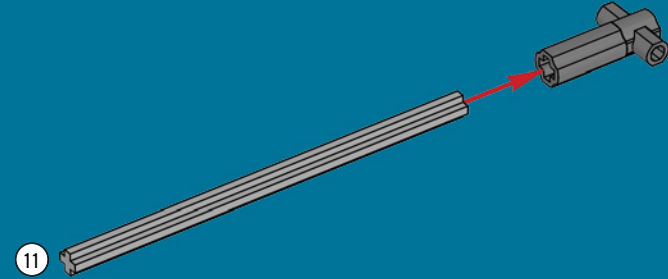

140

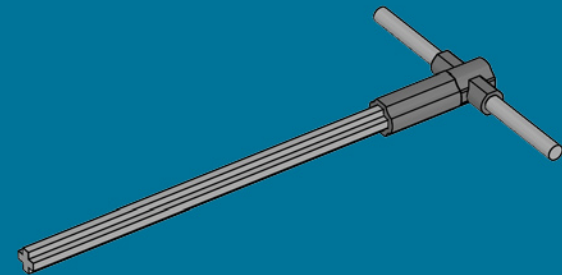

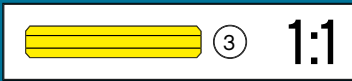
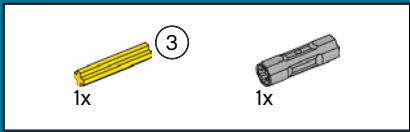

141

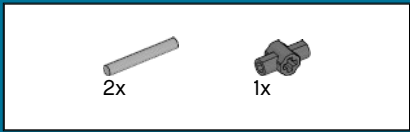
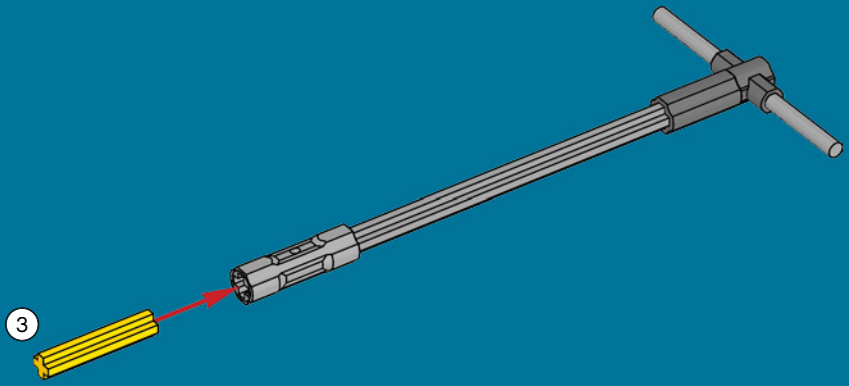

142

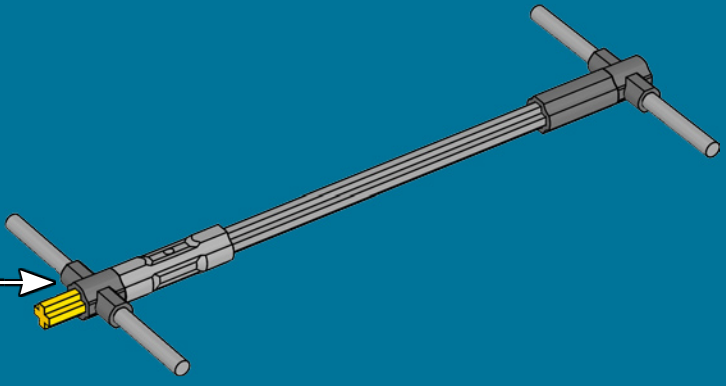
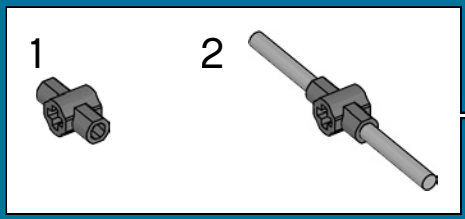

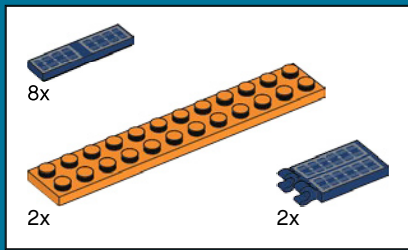

143

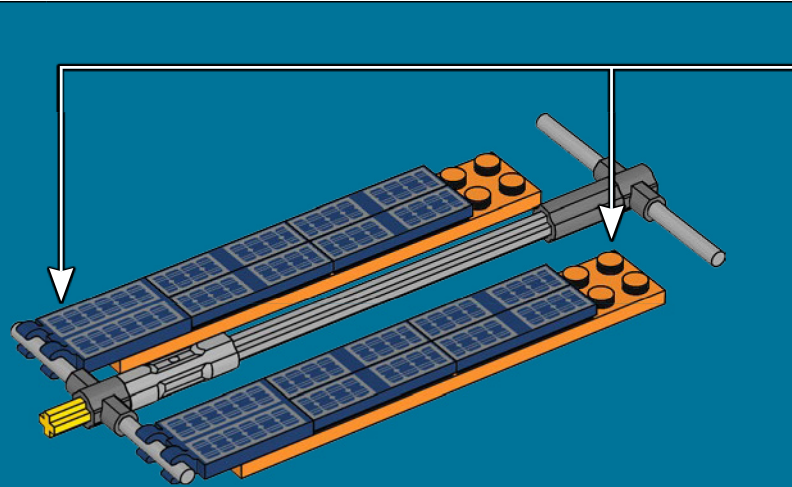
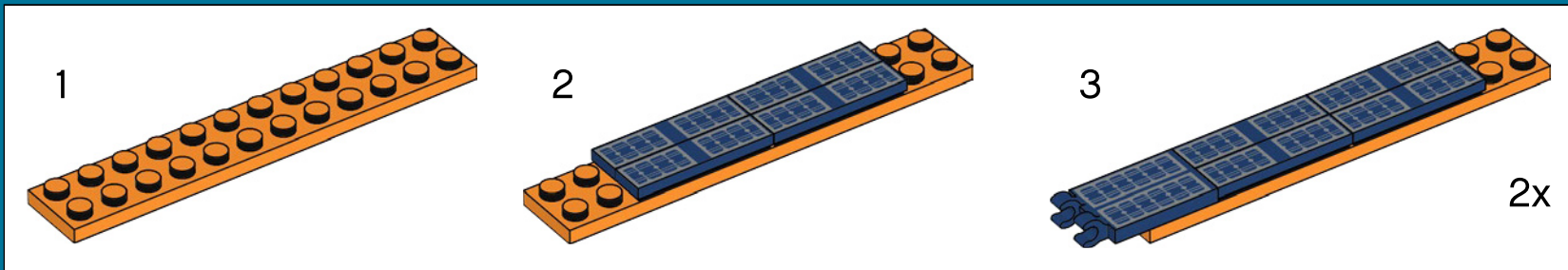

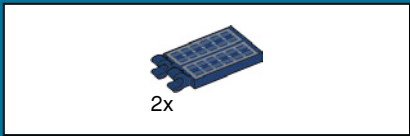

144

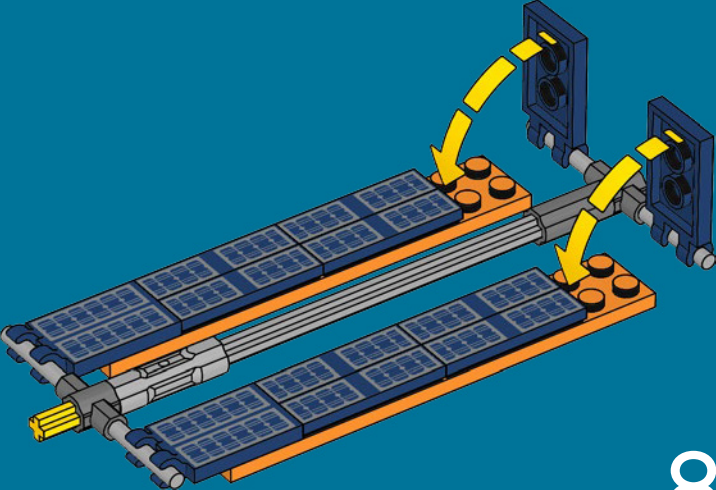

8x

145

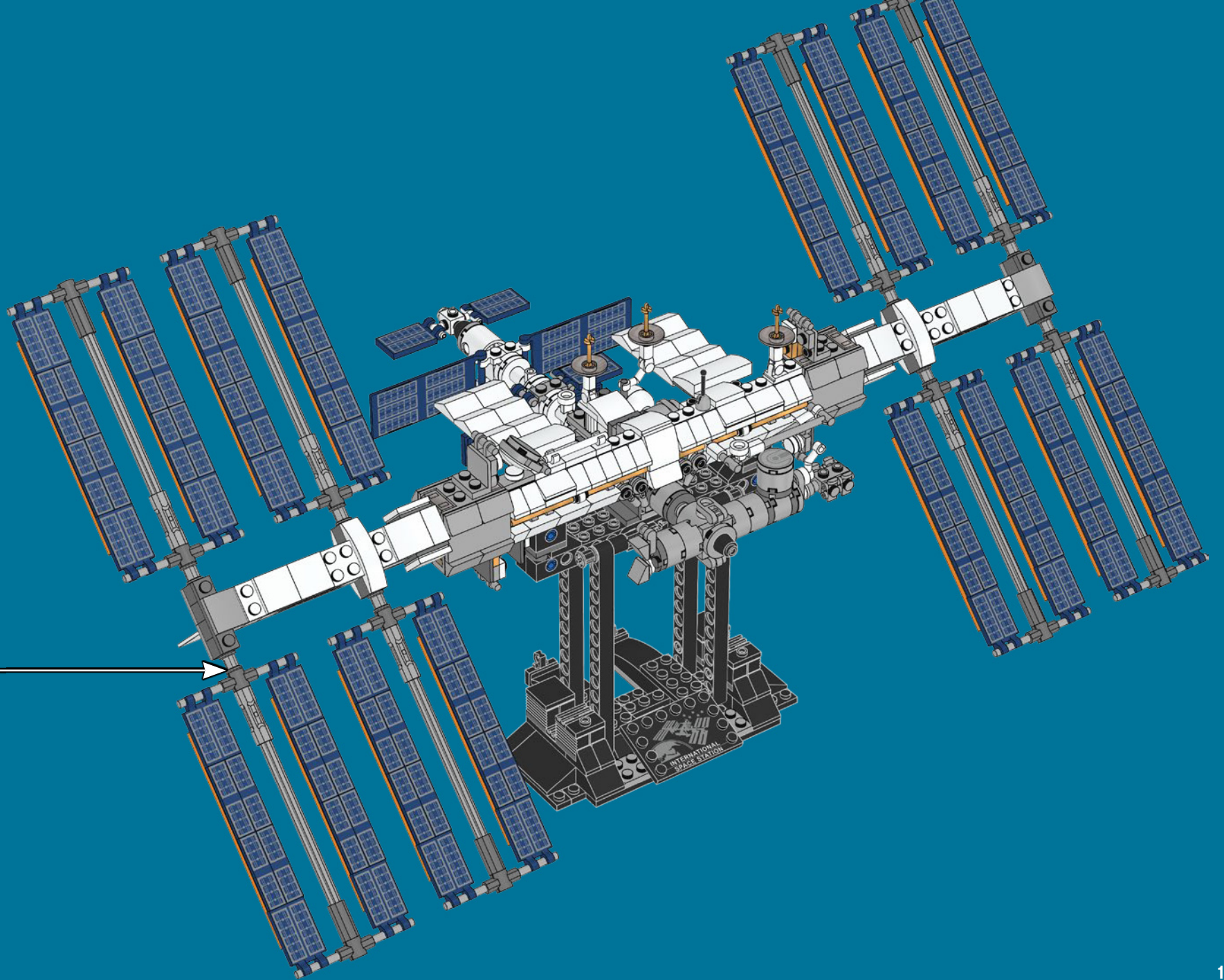

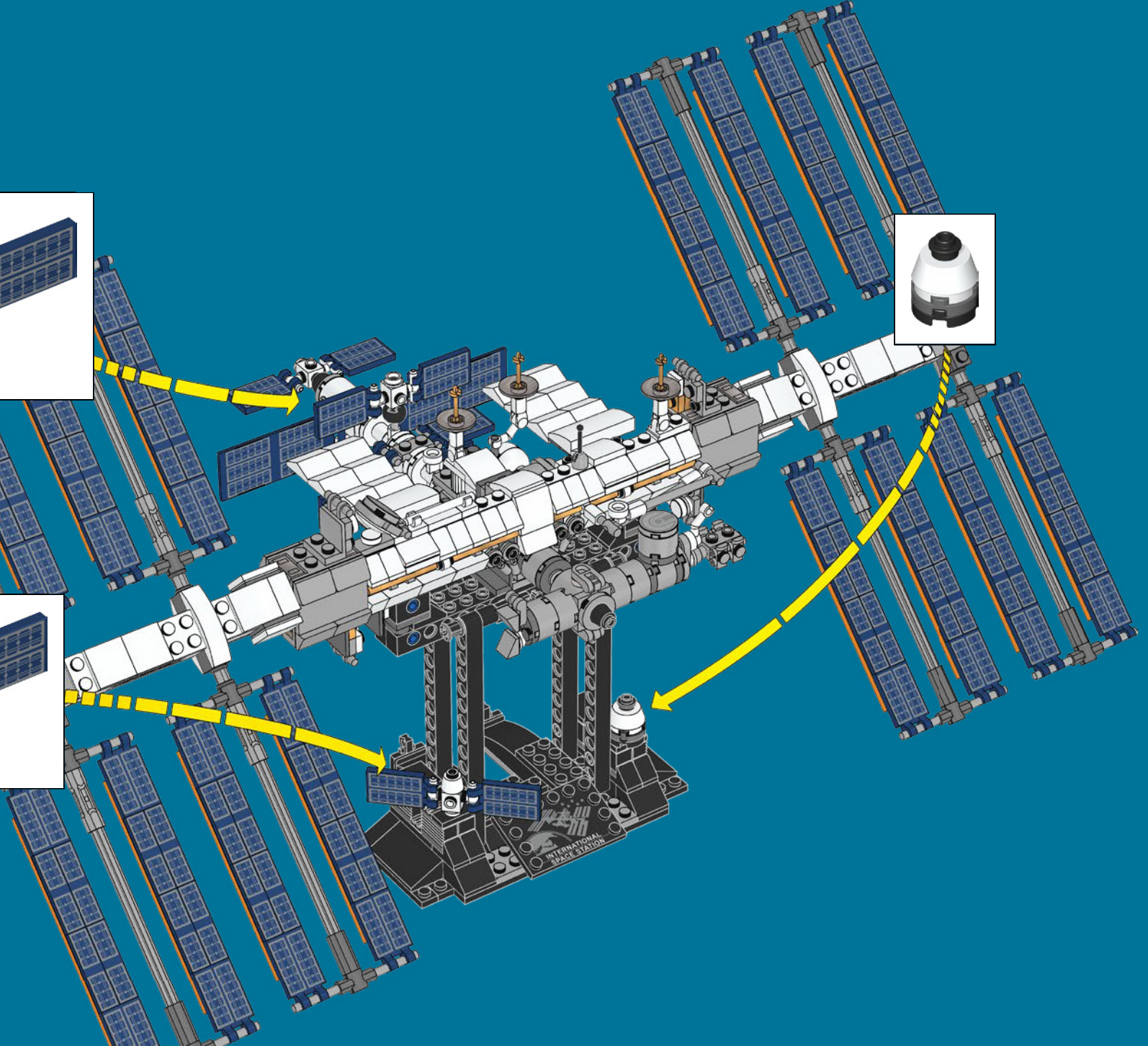
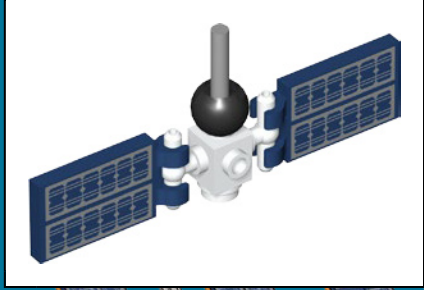

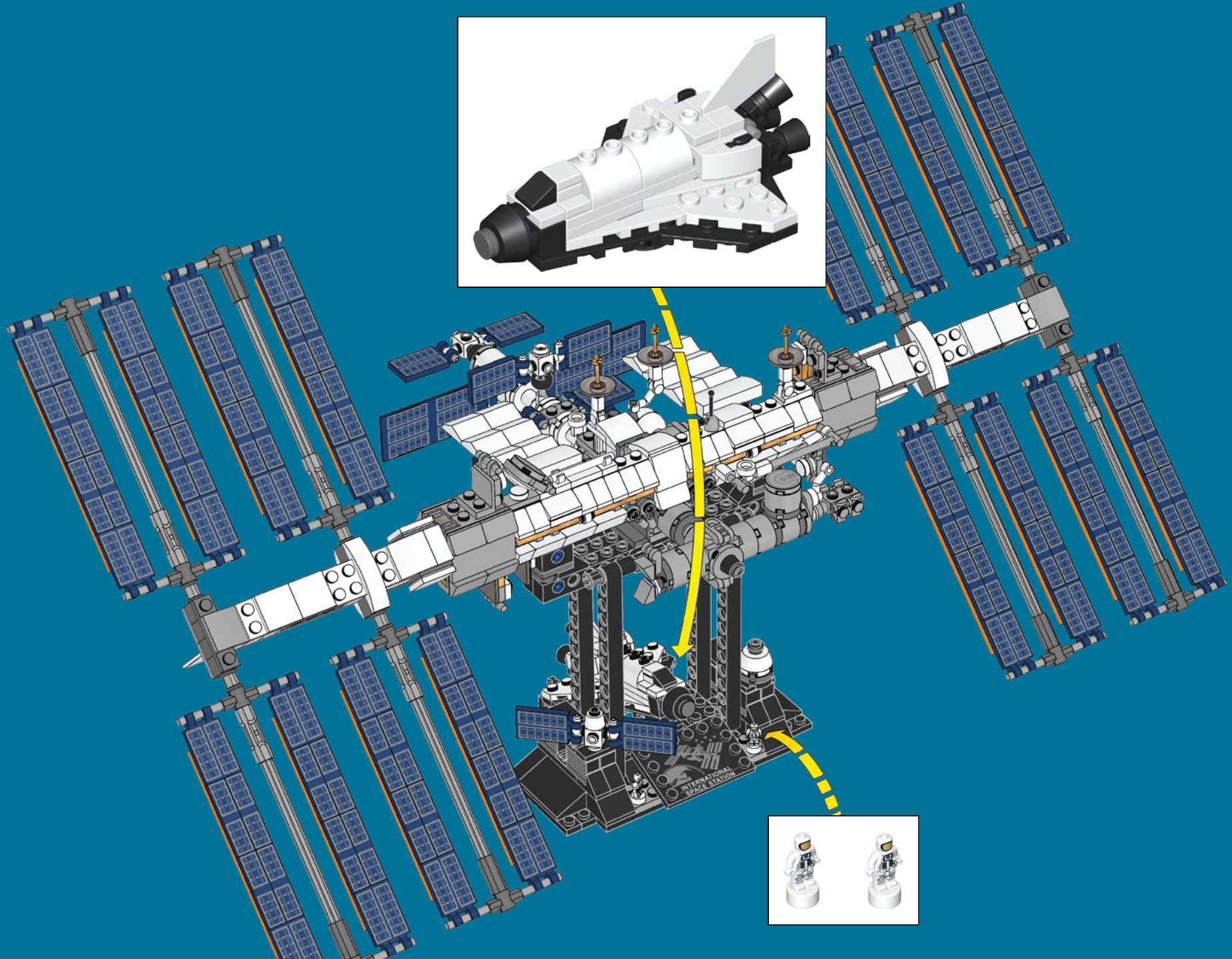
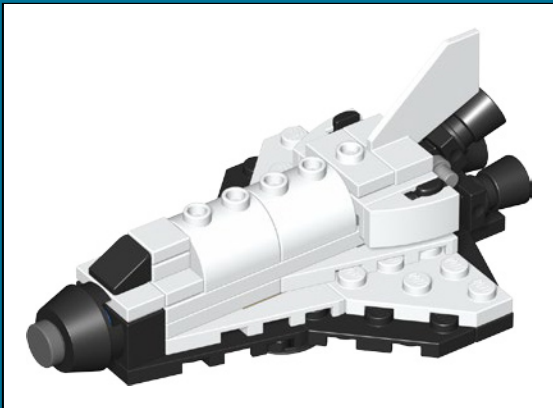



IDEAS

GATHER SUPPORT
HOL DIR UNTERSTÜTZUNG
RASSEMBLE DES VOTES
CHIEDI DI ESSERE SUPPORTATO
GANA APOYOS
OBTÉM APOIO
SZEREZZ TÁMOGATÁST
IEGŪSTI ATBALSTU
获得更多支持

SHARE YOUR IDEA
TEILE DEINE IDEE
PARTAGE TON IDÉE
CONDIVIDI LA TUA IDEA
COMPARTE TU IDEA
PARTILHA A TUA IDEIA
TEDD KÖZZÉ AZ ÖTLETED
DALIES AR SAVU IDEJU
分享您的观点

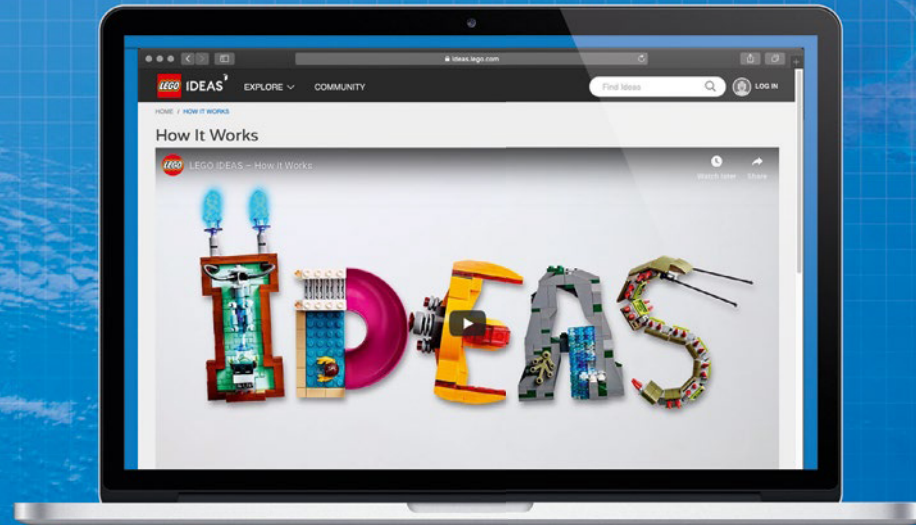

NEW LEGO® PRODUCT
NEUES LEGO® PRODUKT
NOUVEAU PRODUIT LEGO®
NUOVO PRODOTTO LEGO®
NUEVO PRODUCTO LEGO®
NOVO PRODUTO LEGO®
ÚJ LEGO® TERMÉK
JAUNS LEGO® PRODUKTS
新的乐高® 产品

LEGO® REVIEW
LEGO® PRÜFUNG
EXAMEN PAR LEGO®
REVIEW LEGO®
REVISIÓN DE LEGO®
AVALIAÇÃO LEGO®
LEGO® VÉLEMÉNYEZÉS
LEGO® RECENZIJIA
乐高® 评论



[LEGO.com/ideas](https://www.lego.com/ideas)

 FRIENDS and all related characters and elements © & ™ Warner Bros. Entertainment Inc. WB SHIELD: TM & © WBEI. (s19)





Customer Service
 Kundenservice
 Service Consommateurs
 Servicio Al Consumidor
LEGO.com/service or dial

 : 00800 5346 5555
 : 1-800-422-5346



IDEAS



Do you like this LEGO® Ideas set?

The LEGO Group would like your opinion on the new product you have just purchased. Your feedback will help shape the future development of this product series.

Please visit:

[LEGO.com/productfeedback](https://www.lego.com/productfeedback)

By completing our short feedback survey, you will be automatically entered into a drawing to win a LEGO® prize.

Terms & Conditions apply.