



Architecture

21052

Dubai

United Arab Emirates

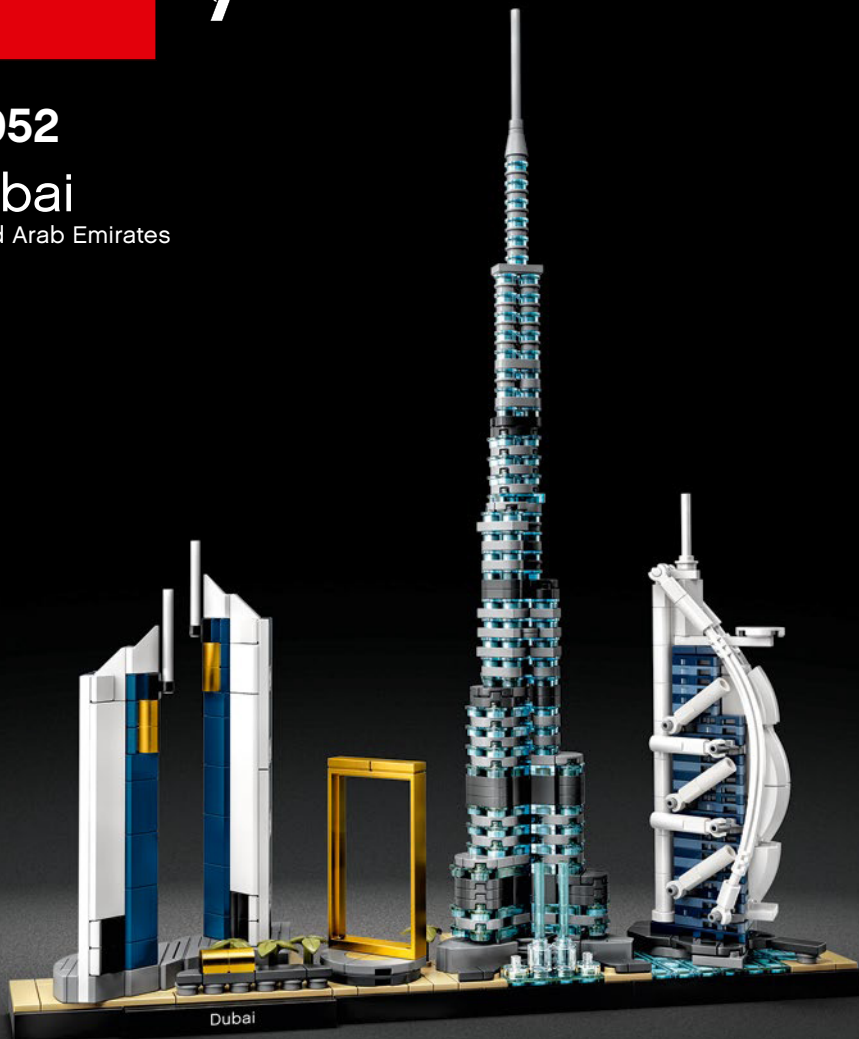

Booklet available in English on
Heft in deutscher Sprache erhältlich auf
Livret disponible en français sur
Libretto disponibile in italiano su
Folleto disponible en español en
Folheto disponível em português em
A füzet magyarul ezen a honlapon olvasható:
Buklets latviešu valodā pieejams vietnē
如需中文版手册, 请访问

LEGO.com/architecture



Dubai

At the crossroads of Europe, Asia and Africa, Dubai is a vibrant blend of traditional Arabian culture and futuristic metropolis. Established as a modern international hub for trade, transport and tourism, it also contains some of the boldest architectural statements in the world.



"...a place where everybody from all over the world meets each other"

HH Sheikh Mohammed bin Rashid Al Maktoum





Jumeirah Emirates Towers

Soaring high above Dubai's financial district, the Jumeirah Emirates Towers are among the most iconic in the city. The larger of the two towers houses an office complex, while the smaller tower is a luxury 56-floor, 400-room hotel. The exterior of the triangular structures is inspired by traditional Islamic themes.



Dubai Frame

Dubai's latest architectural landmark is the impressive Dubai Frame. Measuring 492 ft. (150m) high and 305 ft. (93m) wide, the structure metaphorically frames the development of the city's past and present, while offering a panoramic view of the Emirate.

The Dubai Fountain

The Dubai Fountain is the world's largest choreographed fountain experience. Set in the 30-acre (12 ha), man-made Burj Khalifa Lake, it shoots water 500 ft. (152m) into the air in time to a range of classical, modern and Arabic music.



Burj Khalifa

Towering 2,716.5 ft. (828m) above downtown Dubai, Burj Khalifa has been the tallest building in the world since its completion in 2010. Described as a “vertical city,” the architects incorporated many patterns and elements from traditional Islamic architecture within its ultra-modern design.

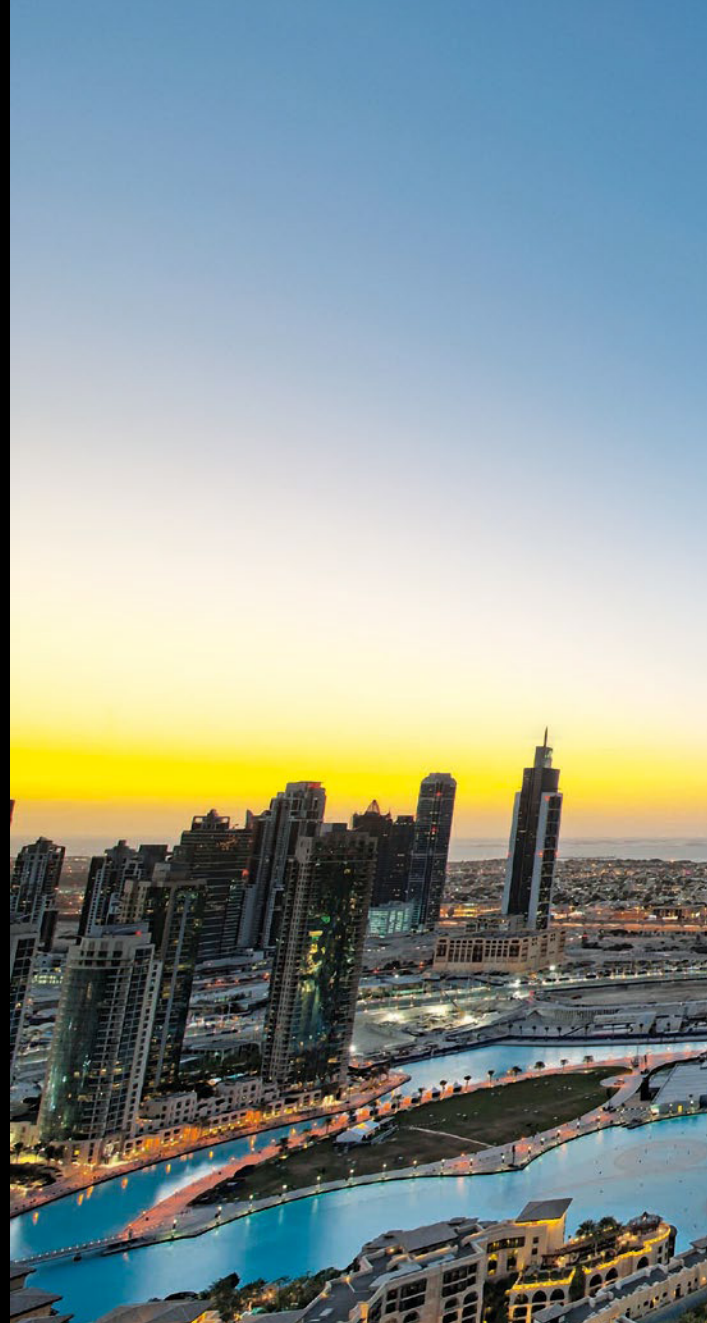

An aerial photograph of the Burj Khalifa in Dubai, United Arab Emirates, during the "blue hour" of dusk. The skyscraper is the central focus, its spire reaching towards a clear, deep blue sky. The building's facade is illuminated with warm lights, and its reflection is visible in the water of the Burj Khalifa Lake. In the foreground, the circular base of the tower is surrounded by modern architecture, including the Dubai Mall and the Dubai Opera. The city skyline is visible in the background, with other skyscrapers and buildings lit up. The overall scene is a vibrant display of modern urban architecture and engineering.

"The race for excellence has no finish line."

HH Sheikh Mohammed bin Rashid Al Maktoum



Burj Al Arab



The distinctive sail-shaped silhouette of the Burj Al Arab Jumeirah has become an icon of modern Dubai. Built on a triangular, man-made island, the 1,053 ft. (321m) tall hotel boasts both a helipad and an underwater aquarium restaurant reached through a simulated submarine voyage.

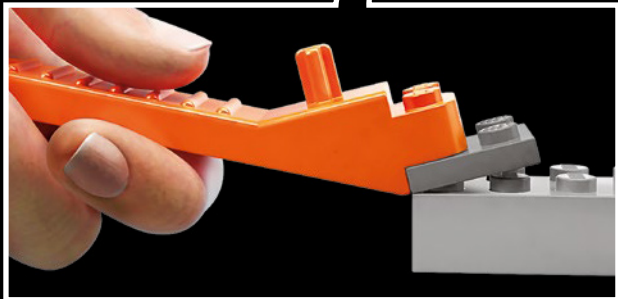
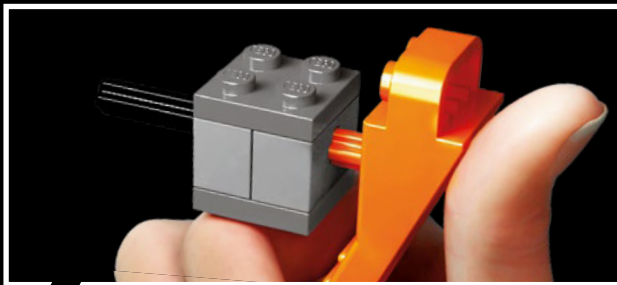
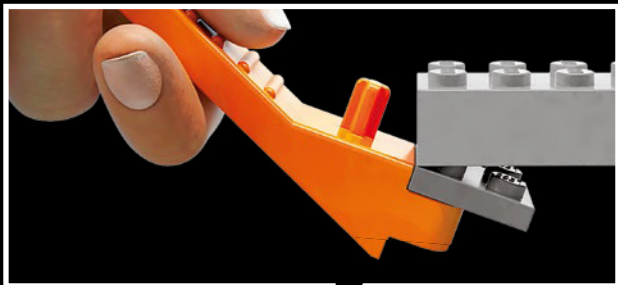



- 1** Scan the code on the front cover
 Scanne den Code auf der Titelseite
 Scanne le code sur la page de couverture
 Scanner le code sur la page couverture
 Scansiona il codice sulla copertina
 Escanea el código de la portada
 Faz scan do código na frente da capa
 Olvasd be a borítón látható kódot!
 Noskenē kodu uz priekšējā vāka
 扫描封面上的二维码

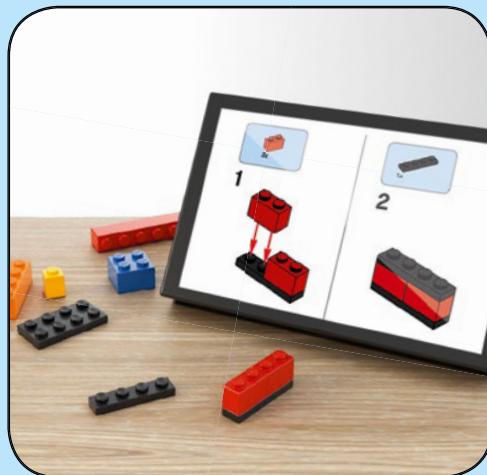

- 2** Get the Building Instructions
 Hol dir die Bauanleitung
 Obtens les instructions de montage
 Obtenir les instructions de montage
 Scarica le istruzioni per la costruzione
 Consulta las instrucciones de construcción
 Obtém as Instruções de Construção
 Szerezd be az építési útmutatókat!
 Saņem būvēšanas instrukcijas
 获取拼搭说明

LEGO.com/apps

Check for compatibility
 Kompatibilität prüfen
 Vérifier la compatibilité
 Controlla la compatibilità
 Comprueba tu compatibilidad

Verificar a compatibilidade
 Ellenőrizd a kompatibilitást
 Pārbaudīt saderību
 检查兼容性

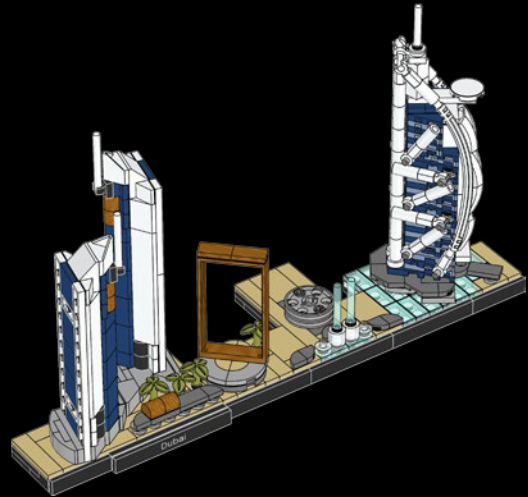
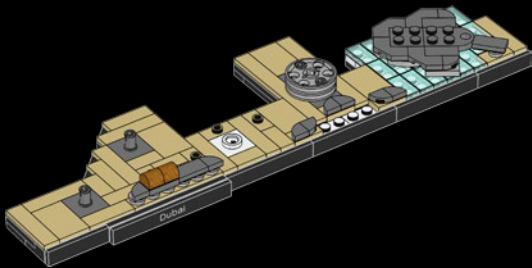

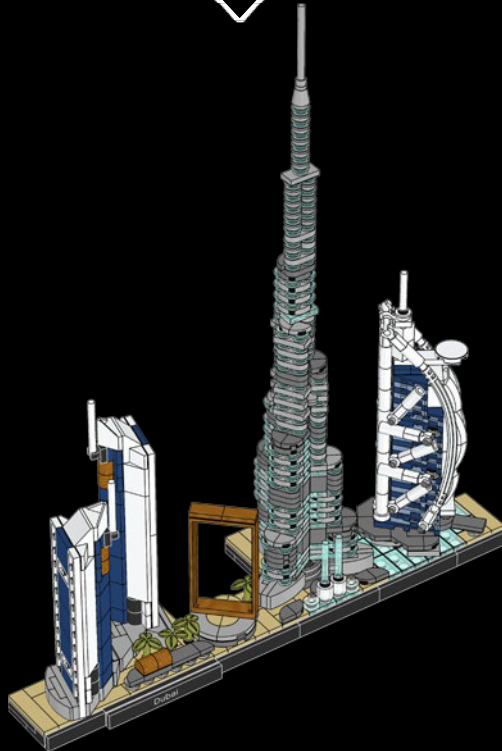

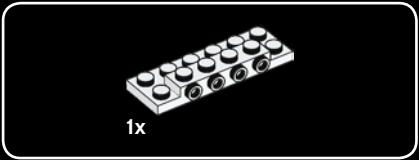

1

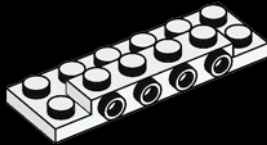
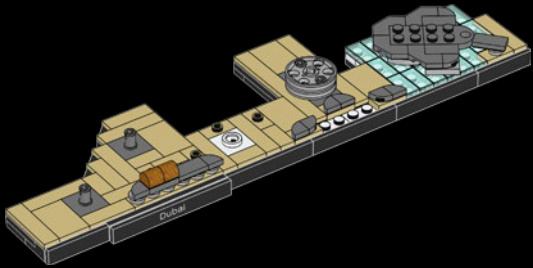

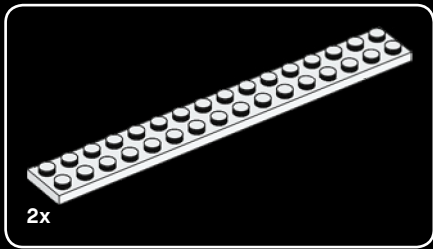

2

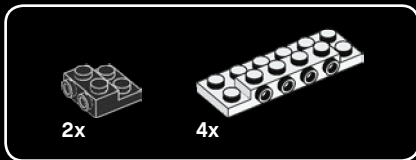
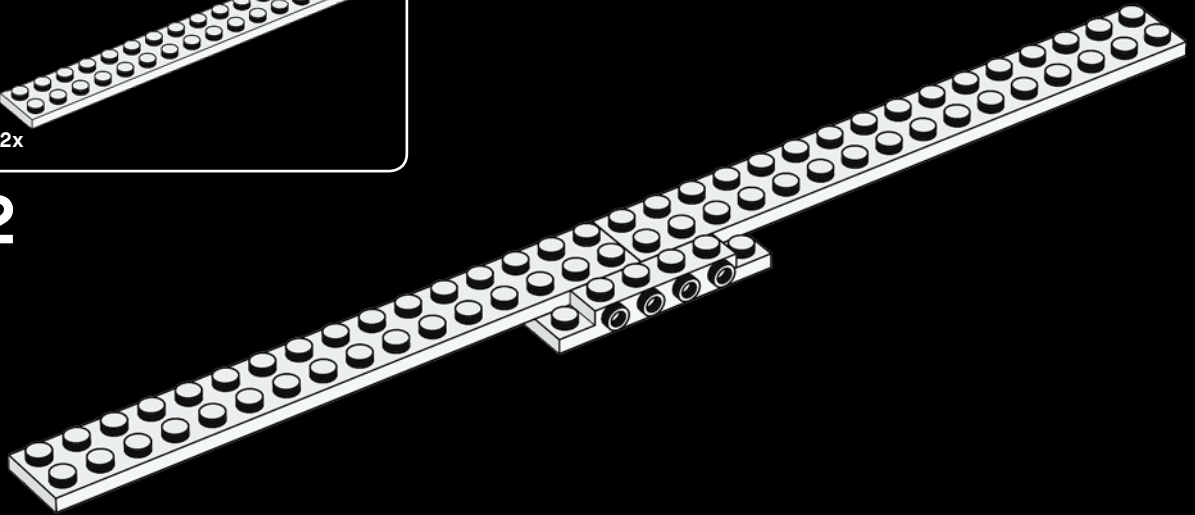

3

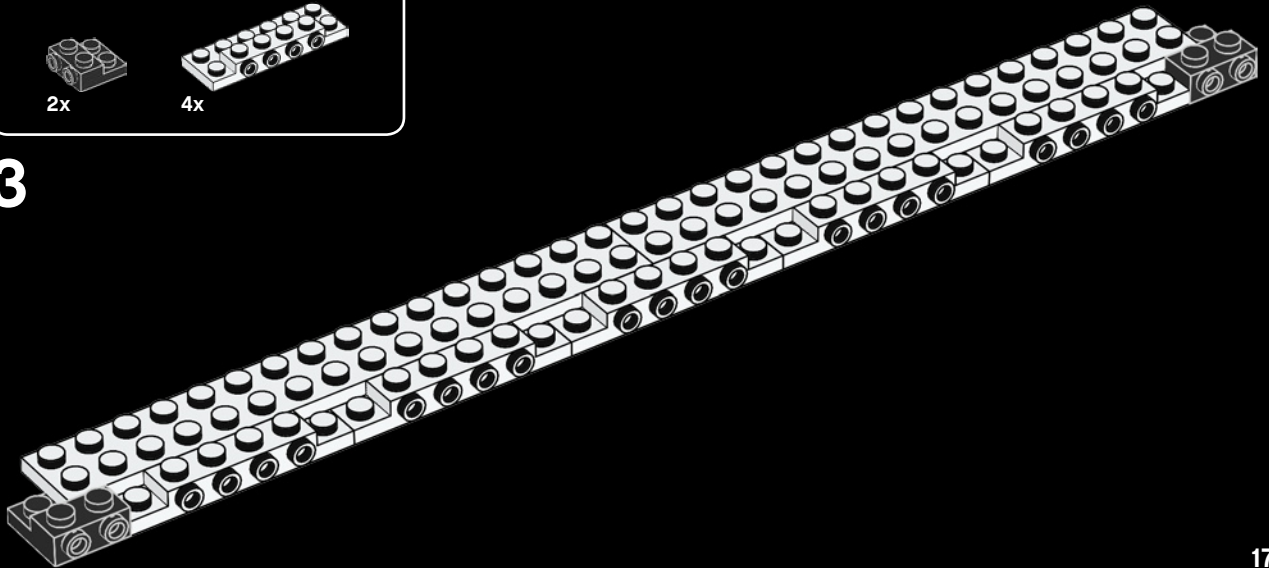



4

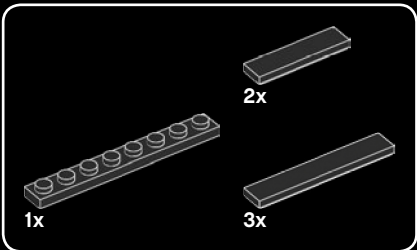
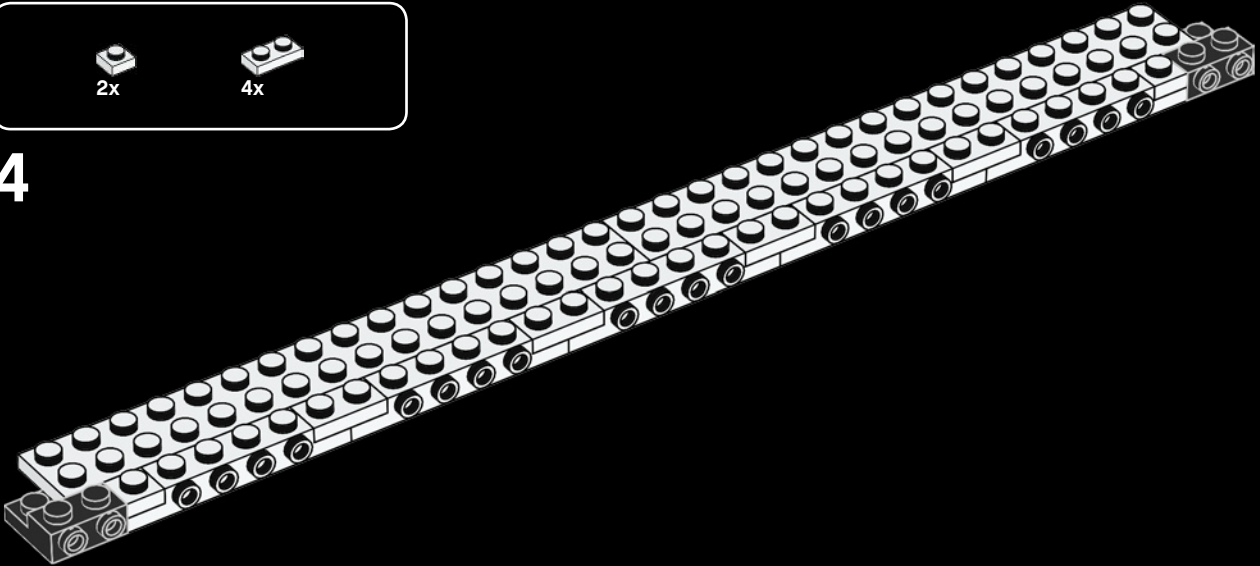

5

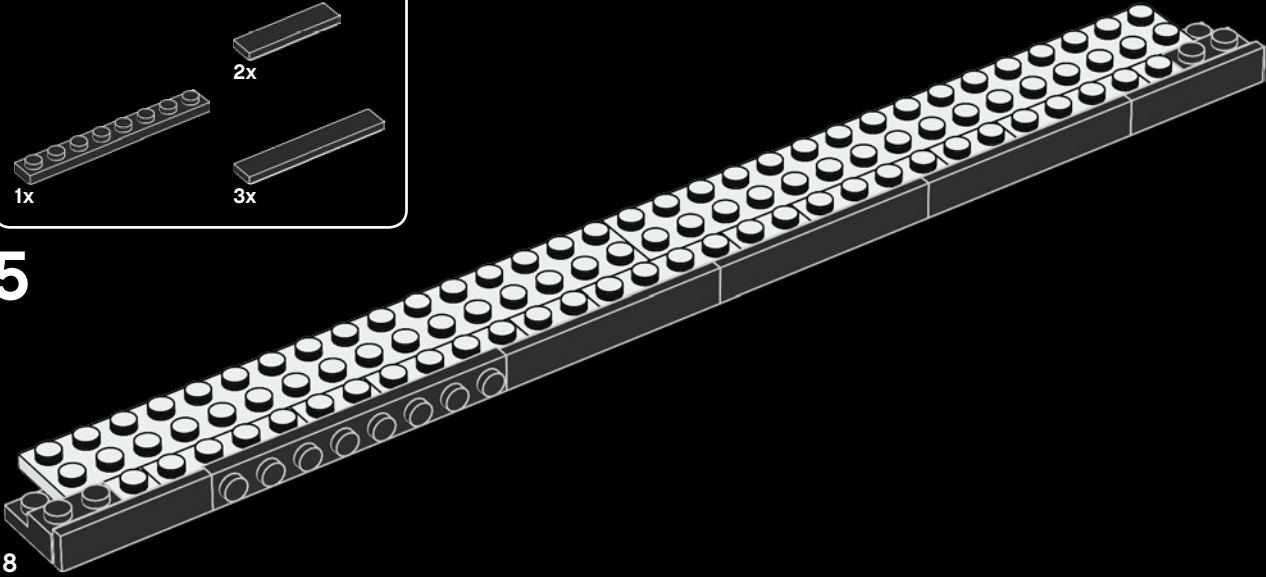

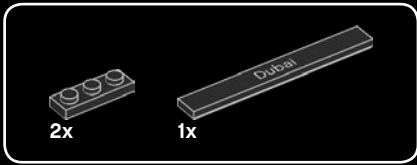

6

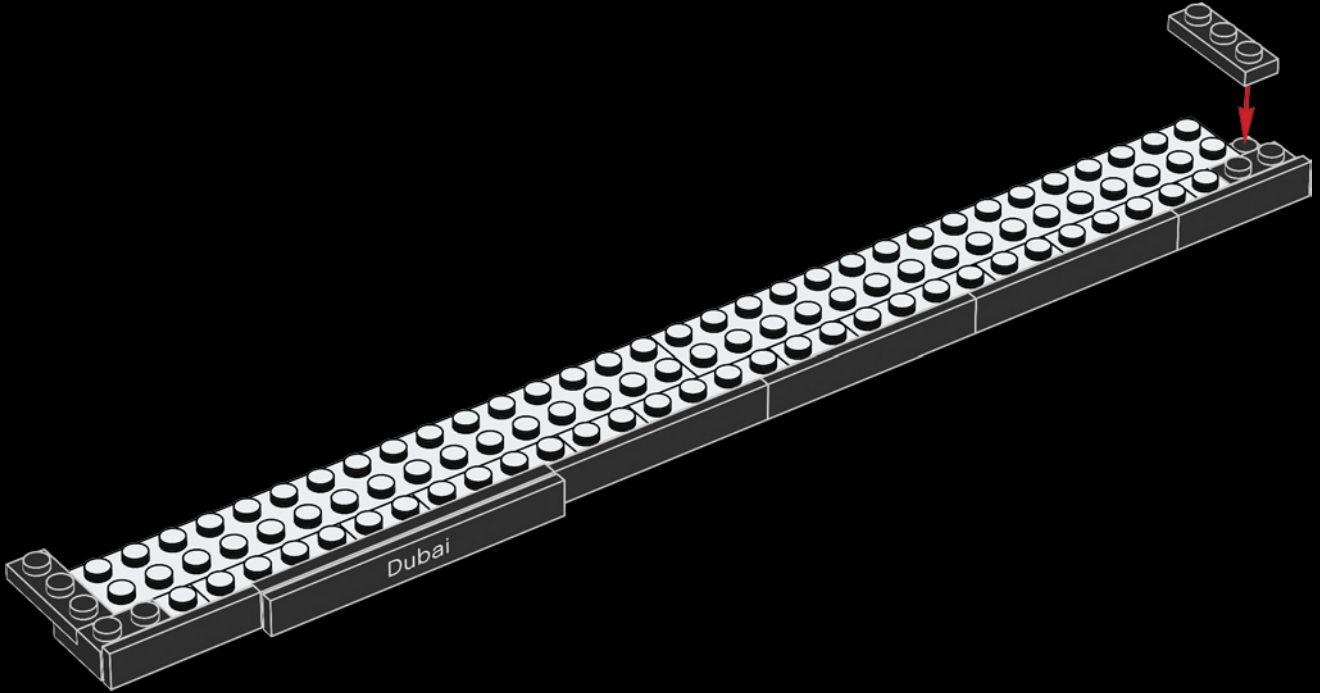

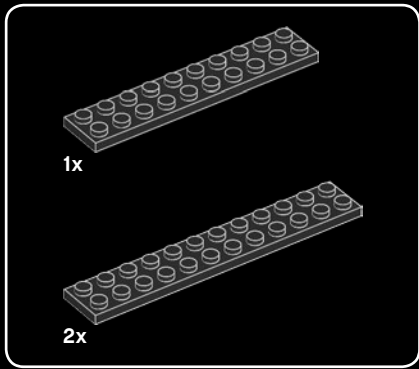

7

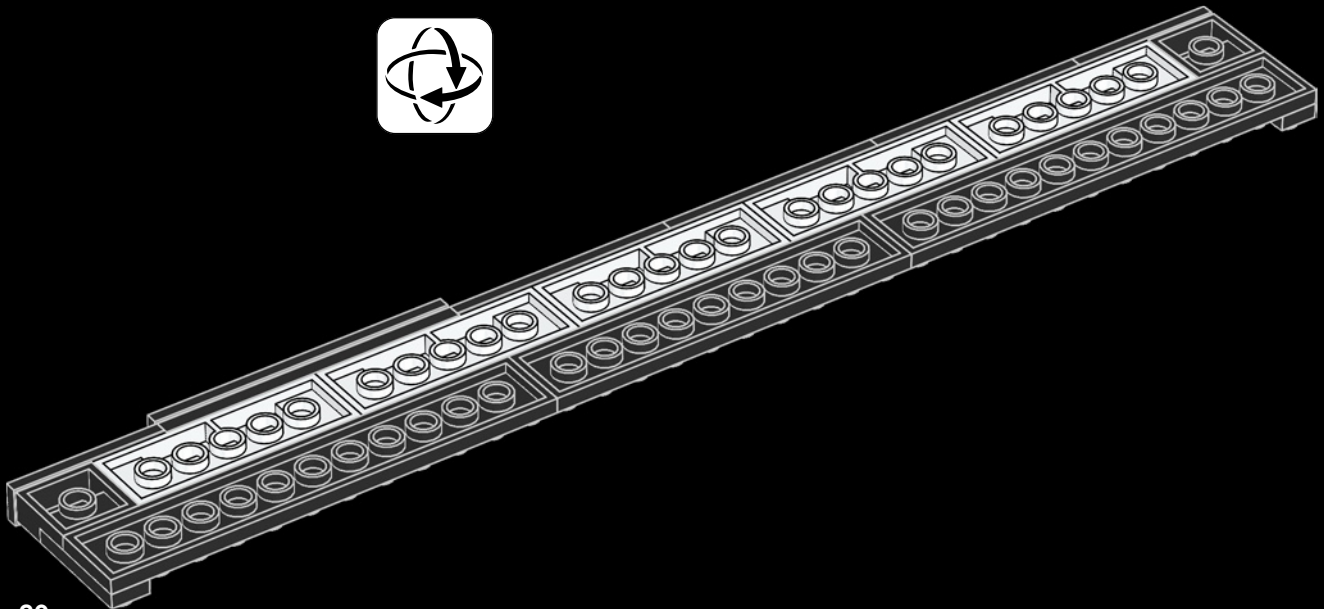

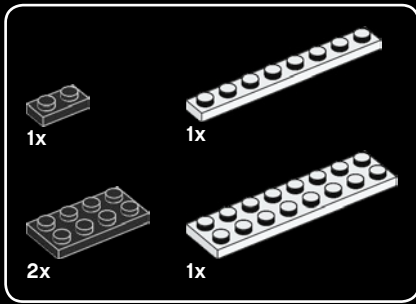

8

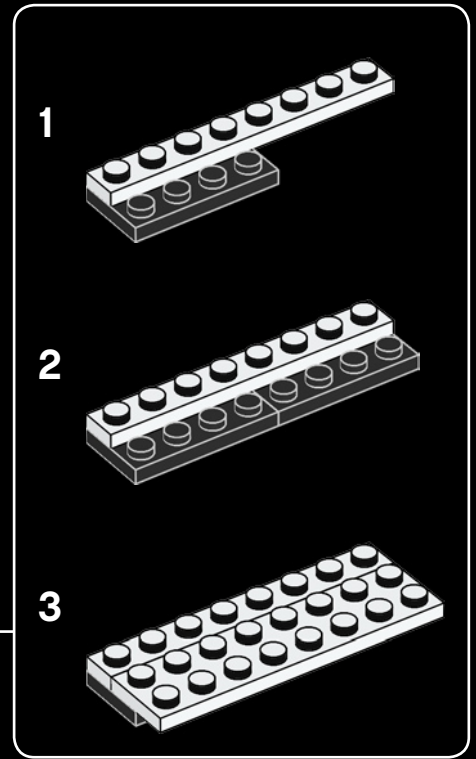
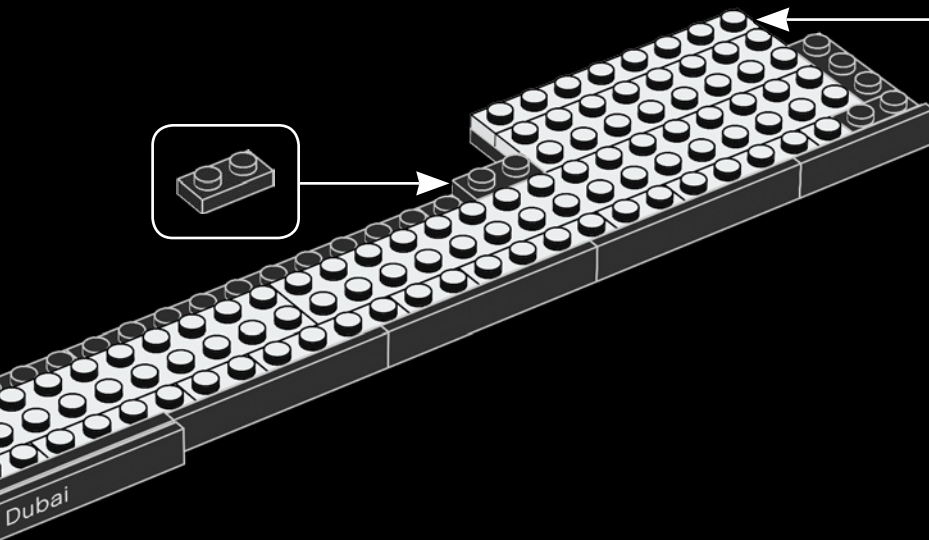

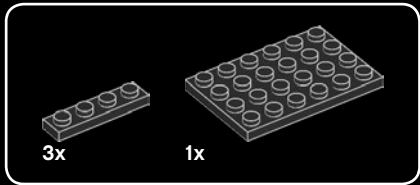

9

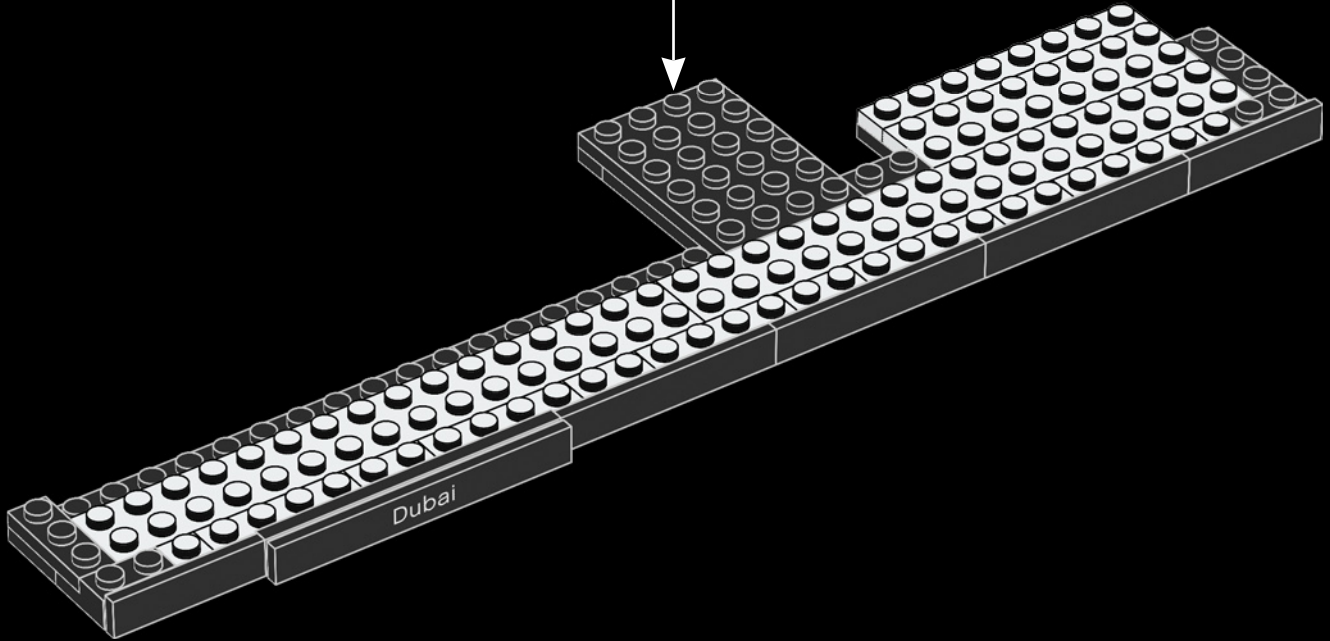
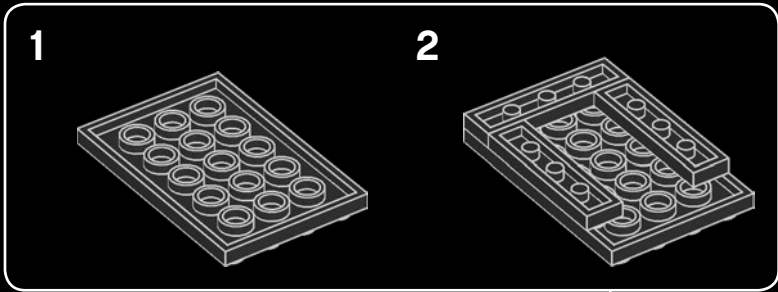

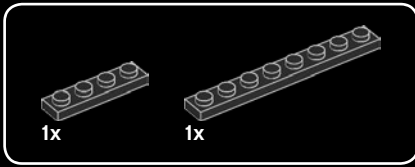

10

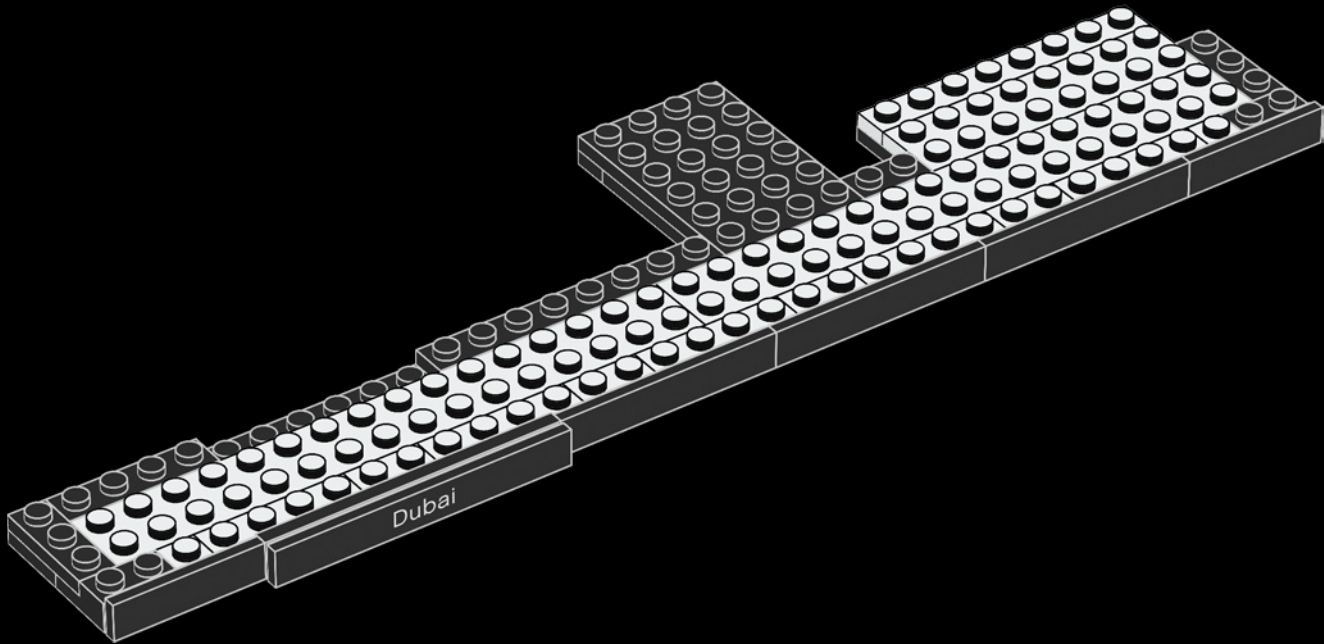

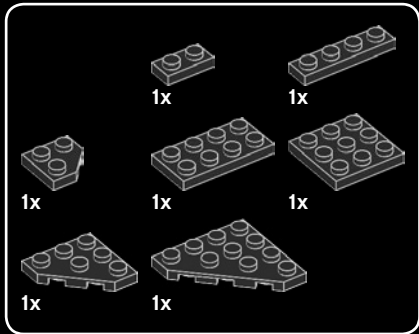

11

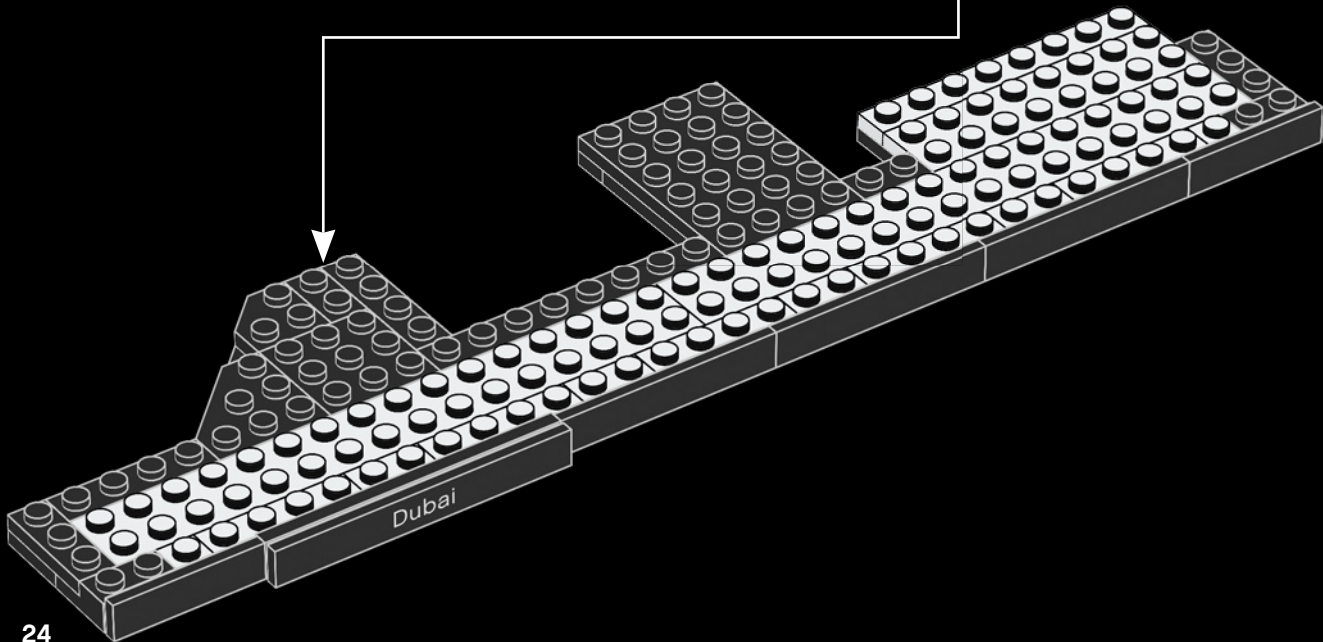
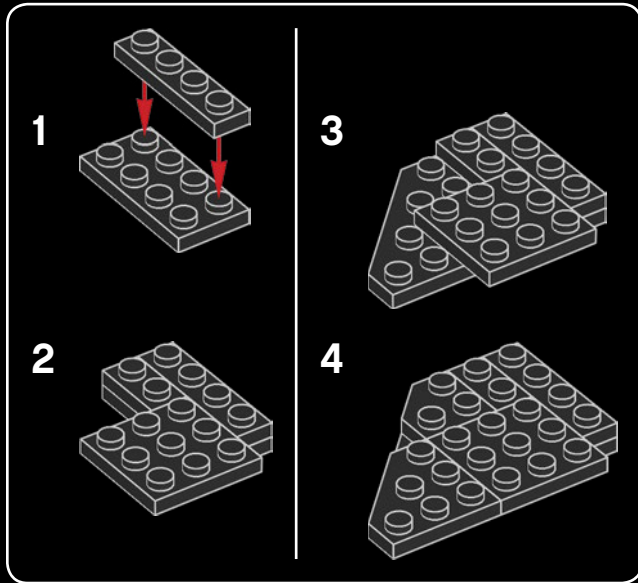

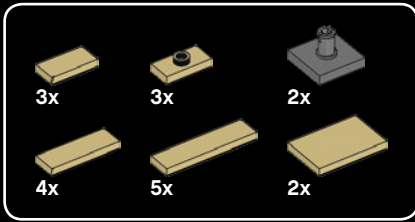

12

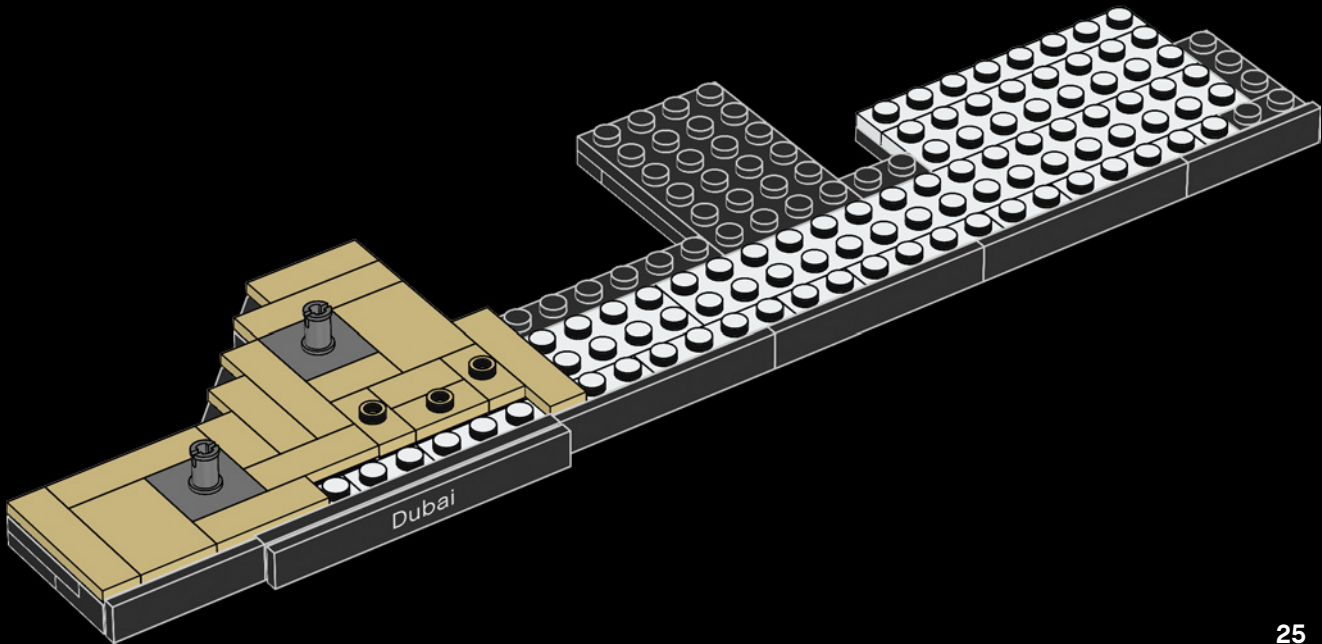

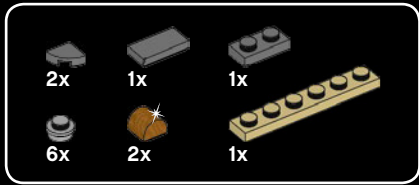

13

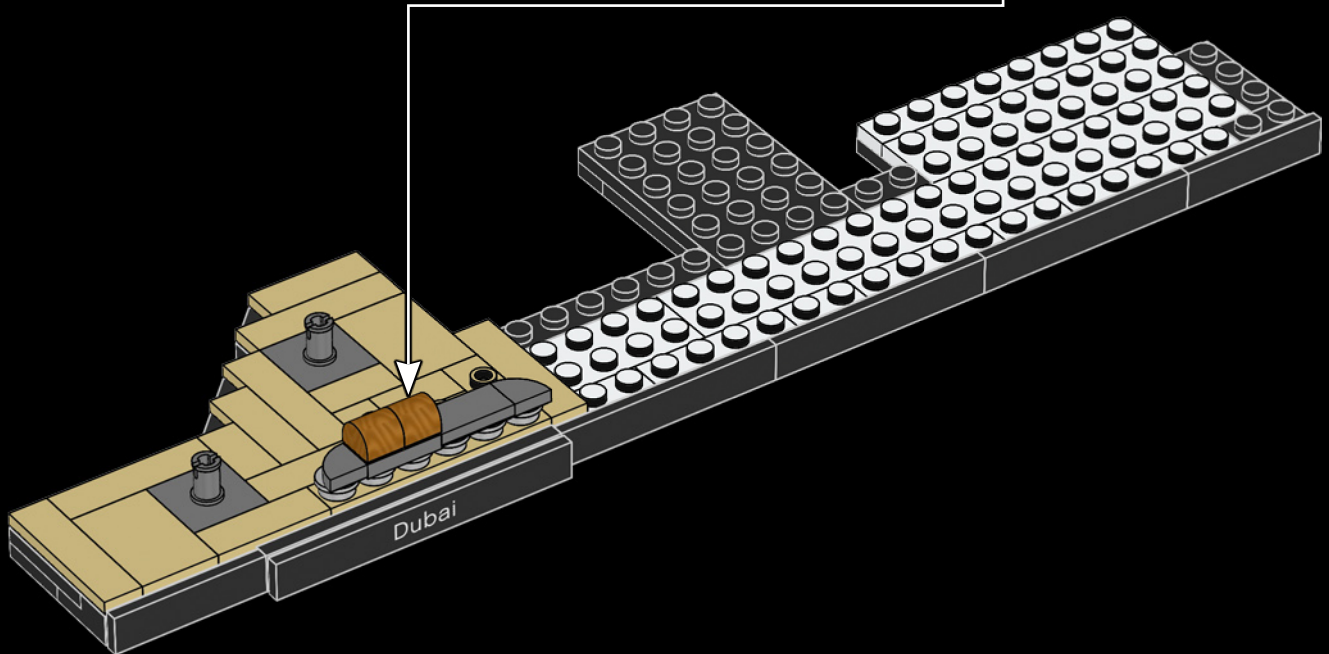
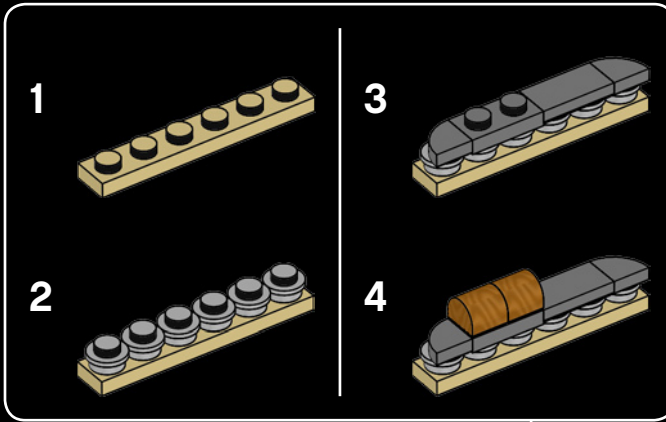

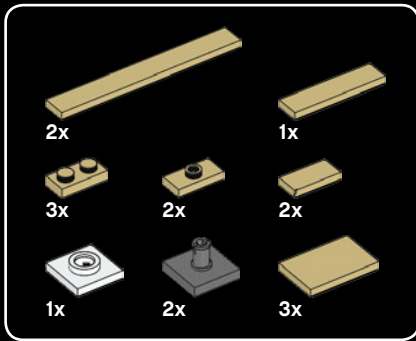

14

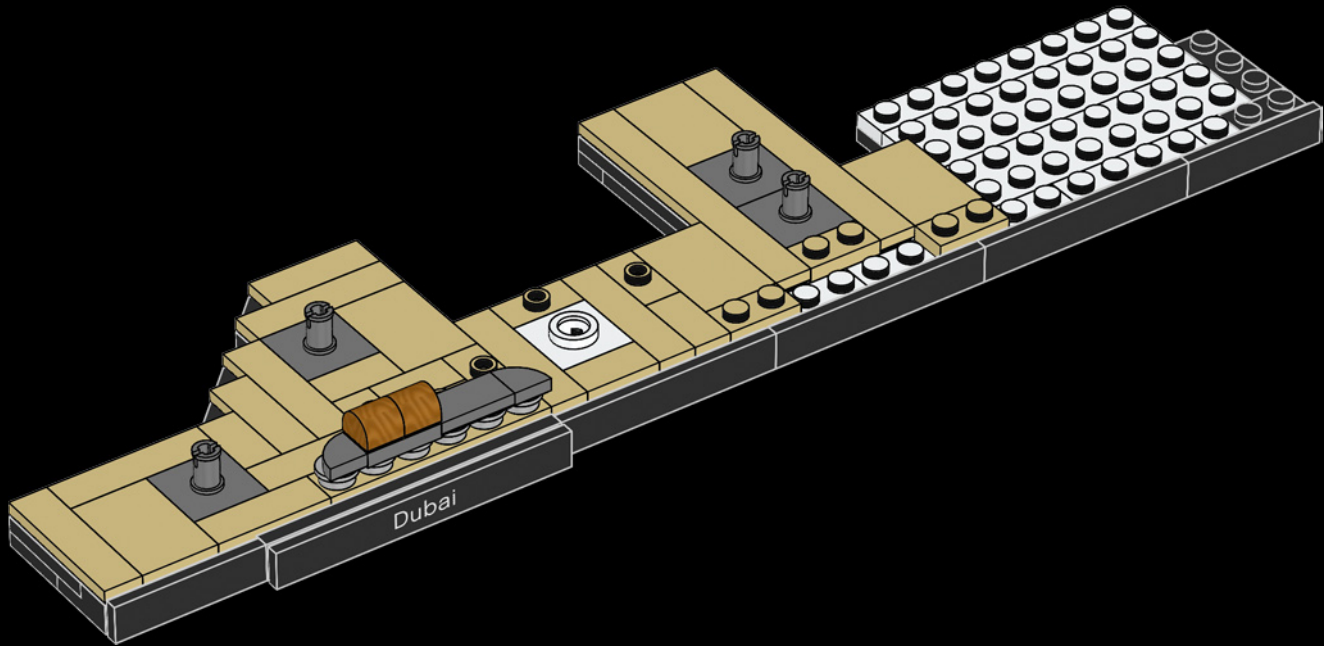

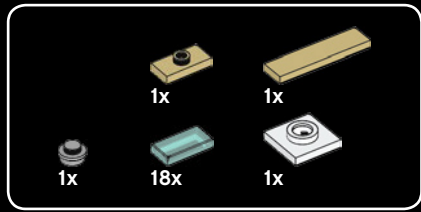

15

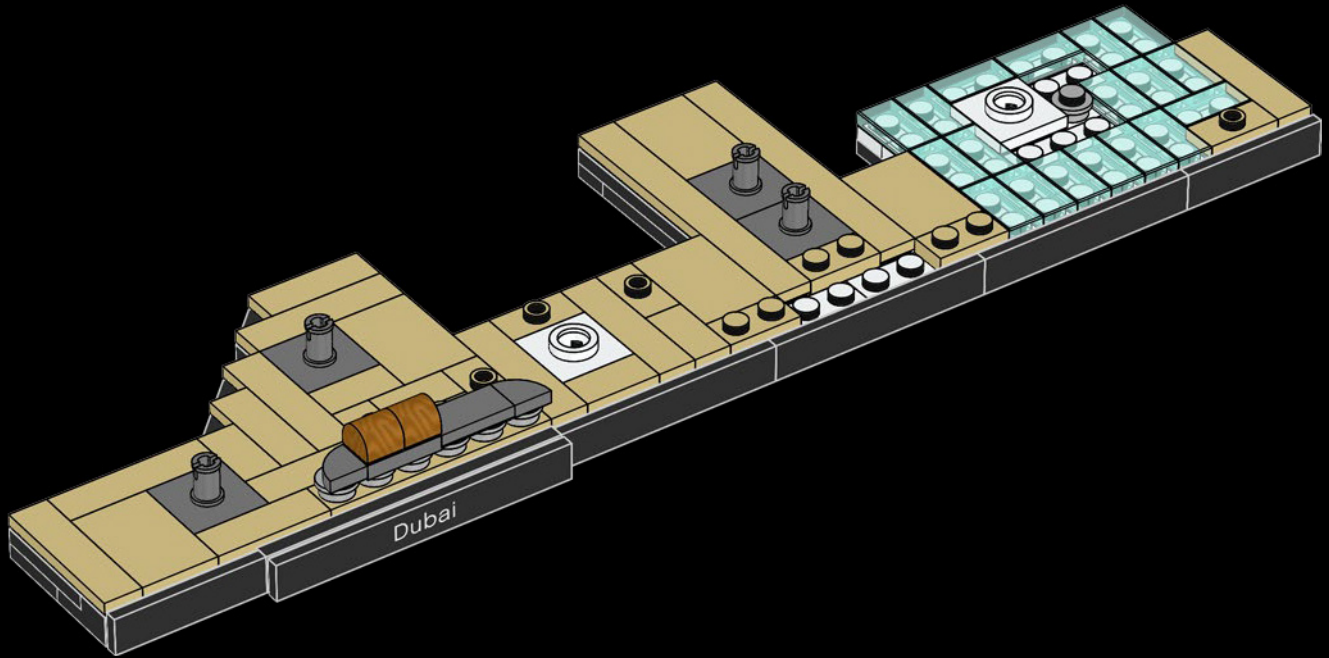

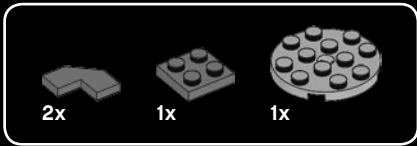

16

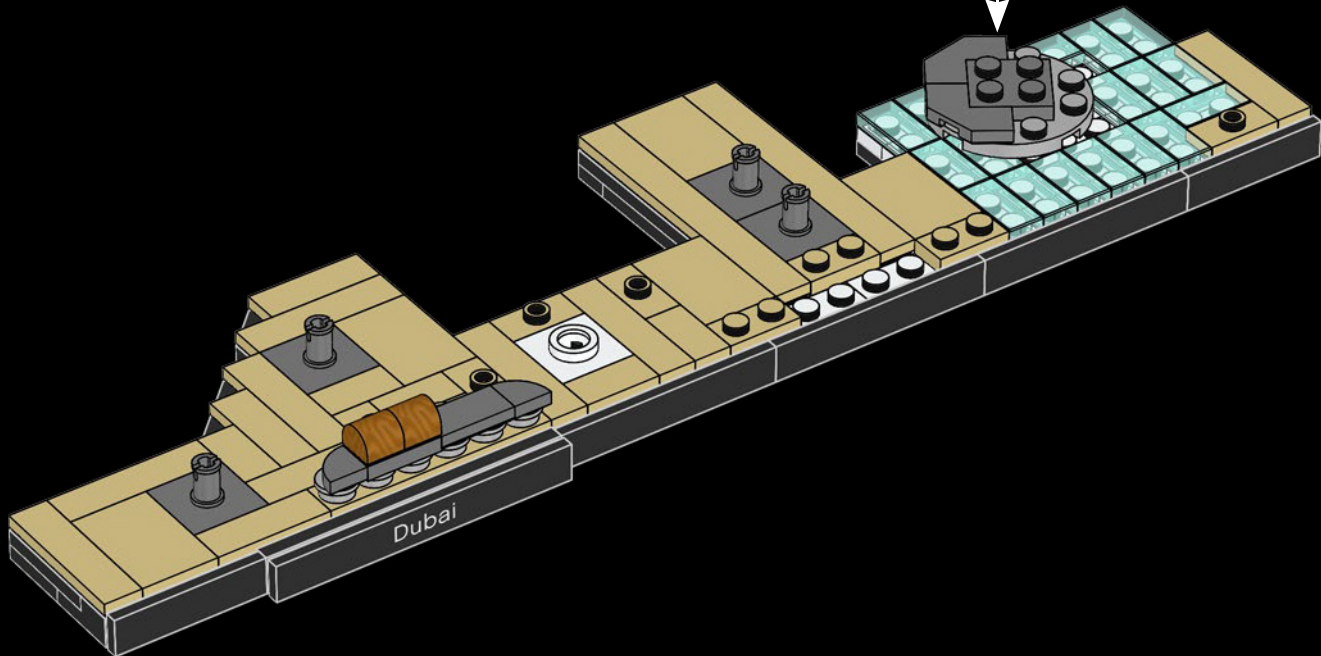
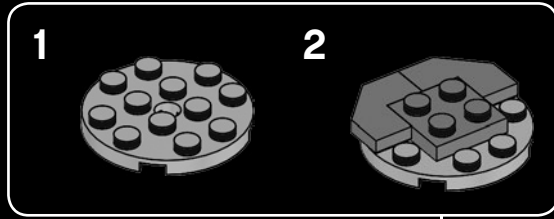

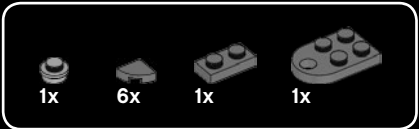

17

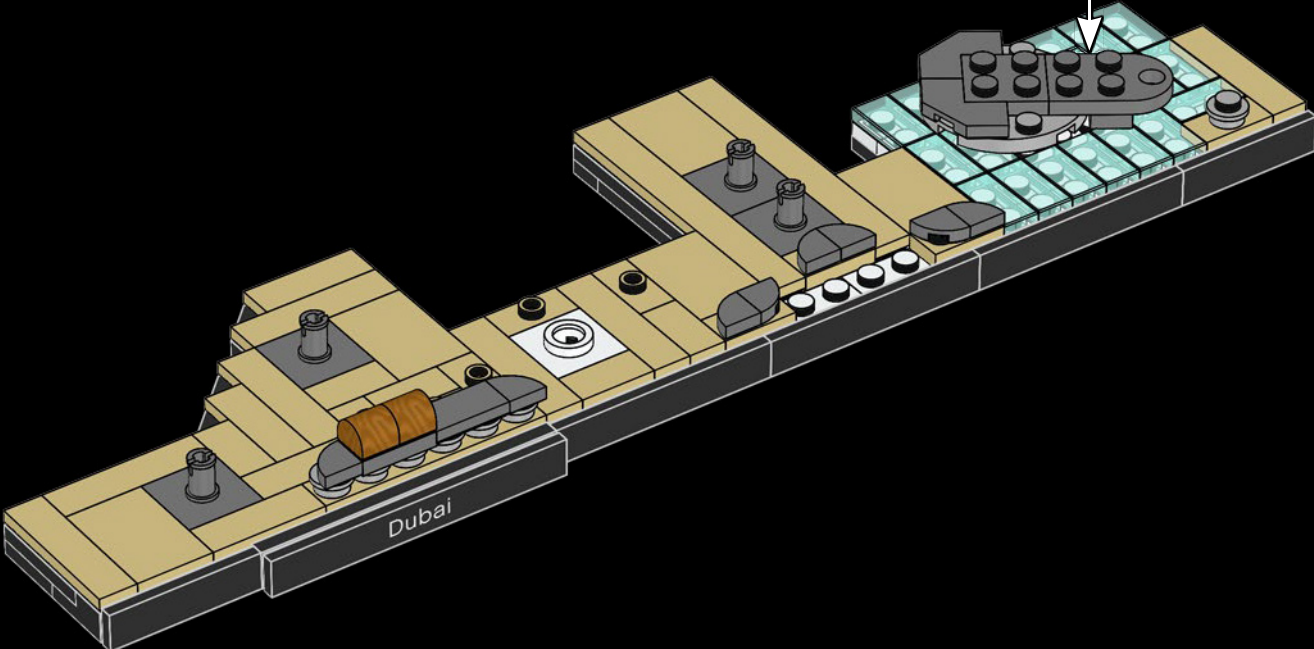
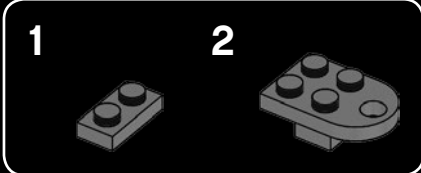

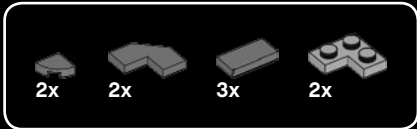

18

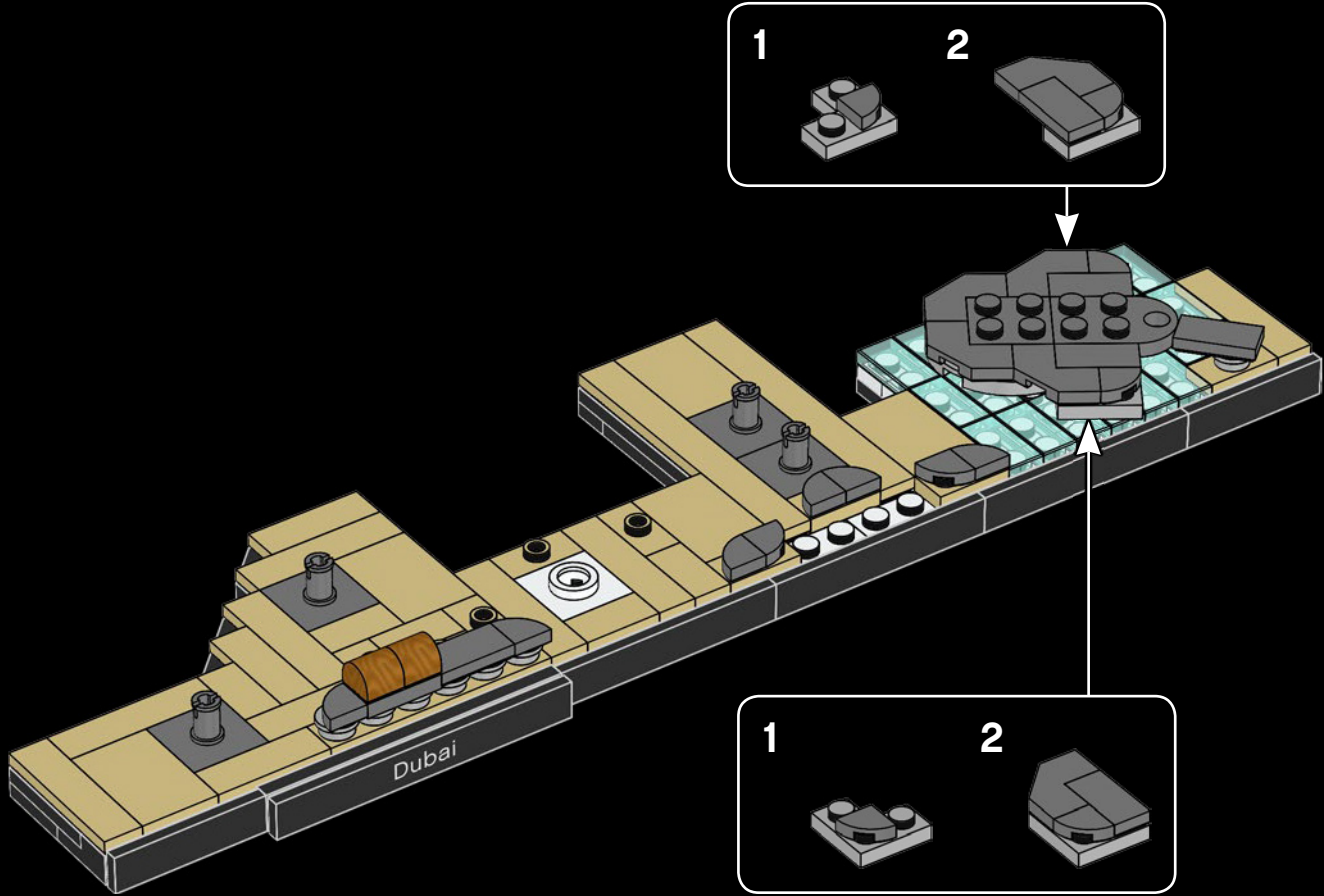



2x

19

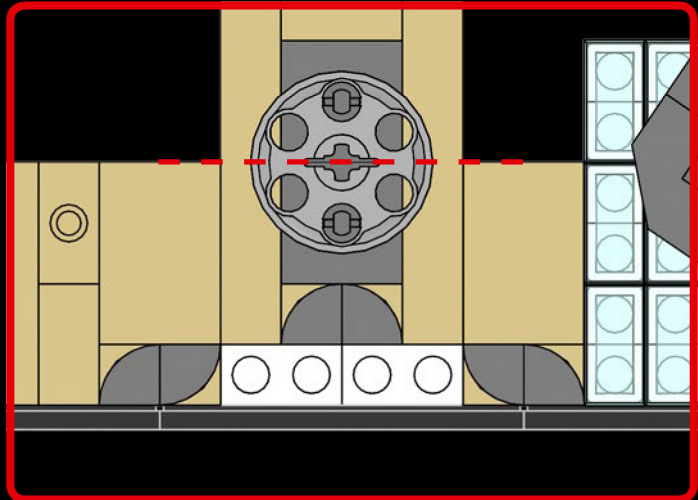
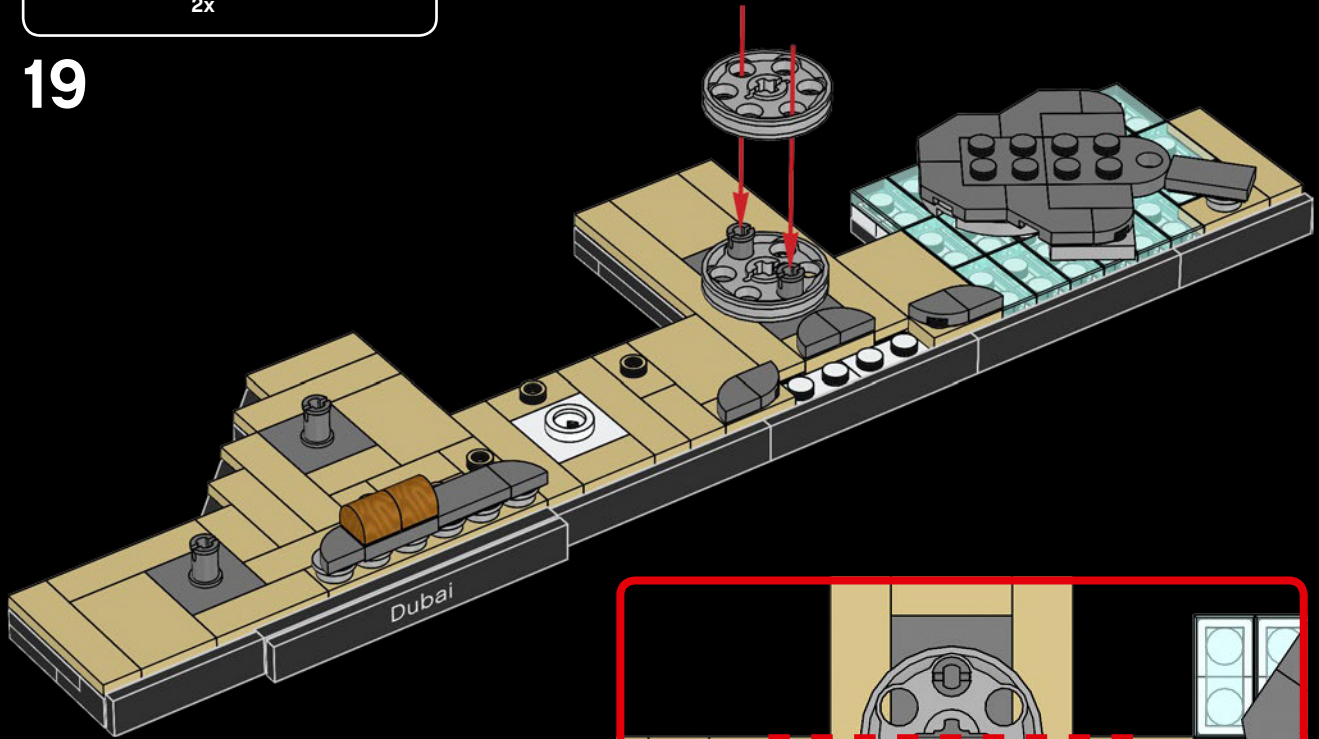

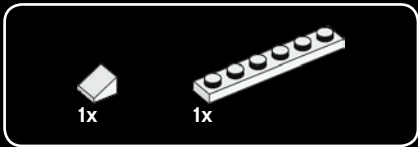
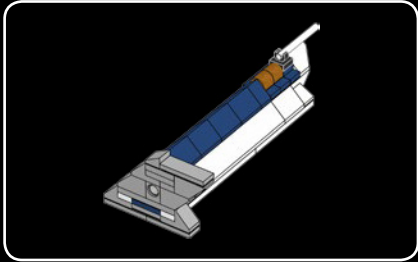
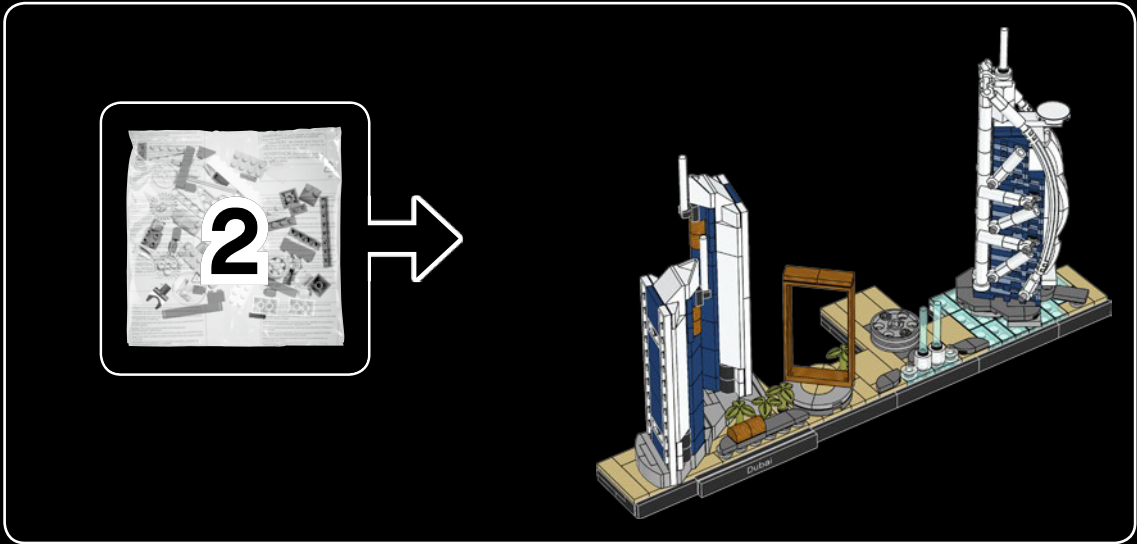

20

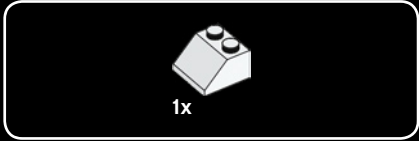
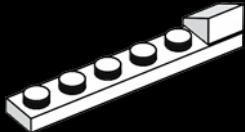

21

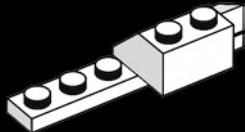

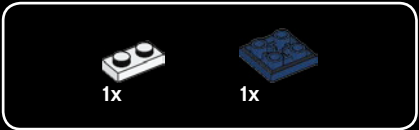

22

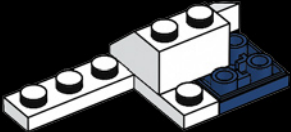

23

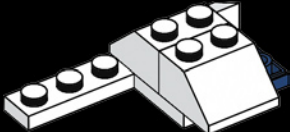

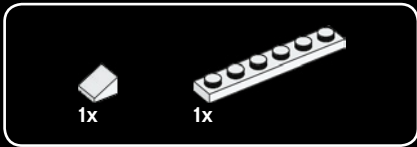

24

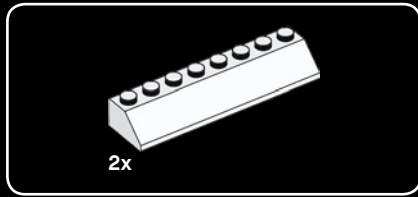
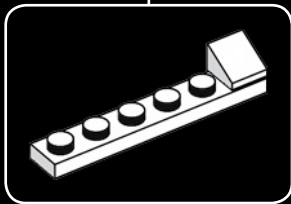
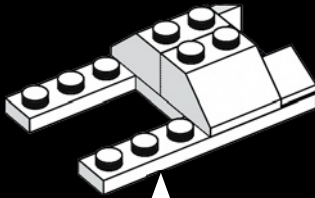

25

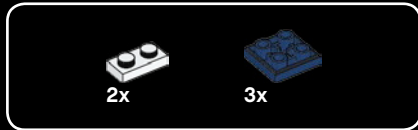
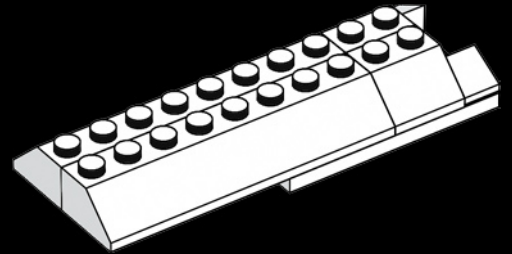

26

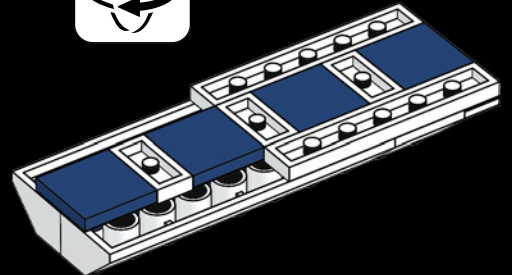

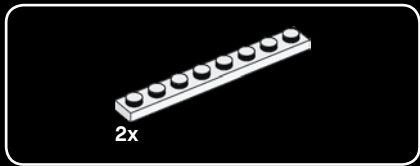

27

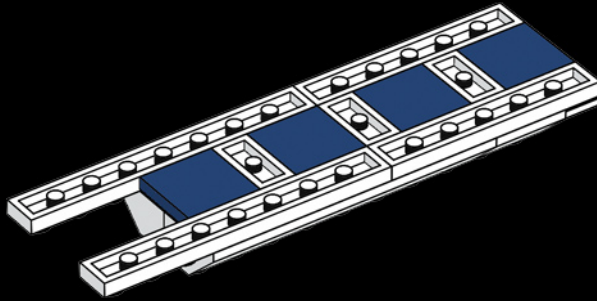

28

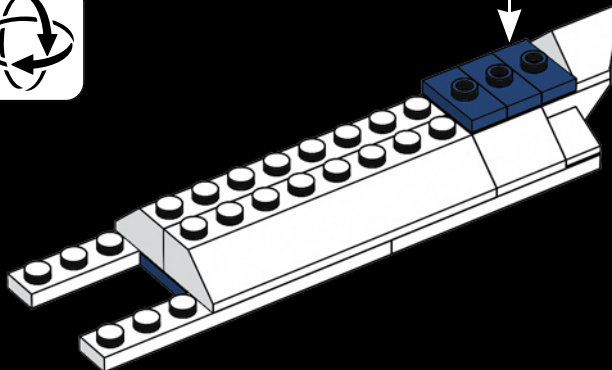
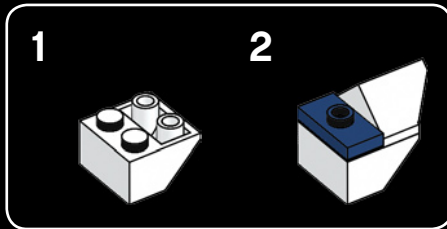



29

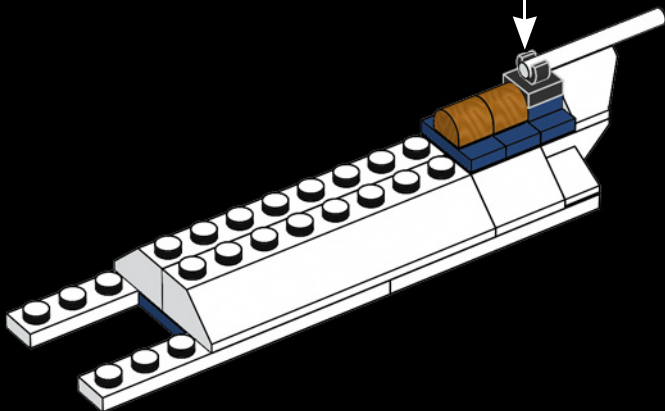
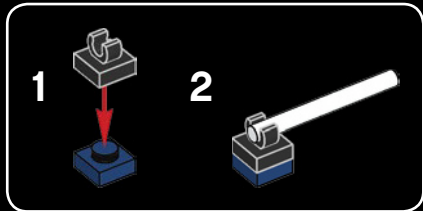



30

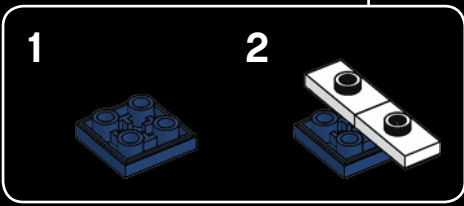
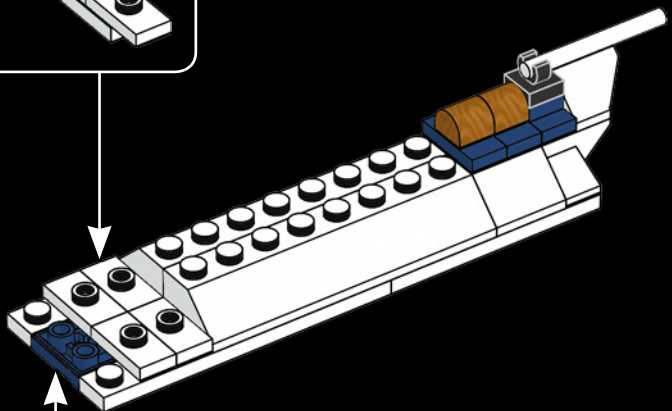
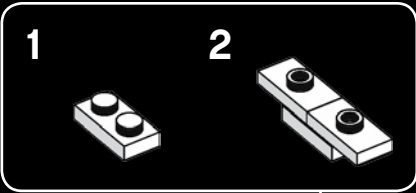

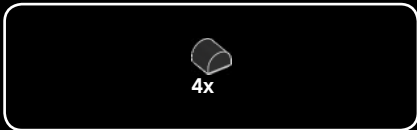

31

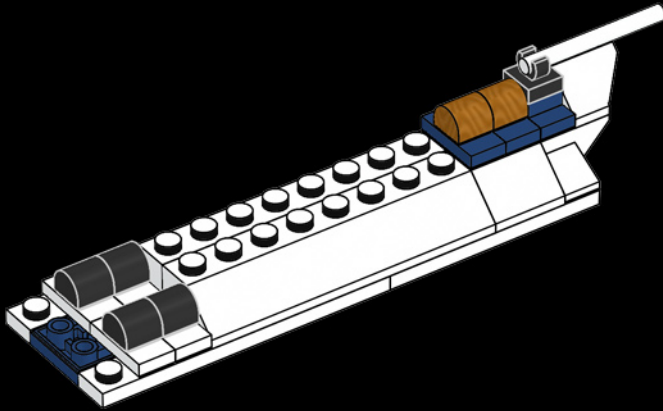

32

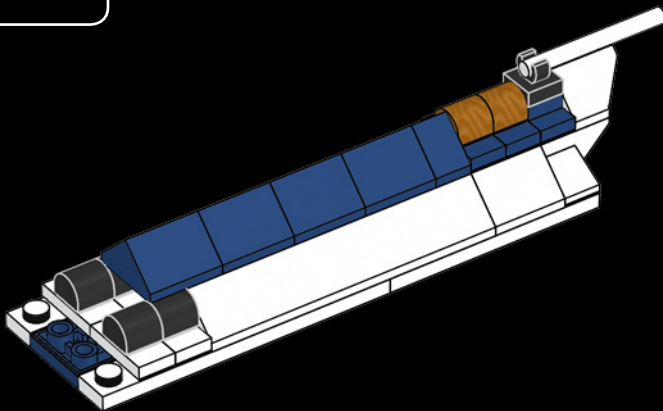

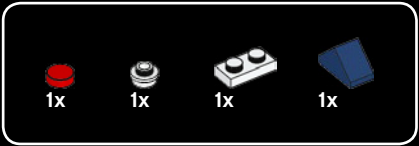

33

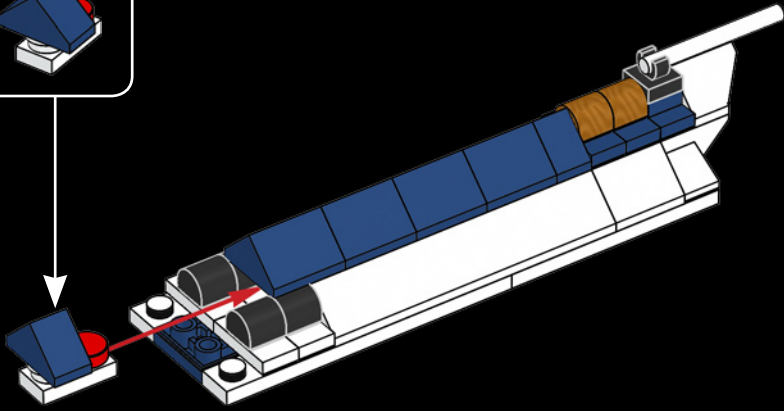
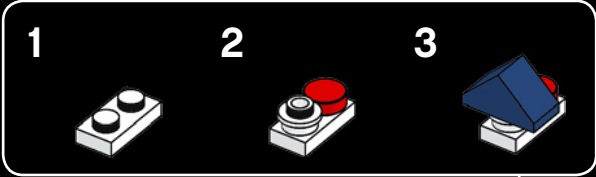

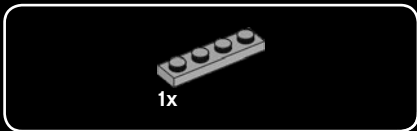

34

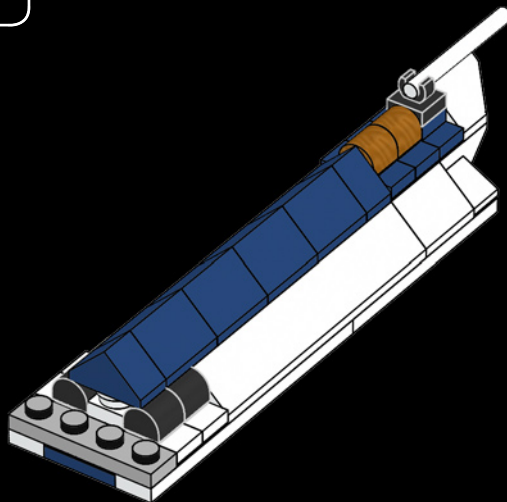

35

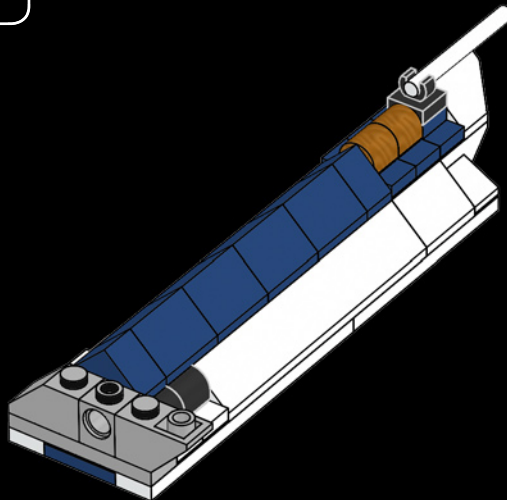



36

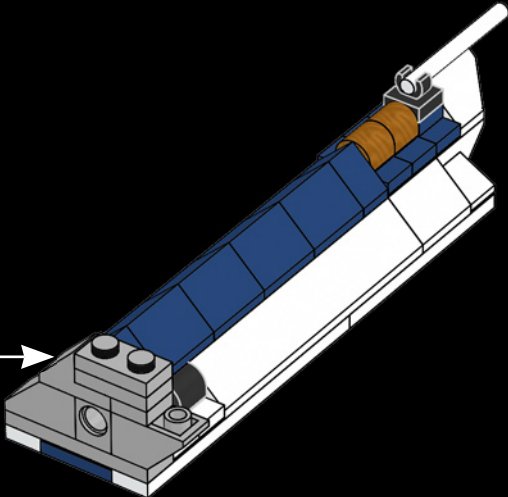
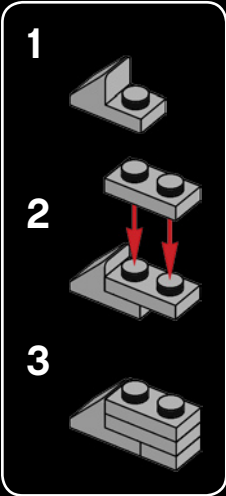

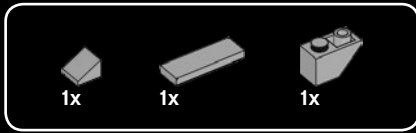

37

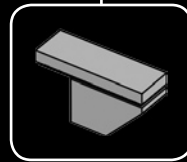
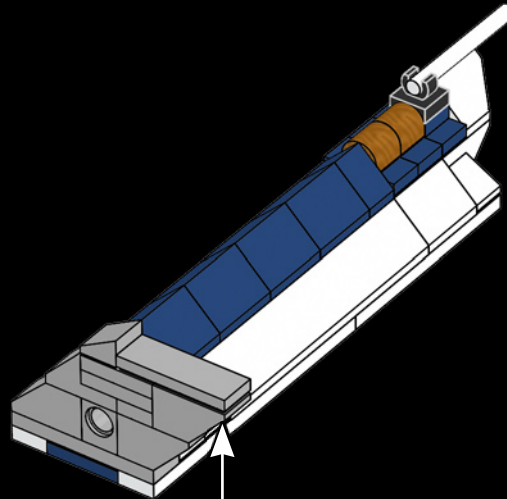

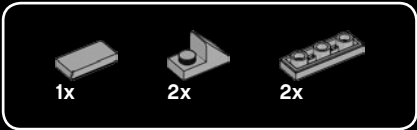

38

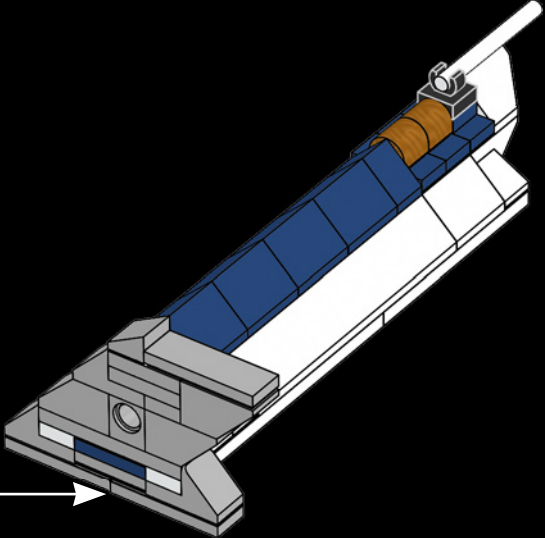
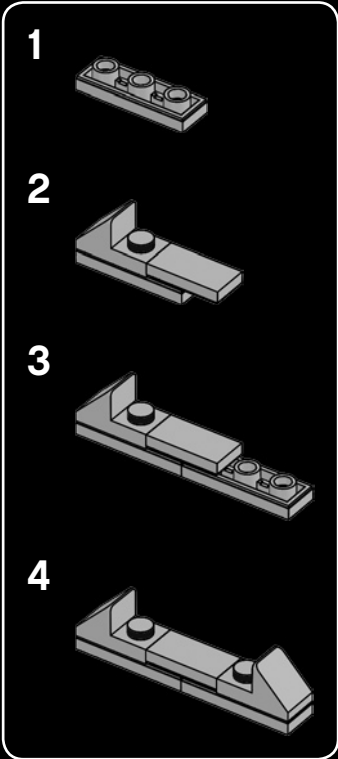

Jumeirah Emirates Towers

The elevators in the 98 ft. (30m) high hotel atrium move at 13 ft. (4 meters) per second.



39

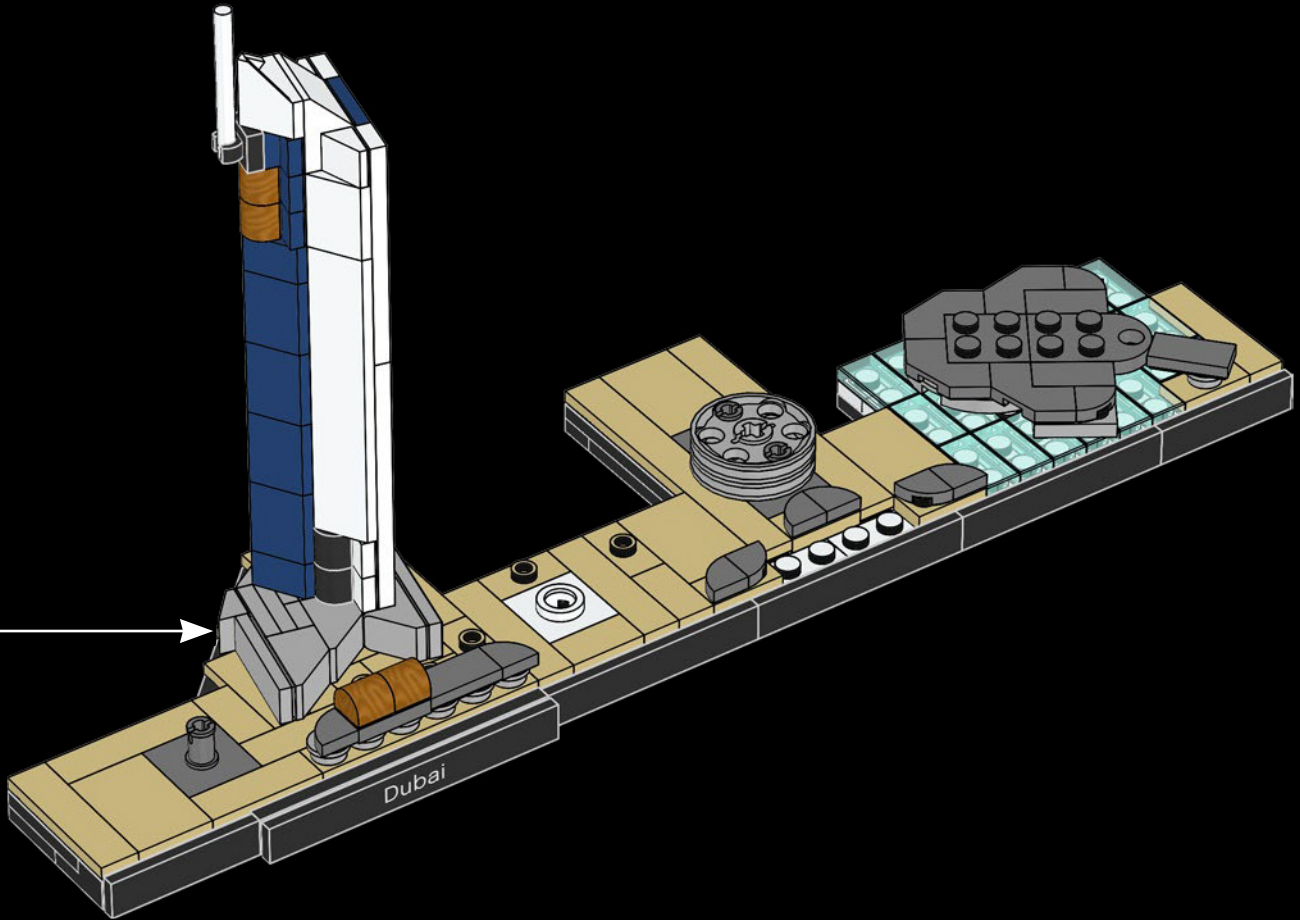

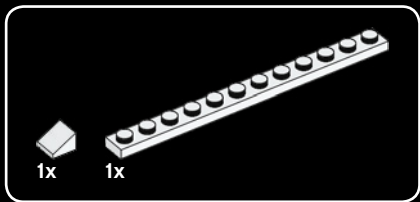
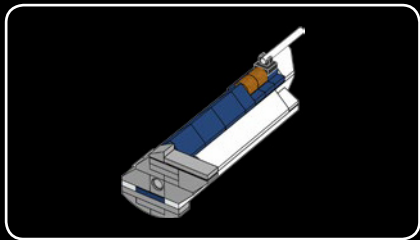

40

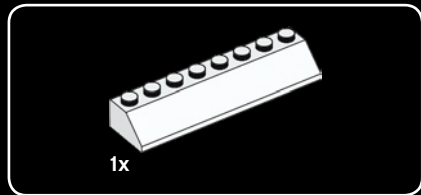
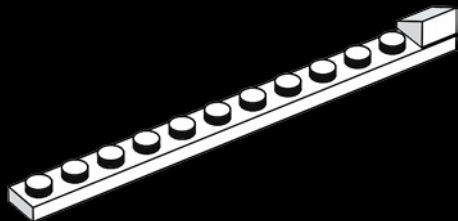

41

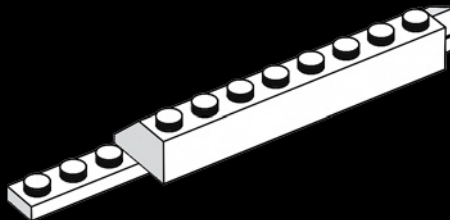

42

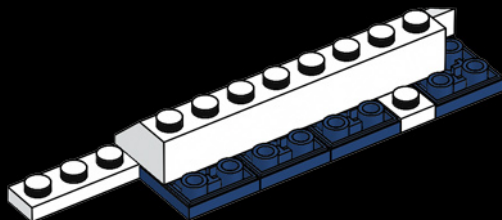

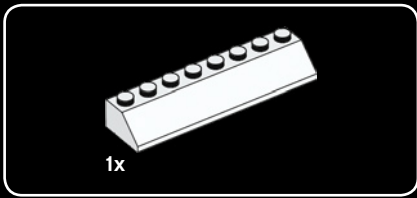

43

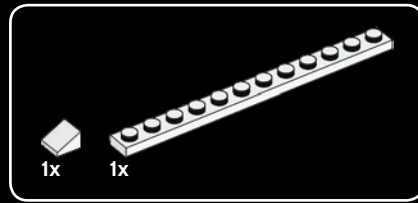
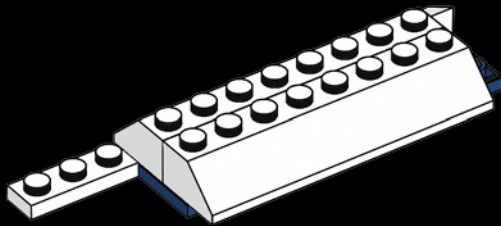

44

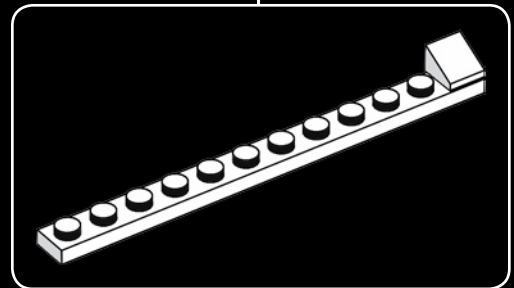
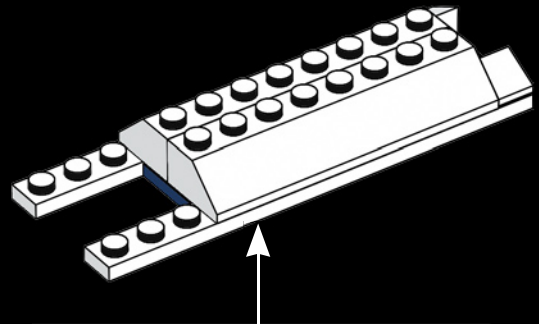



45

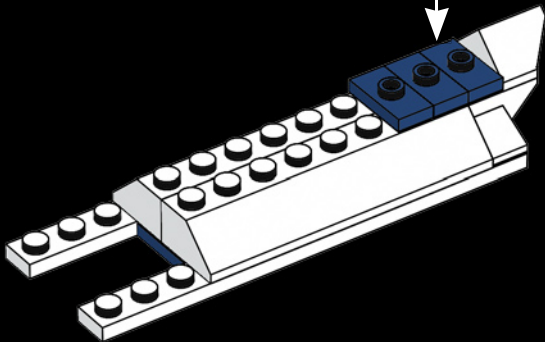
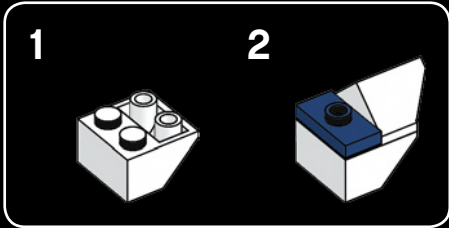

46

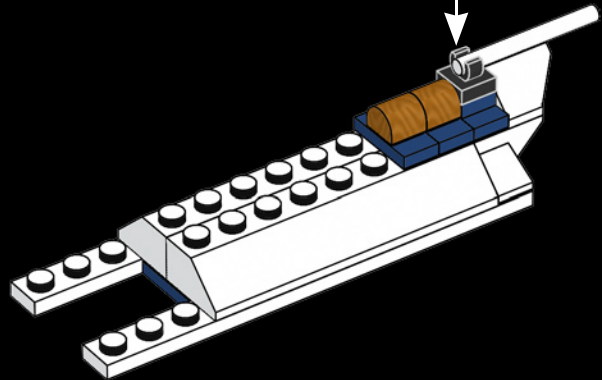
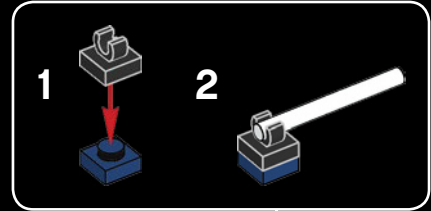



47

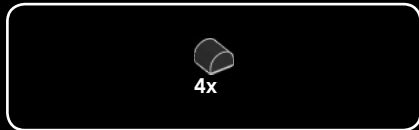
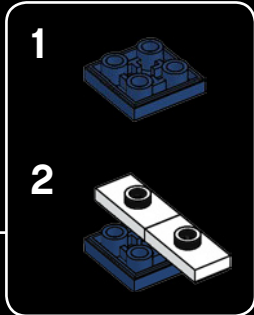
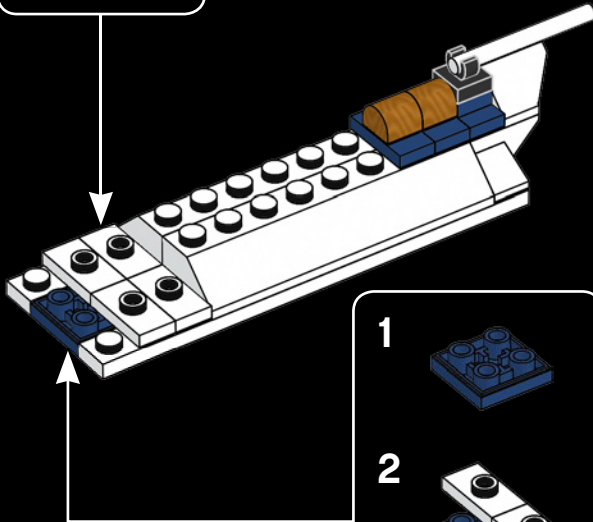
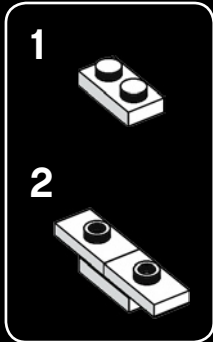

48

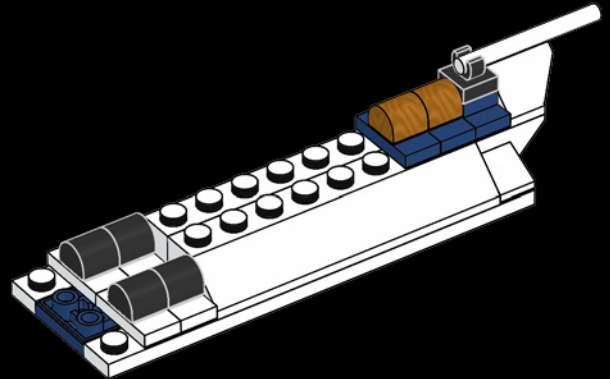

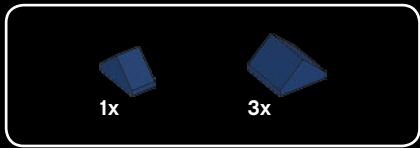

49

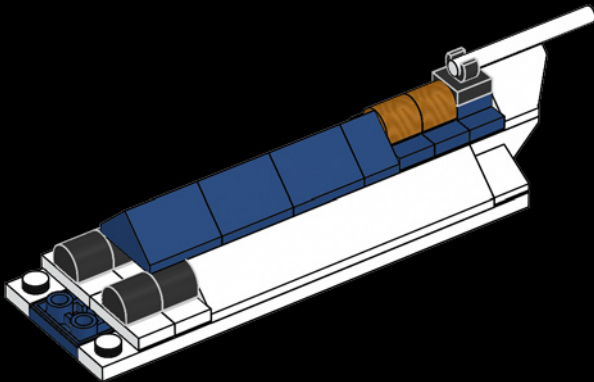

50

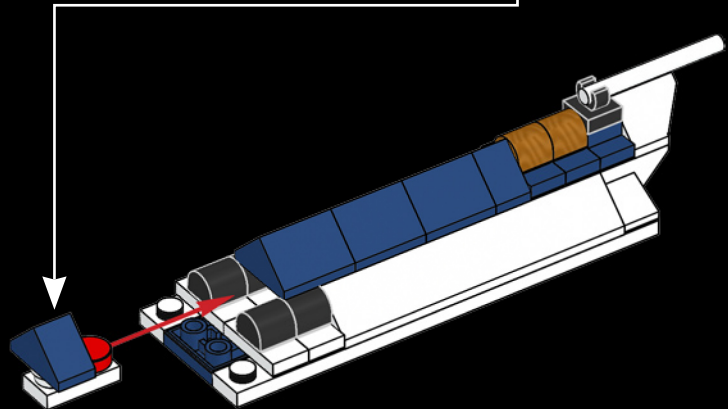
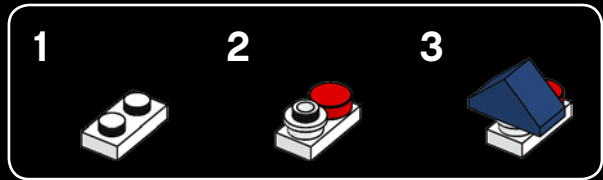

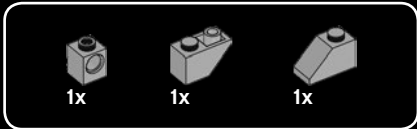

51

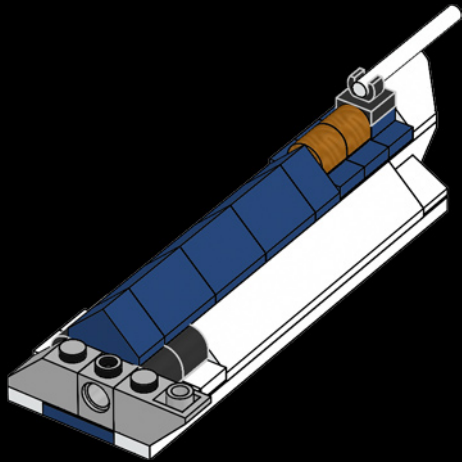

52

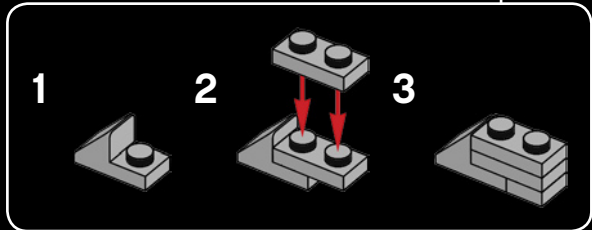
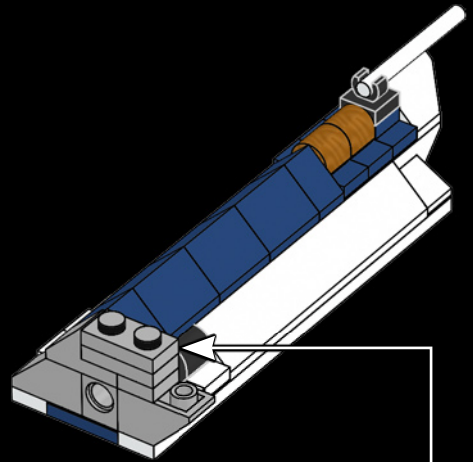

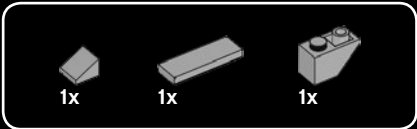

53

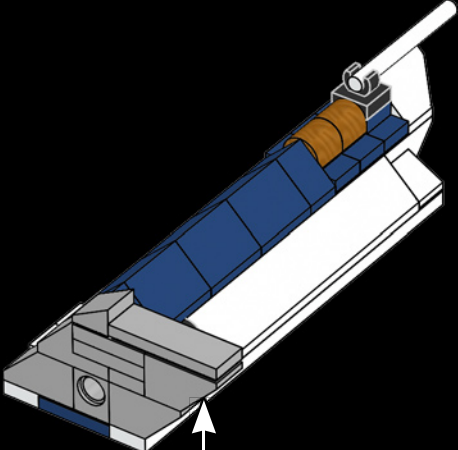

54

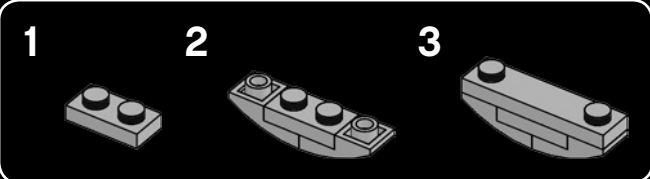
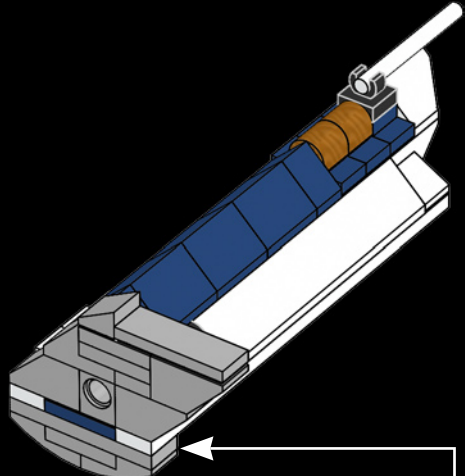

55

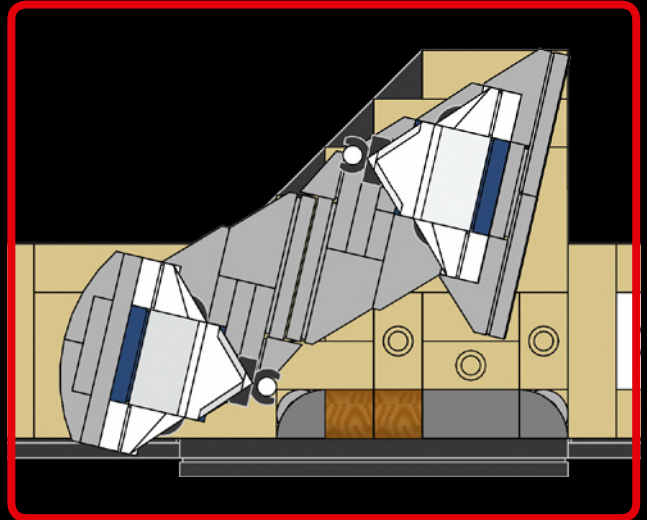
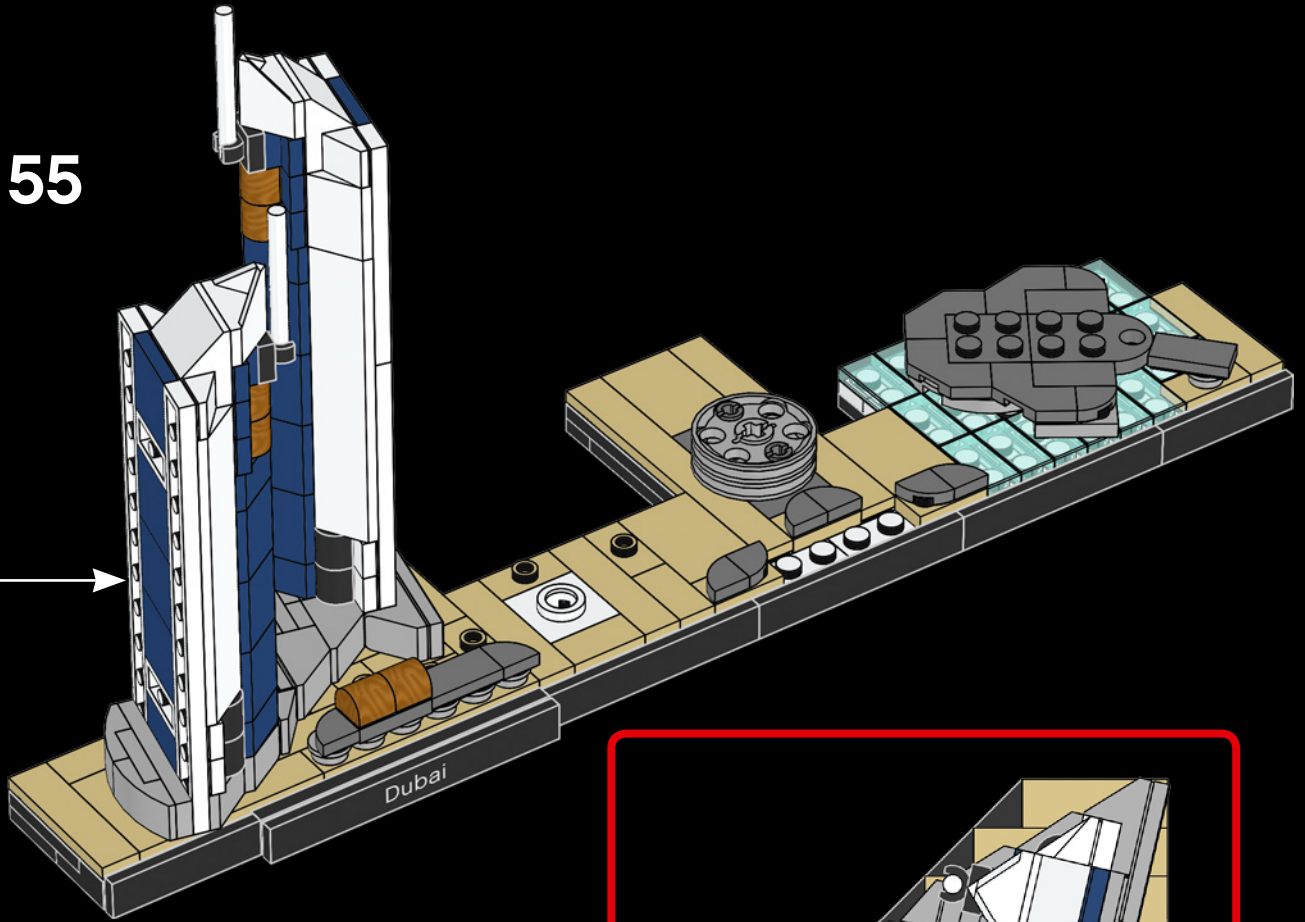

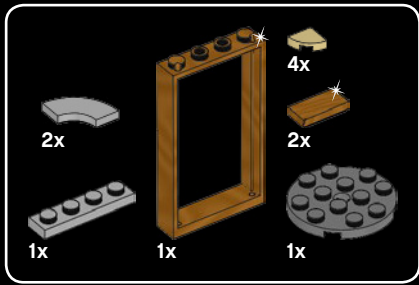

56

1



2



3



4



Dubai Frame

It's expected that up to 2 million tourists will visit the Dubai Frame every year.

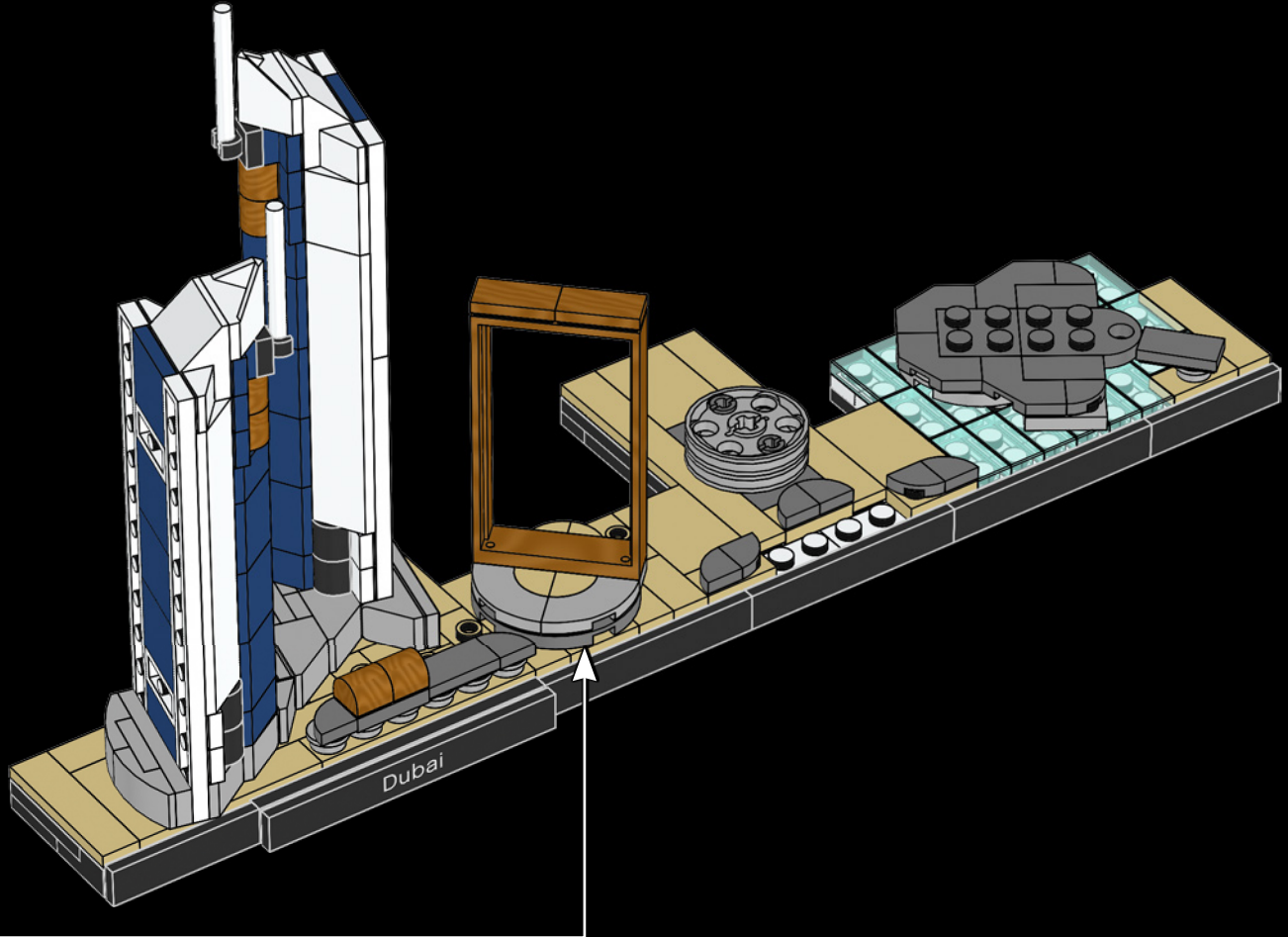



4x

57

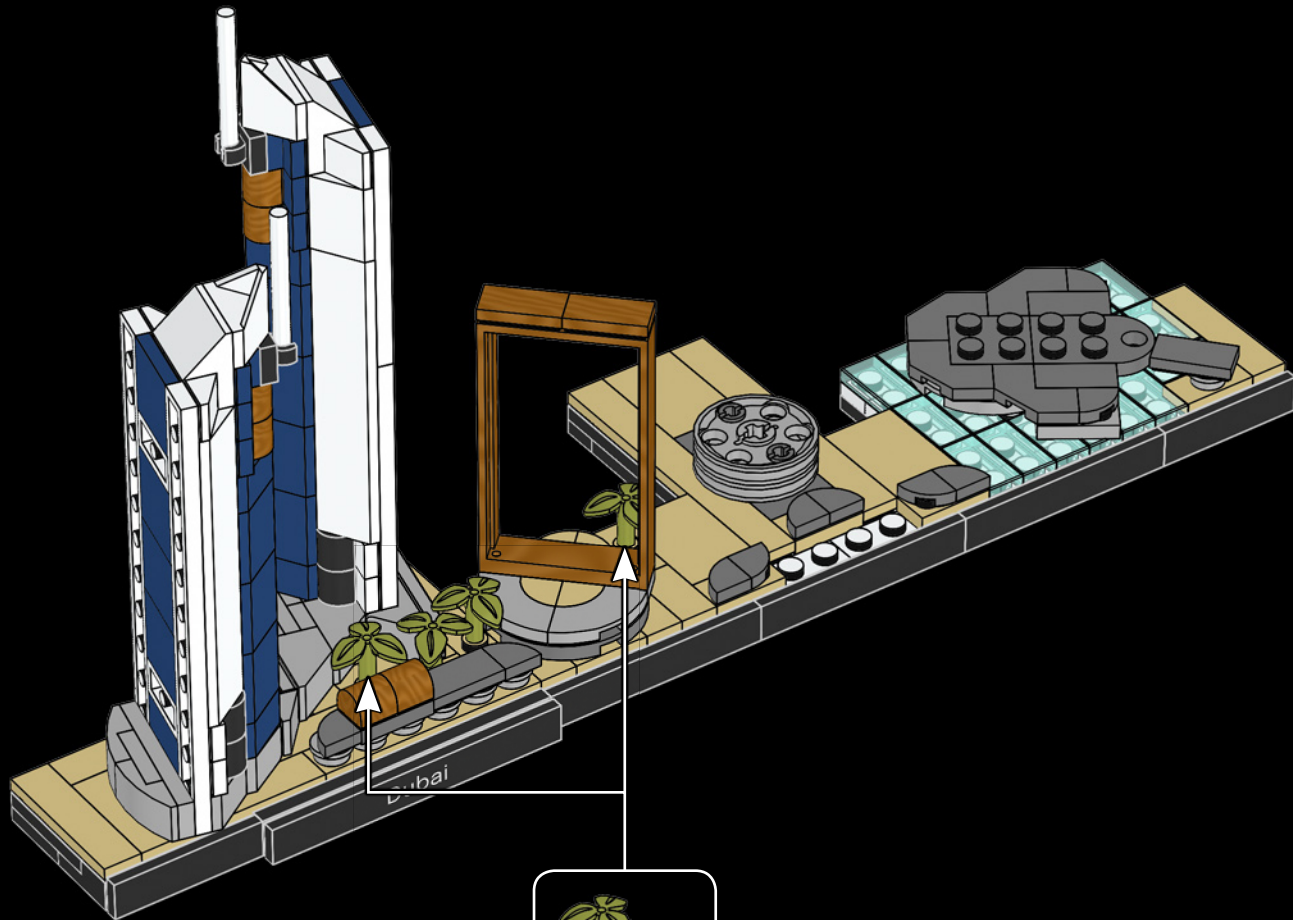

4x

Dubai Frame

More than 161,458 sq. ft. (15,000m²) of gold-colored stainless steel covers the Dubai Frame.

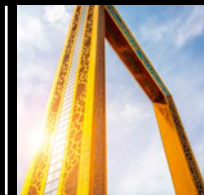

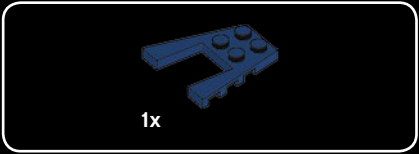
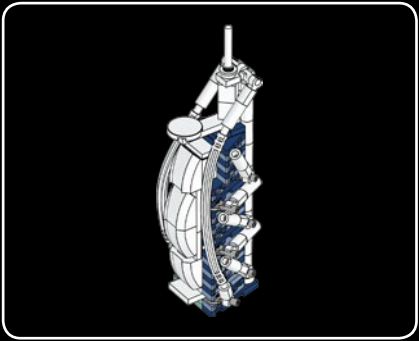

59

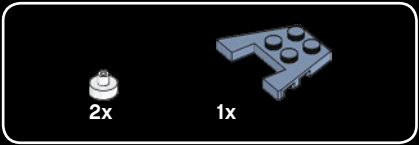
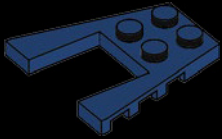

60

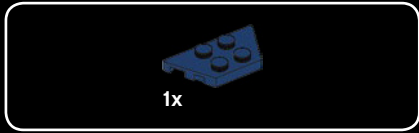
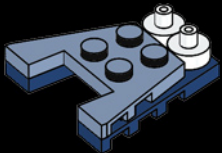

61

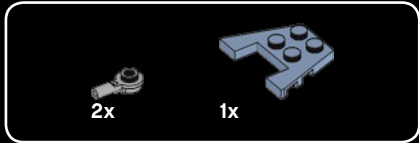
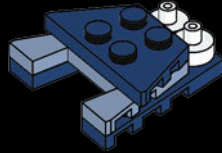

62

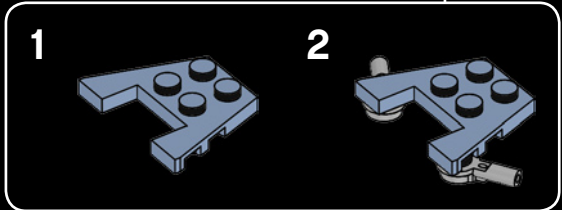
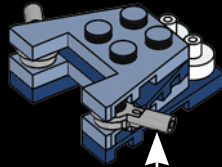

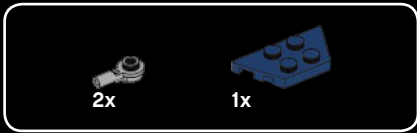

63

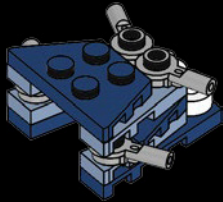

64

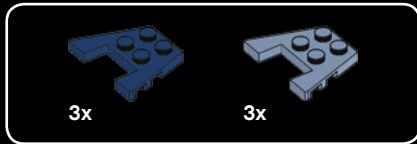
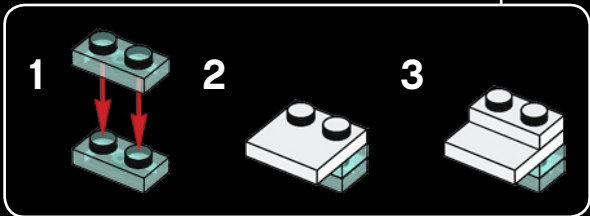
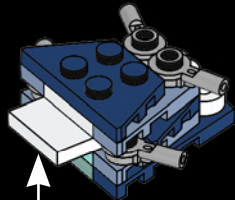

65

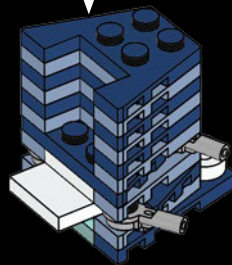
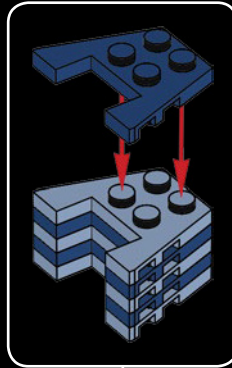

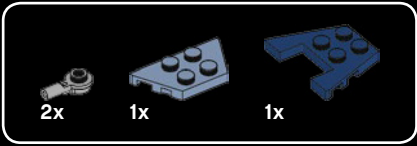

66

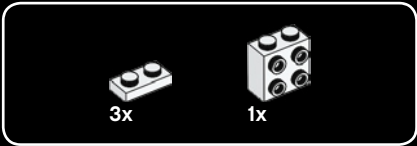
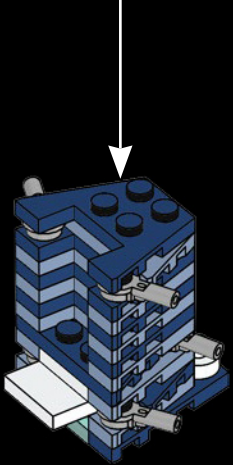
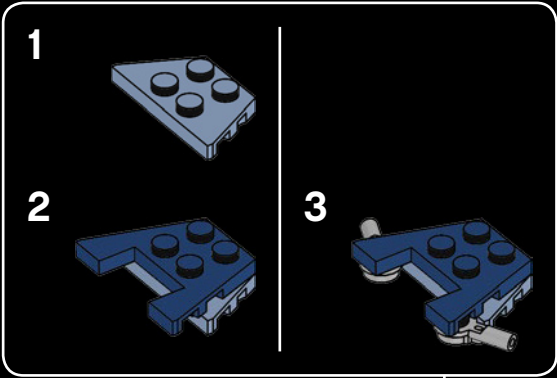

67

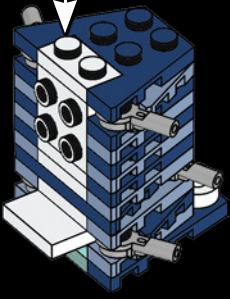
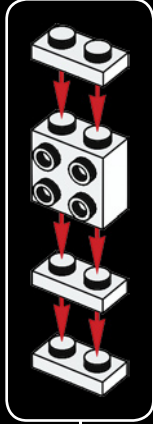

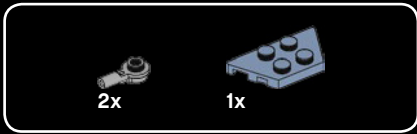

68

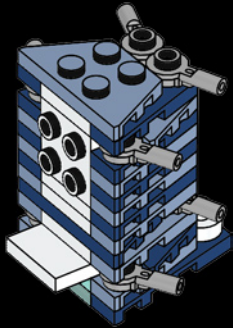

Burj Al Arab
The Burj Al Arab hotel opened for business in 1999.

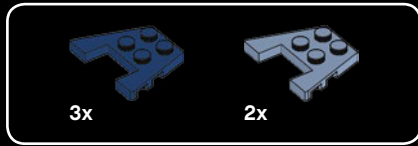

69

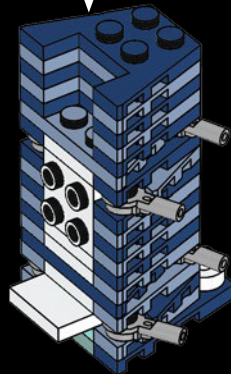
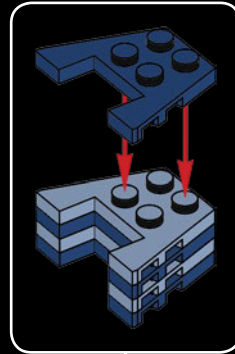

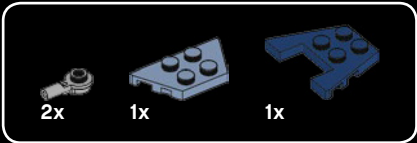

70

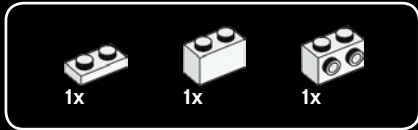
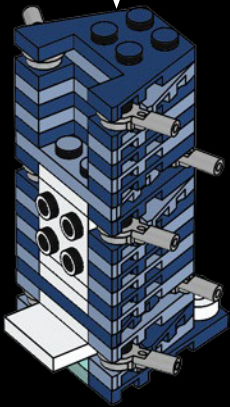
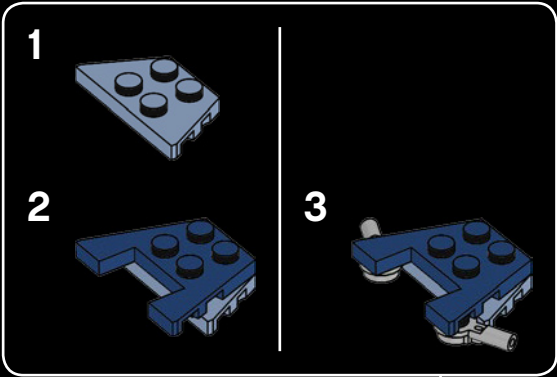

71

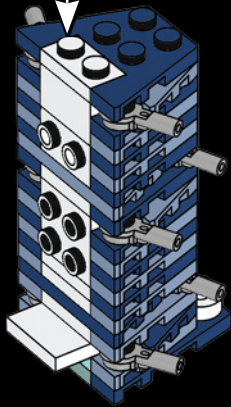
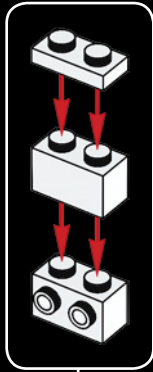

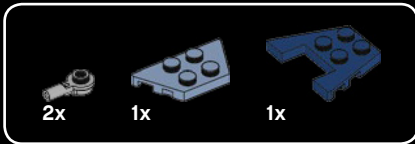

72

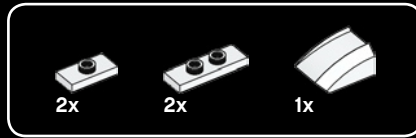
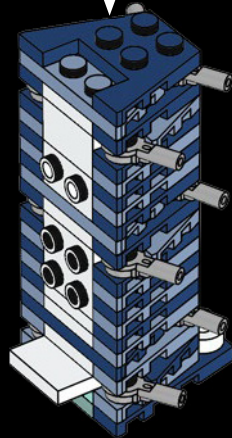
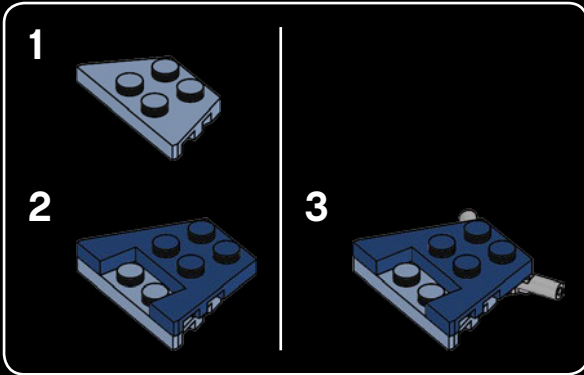

73

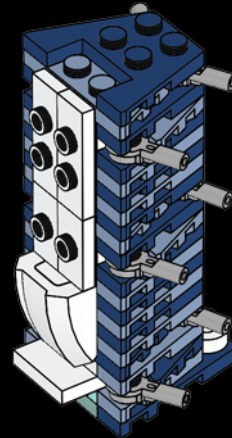



74

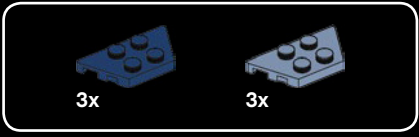
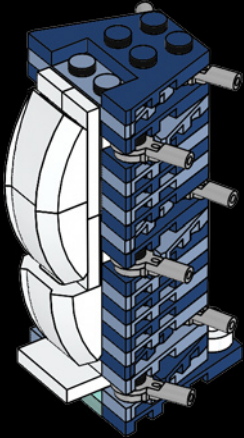

75

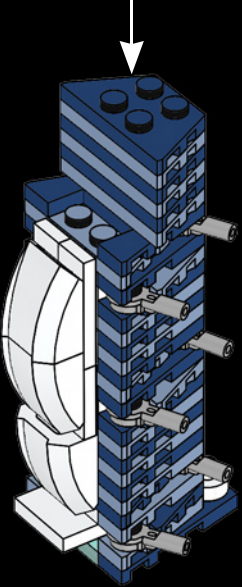
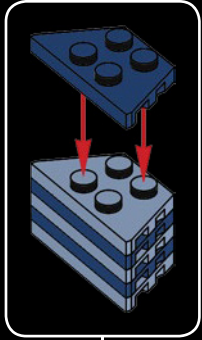

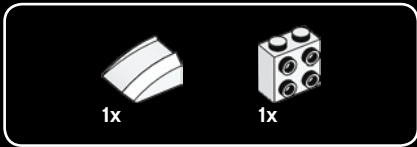

76

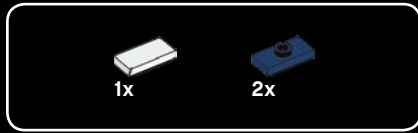
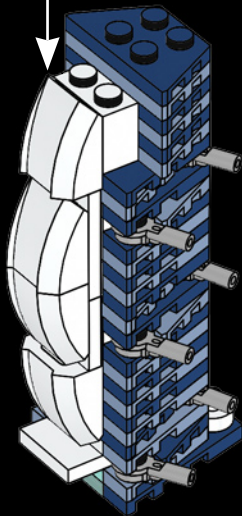
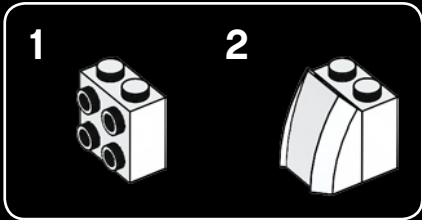

77



Burj Al Arab

The hotel's sail-like shape is taken from the traditional Arabian dhow ship.

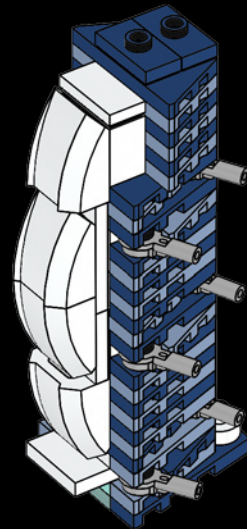



2x



1x

78

1

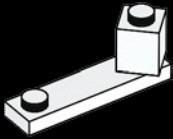

2

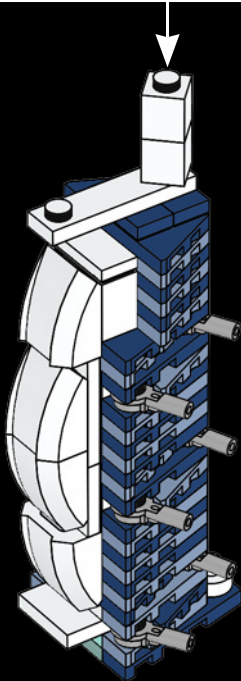
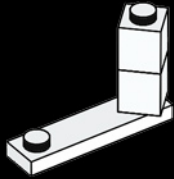

2x



16x

79

1



2



2x

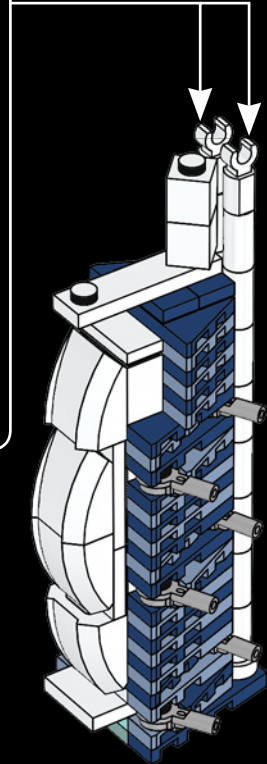



80

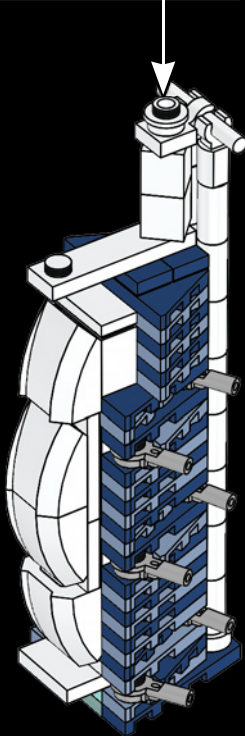
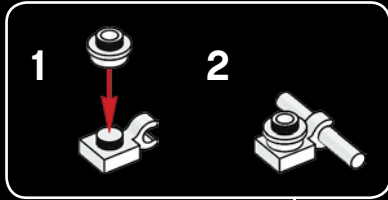

81

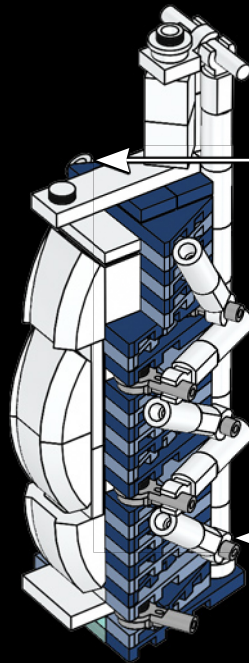
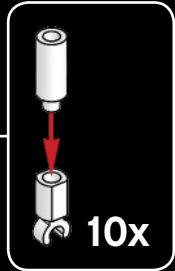

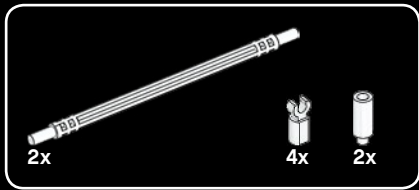

82

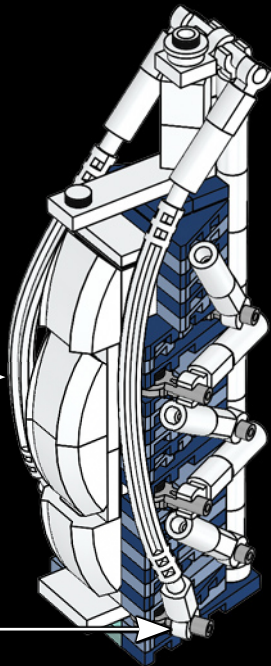
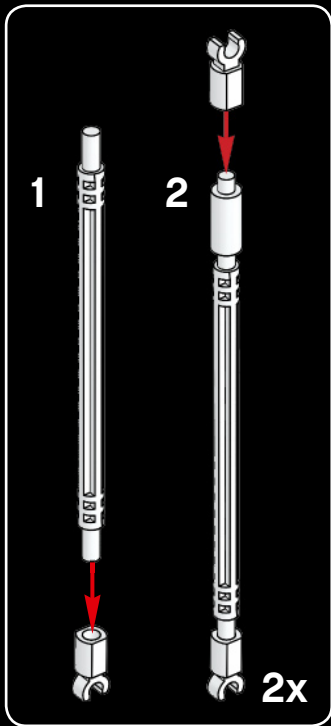

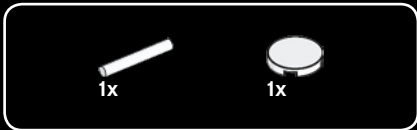

83

Burj Al Arab
The hotel boasts the tallest atrium in the world
at almost 590 ft. (180m).

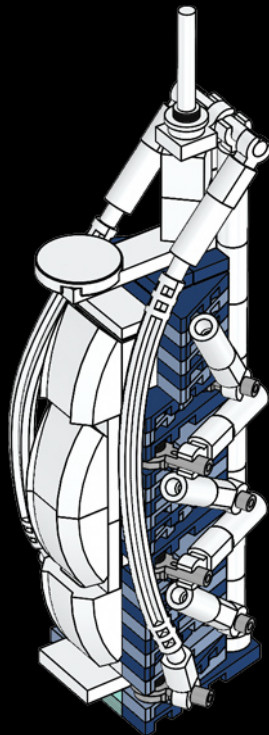
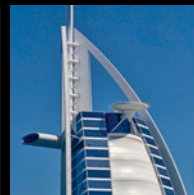

84

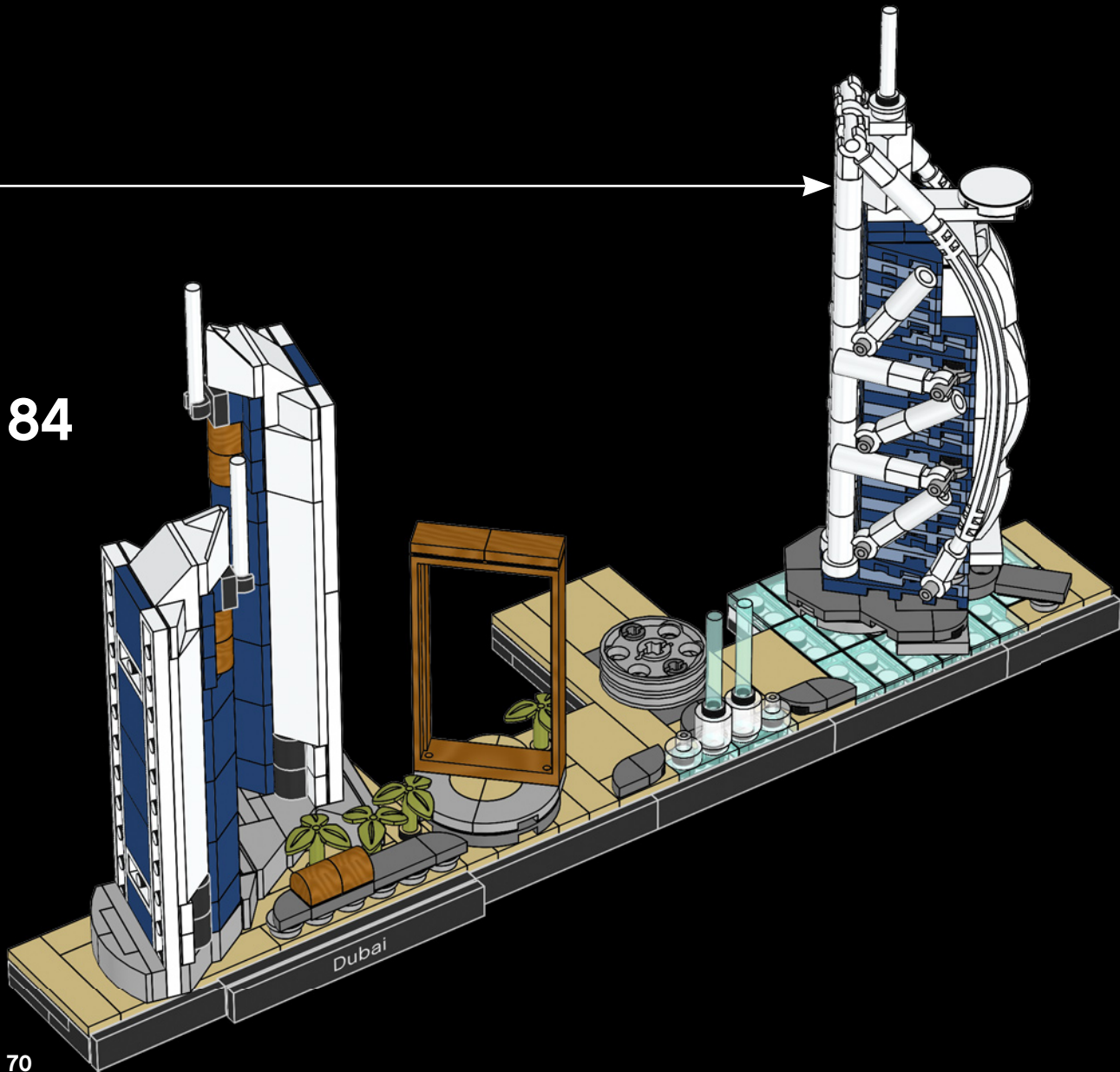

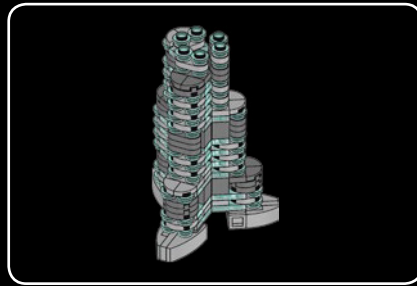
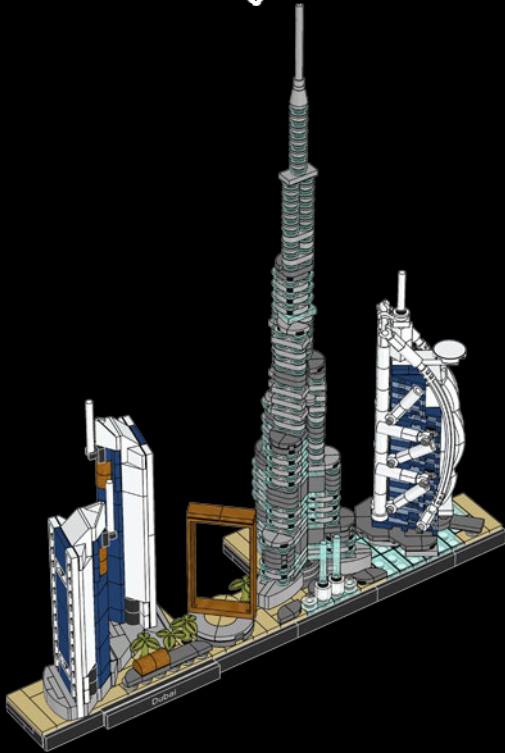

85



86





1x

87

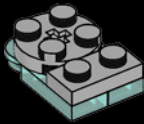

2x



2x

88



3x



1x

89

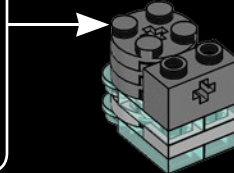
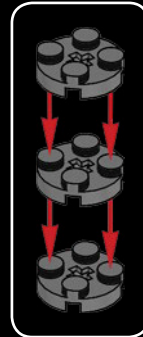



90

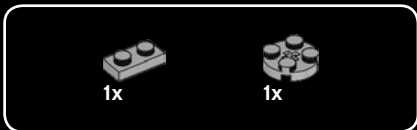

91

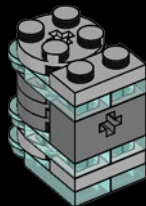

92



93



2x



2x

94



1x



1x

95

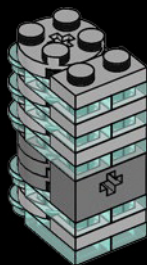

2x



2x

96

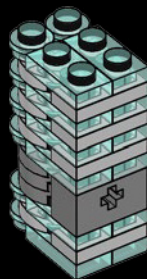

2x



1x



97

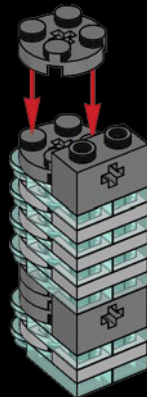



98

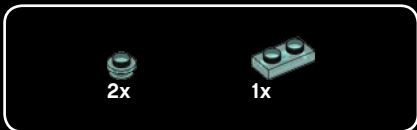
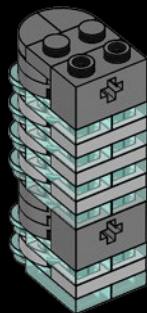

99

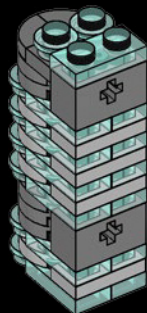

100

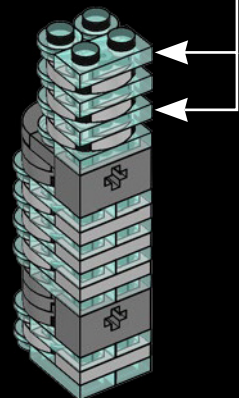



2x

101



2x



1x

102



2x

1x

103

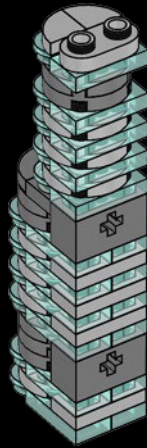

Burj Khalifa

It takes 36 workers 3 to 4 months to clean the entire exterior façade.

2x

104

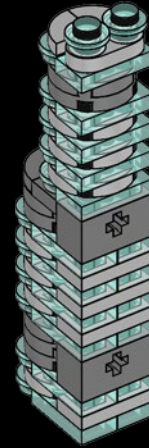

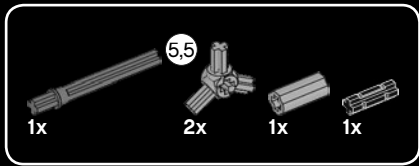

105

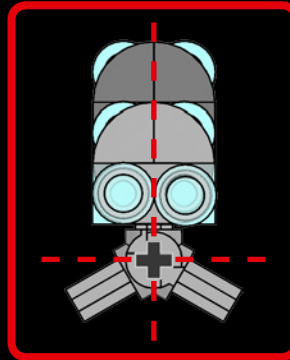
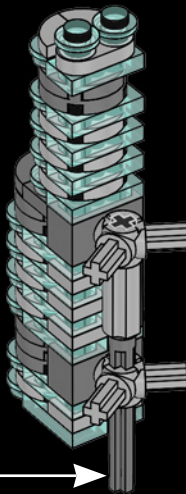
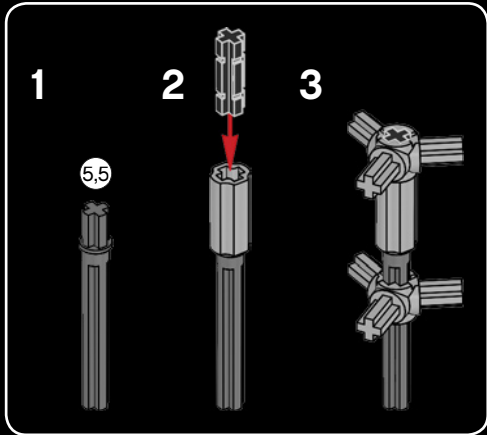



110

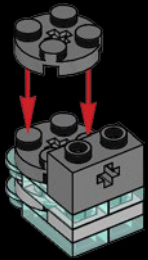

111



112



113





114

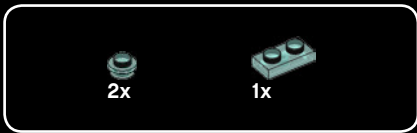
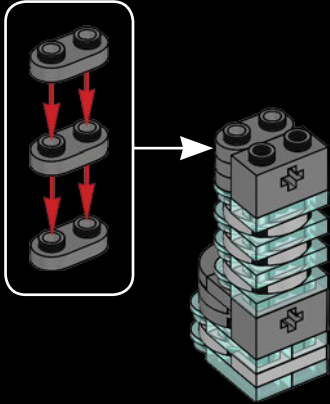

115



116



117

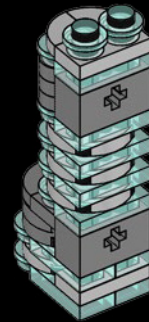



118

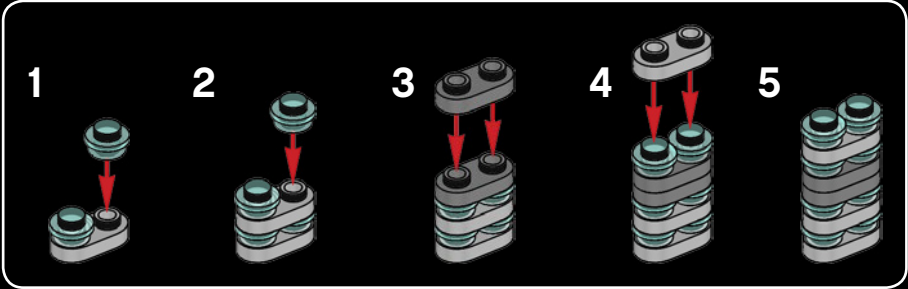

Burj Khalifa

A record-breaking 11.6 million cu. ft. (330,000 cubic meters) of concrete was used in the Burj Khalifa's construction.



119

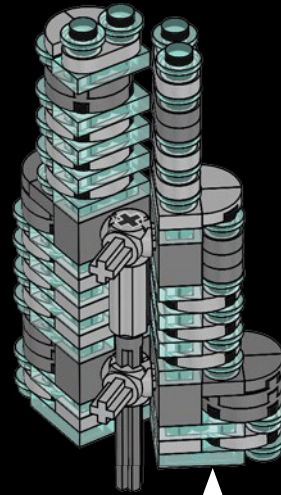



1x

120



2x



2x

121



1x

122



2x



2x

123

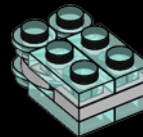



124

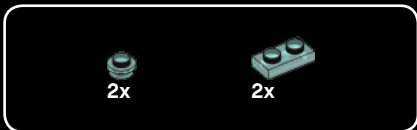
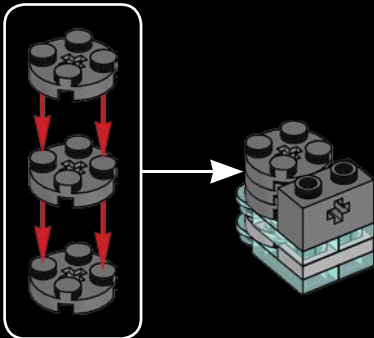

125



126

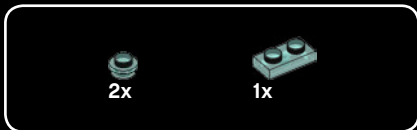

127





128

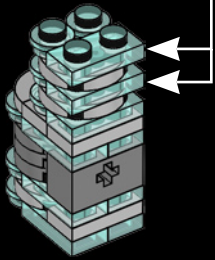
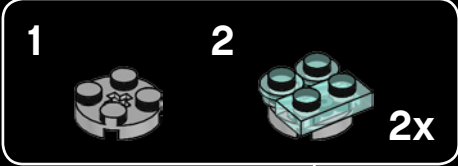

129

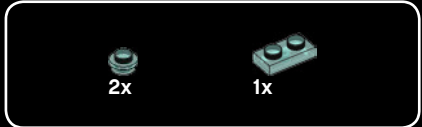
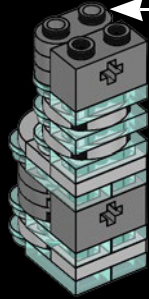
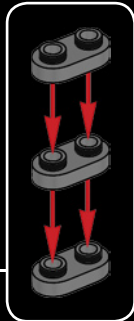

130

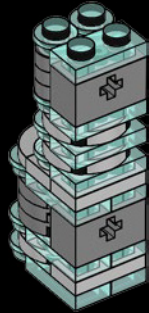



131

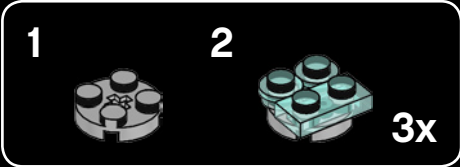

132





2x



1x

133



2x

134





1x

135



2x

136



Burj Khalifa

The tower took 22 million man-hours to construct.



137

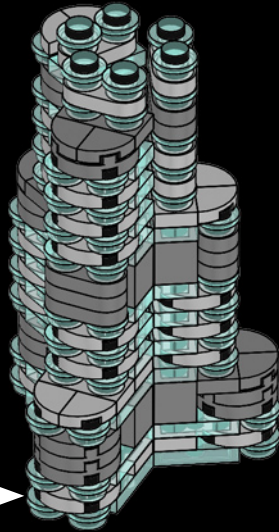

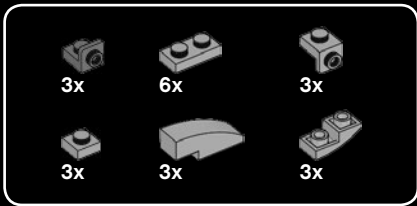

138

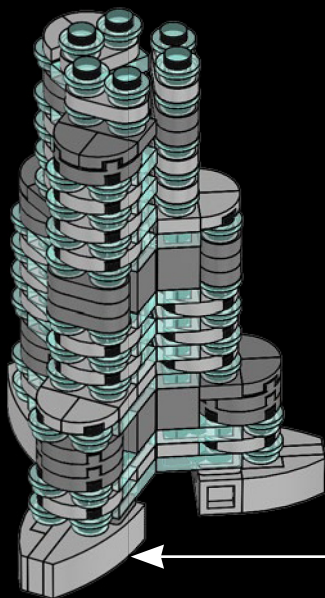
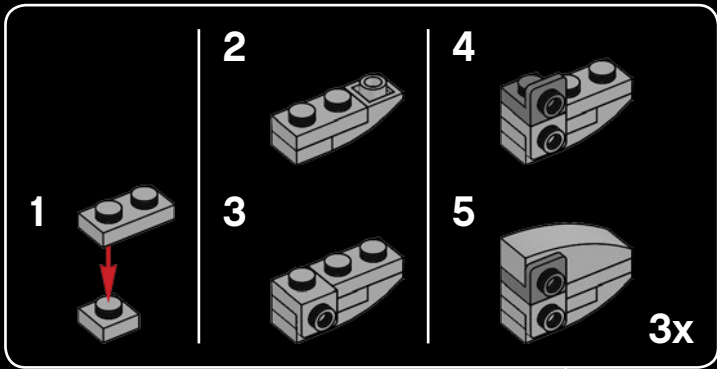

139

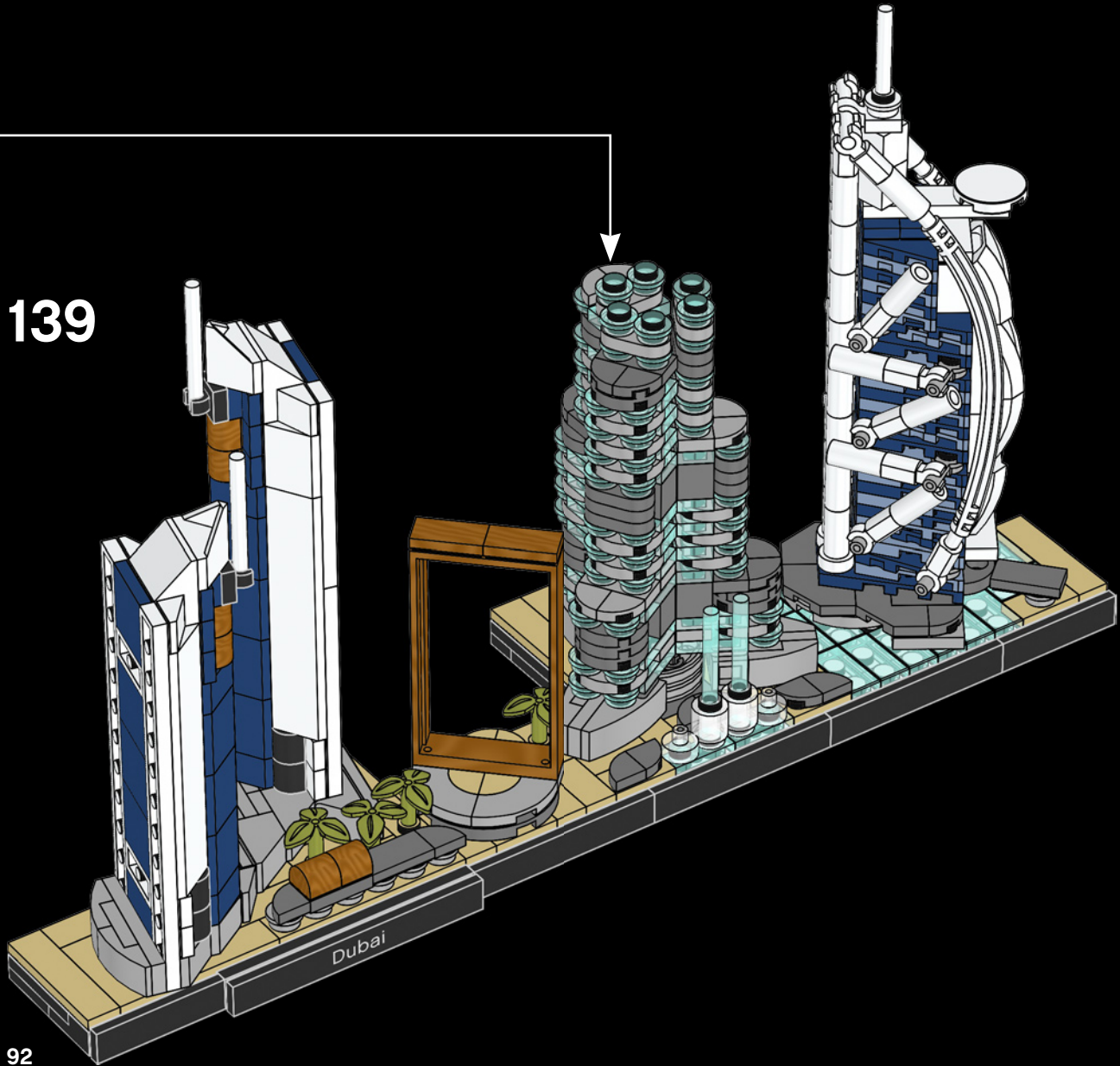

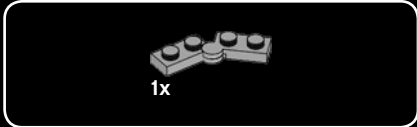
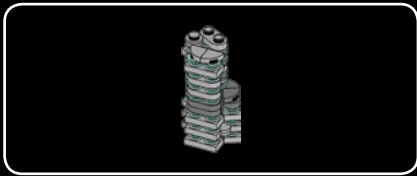

140



141

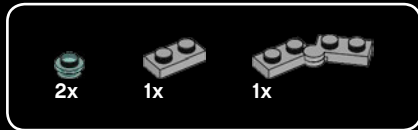
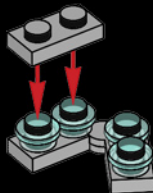

142

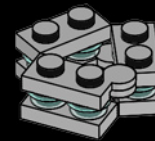

143

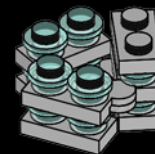
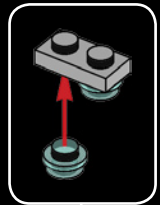



1x

144



2x

145



1x

146



2x

147





148

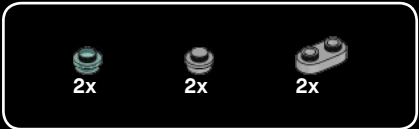
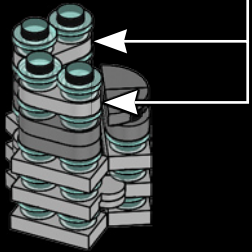
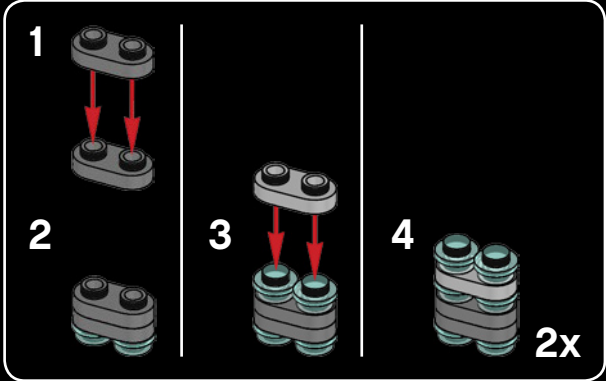

149

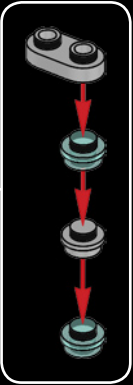

150





1x



1x

151



5x

152

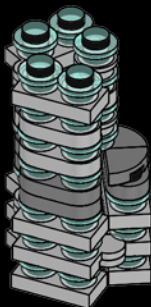

1x



2x



1x

153



154

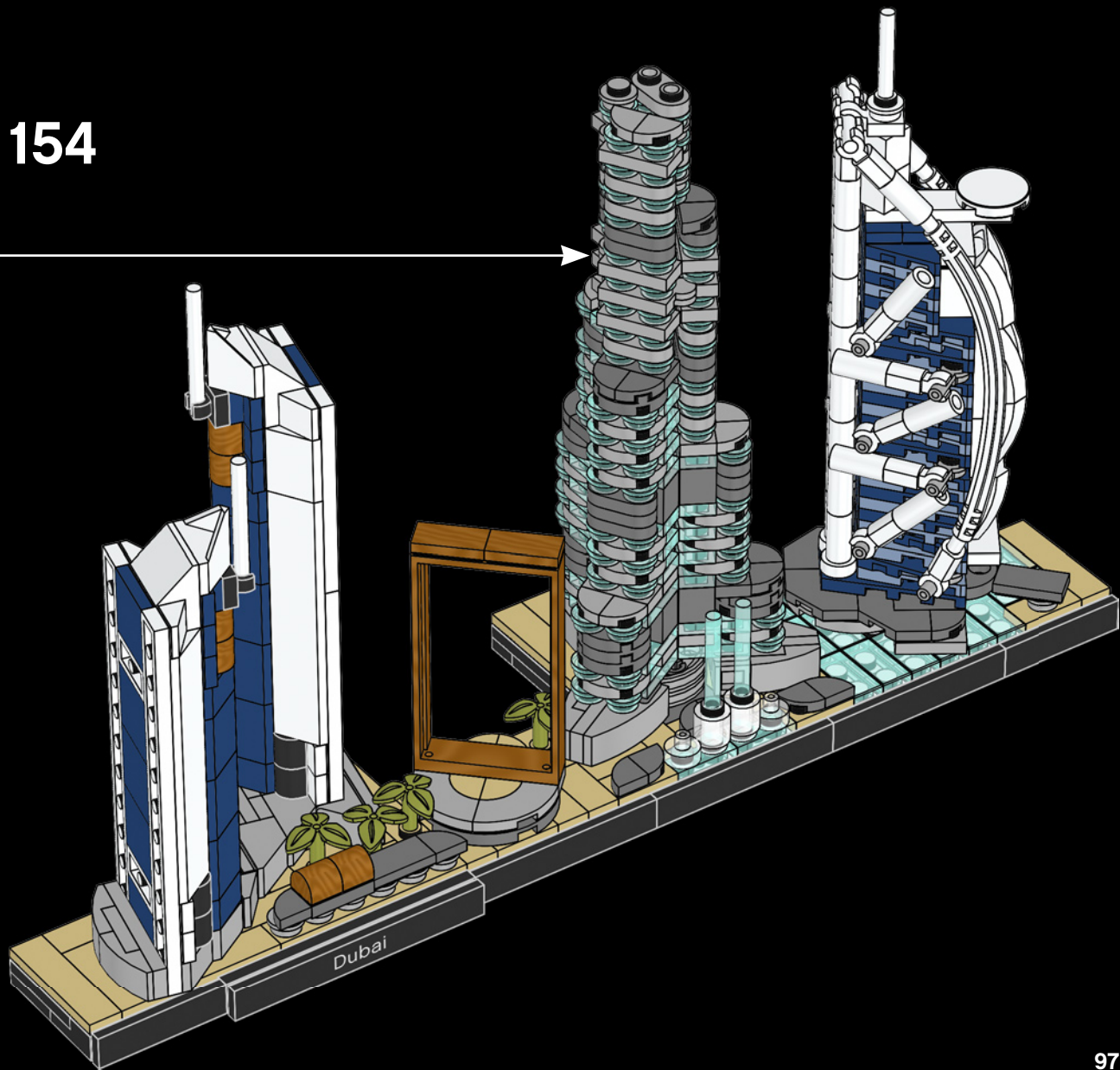

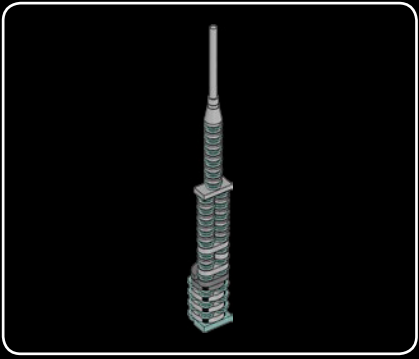

155



156

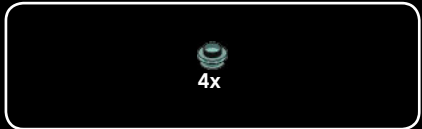
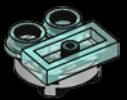

157

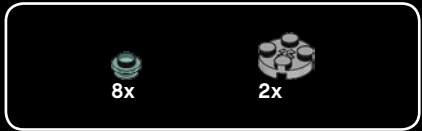

158

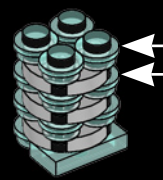



1x

159



1x



1x



1x

160



2x



1x

161



2x

162



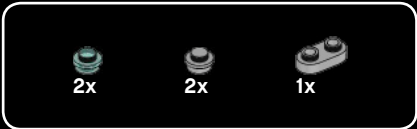

163

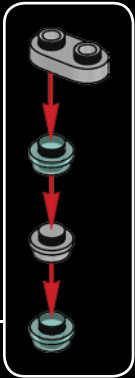

164



165





8x



10x

166

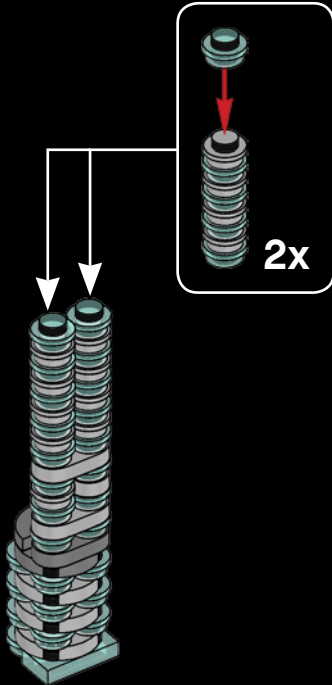

1x

167



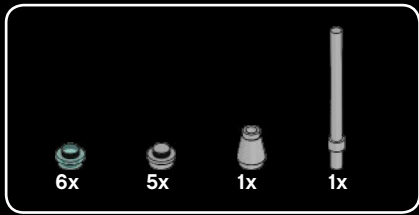

168

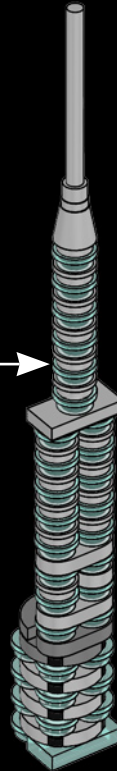
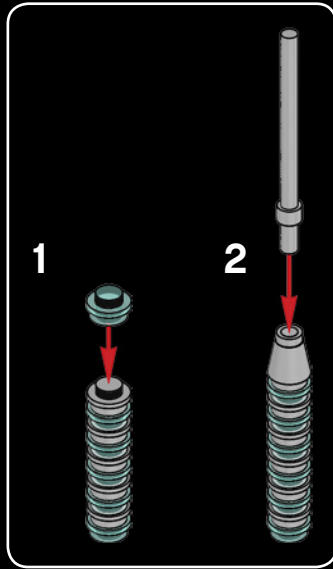



Dubai Frame

The Dubai Frame can only handle 200 visitors per hour.

169

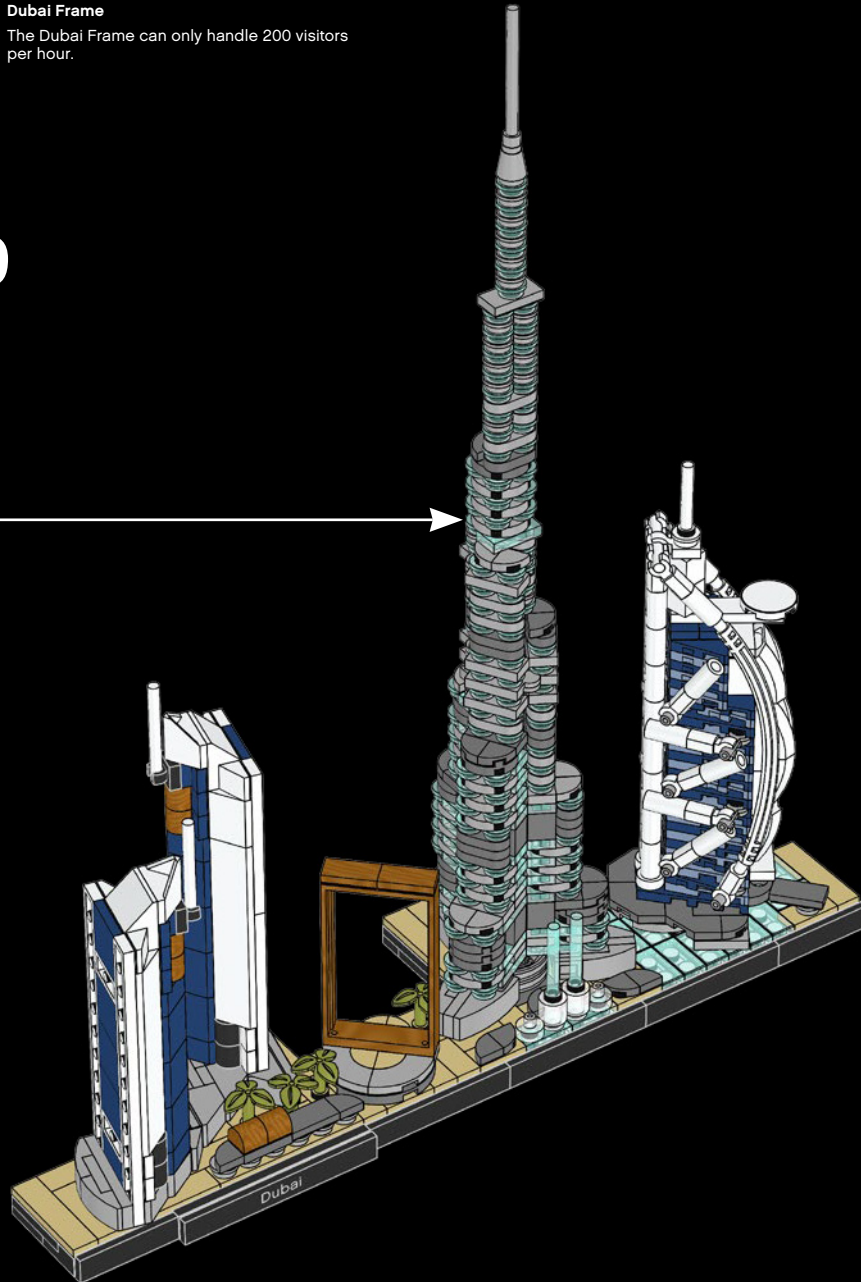



LEGO® Architecture – do you like it?

The LEGO Group would like your opinion on the new product you have just purchased. Your feedback will help shape the future development of this product series. Please visit:

[LEGO.com/productfeedback](https://www.lego.com/productfeedback)

By completing our short feedback survey, you will be automatically entered into a drawing to win a LEGO® prize.





Terms & Conditions apply.

LEGO® Architecture

The LEGO® Architecture series creatively captures the essence of many of the world's most iconic landmarks while giving you an enjoyable and engaging LEGO building experience.

Whether your interest is in travel, design, history or architecture, these sets are a physical memento of a great trip abroad, a famous building you know well, or a city you still dream of visiting.

Every LEGO Architecture set is designed to be displayed. Much more than just a photo, building and displaying your model on your desk, in the bookcase or on the shelf, lets you be transported every time you admire the view.

Follow us on  

Adam Reed Tucker is the co-developer of the LEGO Architecture product line.



Celebrate the world of architecture and collect all the models

21045
Trafalgar Square



21042
Statue of Liberty



21046
Empire State Building



21028
New York City



21039
Shanghai

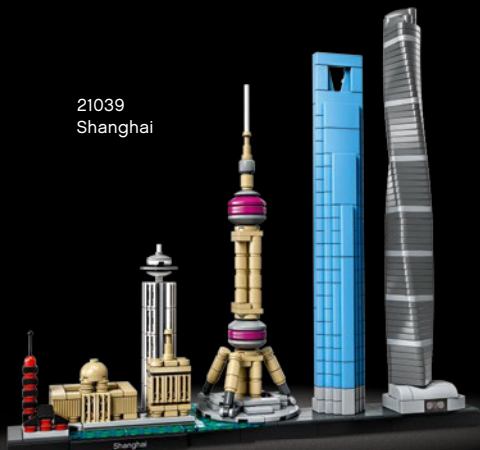

21043
San Francisco



21034
London

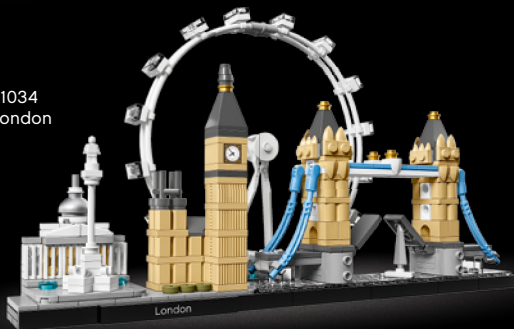

21044
Paris



21051
Tokyo



28x
6234807

16x
6052824

2x
6186681

2x
302401

4x
4504369

2x
300501

1x
4538353

1x
6044691

2x
6059271

2x
6051511

10x
6051511

1x
6058177

1x
306901

2x
302301

17x
302301

1x
300401

2x
6218823

2x
6093526

1x
6218822

2x
366001

2x
303901

4x
4195869

2x
6195371

2x
6116602

1x
4597131

2x
366601

2x
4296264

2x
4119227

3x
6168642

2x
6238334

4x
4163984

1x
303401

5x
4560929

3x
346001

2x
4514842

1x
6285745

2x
346026

1x
383226

2x
244526

8x
6273589

1x
6174243

2x
6052126

2x
362326

2x
243126

5x
371026

1x
6174917

1x
4227684

3x
302026

3x
663626

1x
4160025

1x
303226

2x
6066102

1x
4109810

2x
302326

4x
6145570

5x
4114026

6x
6092587

3x
4113917

4x
6131896

5x
6175367

7x
4550324

1x
4124067

2x
4544139

2x
4184108

8x
6092588

10x
6285466

7x
6285473

4x
6285562

5x
4613335

9x
6285477

1x
6275408

7x
6285557

7x
6285482

1x
4210633

19x
6199549

3x
6225494

14x
6221607

14x
4211042

5x
4211063

6x
6178919

4x
4211052

1x
4211094

4x
4211129

4x
6177079

1x
4225733

1x
4528323

1x
4508553

1x
6170418

1x
4529241

27x
4211525

9x
6176433

2x
4521921

5x
4211399

2x
4211535

3x
6248078

13x
6248890

12x
6227897

20x
4211475

1x
4512360

5x
6144138

4x
6093859

1x
6066097

23x
4211398

1x
4211414

4x
4211437

2x
4211614

2x
4502595

2x
4494222

2x
6163990

2x
4211353

2x
6251044

2x
4558169

3x
4251163

1x
4599498

2x
4211445

1x
4515351

4x
6102769

149x
6240225

44x
6240222

18x
6251295

2x
6170187

2x
6186867

2x
6223655

2x
6284574

4x
6285465

6x
6286351

2x
6265247

1x
6286377

1x
6240515

Customer Service
Kundenservice
Service Consommateurs
Servicio Al Consumidor
LEGO.com/service or dial



00800 5346 5555 :

1-800-422-5346 :



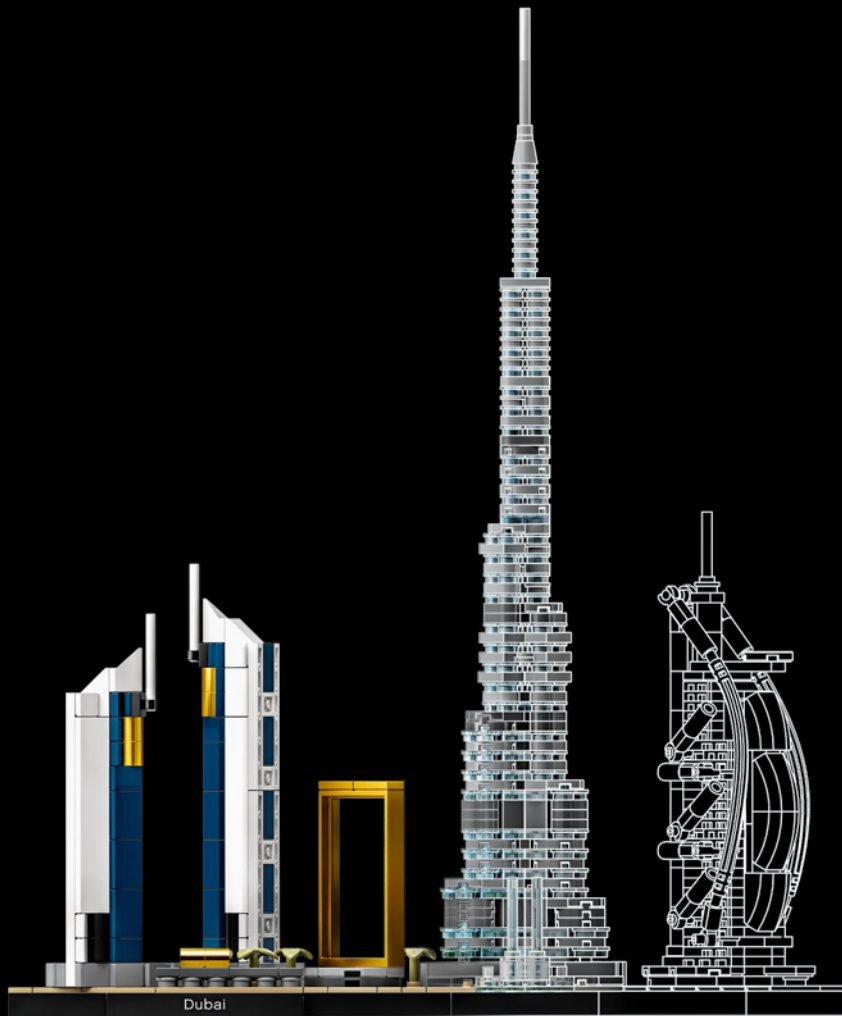

[LEGO.com/architecture](https://www.lego.com/architecture)

BURJ KHALIFA
EMAAR

LEGO and the LEGO logo are trademarks of the LEGO Group.
©2020 The LEGO Group. 6313380

© Jumeirah International LLC

Follow LEGO® Architecture on

