



Booklet available in English on
Heft in deutscher Sprache erhältlich auf
Livret disponible en français sur
Libretto disponibile in Italiano su
Folleto disponible en español en
如需中文版手册, 请访问

[LEGO.com/service/buildinginstructions](https://www.lego.com/service/buildinginstructions)



THE ART OF THE BONSAI

The art of growing miniature trees in decorative pots originated in China over 2000 years ago. This LEGO® variety is much more modern, but the process and outcome is the same: you assemble, plant and prune your LEGO Bonsai, then watch as it grows into a beautiful creation you can be proud of for yourself and share with others. Enjoy!





LEGO® Designer Nicolaas Vás

THE LEGO® BONSAI MASTER

Growing up in New Zealand, LEGO® Designer Nicolaas Vás always loved trees and plants but admits to being pretty bad at looking after them. Luckily, he's much better at creating beautiful horticulture from LEGO elements. His first LEGO Bonsai tree was created as part of his work with the LEGO NINJAGO® series, and since then he's become the Bonsai specialist within the LEGO design team.

ONE TREE, TWO VARIETIES

The biggest challenge for Nico was deciding which two leaf variations to include for you to build. The first variety is the more traditional Bonsai tree where the foliage ranges from bright to dark green, with the juvenile buds being darker in colour. The second tree is inspired by a Japanese Cherry Tree and is much more colourful with striking light purple blossoms. Both options are full of character and capture the wonder and beauty of a real Bonsai.

LEGO® Bonsai trees are surprisingly robust and thrive in indoor environments. Be sure to dust occasionally and your Bonsai tree will continue to remain healthy and beautiful for many years to come!



PLANTS FROM PLANTS

The LEGO Group is working to build a more sustainable future for children. Currently more than 80 LEGO® elements including trees, leaves and bushes are made from a plant-based plastic, produced using sustainably sourced sugarcane, Plants from Plants! These elements represent the first steps of a bigger mission to make LEGO bricks from sustainable sources by 2030.

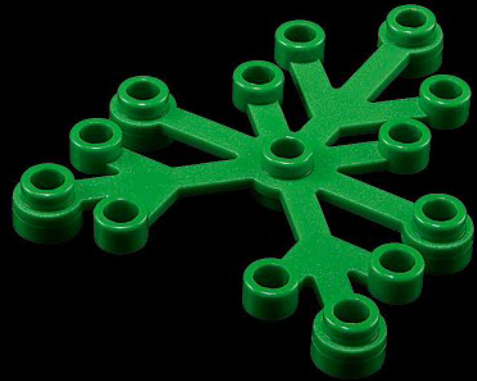

Plants from Plants elements in this set:

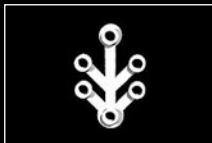
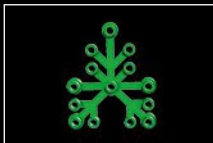

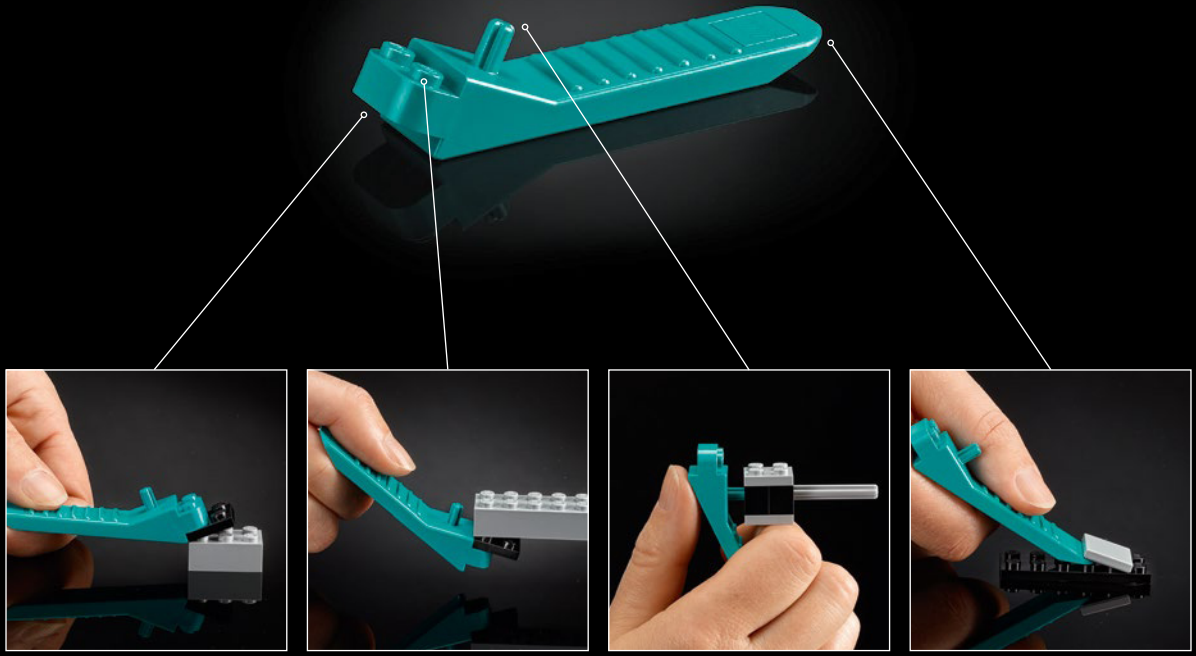

LEGO.com/brickseparator

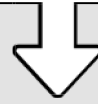

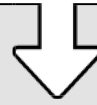
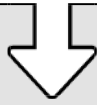

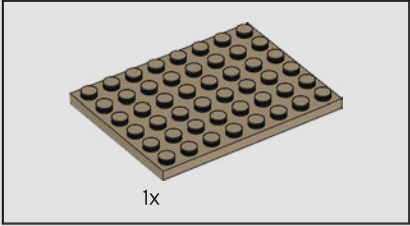
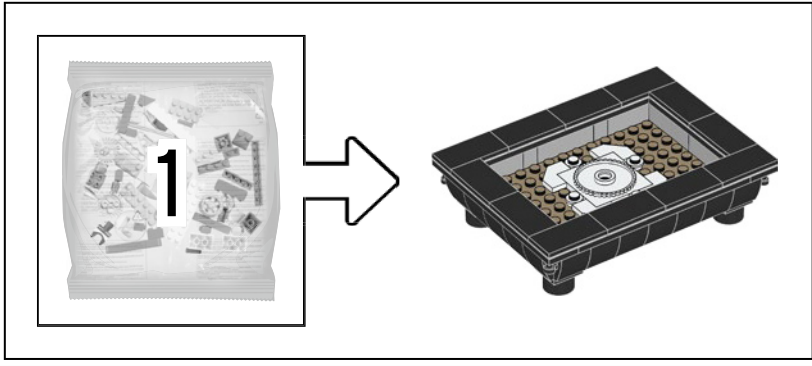

1

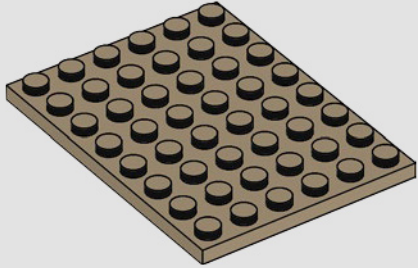

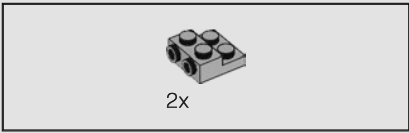

2

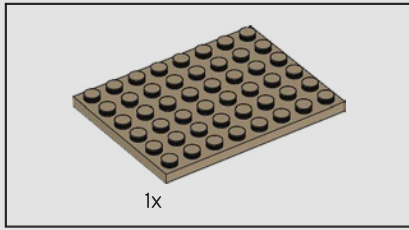
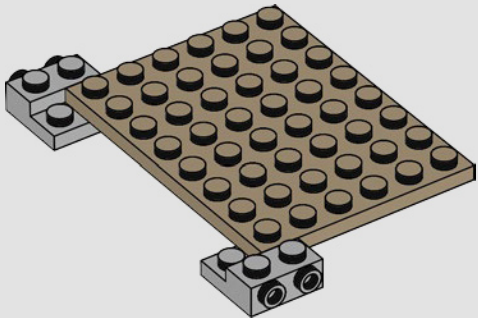

3

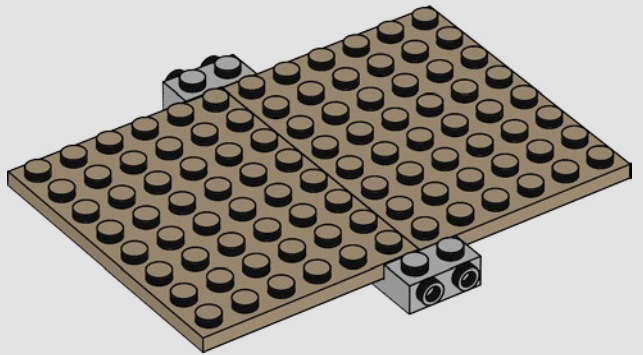

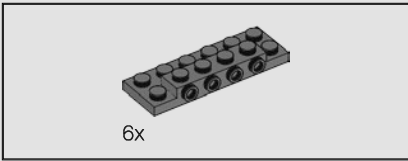

4

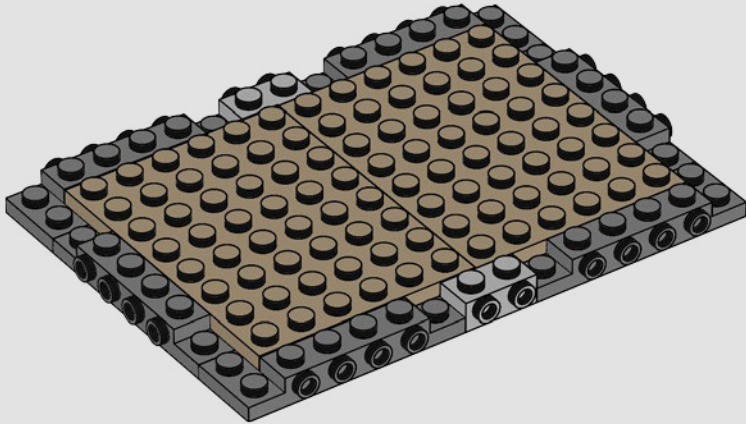

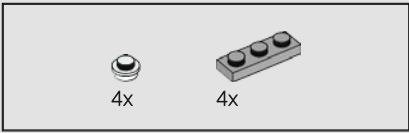

5

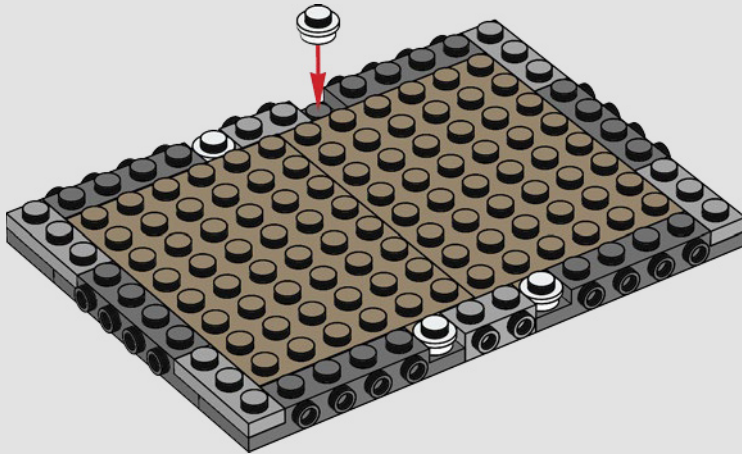

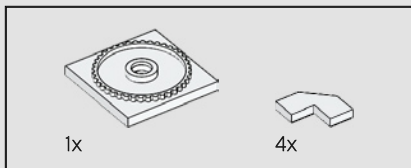

6

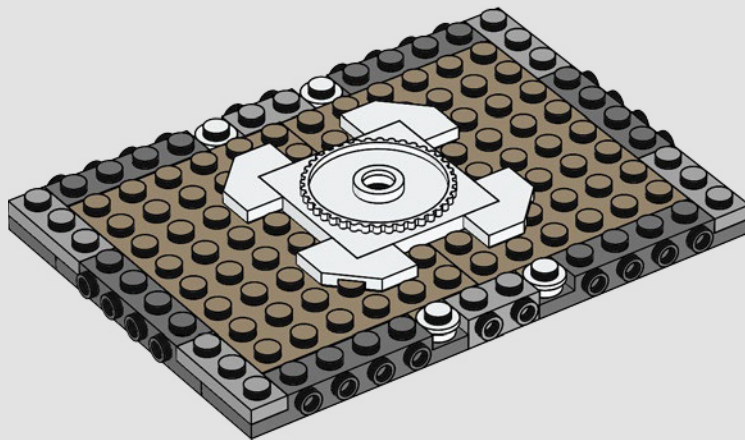



4x

7

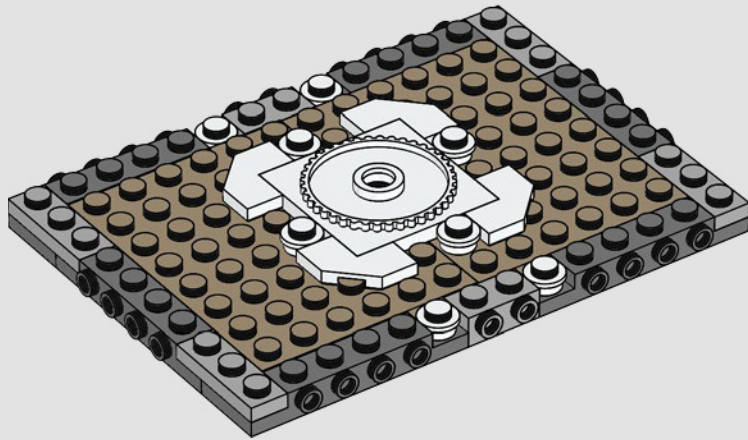

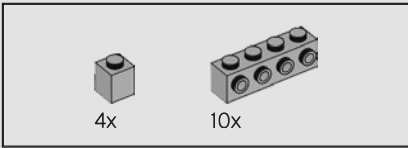

8

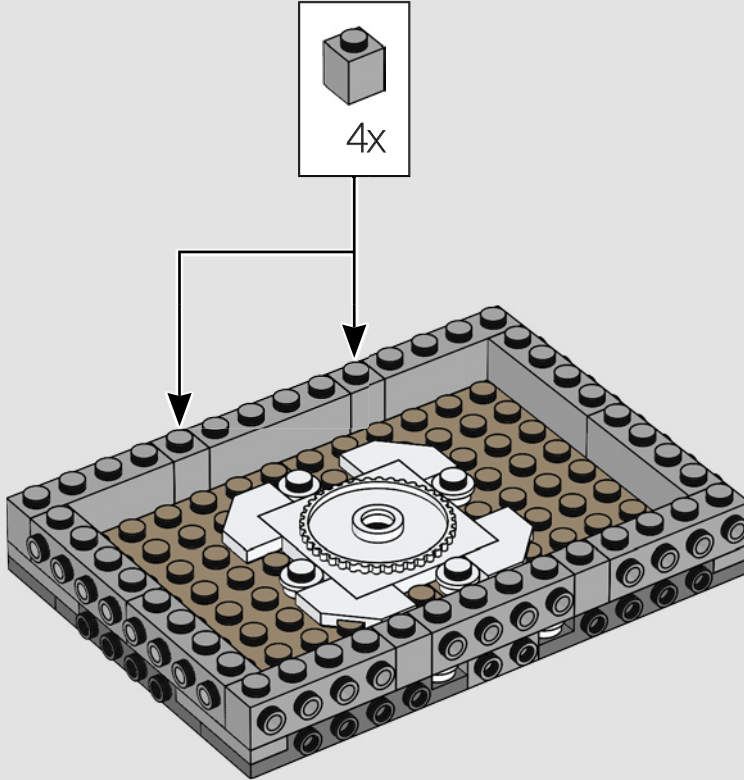

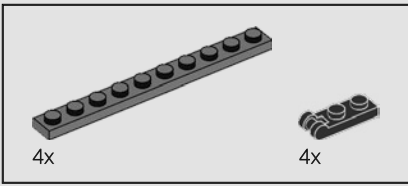

9

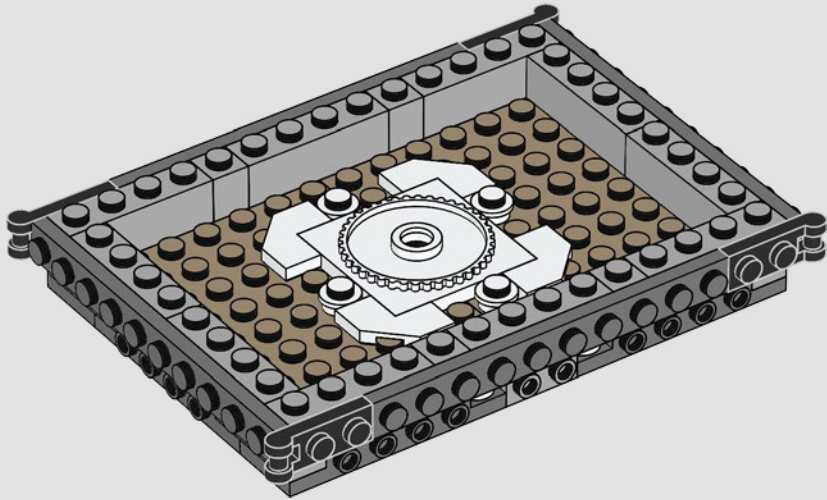



24x

10

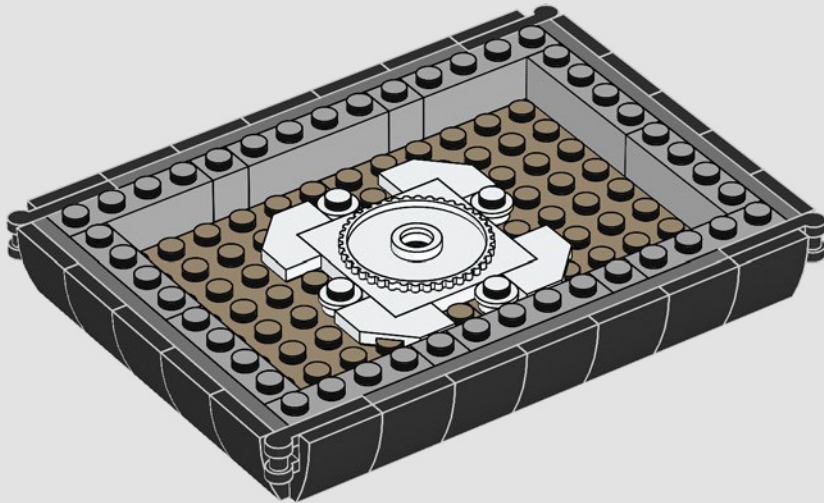

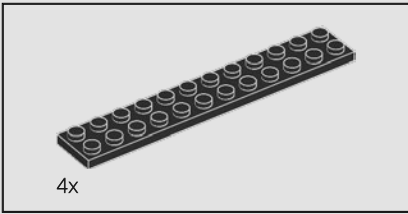

11

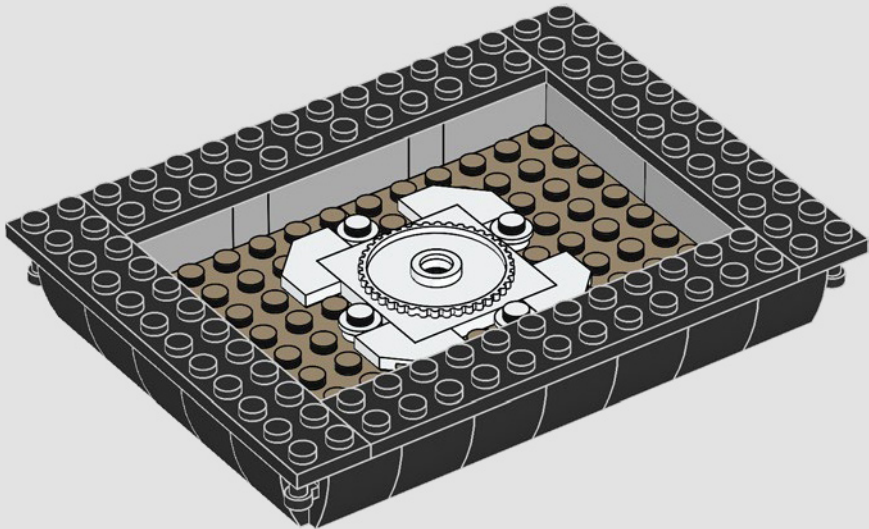

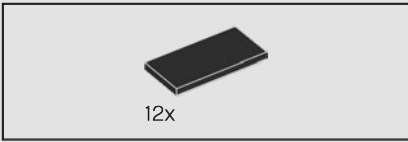

12

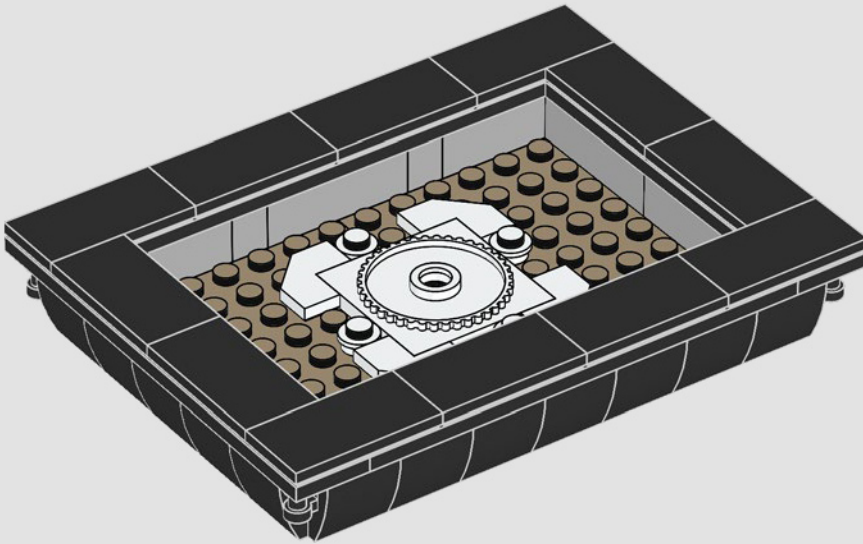



13

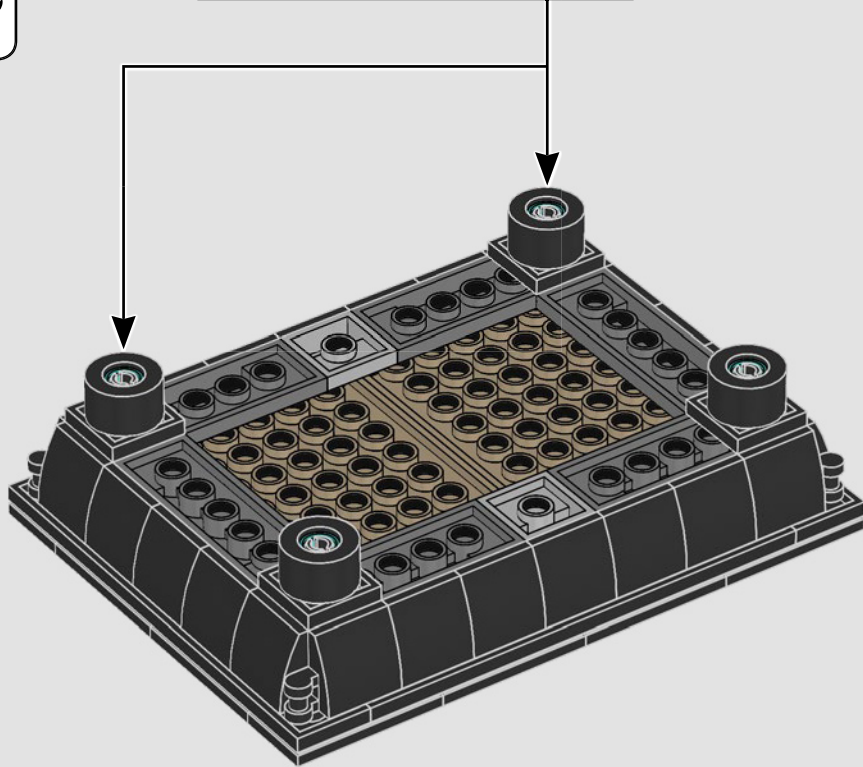
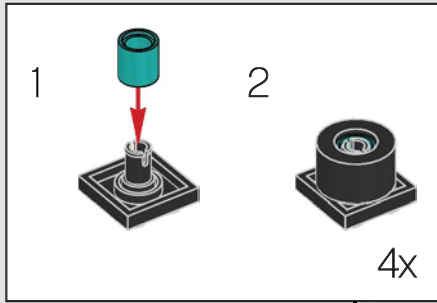

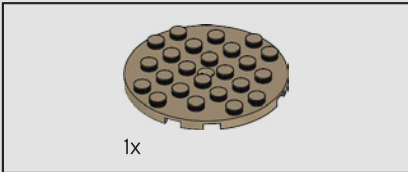
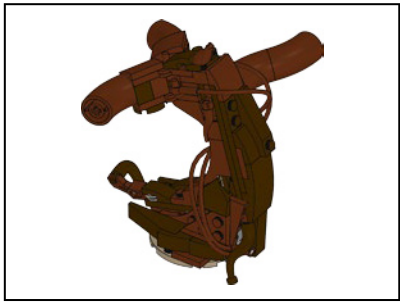
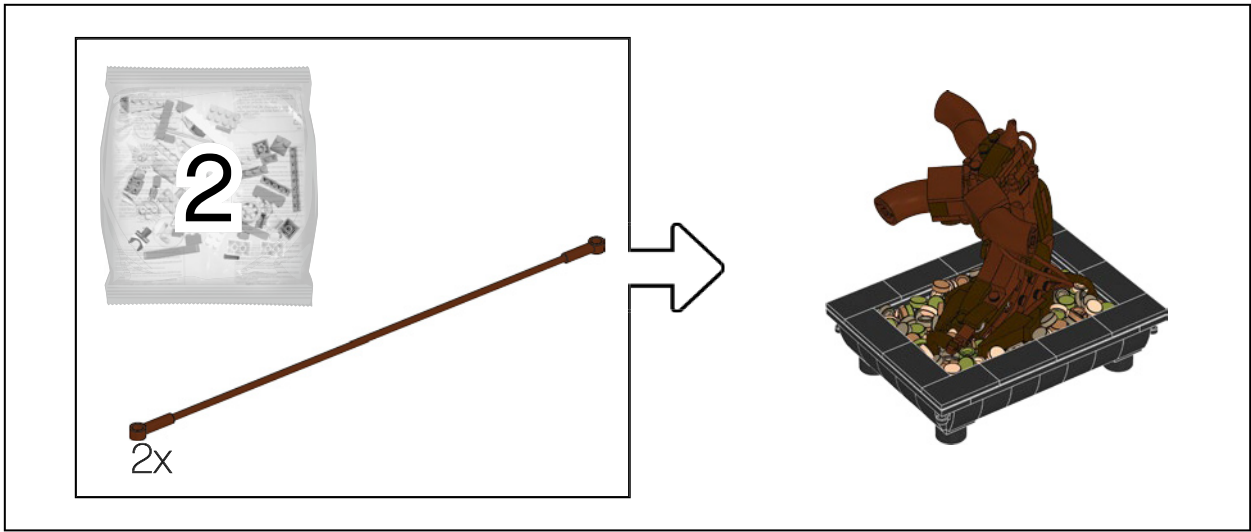

14

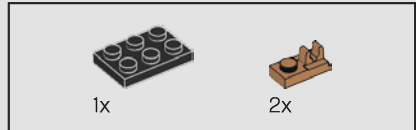
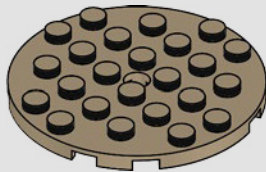

15

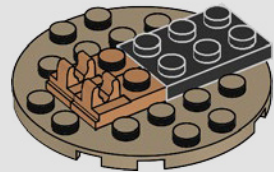



16

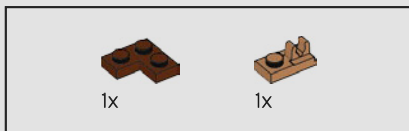
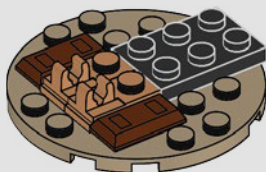

17

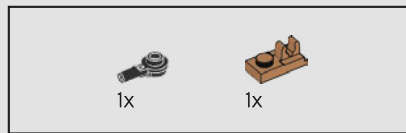
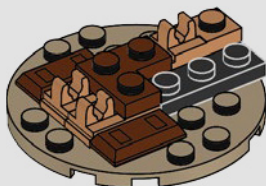

18

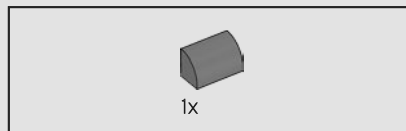
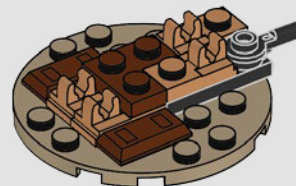

19

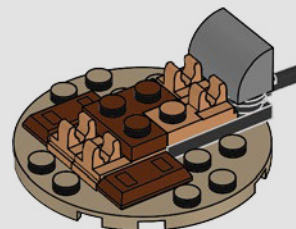

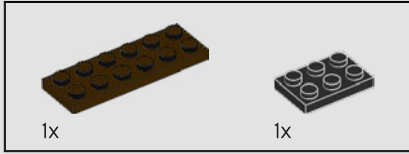
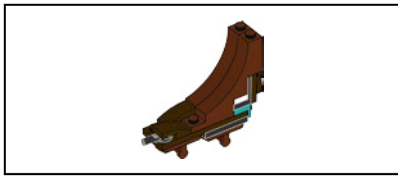

20

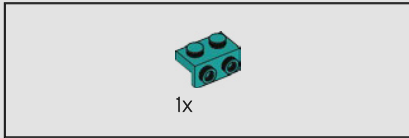
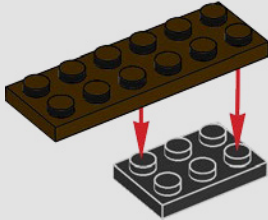

21

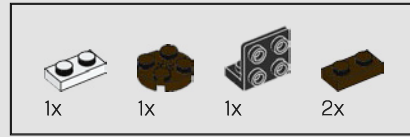
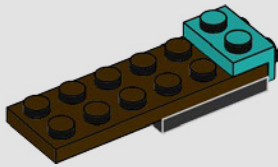

22

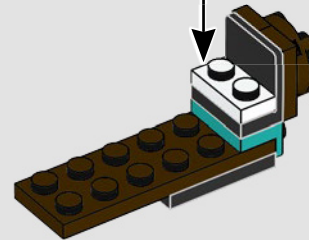
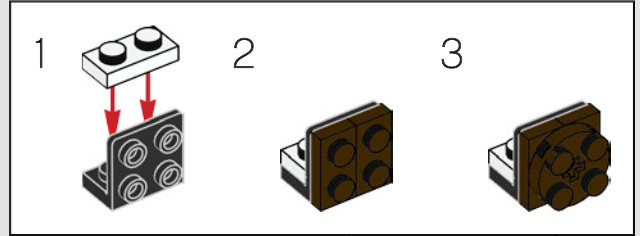

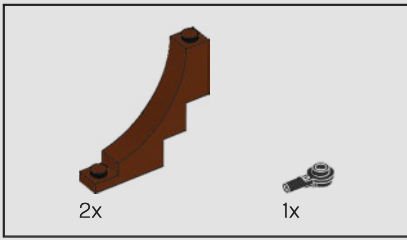

23

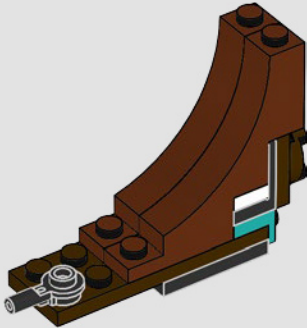

24

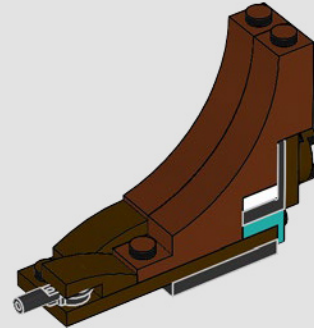



25

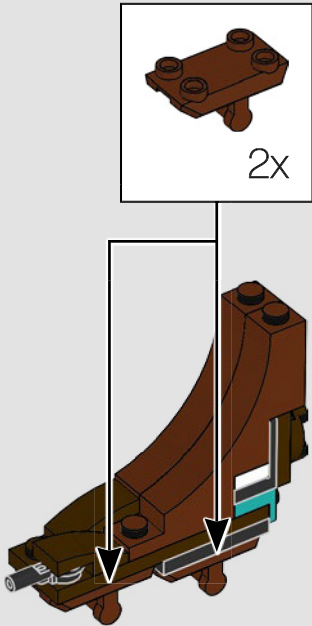

26

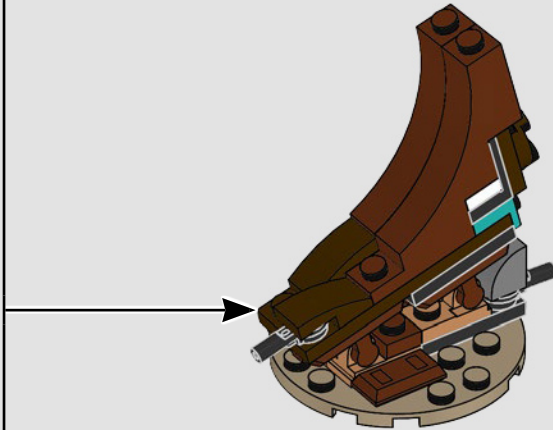

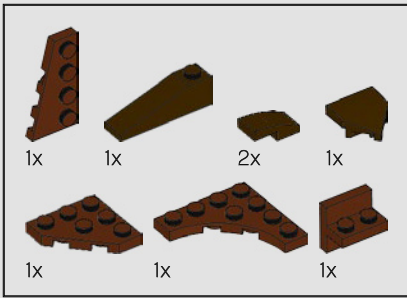

27

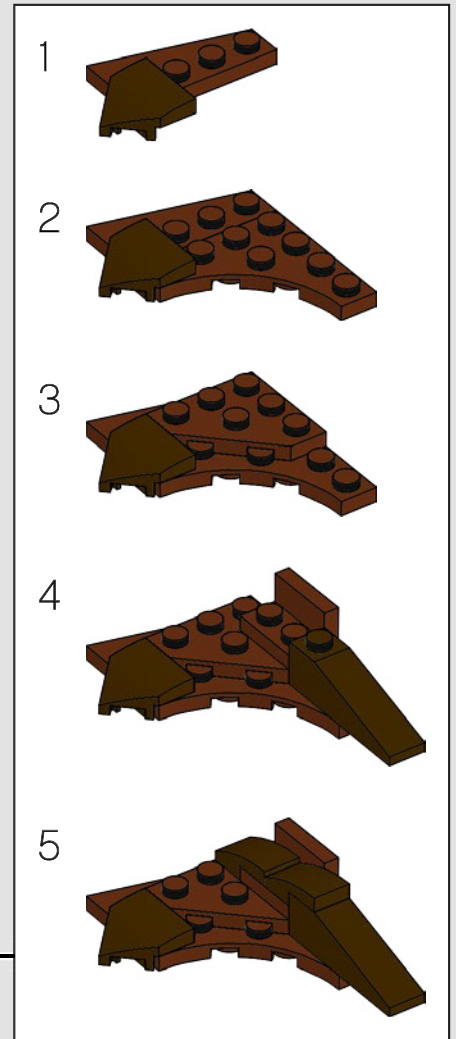
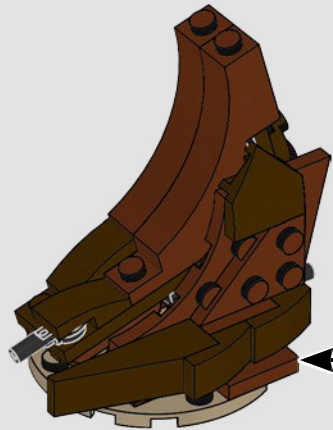

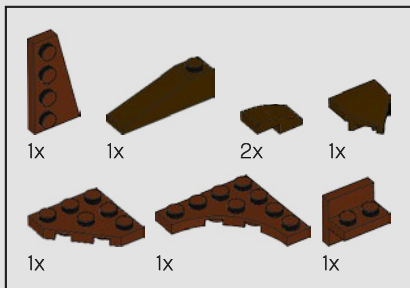

28

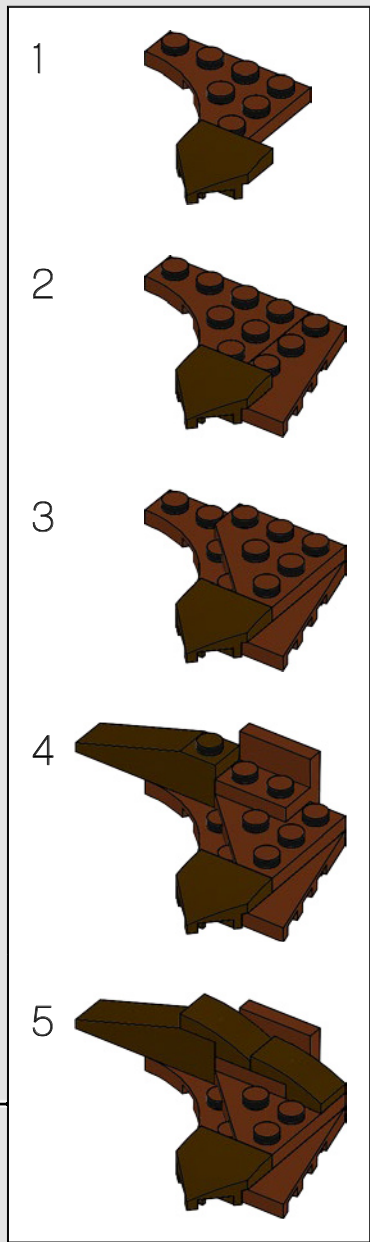
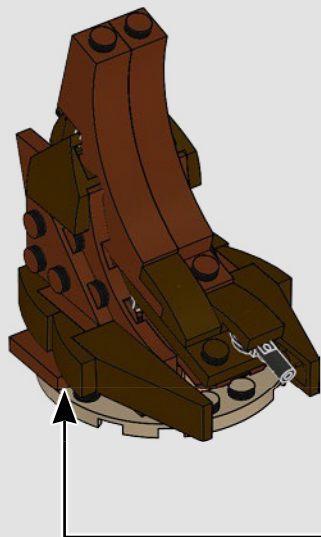

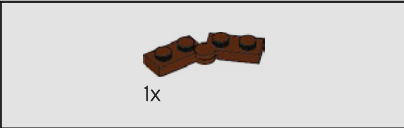
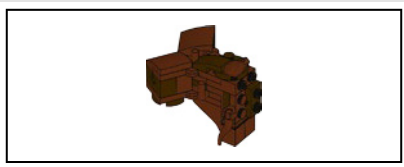

29



30

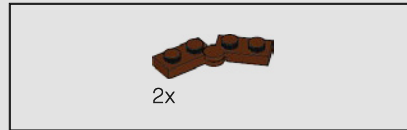
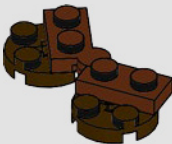

31

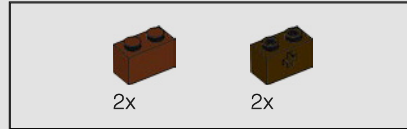

32

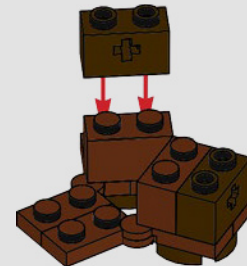

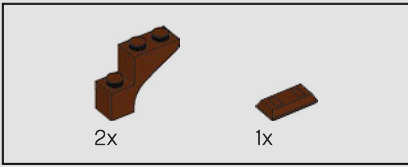

33

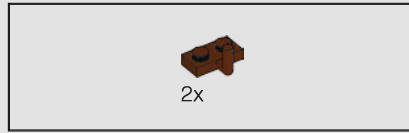
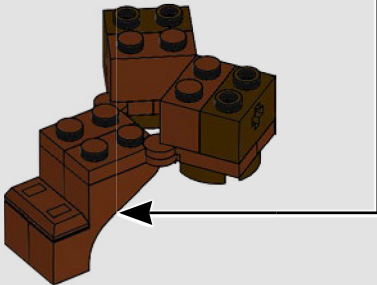
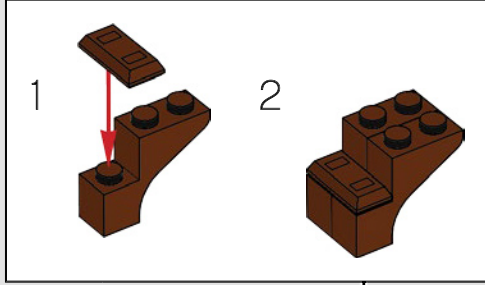

34

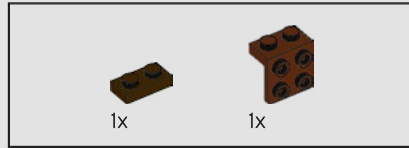
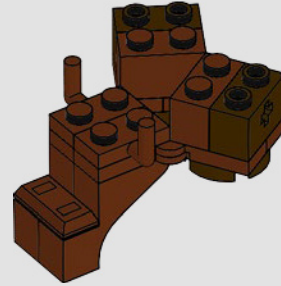

35

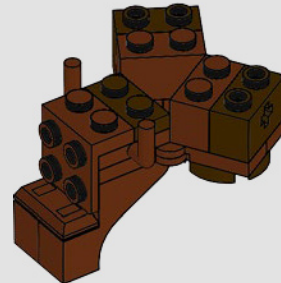

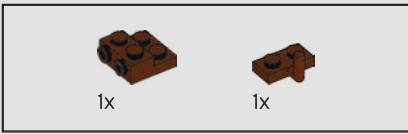

36

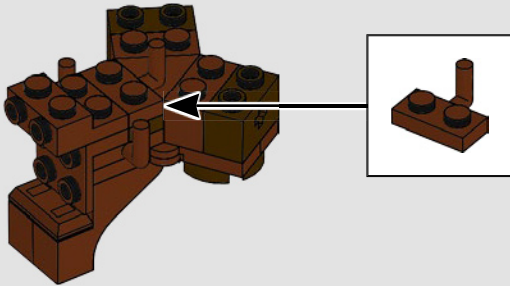

37

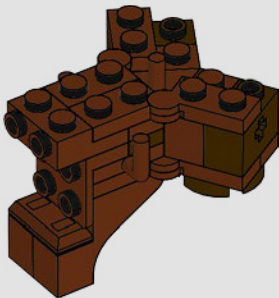

38

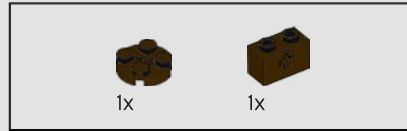
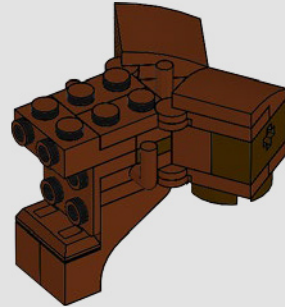

39

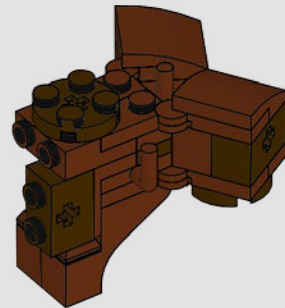

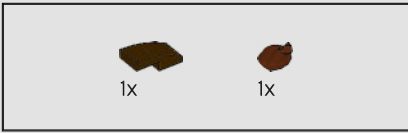

40

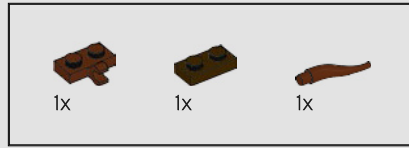
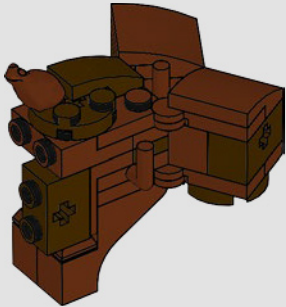

41

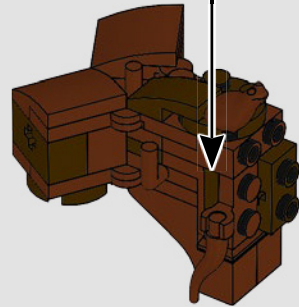
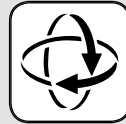
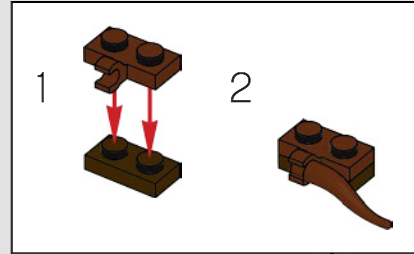

42

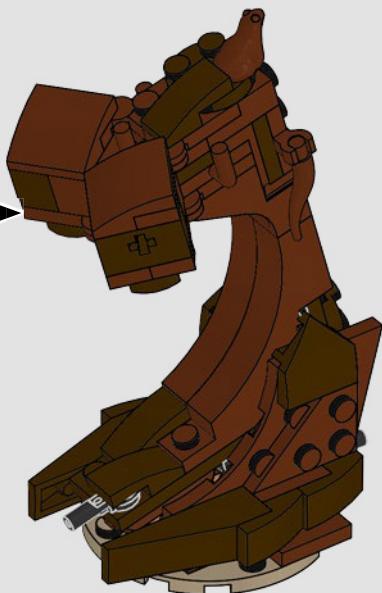

43

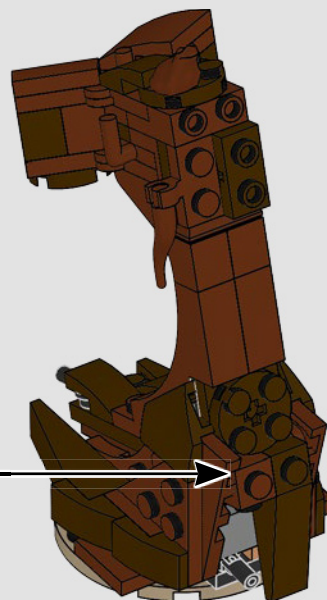
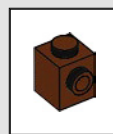
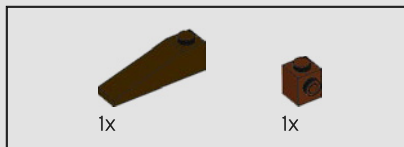

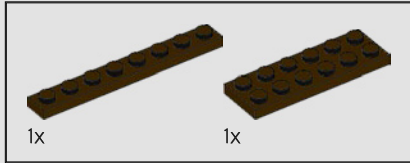
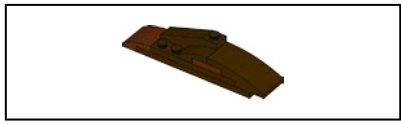

44

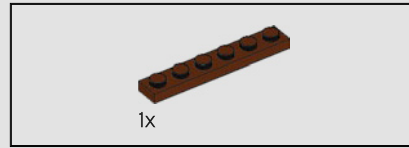
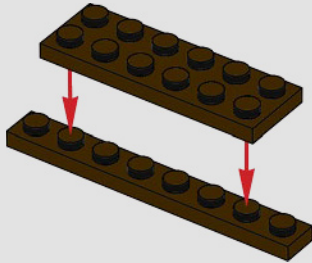

45

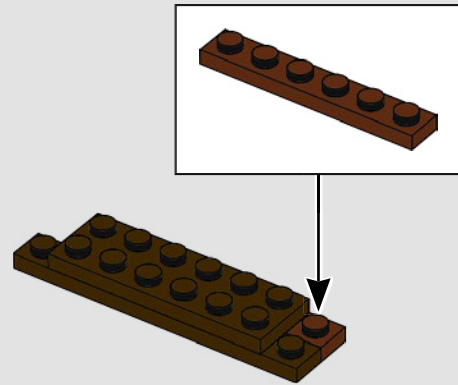

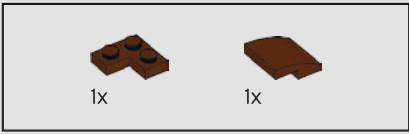

46

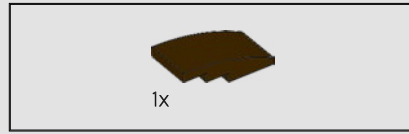
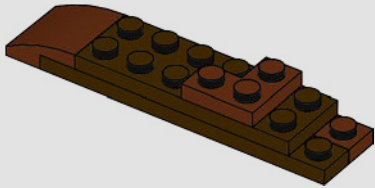

47

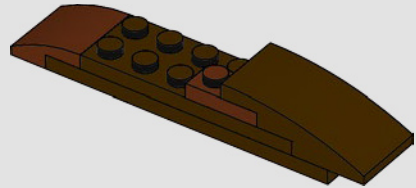

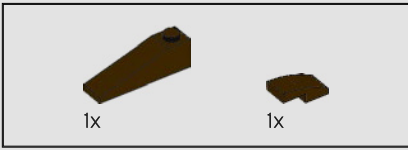

48

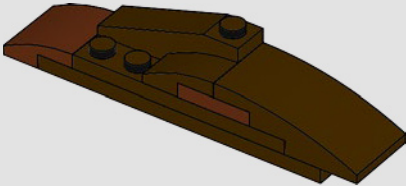

49

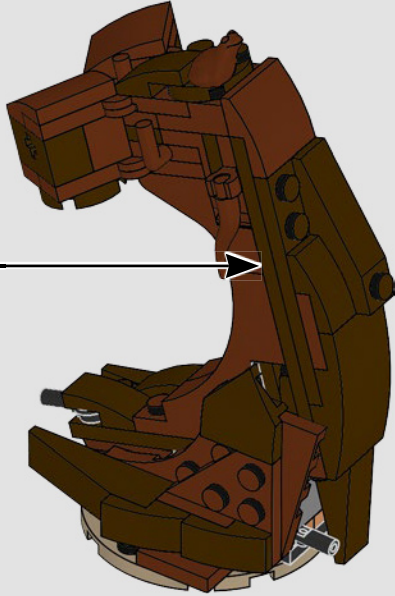

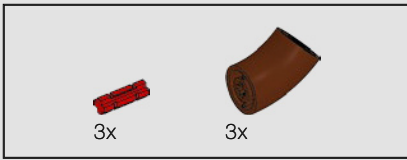

50

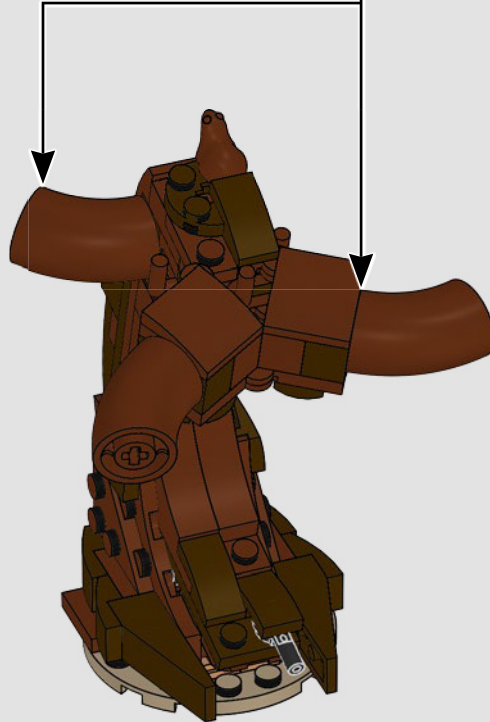
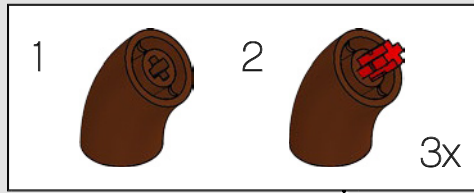

This is one of the first times this particular element has been used in a LEGO® set in a reddish-brown colour.

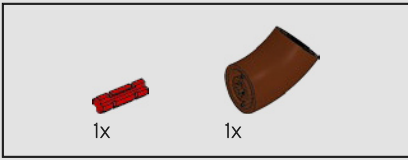

51

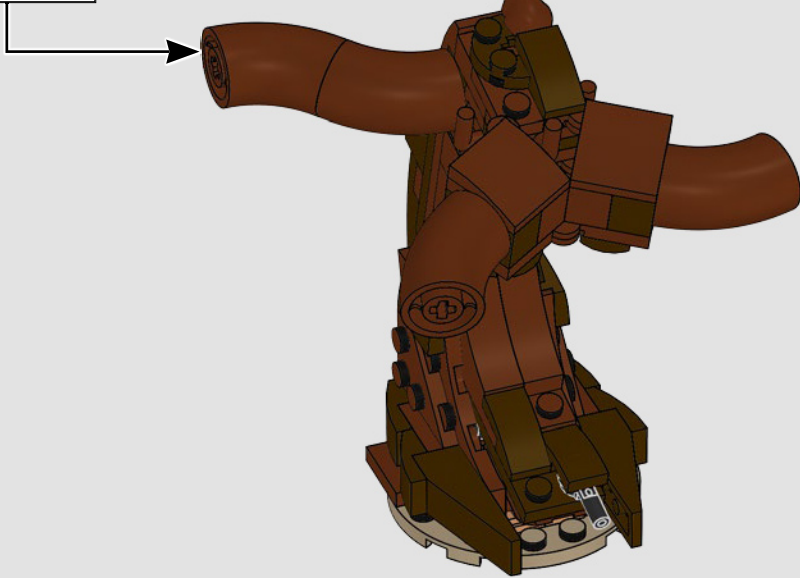
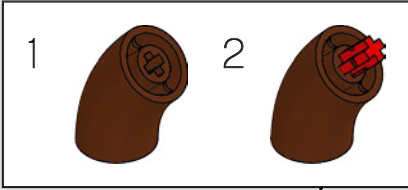

It's the first time these LEGO® 'vine' elements have appeared in a reddish-brown colour.

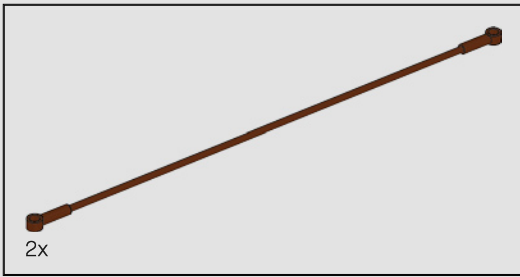

52

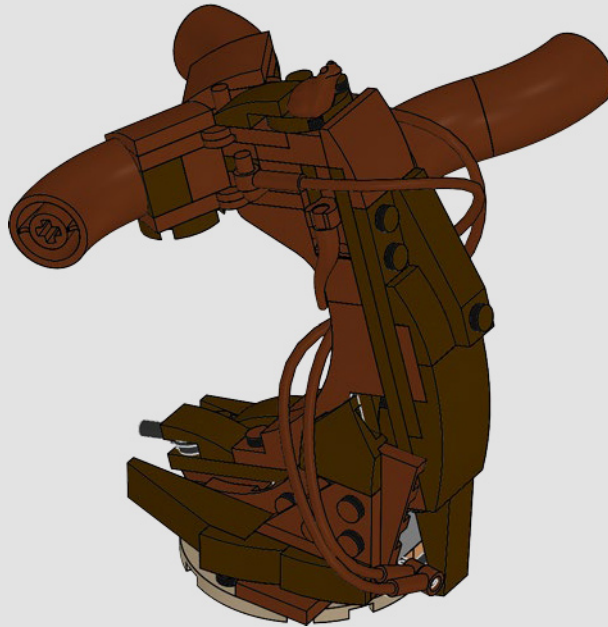

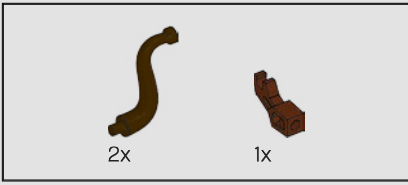

53

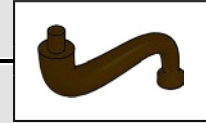
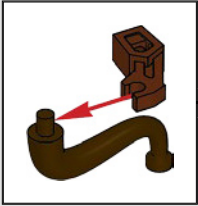
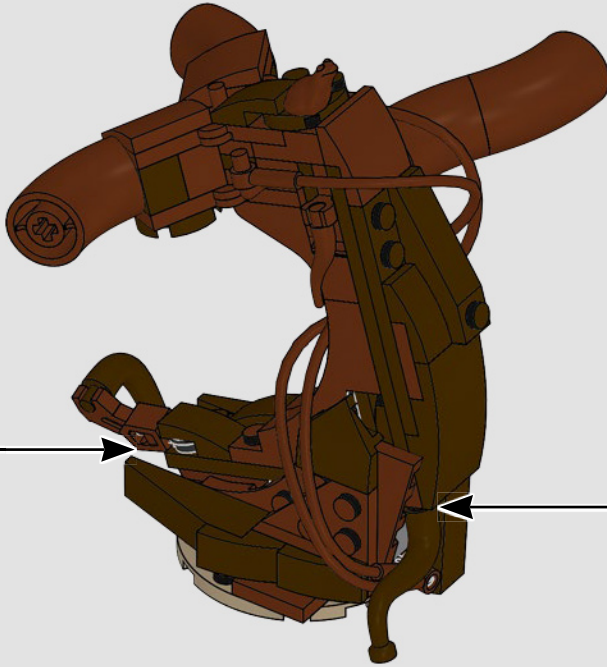

These root pieces were originally used as elephant trunks, perfect for slurping water!

54

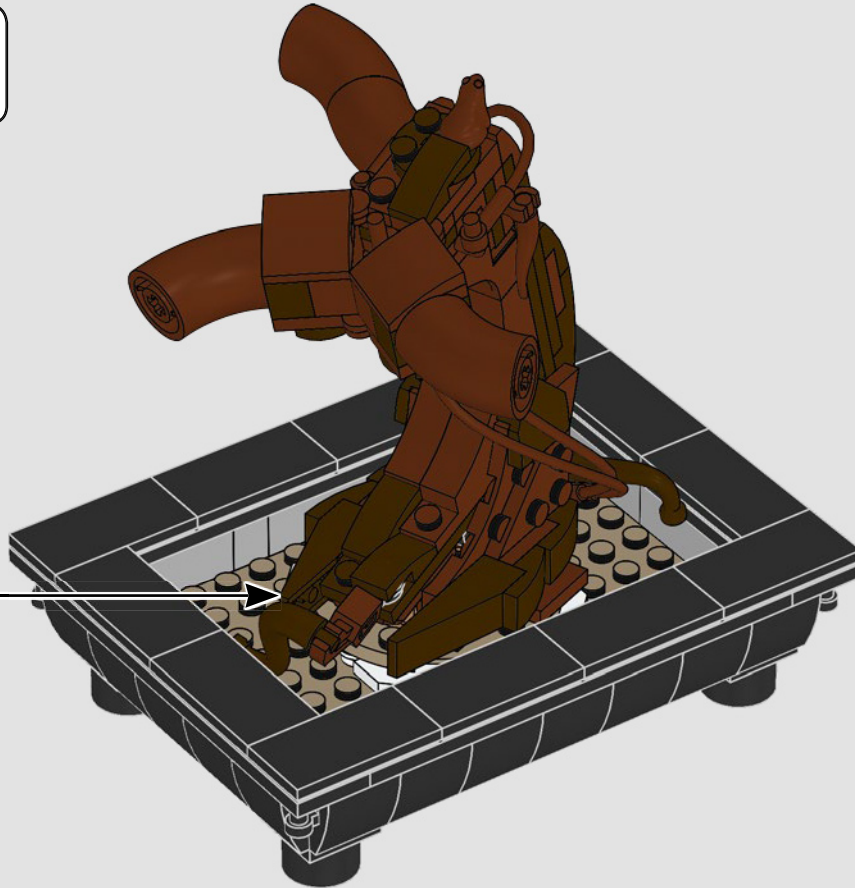

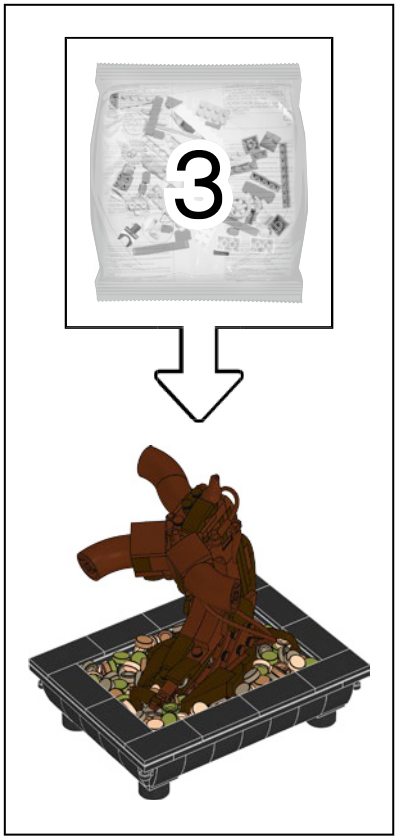

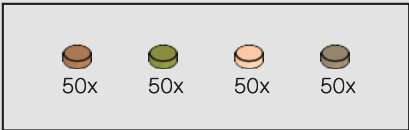

55



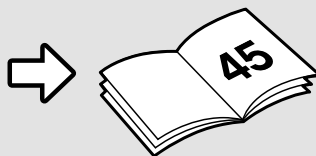

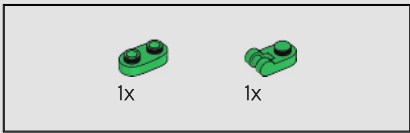
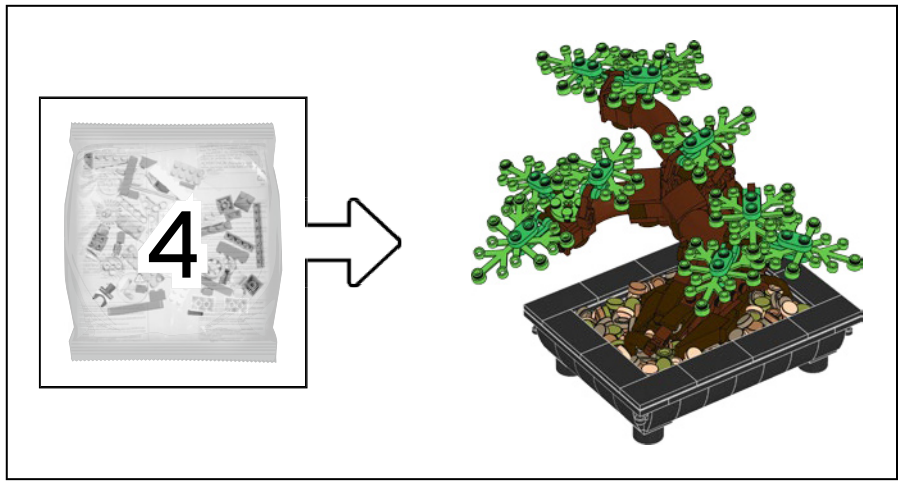

56

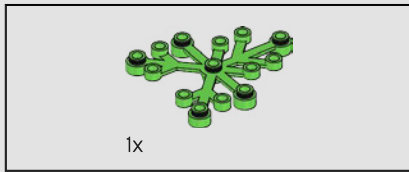
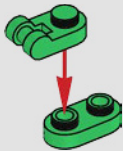

57



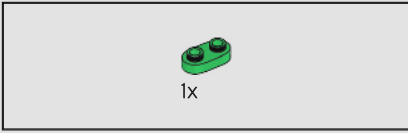

58

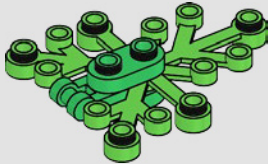

59

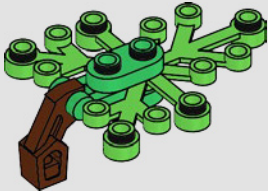

60



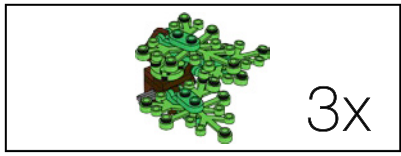

61

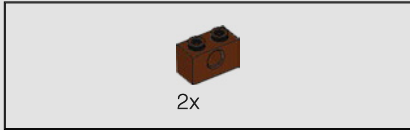

62

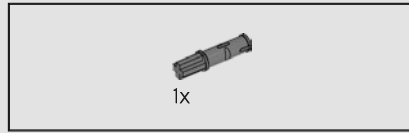
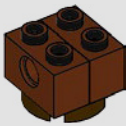

63

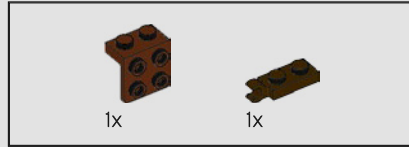
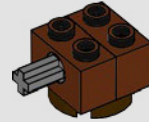

64

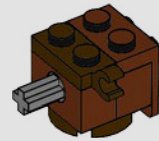

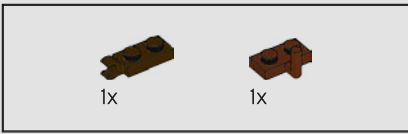

65

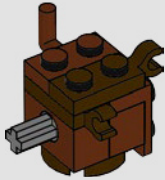

66

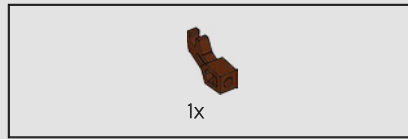
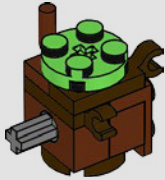

67

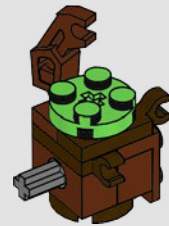

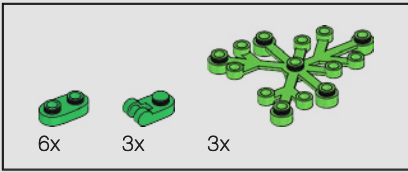

68

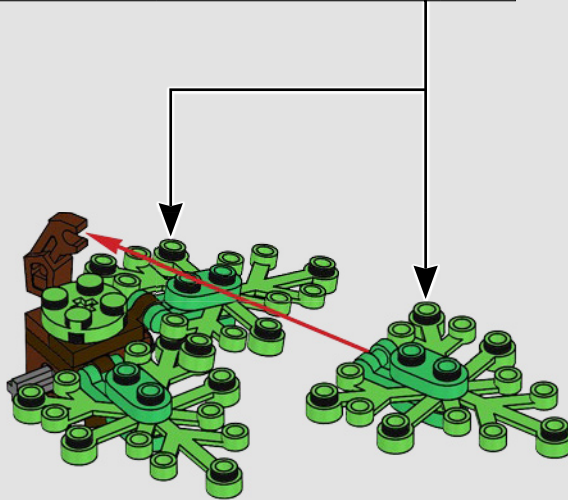
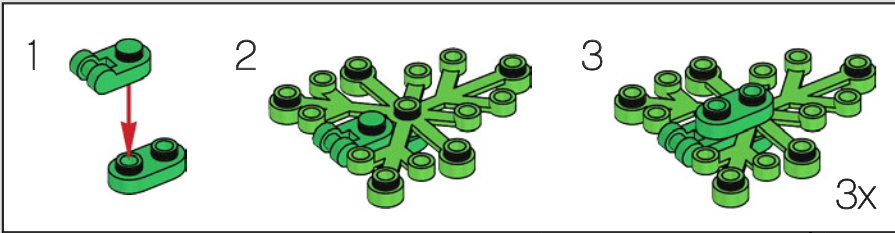

3x

69



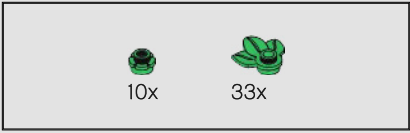

70

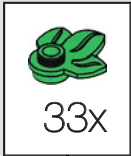

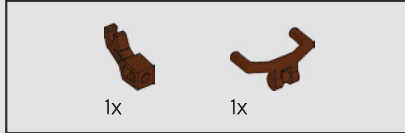
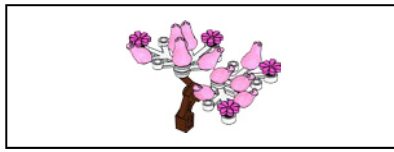
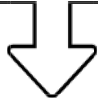

71

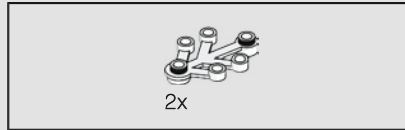
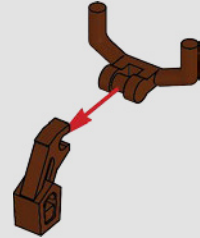

72

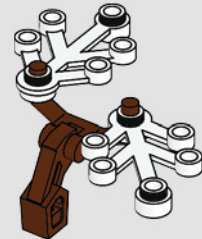

These branch connectors were originally used as mini-doll bicycle handlebars.

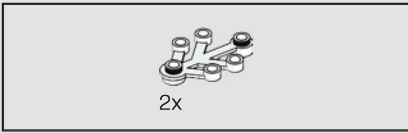

73

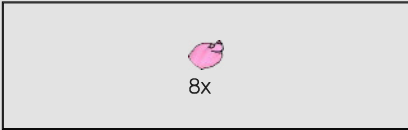
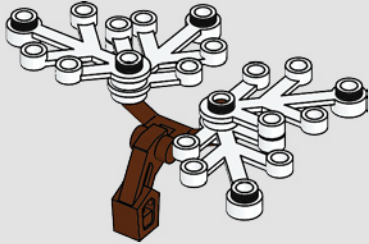

74

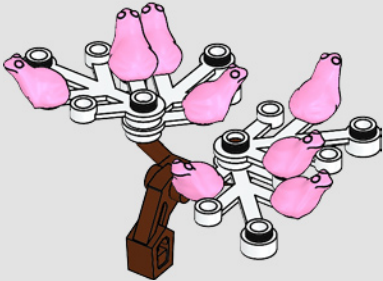

75

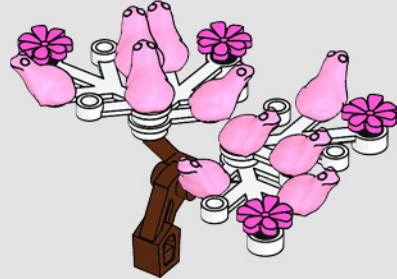

76



It's the first time these 'frogs' have been seen in this light purple colour.

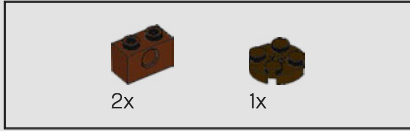
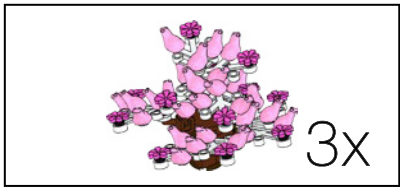

77

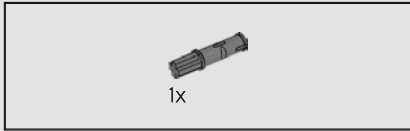
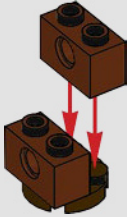

78

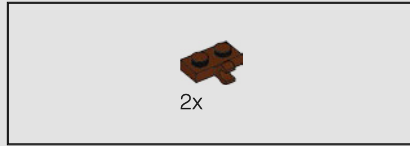
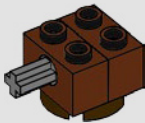

79

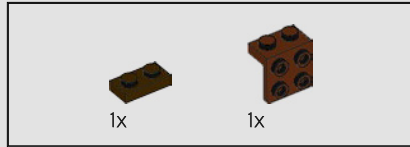
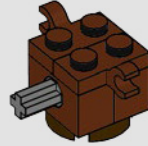

80

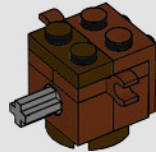

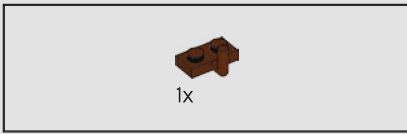

81

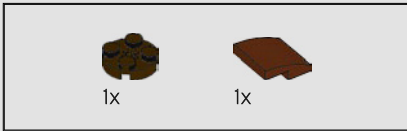
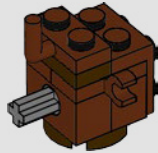

82

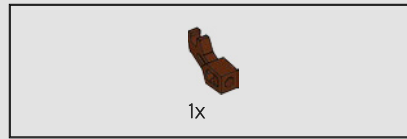
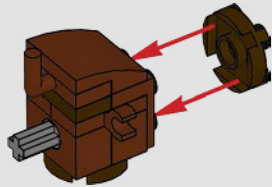

83

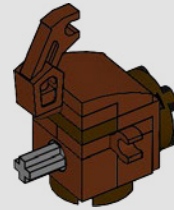

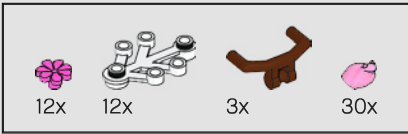

84

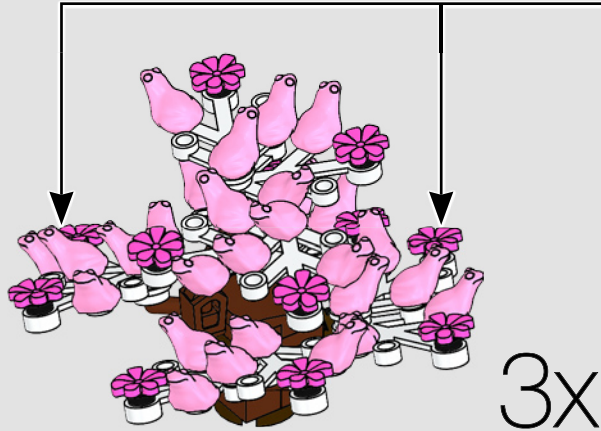
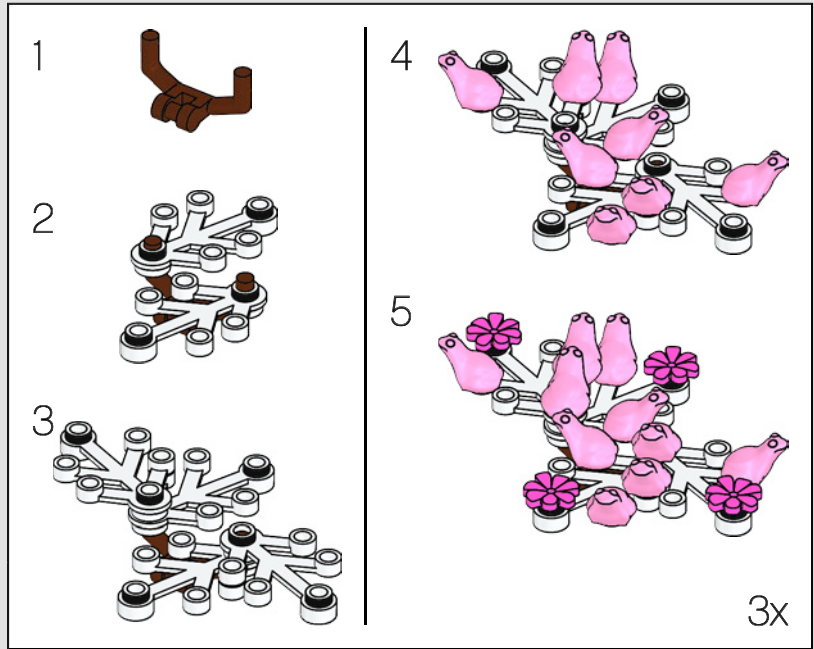

With 101 frogs available, this is the greatest number of frogs used in any single LEGO® set.

85



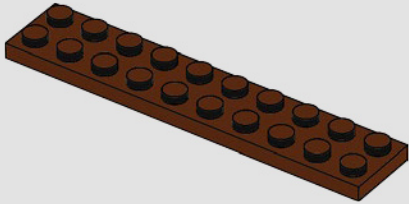
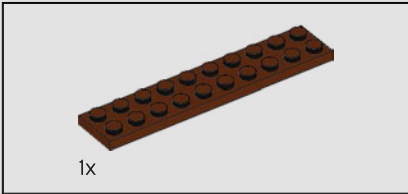
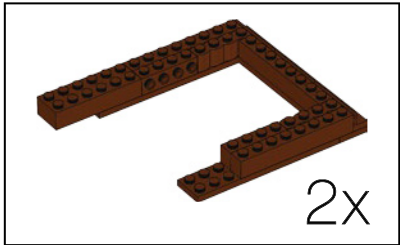
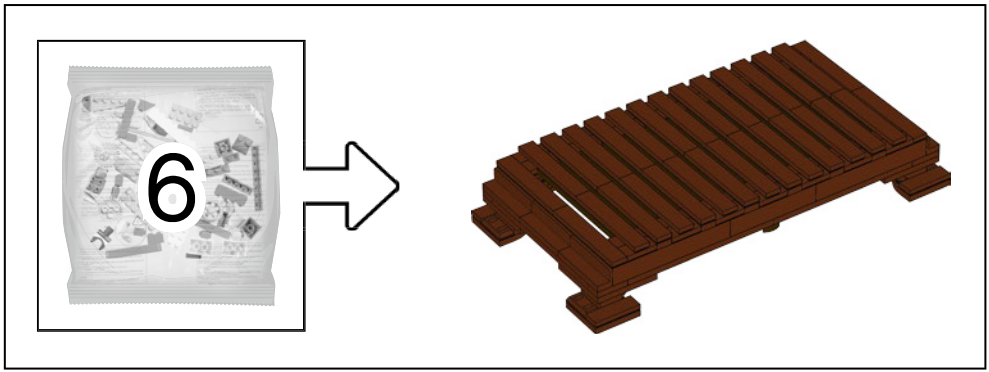

86

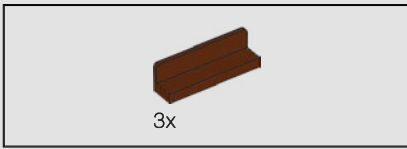

87

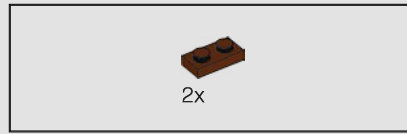
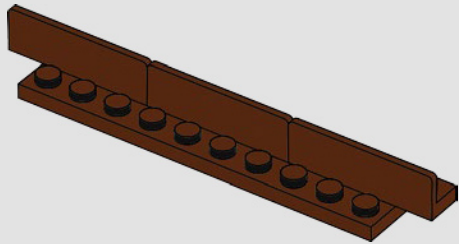

88

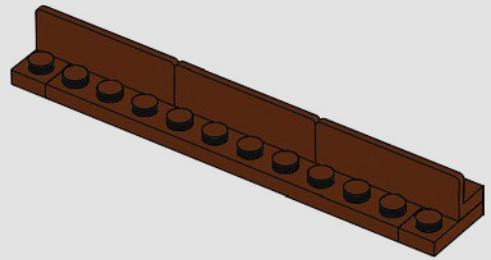

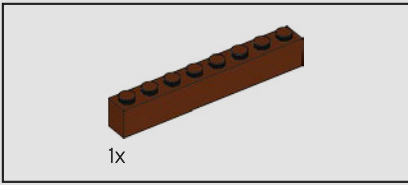

89

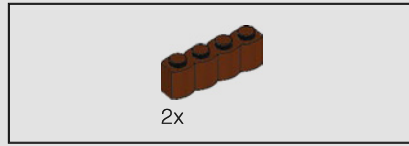
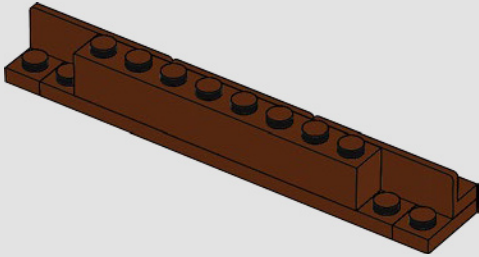

90

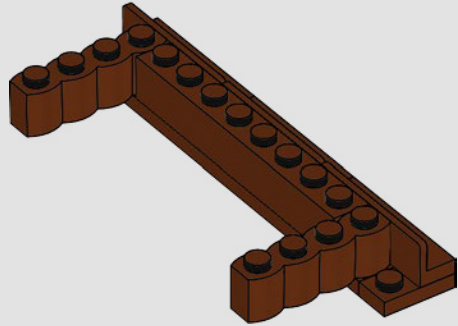

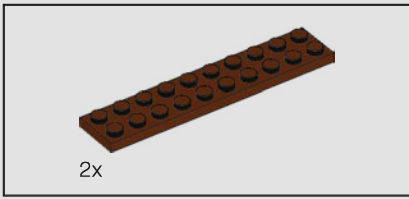

91

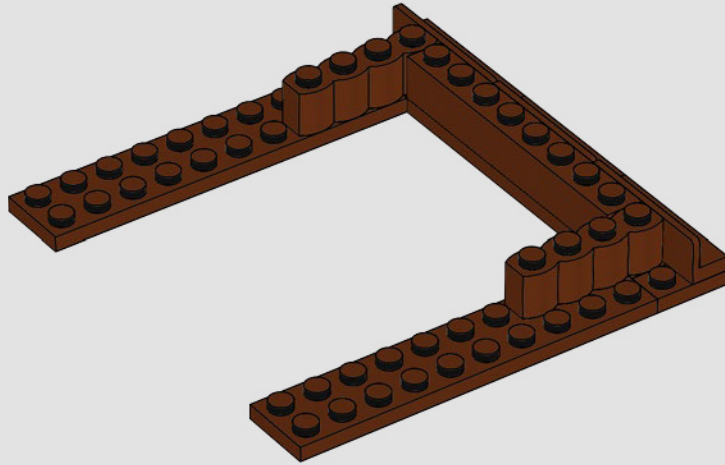

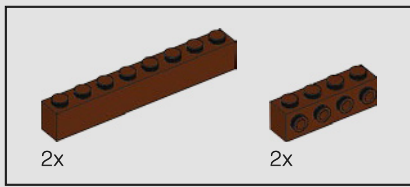

92

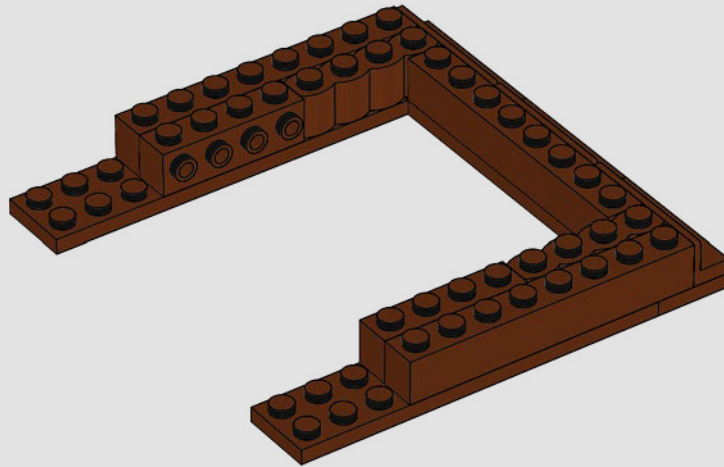

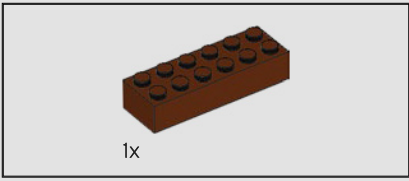

93

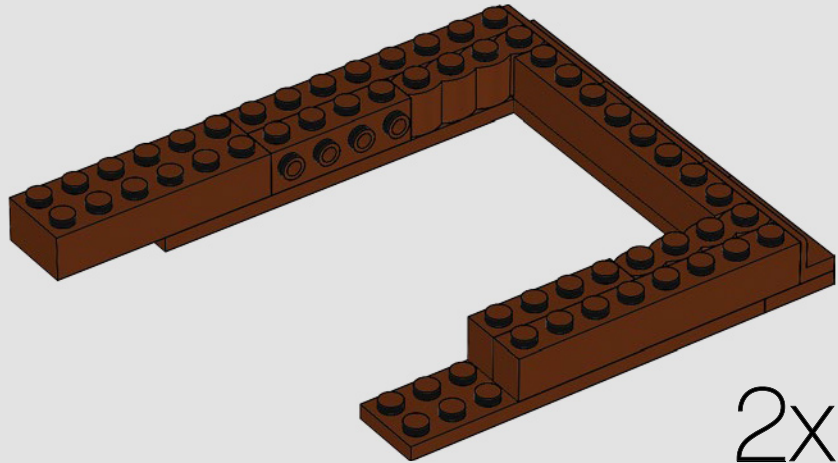

94

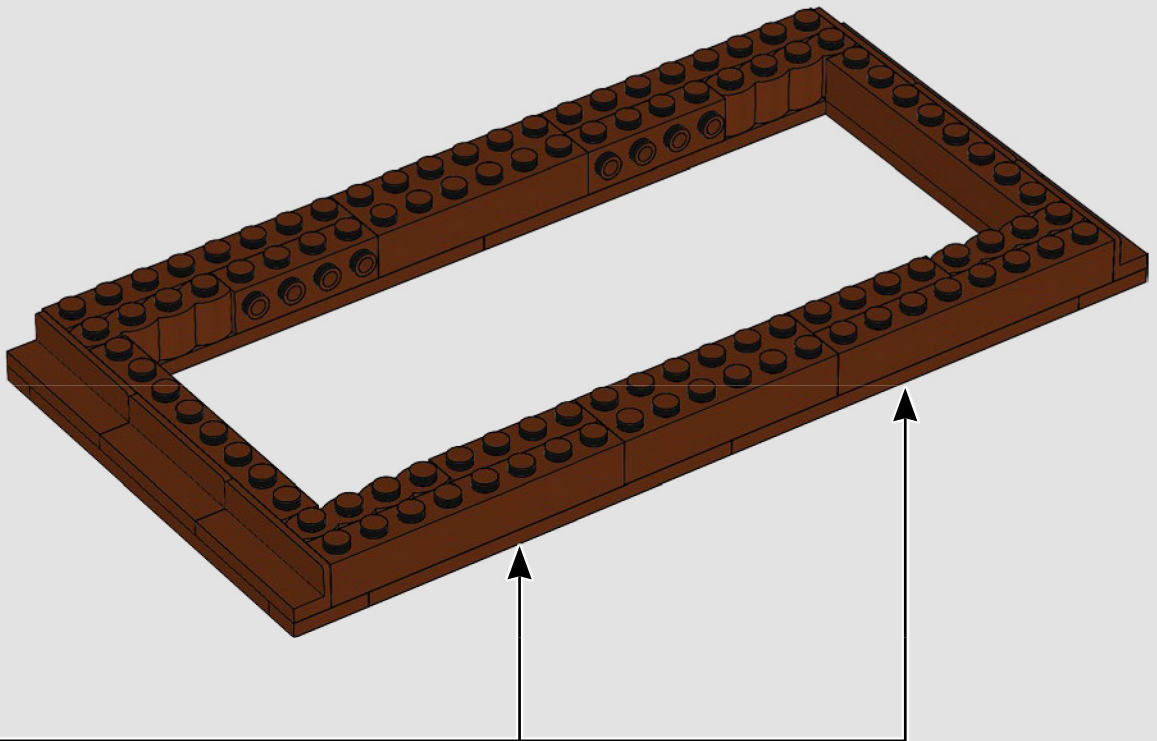

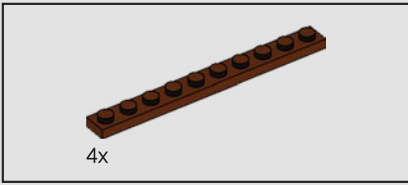

95

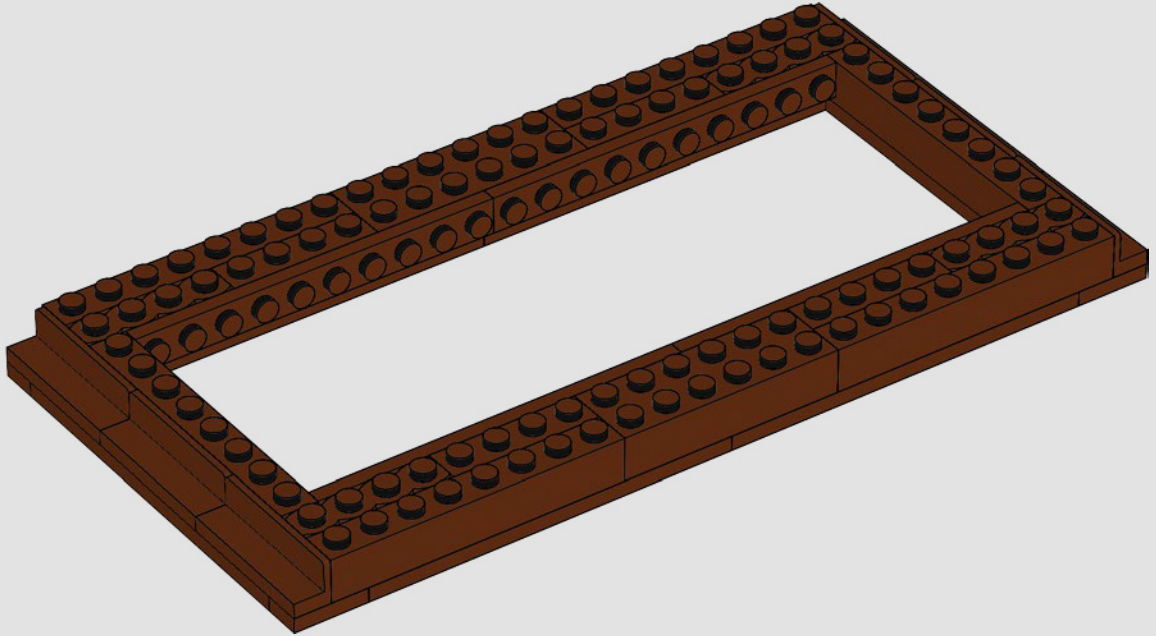

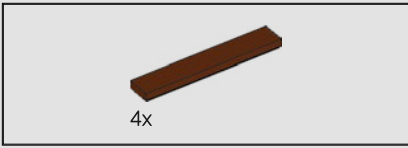

96

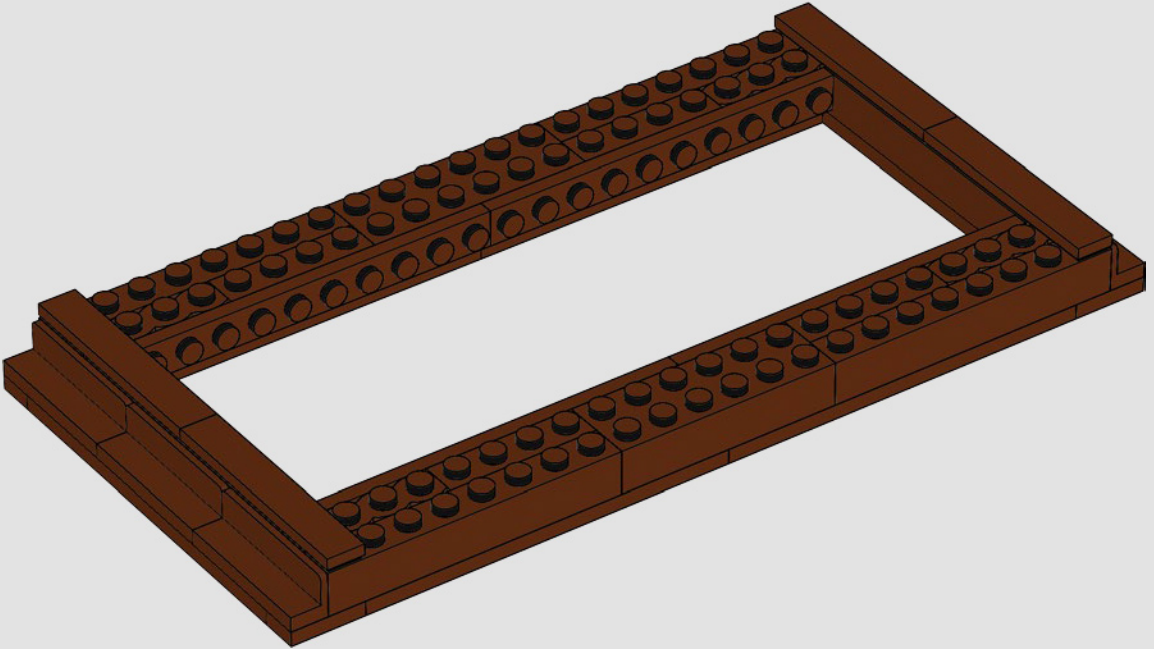

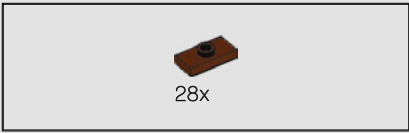

97





98



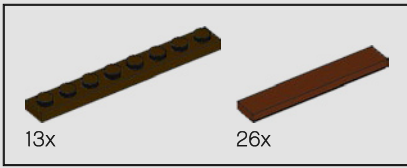

99

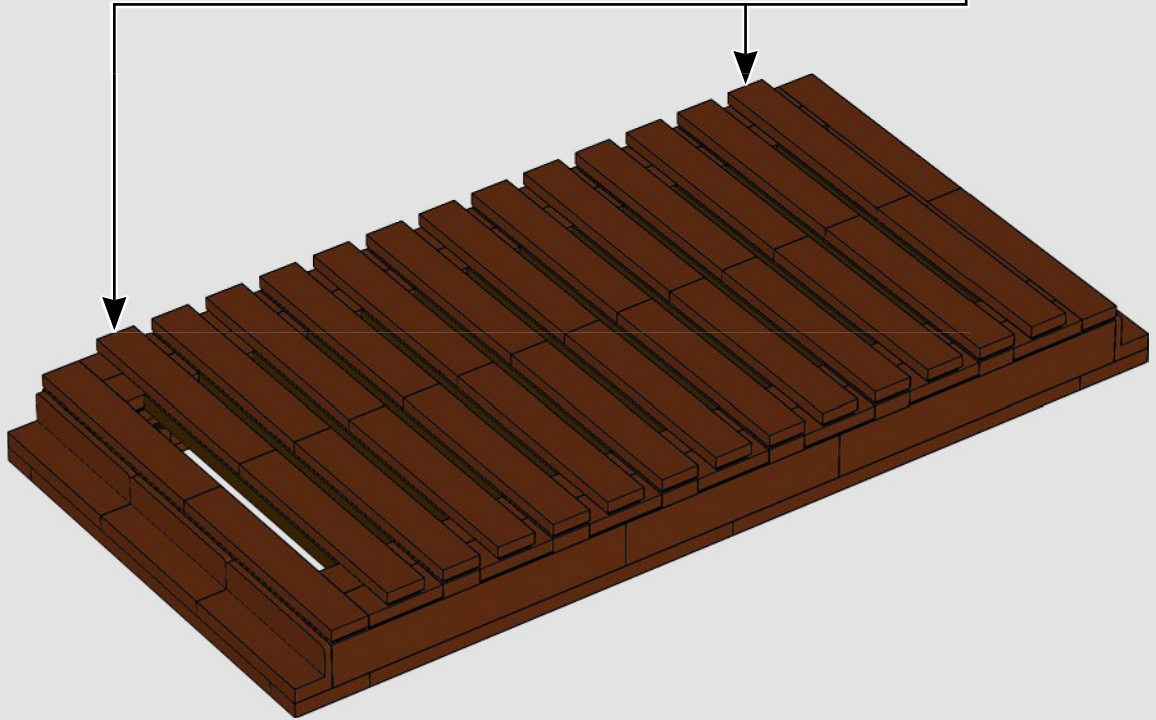
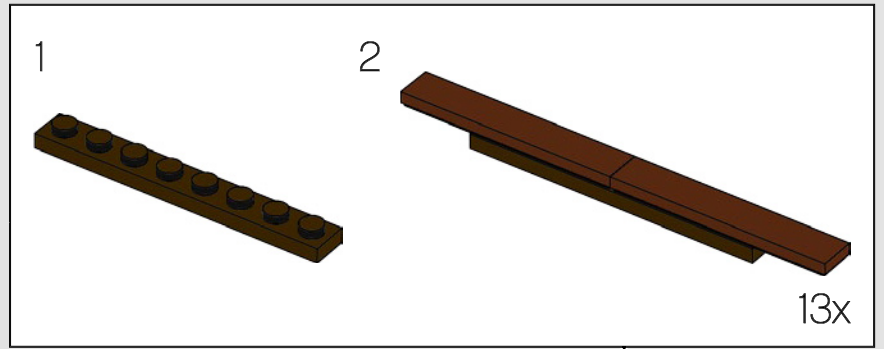



100

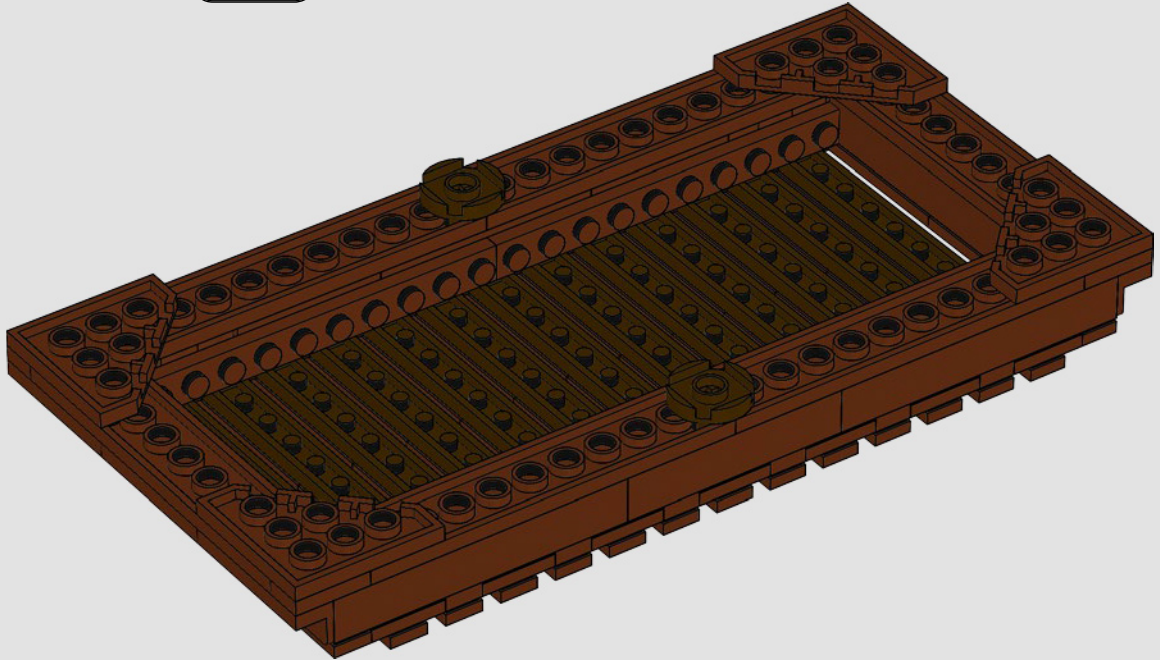

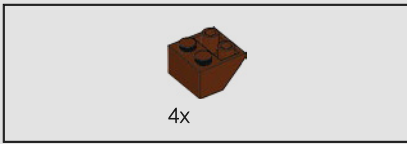

101

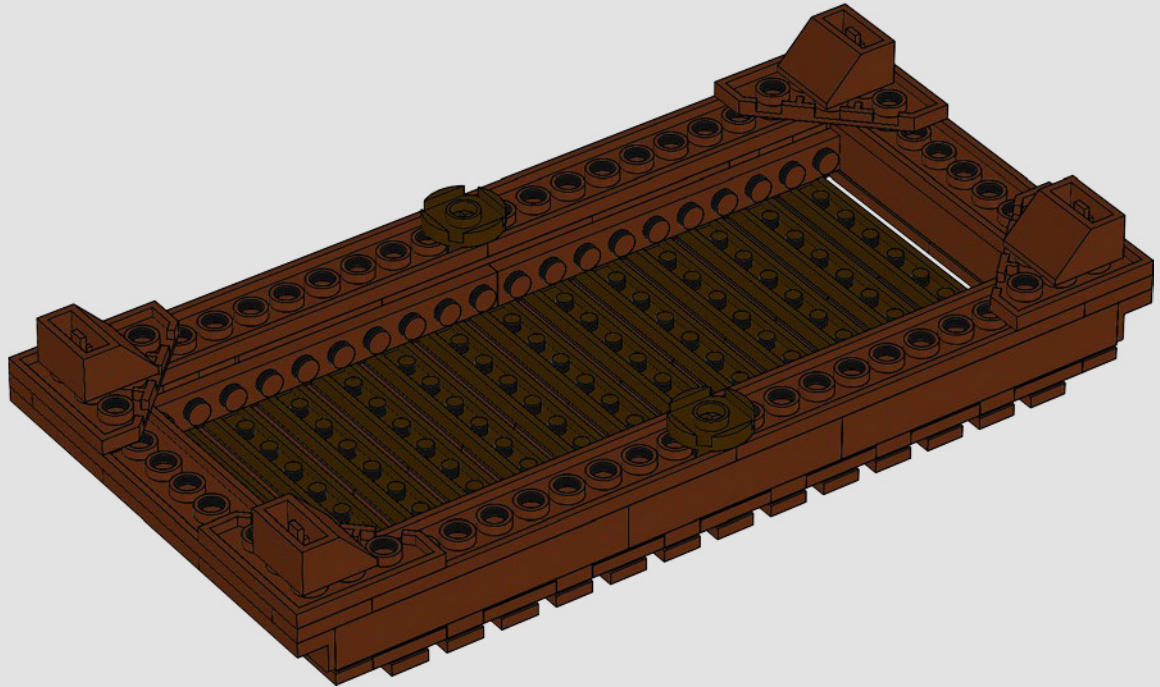

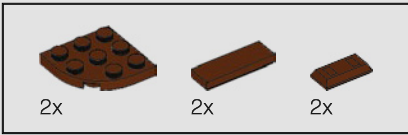

102

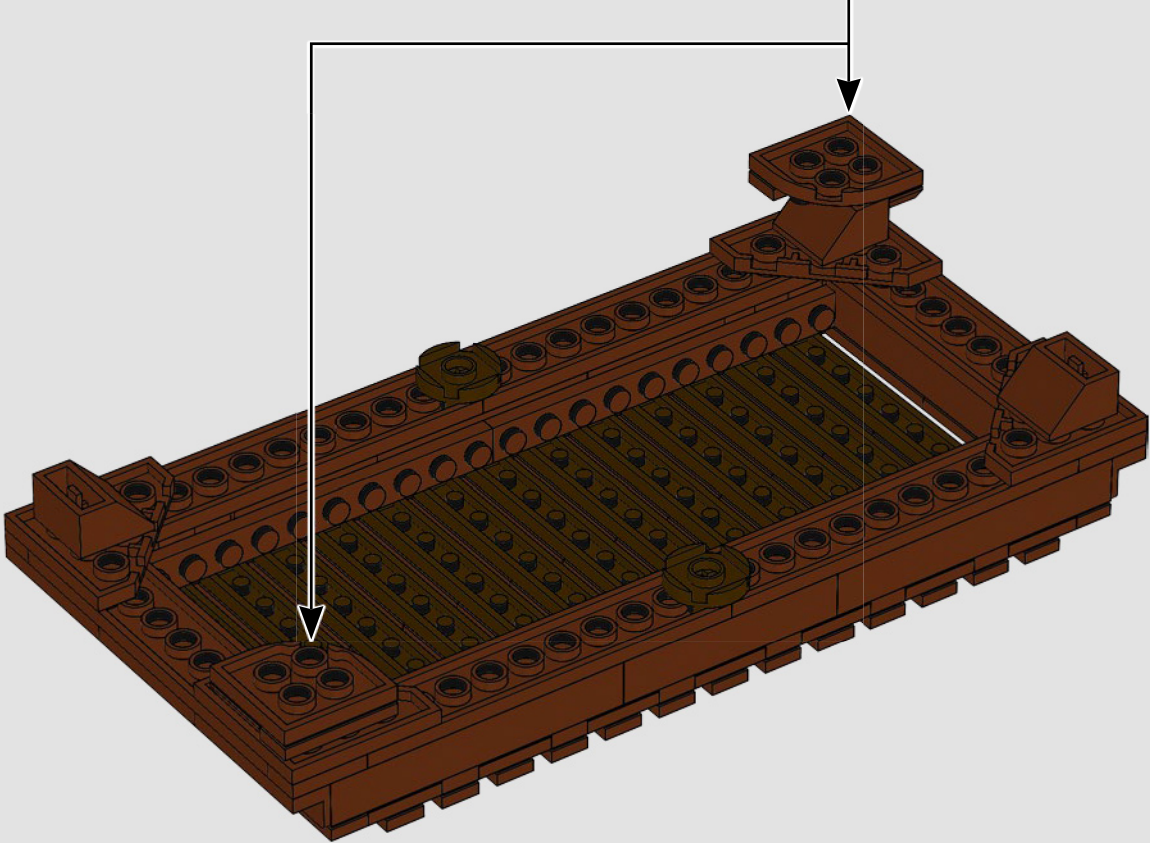
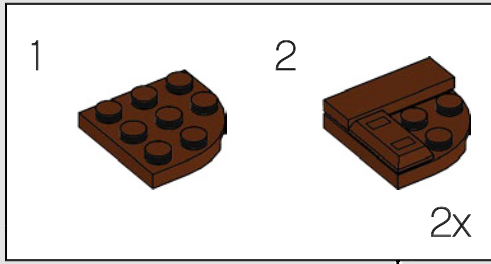

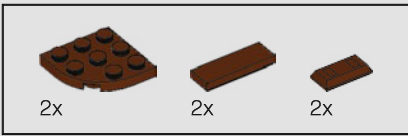

103

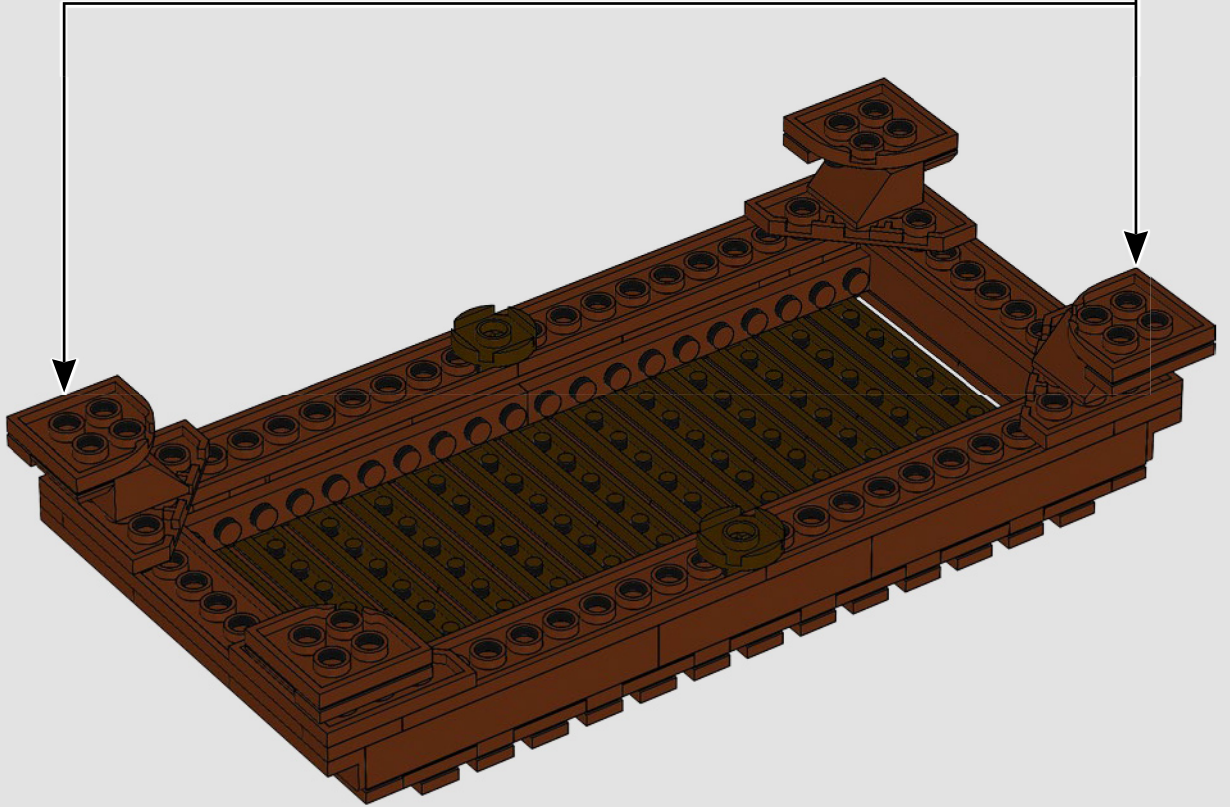
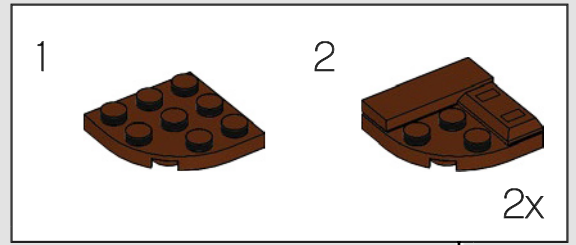

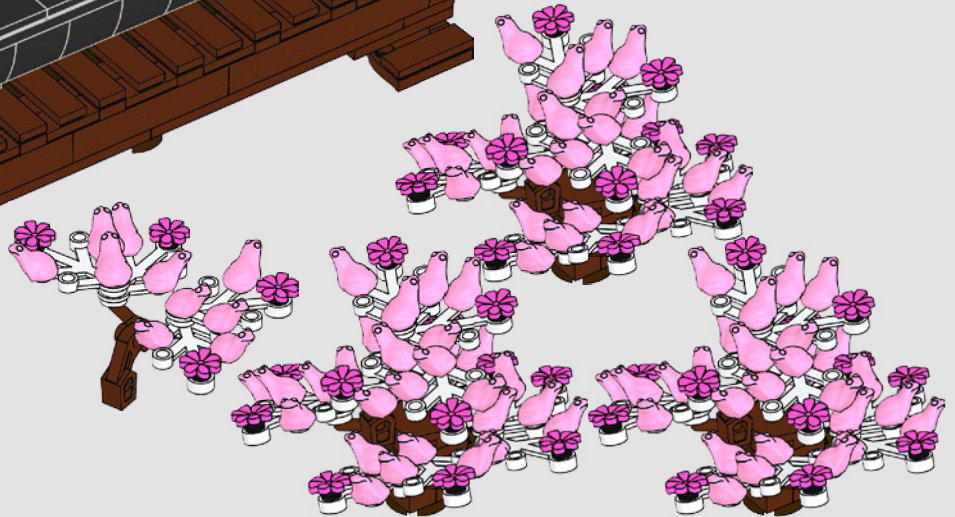
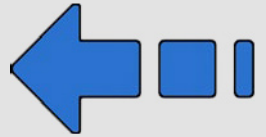



CARRY ON GROWING

Unlike other art forms, a LEGO® Bonsai tree is never complete, but is instead an ongoing dynamic masterpiece. Once you have mastered the first two varieties of LEGO Bonsai, we hope you will want to branch out and create your own individual vision of the perfect tree. We have created this gallery to inspire you in your future building (they cannot be built from the bricks included in this set). While all the elements you see here are LEGO elements, not all of them are still available in our assortment, so hunt out your old LEGO sets and use whatever you find.



Inspirational models only. Not part of the actual set.



Inspirational models only. Not part of the actual set.



Inspirational models only. Not part of the actual set.



Customer Service

Kundenservice

Service Consommateurs

Servicio Al Consumidor

LEGO.com/service or dial



00800 5346 5555 :



1-800-422-5346 :





FEEDBACK AND WIN



FEEDBACK AND WIN

Your feedback will help shape the future development of this product series.

Please visit:

FEEDBACK UND GEWINNEN

Dein Feedback trägt zur Weiterentwicklung dieser Produktreihe bei.

Geh auf:

COMMENTEZ ET GAGNEZ

Vos commentaires nous aideront à concevoir les futurs produits de cette gamme.

Rendez-vous sur :

COMENTA Y GANA

Tu opinión nos ayudará a dar forma al desarrollo de esta serie de productos en el futuro.

Visita:

反馈有奖

您的反馈将有助于我们在今后改进本系列产品。

请访问：

[LEGO.com/productfeedback](https://www.lego.com/productfeedback)

By completing, you will automatically enter a drawing to win a LEGO® set.

Terms & Conditions apply.

Durch Ausfüllen nimmst du automatisch an der Verlosung eines LEGO® Preises teil.

Es gelten die Teilnahmebedingungen.

En envoyant vos commentaires, vous serez automatiquement inscrit(e) à un tirage au sort qui vous permettra de remporter un prix LEGO®.

Offre soumise à conditions.

Al contestar, participarás automáticamente en el sorteo y podrás ganar un set LEGO®.

Sujeto a Términos y Condiciones.

完成我们的反馈调查，即可自动进入抽奖环节，赢取乐高®套装。

适用《条款和条件》。

