

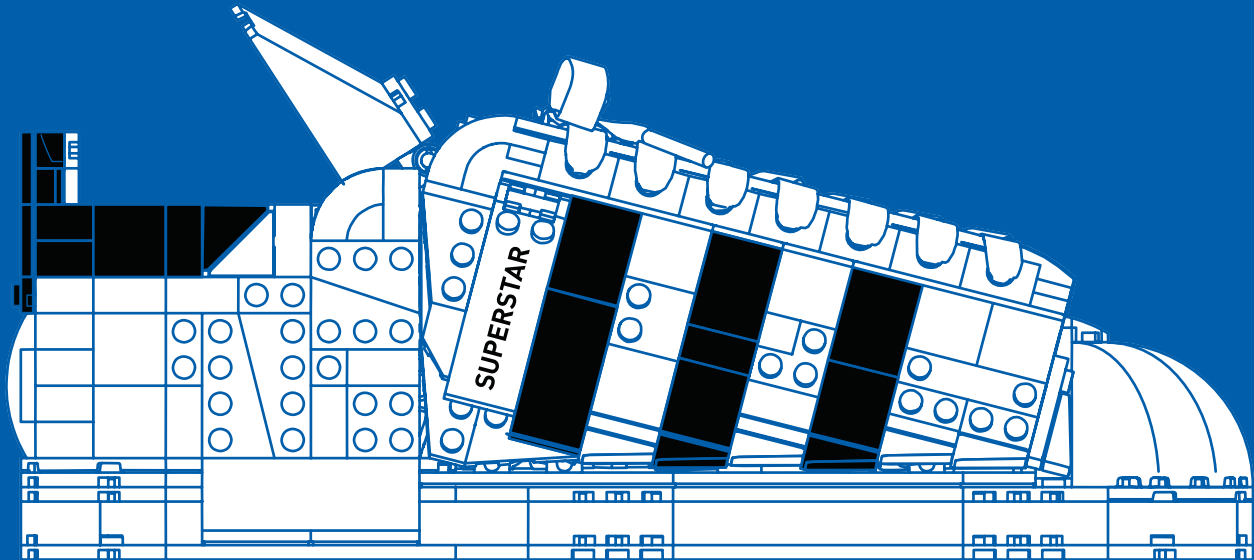

adidas
originals
superstar



Booklet available in English on
Heft in deutscher Sprache erhältlich auf
Livret disponible en français sur
Libretto disponibile in Italiano su
Folleto disponible en español en
如需中文版手册, 请访问

[LEGO.com/service/buildinginstructions](https://www.lego.com/service/buildinginstructions)

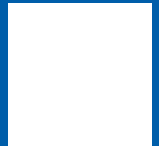



©The adidas Archive
*Credit Studio Waldeck

ORIGINAL FROM THE START

In the early 1960s, adidas embarked on a mission to expand the brand into the American market. Their US distributor suggested that basketball offered the best opportunity. For several decades, the sport had been lacking in any significant innovation in both design and technology. But Horst Dassler, son of the company founder, had a vision and a love for the game, so he began development work on a shoe that was to become the Superstar.



1970



1985



1993



2001



2015



2020

WHERE SPORT AND ARTS MERGED

The story of the adidas Superstar started on the basketball court but rapidly moved onto the streets of New York. First adopted in NBA championships in the early 70s, the adidas Superstar quickly became a counter-culture classic and the must-have streetwear staple for up-and-coming musicians and skateboarders alike. The name Superstar felt fitting, and today athletes, artists and everyday stars continue to make this iconic shoe their own. With over 50 years on the street, the iconic silhouette has been re-imagined time and time again and continues to be at the forefront of modern sneaker culture.

GREAT PLAYERS INSIST ON GREAT SHOES

Foam-padded tongue.
Relieves pressure of the laces.

Shelltoe cap
withstands
heavy abuse.

SUPERSTAR

Special high
SOFTPROTECT heel
design.

One-piece sole is
bonded and stitched
to uppers.

World-famous 3
stripes mark now
in real leather.

Deep profile
ribbing gives
excellent
traction.





It's official!

adidas "Americans" –
the official shoe of the
American Basketball Association



adidas basketball shoes – No.1 in lightness,
comfort and performance.

Superstar – an amazingly light leather
basketball shoe worn by the best pro and college players.
Promodel – a shoe for players who prefer high tops.
Tournament – extra comfortable, velour leather in
dazzling team colors – blue, red, gold and black.



FROM THE DESIGN TEAM...

With a deep passion for both LEGO® building and adidas Superstar footwear, Senior LEGO Designer, Florian Müller, was the perfect person to create the LEGO version of this famous shoe.

“My task was to reproduce as many of the iconic details of the sneaker as possible, while ensuring the overall build experience was still fun and fulfilling.” Given the Superstar’s hoop-to-hip-hop cross-over, Florian also ensured you can display your finished shoe with or without its lace!



[LEGO.com/brickseparator](https://www.lego.com/brickseparator)

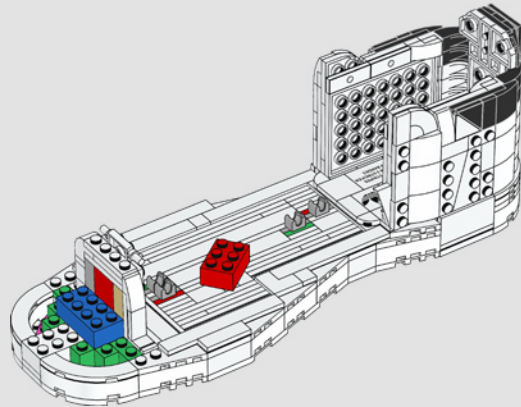
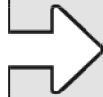
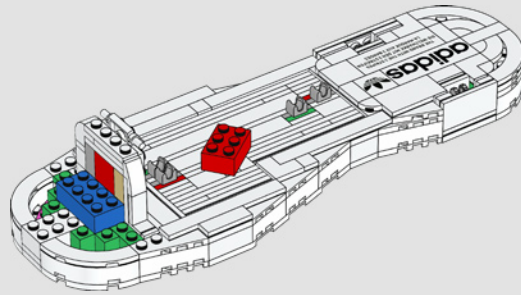
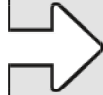
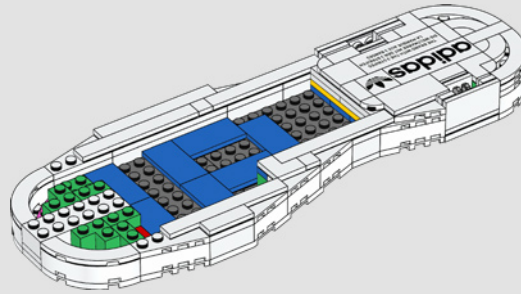
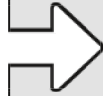

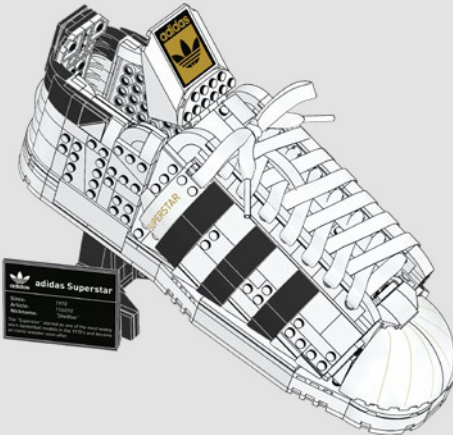
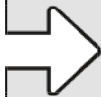
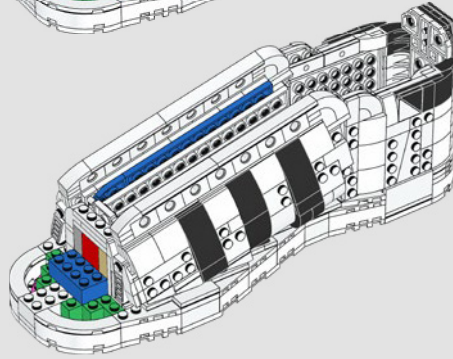
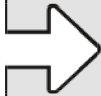
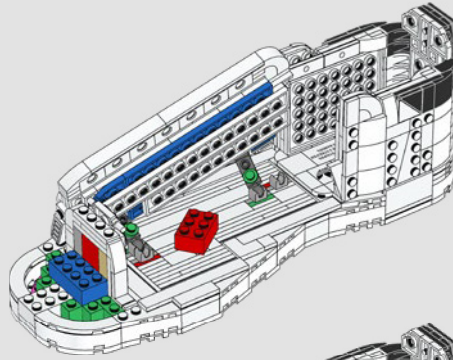
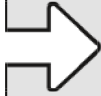

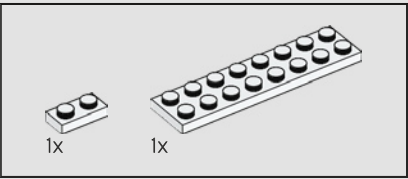
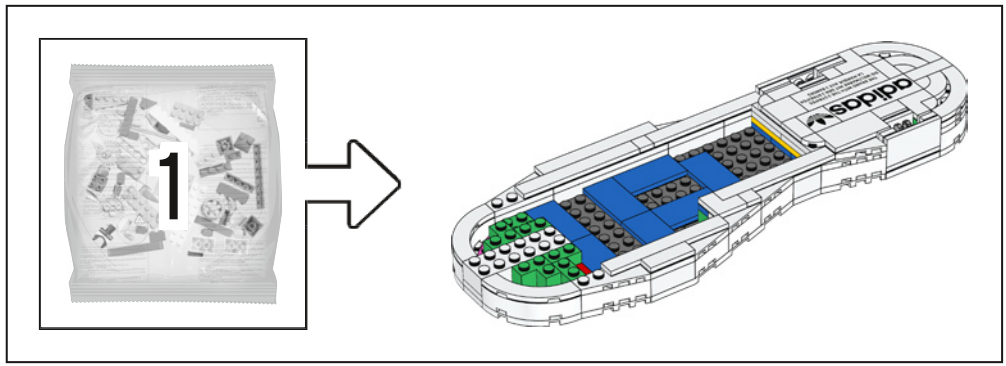

1

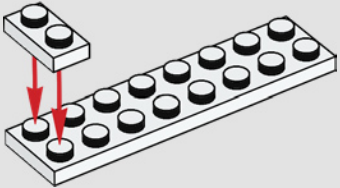

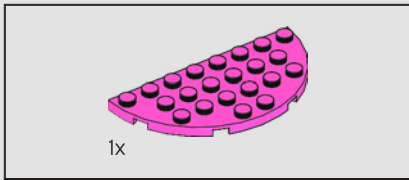

2

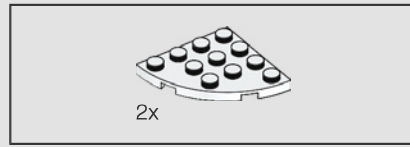
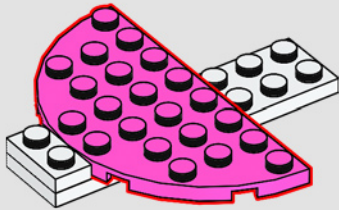

3

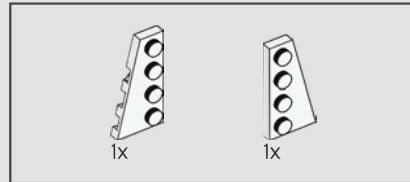
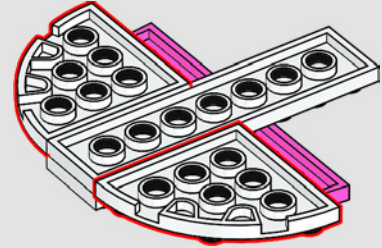

4

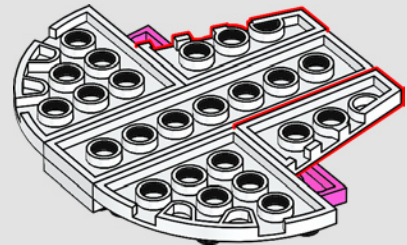

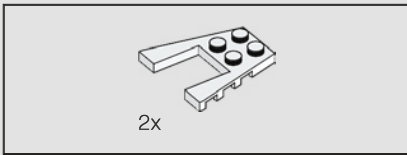

5

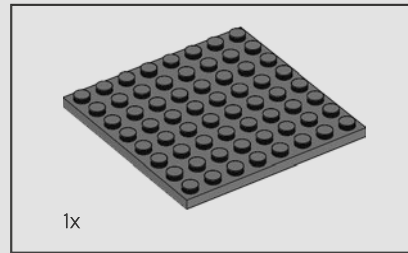
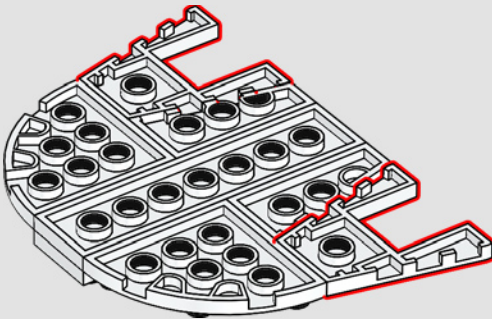

6

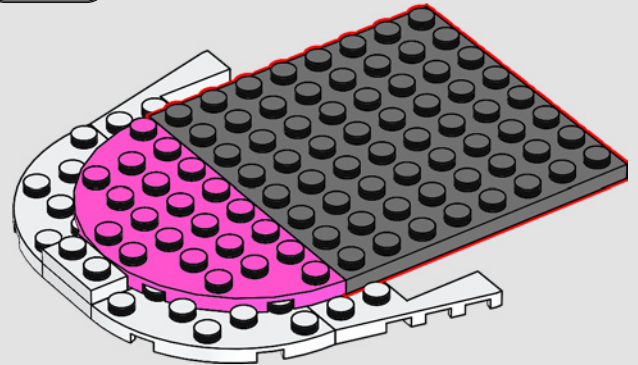

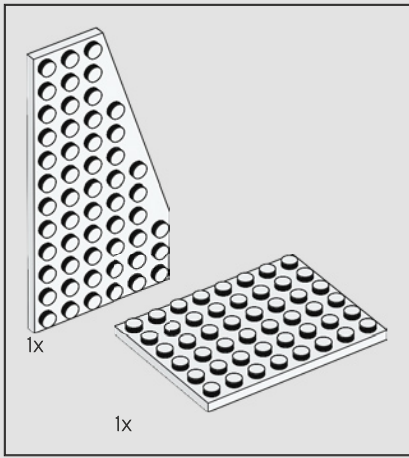

7

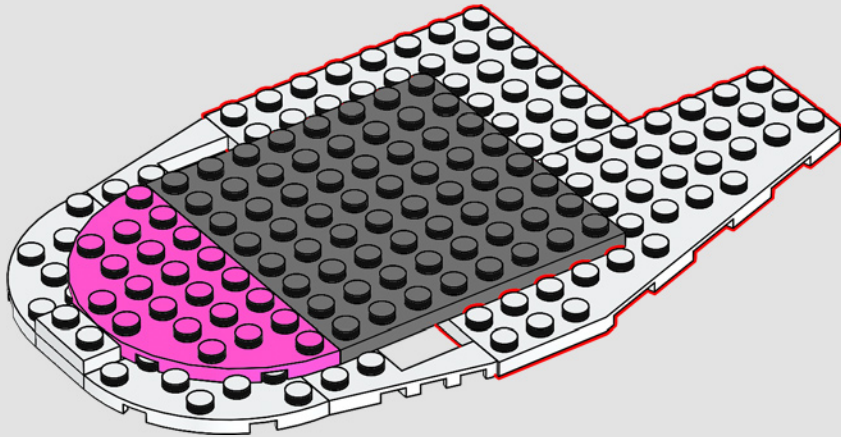

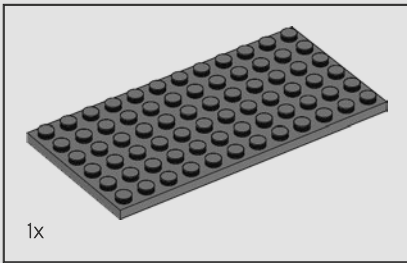

8

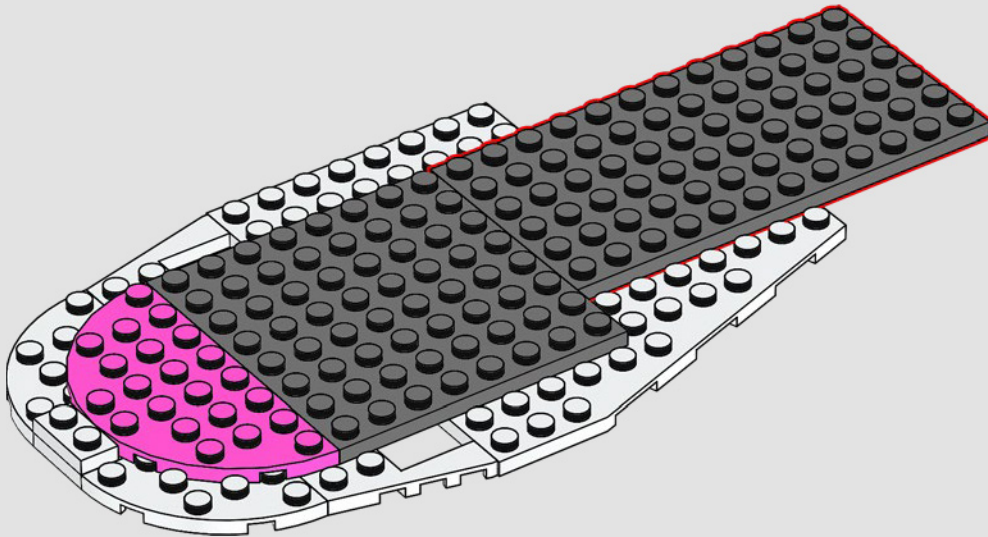

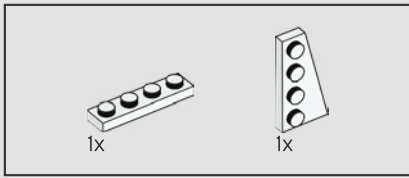

9

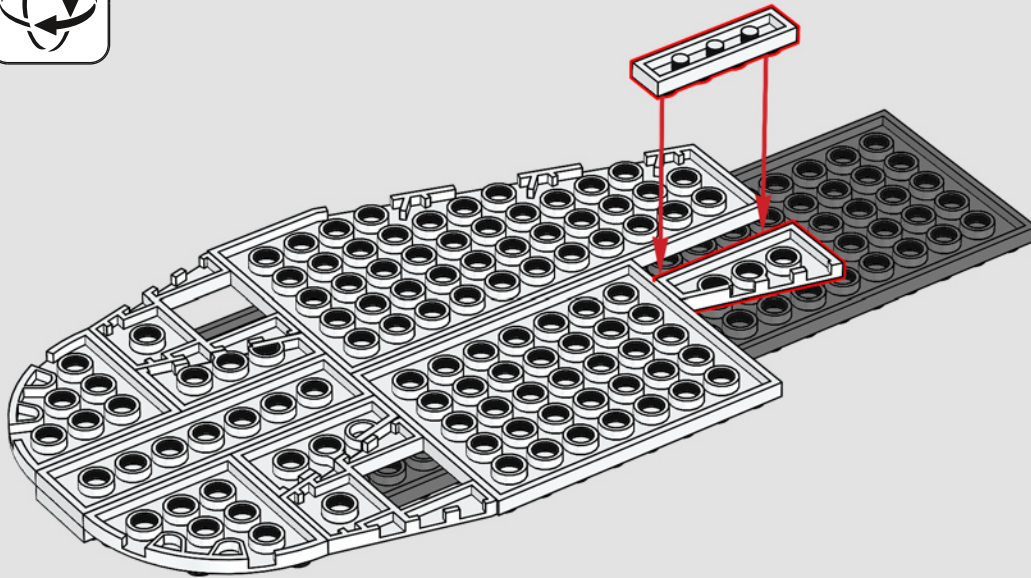

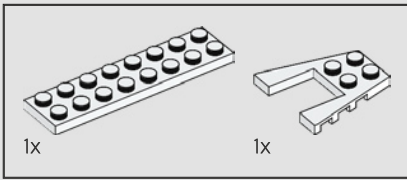

10

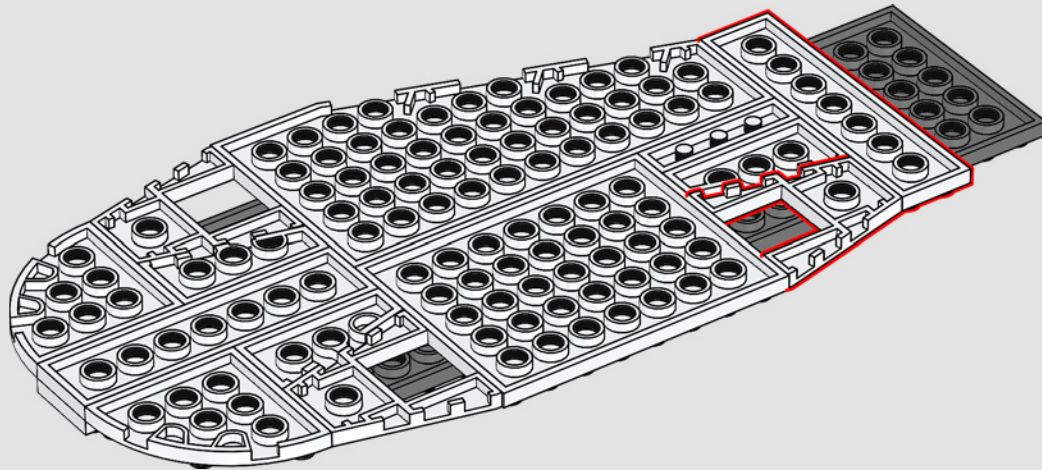

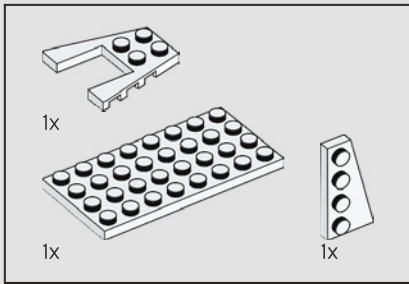

11

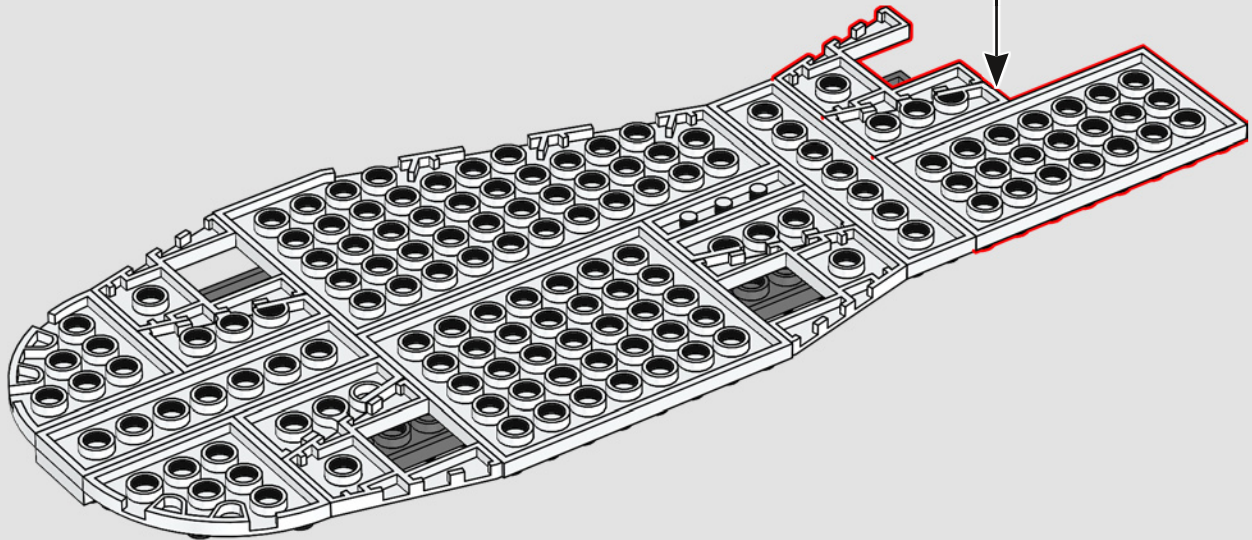
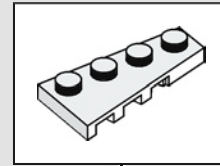

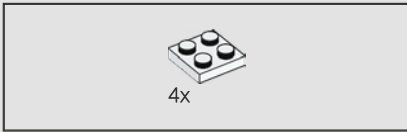

12

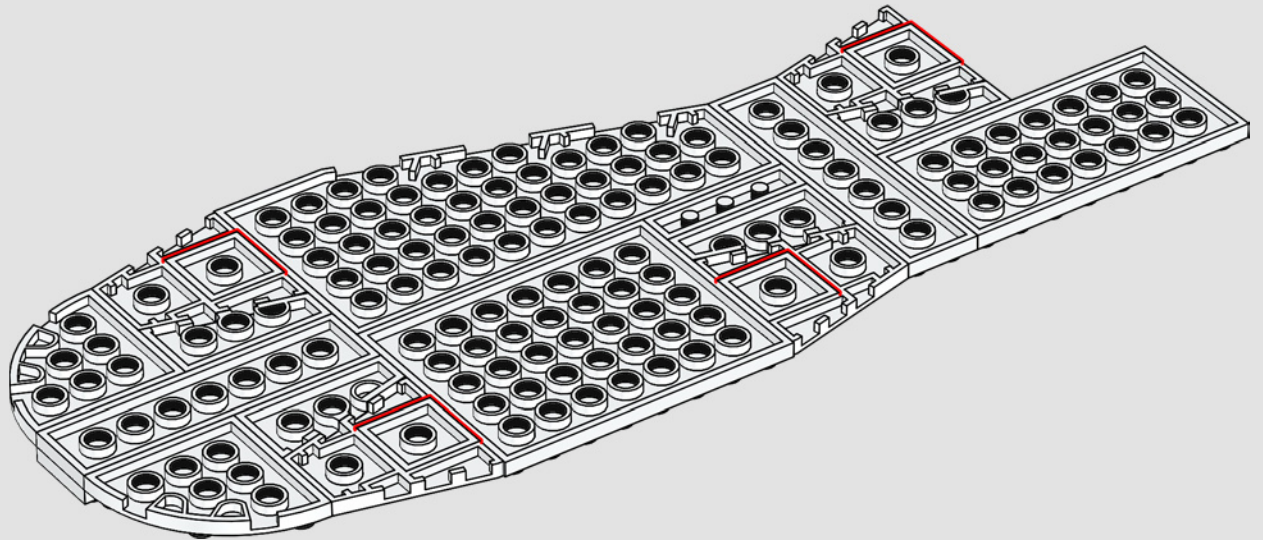

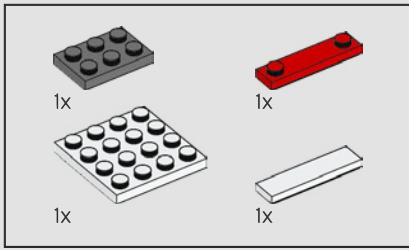

13

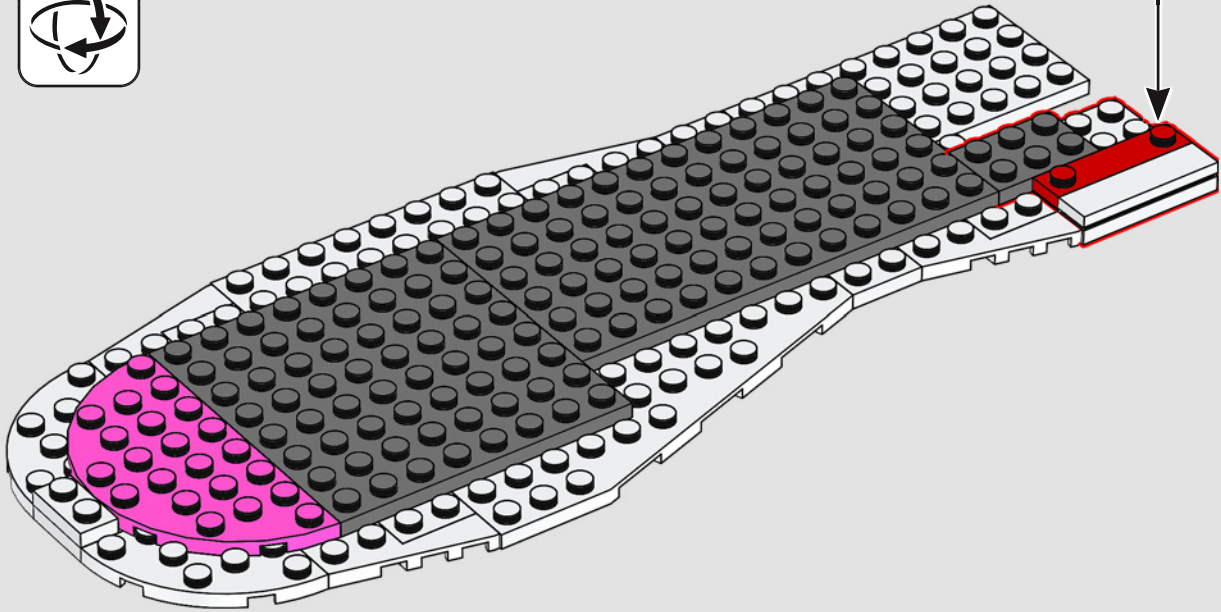
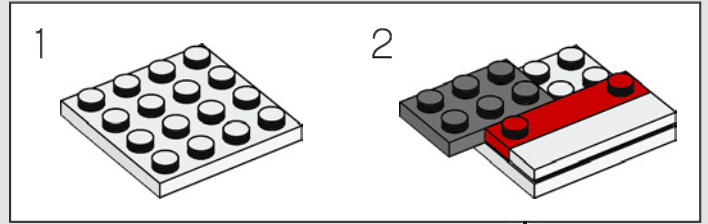

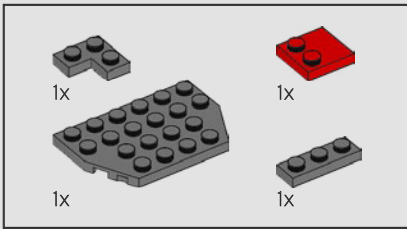

14

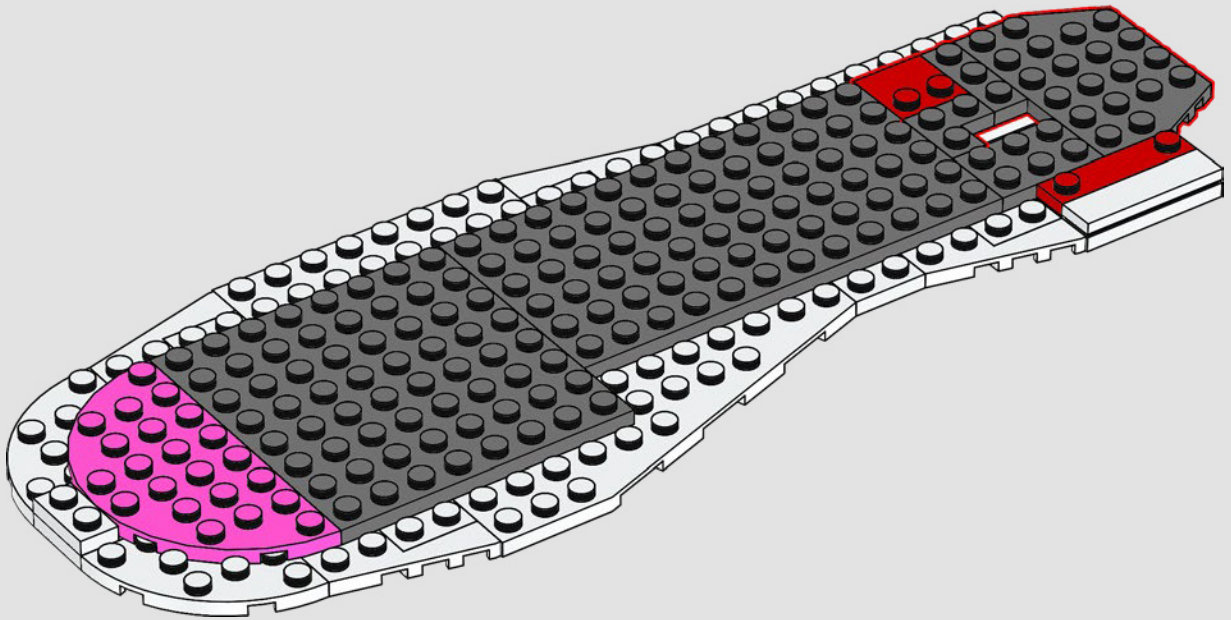

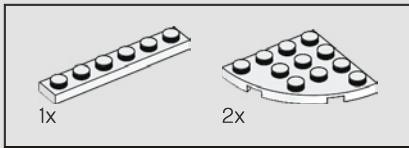

15

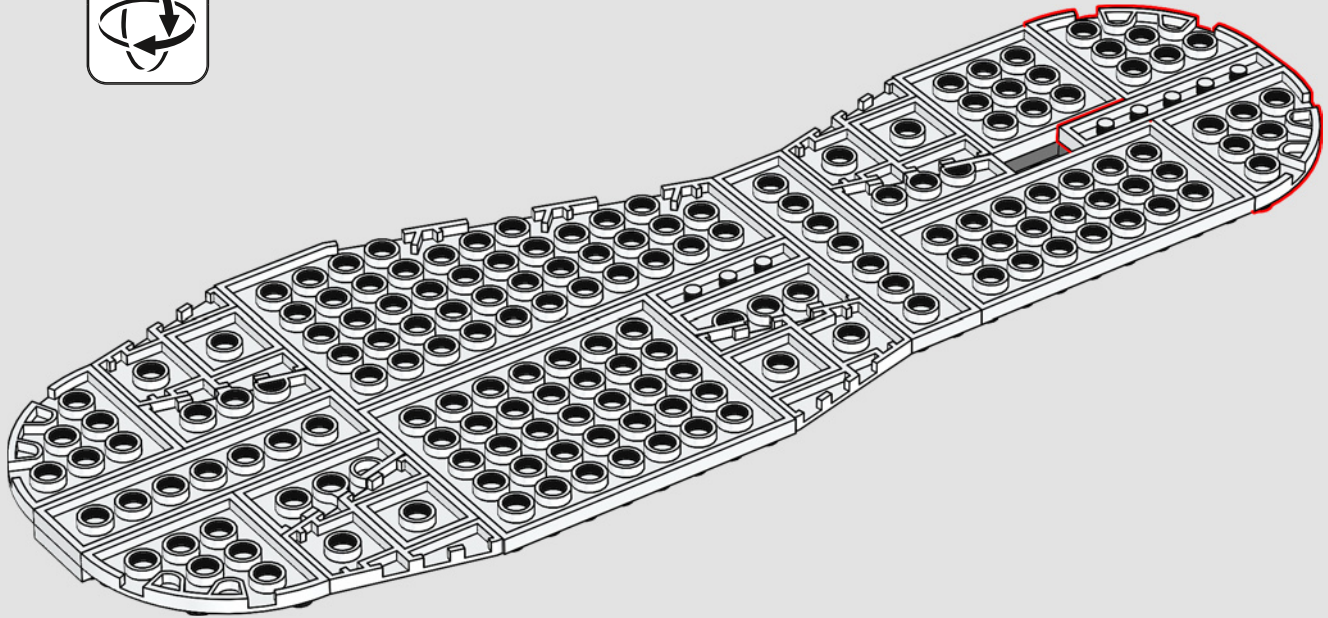

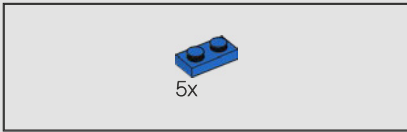

16

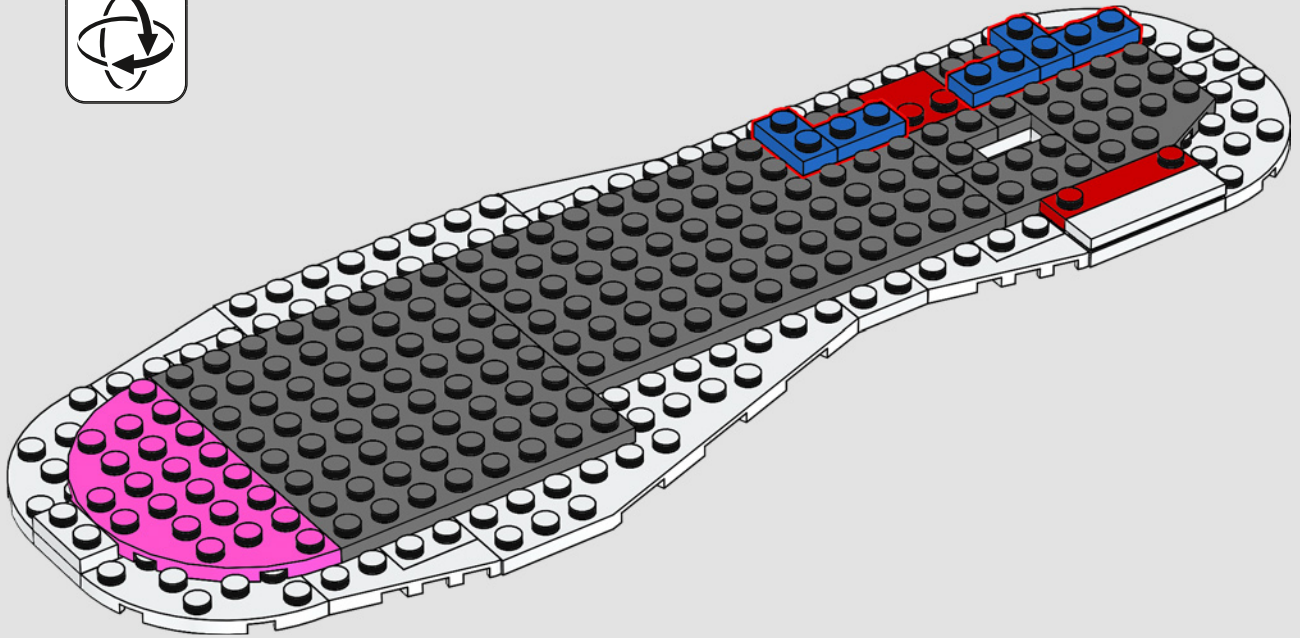

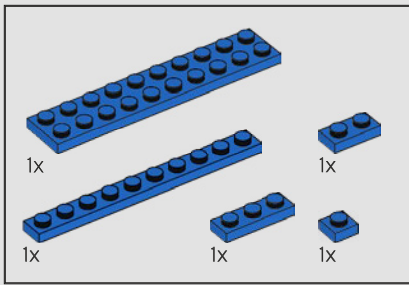

17

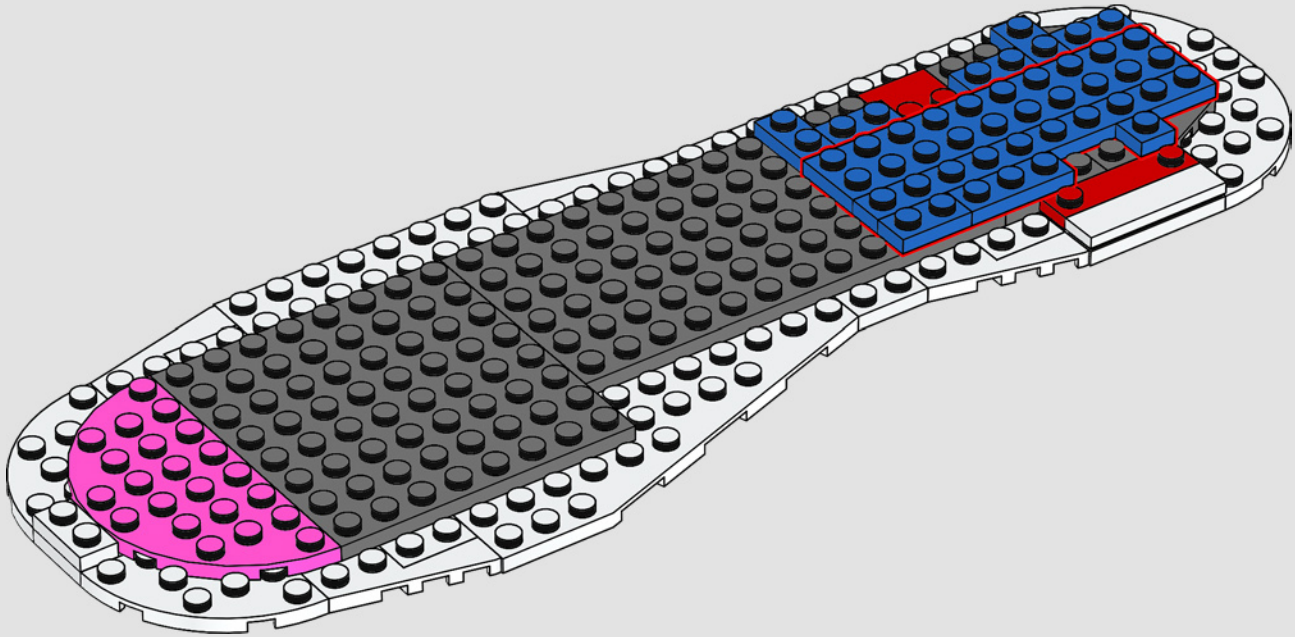

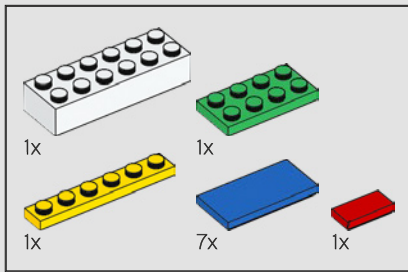

18

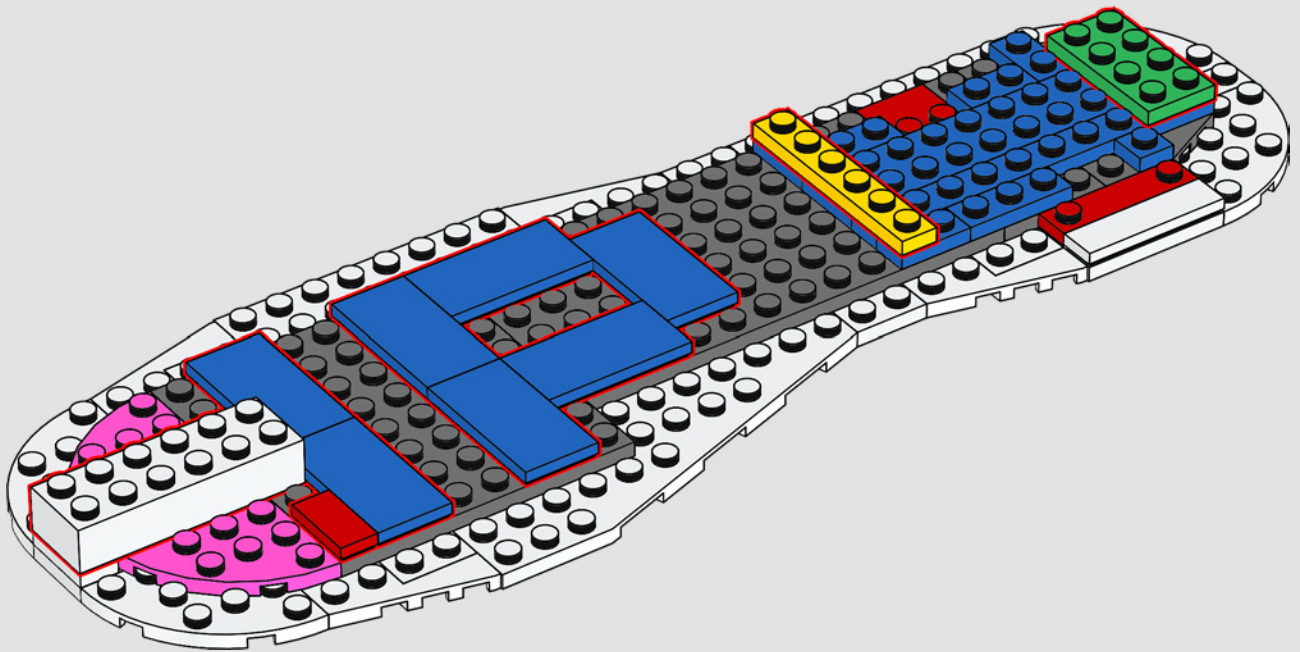

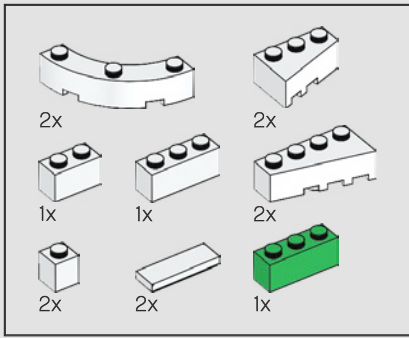

19

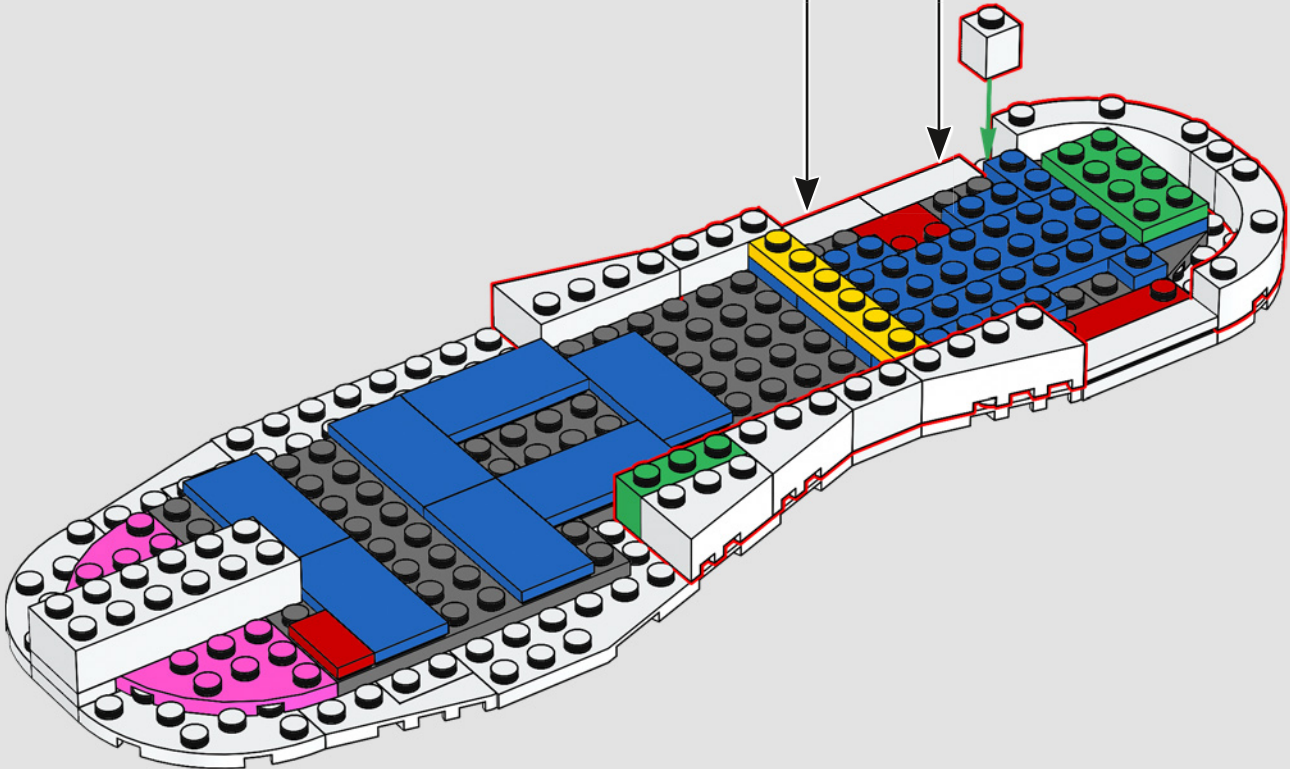
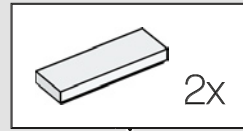

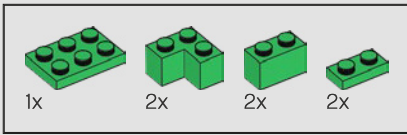

20

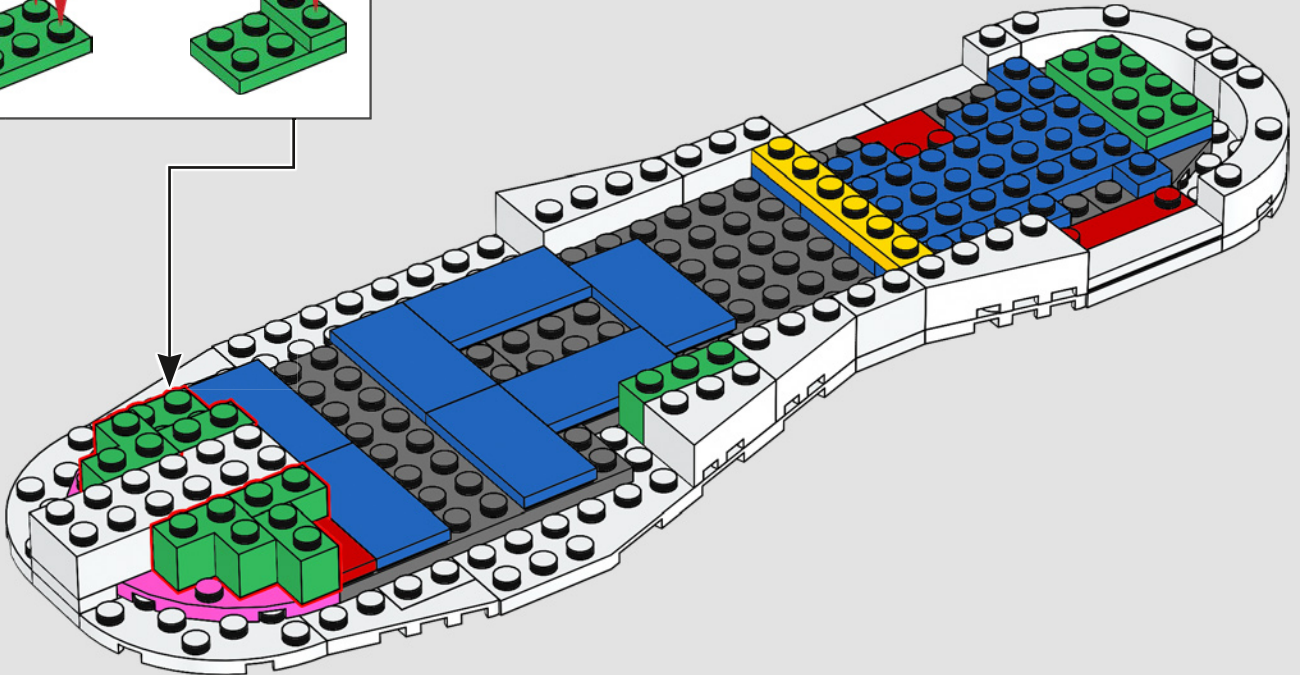
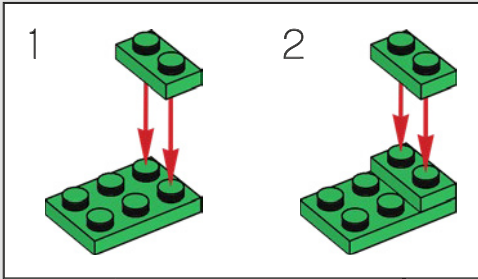

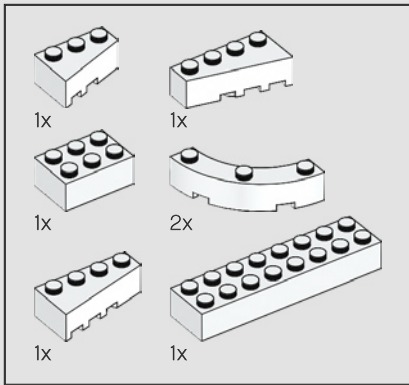

21

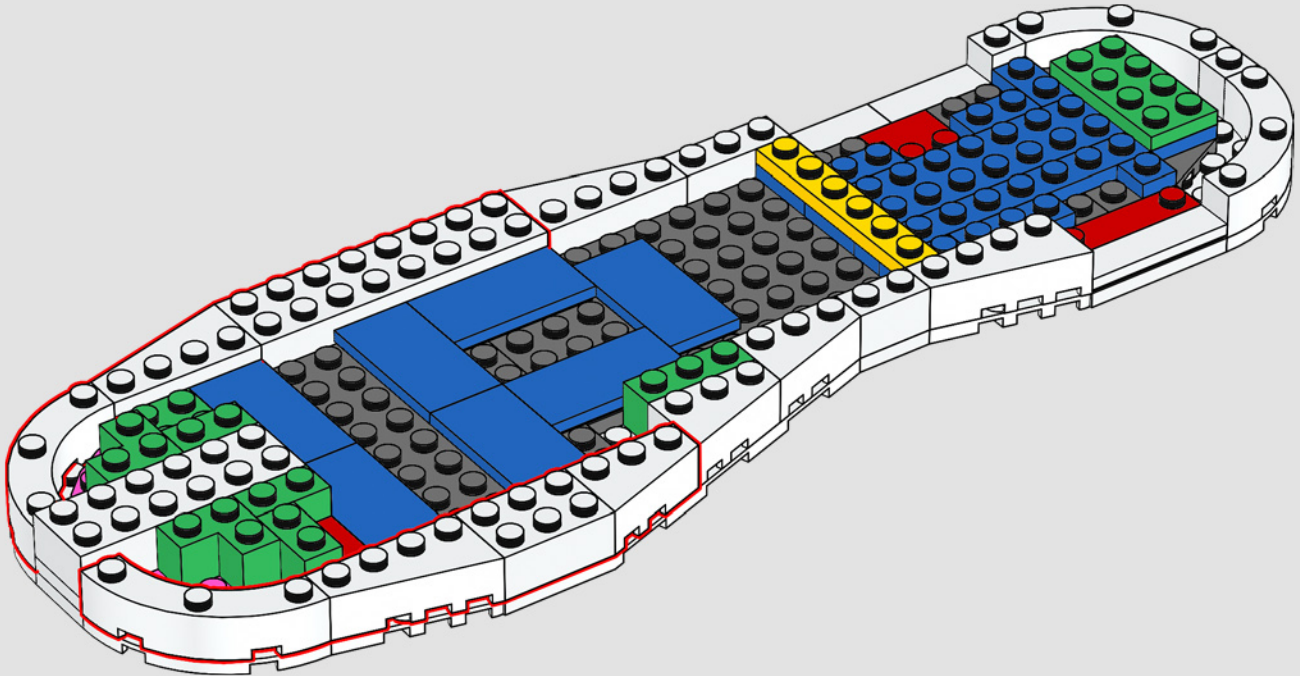

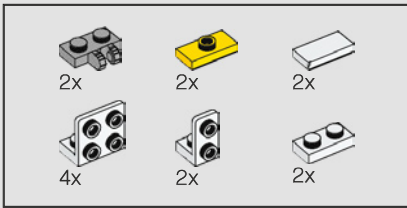

22

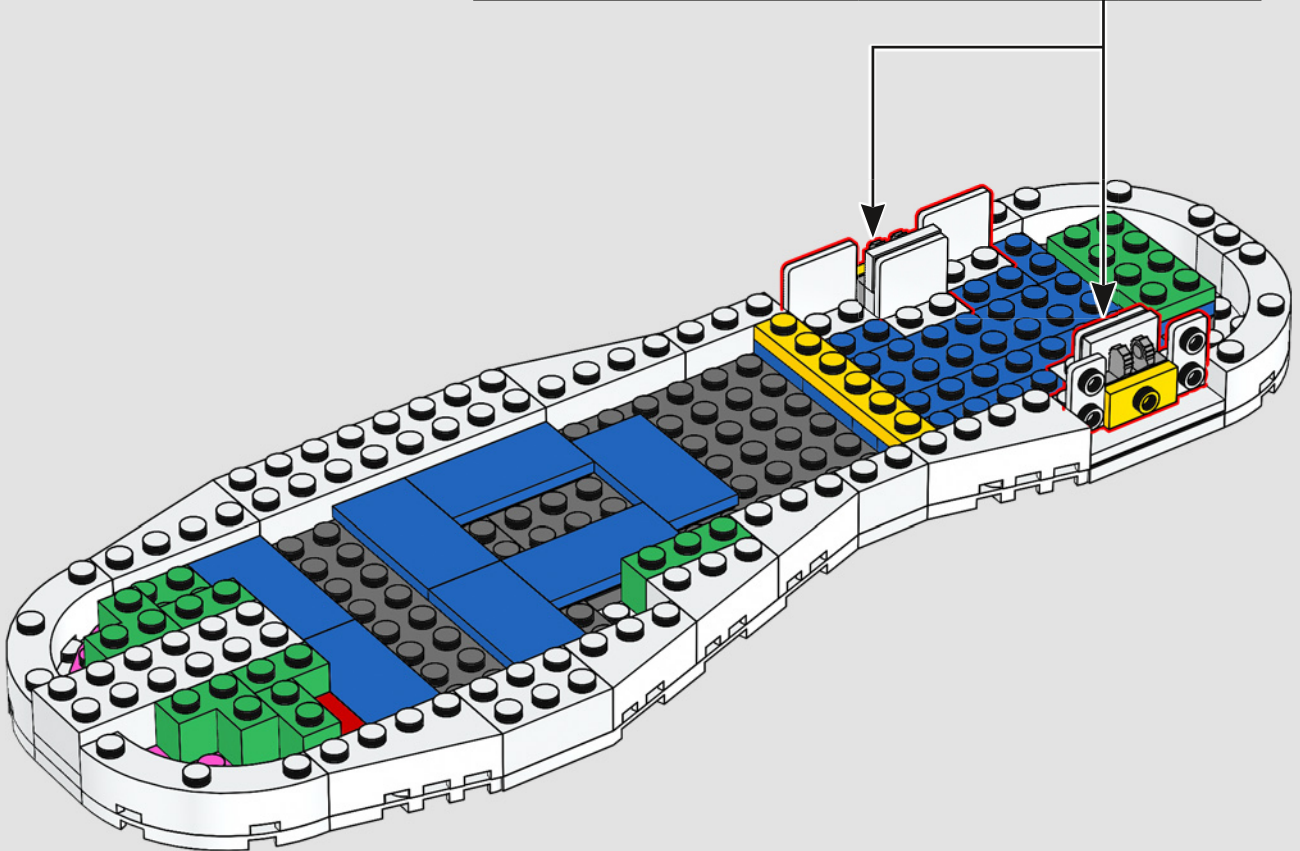
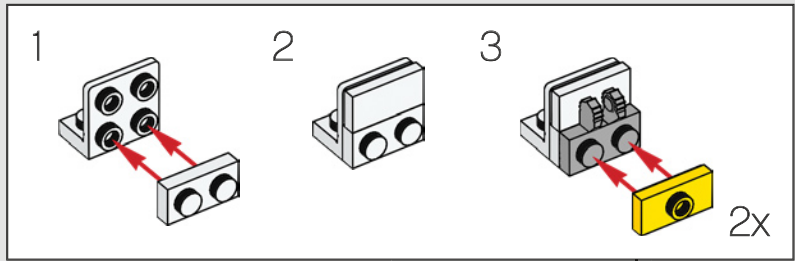

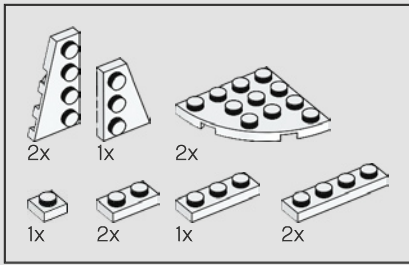

23

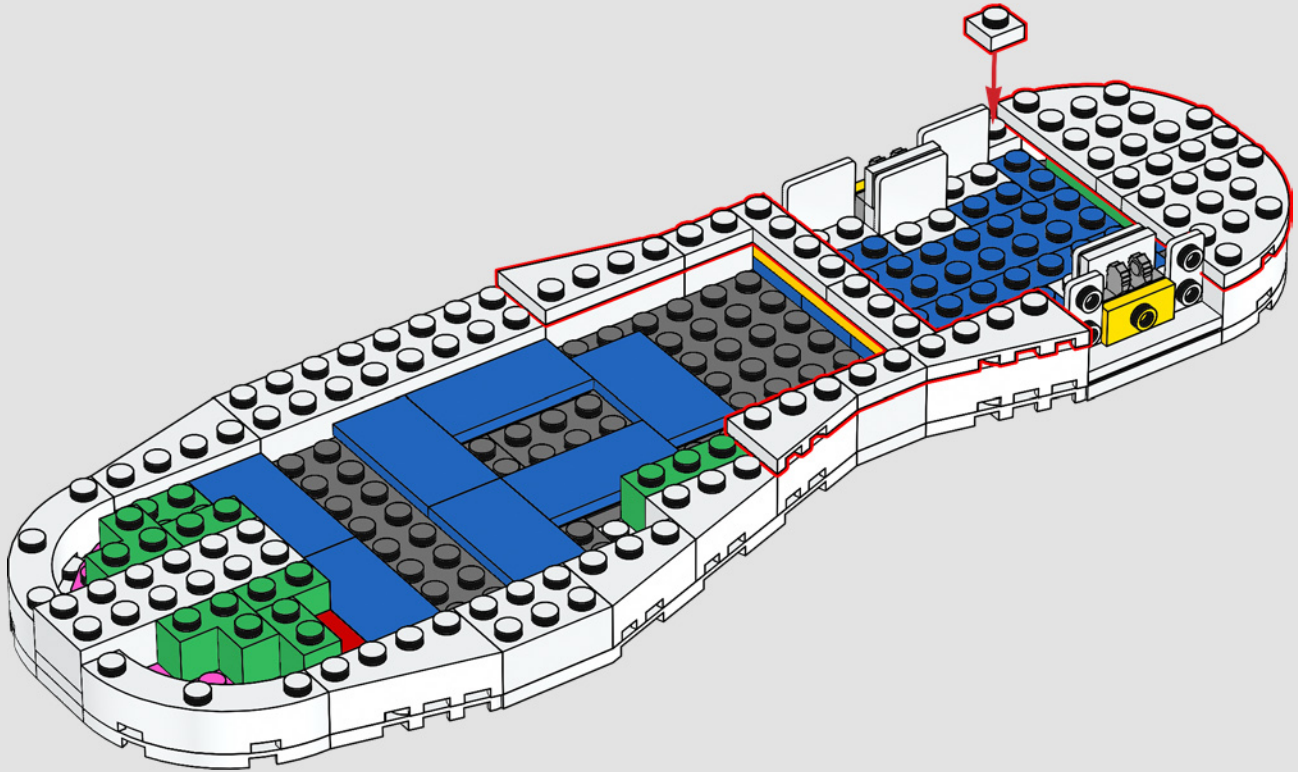

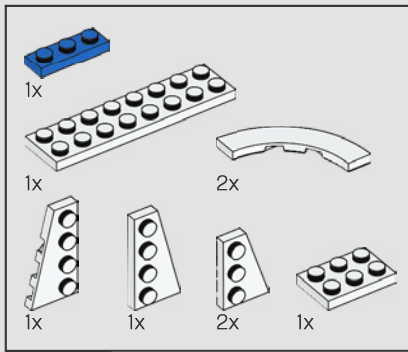

24

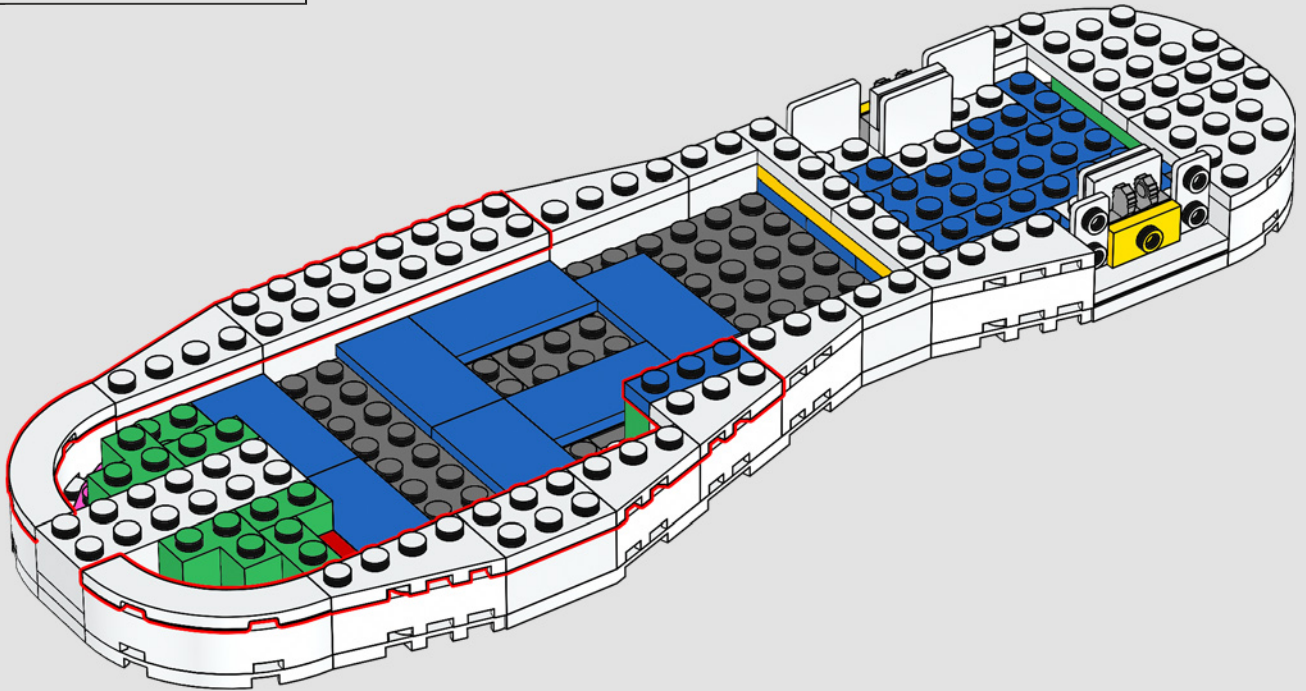

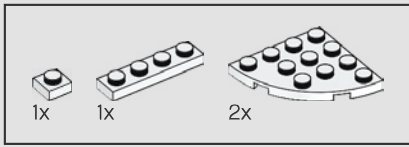

25

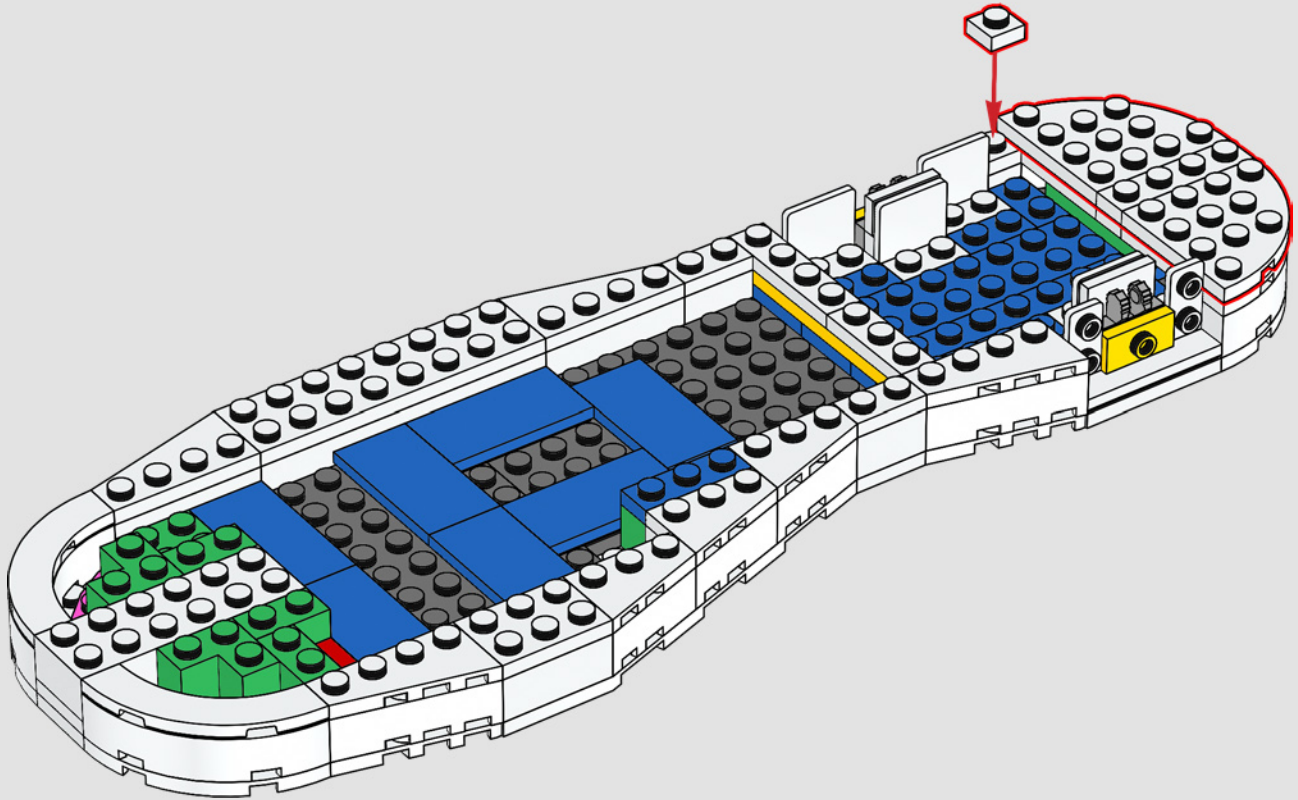

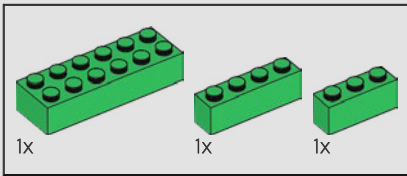

26

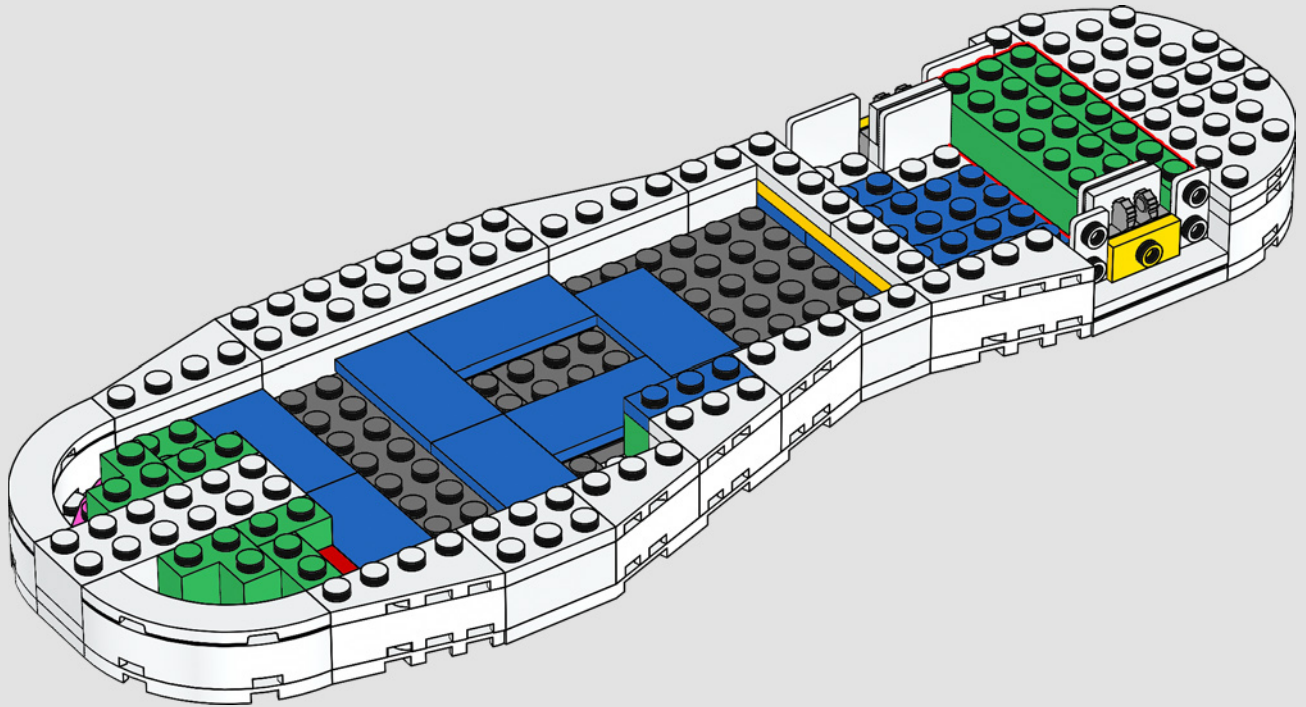

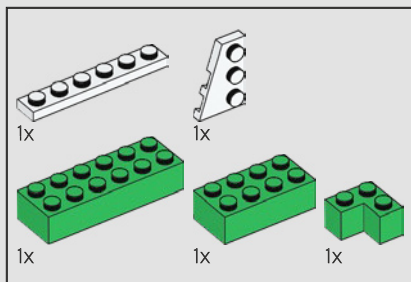

27

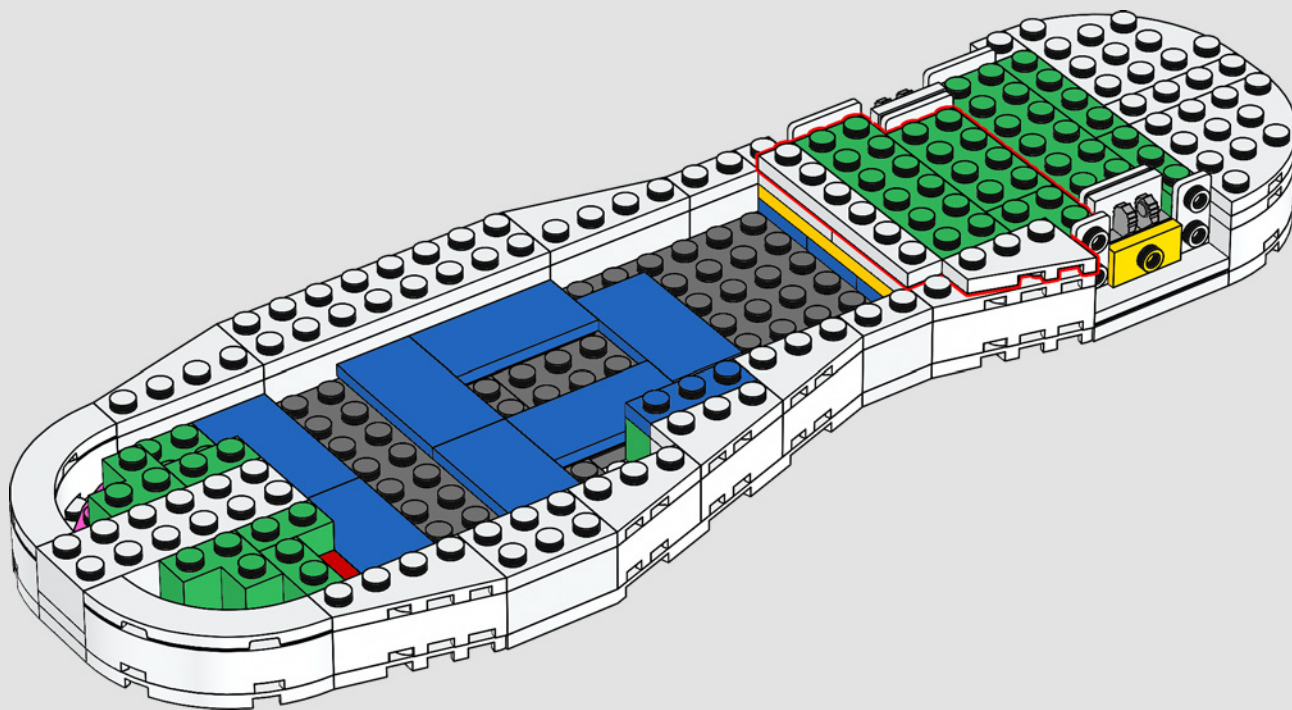

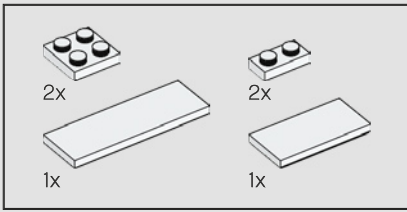

28

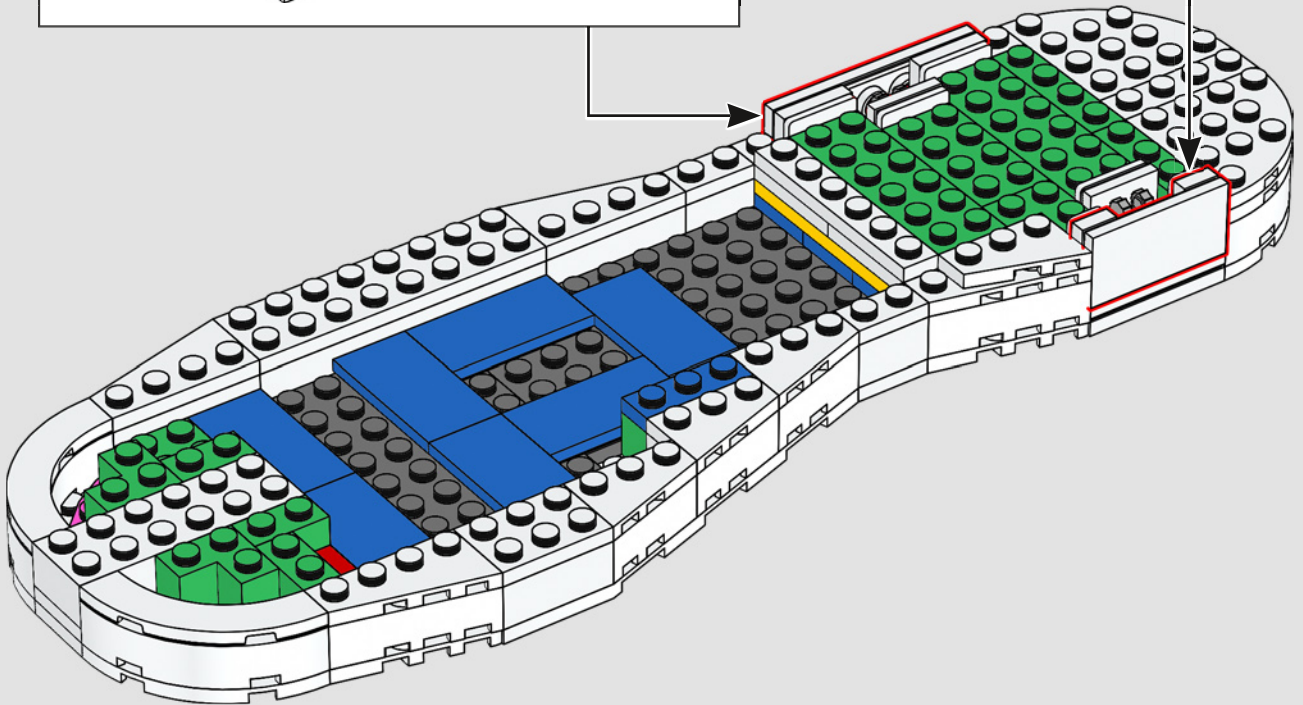
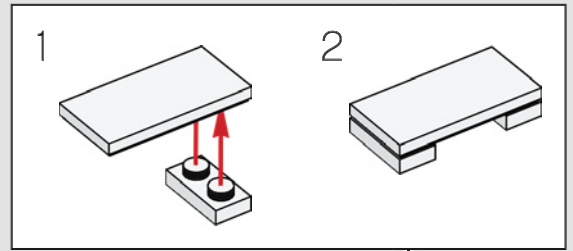
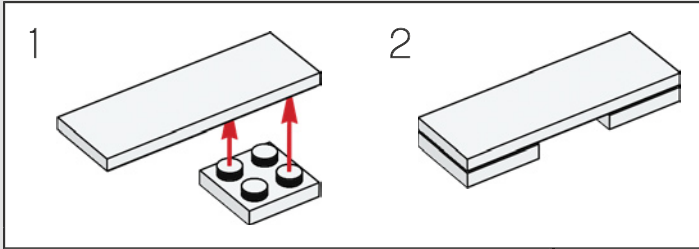

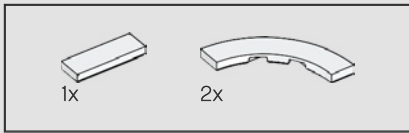

29

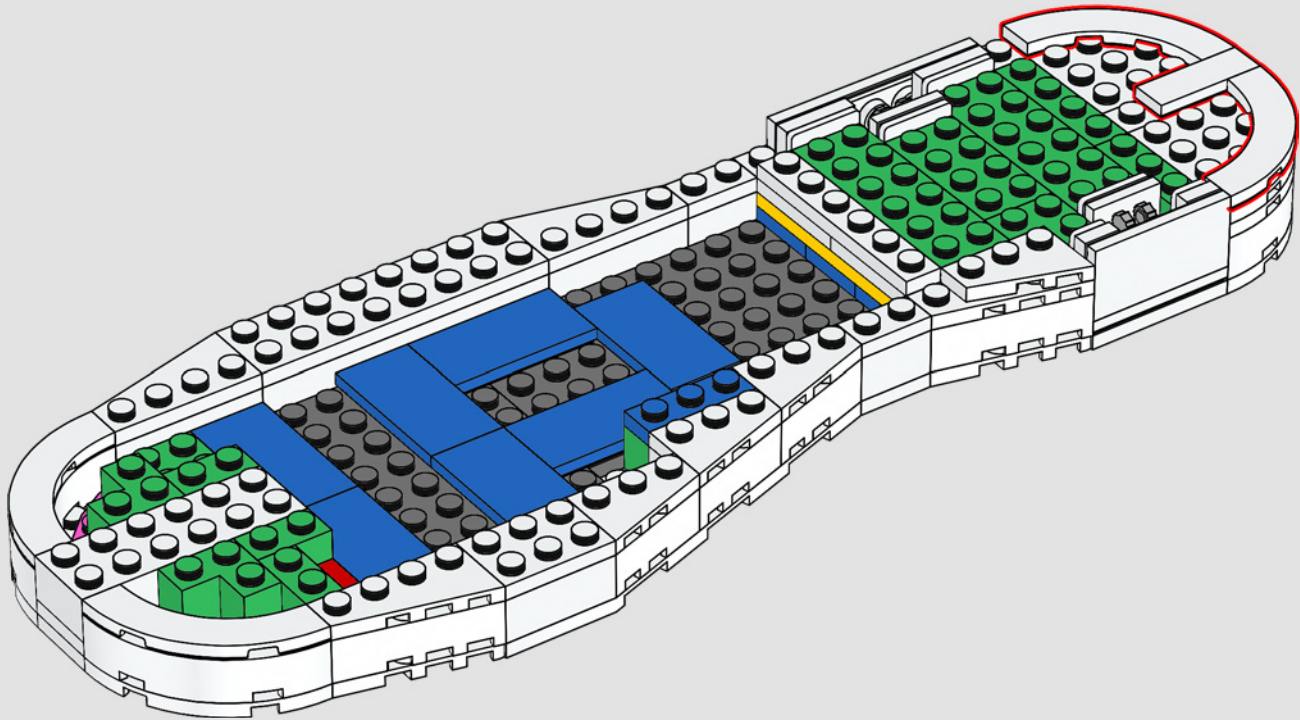

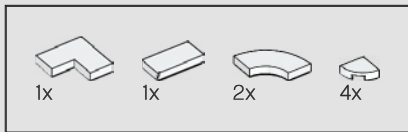

30

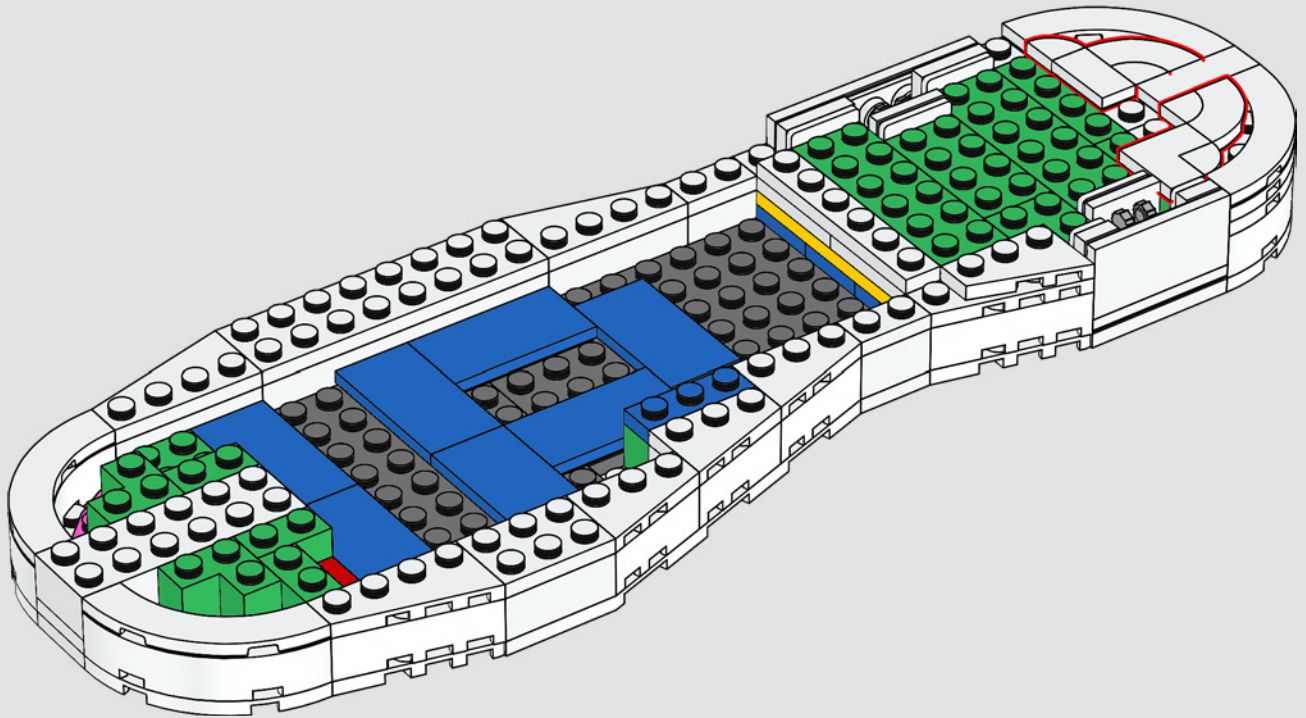

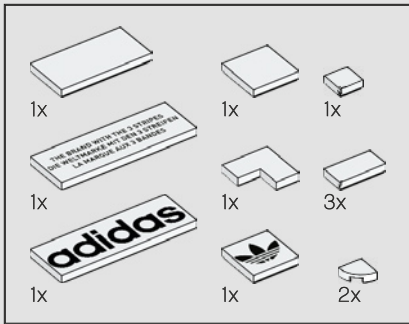

31

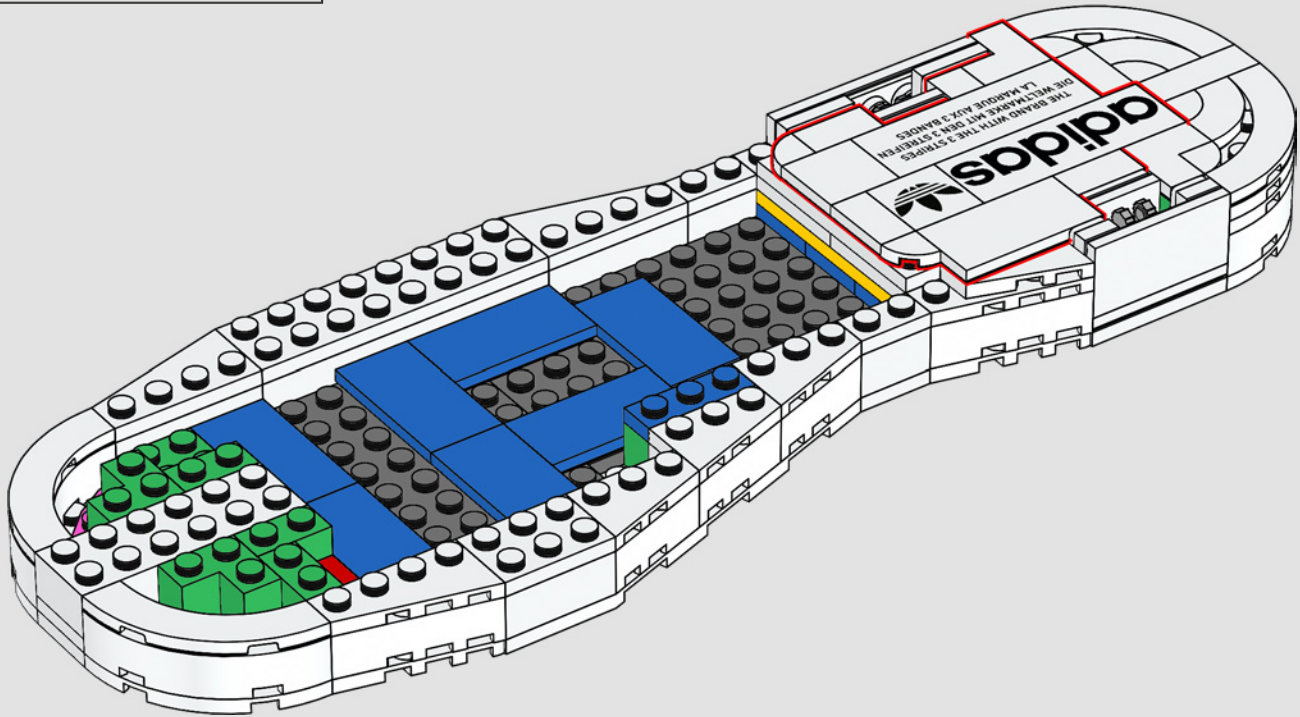

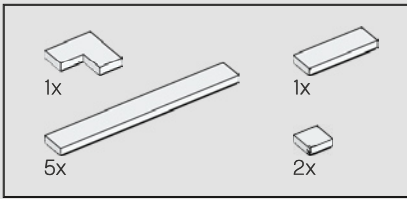

32

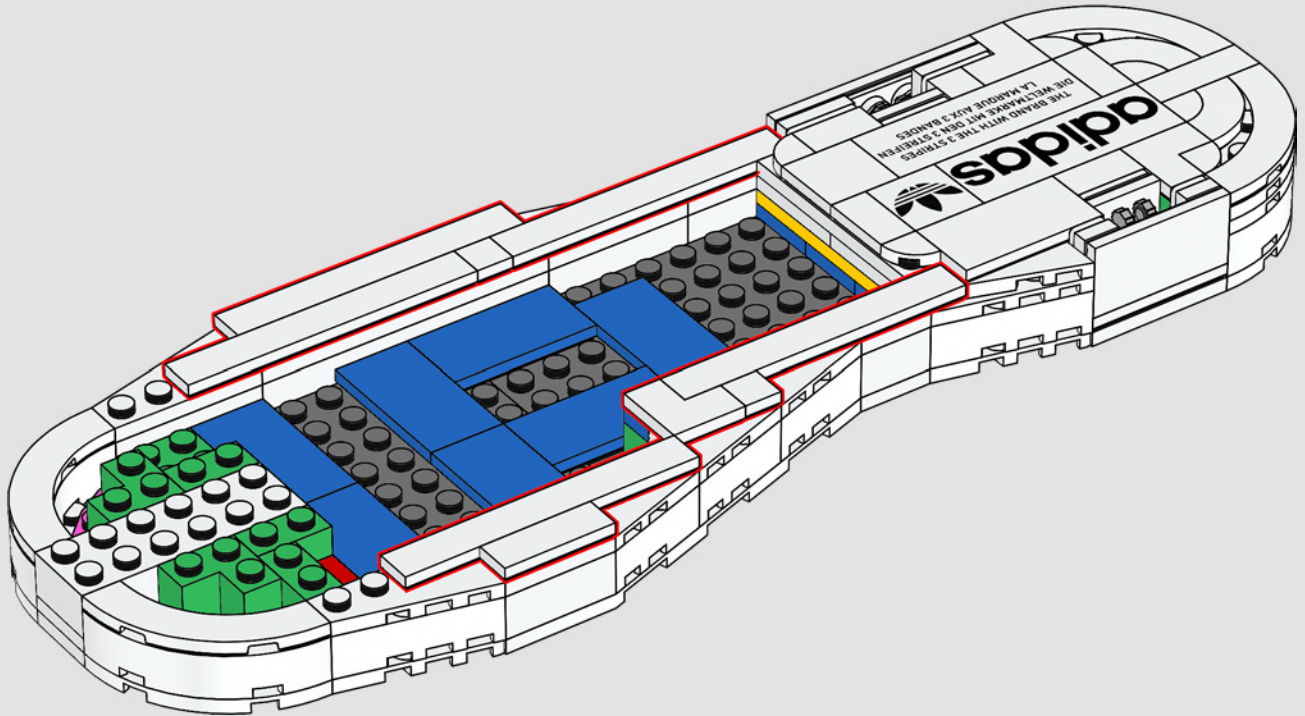

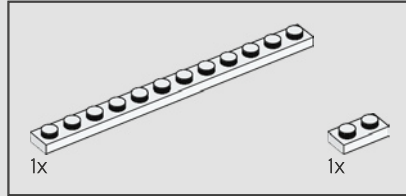
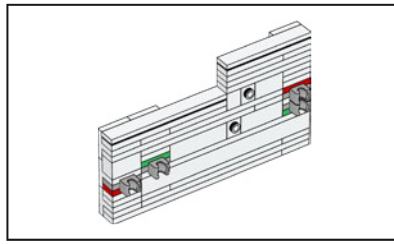
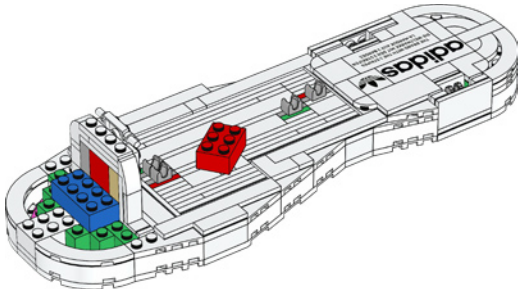
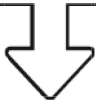

33

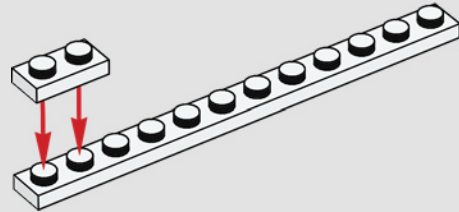

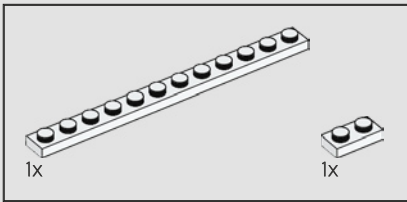

34

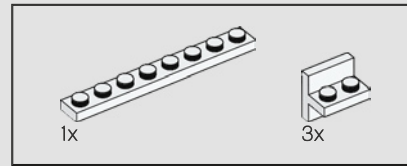
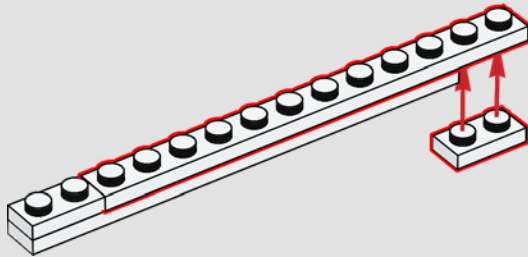

35

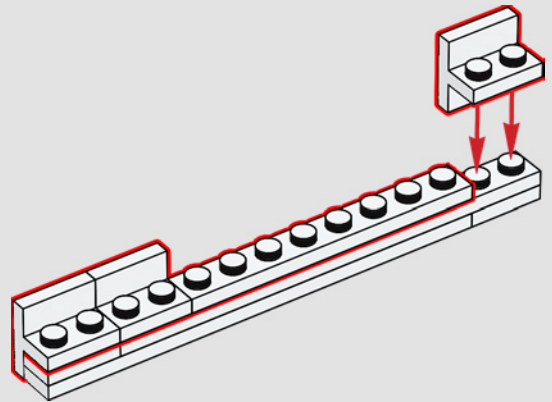

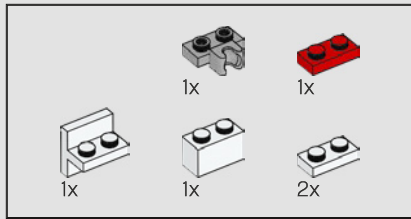

36

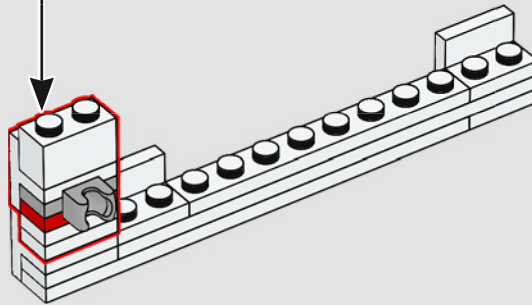
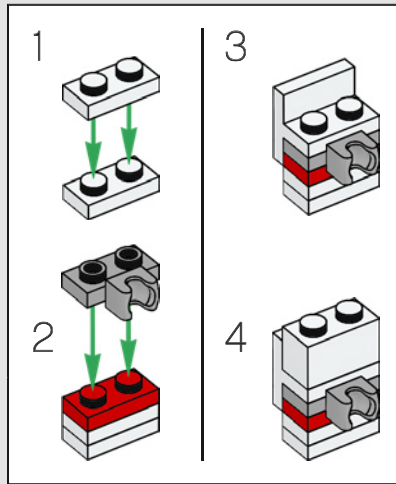

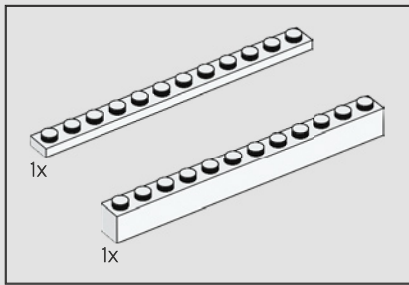

37

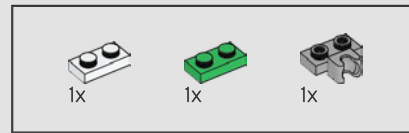
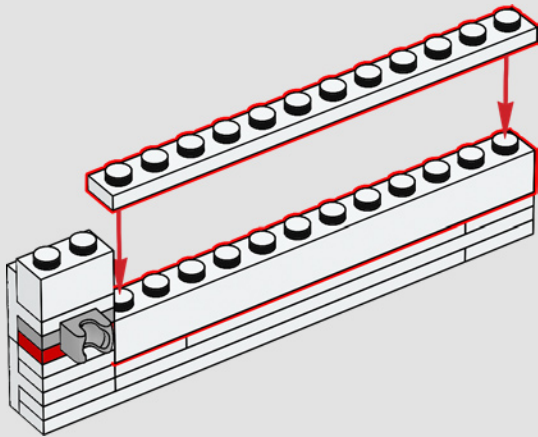

38

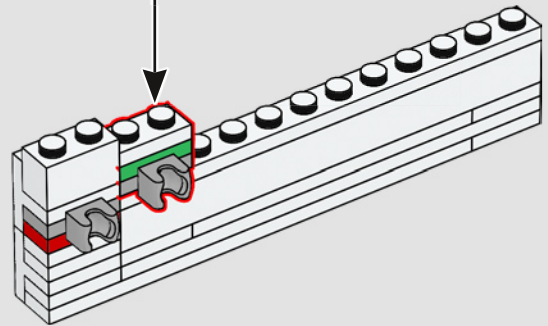
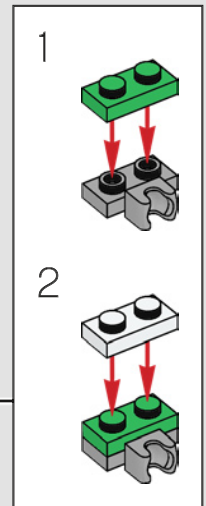

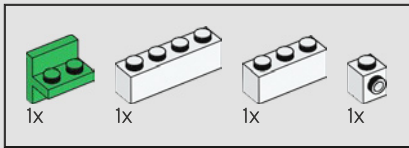

39

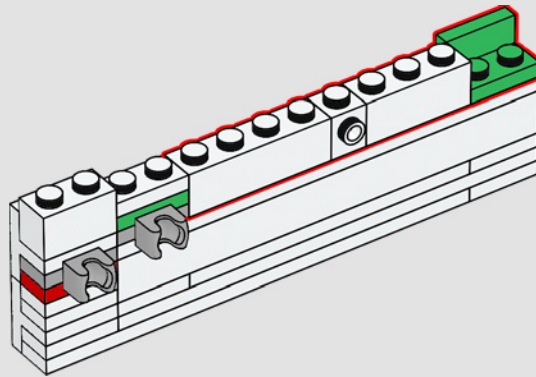

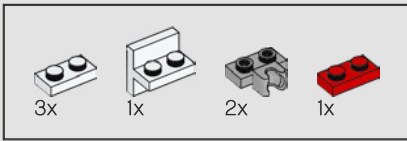

40

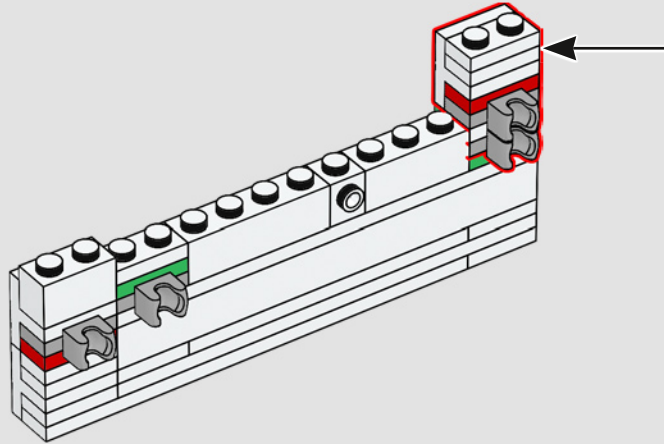
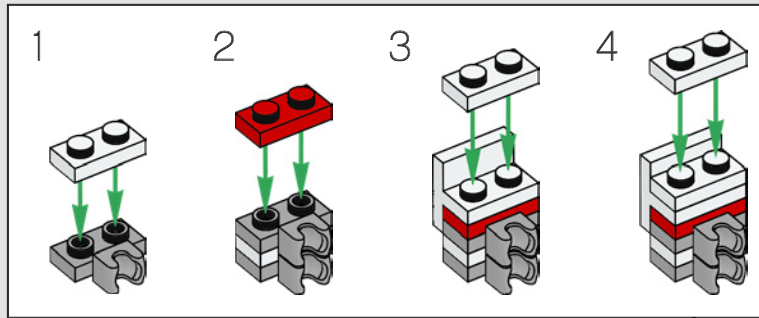

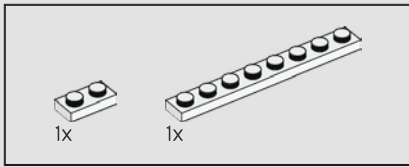

41

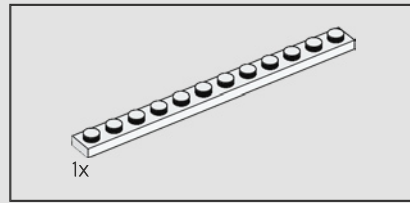
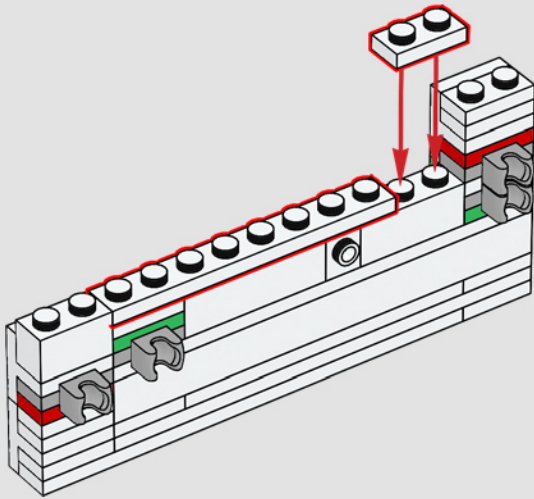

42

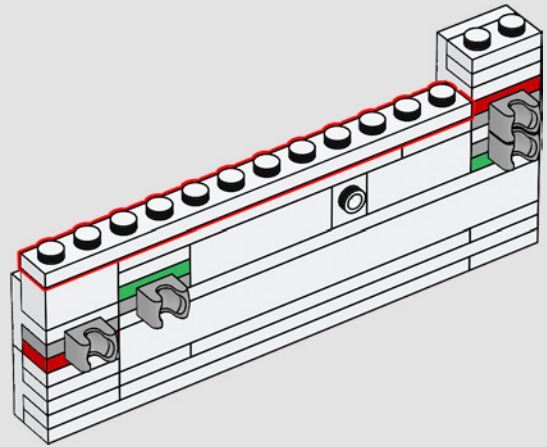

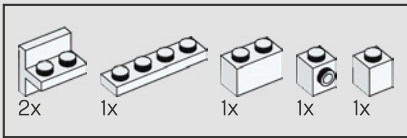

43

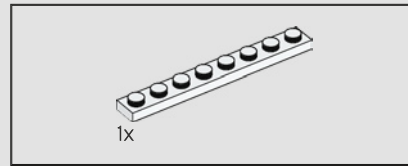
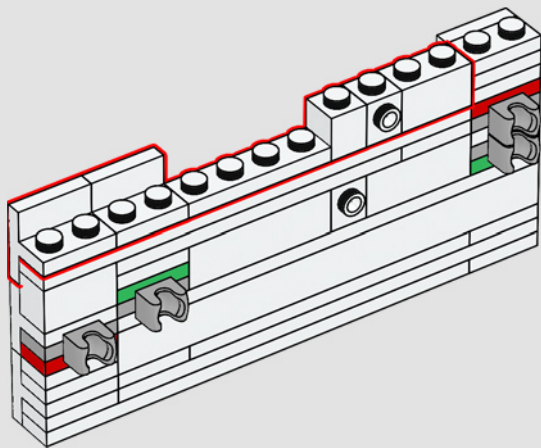

44

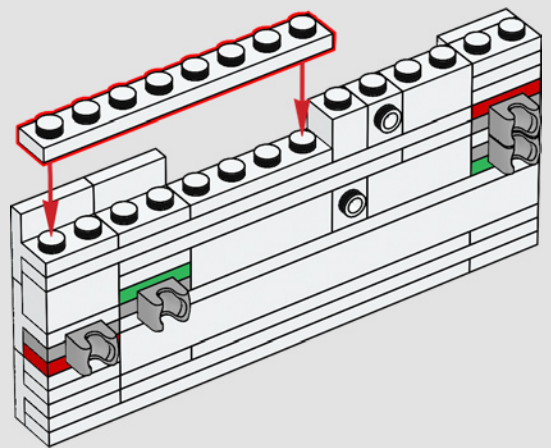

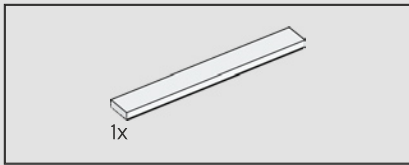

45

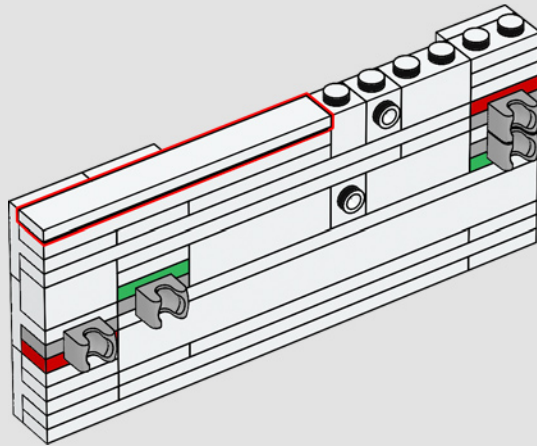

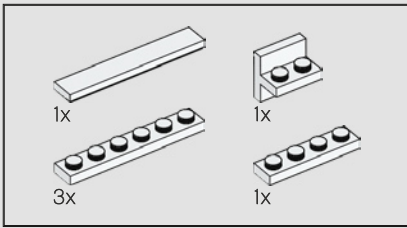

46

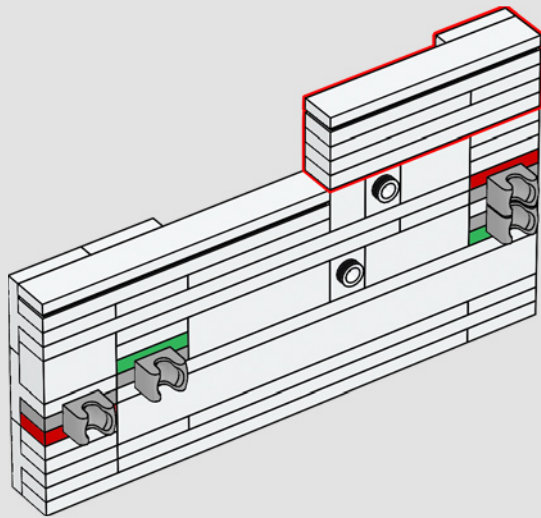
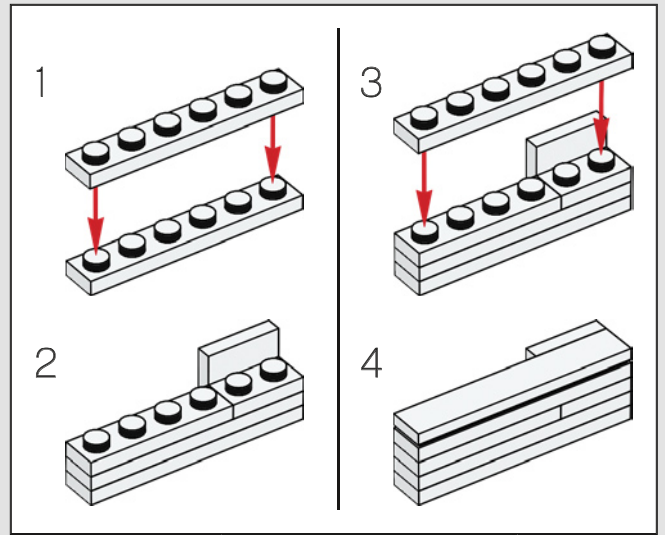

47

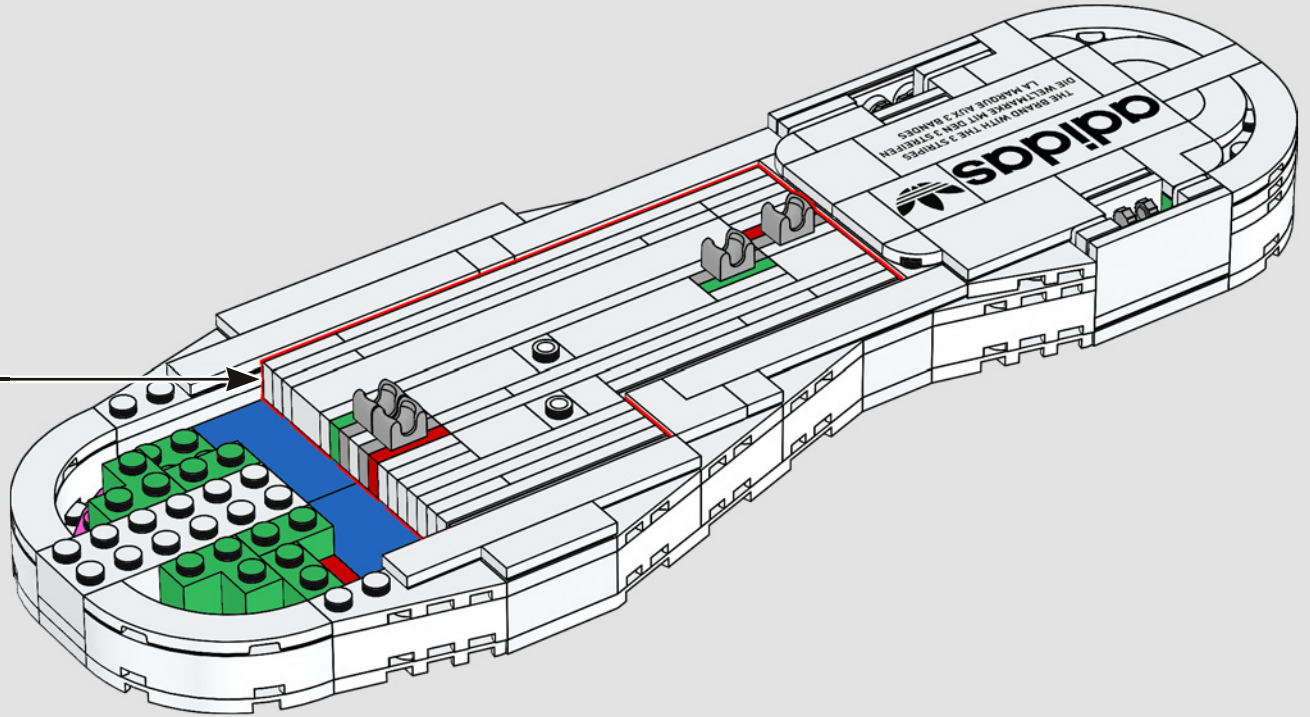

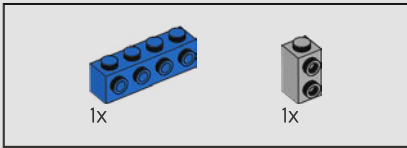
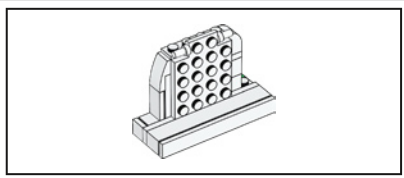

48

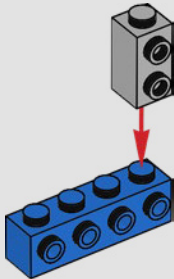

49

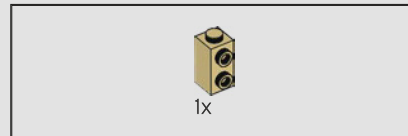
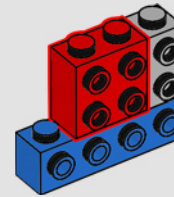

50

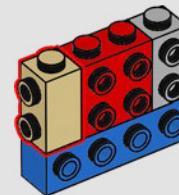

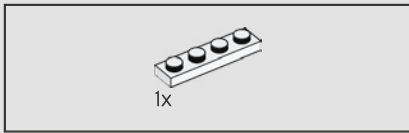

51

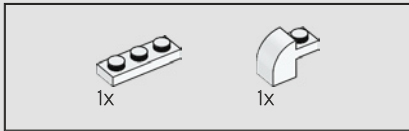
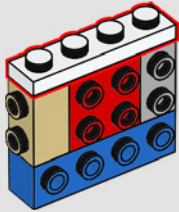

52

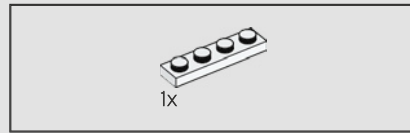
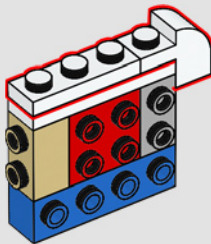

53

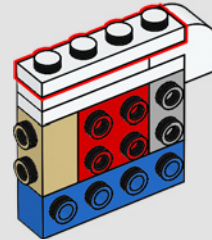

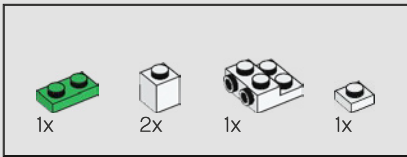

54

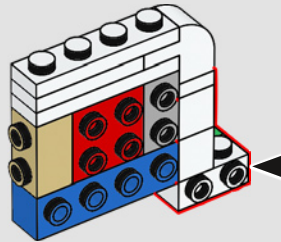
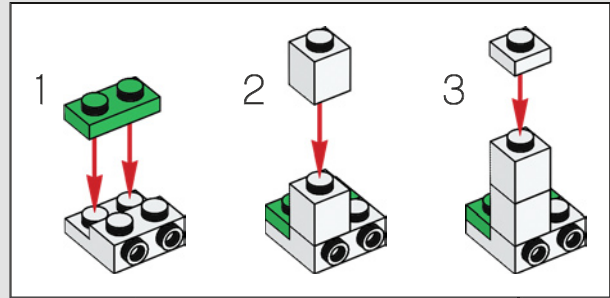

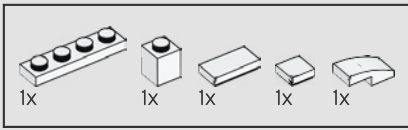

55

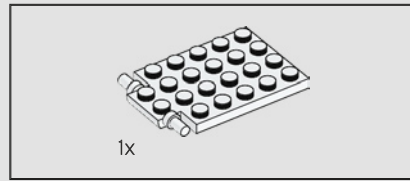
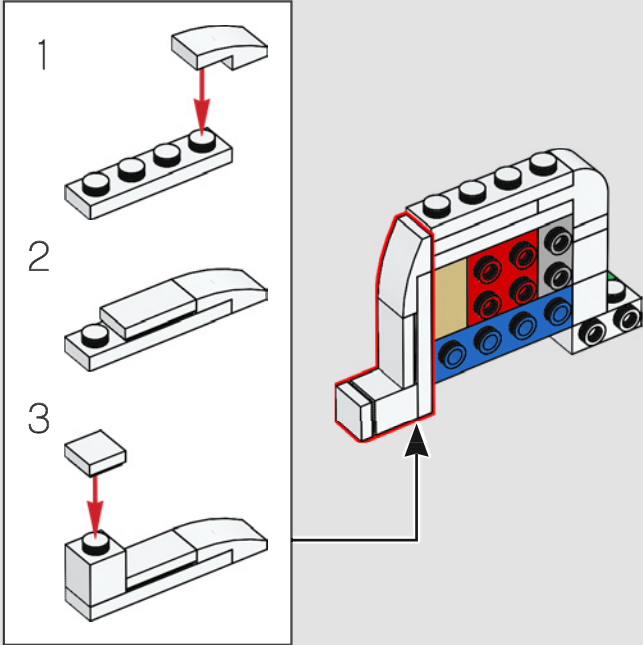

56

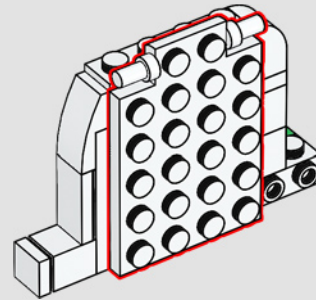

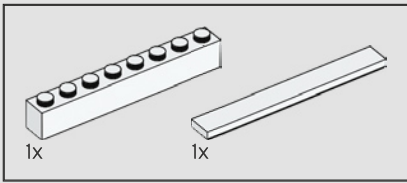

57

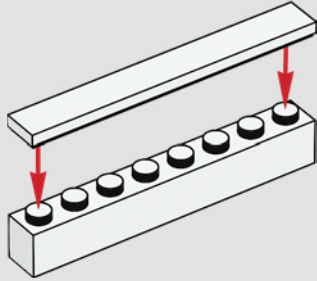

58

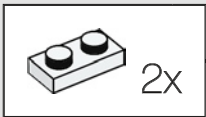
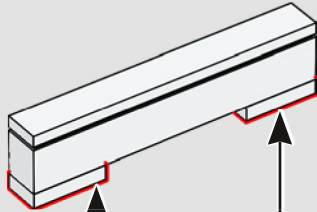

59

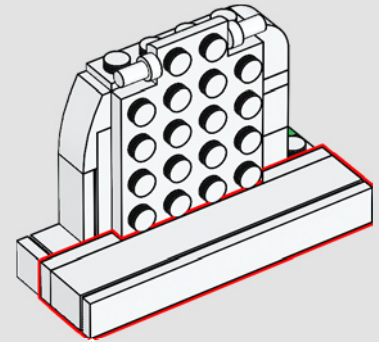

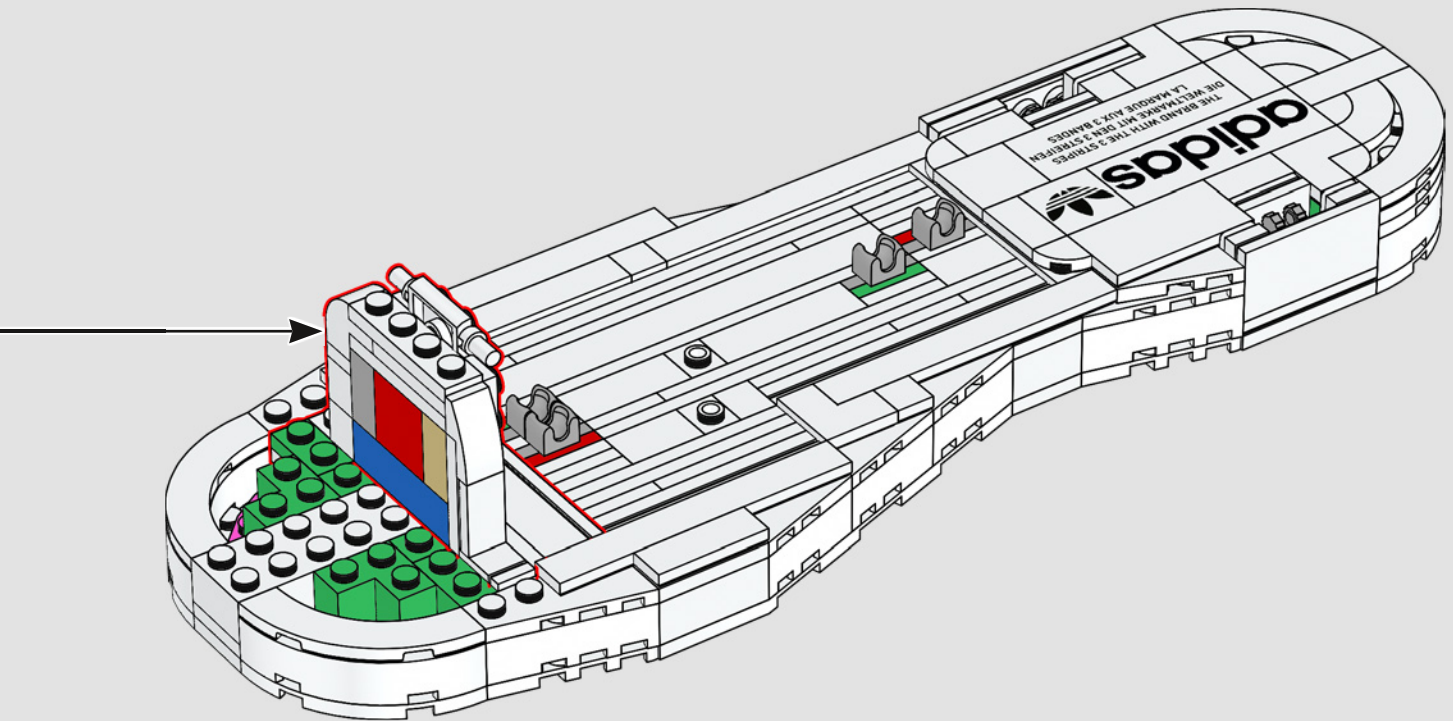

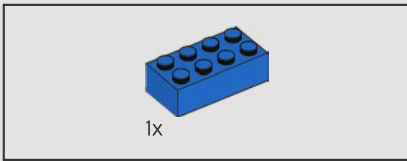

61

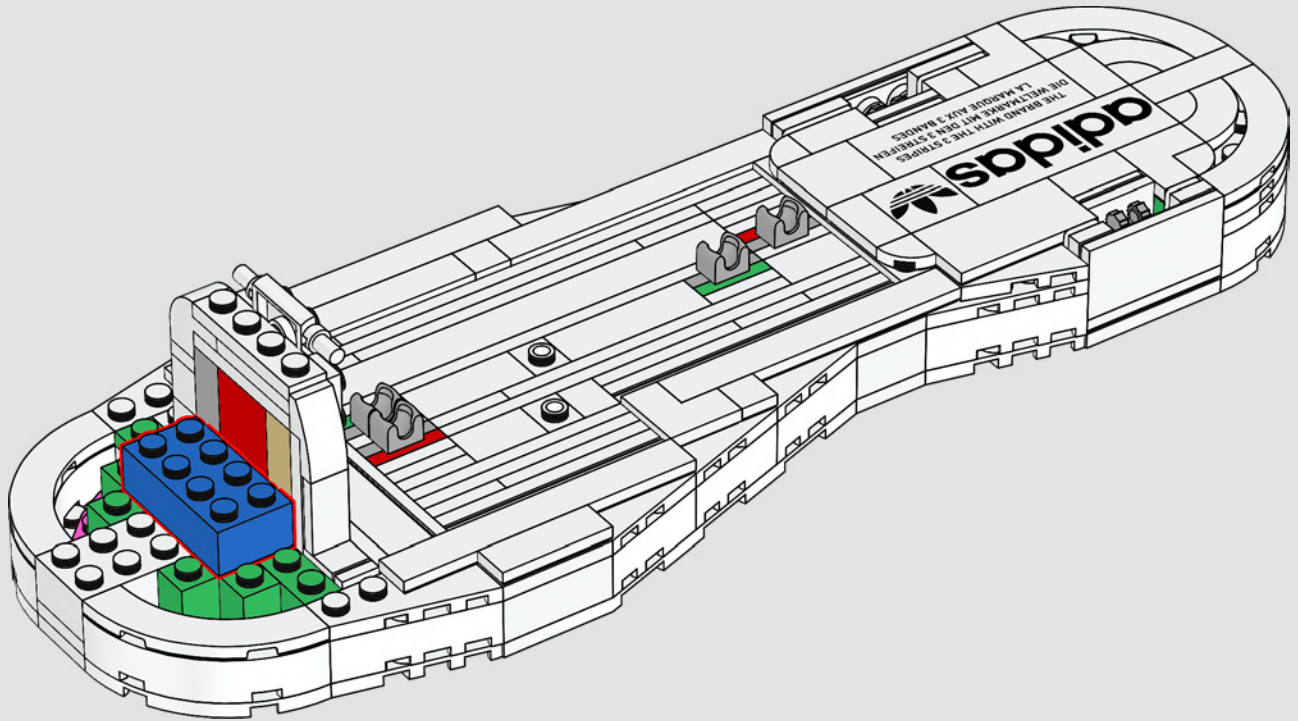

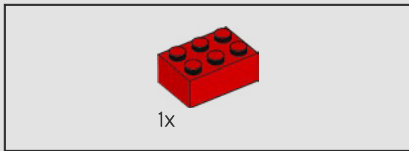

62

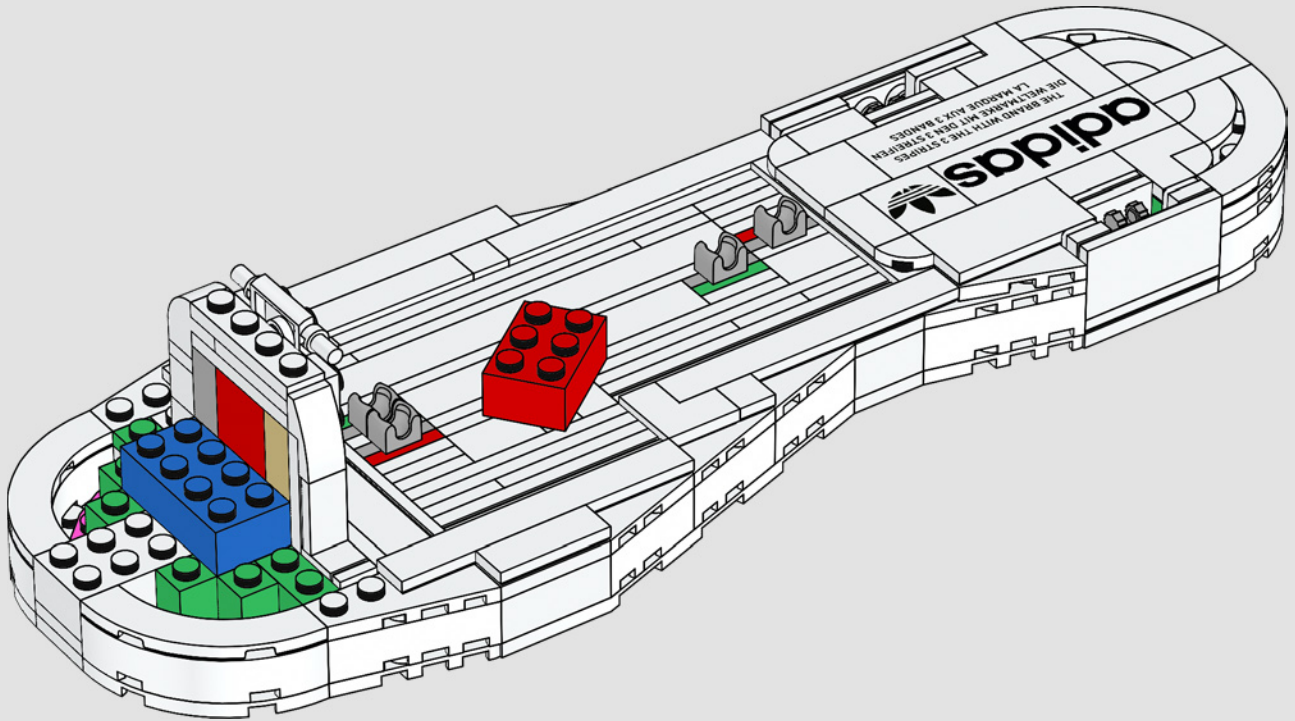

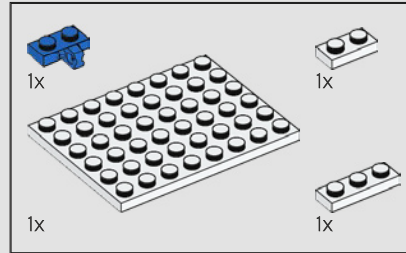
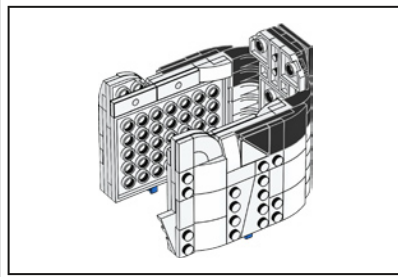

63

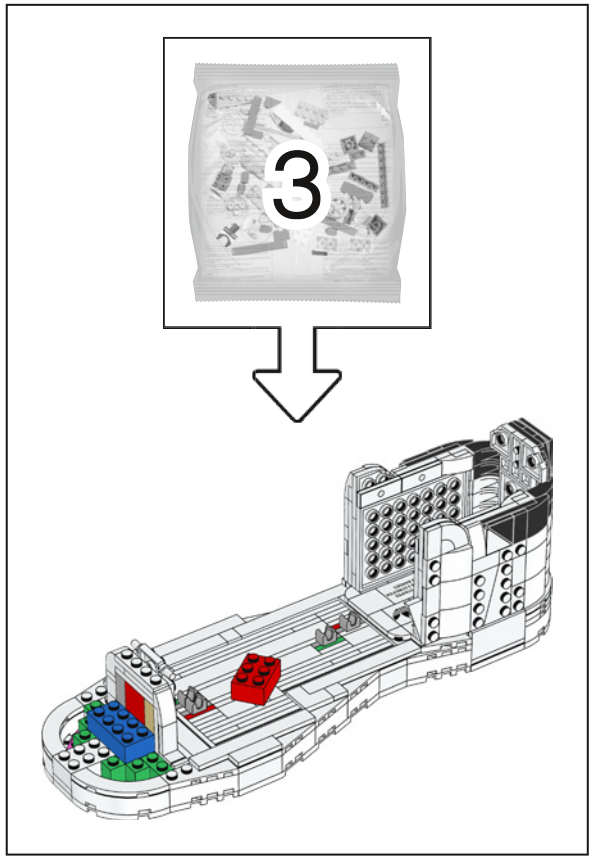
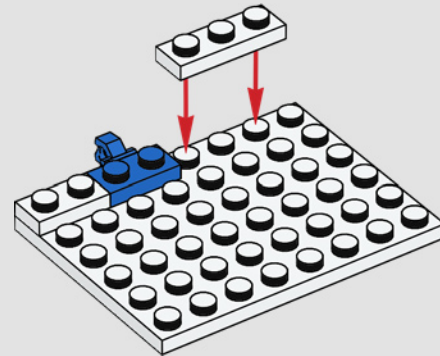

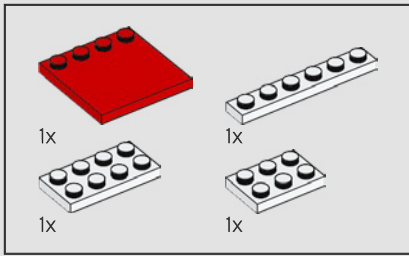

64

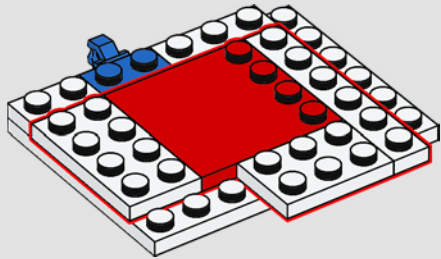

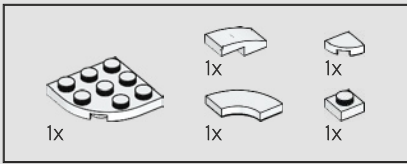

65

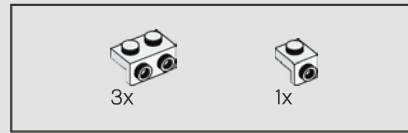
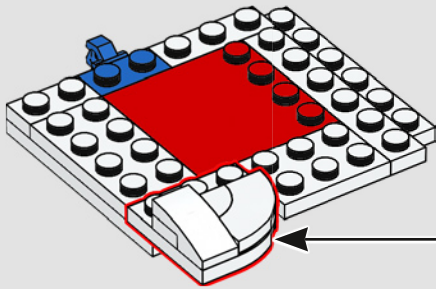
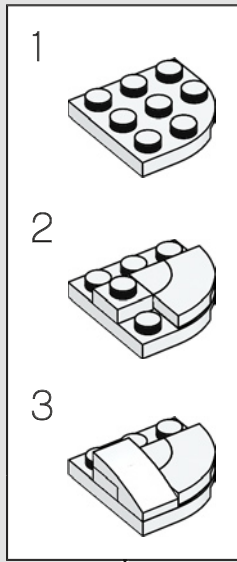

66

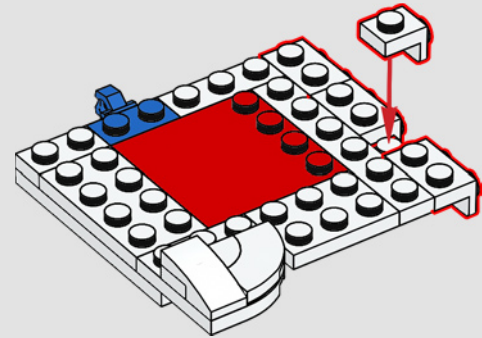

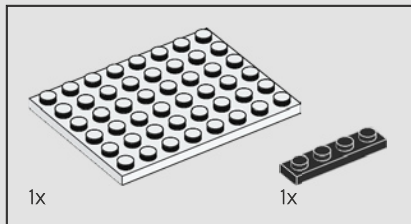

67

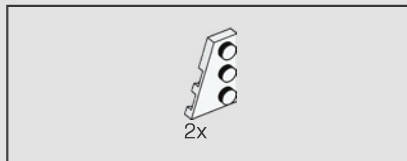
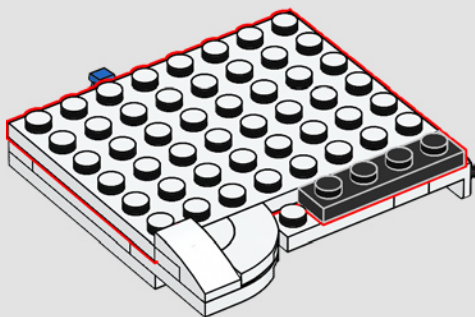

68

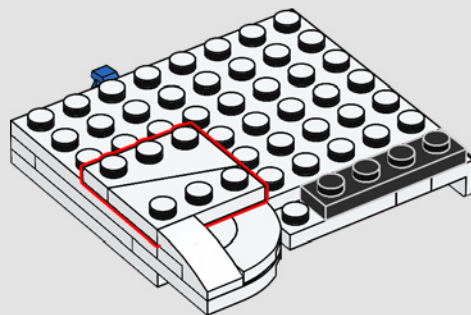

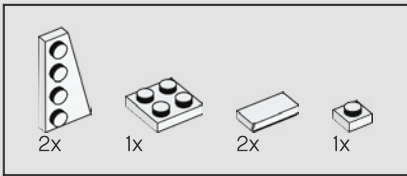

69

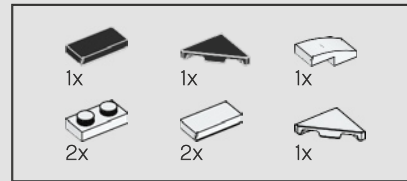
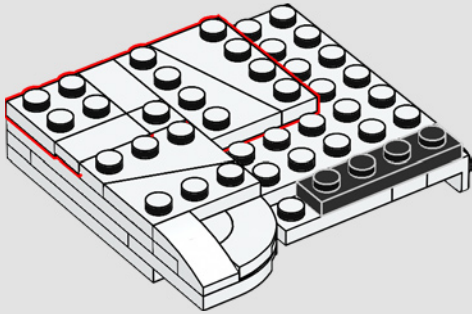

70

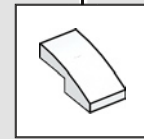
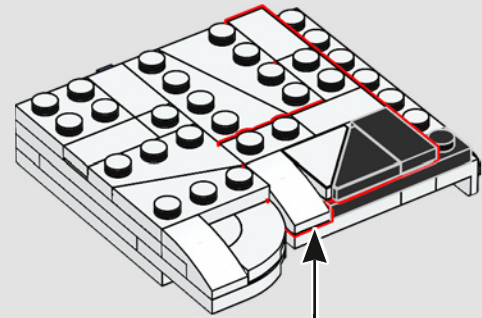

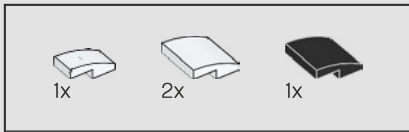

71

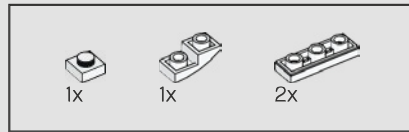
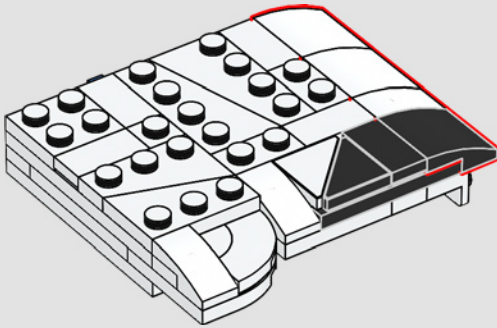

72

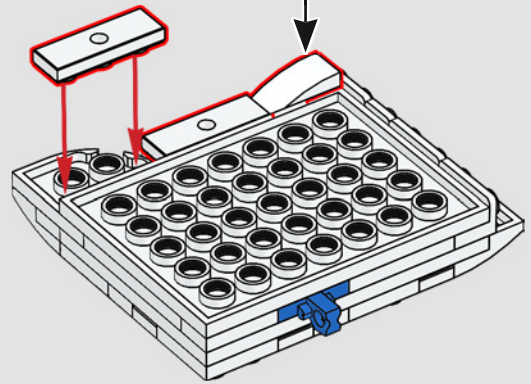
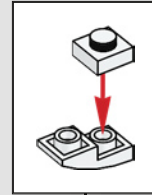

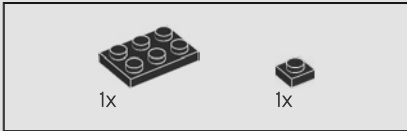
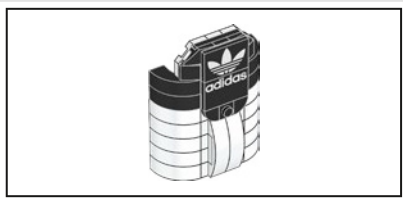

73

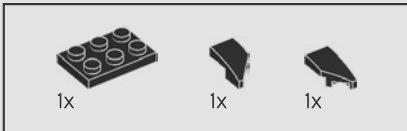

74

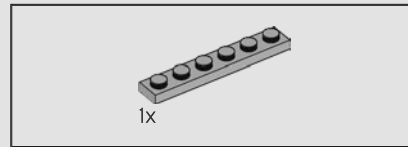
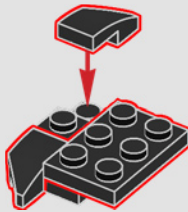

75

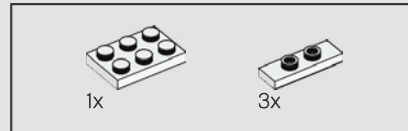
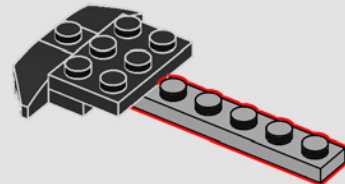

76

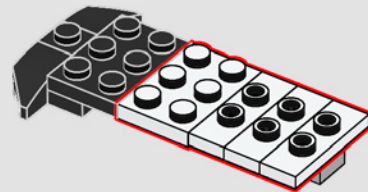

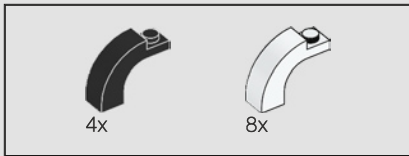

77

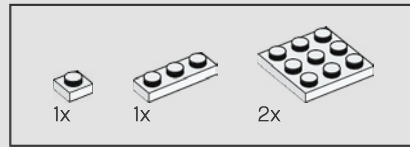
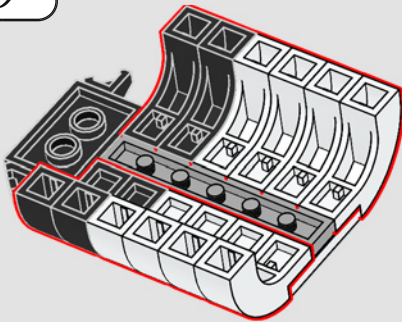

78

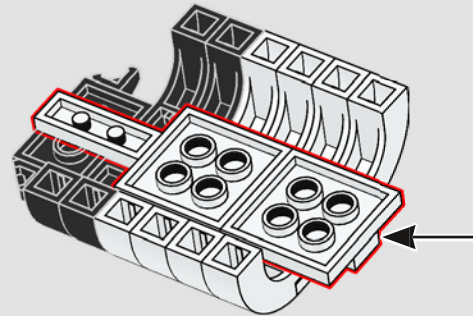
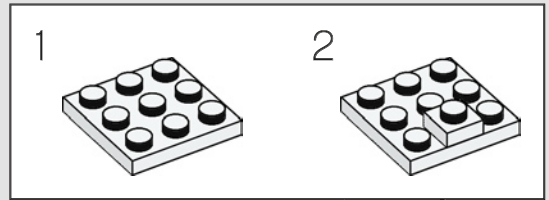

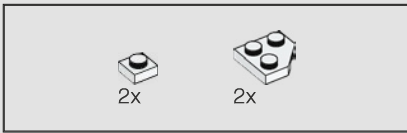

79

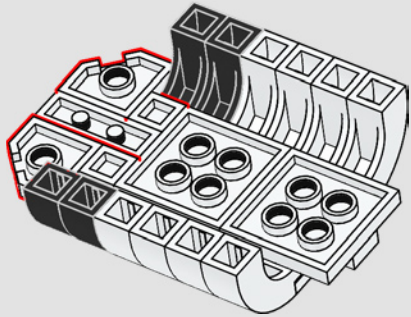

80

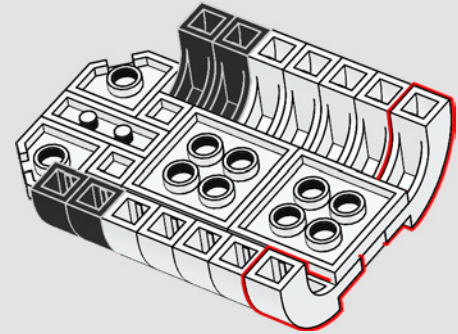

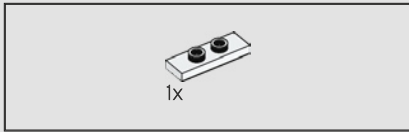

81

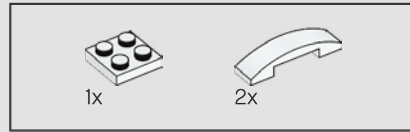
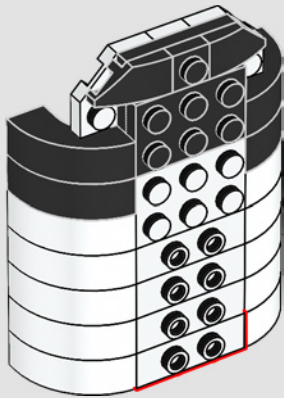

82

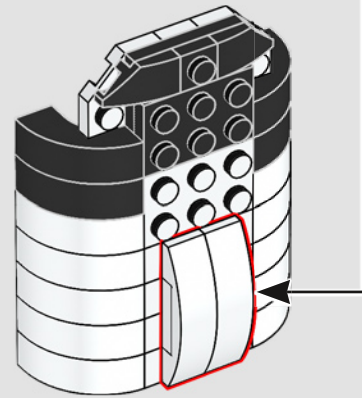
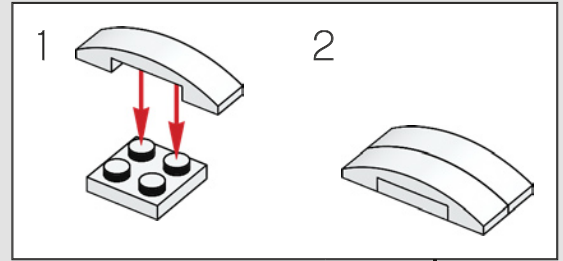

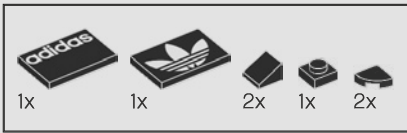

83

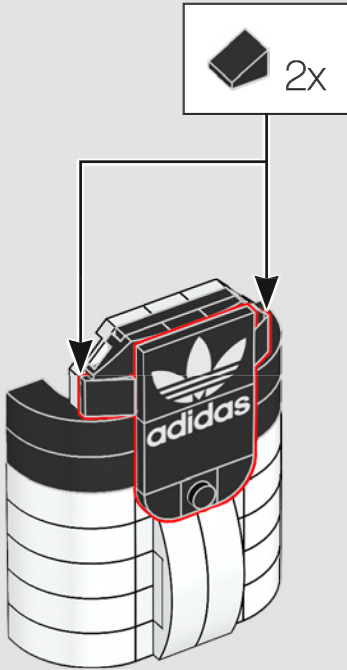

84

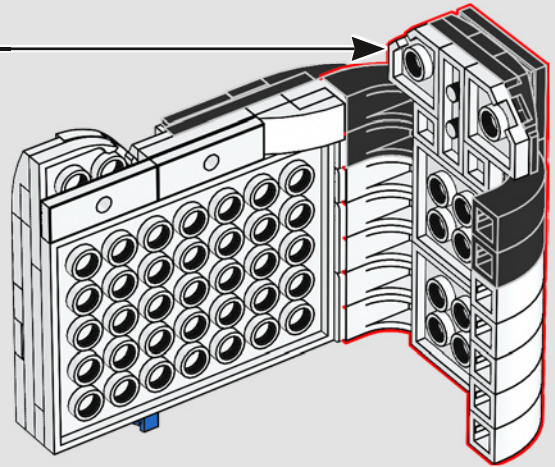

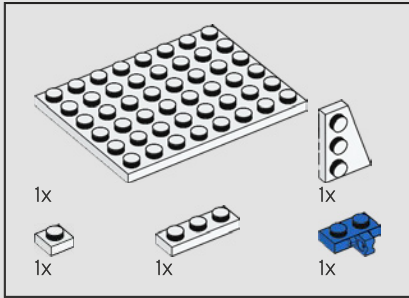
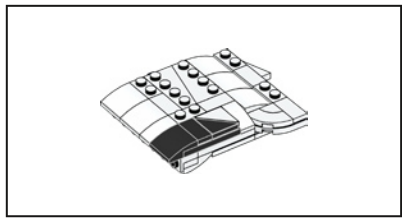

85

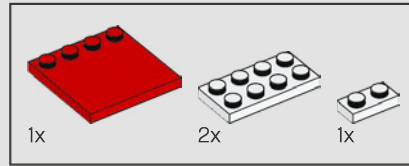
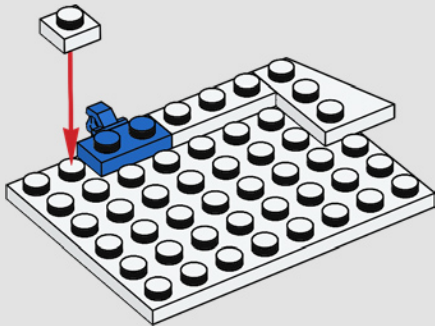

86

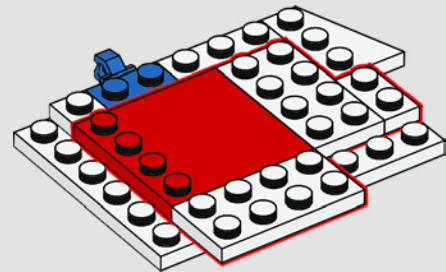



87

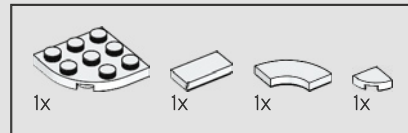
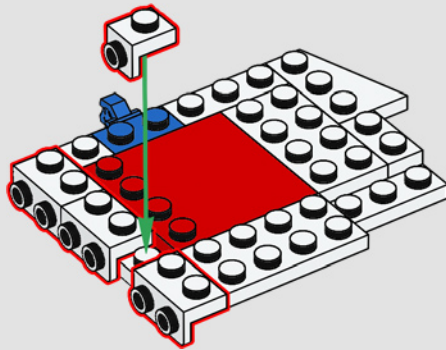

88

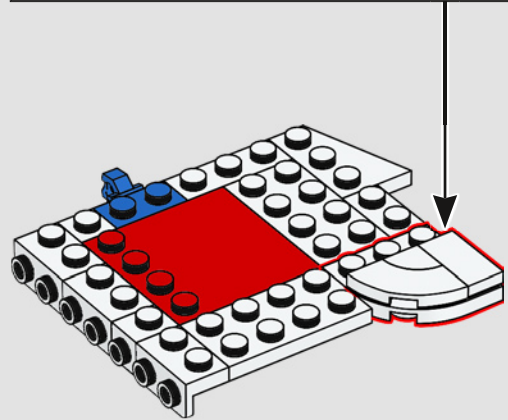
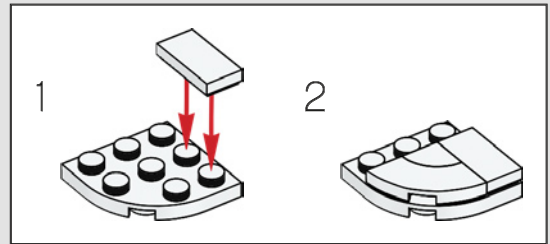

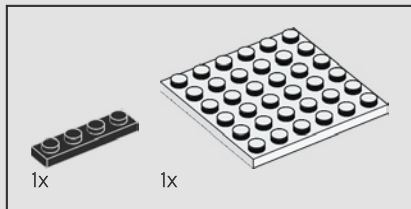

89

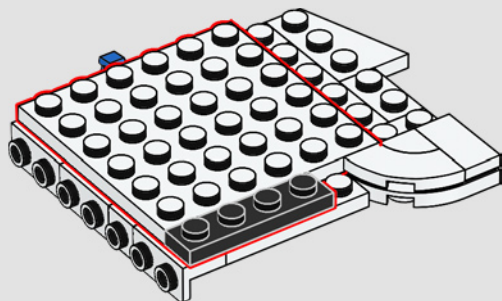

90

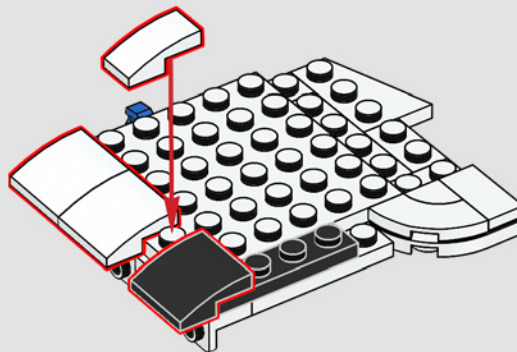

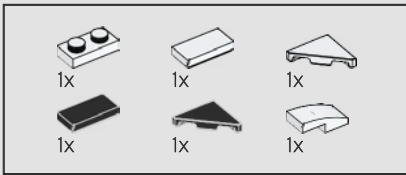

91

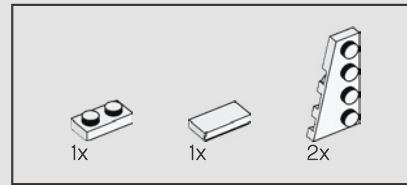
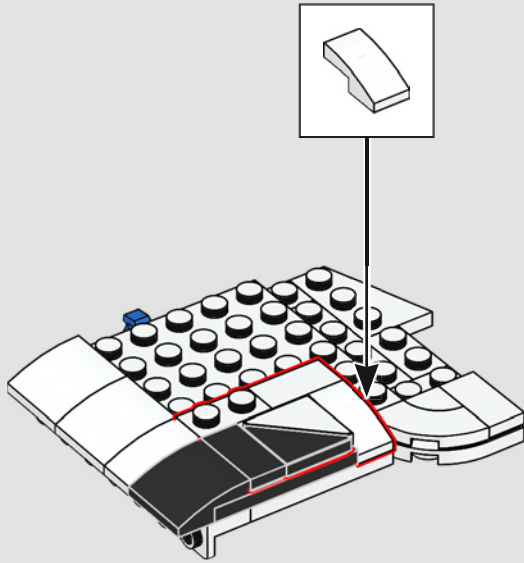

92

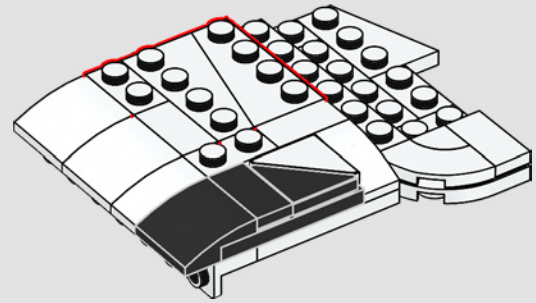

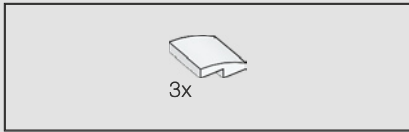

93

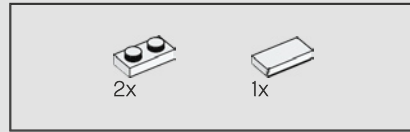
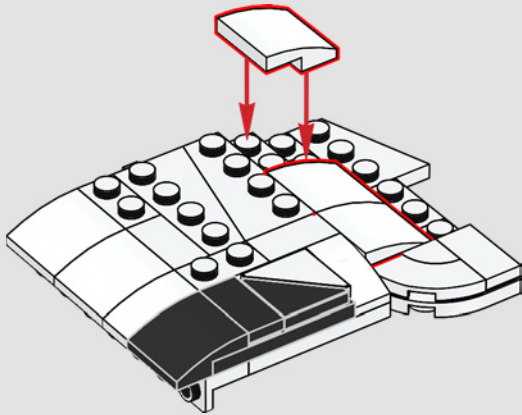

94

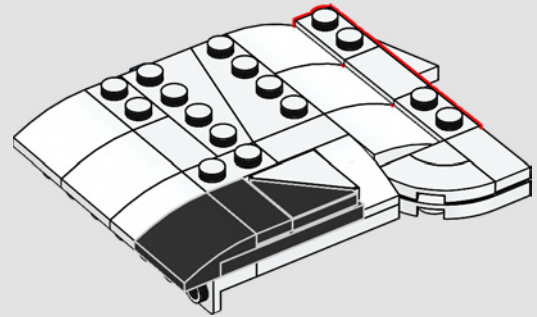

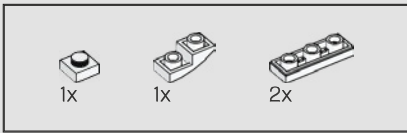

95

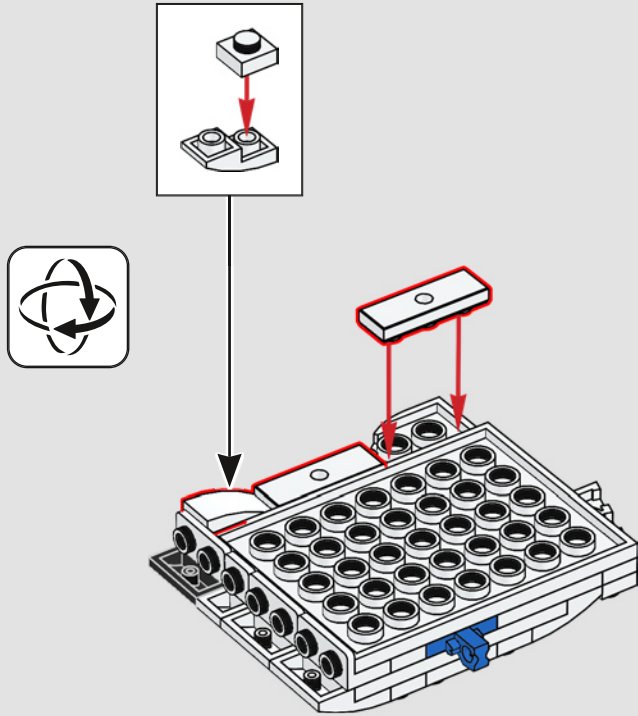

96

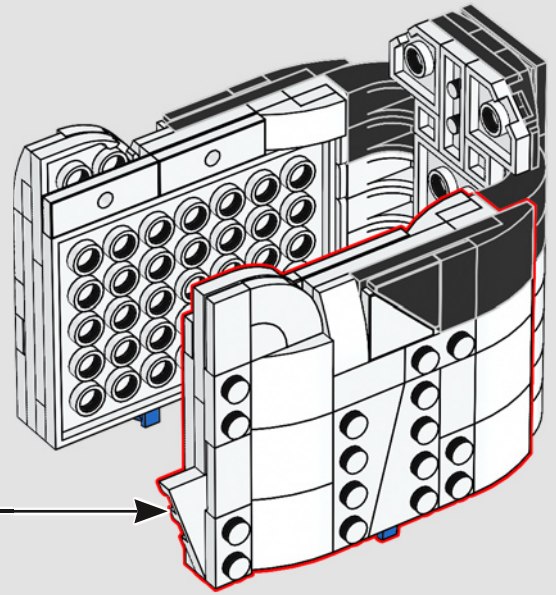

97

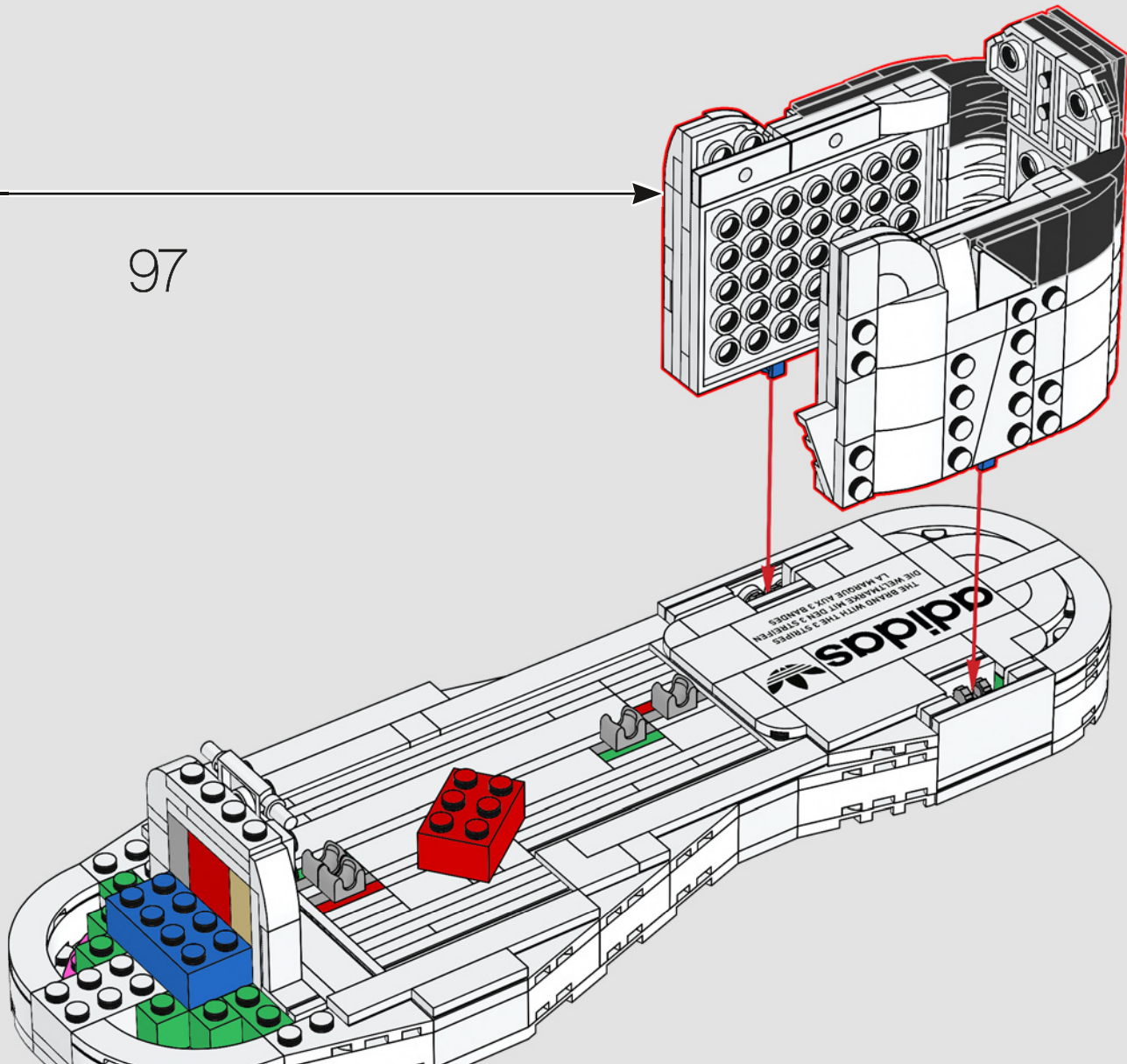

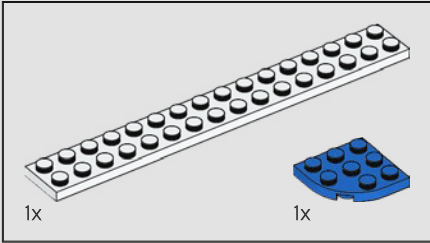
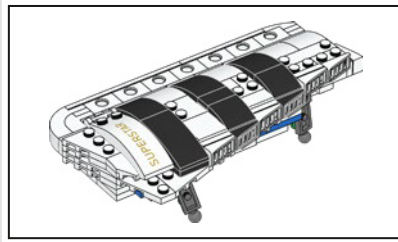

98

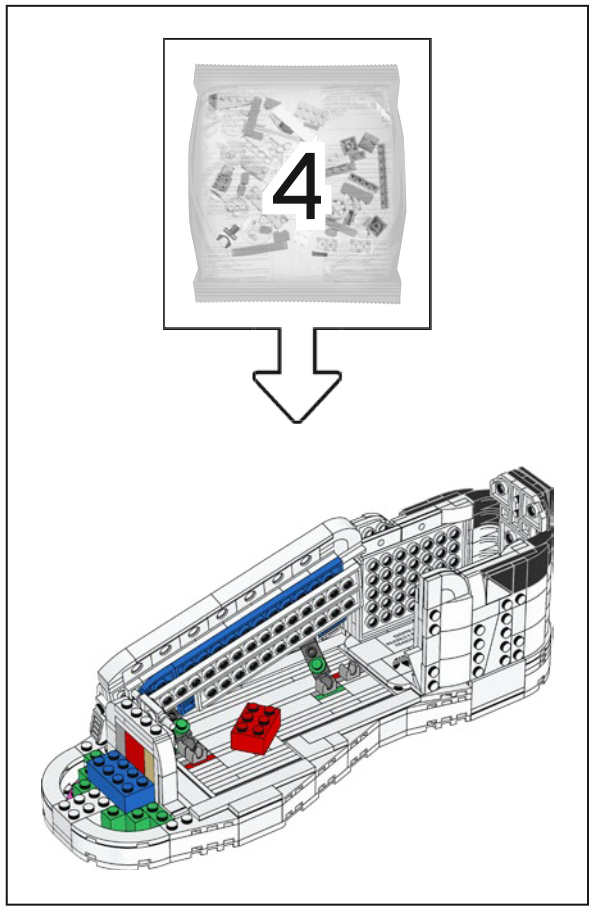
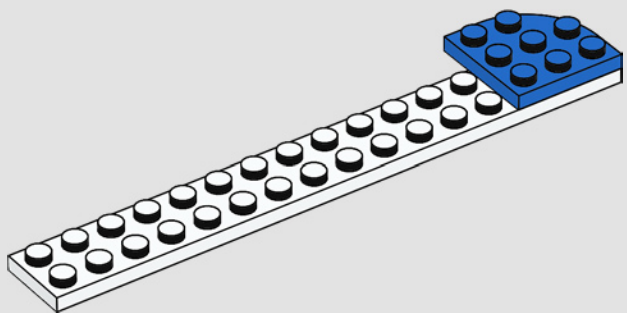

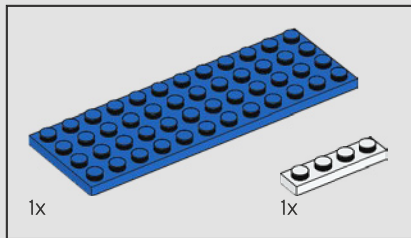

99

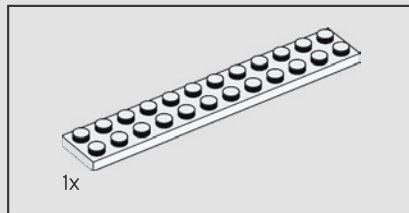
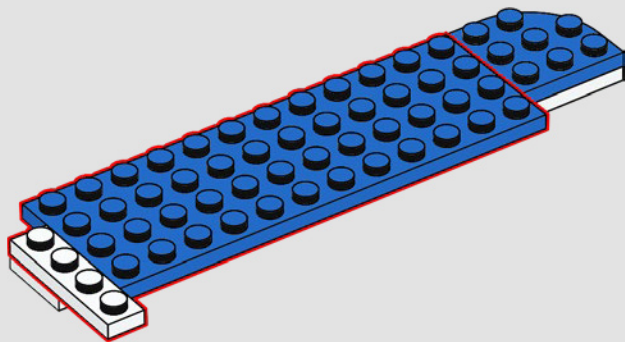

100

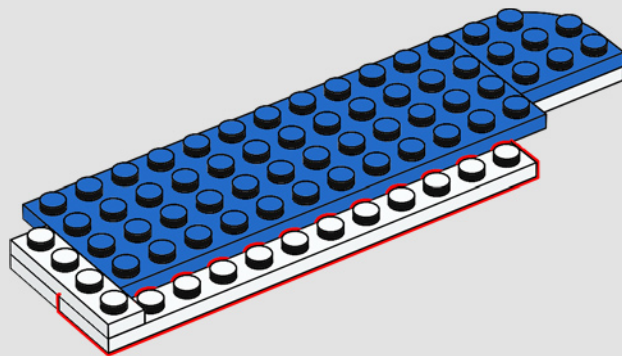

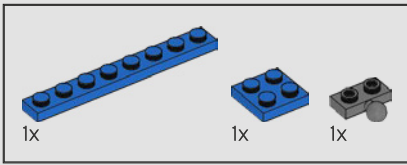

101

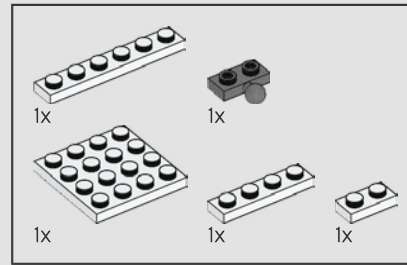
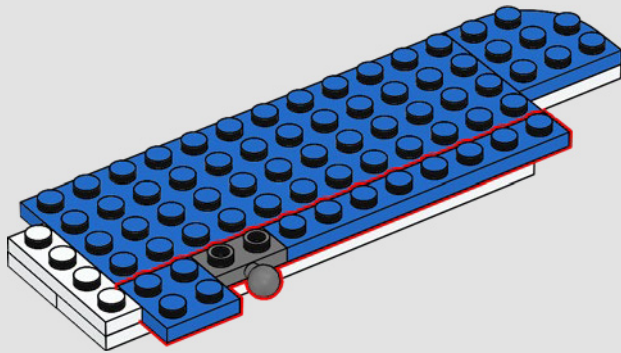

102

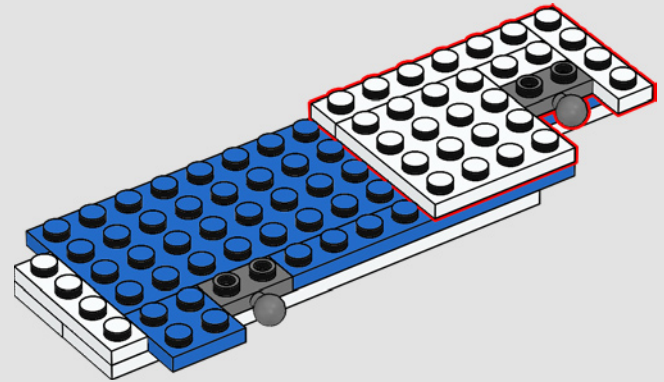

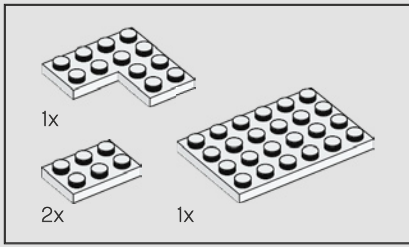

103

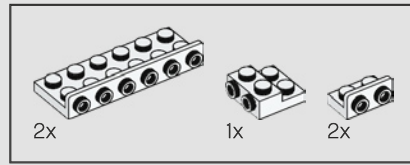
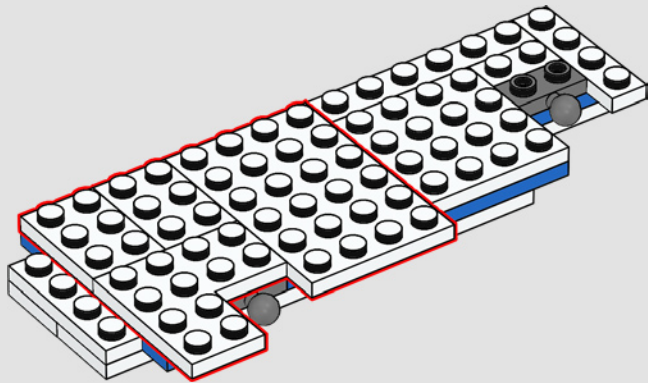

104

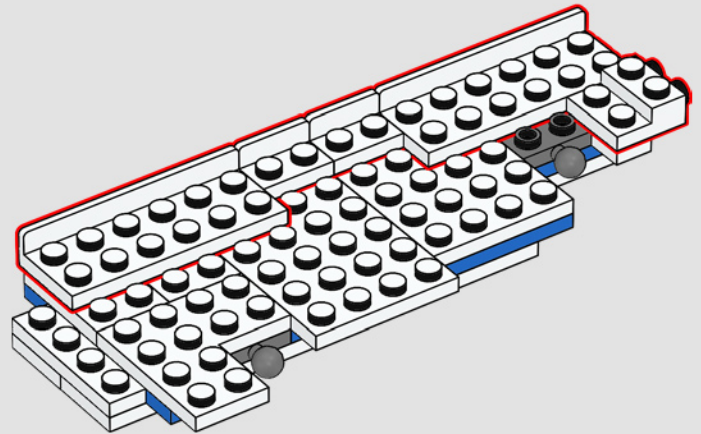

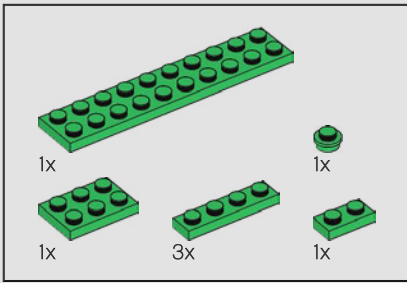

105

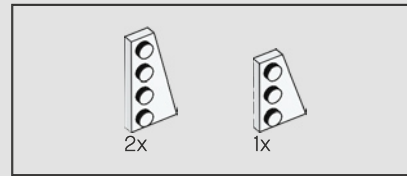
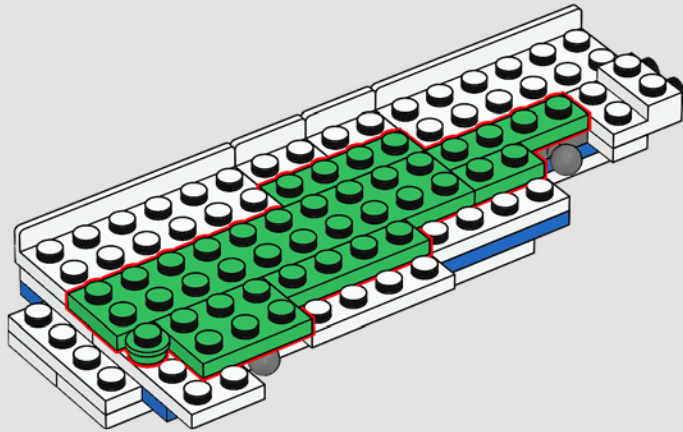

106

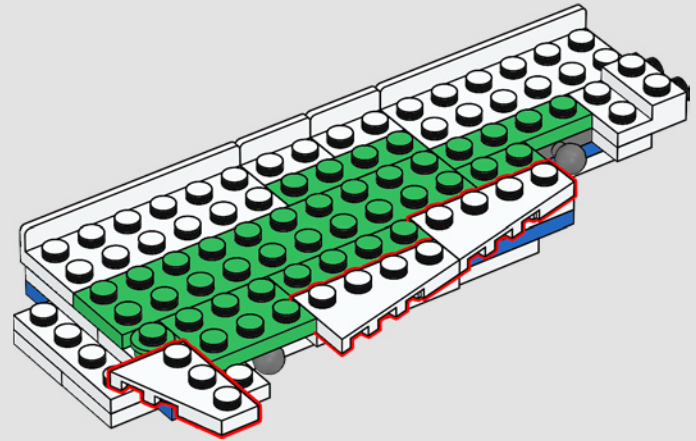

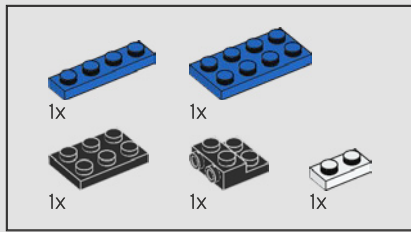

107

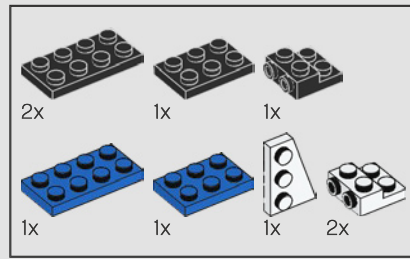
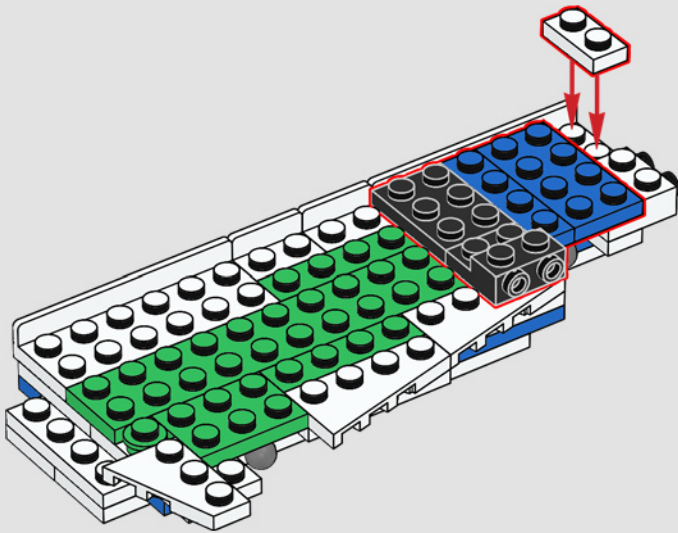

108

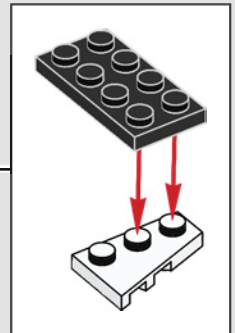
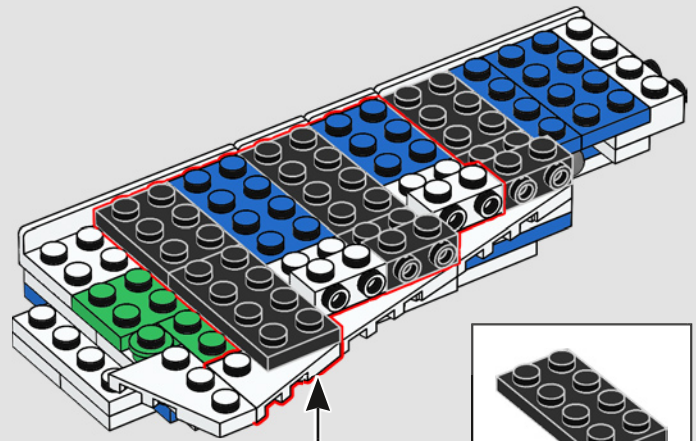

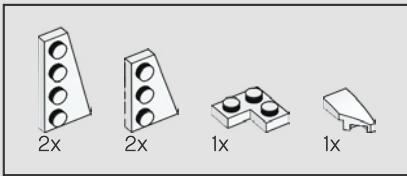

109

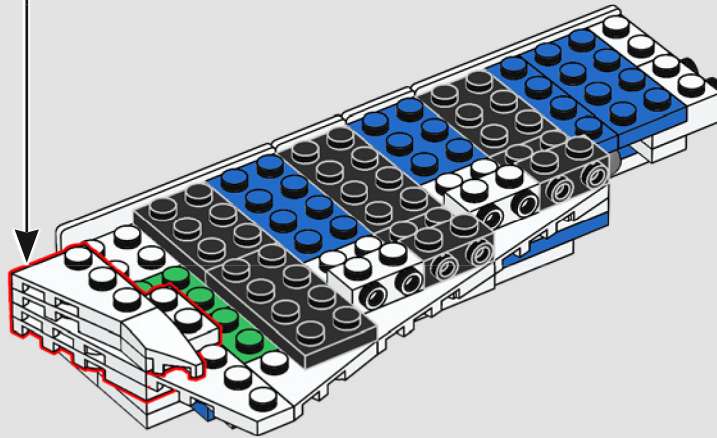
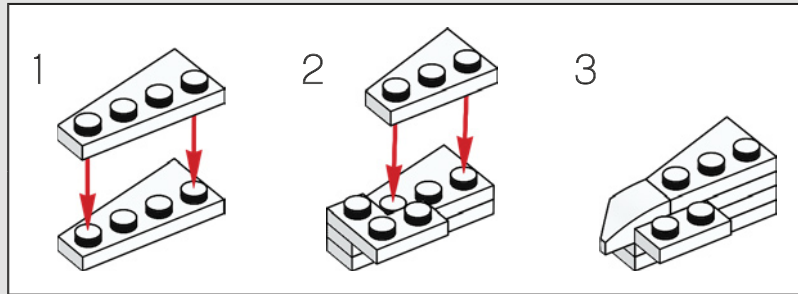

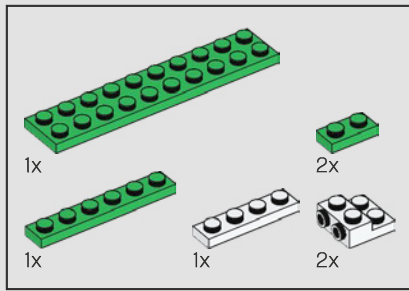

110

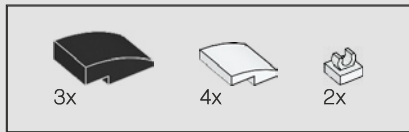
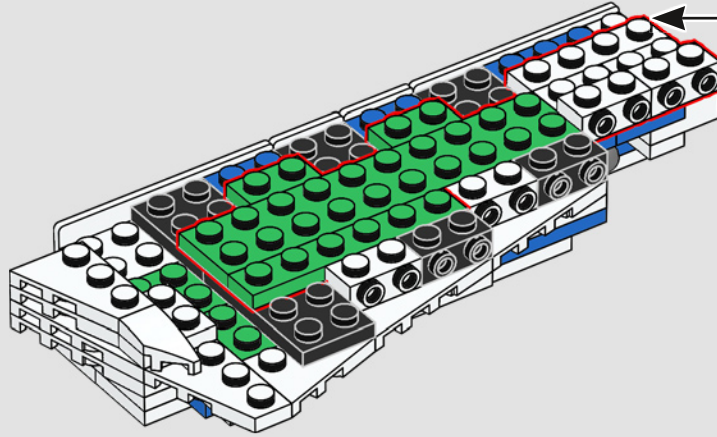

111

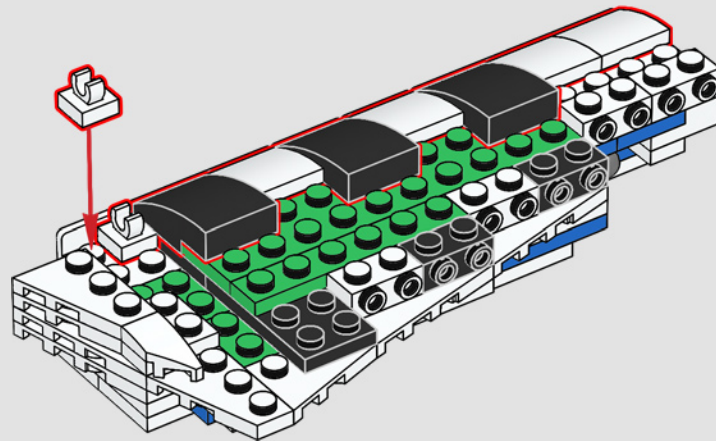

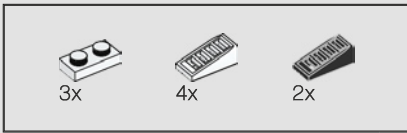

112

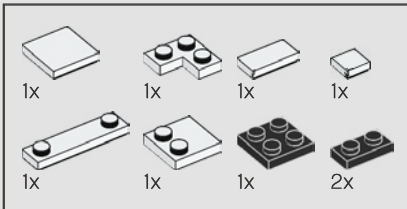
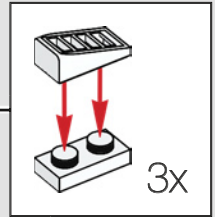
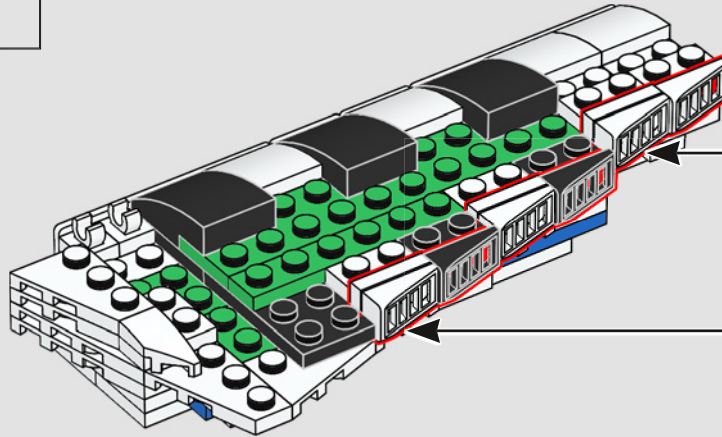

113

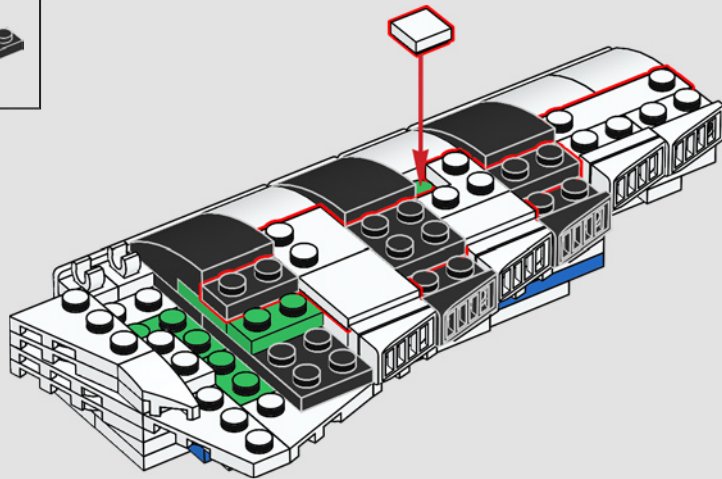

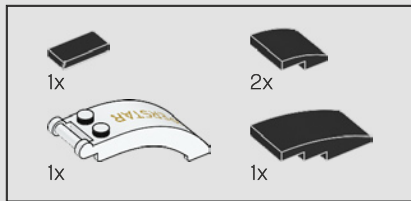

114

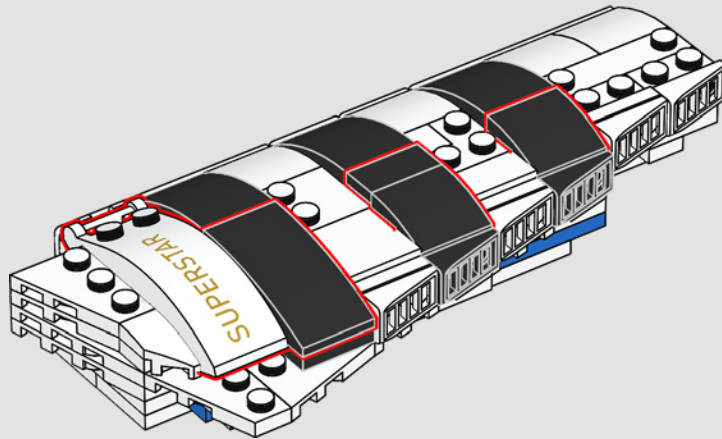

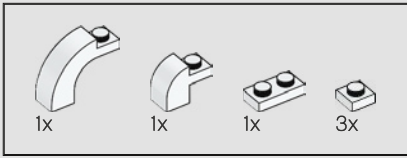

115

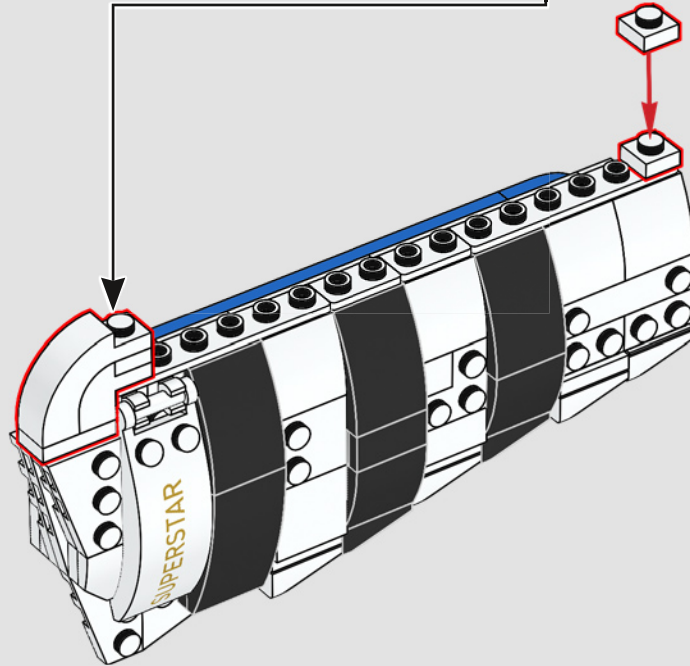
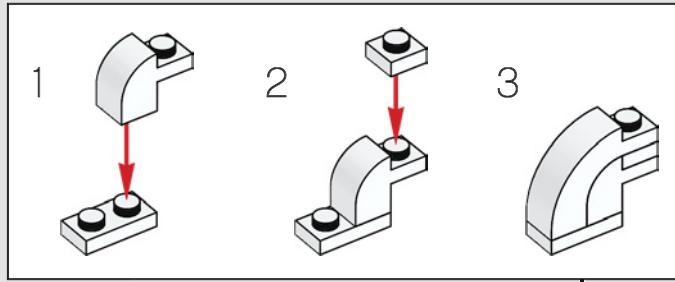

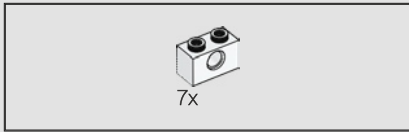

116

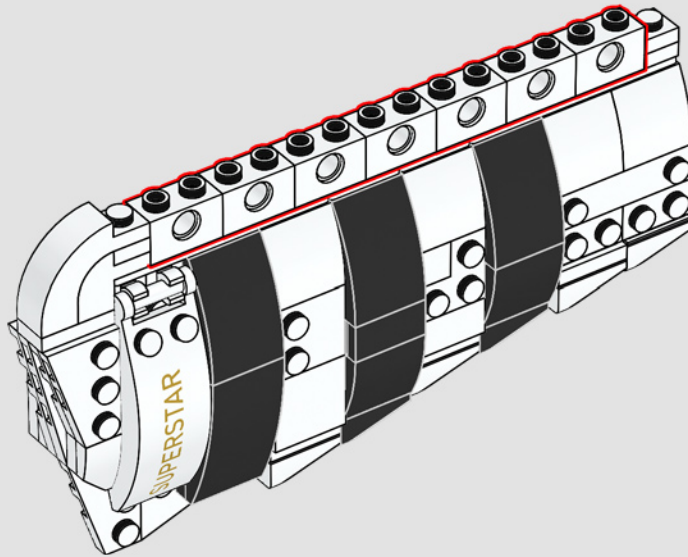

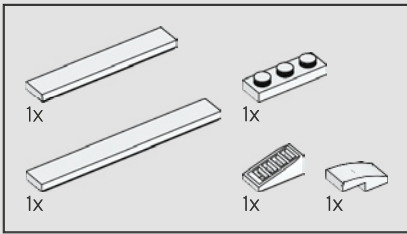

117

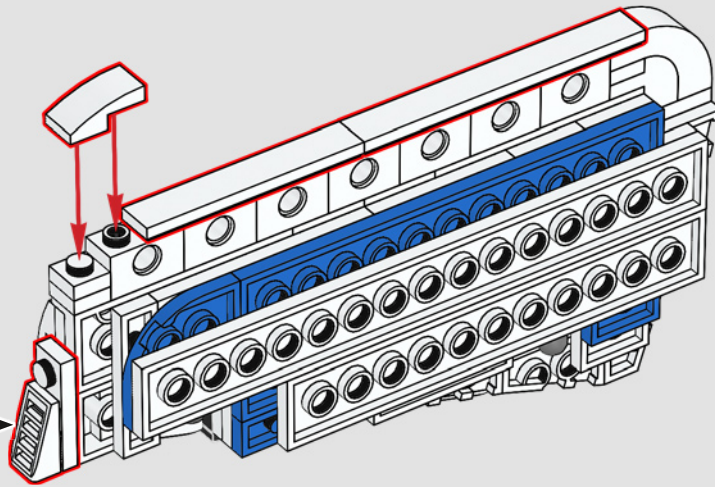
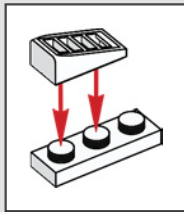



118

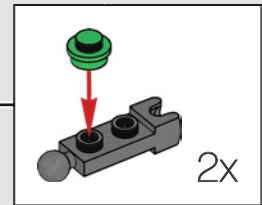
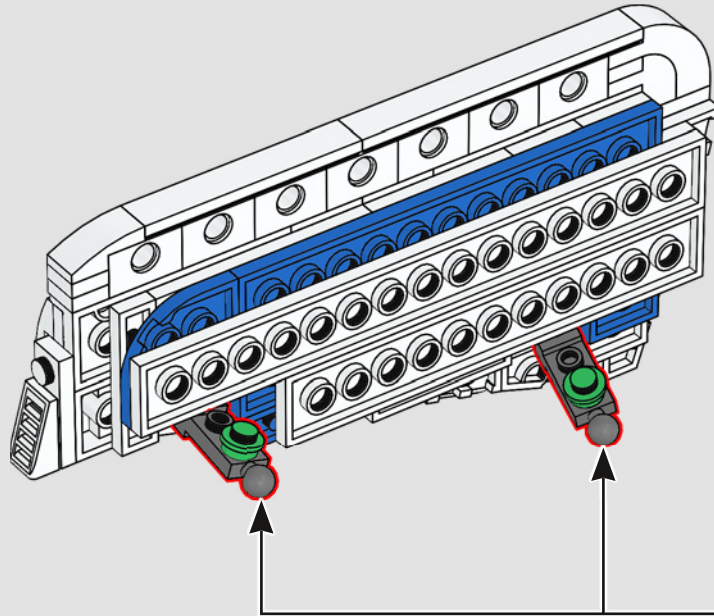

119

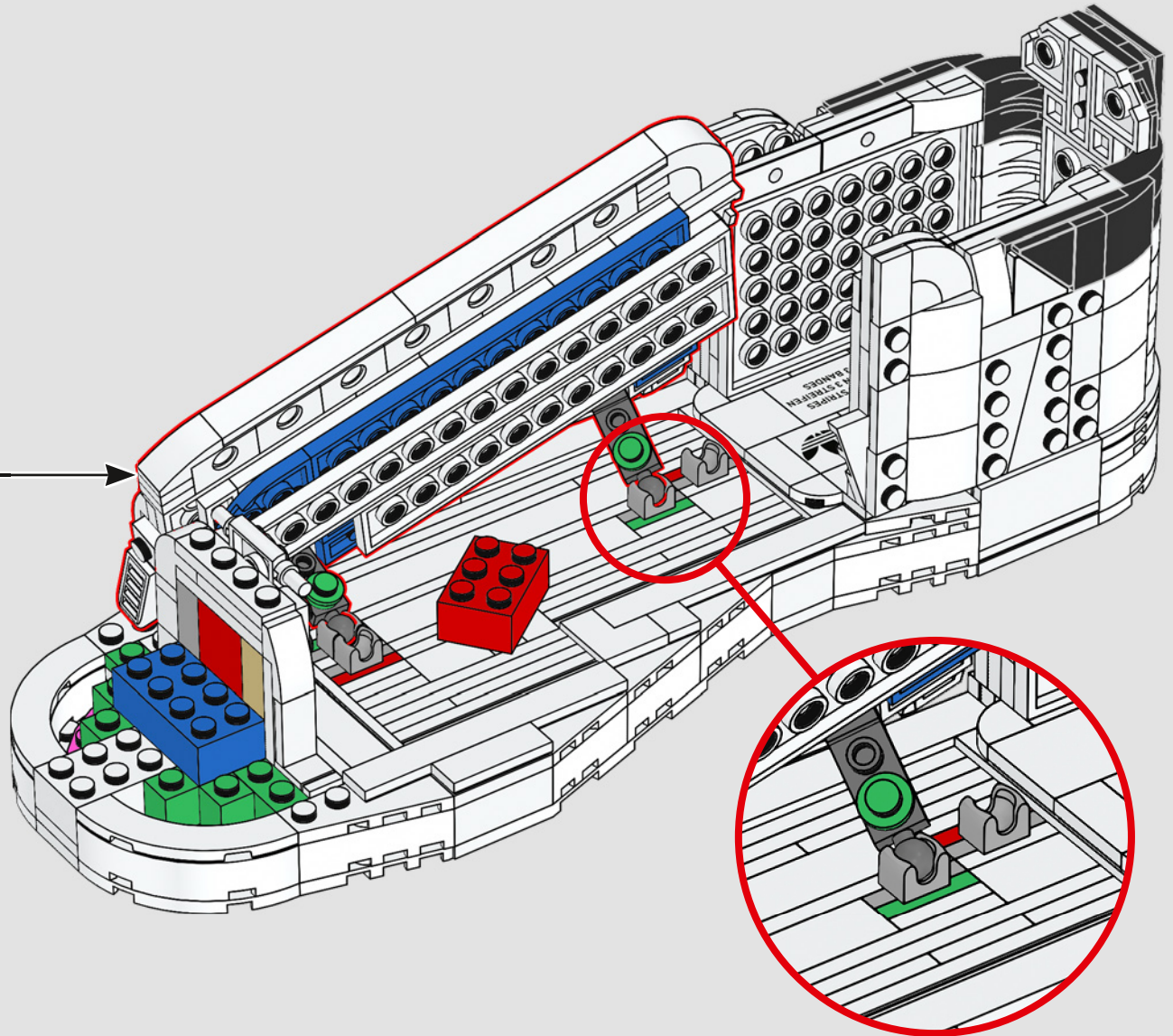

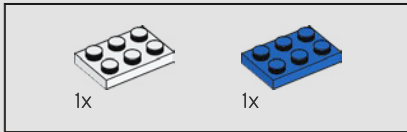
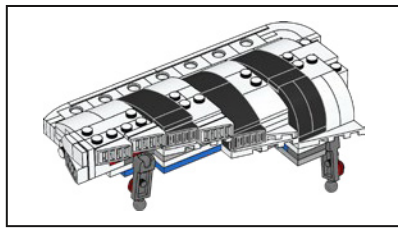
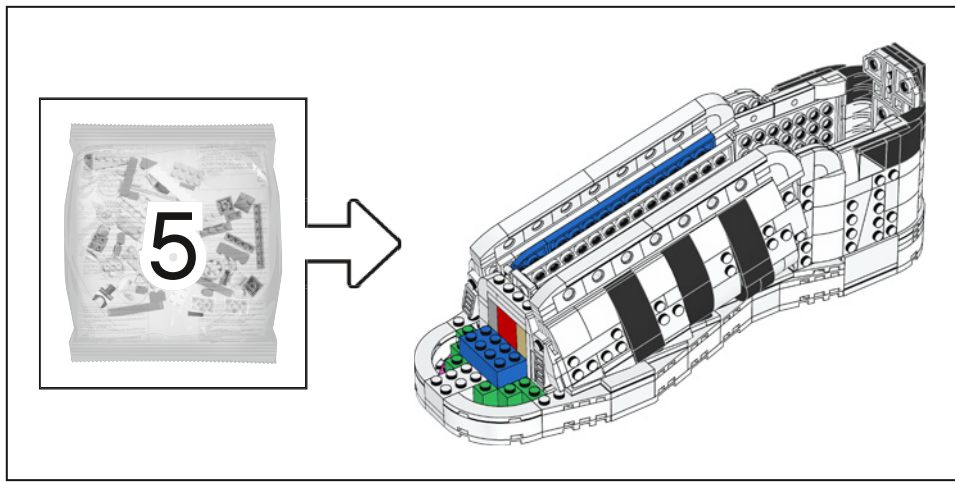

120

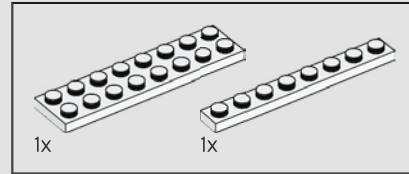

121

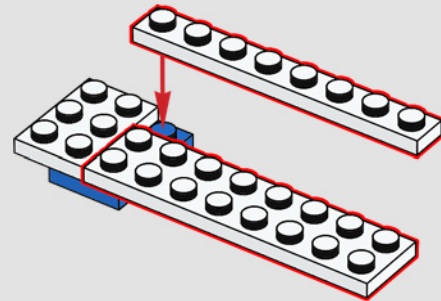

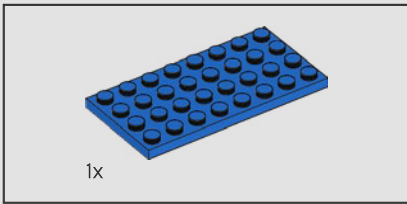

122

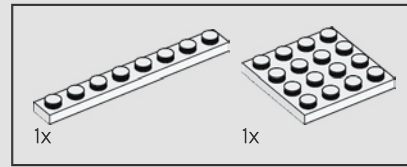
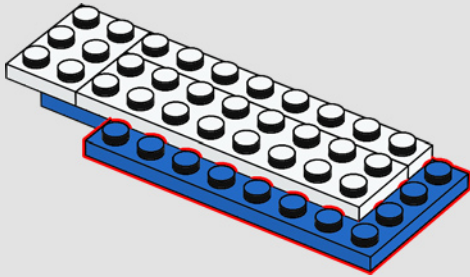

123

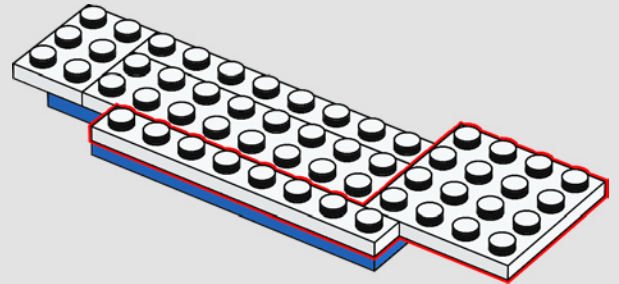

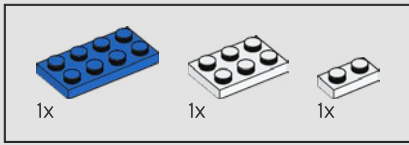

124

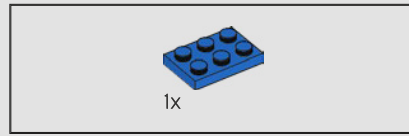
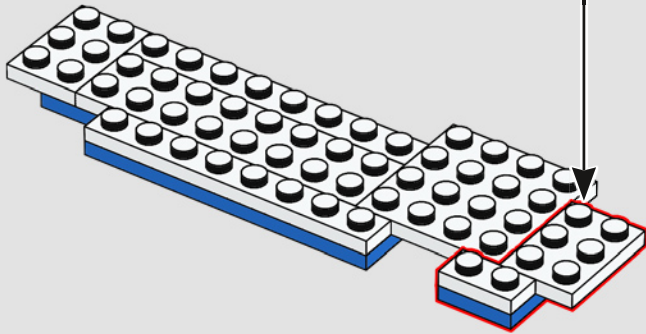
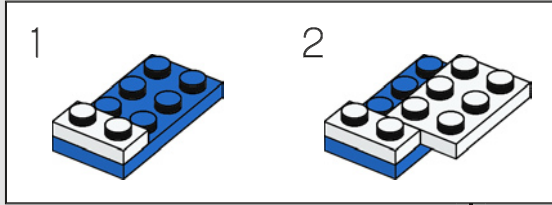

125

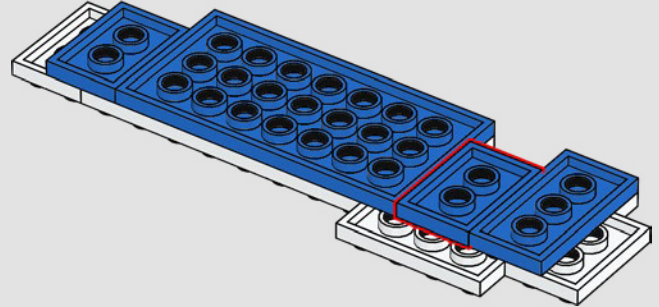
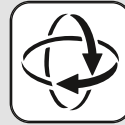

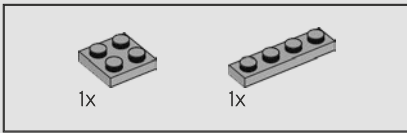

126

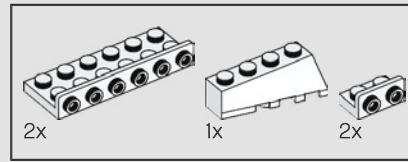
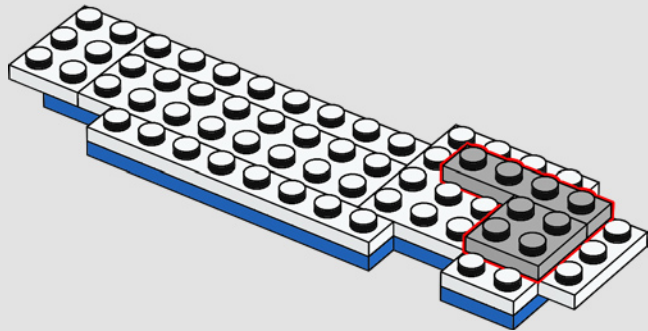

127

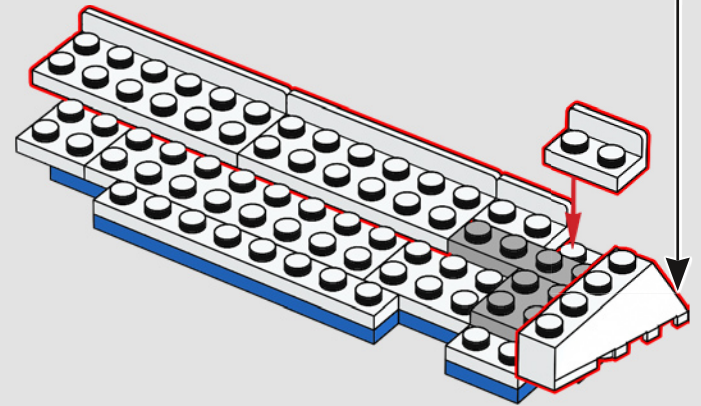
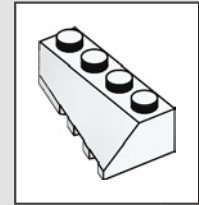

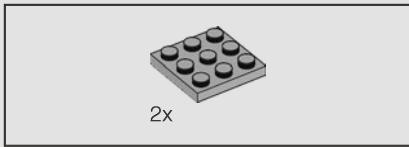

128

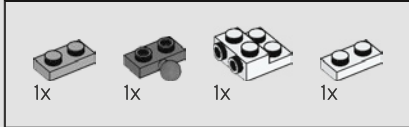
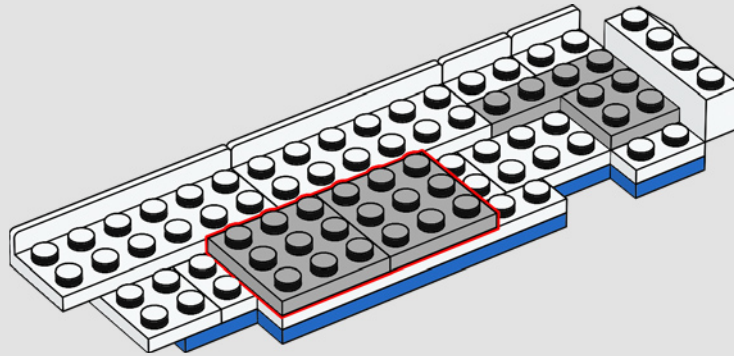

129

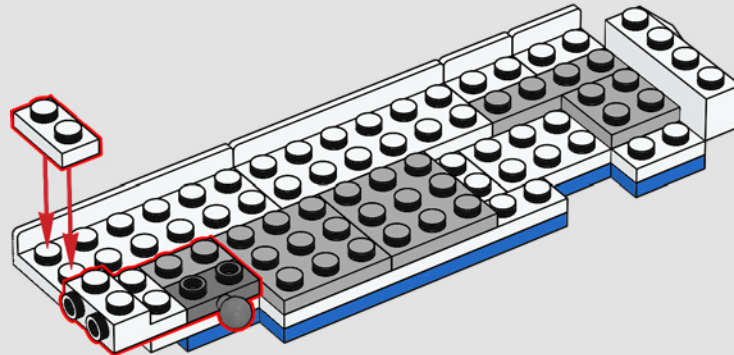

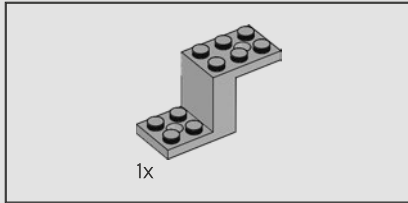
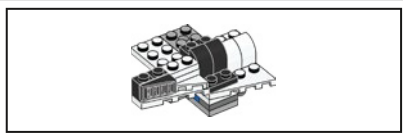

130

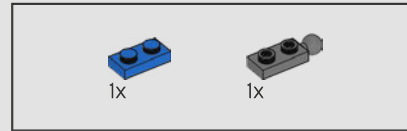
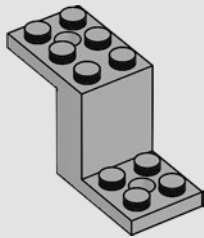

131

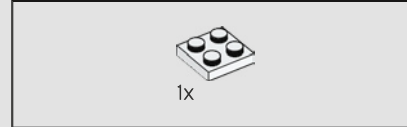
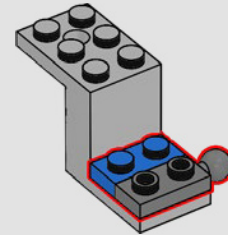

132

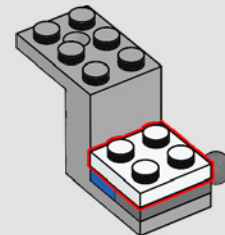

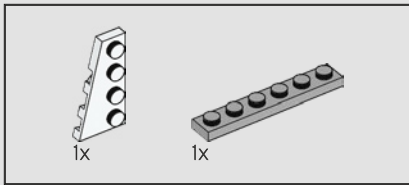

133

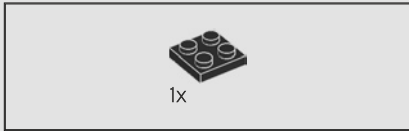
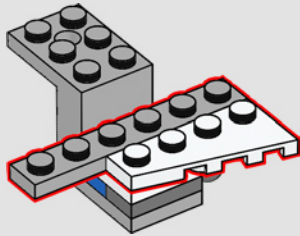

134

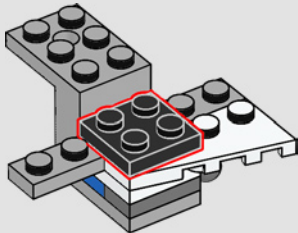

135

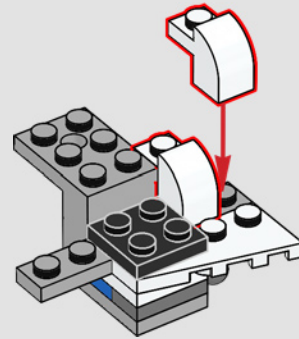

136

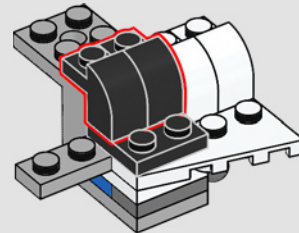

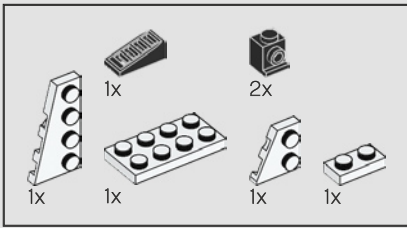

137

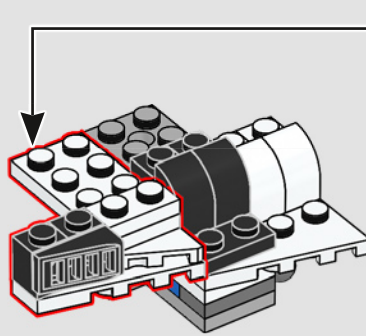
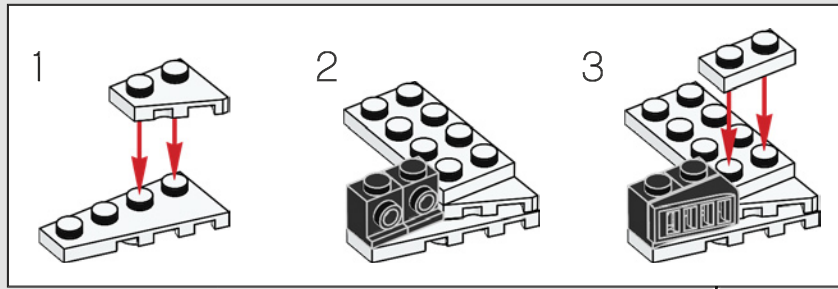

138

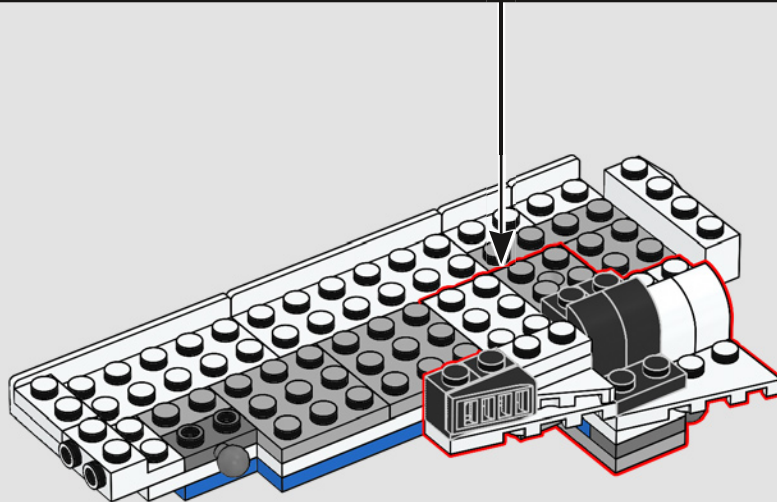

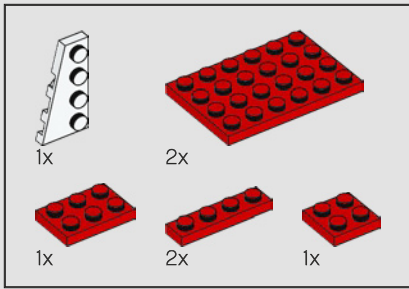

139

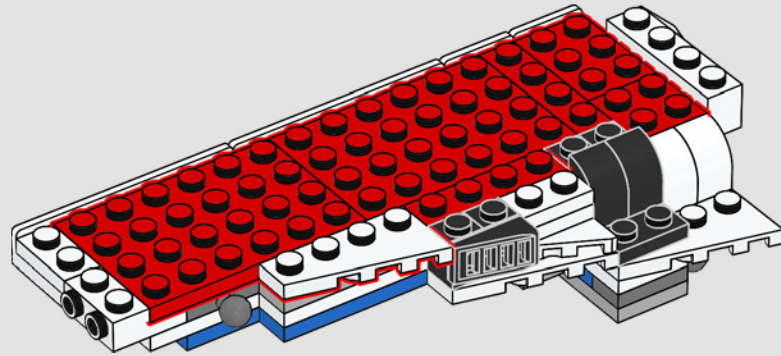

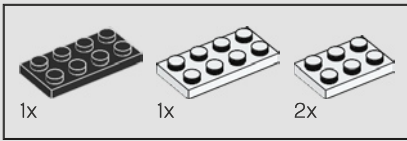

140

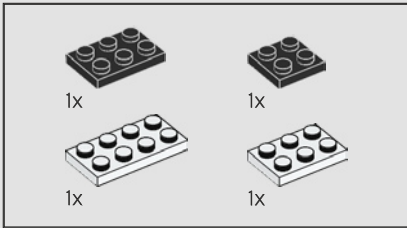
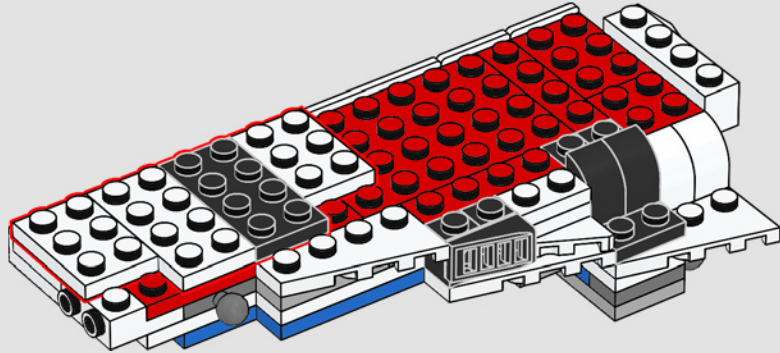

141

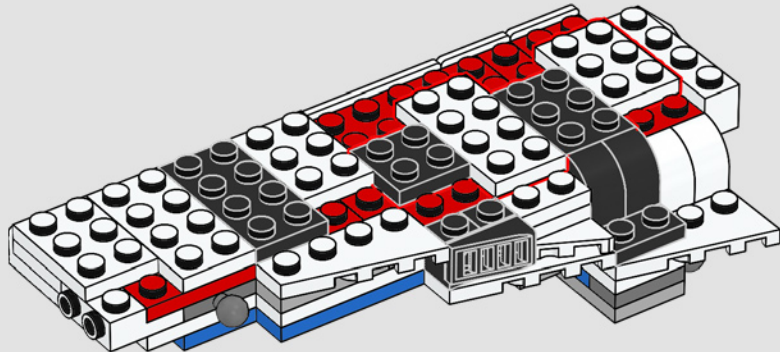



142

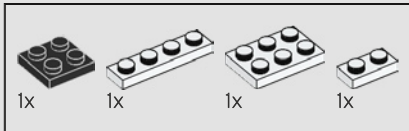
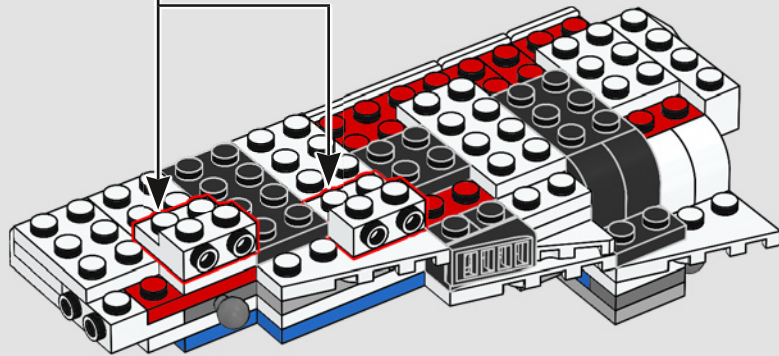
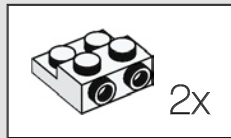

143

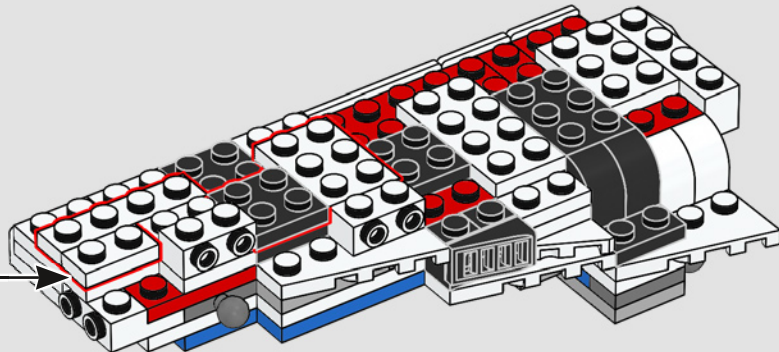
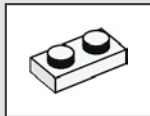



144

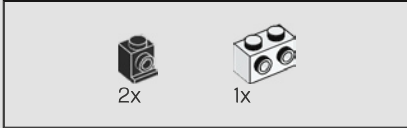
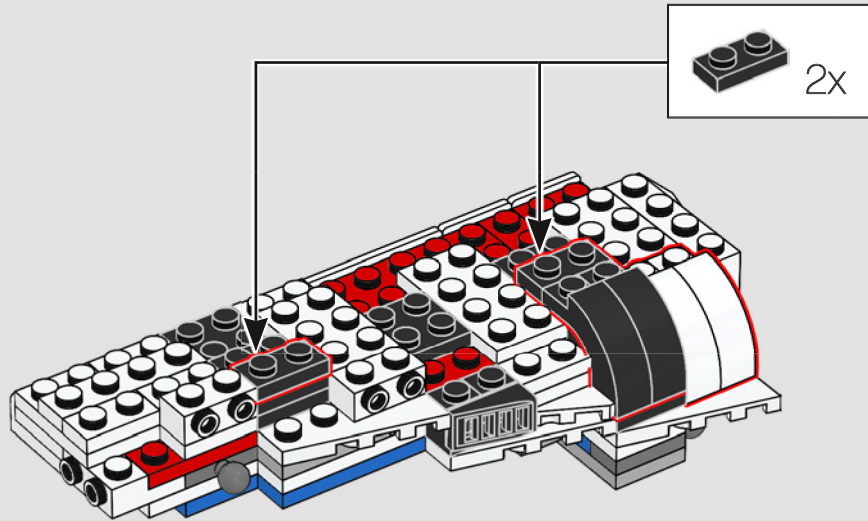

145

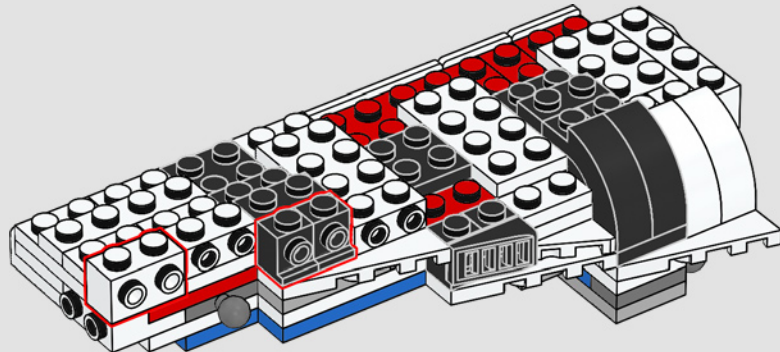

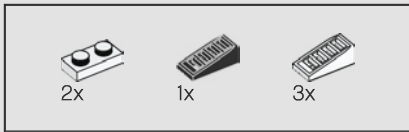

146

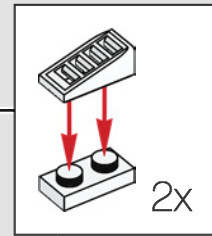
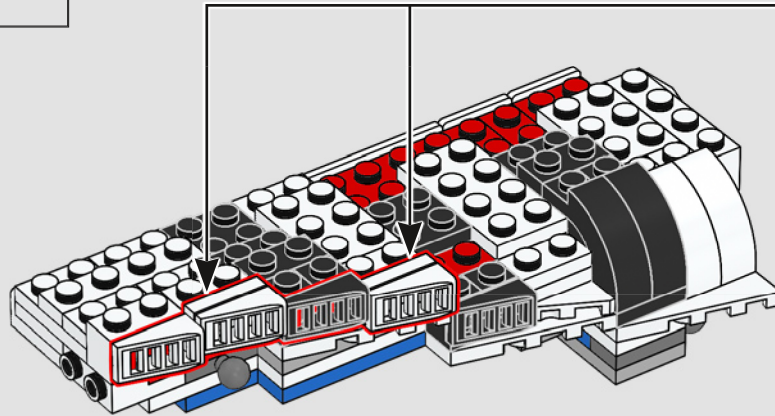

147

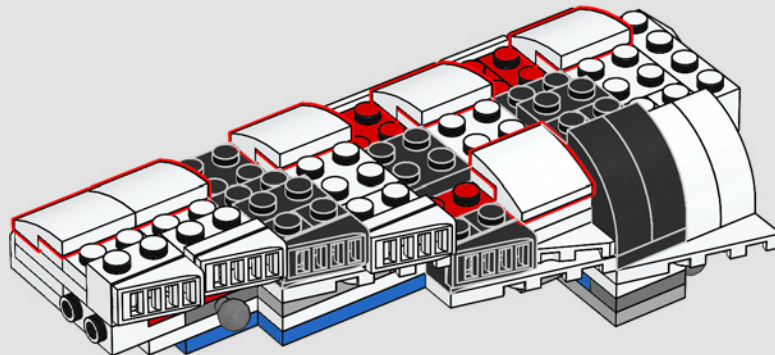

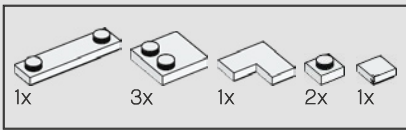

148

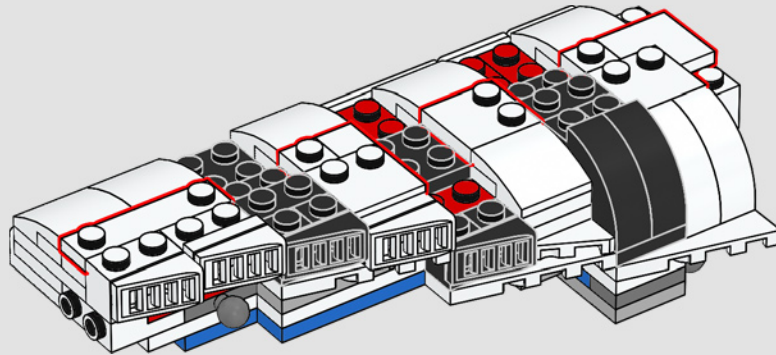

149

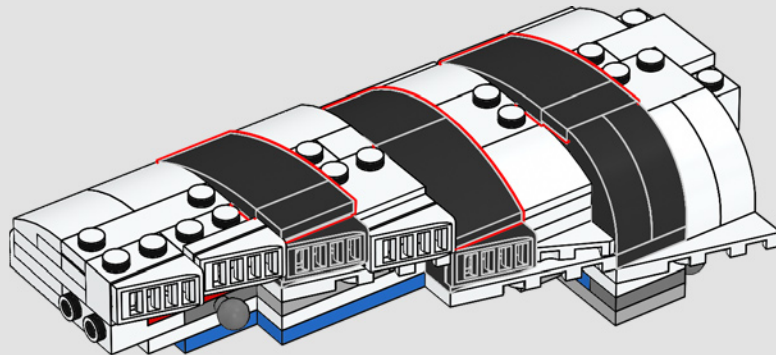

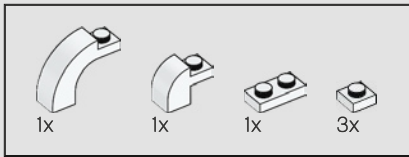

150

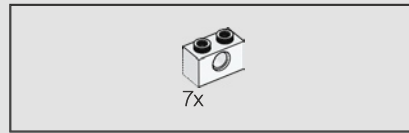
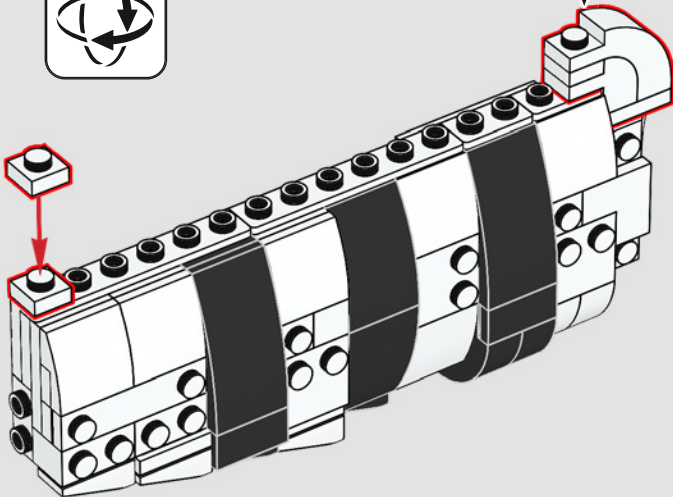
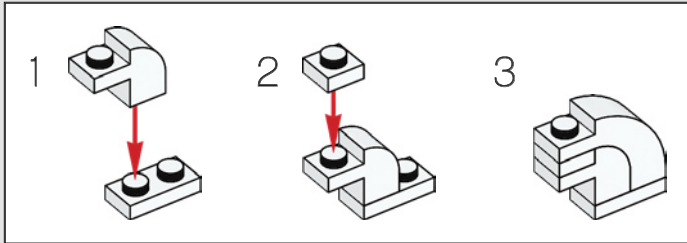

151

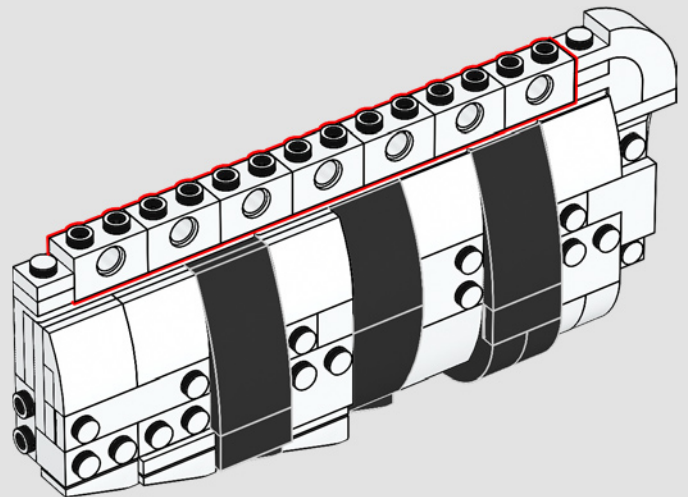

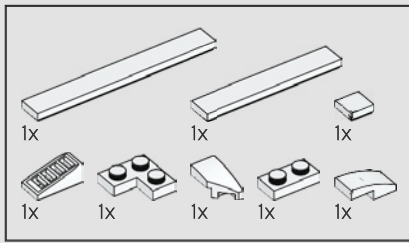

152

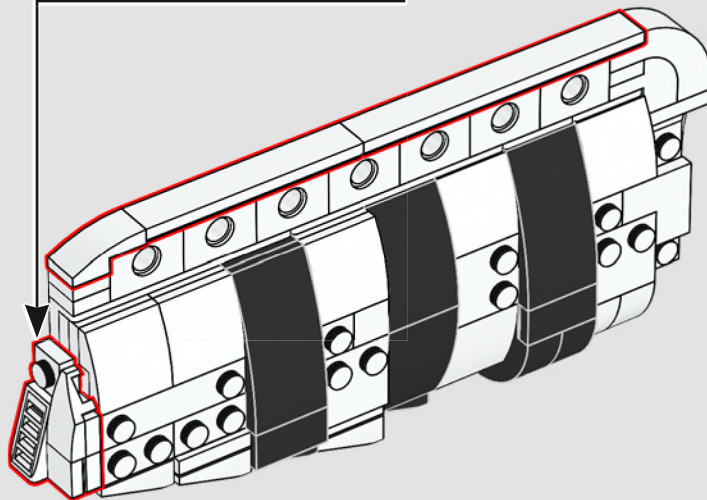
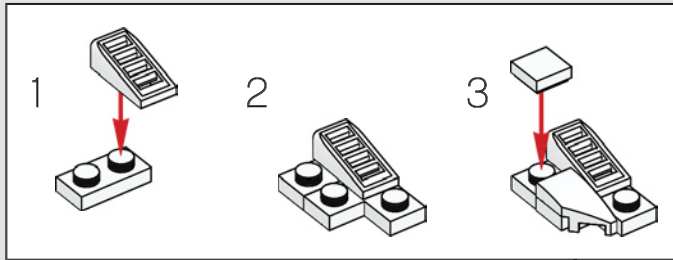



153

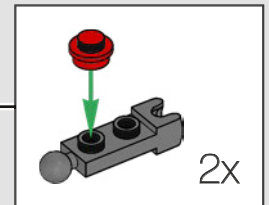
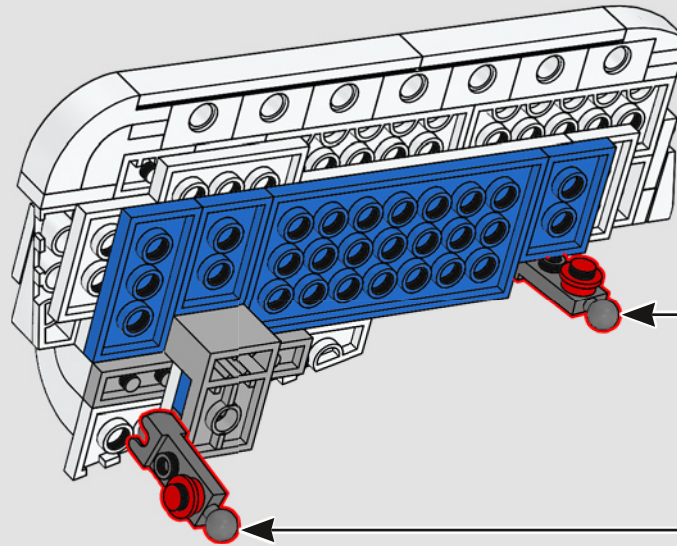

154

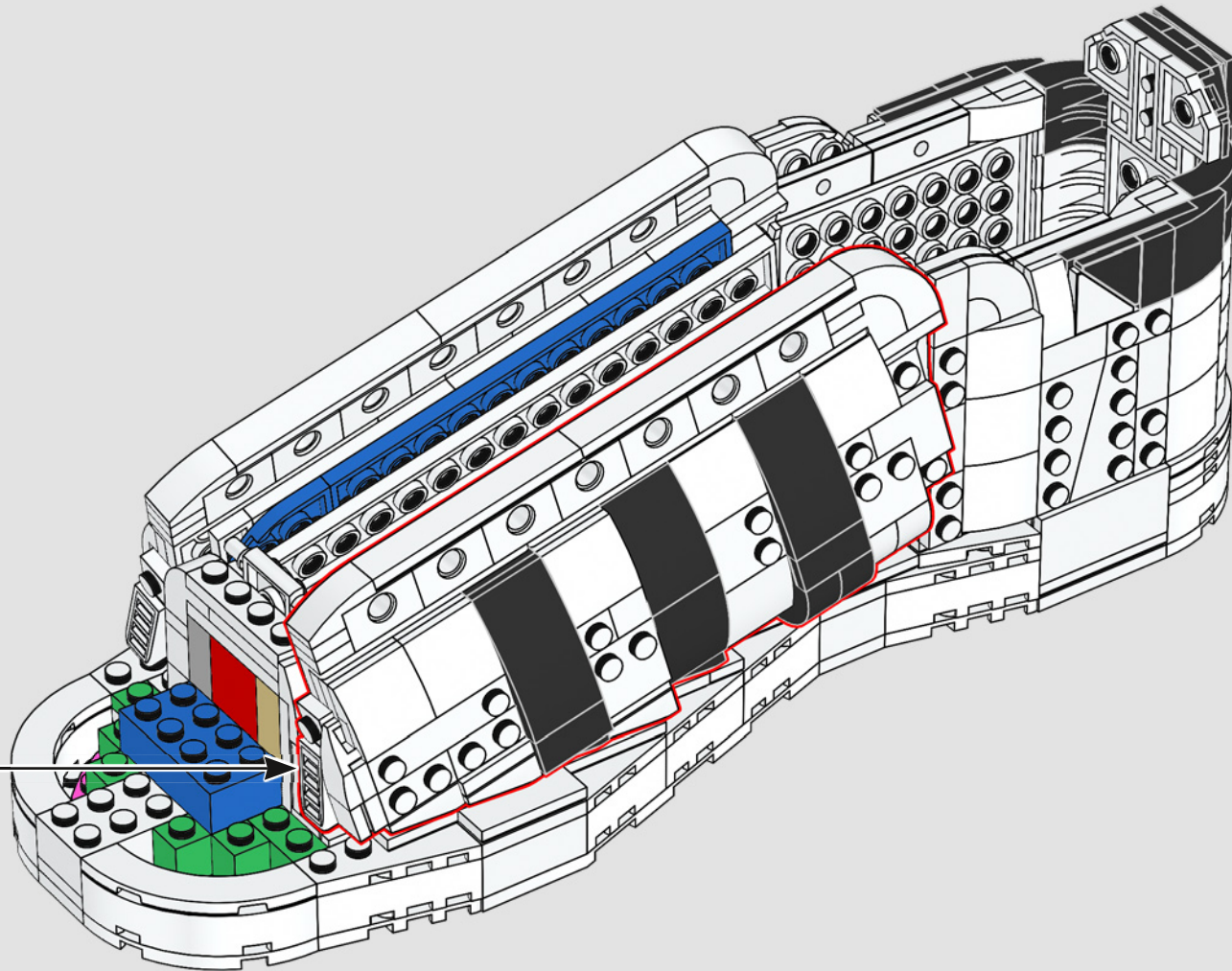

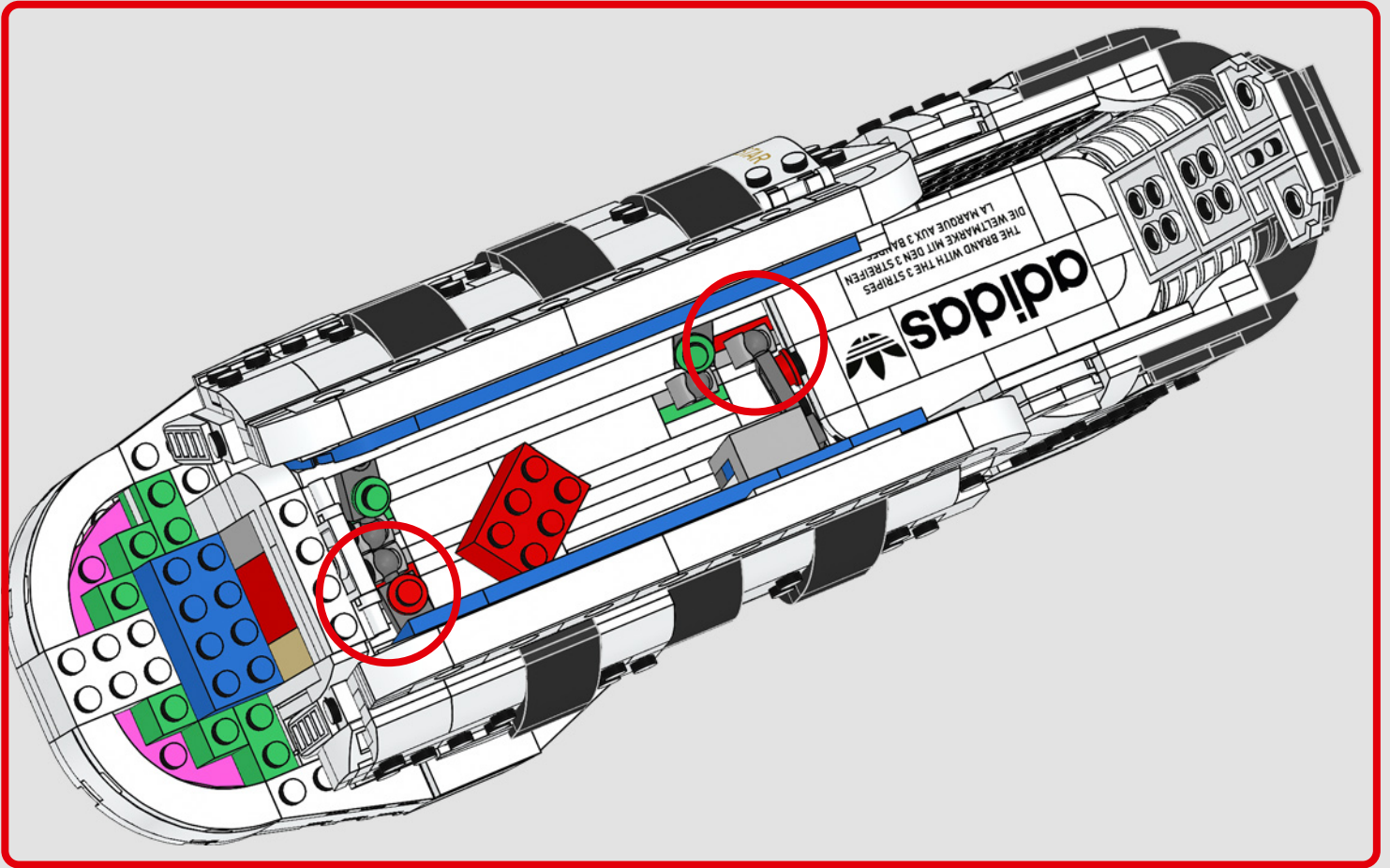

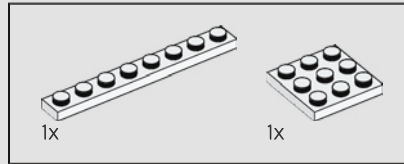
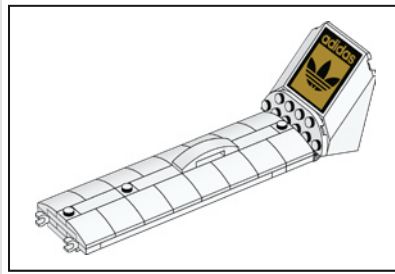
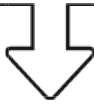

155

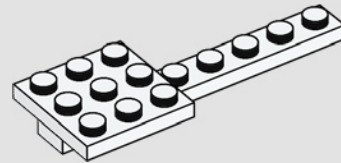

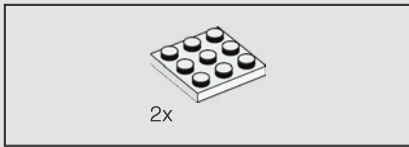

156

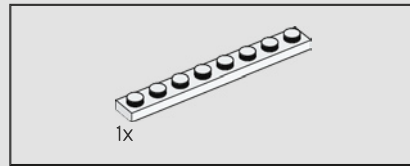
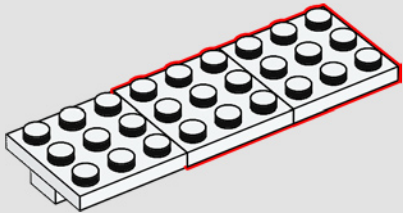

157

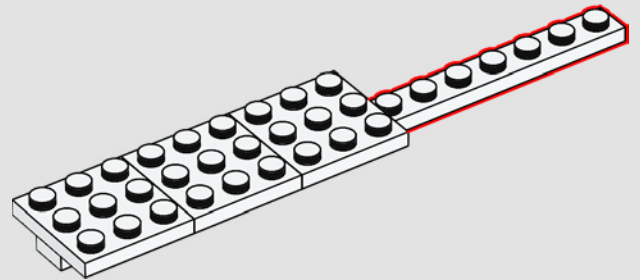

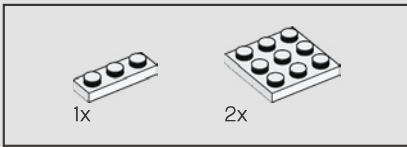

158

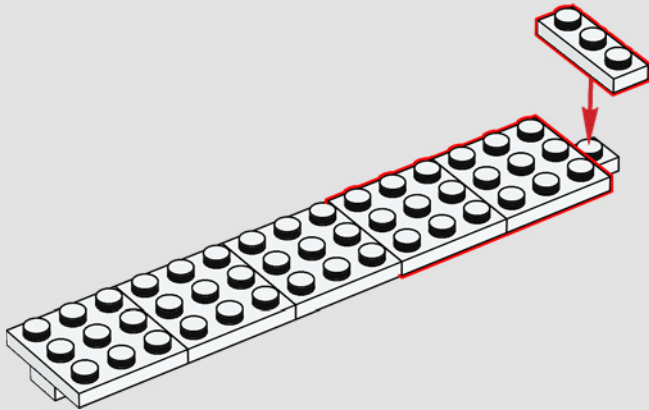

159

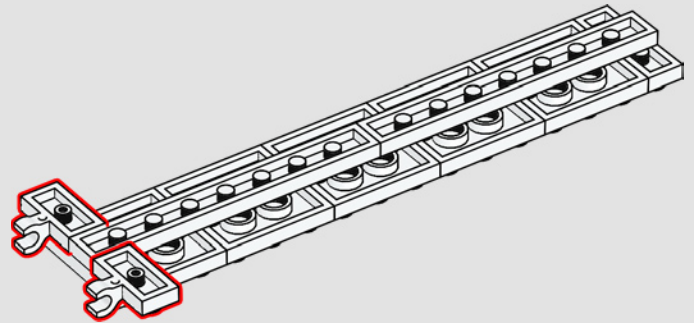

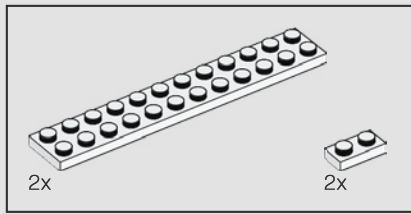

160

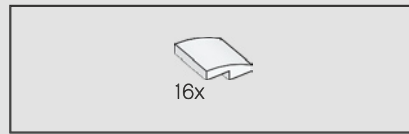
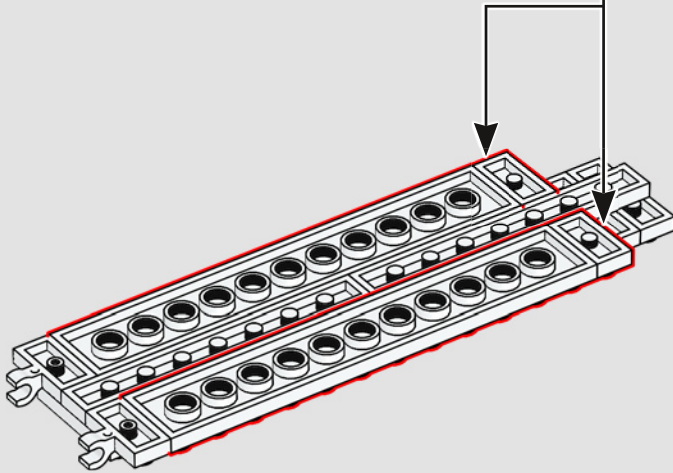
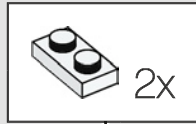

161

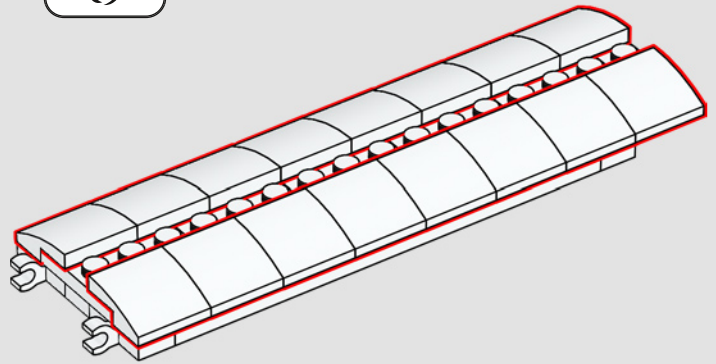

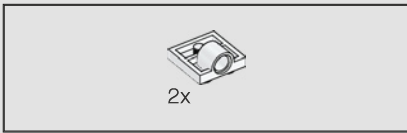

162

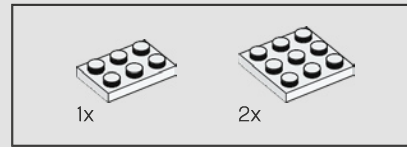
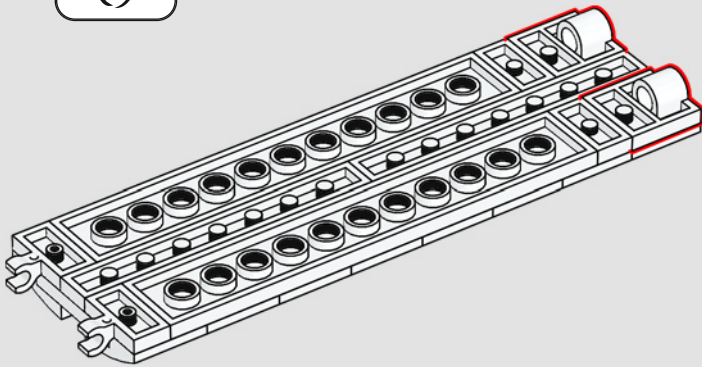

163

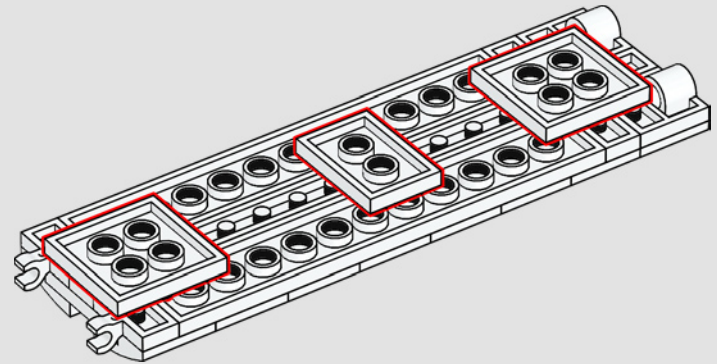

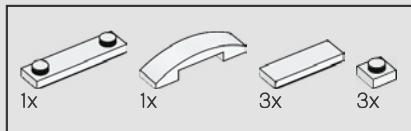

164

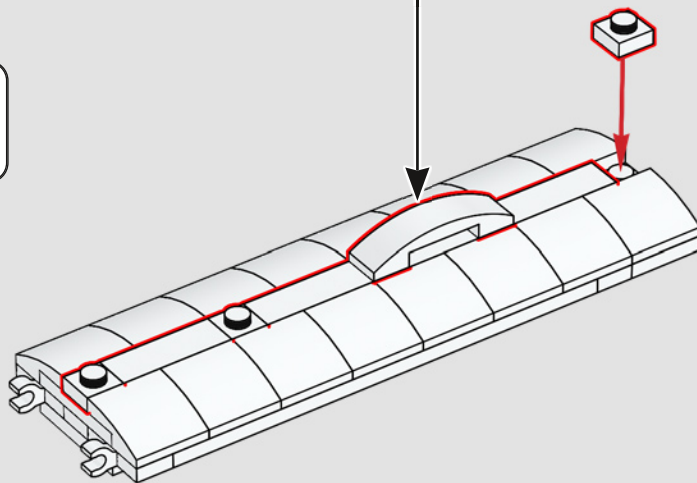
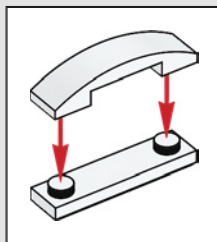

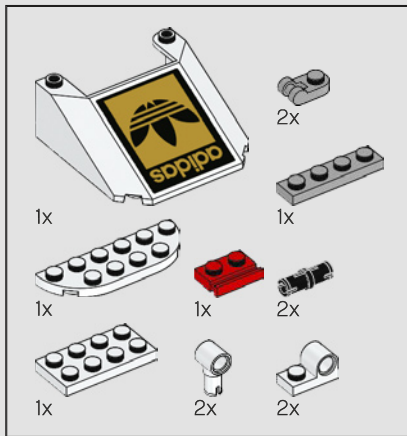

165

1

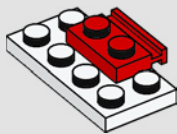

2

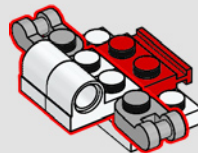

3

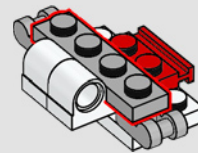

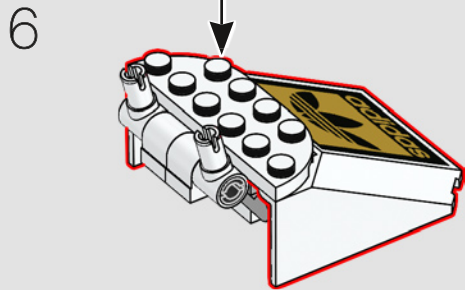
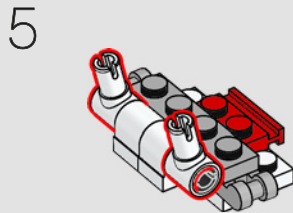
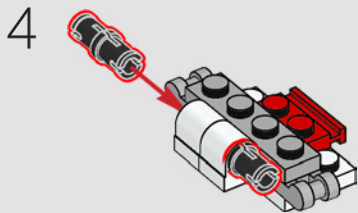

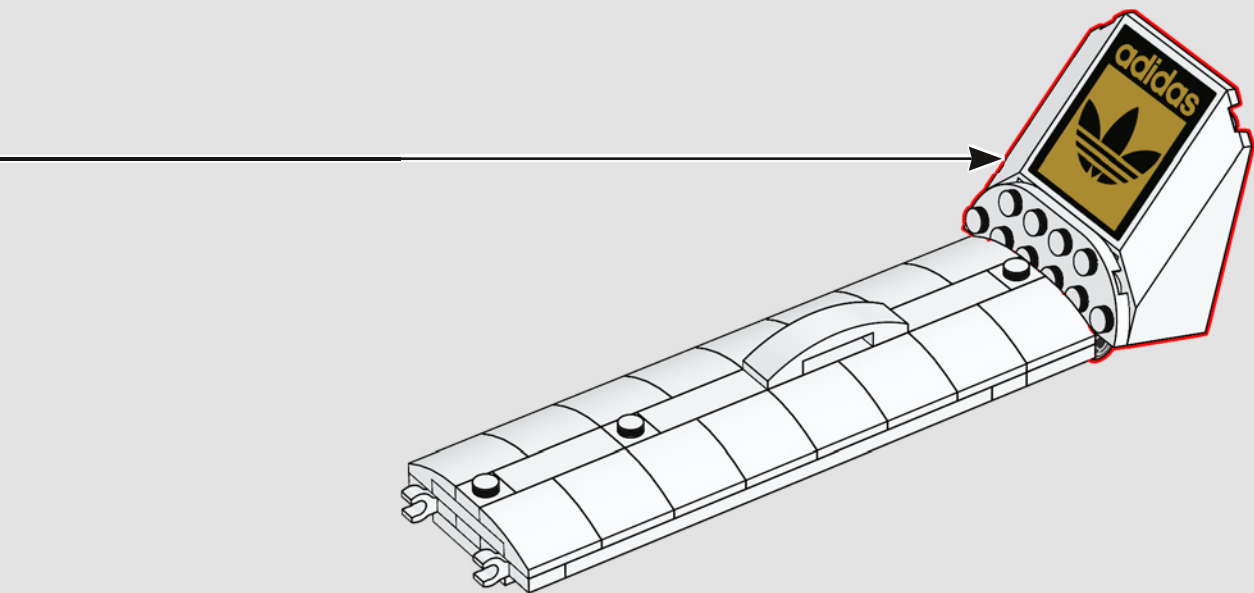

166

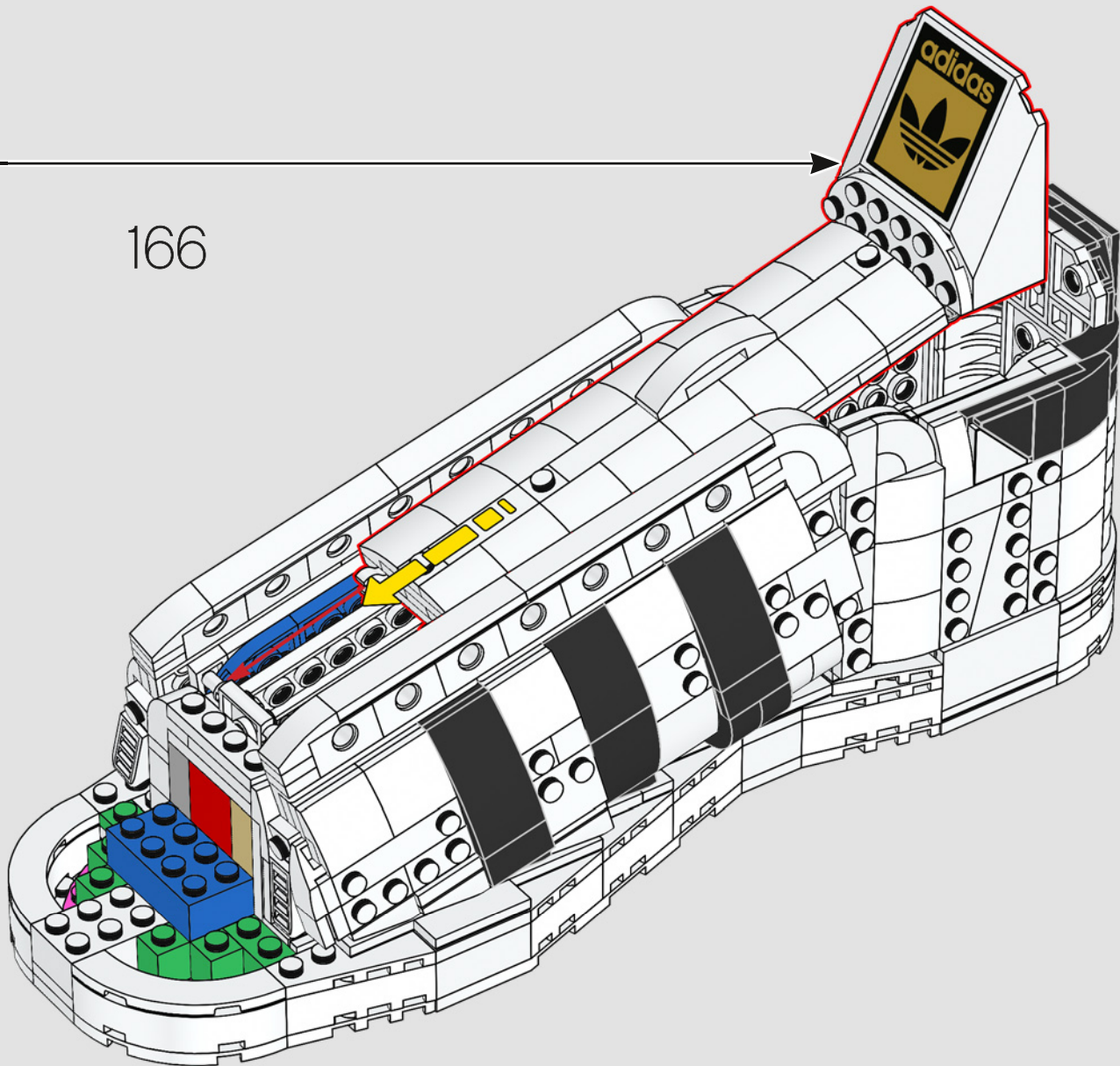

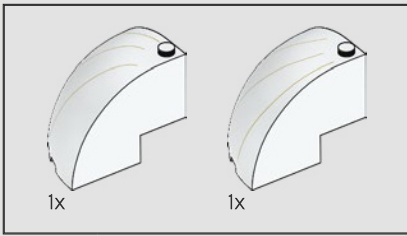

167

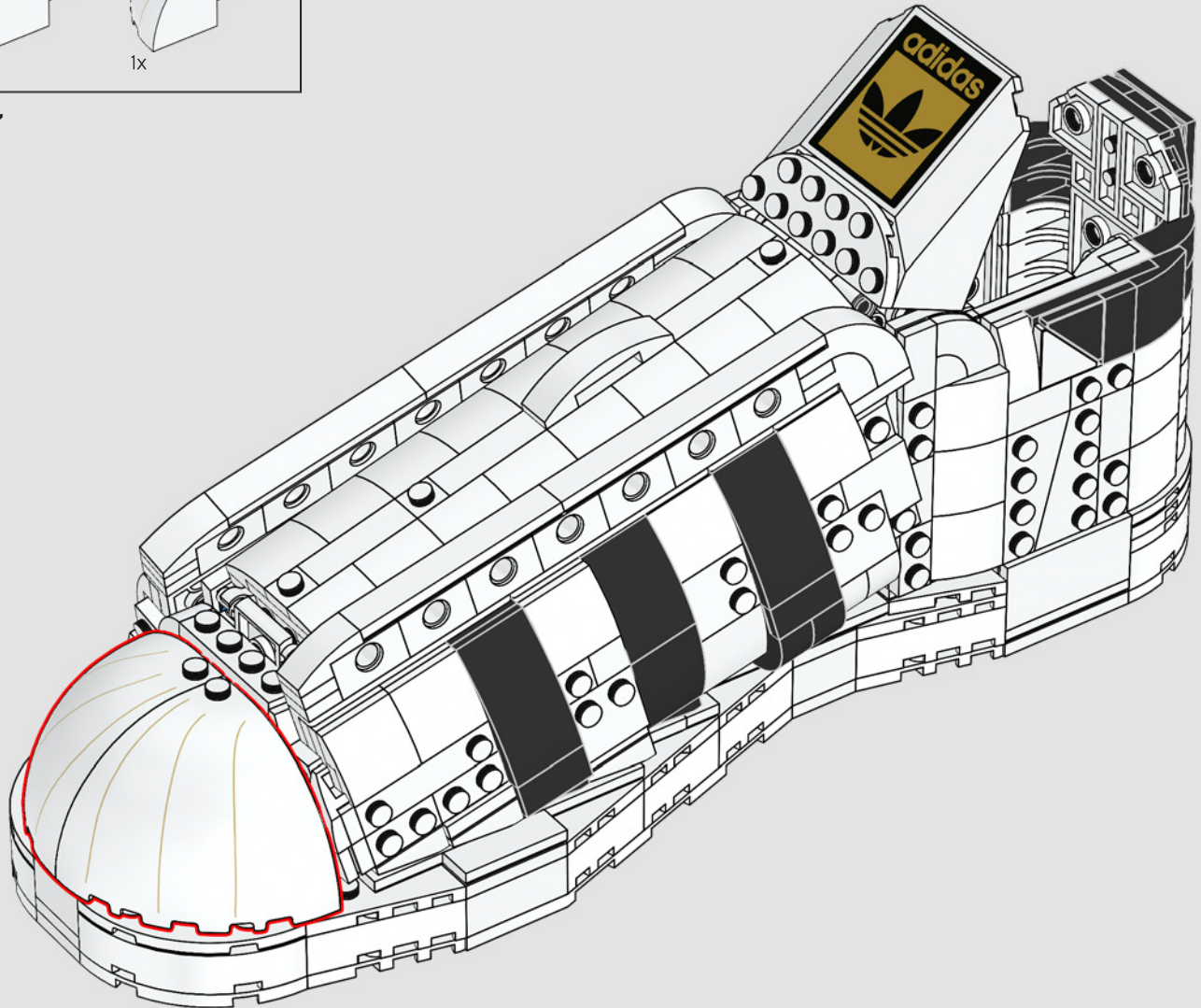



168

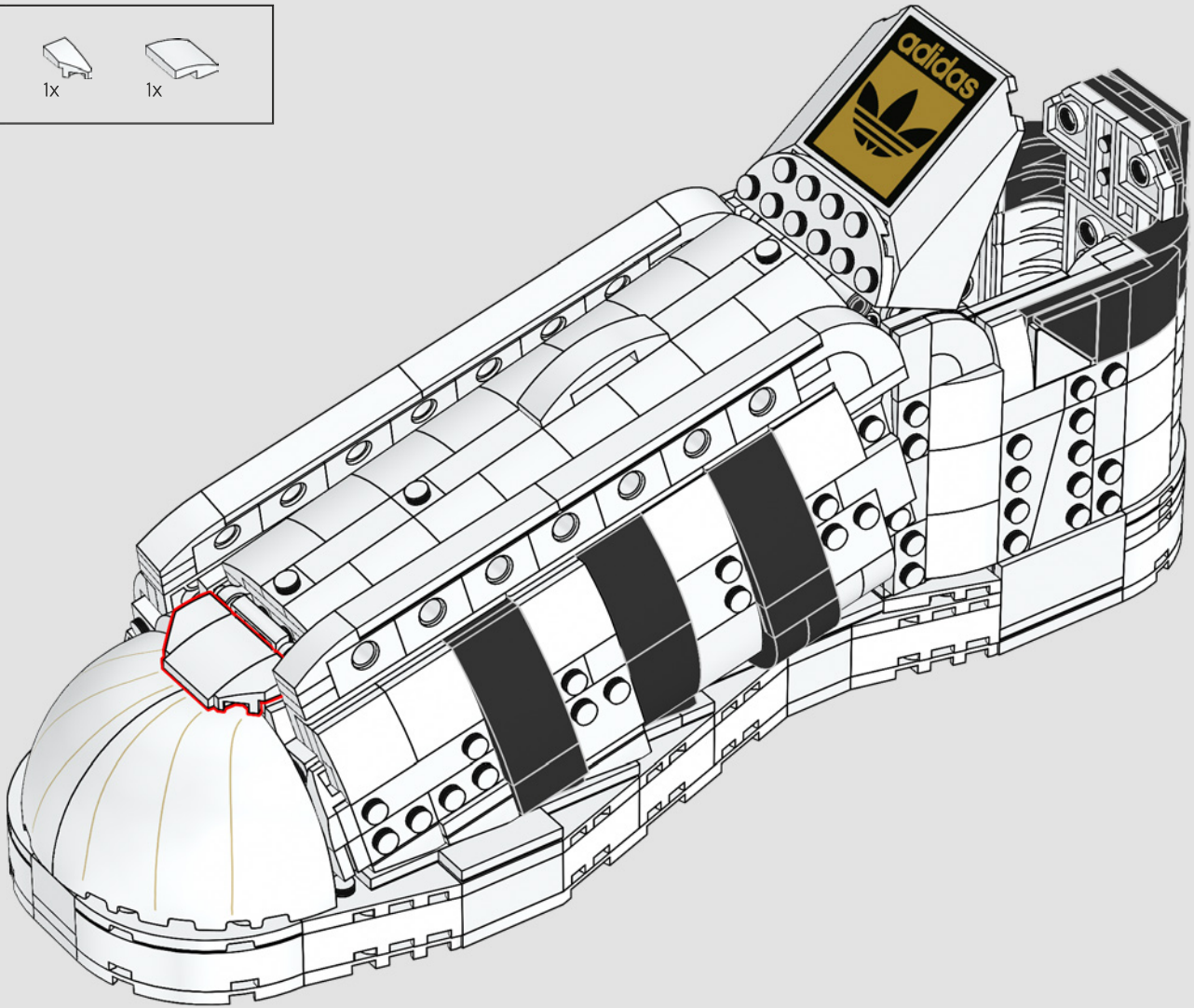

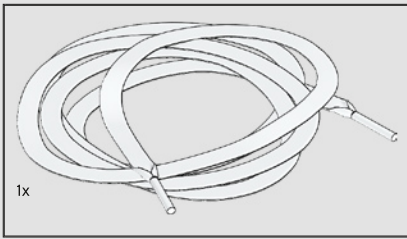

169

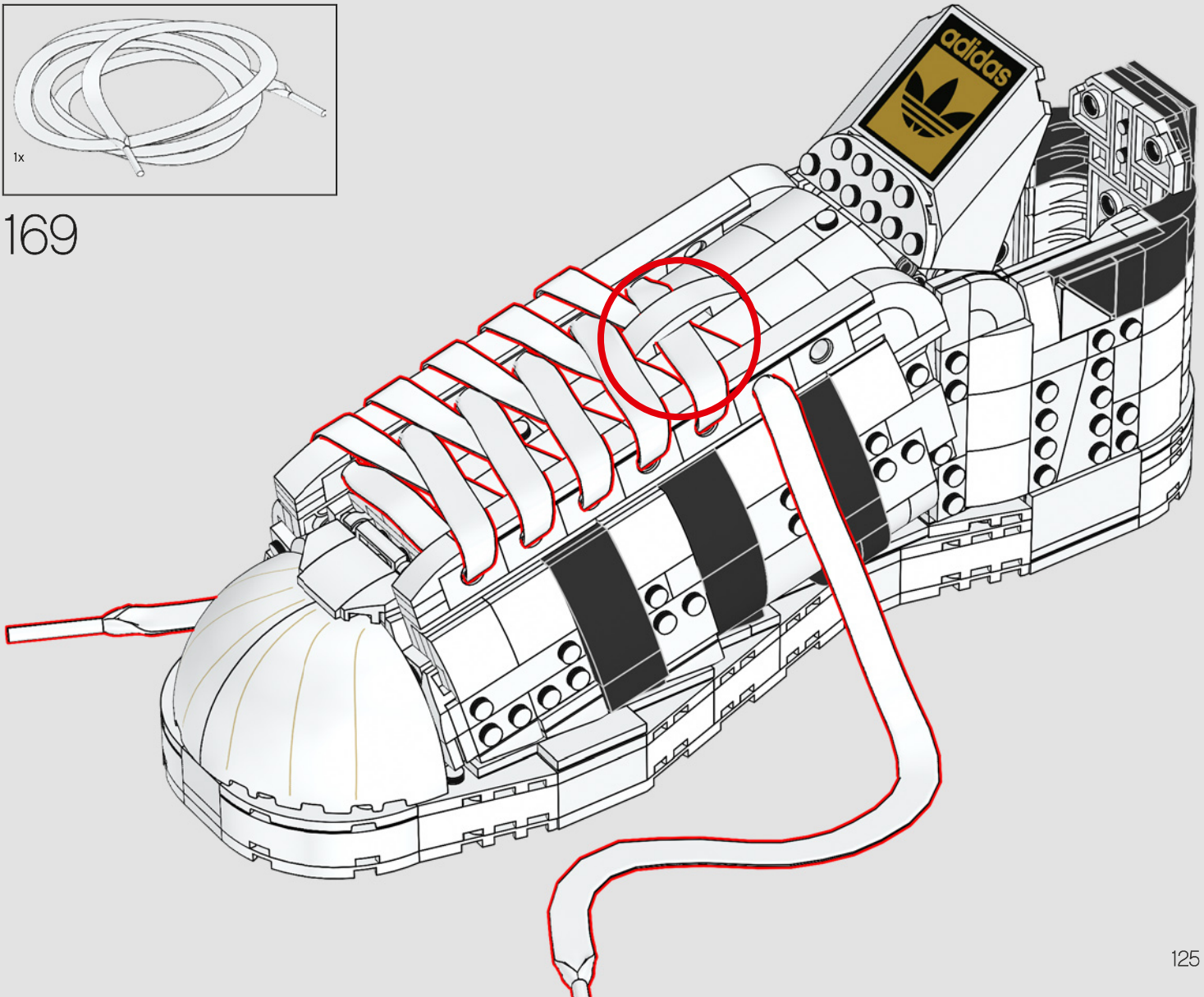

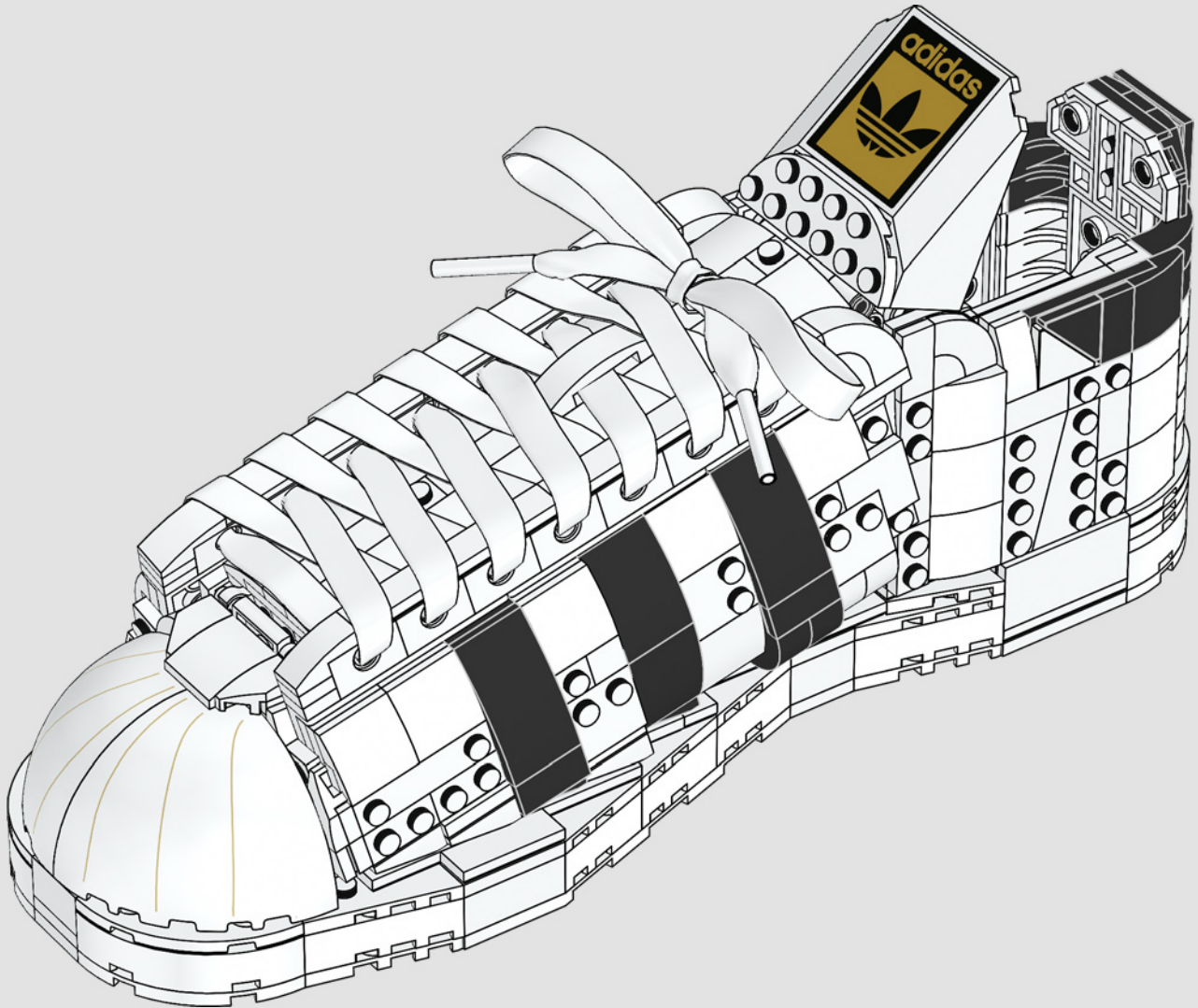

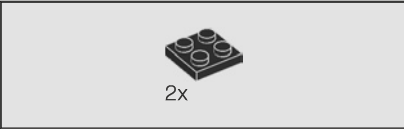

1

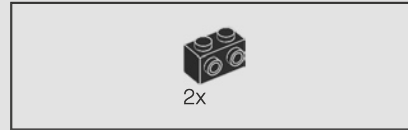
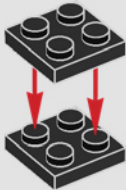

2

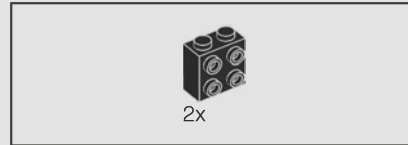
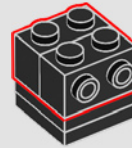

3

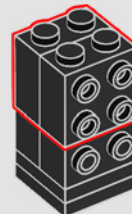

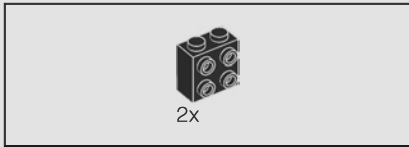

4

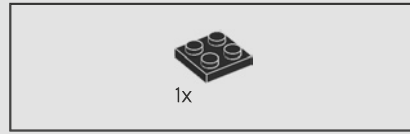
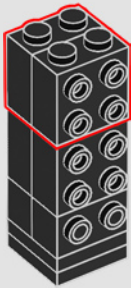

5

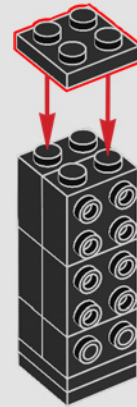



6

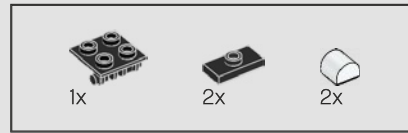
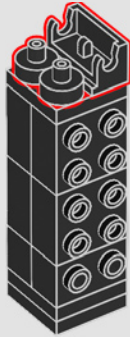

7

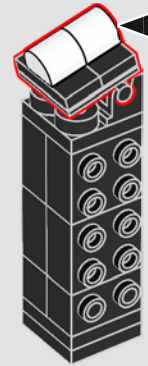
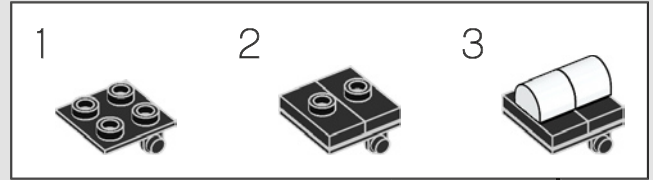

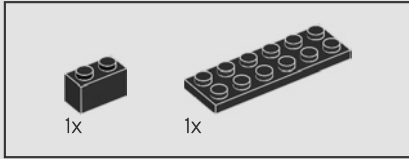
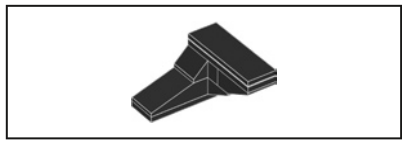

8

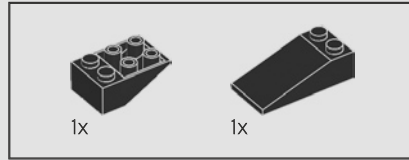
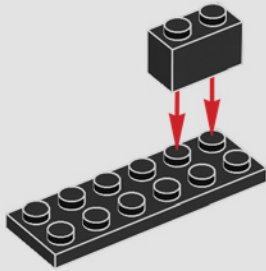

9

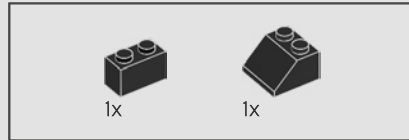
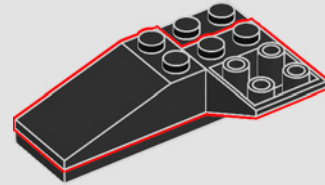

10

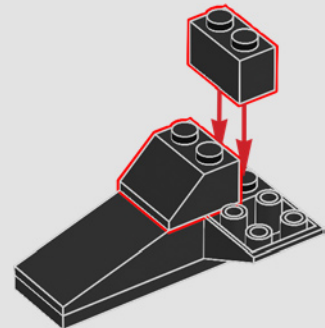

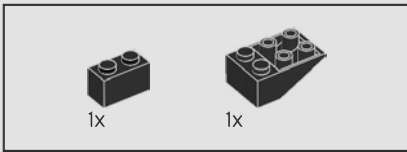

11

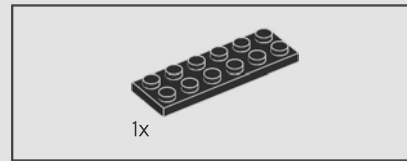
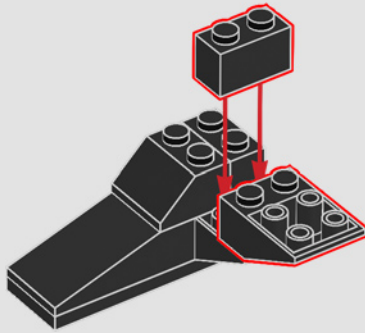

12

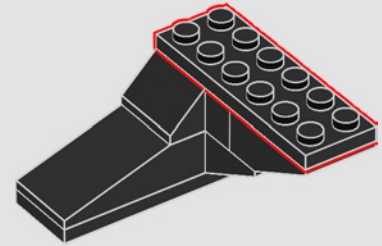

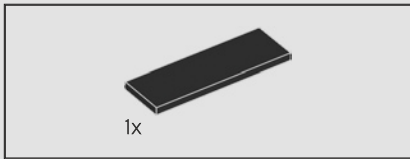

13

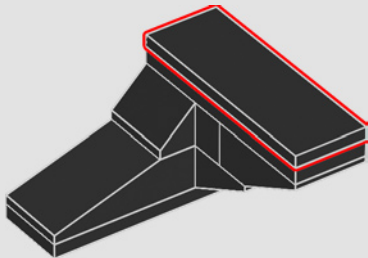

14

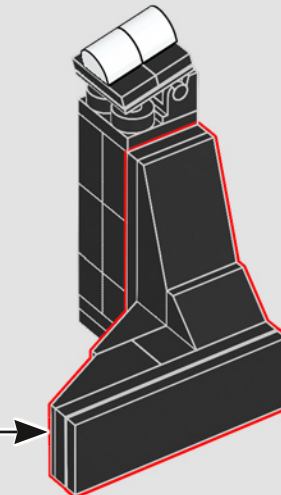

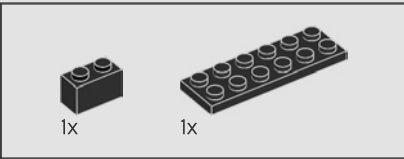
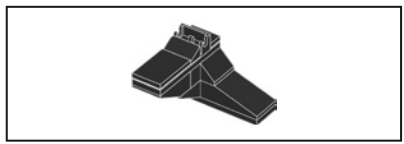

15

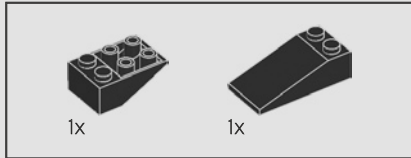
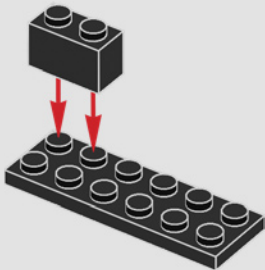

16

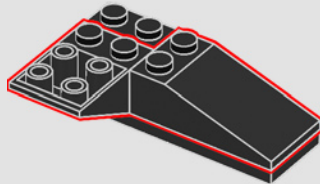

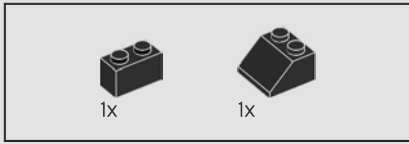

17

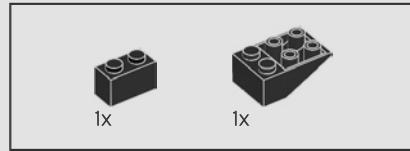
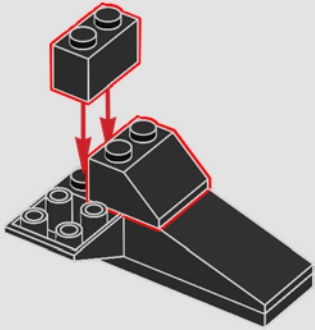

18

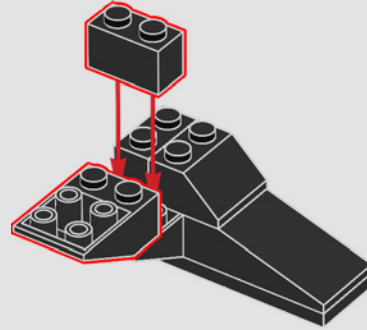

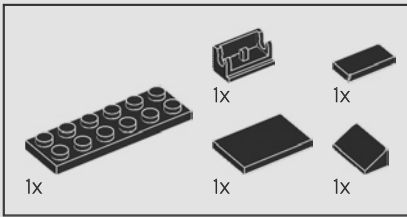

19

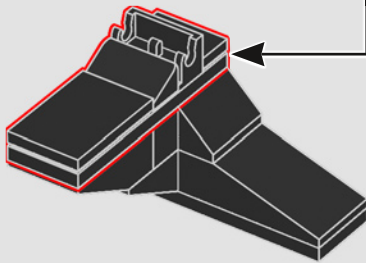
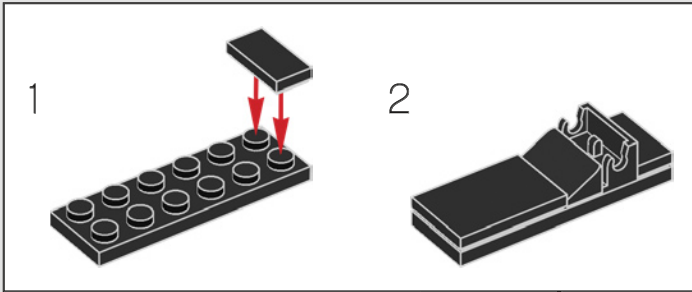

20

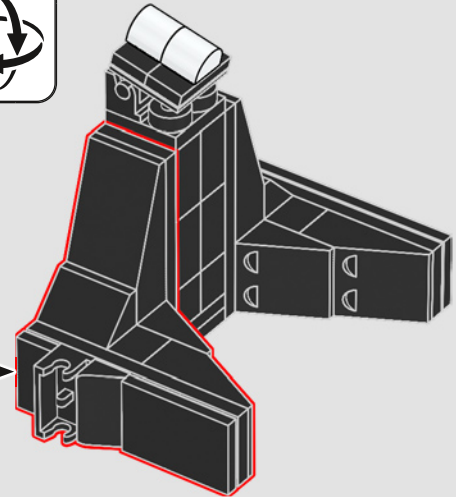

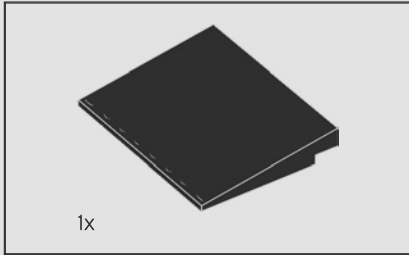

21

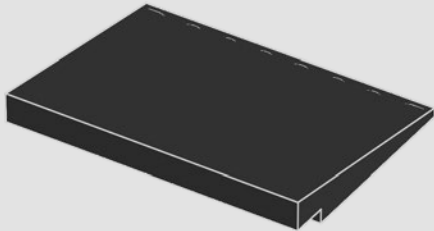

22

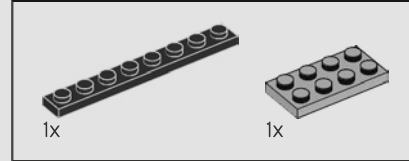

23

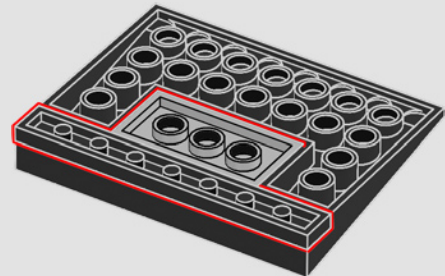

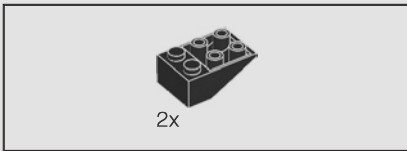

24

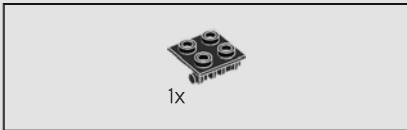
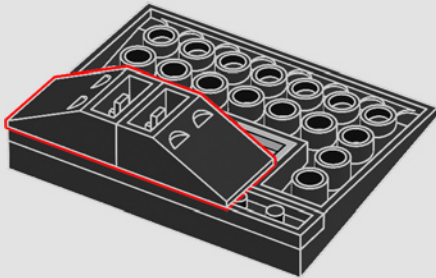

25

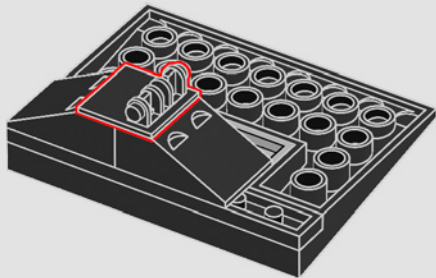

26



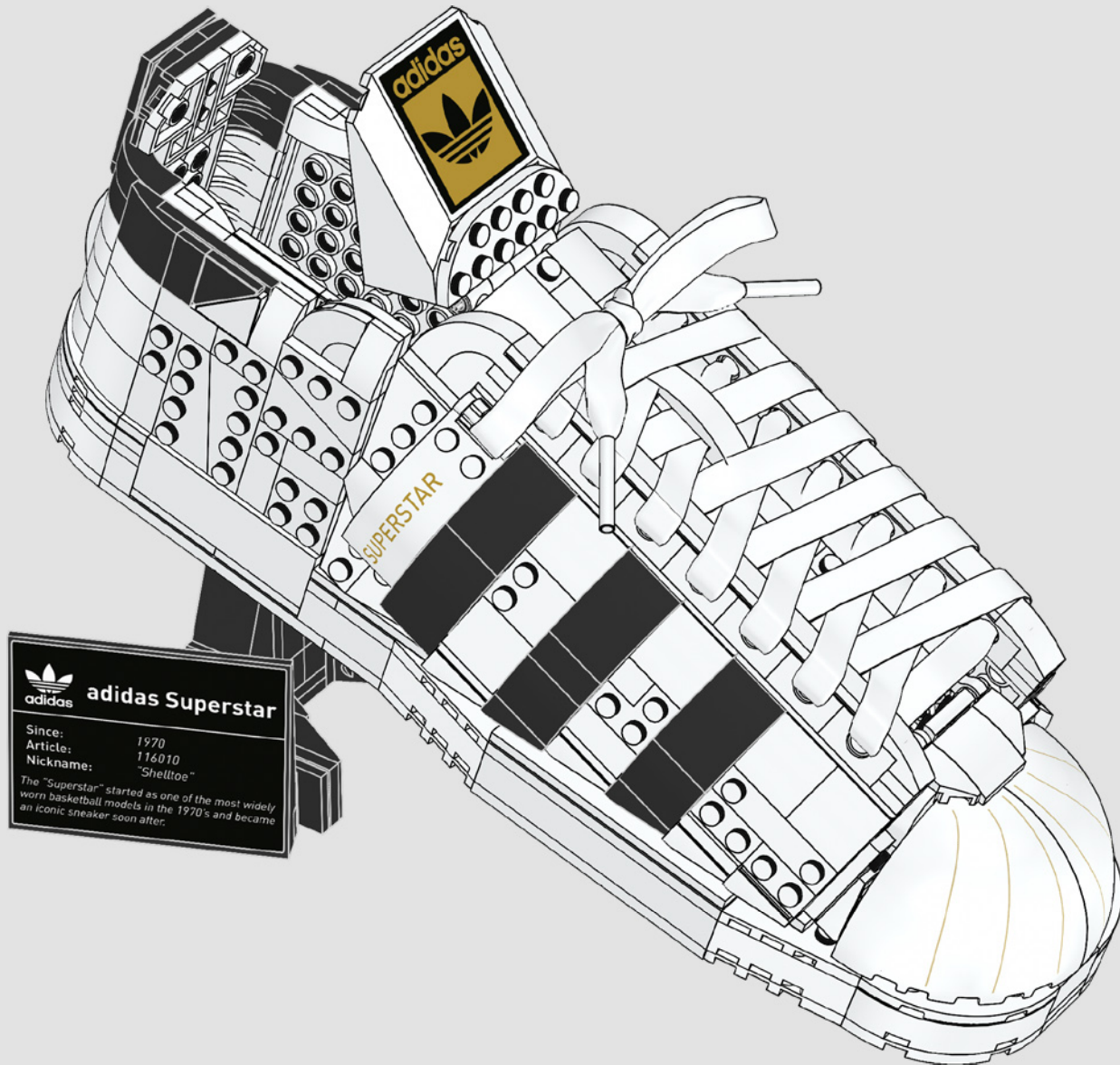

FROM RIGHT TO LEFT

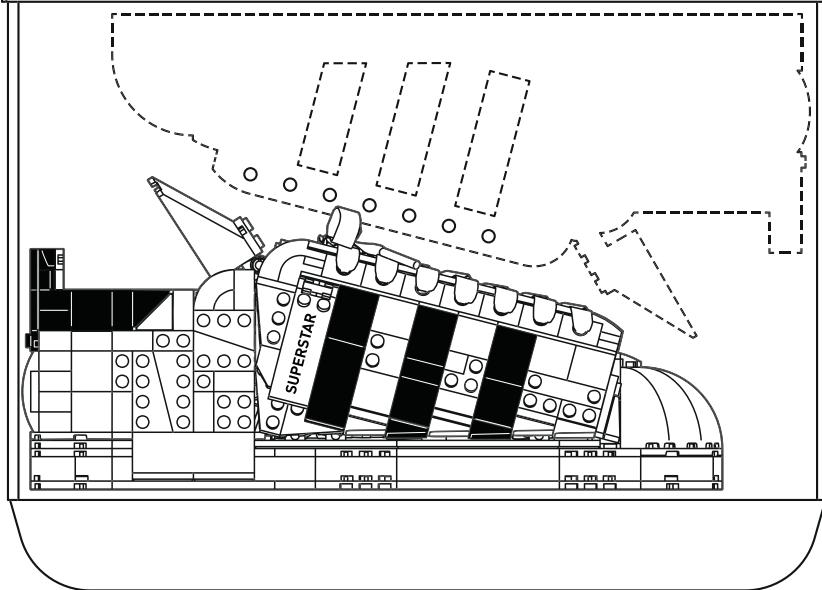

HOW TO BUILD A LEFT SHOE

The model is based on a right, size UK 7, EU 40 2/3, US 7 1/2 shoe. If you'd like to build a left shoe instead, simply download the building instructions at www.LEGO.com/service/buildinginstructions/10282 and use the extra elements already included in this set.

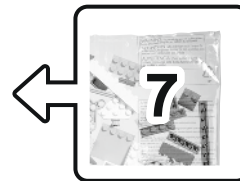

Download the PDF instructions for the adidas Originals Superstar left shoe build here: LEGO.com/service/buildinginstructions/10282



FEEDBACK AND WIN



FEEDBACK AND WIN

Your feedback will help shape the future development of this product series.

Please visit:

FEEDBACK UND GEWINNEN

Dein Feedback trägt zur Weiterentwicklung dieser Produktreihe bei.

Geh auf:

COMMENTEZ ET GAGNEZ

Vos commentaires nous aideront à concevoir les futurs produits de cette gamme.

Rendez-vous sur :

COMENTA Y GANA

Tu opinión nos ayudará a dar forma al desarrollo de esta serie de productos en el futuro.

Visita:

反馈有奖

您的反馈将有助于我们在今后改进本系列产品。

请访问：

[LEGO.com/productfeedback](https://www.lego.com/productfeedback)

By completing, you will automatically enter a drawing to win a LEGO® set.

Terms & Conditions apply.

Durch Ausfüllen nimmst du automatisch an der Verlosung eines LEGO® Preises teil.

Es gelten die Teilnahmebedingungen.

En envoyant vos commentaires, vous serez automatiquement inscrit(e) à un tirage au sort qui vous permettra de remporter un prix LEGO®.

Offre soumise à conditions.

Al contestar, participarás automáticamente en el sorteo y podrás ganar un set LEGO®.

Sujeto a Términos y Condiciones.

完成我们的反馈调查，即可自动进入抽奖环节，赢取乐高®套装。

适用《条款和条件》。

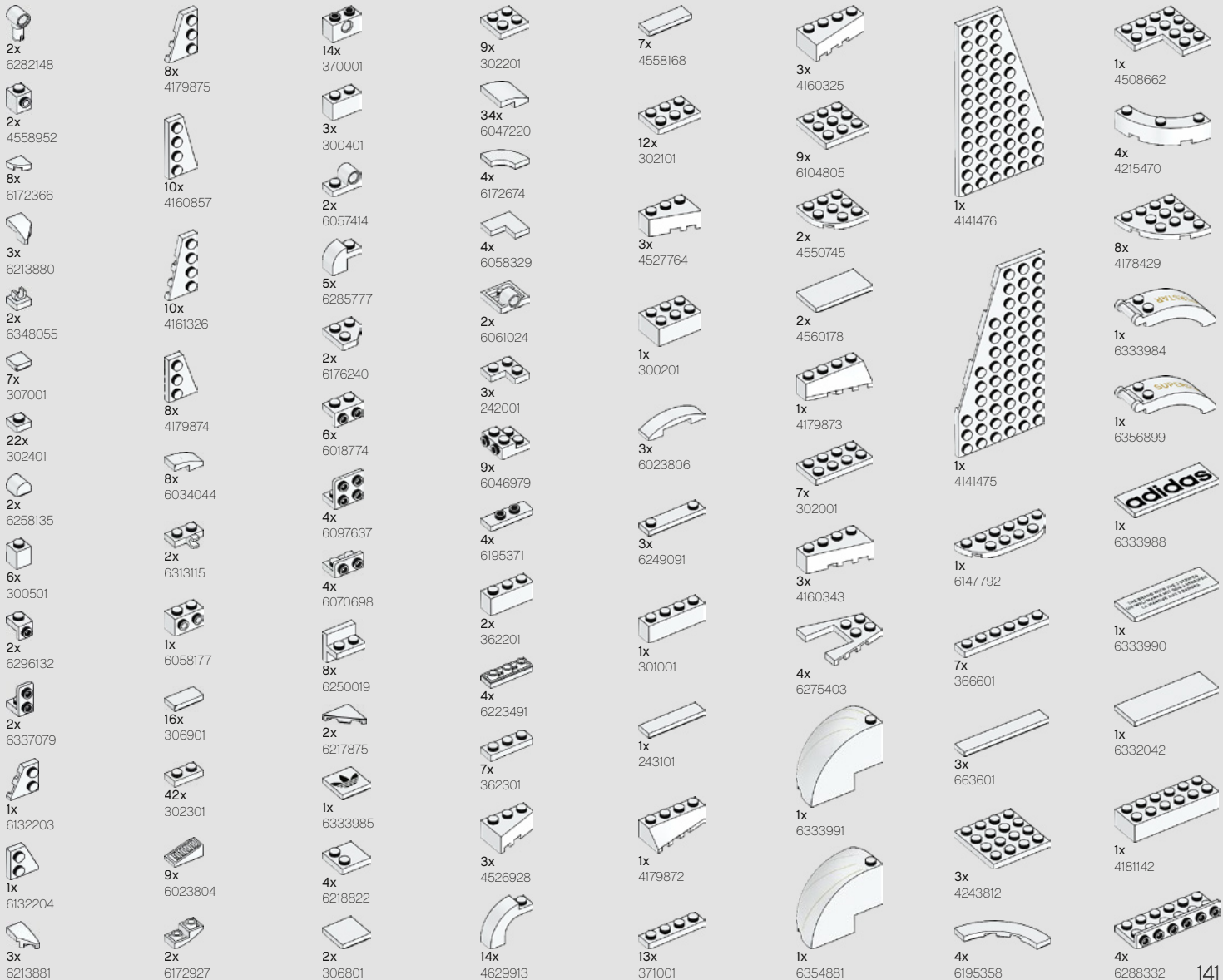

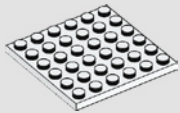

1x
4144012



1x
303501

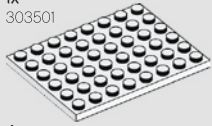

4x
303601



4x
4514842

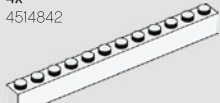

1x
611201

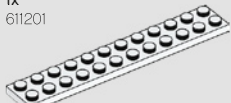

3x
244501

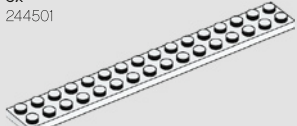

1x
4119227

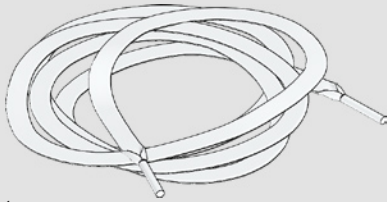

1x
6342961

142



1x
4599044



7x
346001



9x
416201

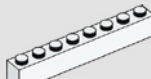

1x
300801



1x
303201

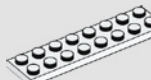

4x
303401

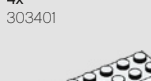

1x
6033776



1x
6354882



2x
614121



2x
302321



1x
306921



1x
6135130



1x
4612575



1x
6219819



1x
302221



1x
302121



1x
300221



2x
371021



2x
303221



1x
6256923



2x
4616342



2x
6186675



2x
4504382



1x
6181720



2x
302426



2x
6172383



4x
407026



1x
6181713



1x
4548180



2x
6279875



4x
4541191



6x
300426



2x
6092585



2x
6138173



4x
302326



2x
6184784



6x
306926



2x
393726



4x
6275806



2x
6214807



7x
302226



4x
6053077



2x
303926



2x
4124096



2x
6052126



6x
4618880



1x
6333986



1x
6333987



1x
6162892



5x
6147790



5x
302126



6x
374726



2x
371026



3x
302026



3x
4647286



2x
4185583

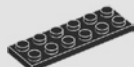

4x
379526



1x
6318582



1x
346026

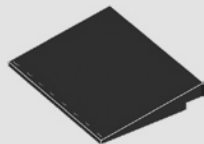

1x
4161067

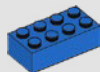

1x
300123



1x
346023



1x
447723

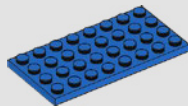

1x
303523



1x
4528850



1x
302423



7x
302323



2x
6266252



1x
302223



2x
362323



3x
302123



1x
371023



1x
4212411



1x
6288176



7x
4560180



3x
302023



1x
383223



1x
4528850



1x
383223



1x
6225242



2x
6225246



2x
6266209



1x
4211398



4x
6043656



1x
4211397



2x
4211445



2x
6015347



1x
4211395



1x
6171067



2x
4211438



1x
6232135



3x
4569058



2x
4107736



7x
302328



1x
6352550



3x
4125281



2x
4109679



2x
302128



1x
4112838



3x
371028



1x
302028



2x
383228



1x
4106356



1x
366628

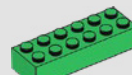

2x
4181135



2x
6092583



1x
366624



3x
6039479



1x
6123814



1x
4210635



1x
4211133



4x
6039482



1x
4211043



1x
4521572



1x
4210802

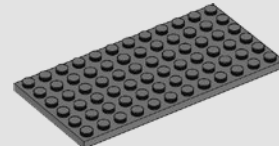

1x
4256149



1x
6134869

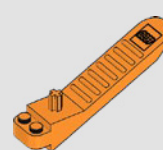

1x
6240515

Customer Service

Kundenservice

Service Consommateurs

Servicio Al Consumidor

LEGO.com/service or dial



: 00800 5346 5555

: 1-800-422-5346

