

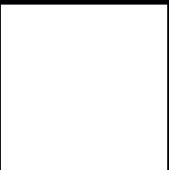

Camaro Z/28 1969



Booklet available in English on
Heft in deutscher Sprache erhältlich auf
Livret disponible en français sur
Libretto disponibile in Italiano su
Folleto disponible en español en
如需中文版手册, 请访问





We've got a mean streak.

Z/28 Camaro.

The '69 Z/28. So ominous it goes by its code name. Code name: Z/28. Standard equipment: mechan-

ical lifters, high-performance cam and an aluminum intake manifold under a massive Holley 4-barrel.

Underneath: multi-leaf rear springs and heavy-duty shocks. New '69 are special white lettered tires on 15 x 7-inch wide wheels and a Hurst shifter

for the 4-speed. To complete the setup, just add the new 'Vette-type 4-wheel power disc brakes.

By now you know the mean streak isn't just painted on—it's built in. One more thing. People are

bound to ask what the Z stands for. Tell them "Zepherus." **Putting you first, keeps us first.**

THE SPORTING COUPE

Affordable, sporty and stylish, "Pony Cars" revolutionised the auto industry when they first appeared in the mid-1960s. A new, younger generation of drivers were instantly attracted to the streamlined body lines with long hoods and powerful engines. Though almost all car manufacturers would introduce their own interpretation of the pony car, few would have as much success as Chevrolet with the iconic Camaro.

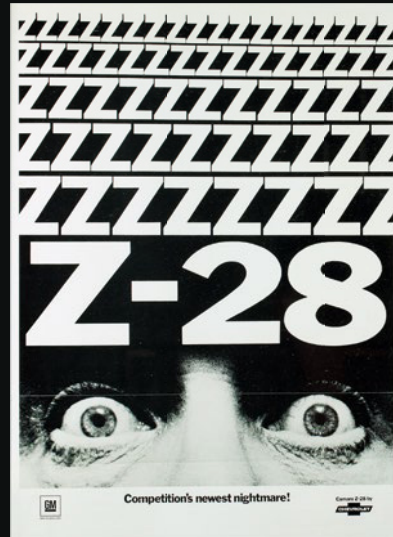

Competition's newest nightmare!

**The skier's skier
with the Camaro's Camaro.**



There are skiers. And then there are *skiers*. Jean-Claude Killy is one of the latter.

The Camaro Z/28 is a special breed, too.

It comes poised on a beefed-up suspension and special road-grabbing wide oval tires.

Under that striped hood is a tough 302 V8 that inhales through a big Holley 4-barrel and exhales through dual exhausts.

Z/28

Add four-on-the-floor with a Hurst shifter plus 4-wheel power disc brakes and you've got the closest thing to a 'Vette yet.

Z/28. In our Sports Department. Almost as much fun as skiing.

Putting you first, keeps us first.

CHEVROLET

See Olympic Gold Medalist Jean-Claude Killy, *Sunday*, CBS-TV. Check your local TV listings.

69 CH-43 A
Ski February
Skiing February
1 page-4 colors
A-P 7729-11-21-68-5



A ROARING SUCCESS

The second-generation Chevrolet Camaro Z28 remains the essence of the perfect Muscle Car. Launched in 1969, the signature "cowl induction" power bulge hood and speed lines stamped into the fenders and doors ensured it was original and distinctive. It refused to borrow from any other auto designs at the time and over 50 years later, it still looks both fresh & bold.



camaro

Camaro

CAMARO



1967 – 1969

1970 – 1981

1982 – 1992

A MOTORING ICON

Though it's 55 years since the first Chevrolet Camaro launched, this famous marque is still very much alive and relevant, with the sixth generation of this iconic vehicle in production today. It's a brand and a name that continues to reach across different generations, beloved by hard-core Muscle Car enthusiasts and featured in countless Video Games, TV shows, Movies and pop culture.

CAMARO

CAMARO



1993 - 2002

2010 - 2015

2016 -



FROM THE DESIGN TEAM

"I grew up with a strong passion for cars and started flipping through hot rod magazines at a very early age, so being able to work on this LEGO® model with real Chevrolet car designers was a dream come true. One thing was getting the overall styling and stance right, but we also wanted to add in those fun but essential details like functioning doors and working steering. It was also great to be able to offer some customisation options just like the original Camaro did back in the day."

Sven Franic, LEGO® Designer



YOUR MODEL. YOUR CHOICE.

One of the most popular features of the original Camaro was the offer of a wide range of personalisation options and high-performance engines. Likewise, it's up to you to decide how you want to style your LEGO® version of the car: should it be a hardtop Coupe or a cool Convertible? And what about the striping? Classic white, subtle grey or a stand-out red? There are also optional covers for the headlights and two number plates to choose from.



The three models cannot be built simultaneously.

You can find the instructions to these alternate models online at:
[LEGO.com/buildinginstructions](https://www.lego.com/buildinginstructions)



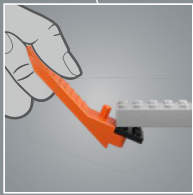
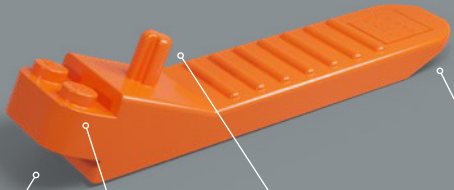
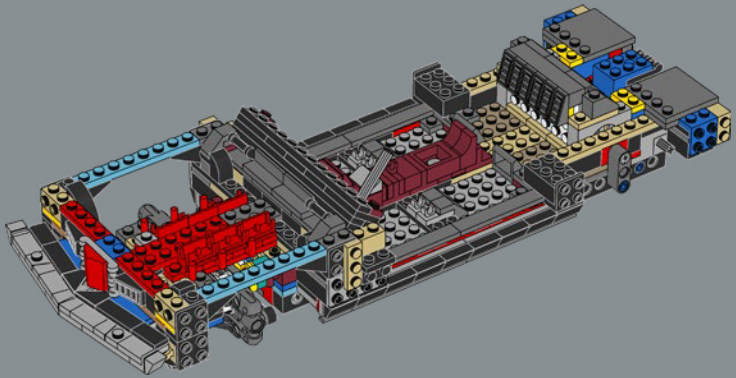
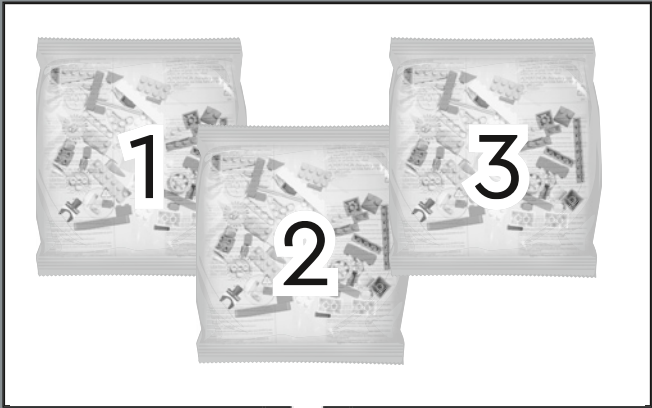

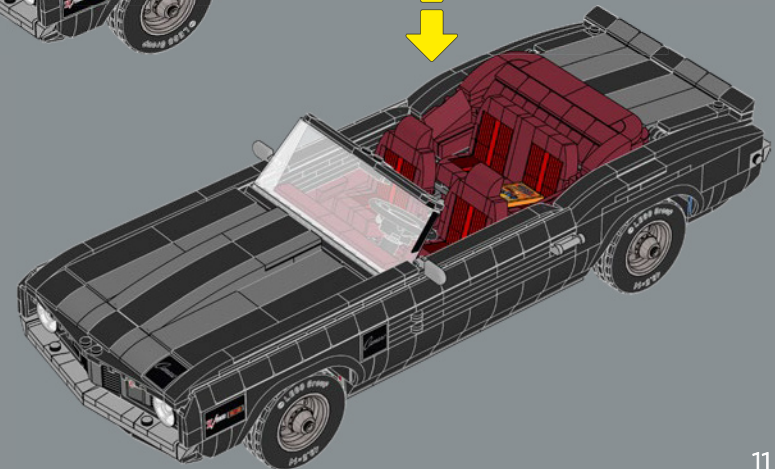
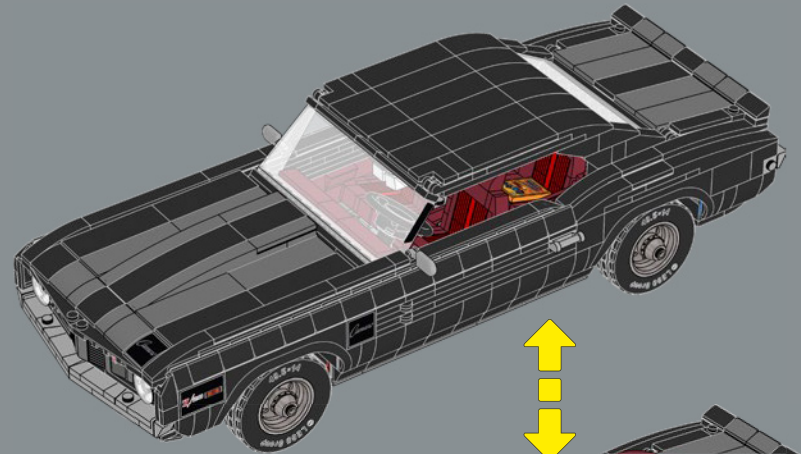
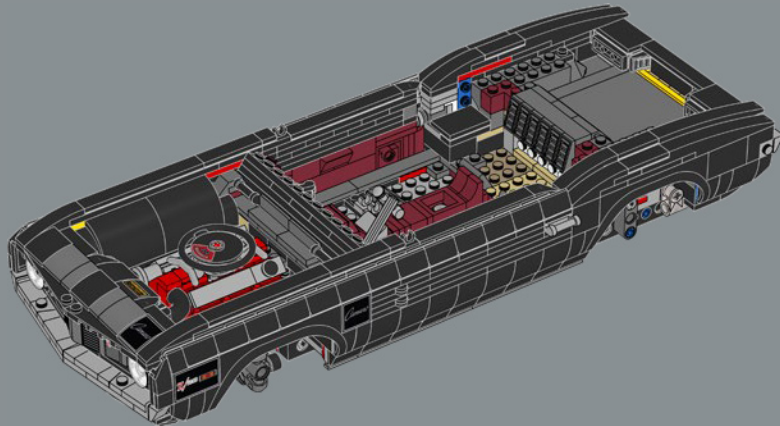
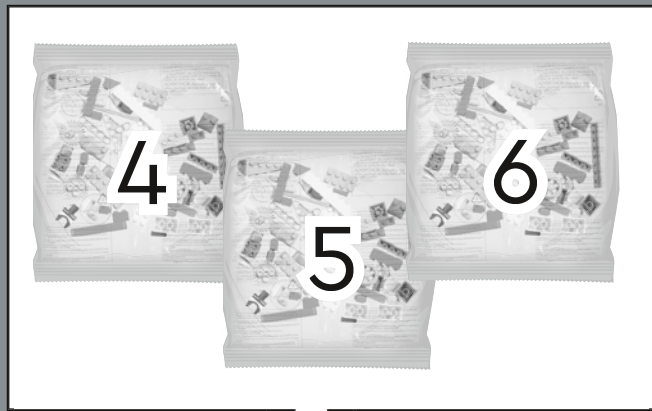

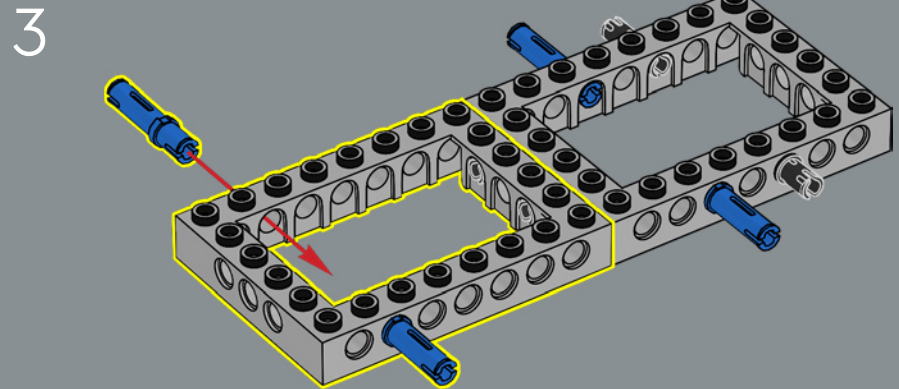
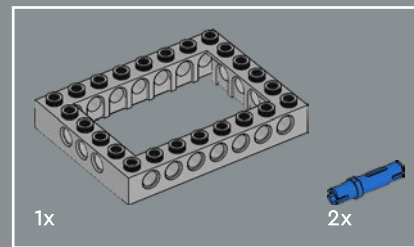
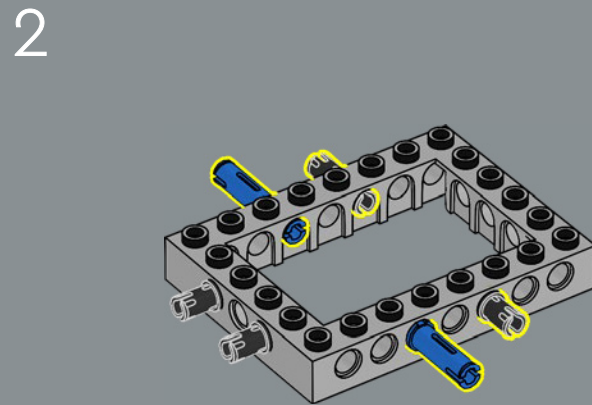
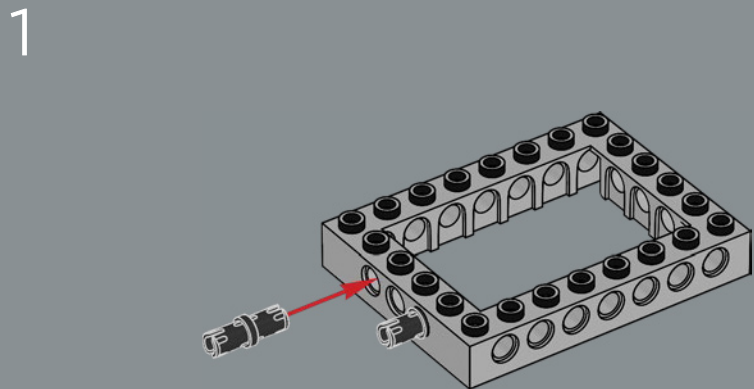
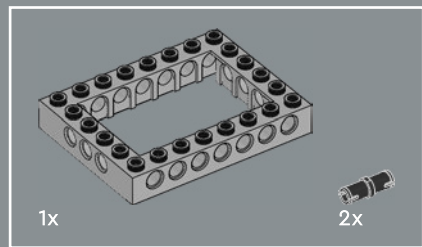

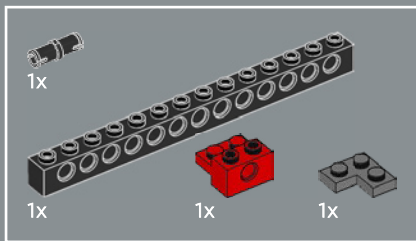

4

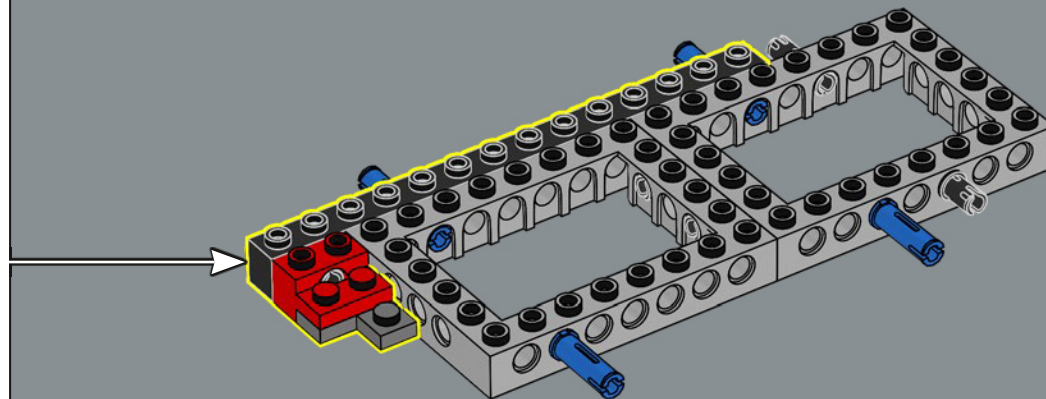
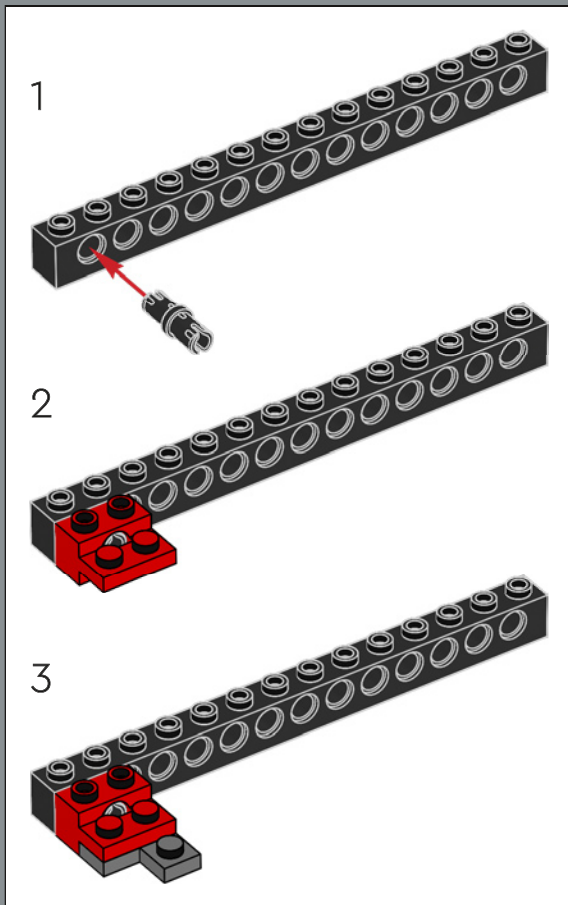

The Camaro name fit with the Chevrolet tradition of starting most of their models with the letter 'C' (Corvaair, Corvette, Chevelle, etc.).

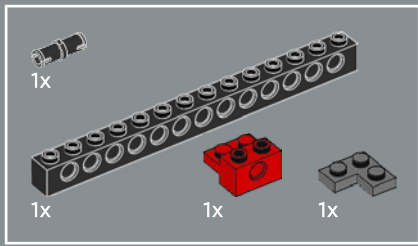

5

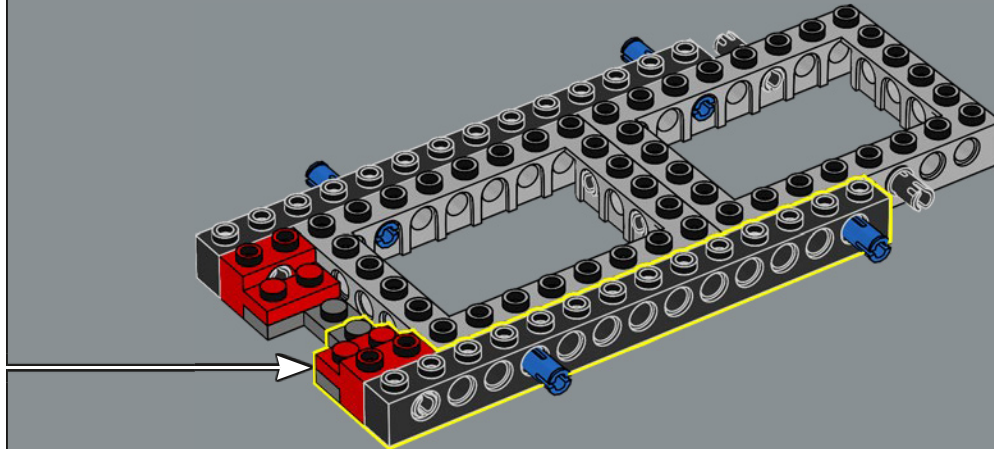
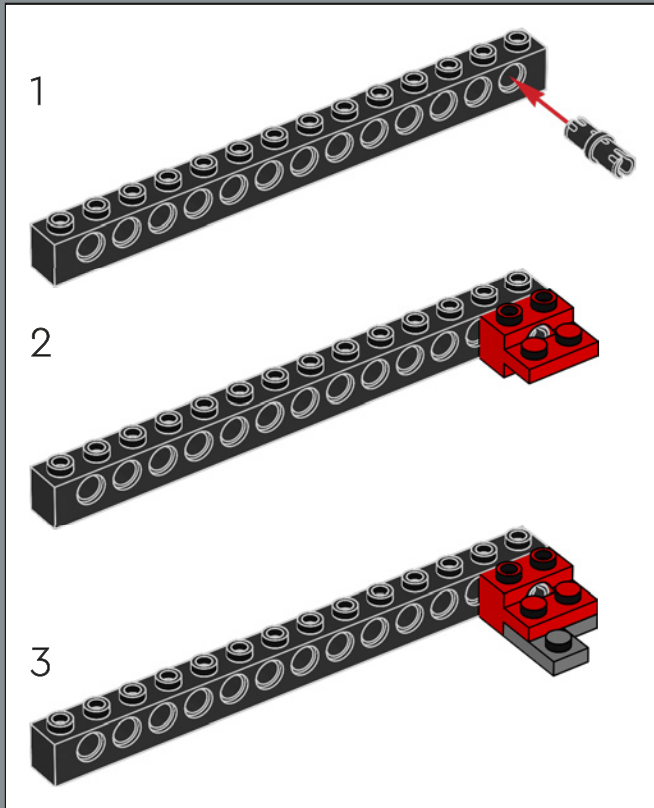

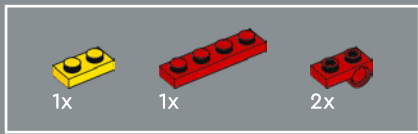

6

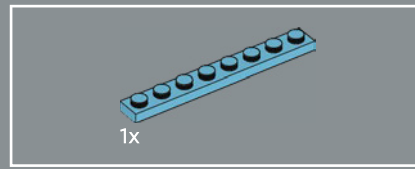
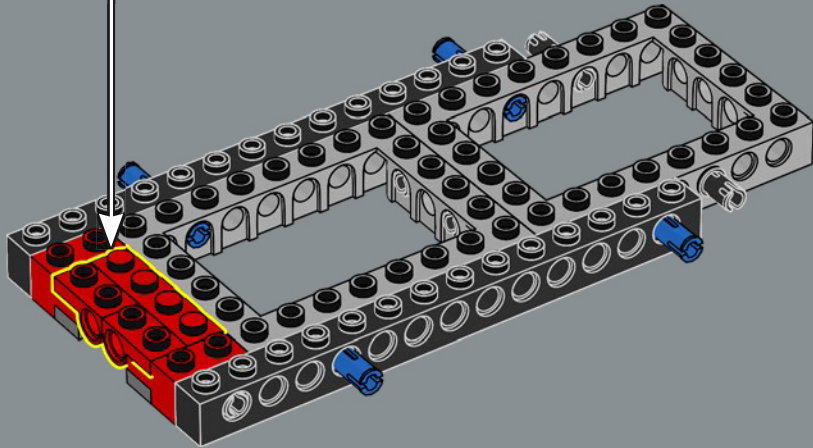
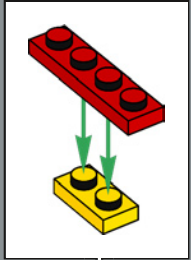

7

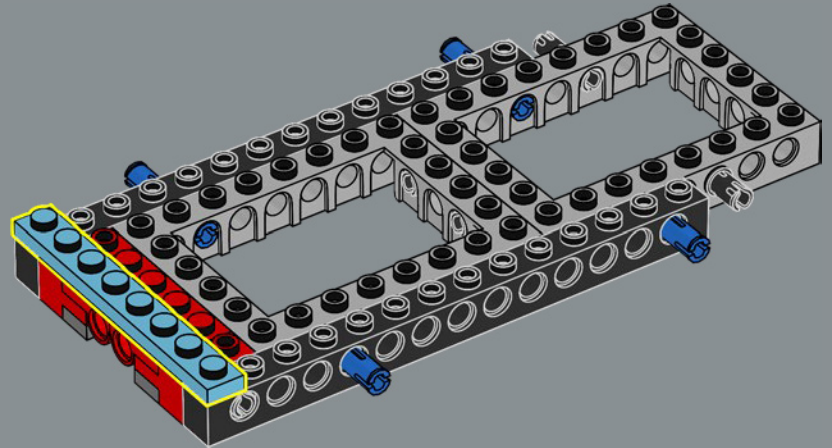

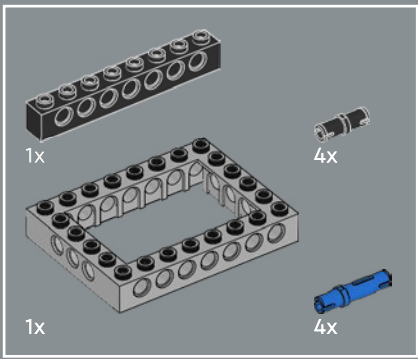

8

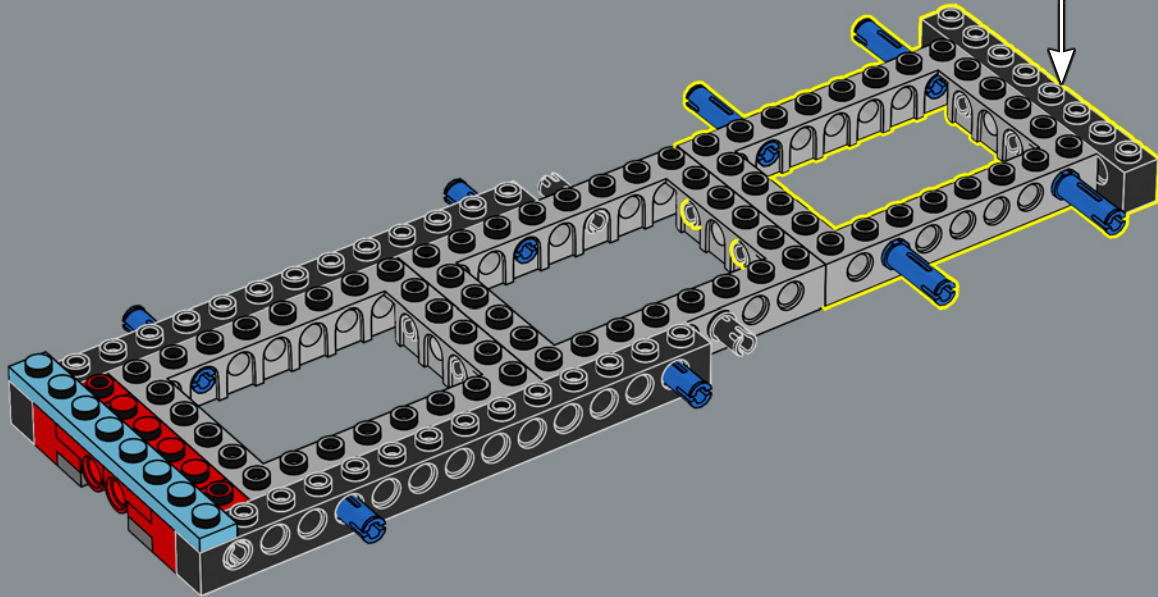
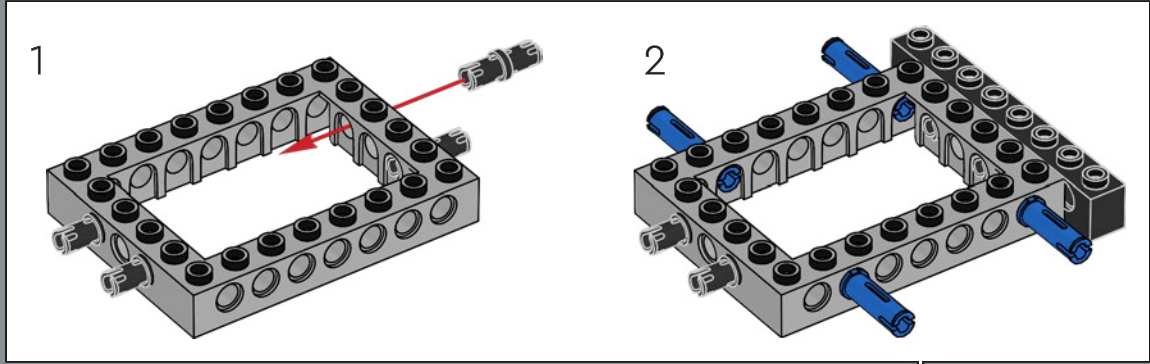

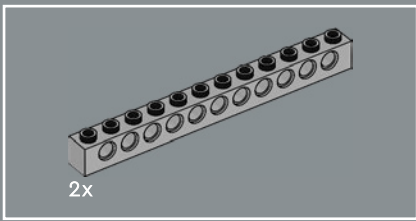

9

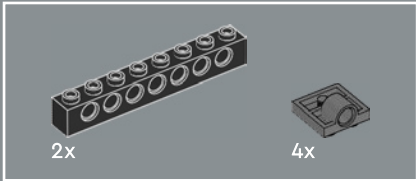
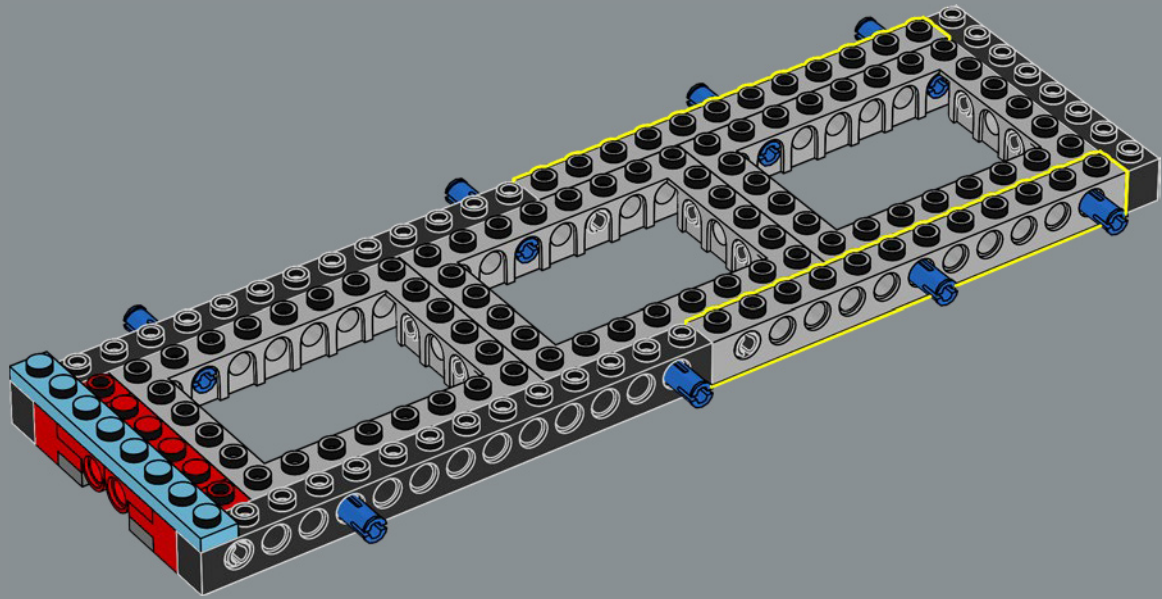

10

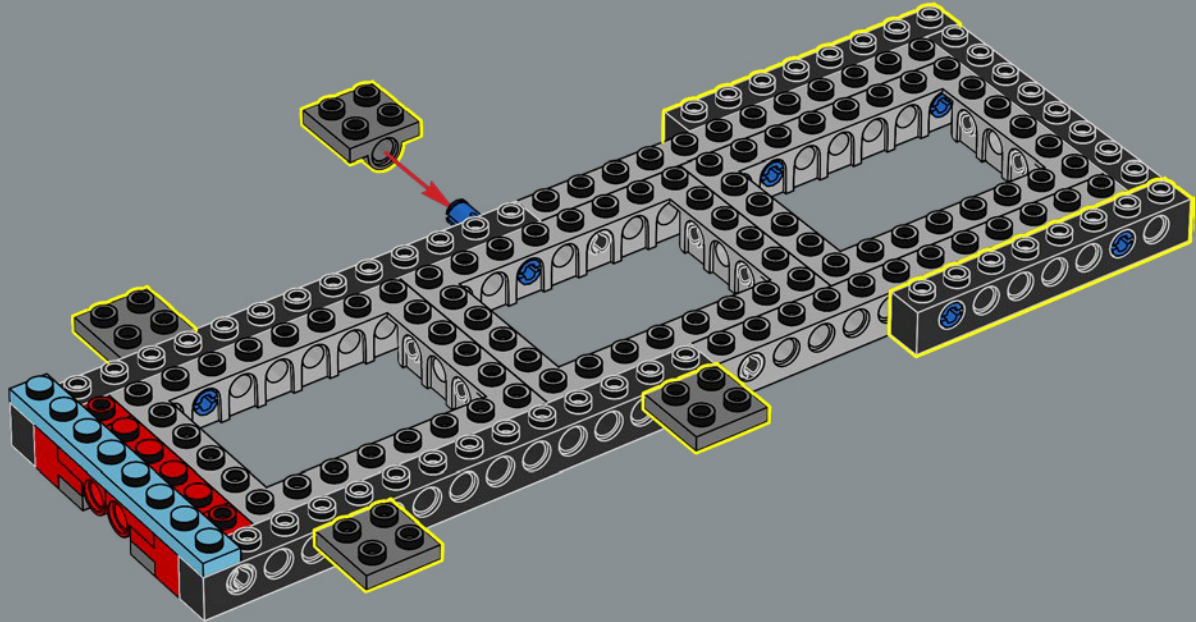

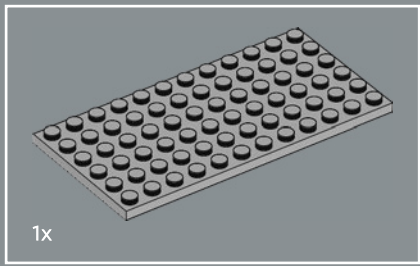

11

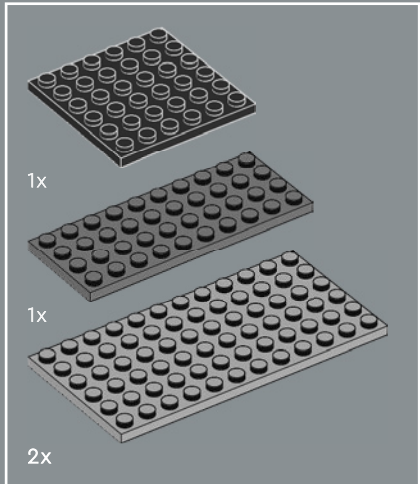
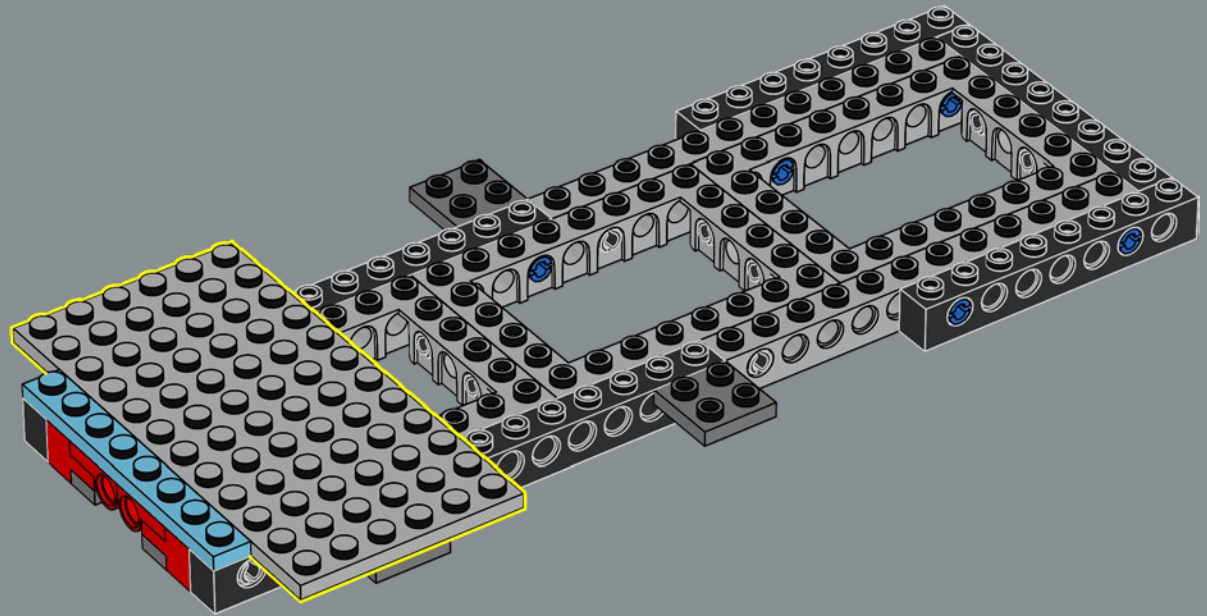

12

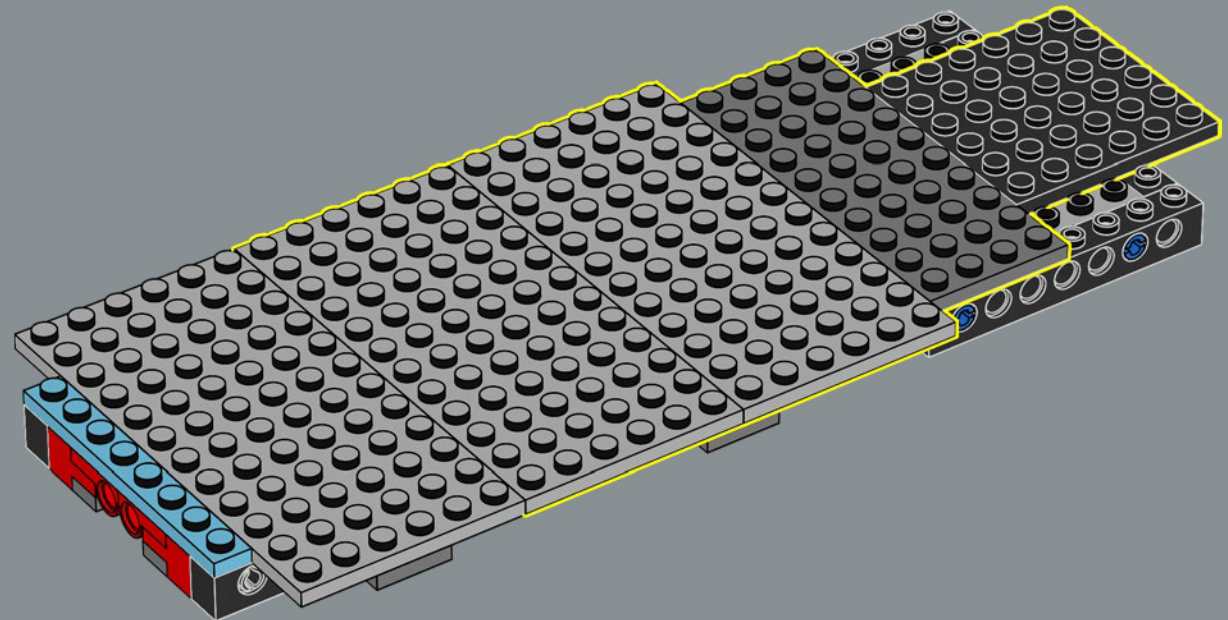



13

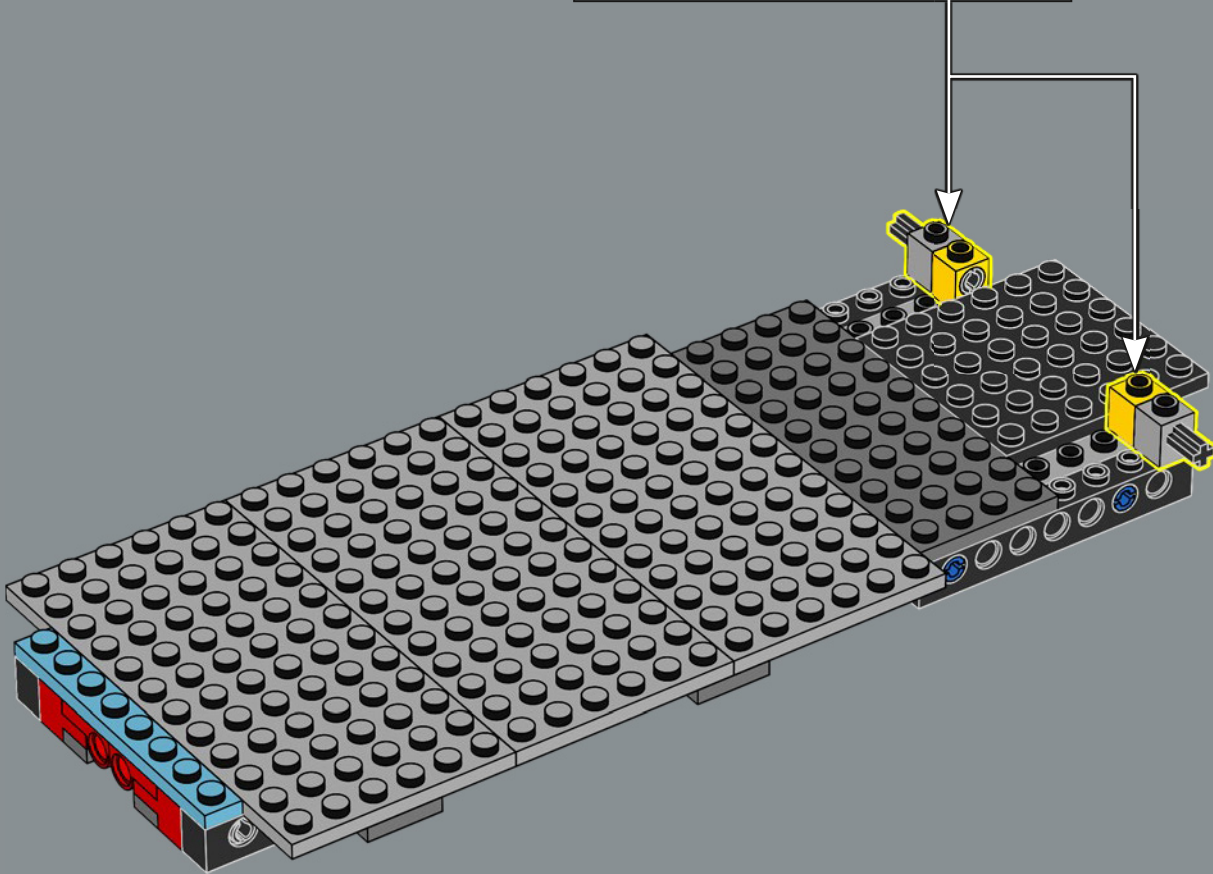
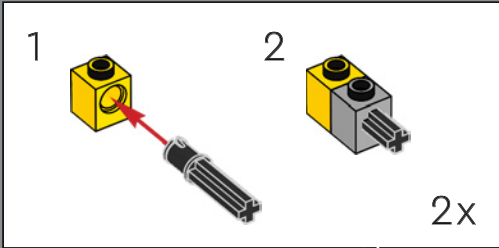

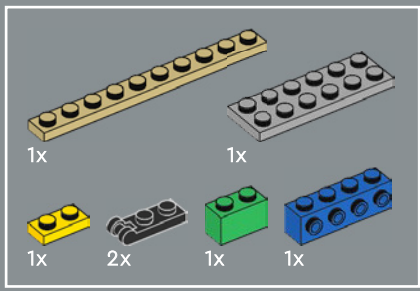

14

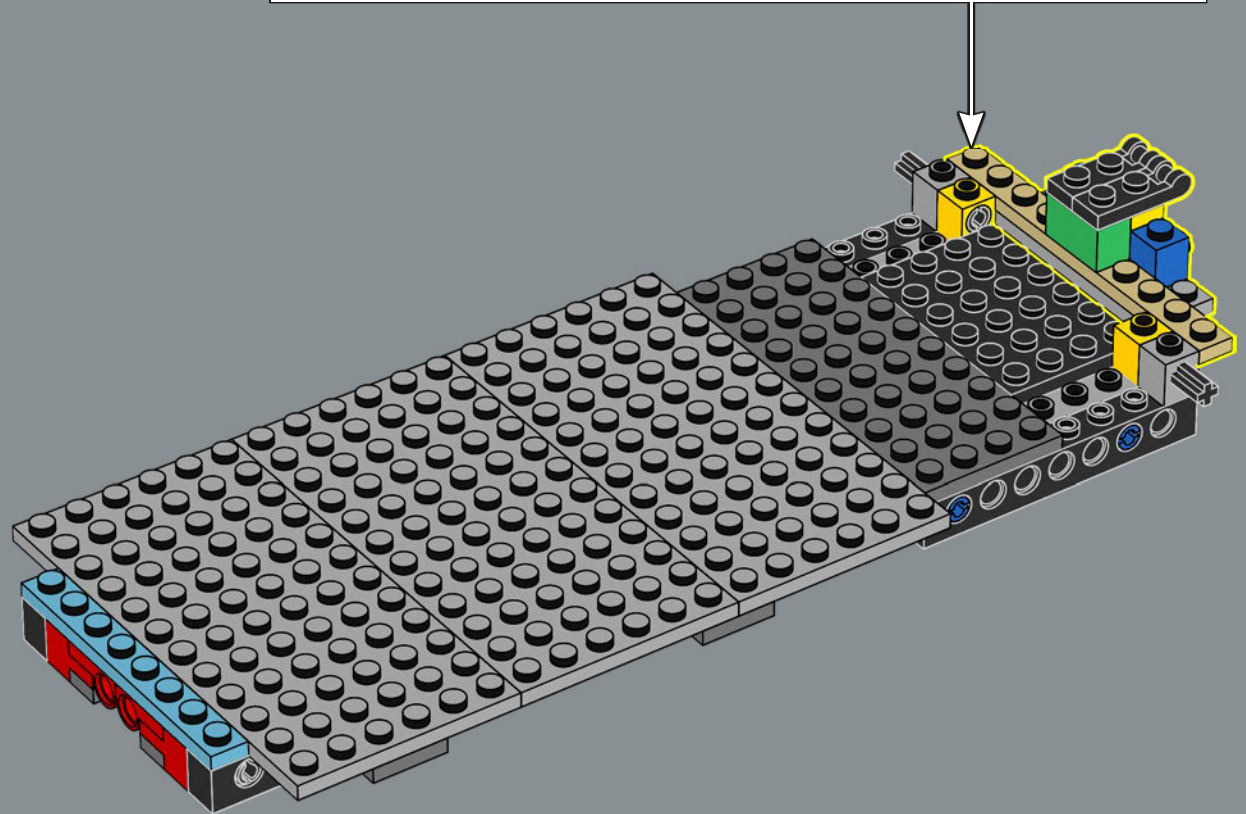
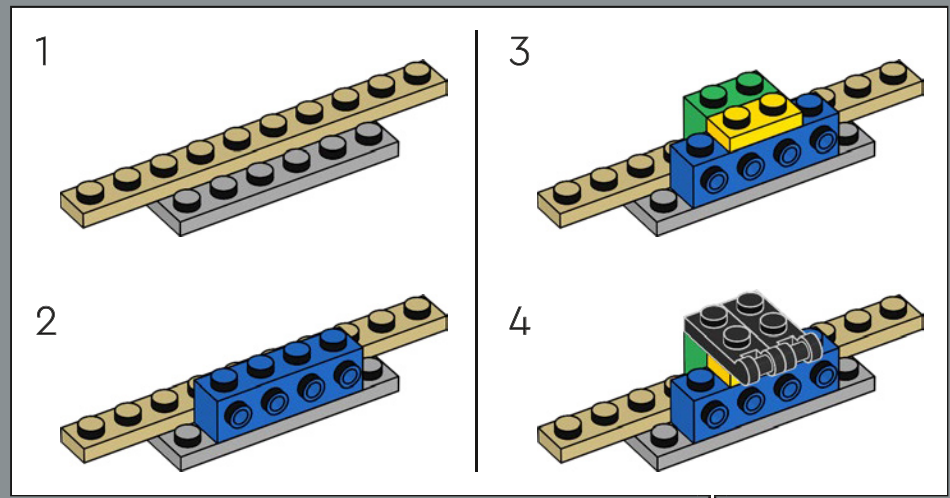

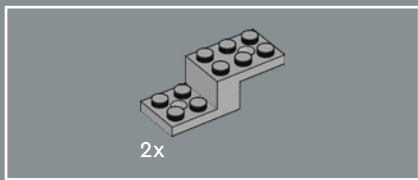

15

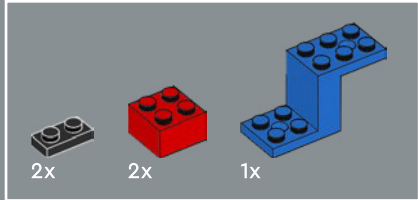
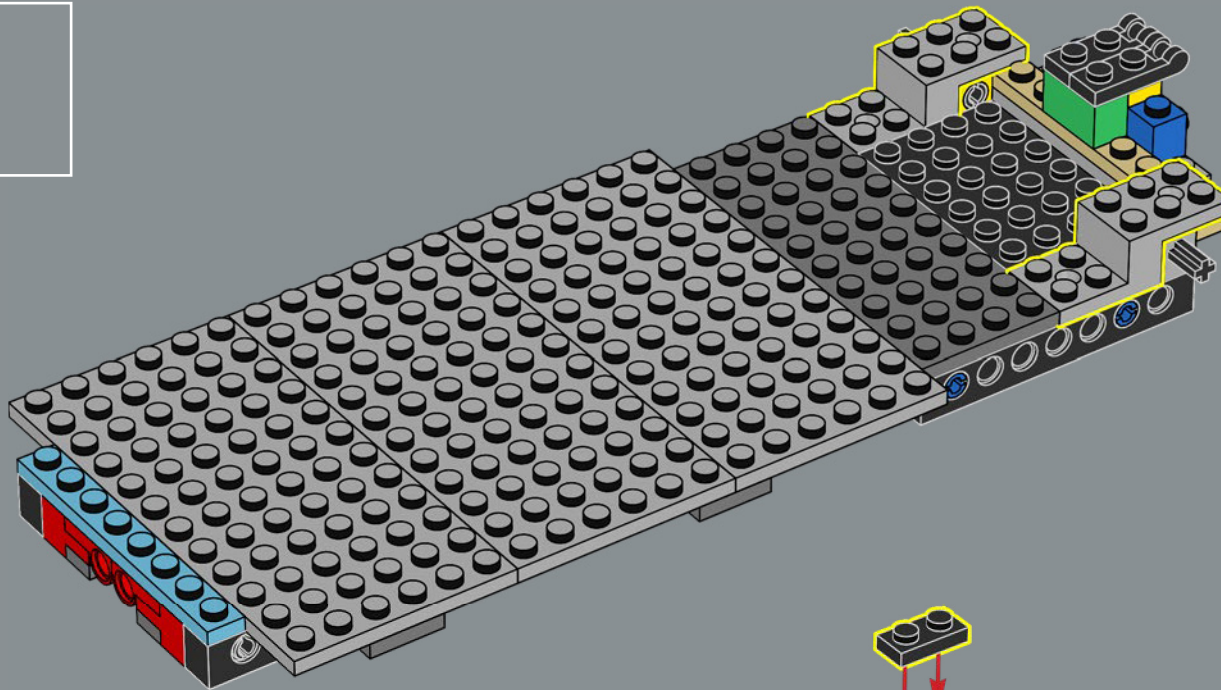

16

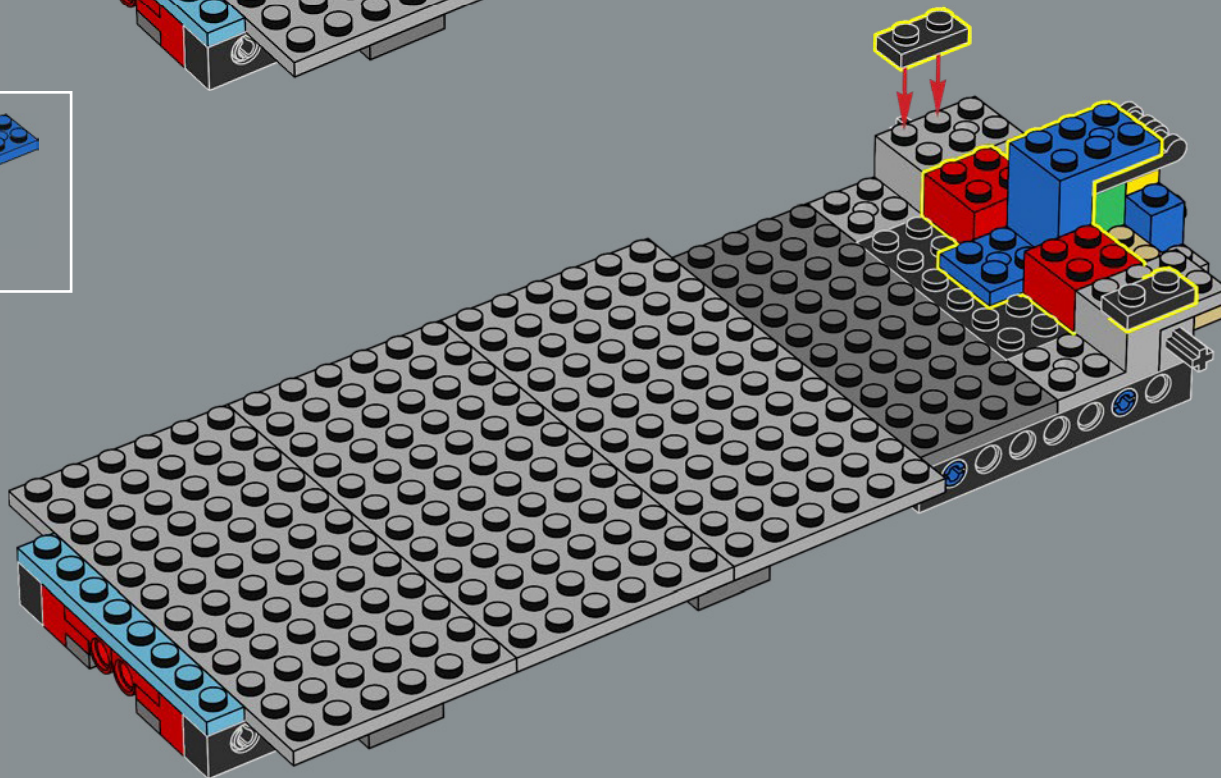

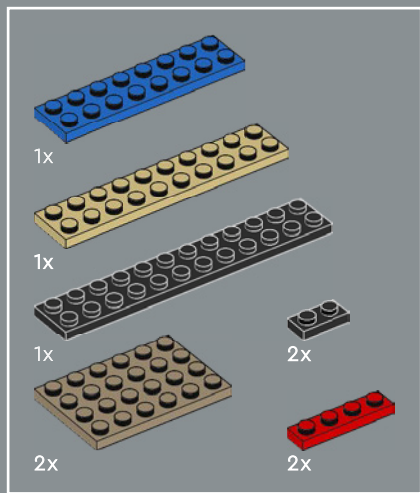

17

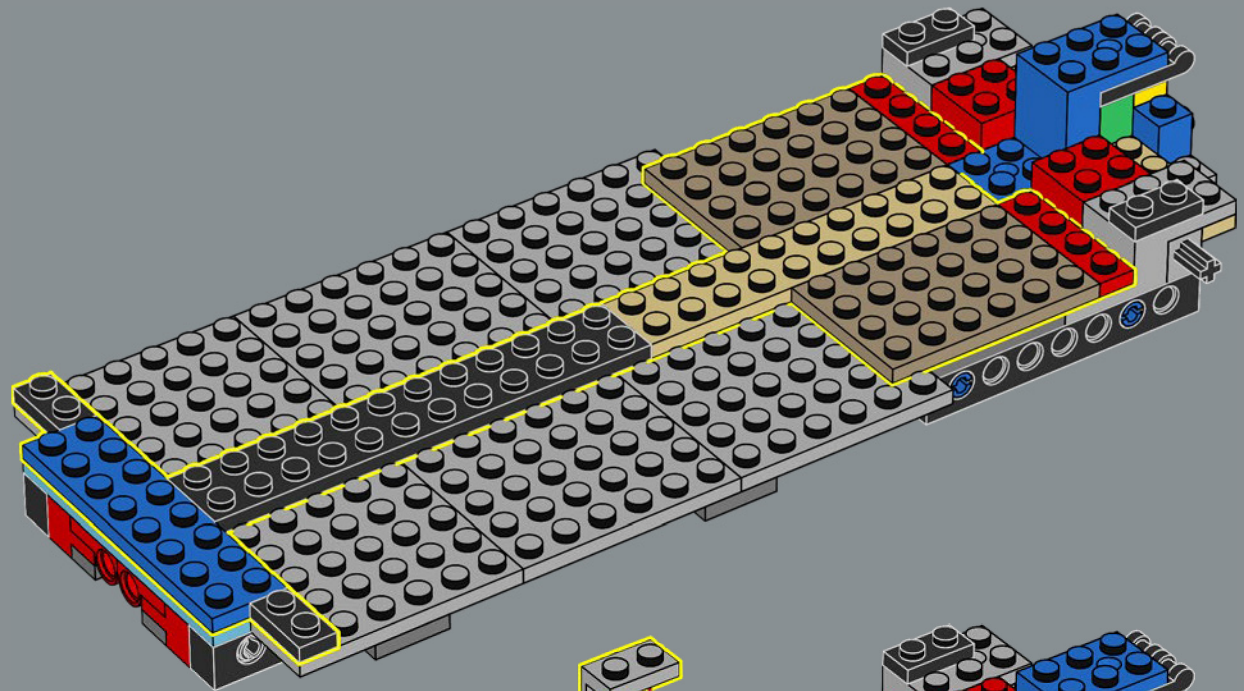

18

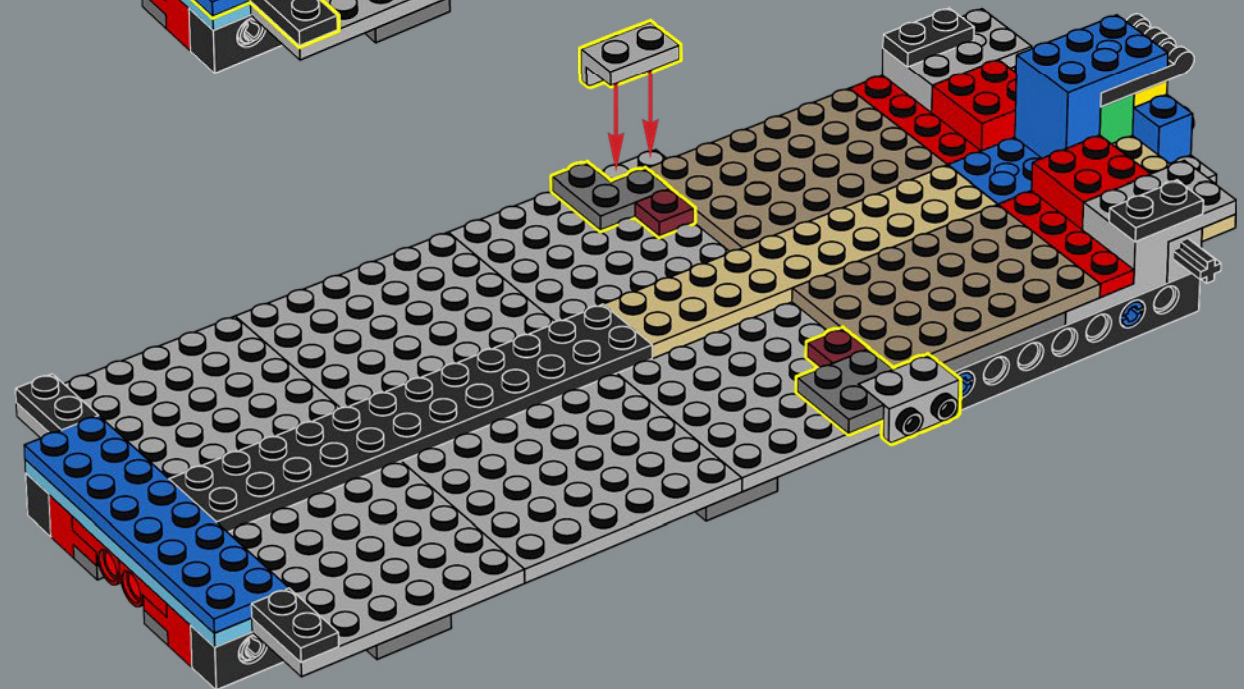



19

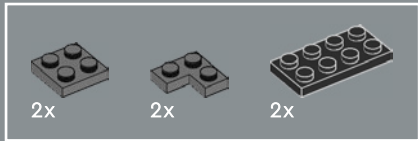
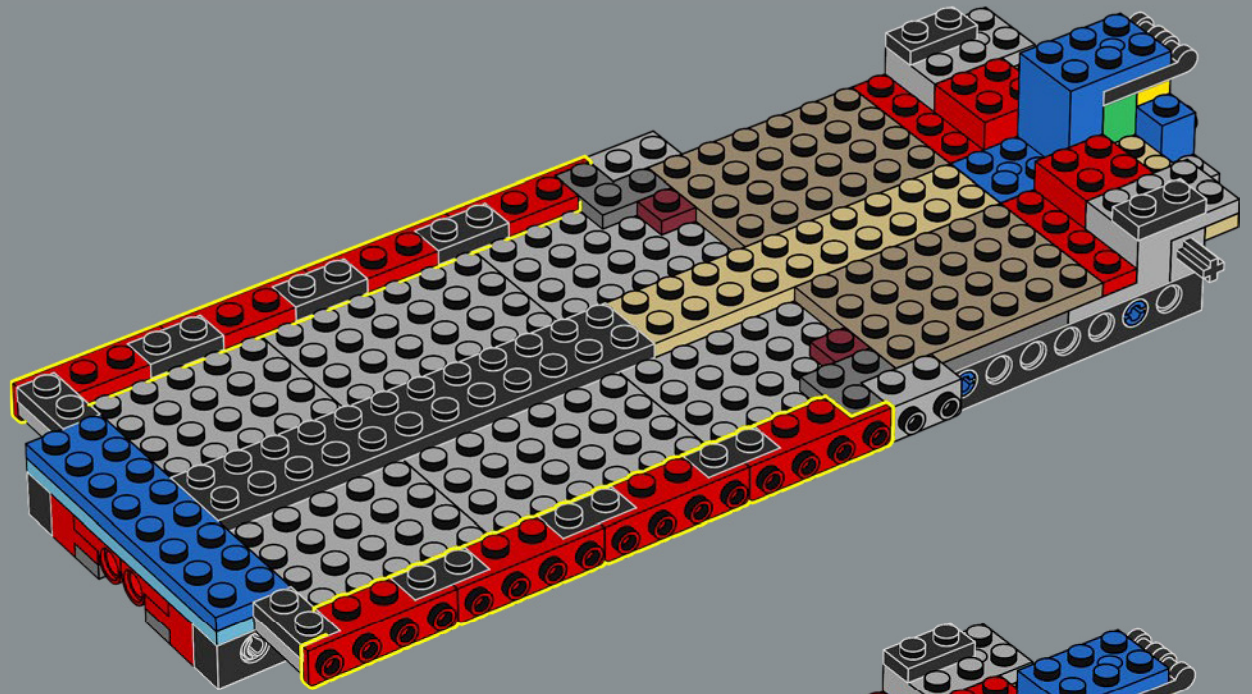

20

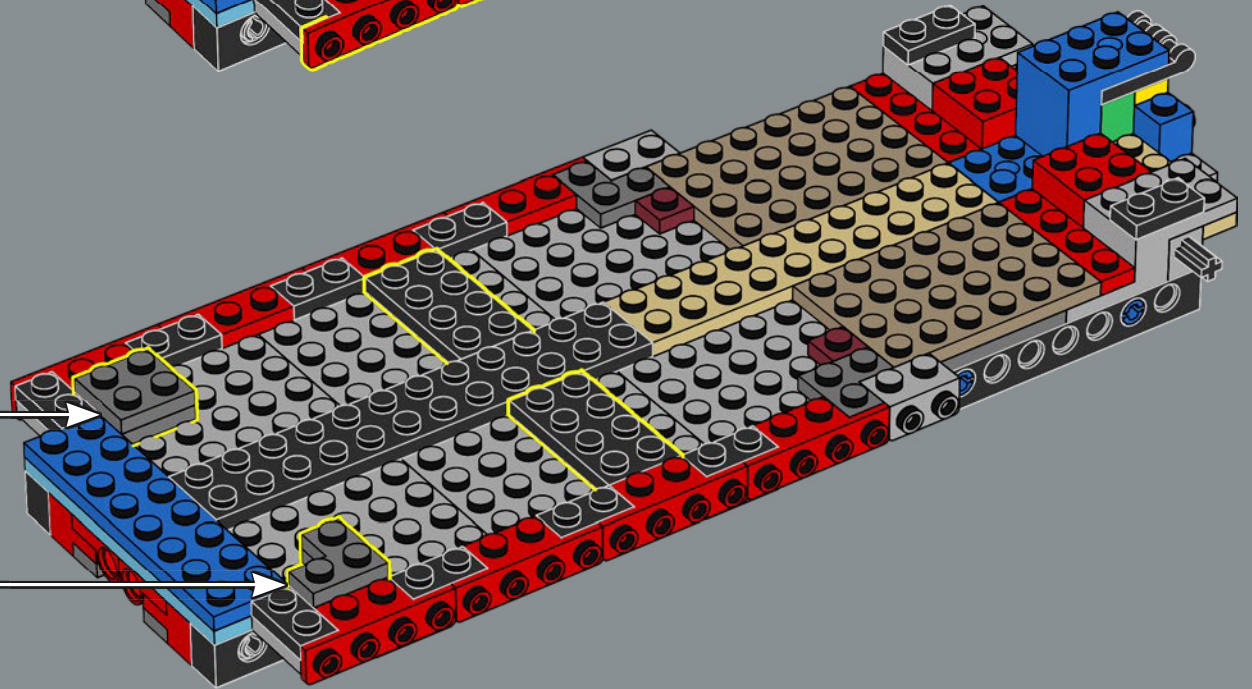
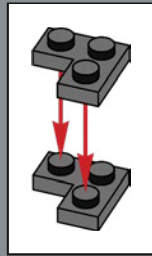
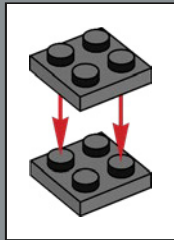

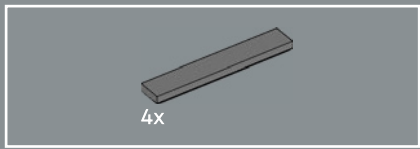

21

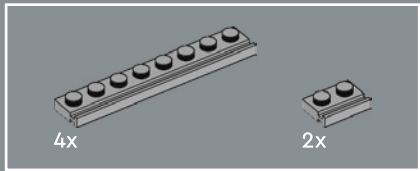
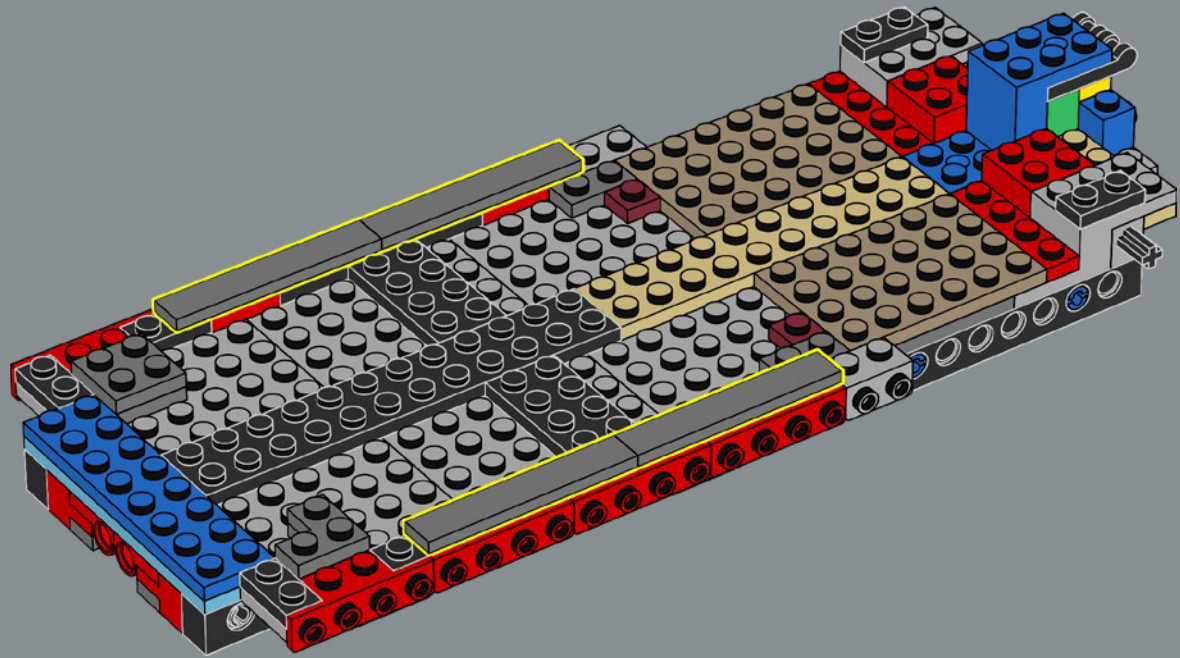

22

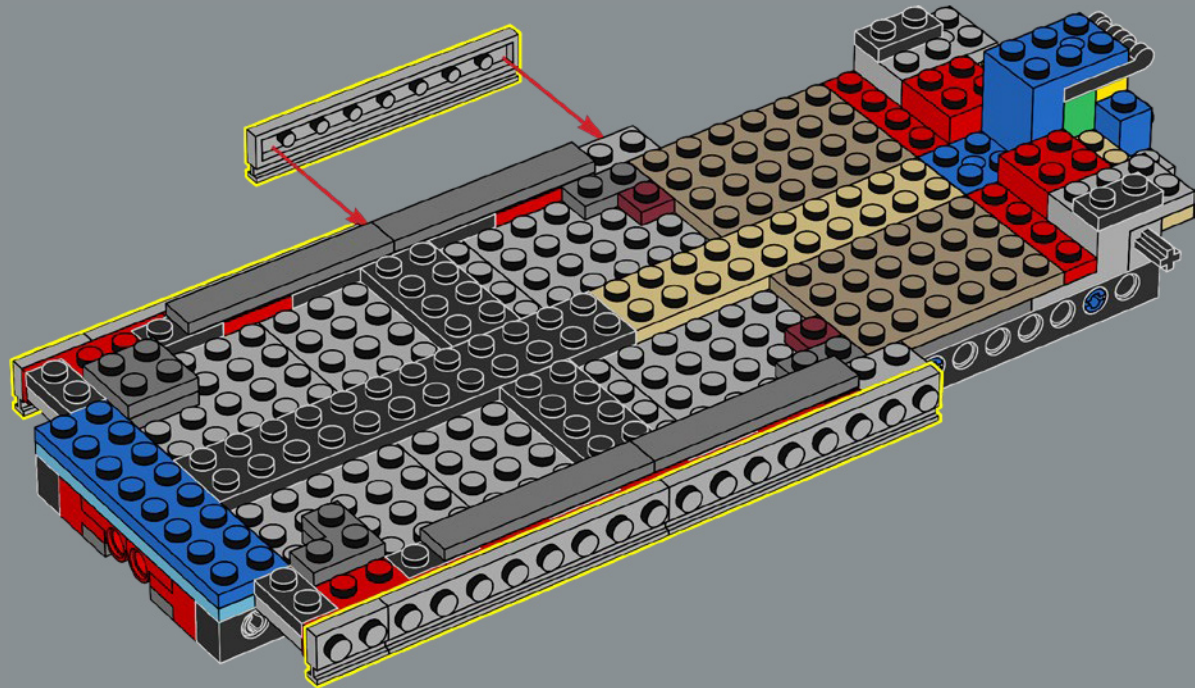



23

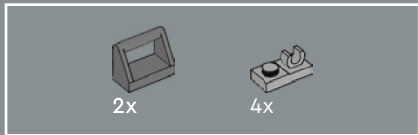
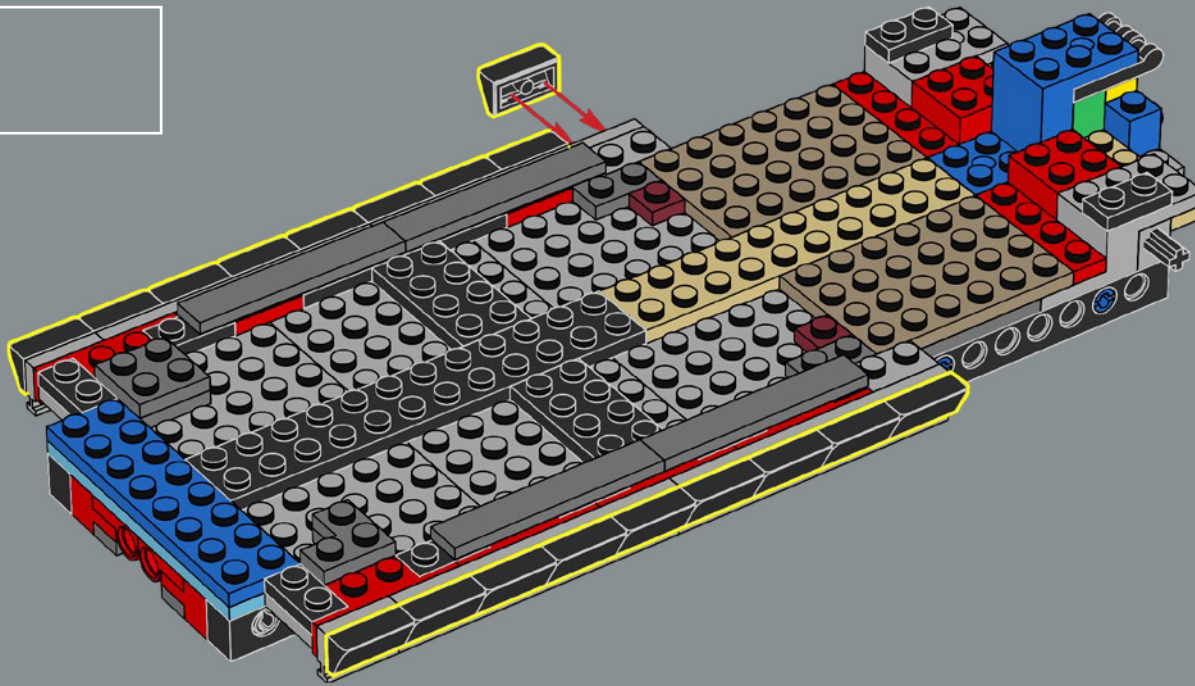

24

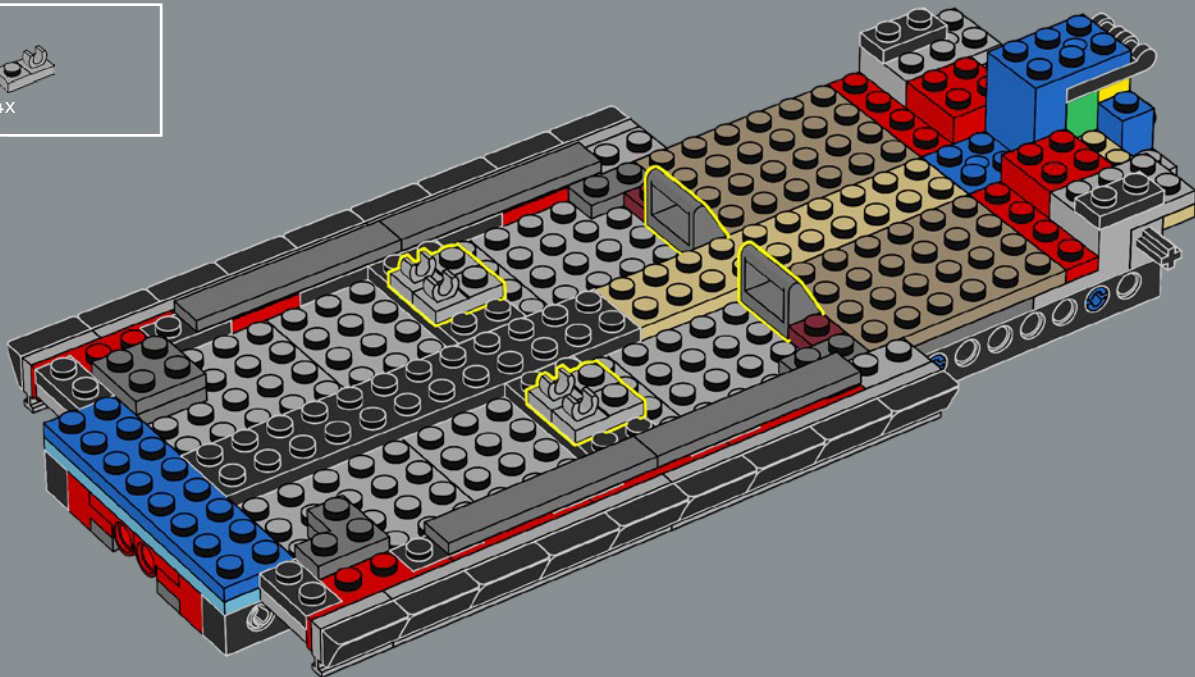



4x

25

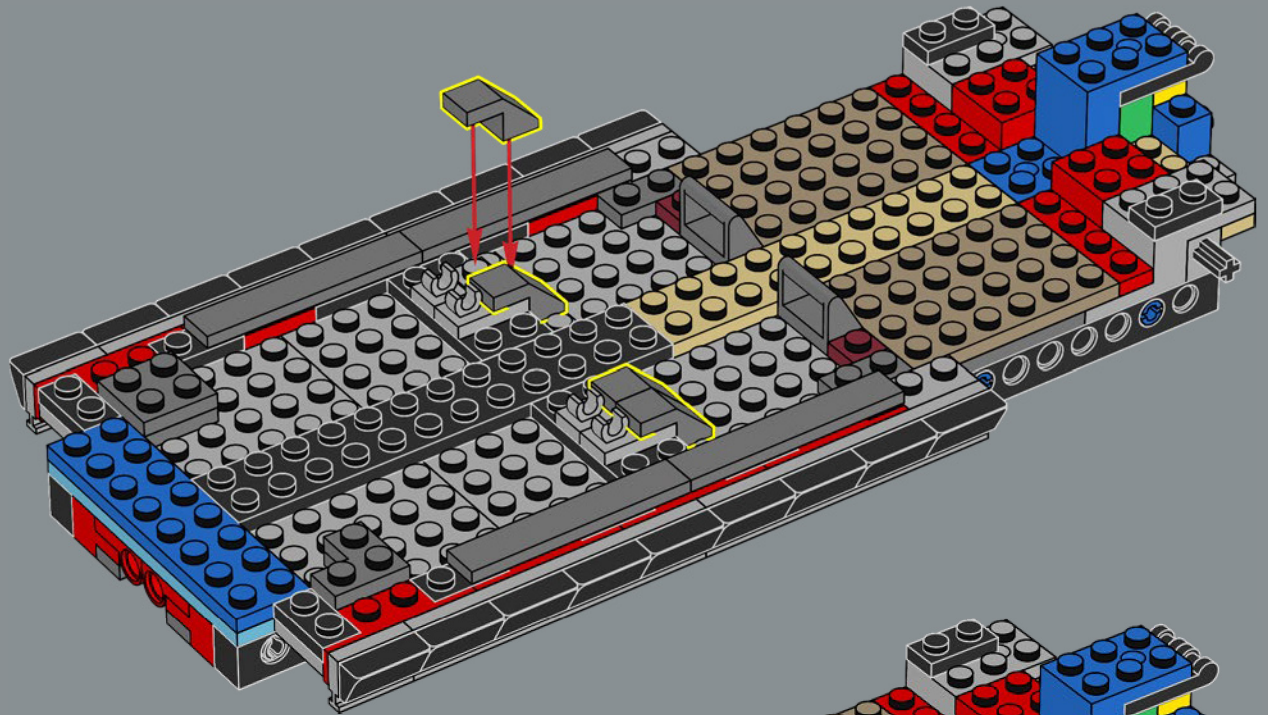

1x



1x



1x

26

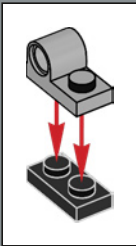
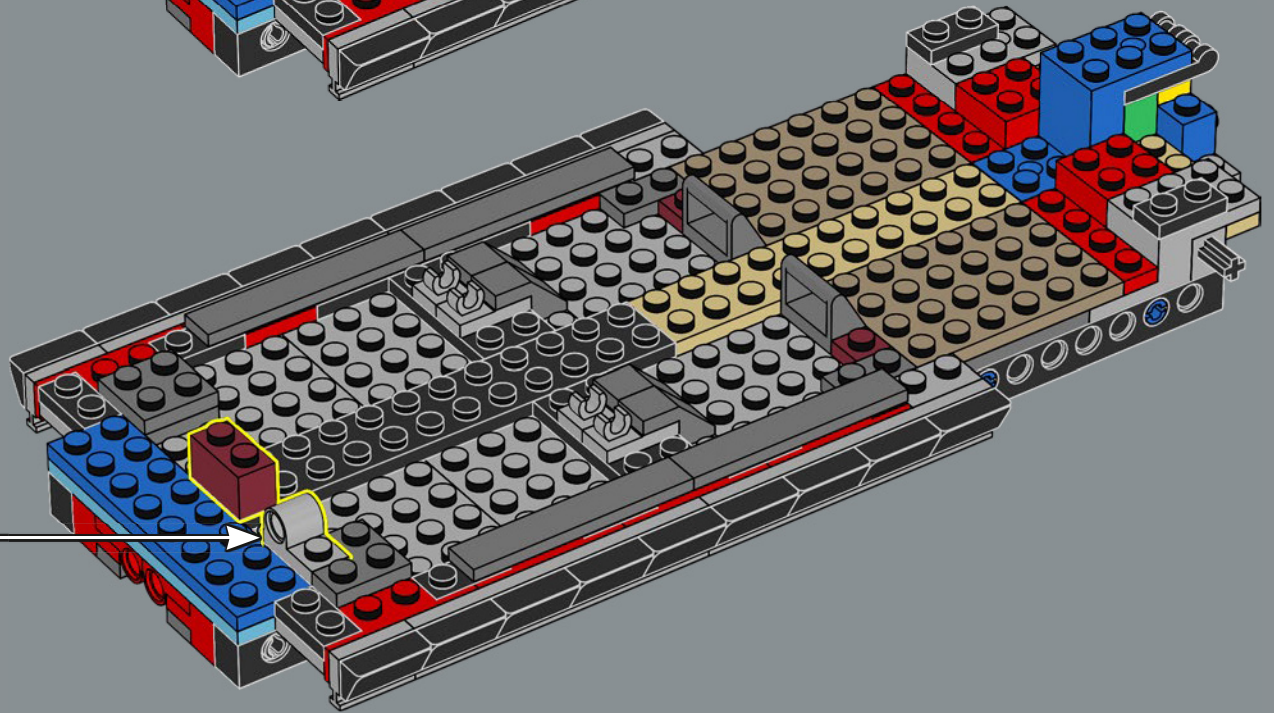

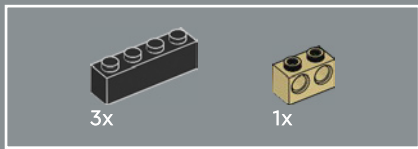

27

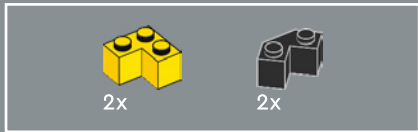
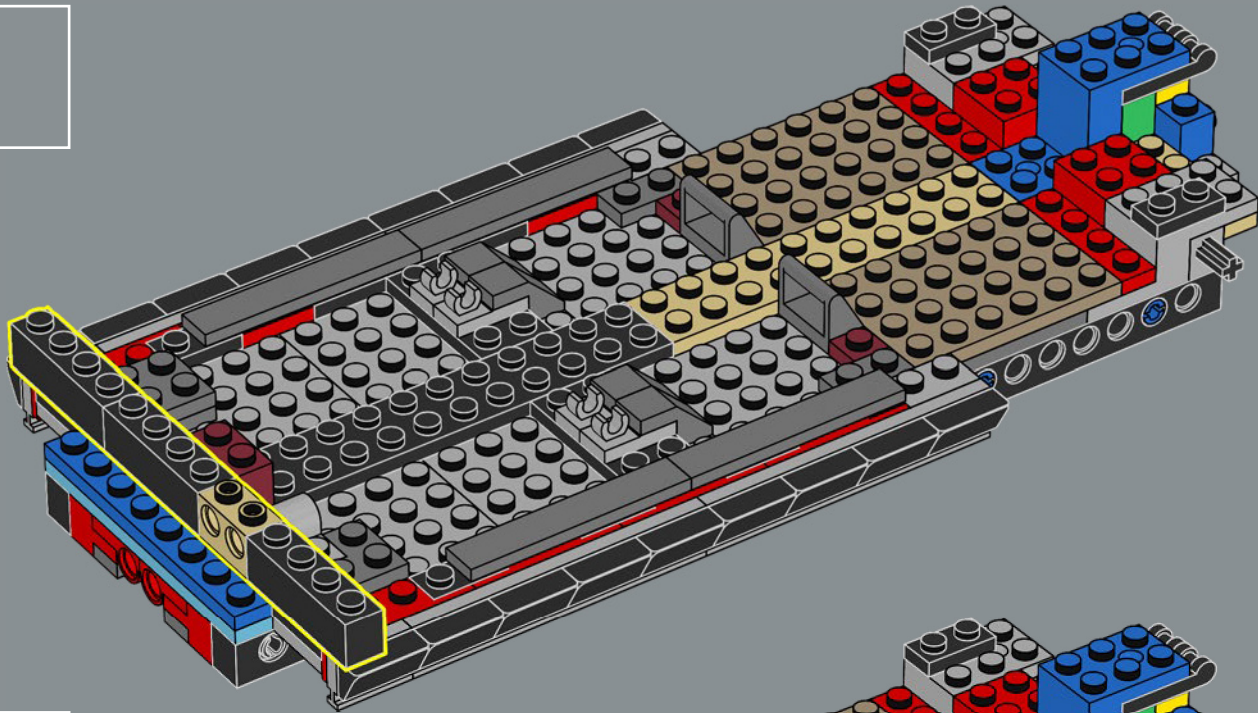

28

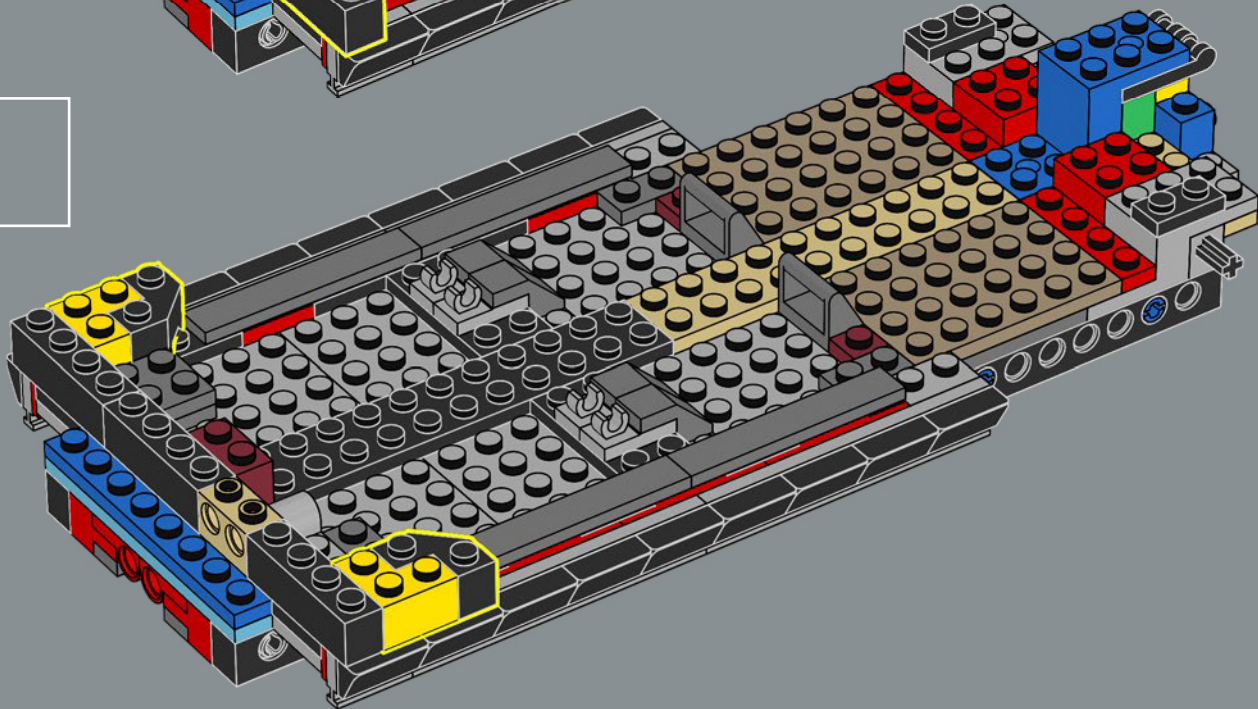



29

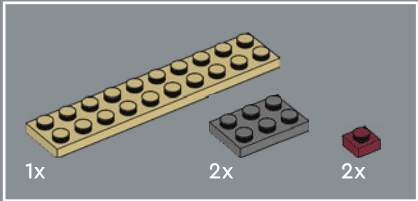
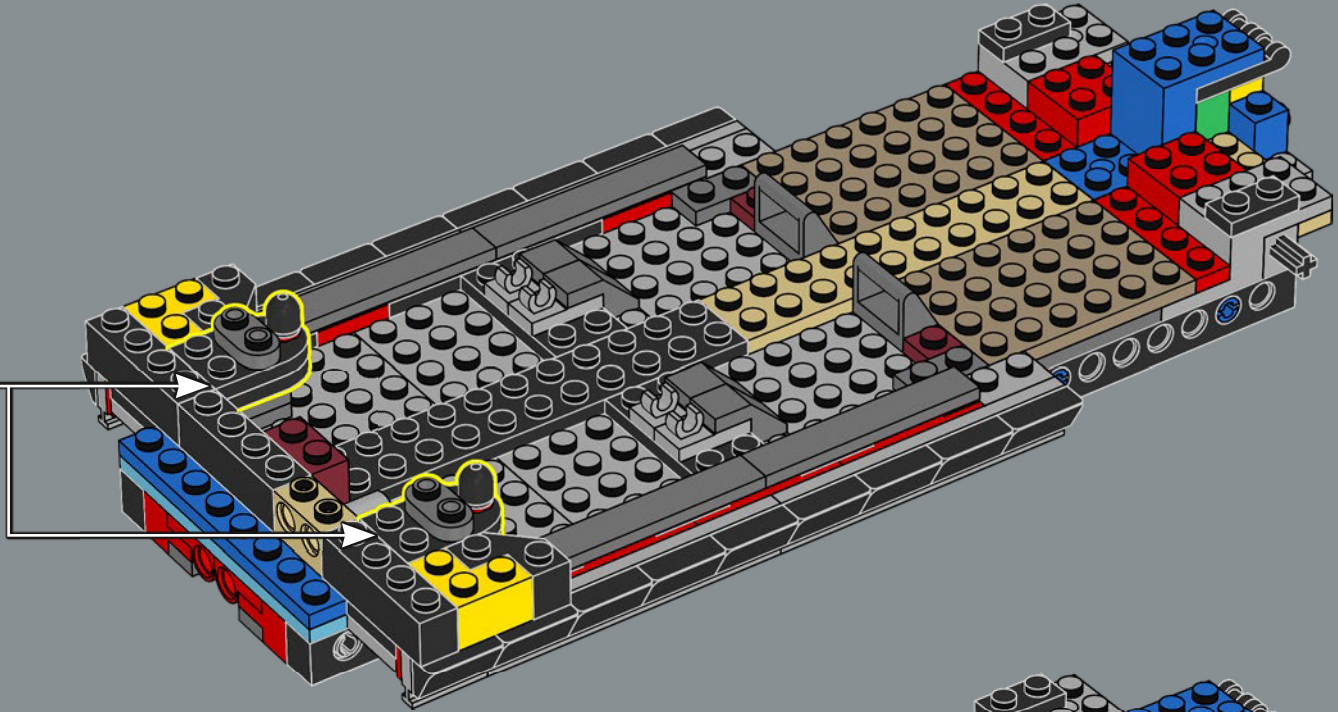
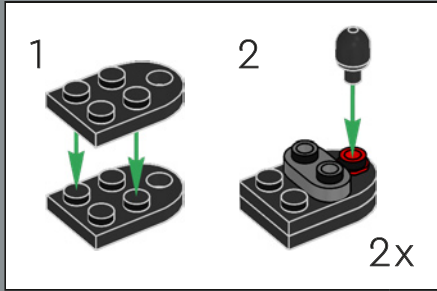

30

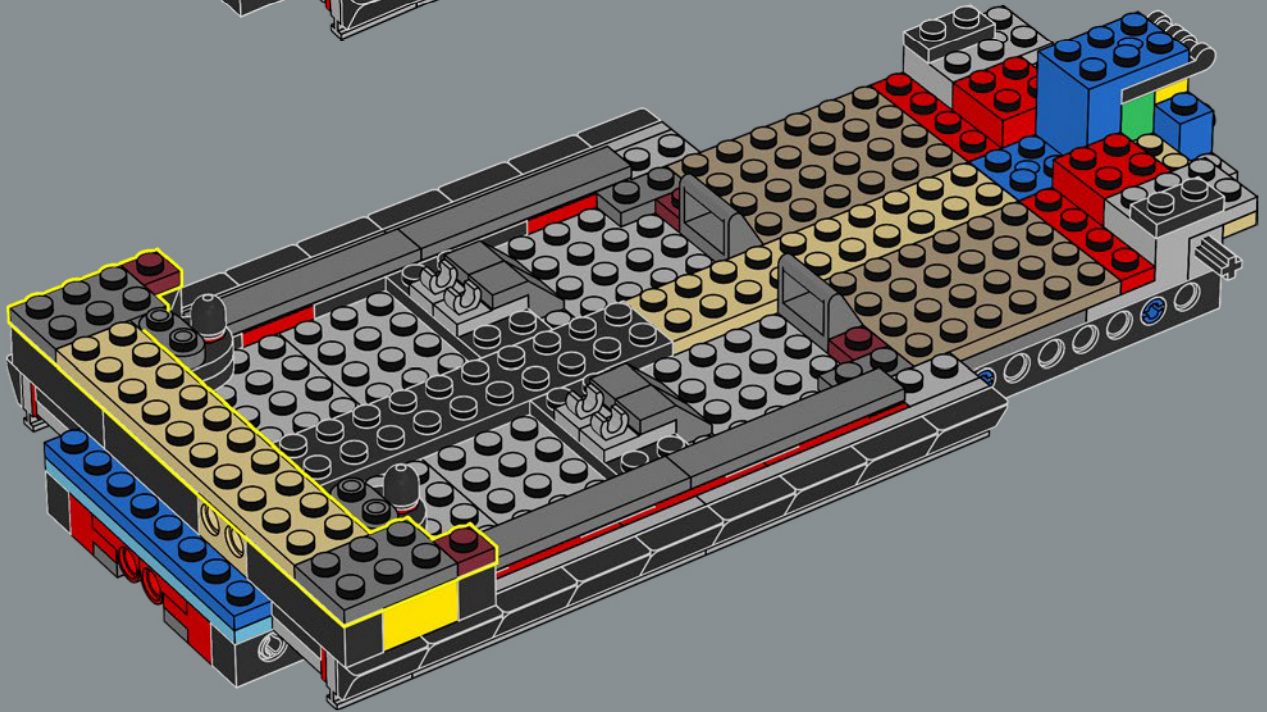

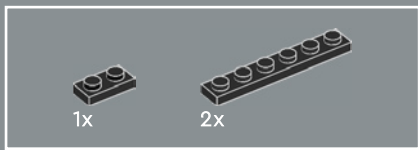

31

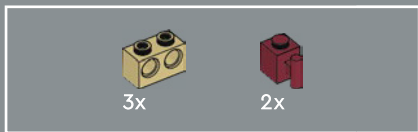
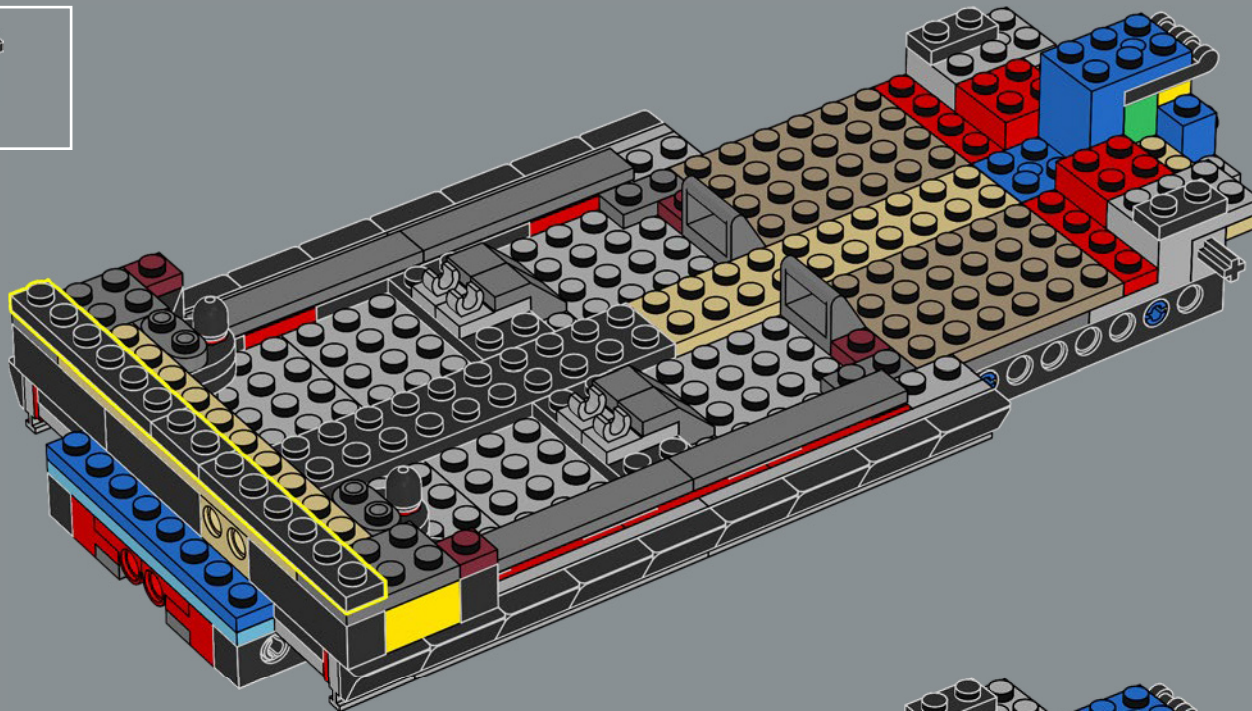

32

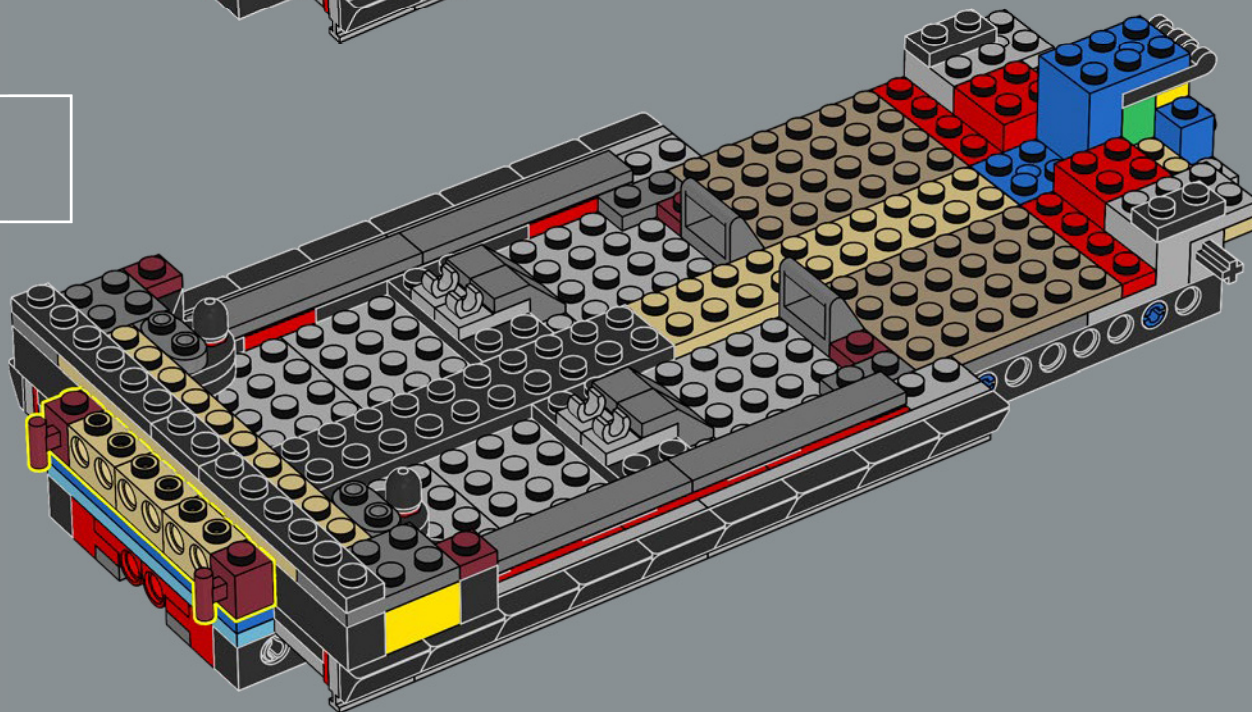

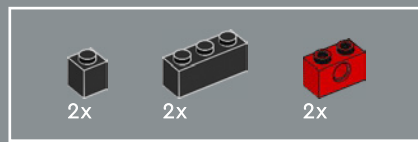

33

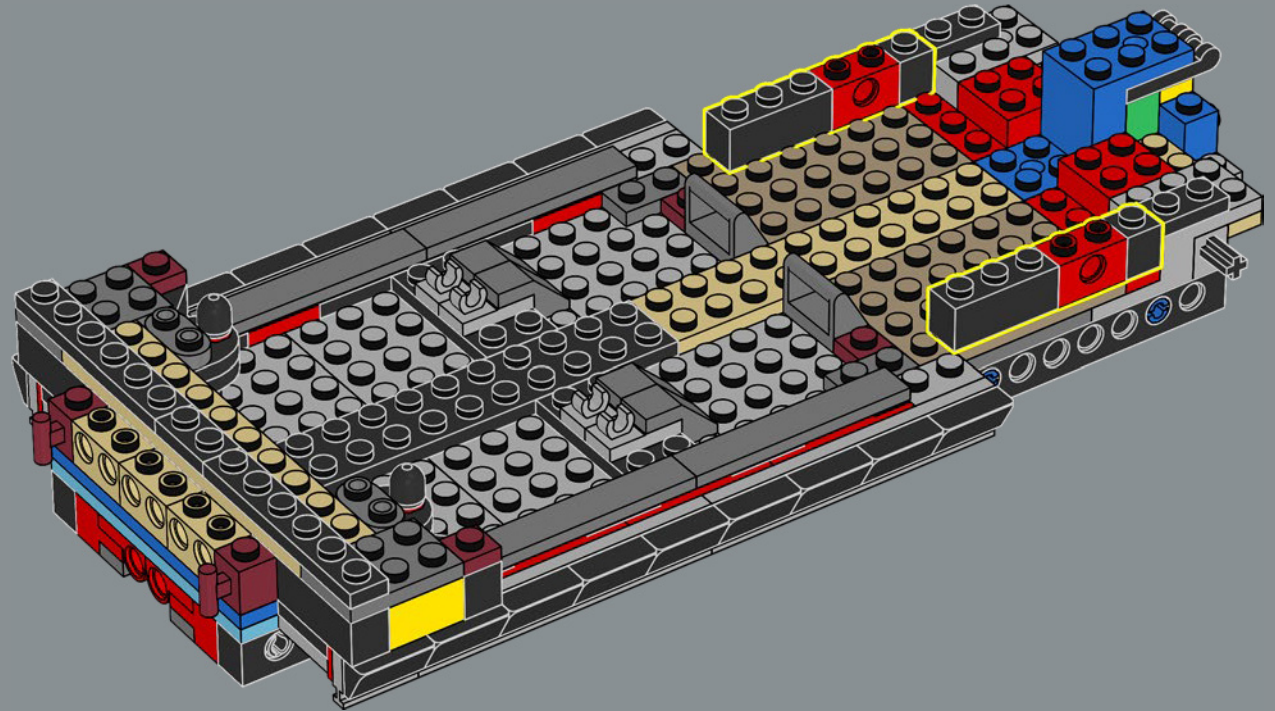

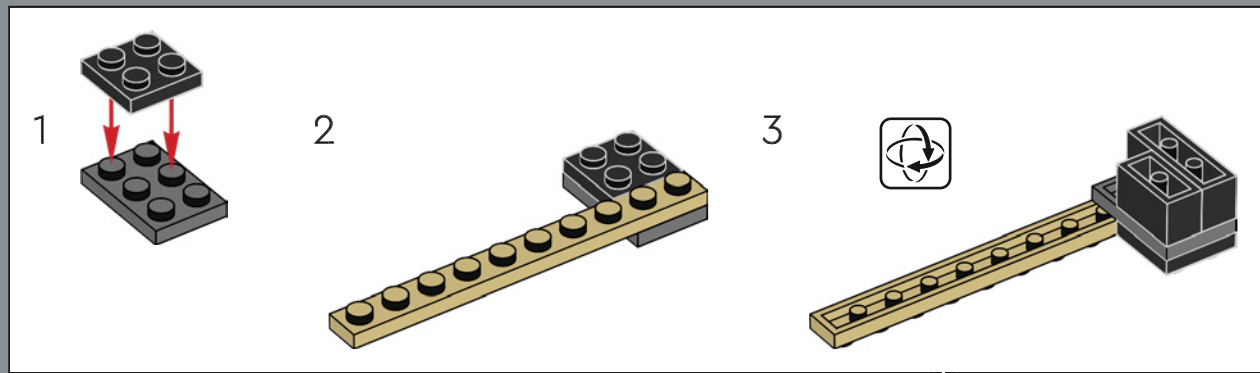
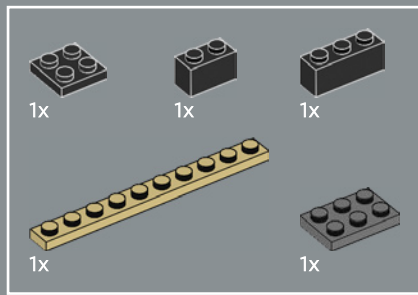

34

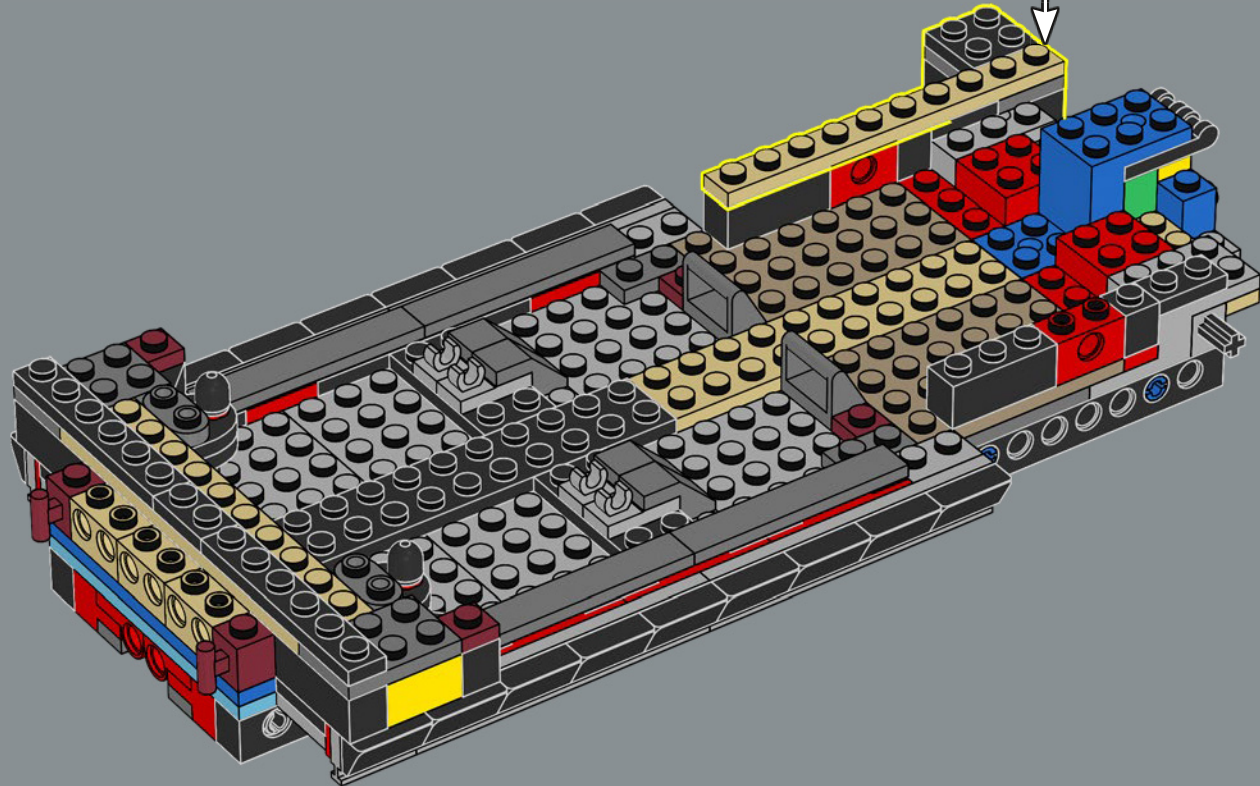

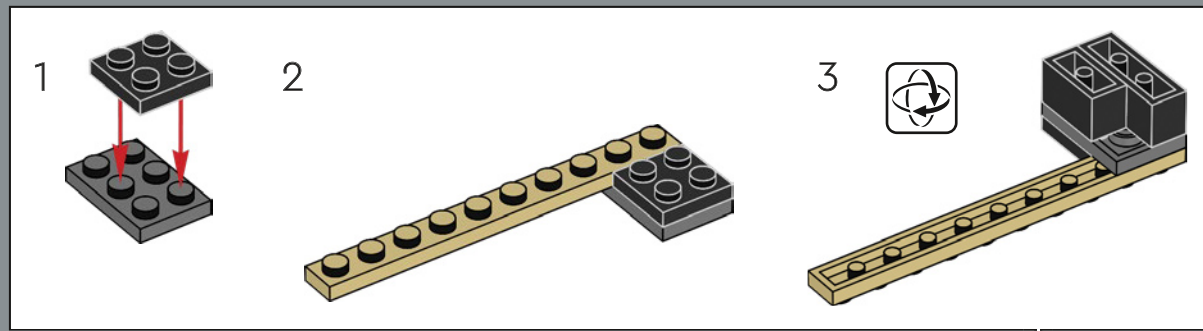
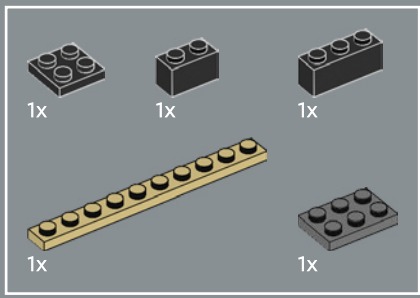

35

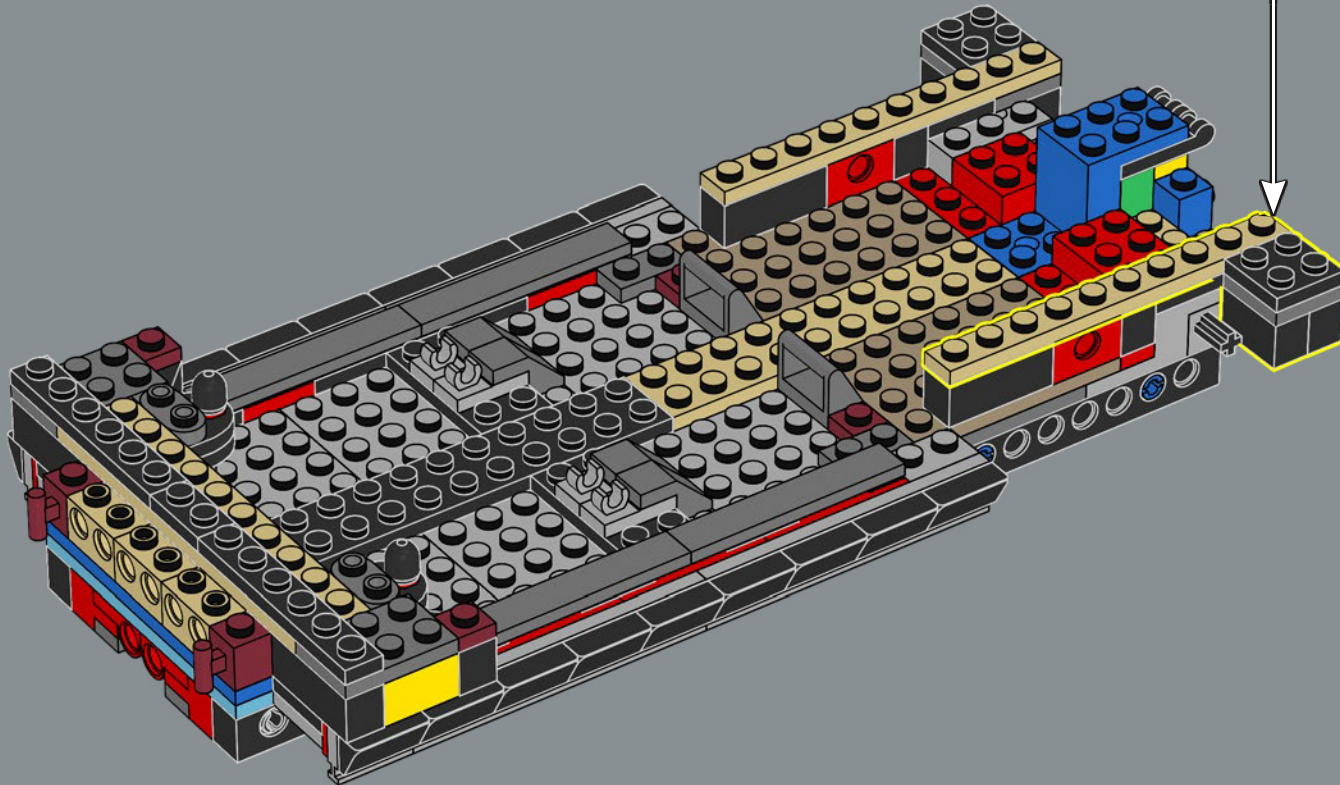

The code-name for the Camaro before it launched was "Panther."

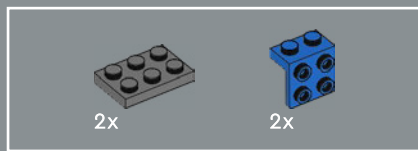

36

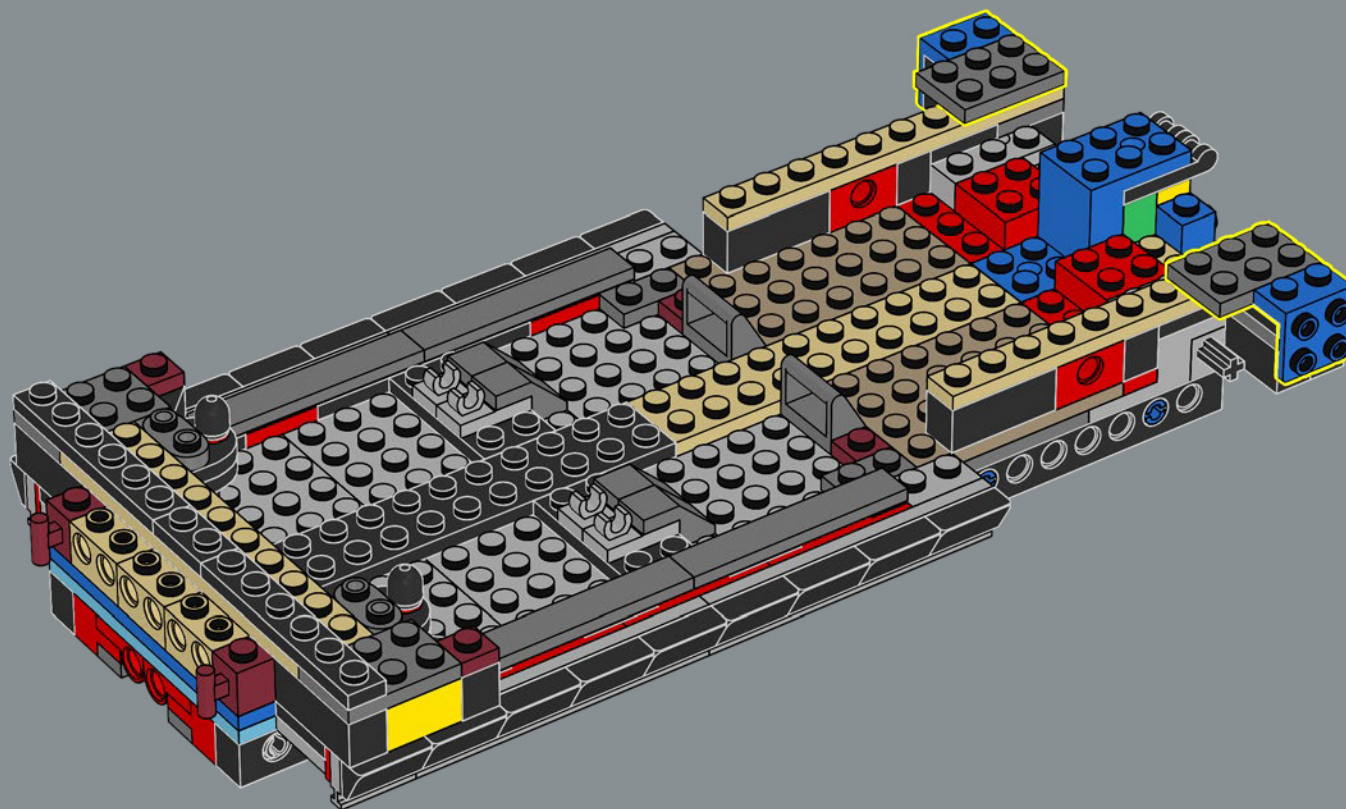

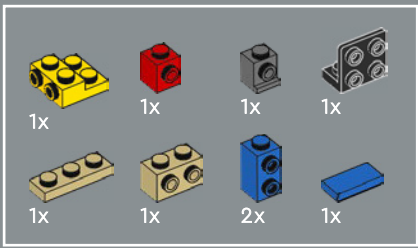

37

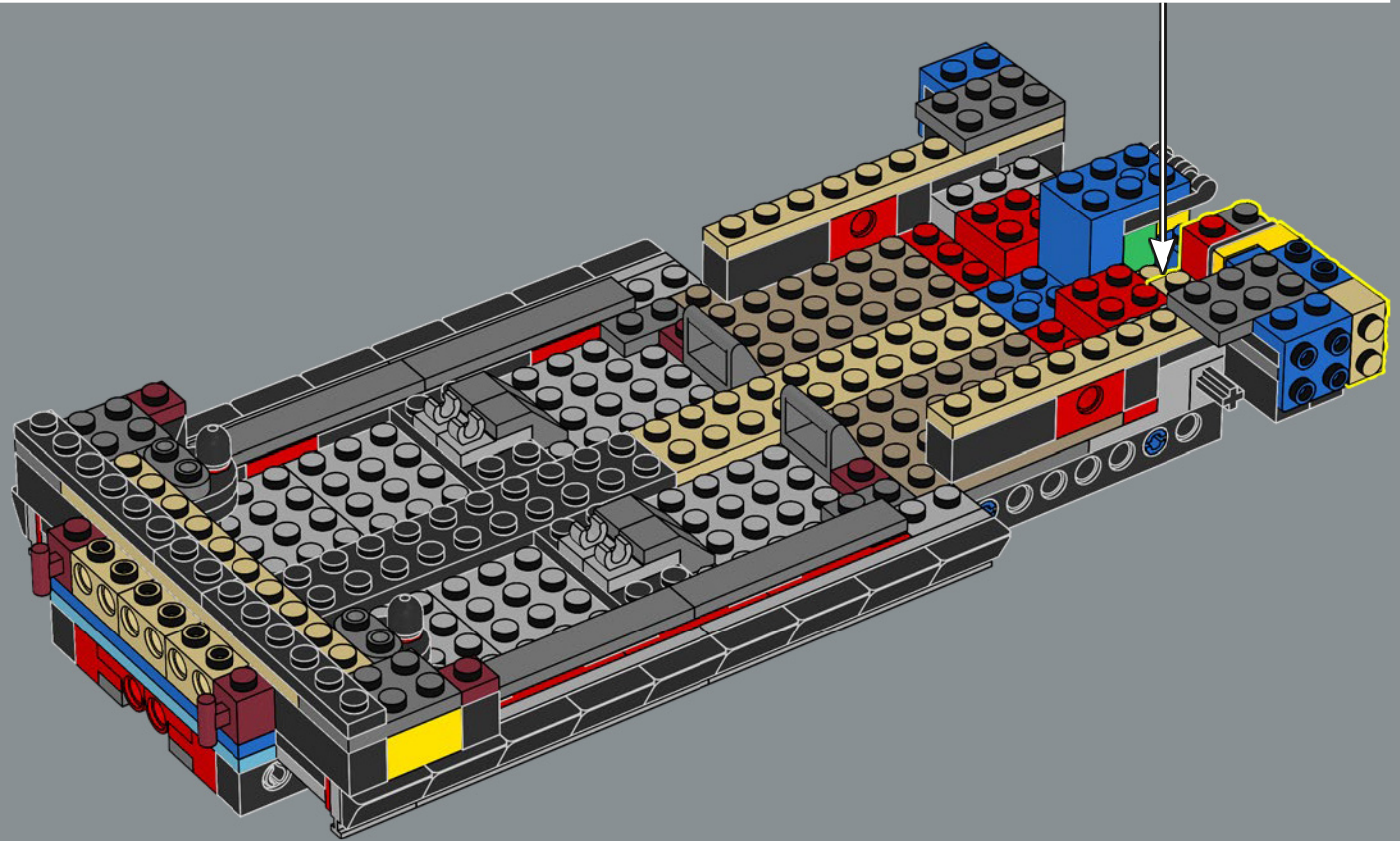
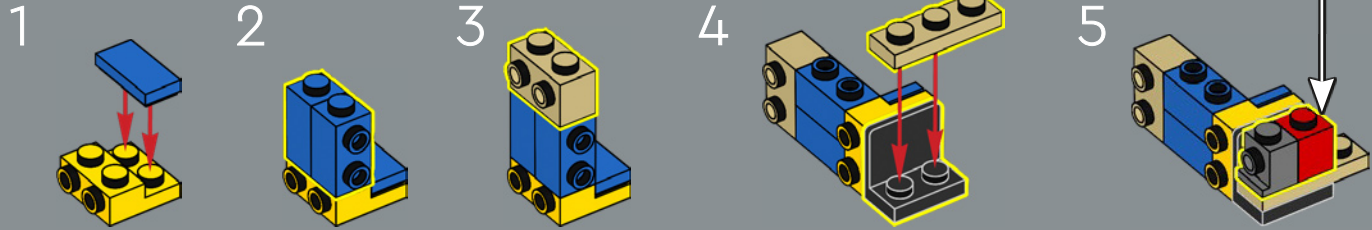

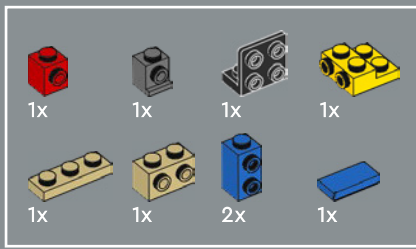

38

1

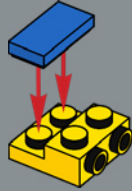

2

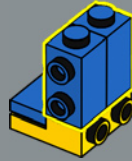

3

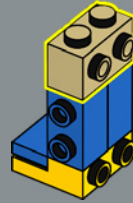

4

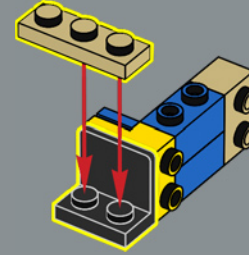

5

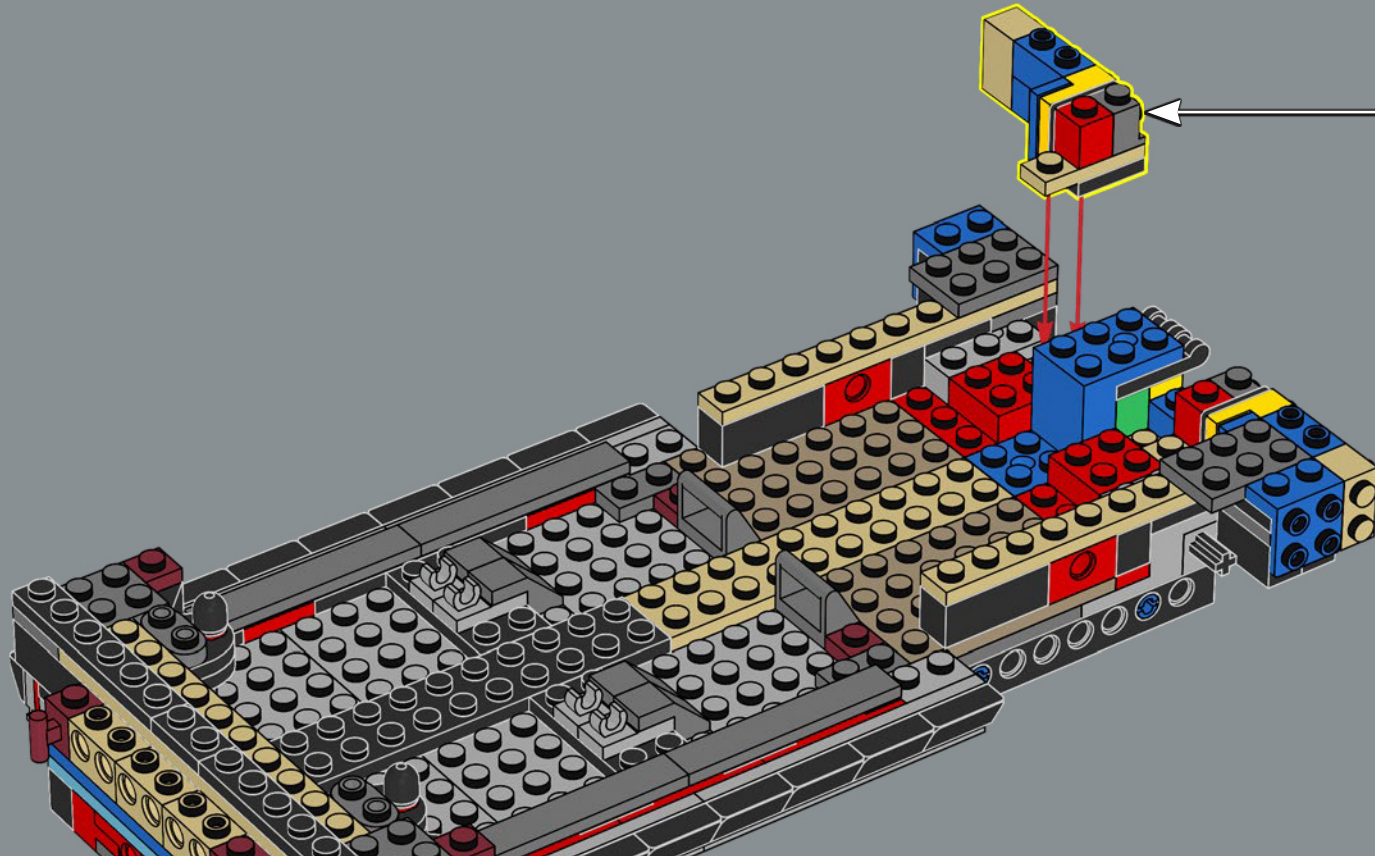
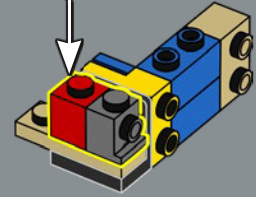
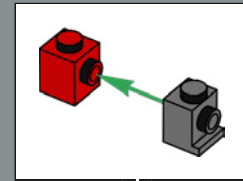

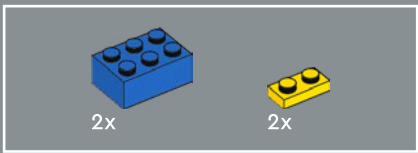

39

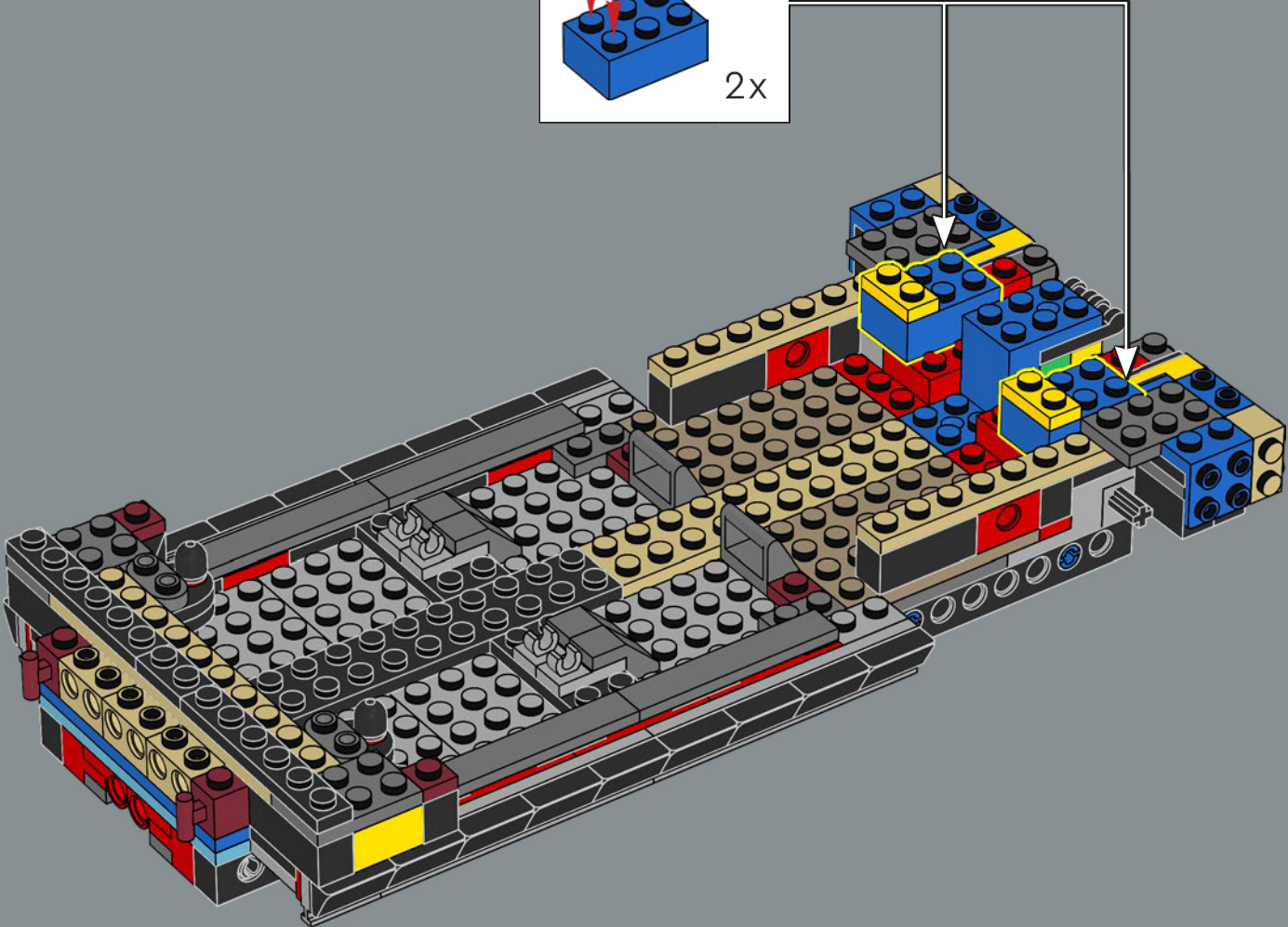
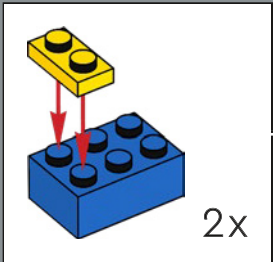

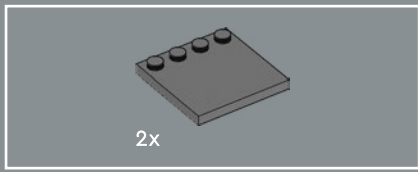

40

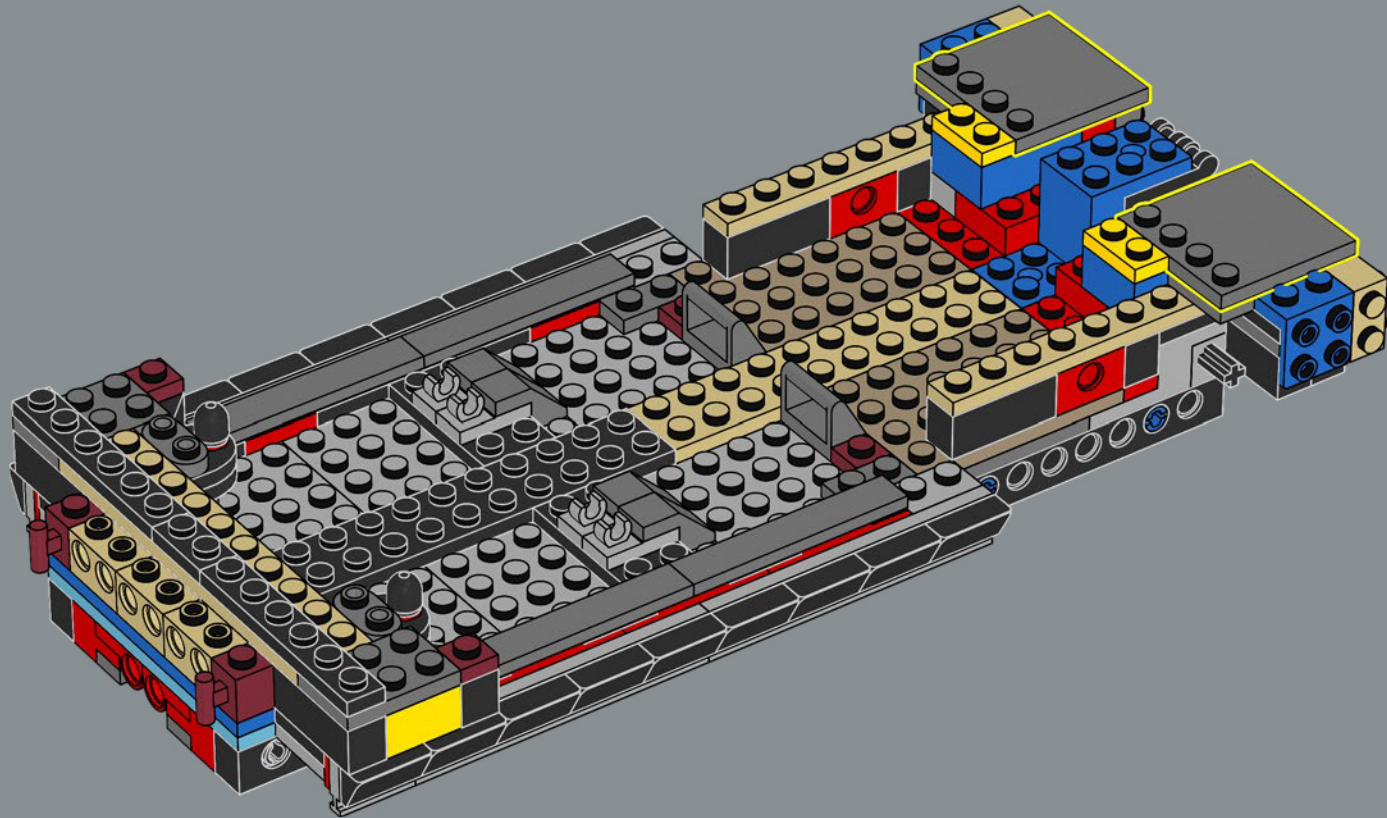



41

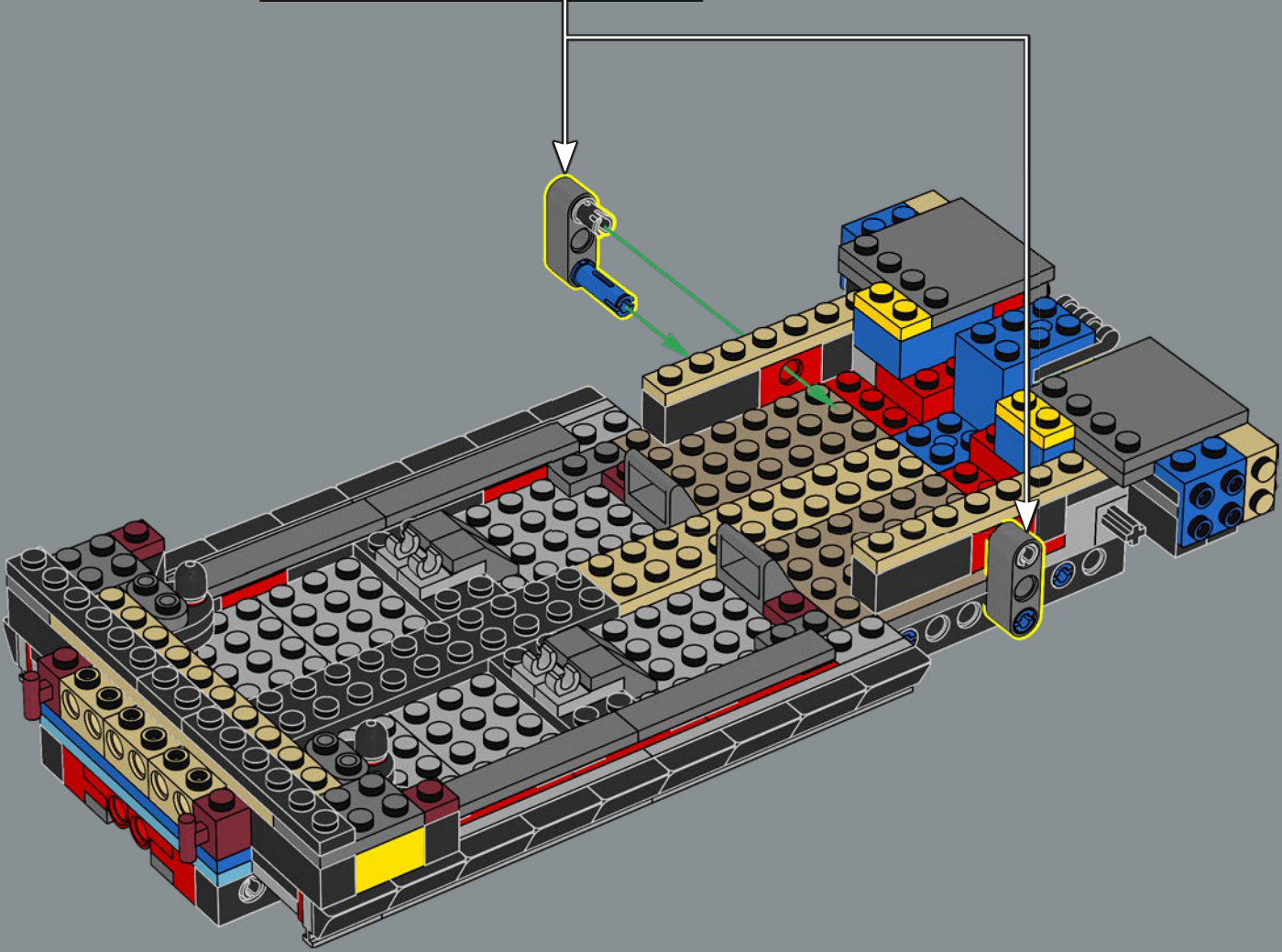
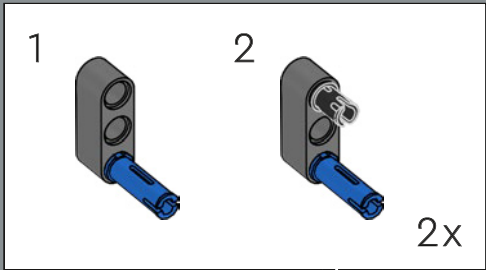

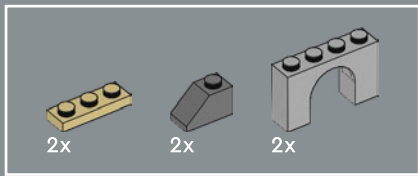

42

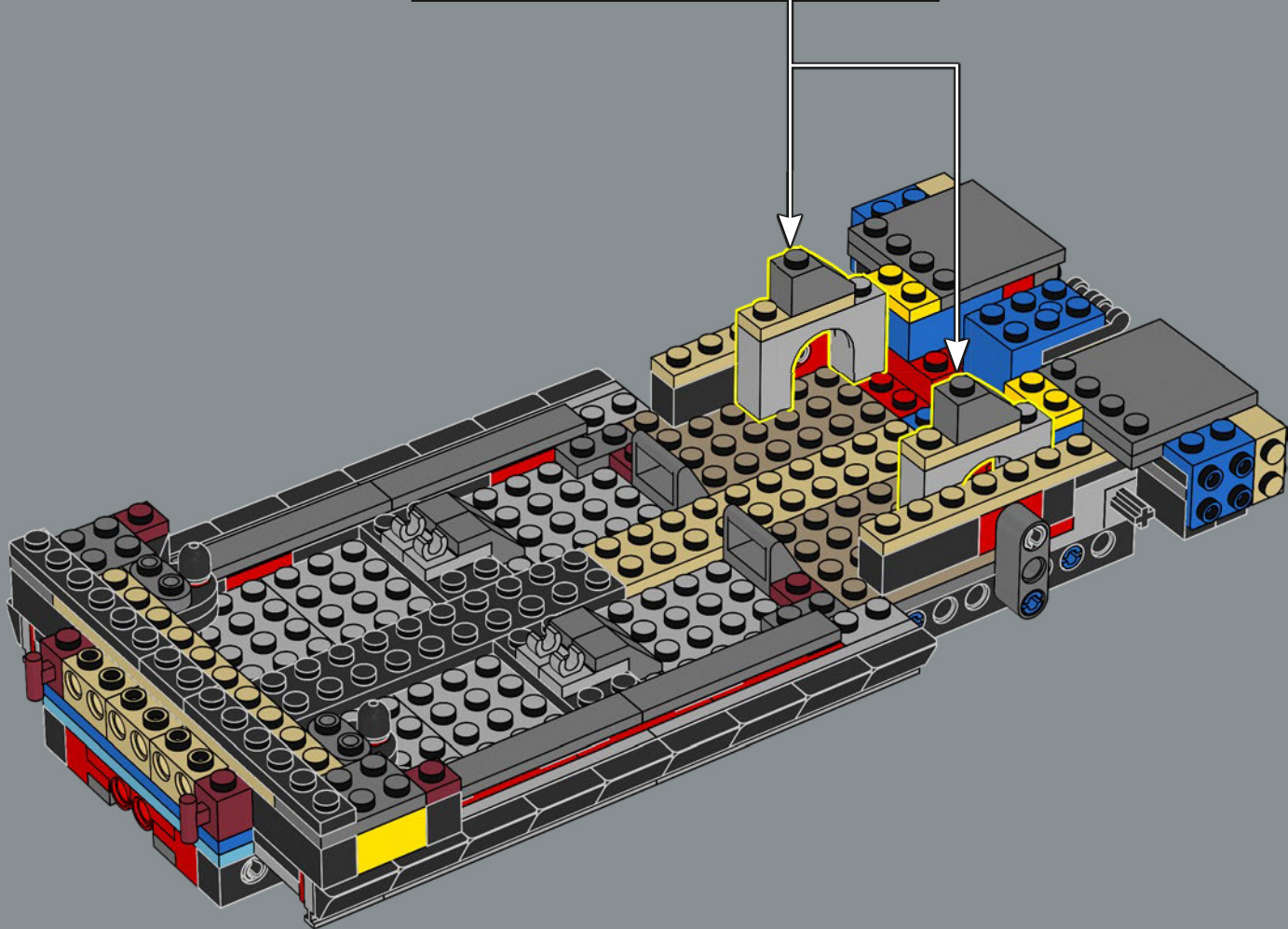
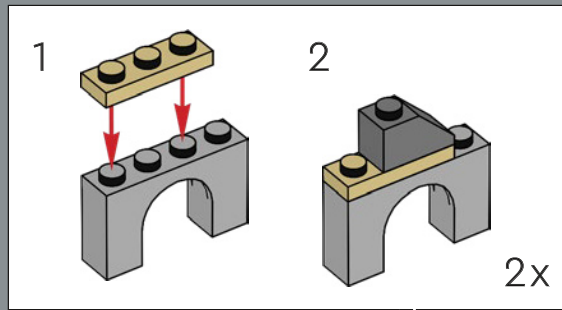

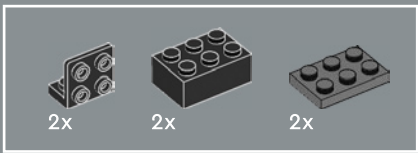

43

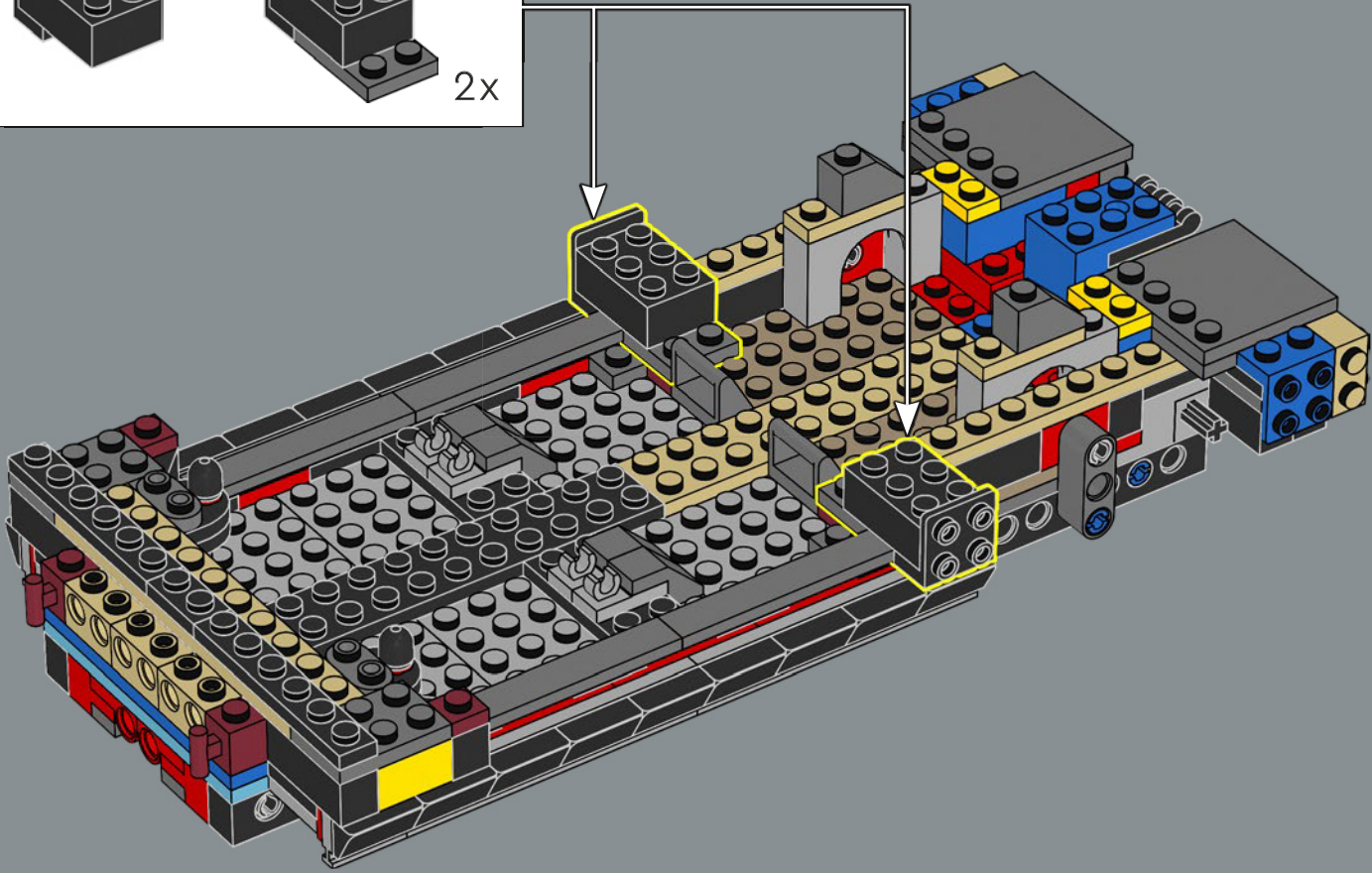
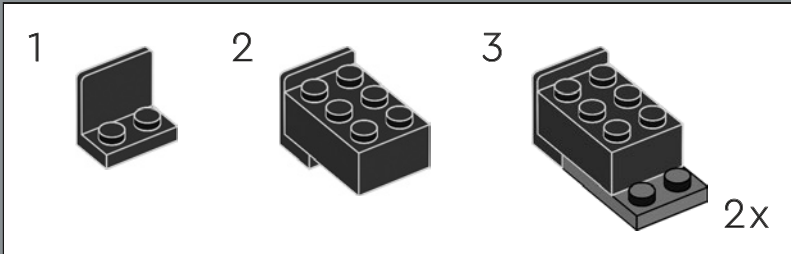

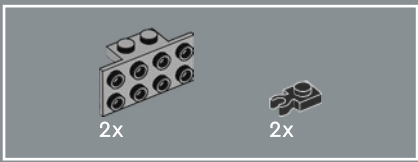

44

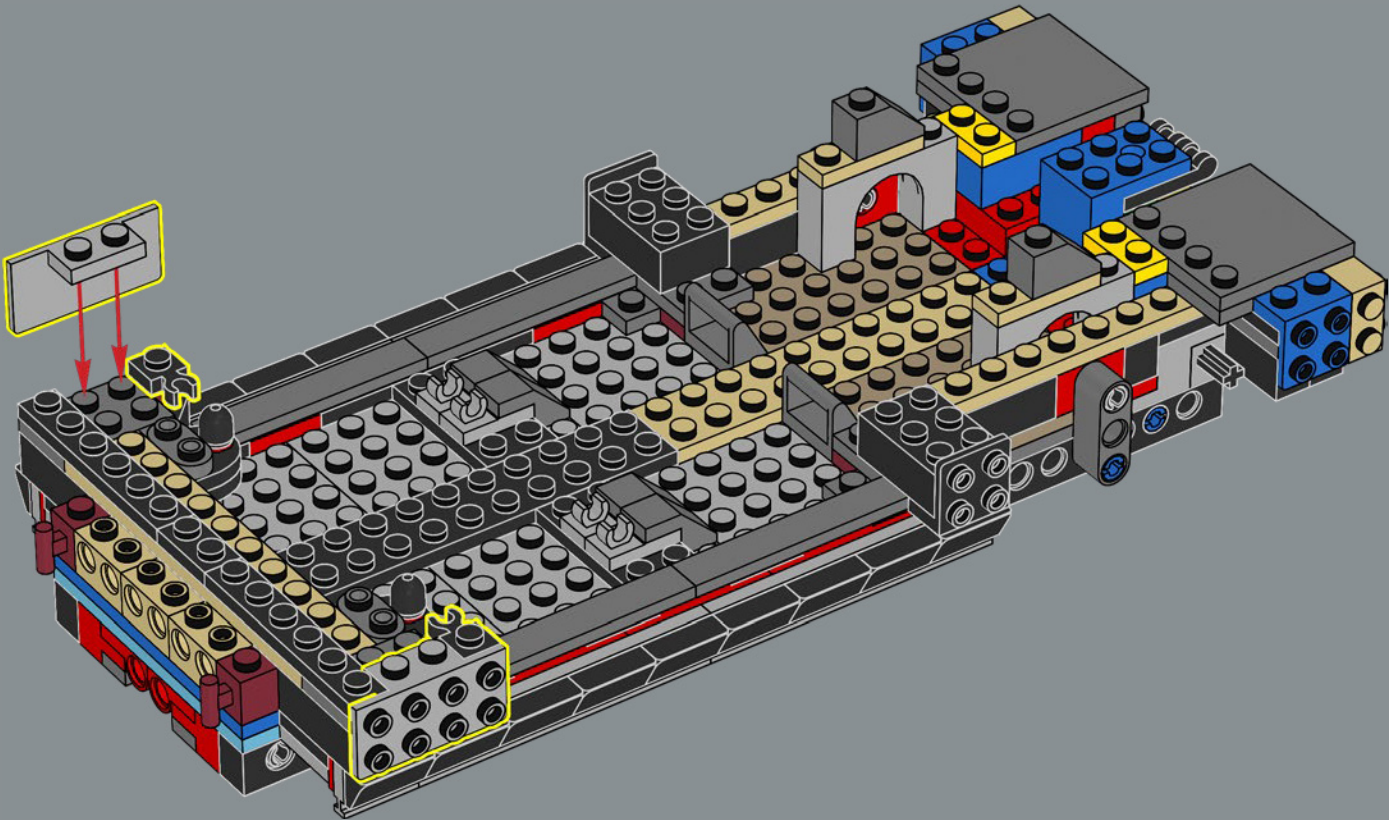

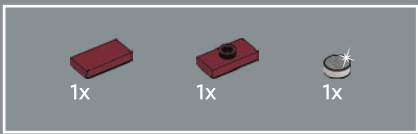

45

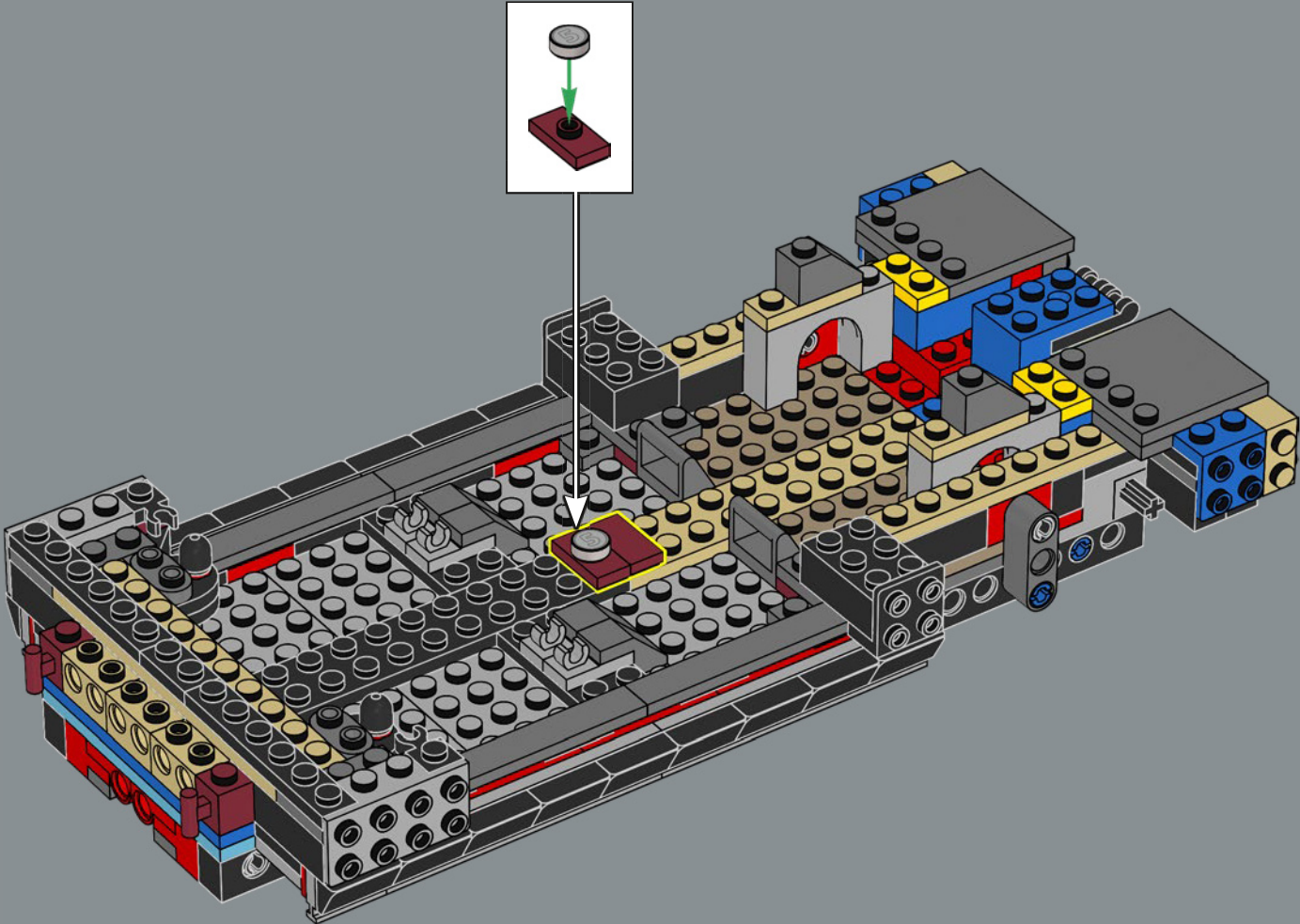

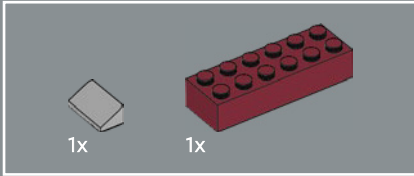
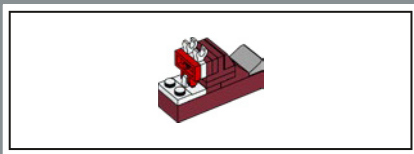

46

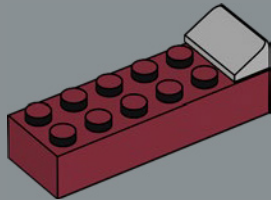

47

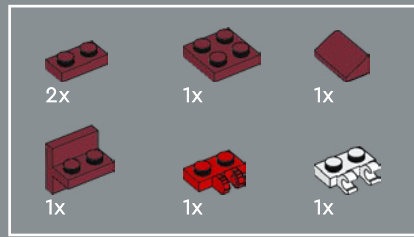
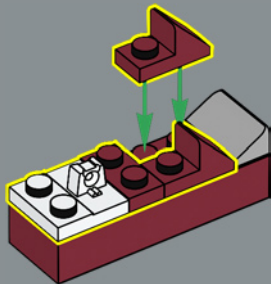

48

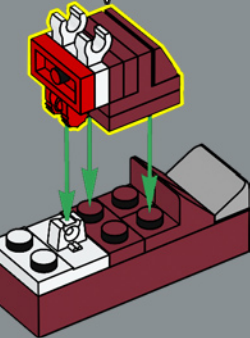
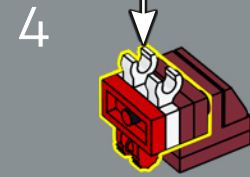
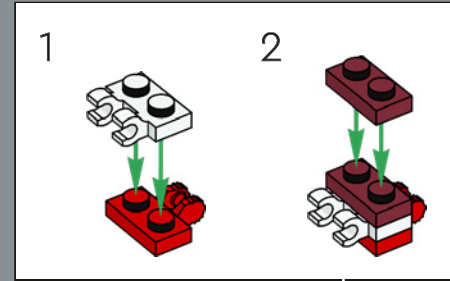
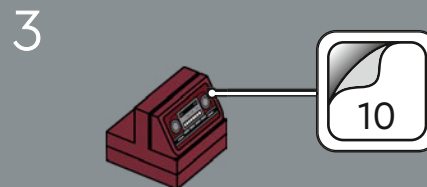
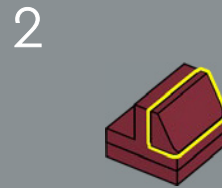
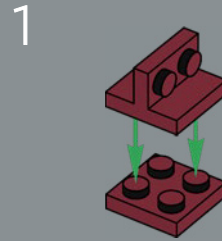

The first pilot prototype Camaro ever built, Chassis no. 10001 still exists and is listed in the National Historic Vehicle Register.

49

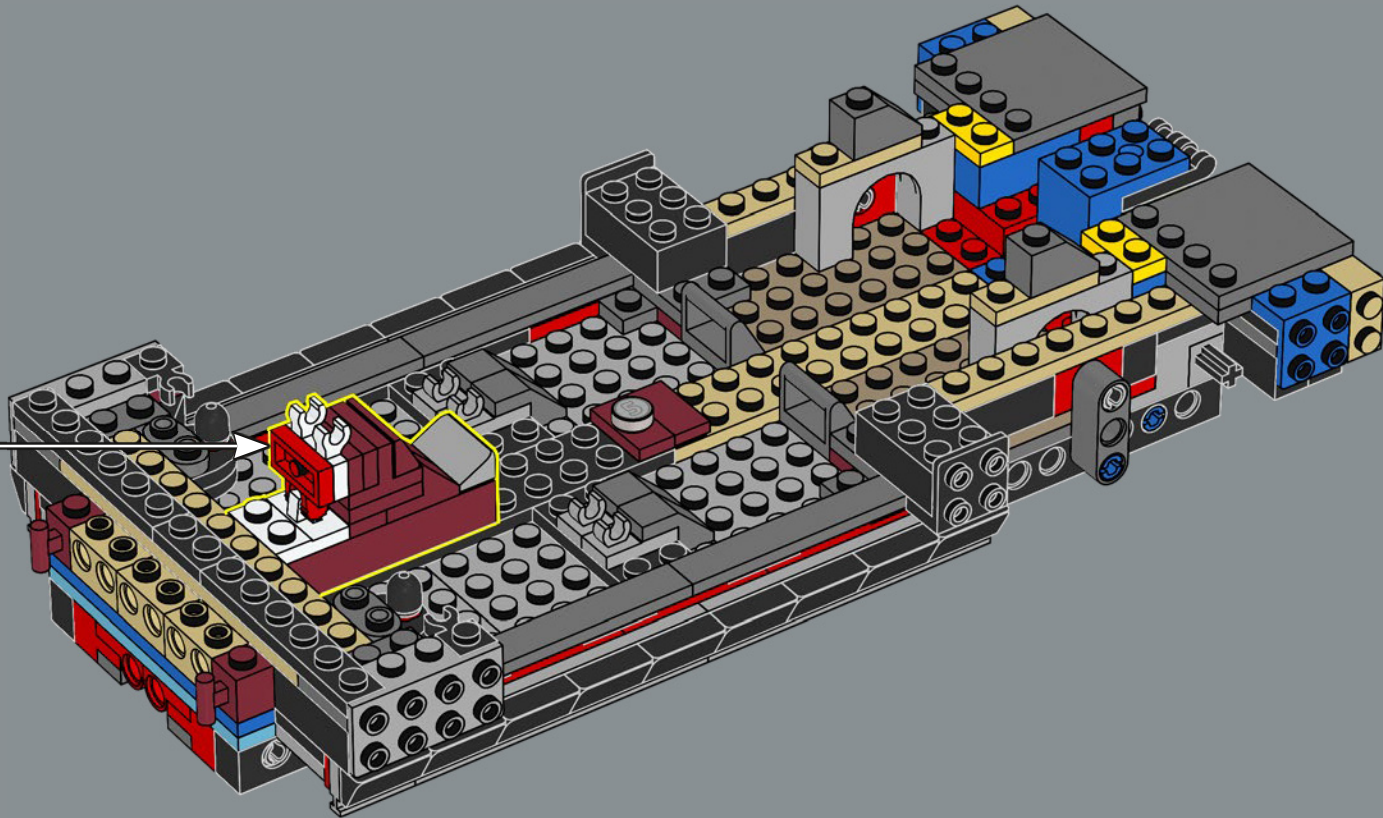

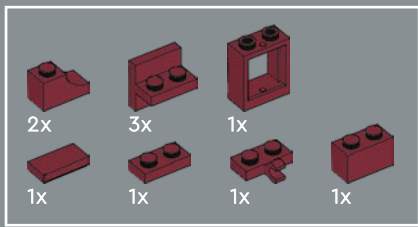

50

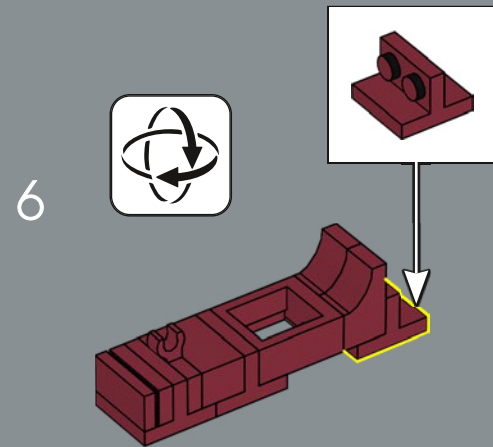
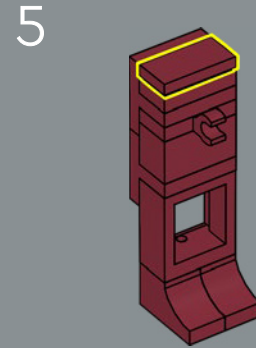
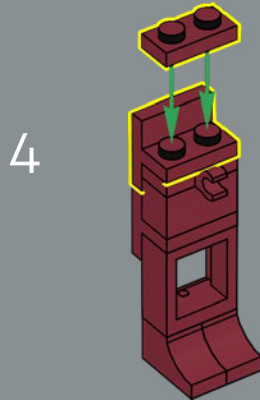
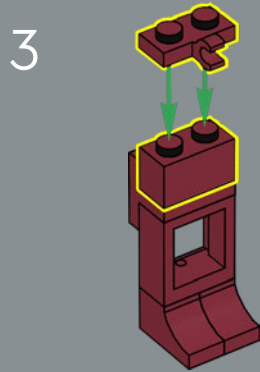
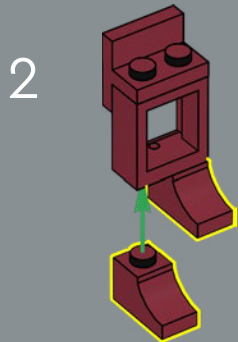
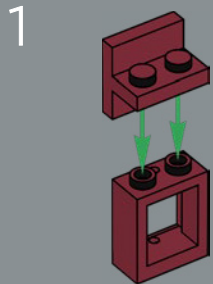

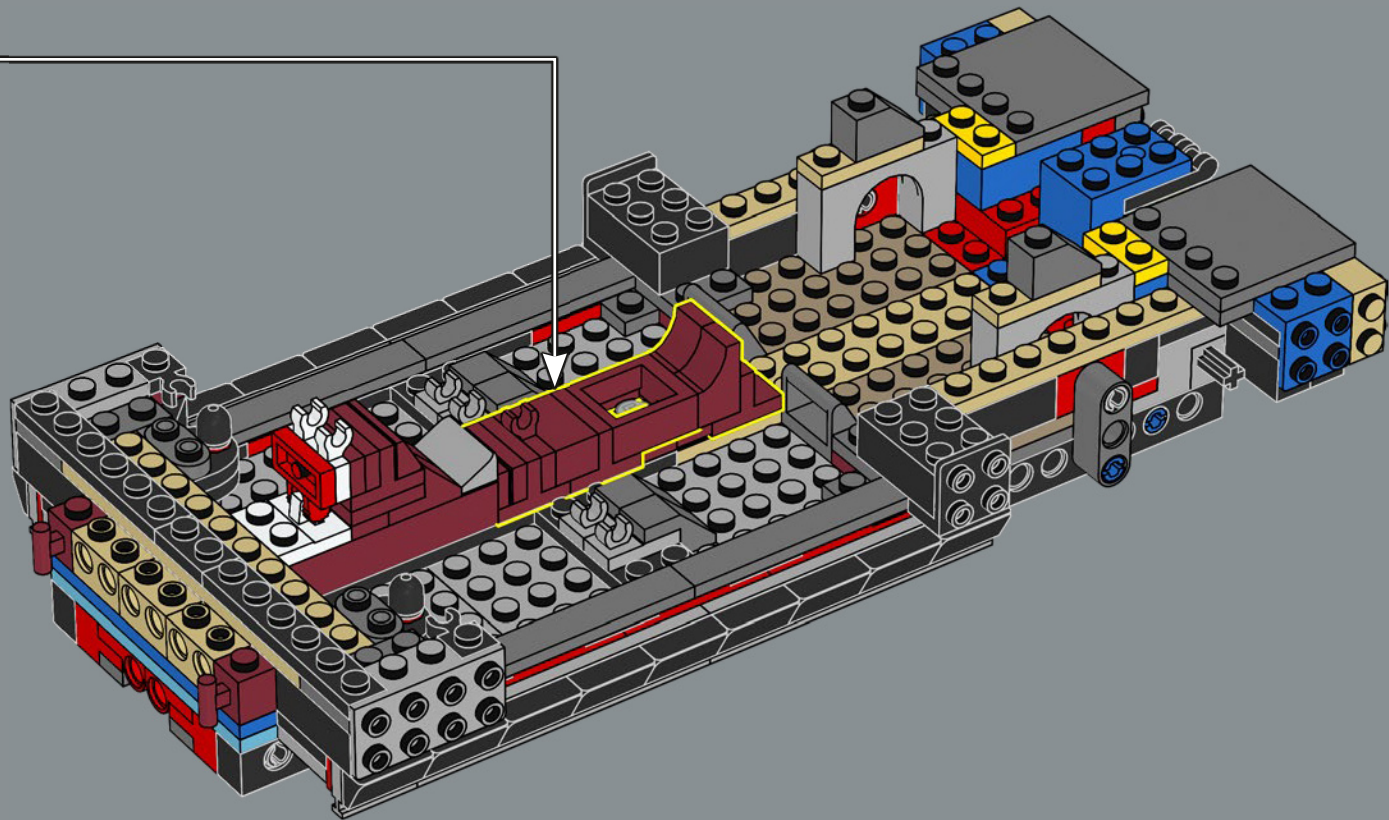

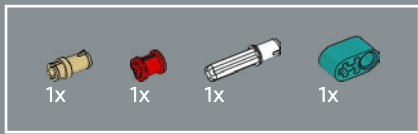

51

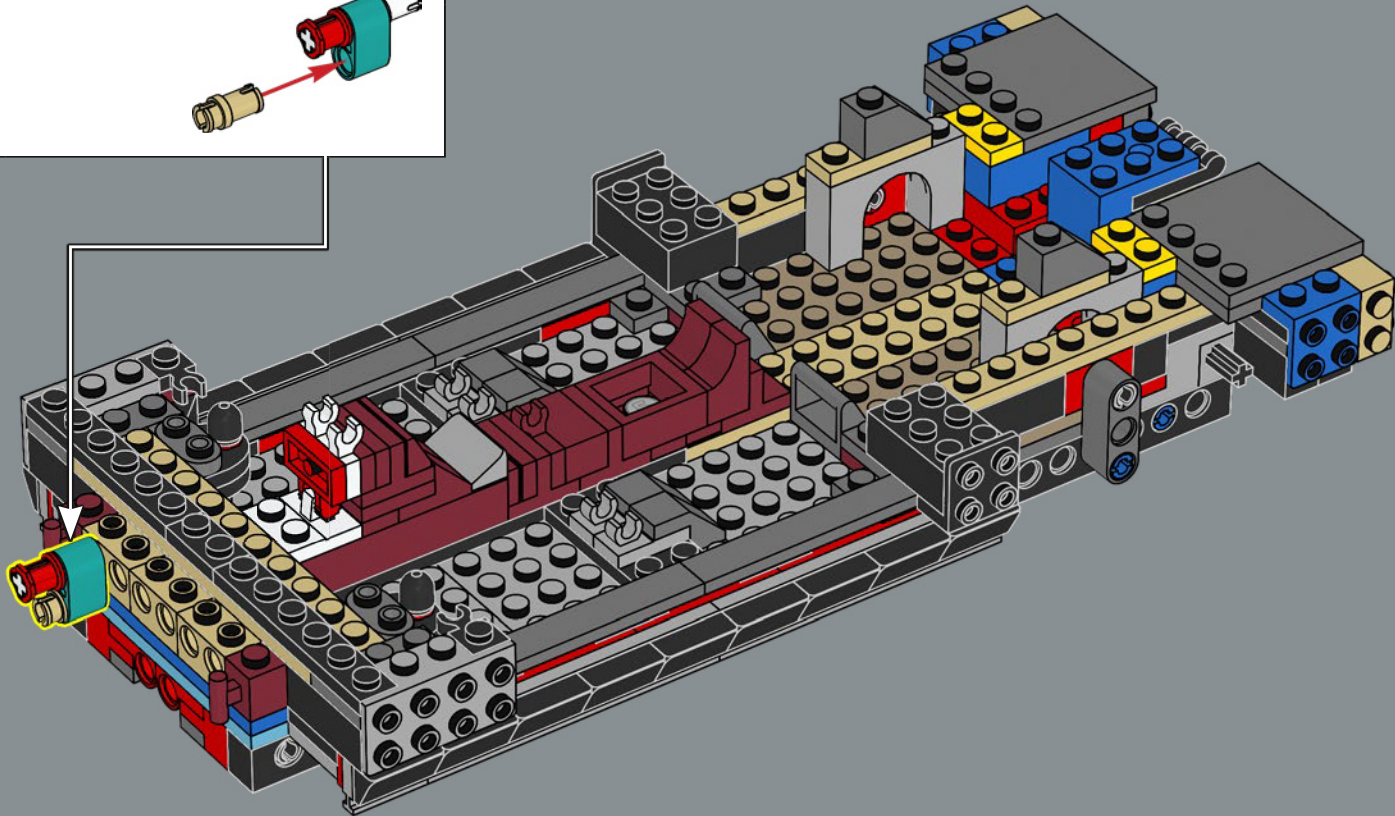
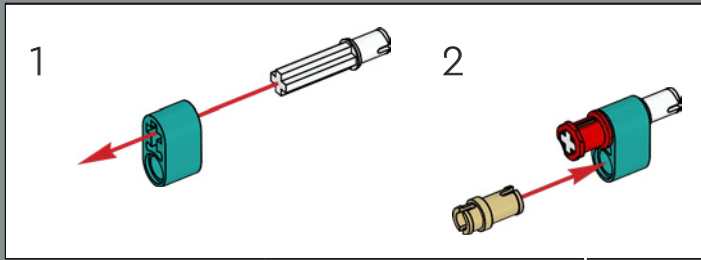

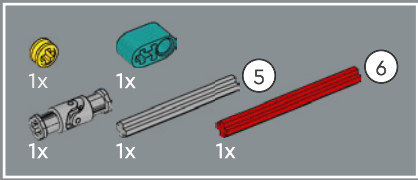

52

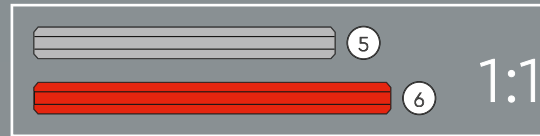
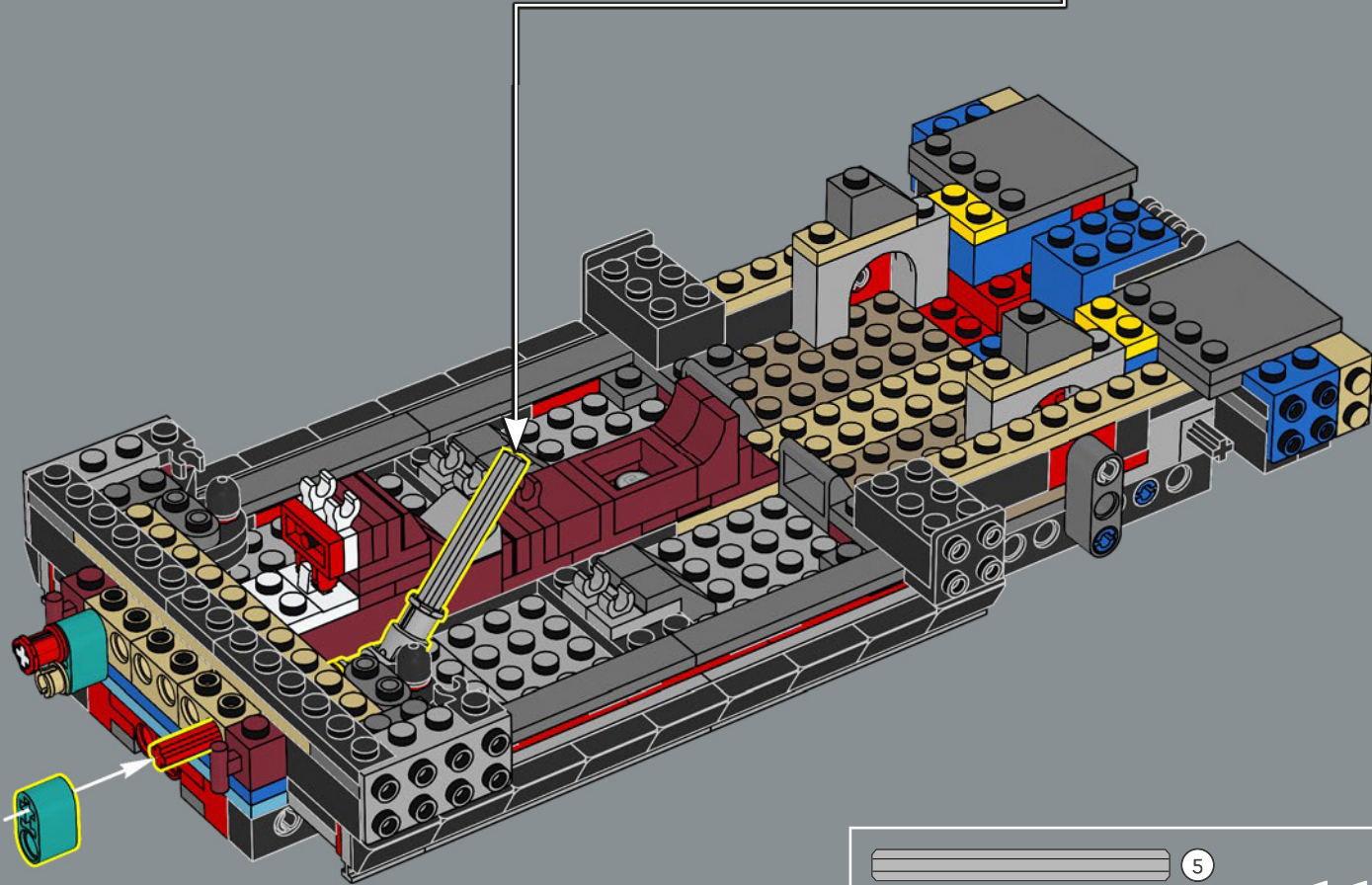
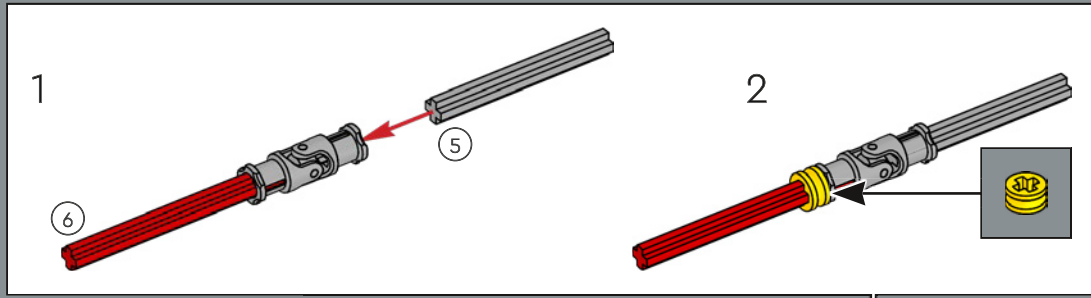



53

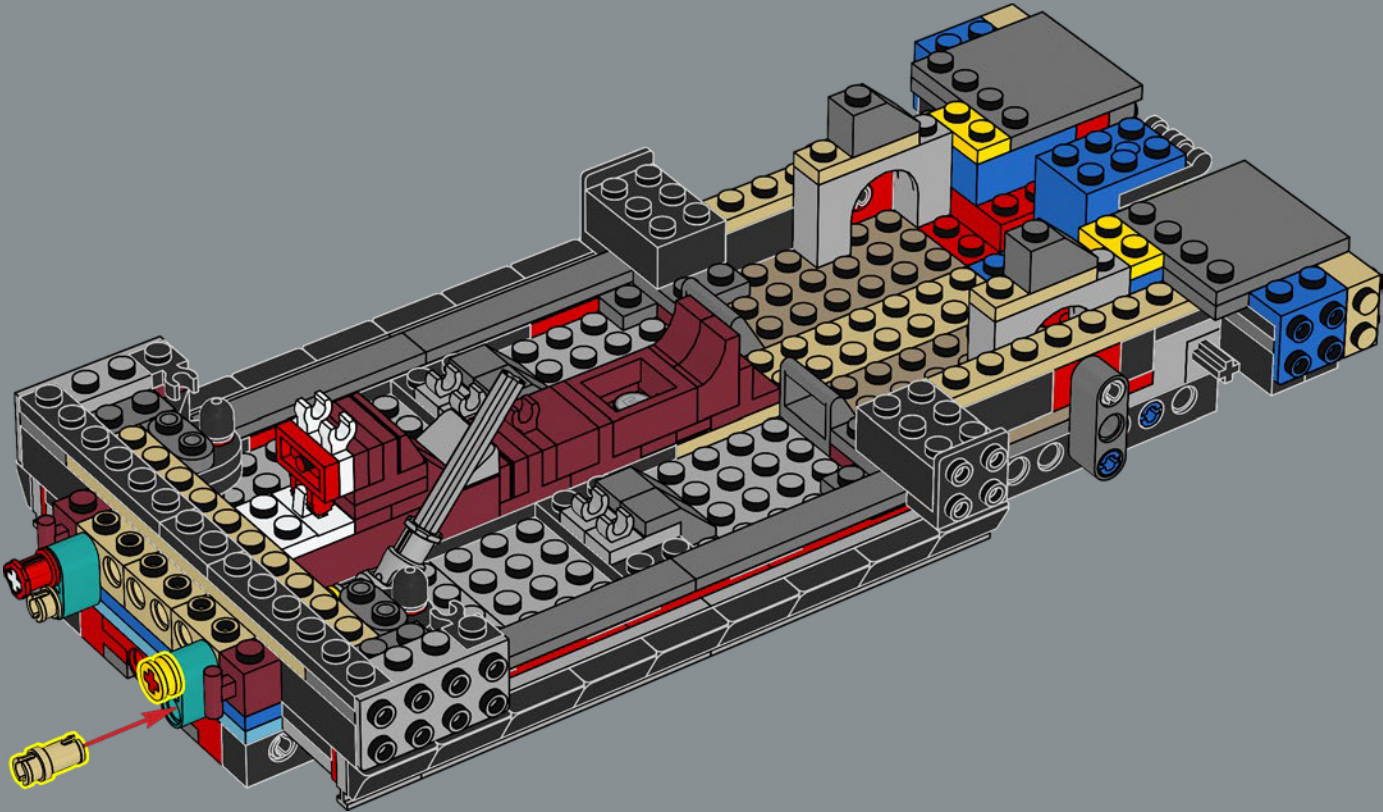

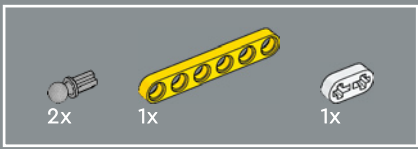

54

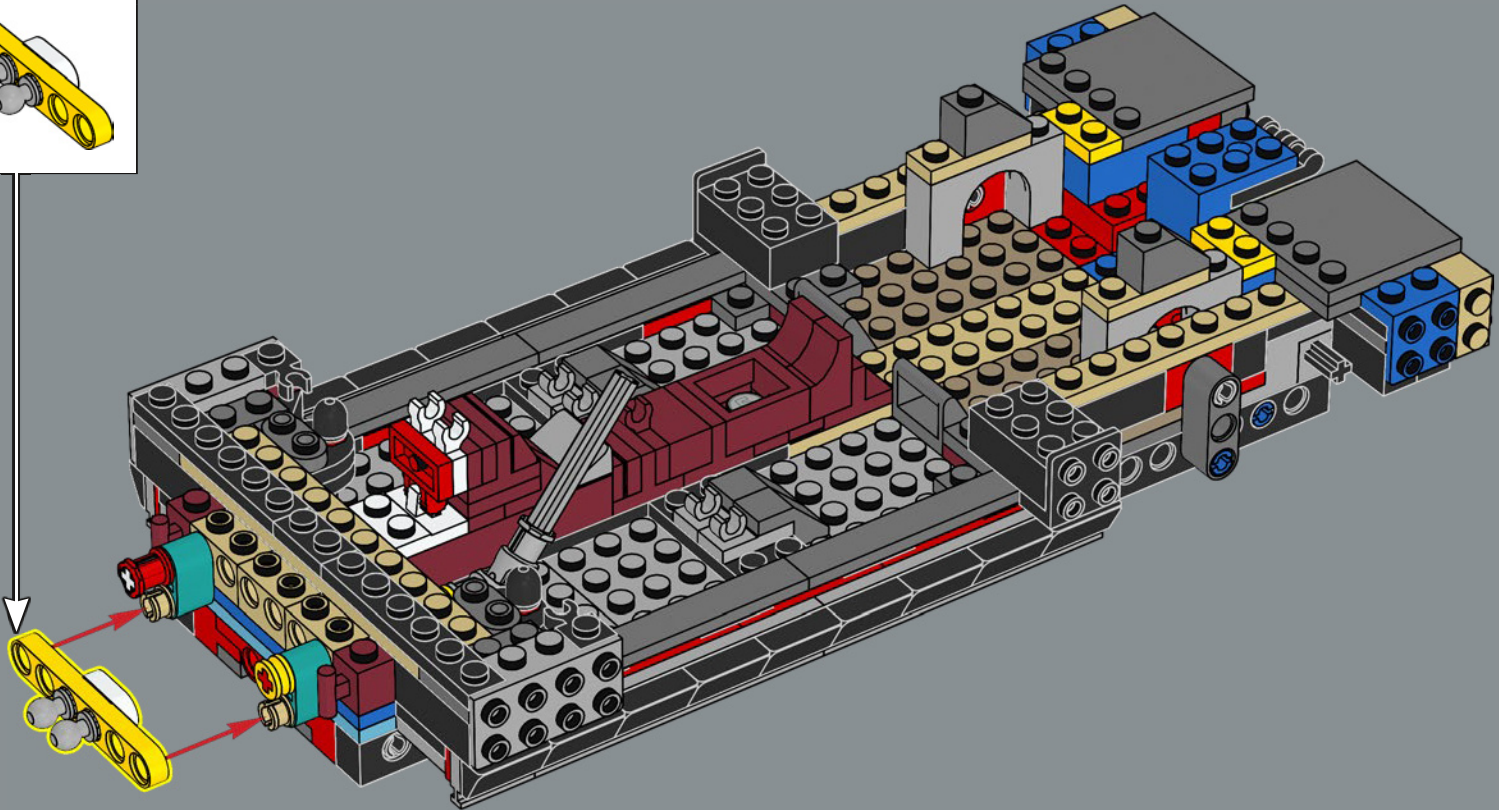
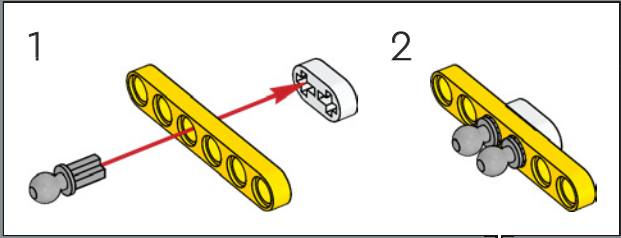

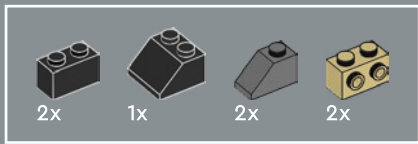

55

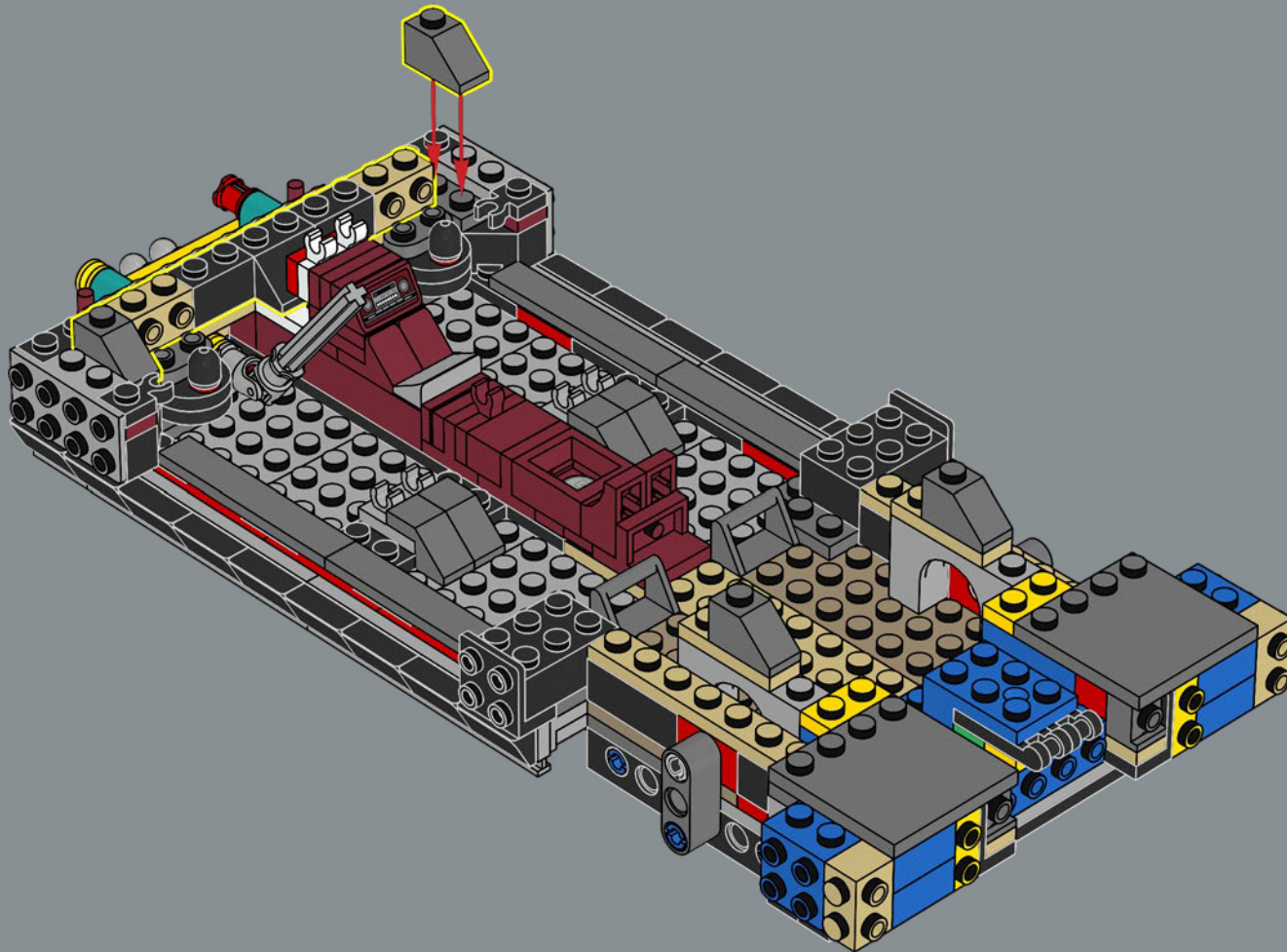

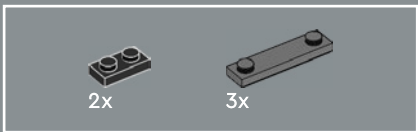

56

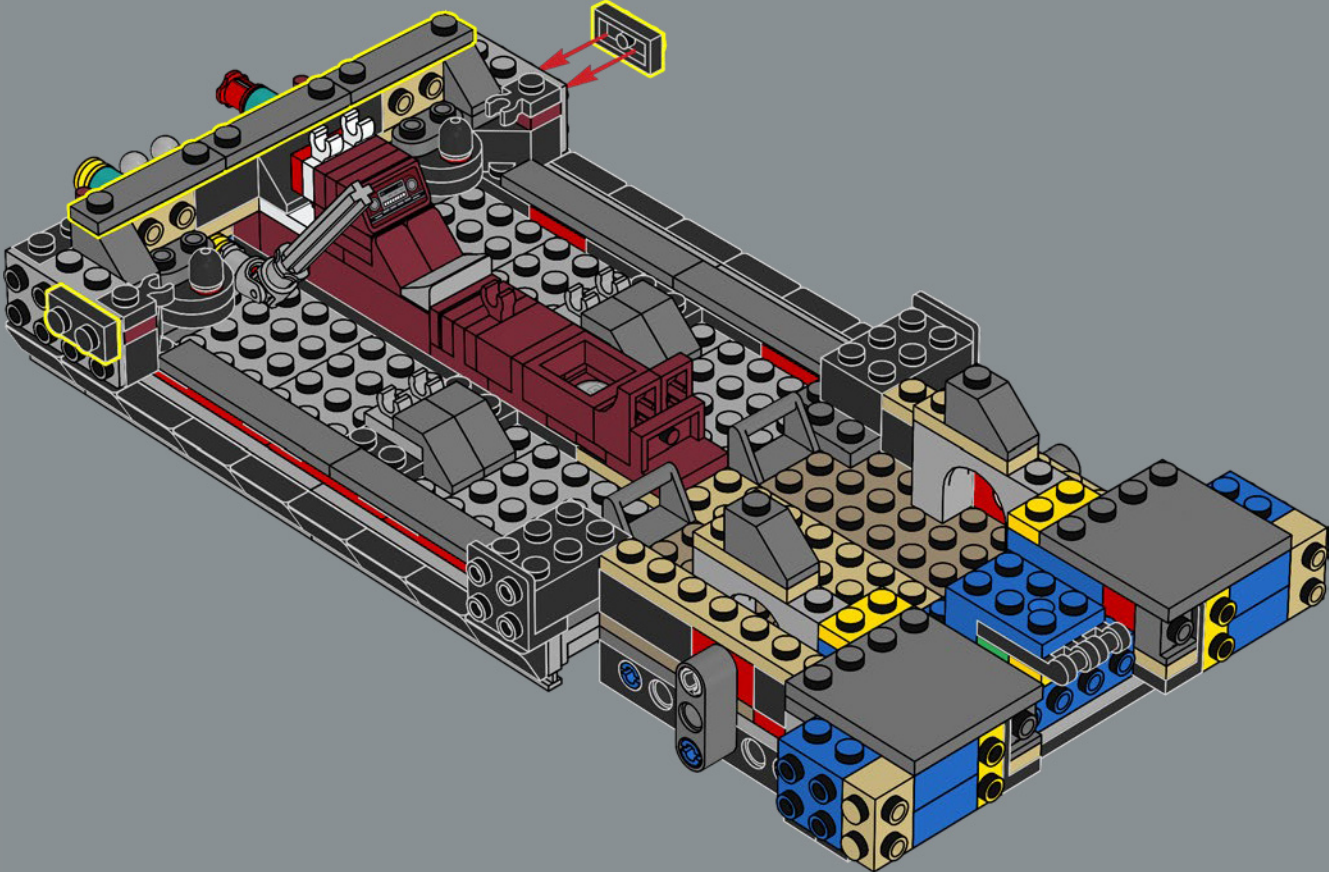

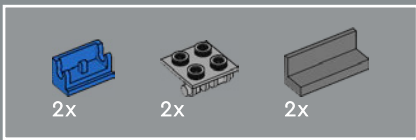

57

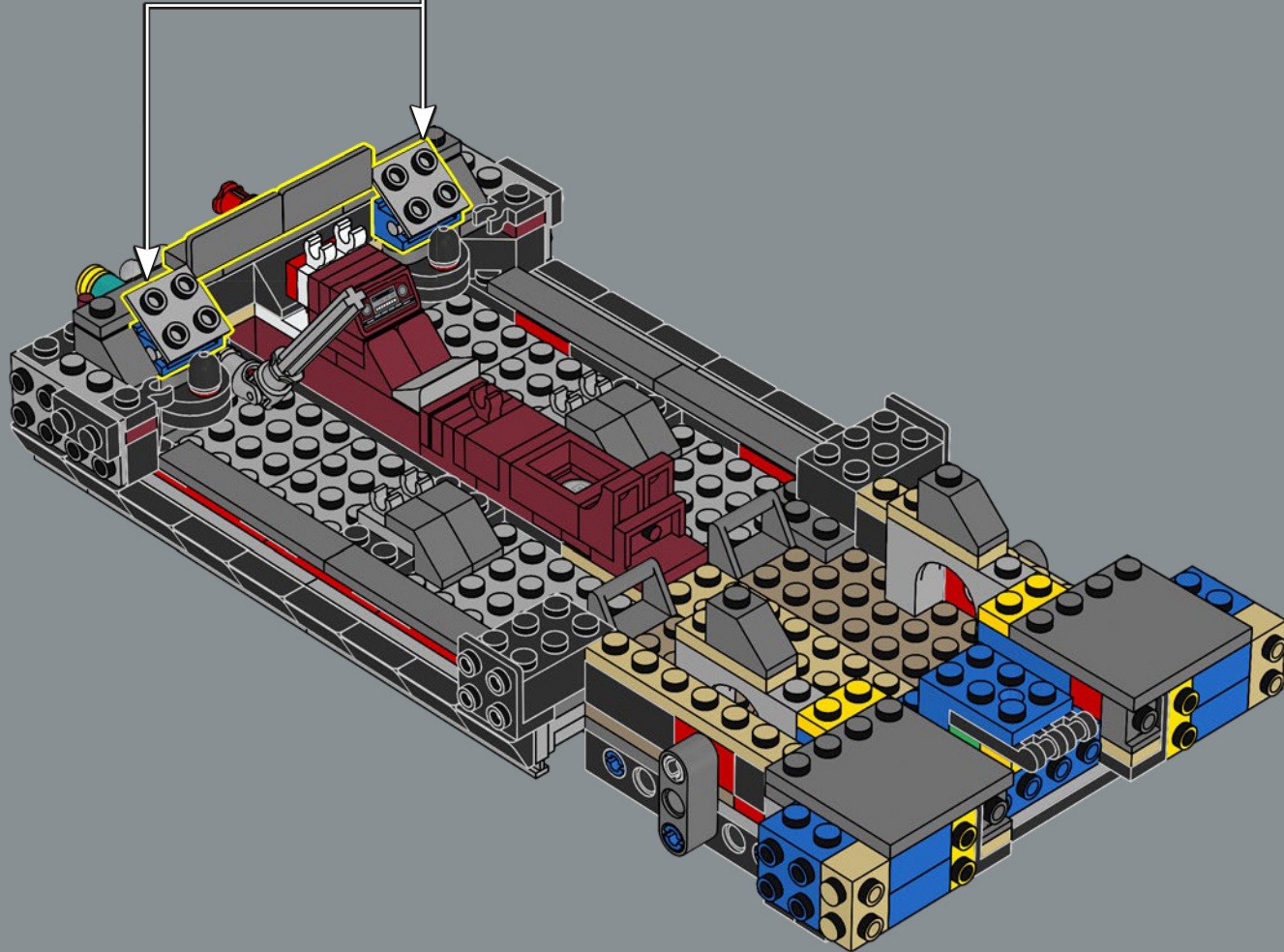
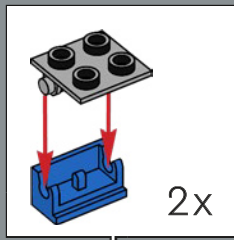



58

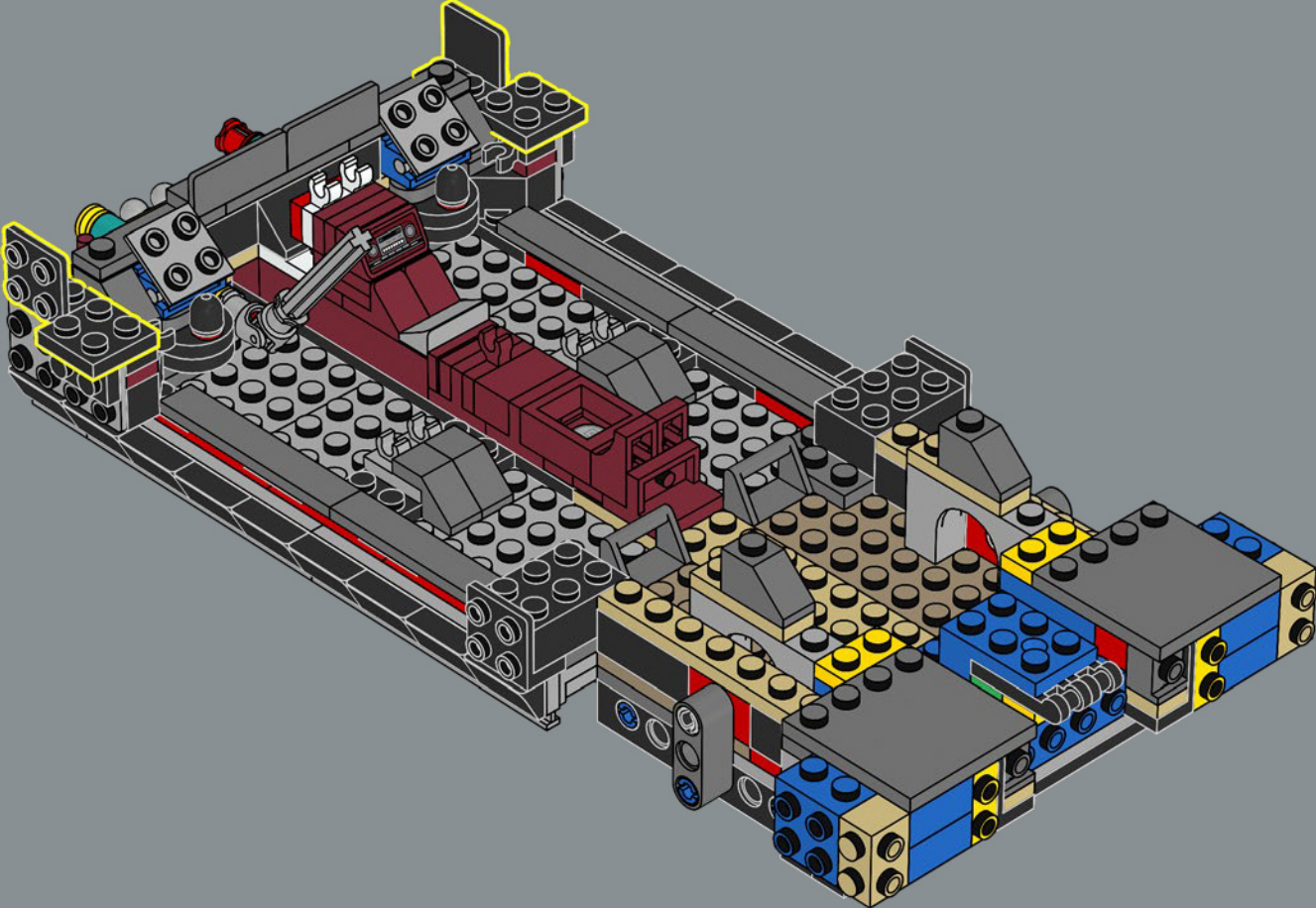

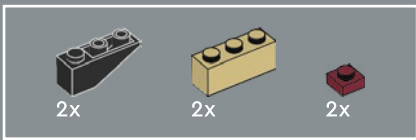

59

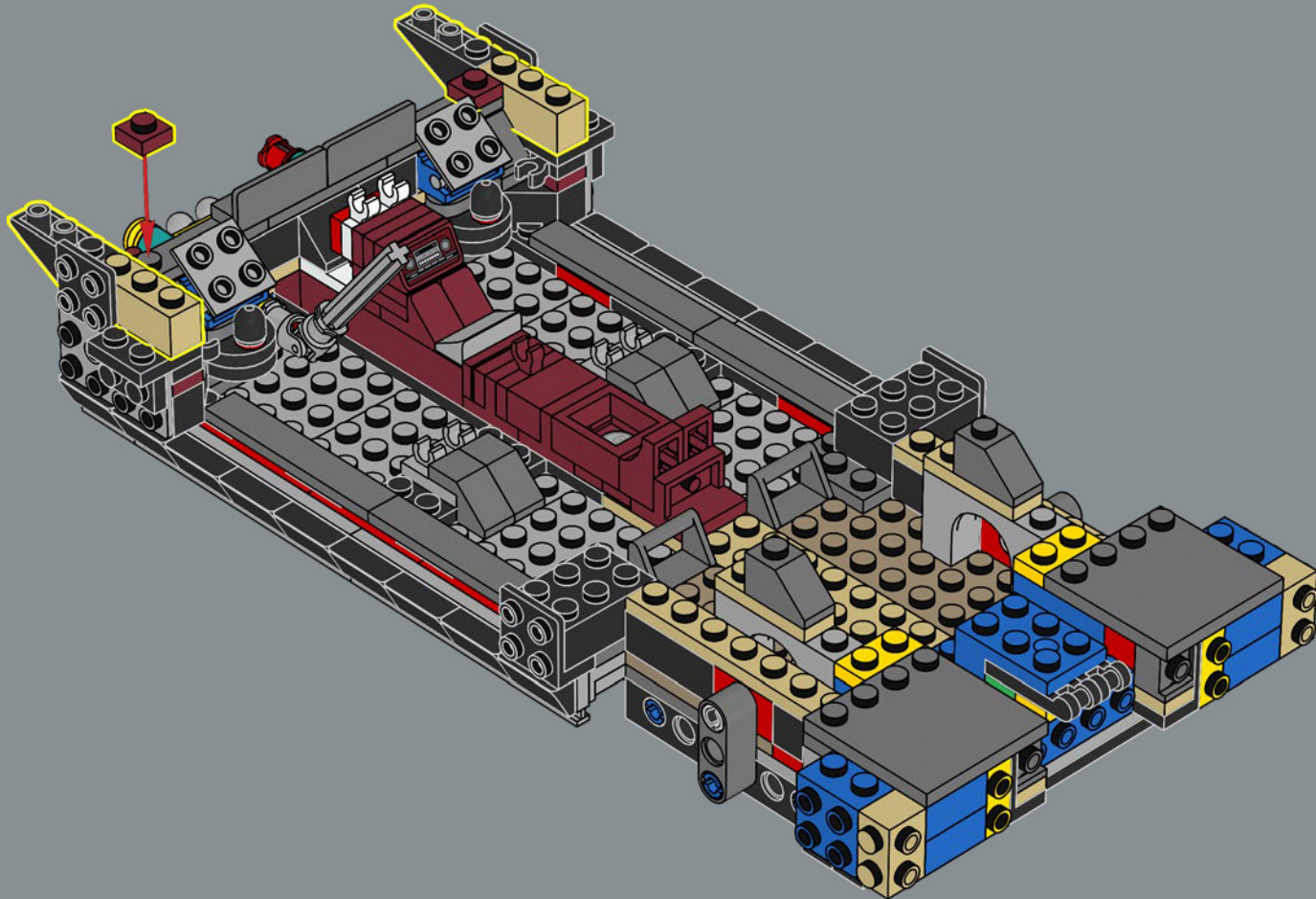



60

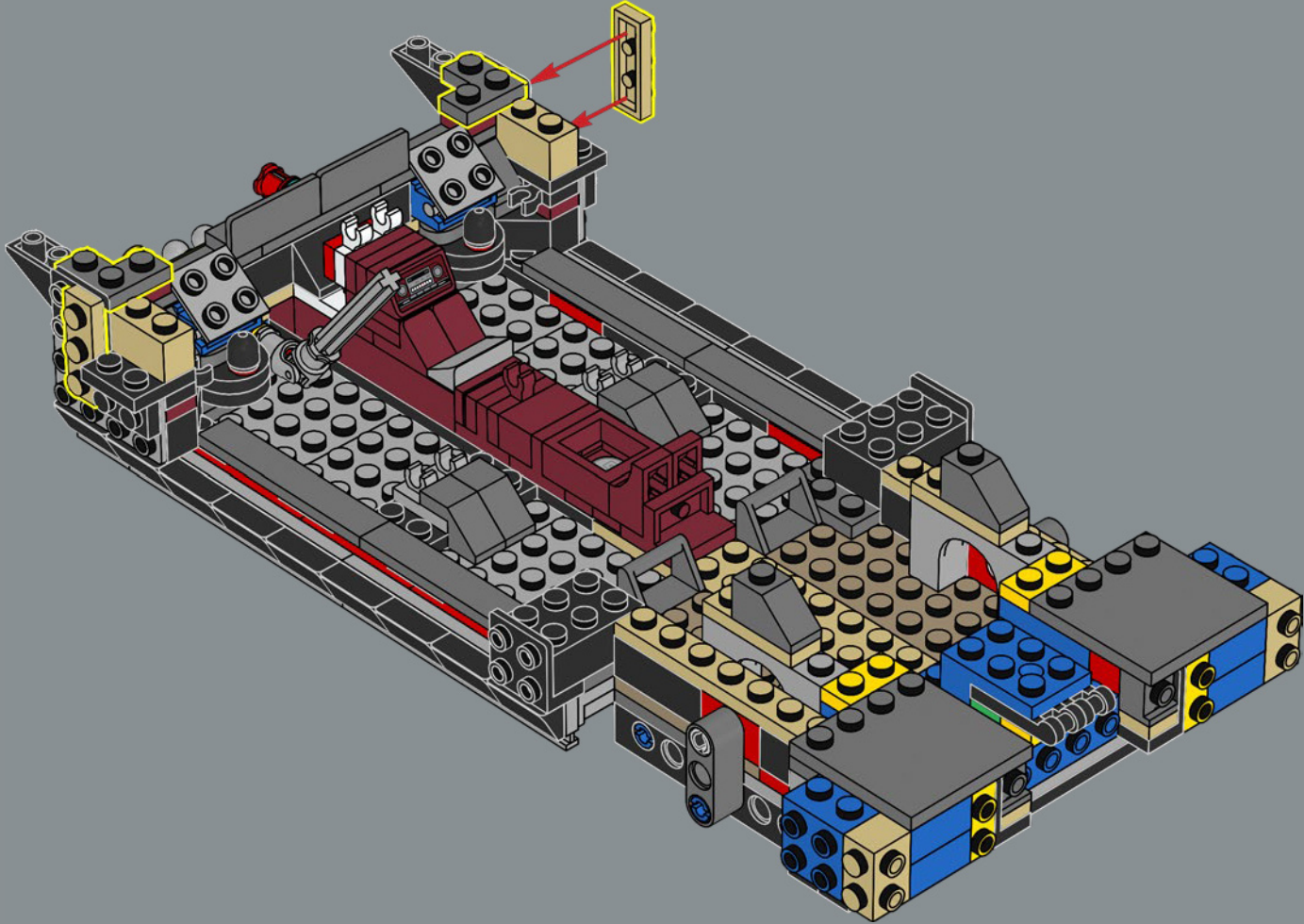

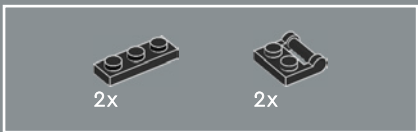

61

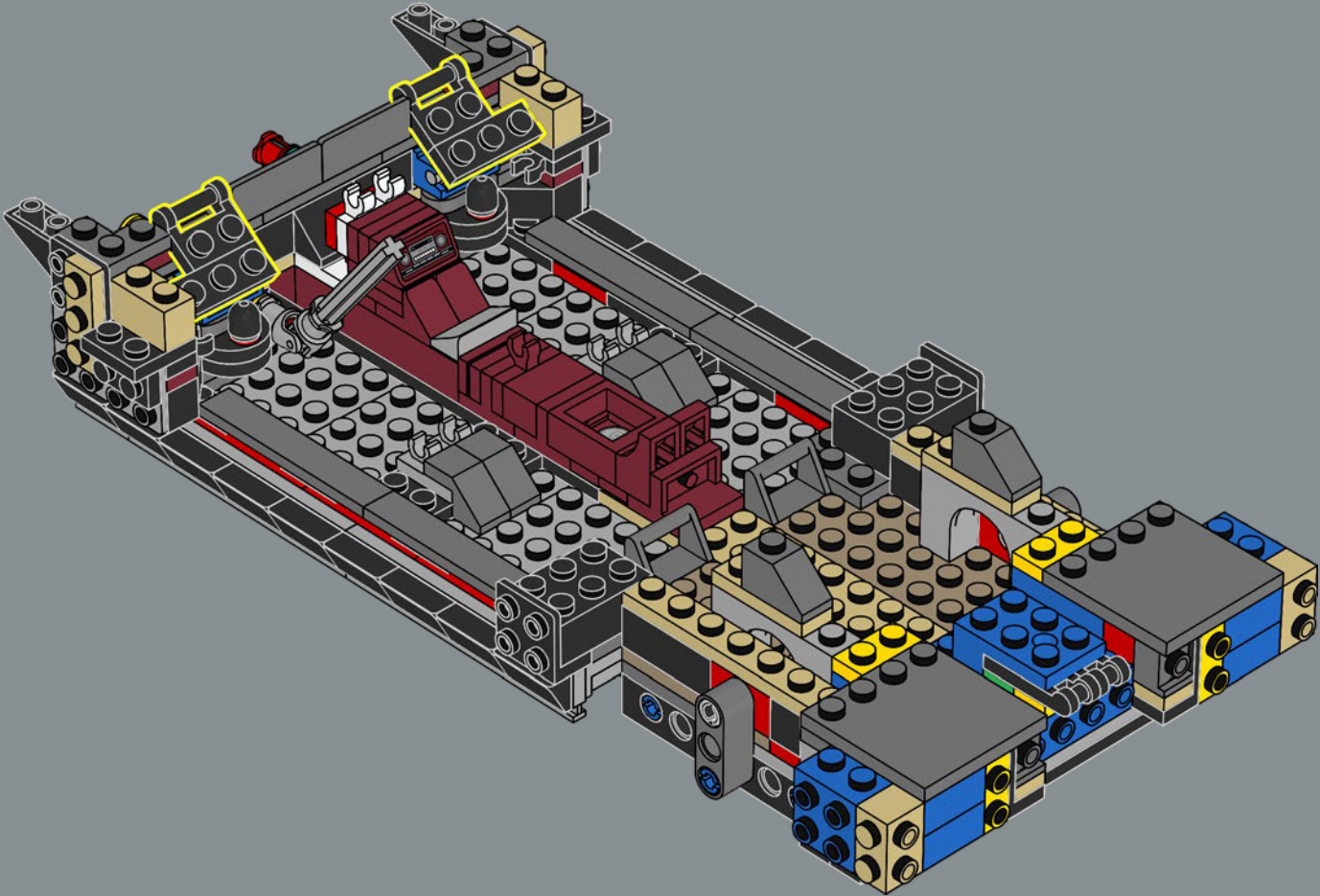

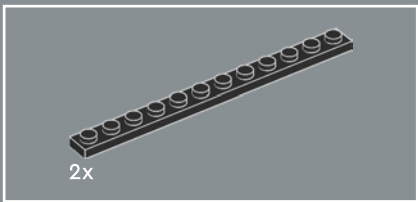

62

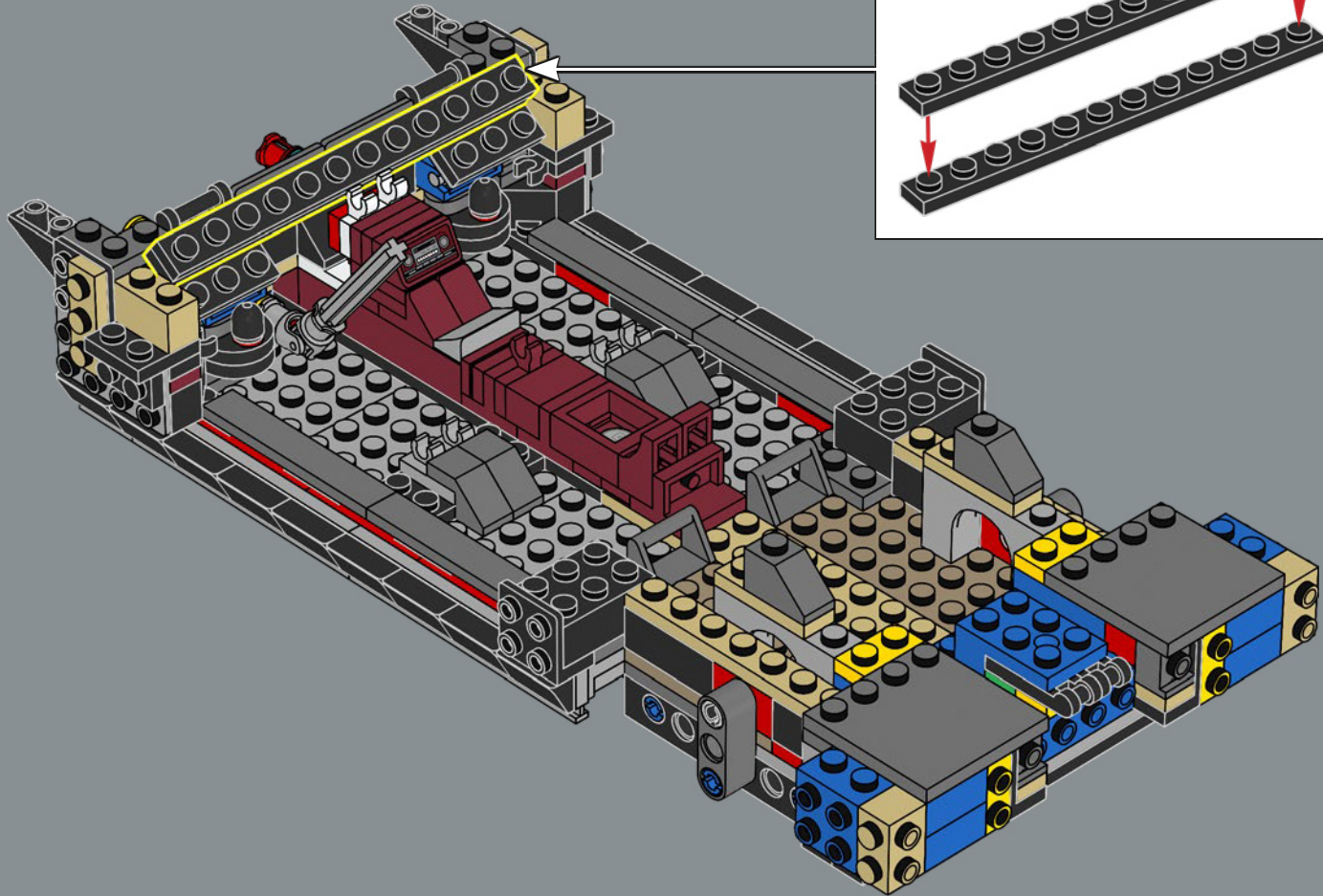

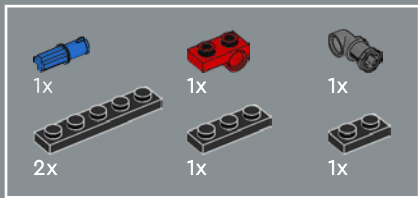

63

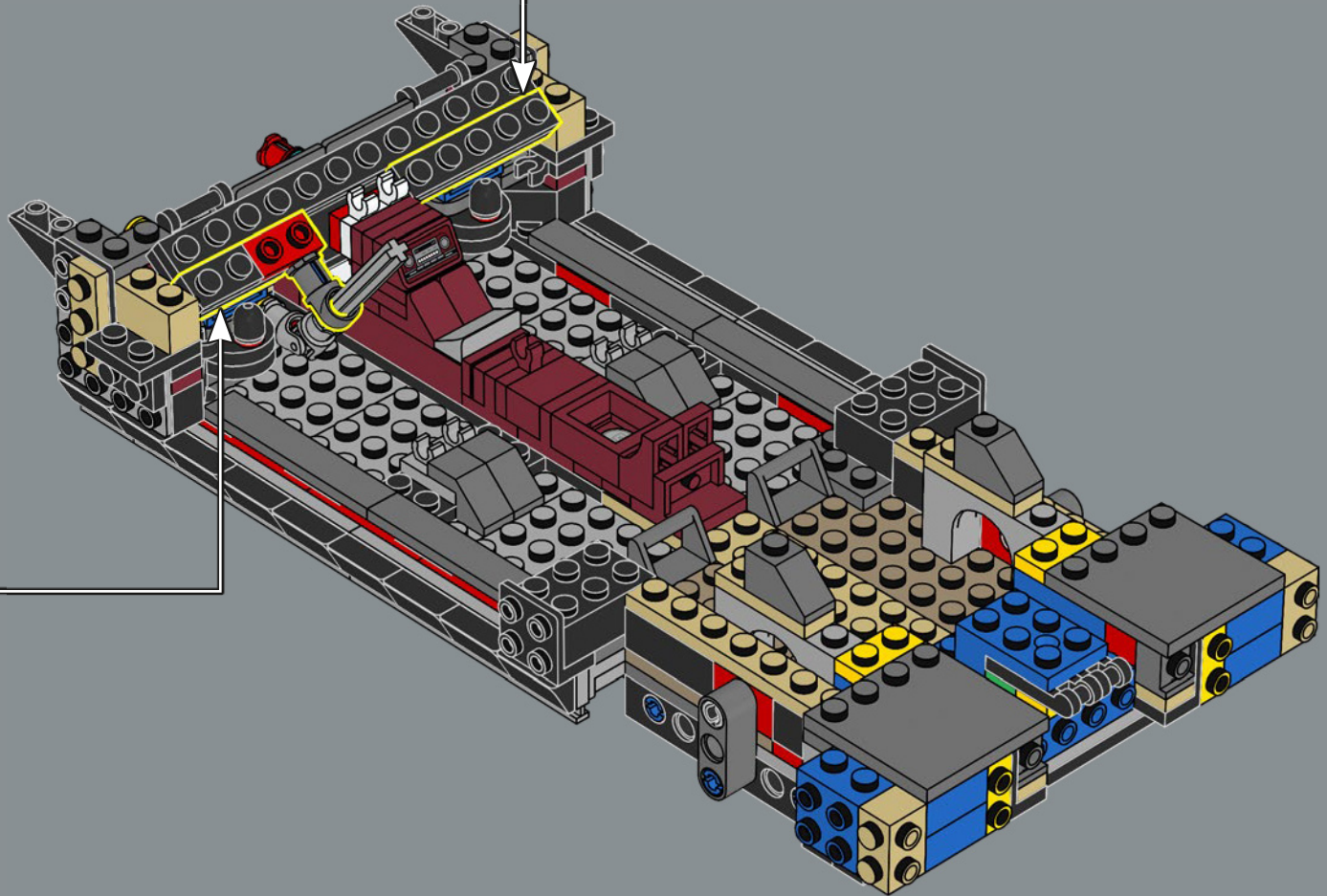
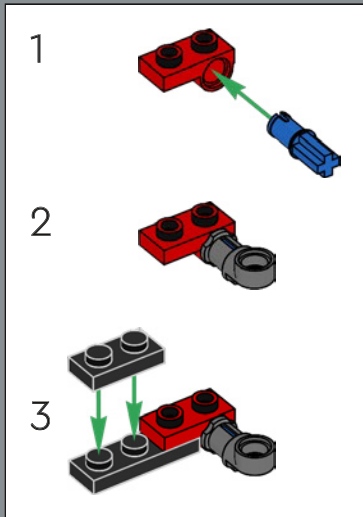
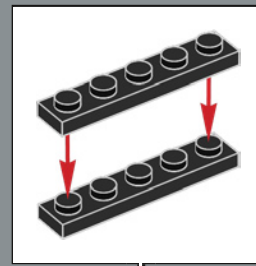

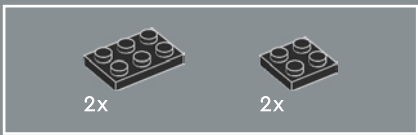

64

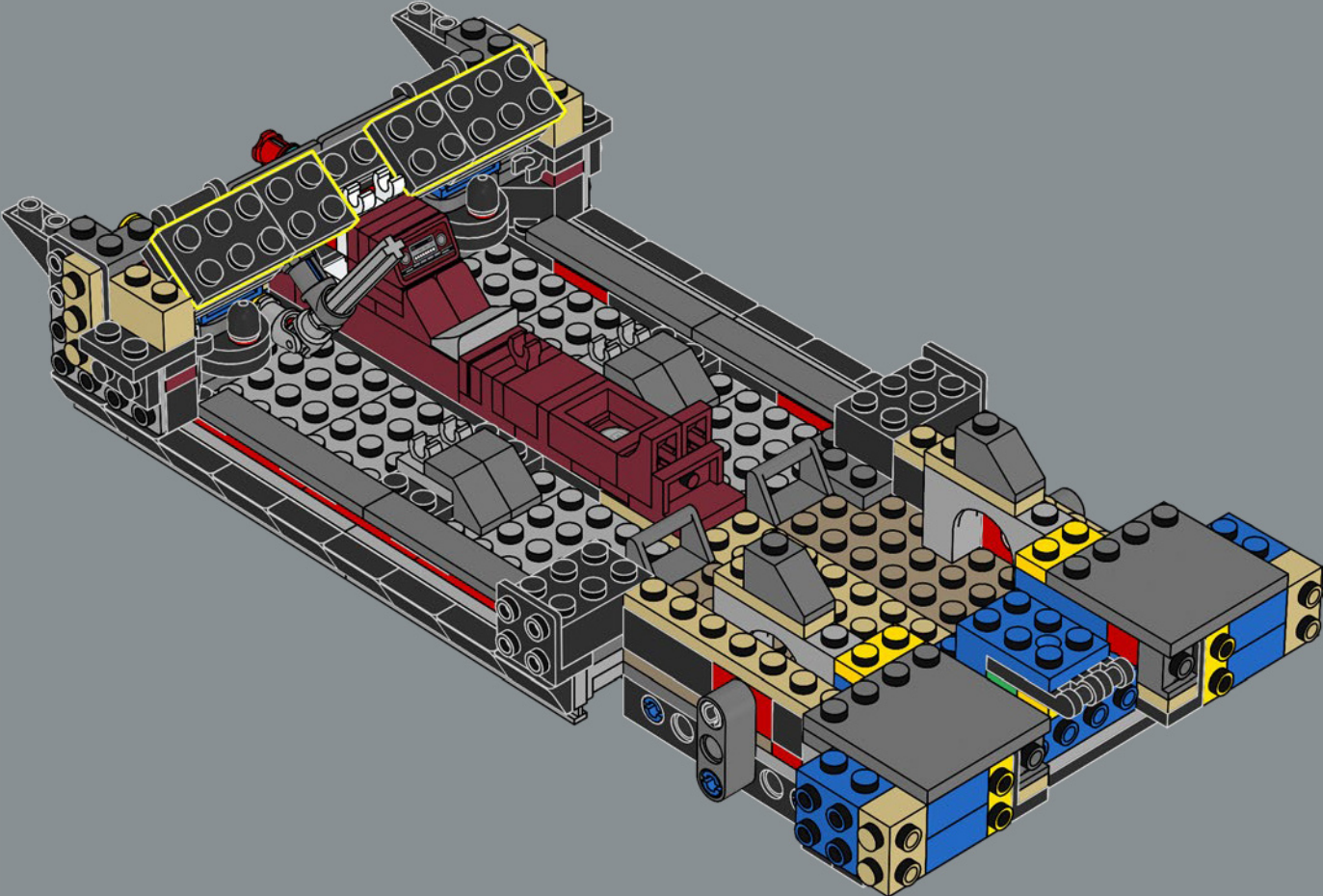



65

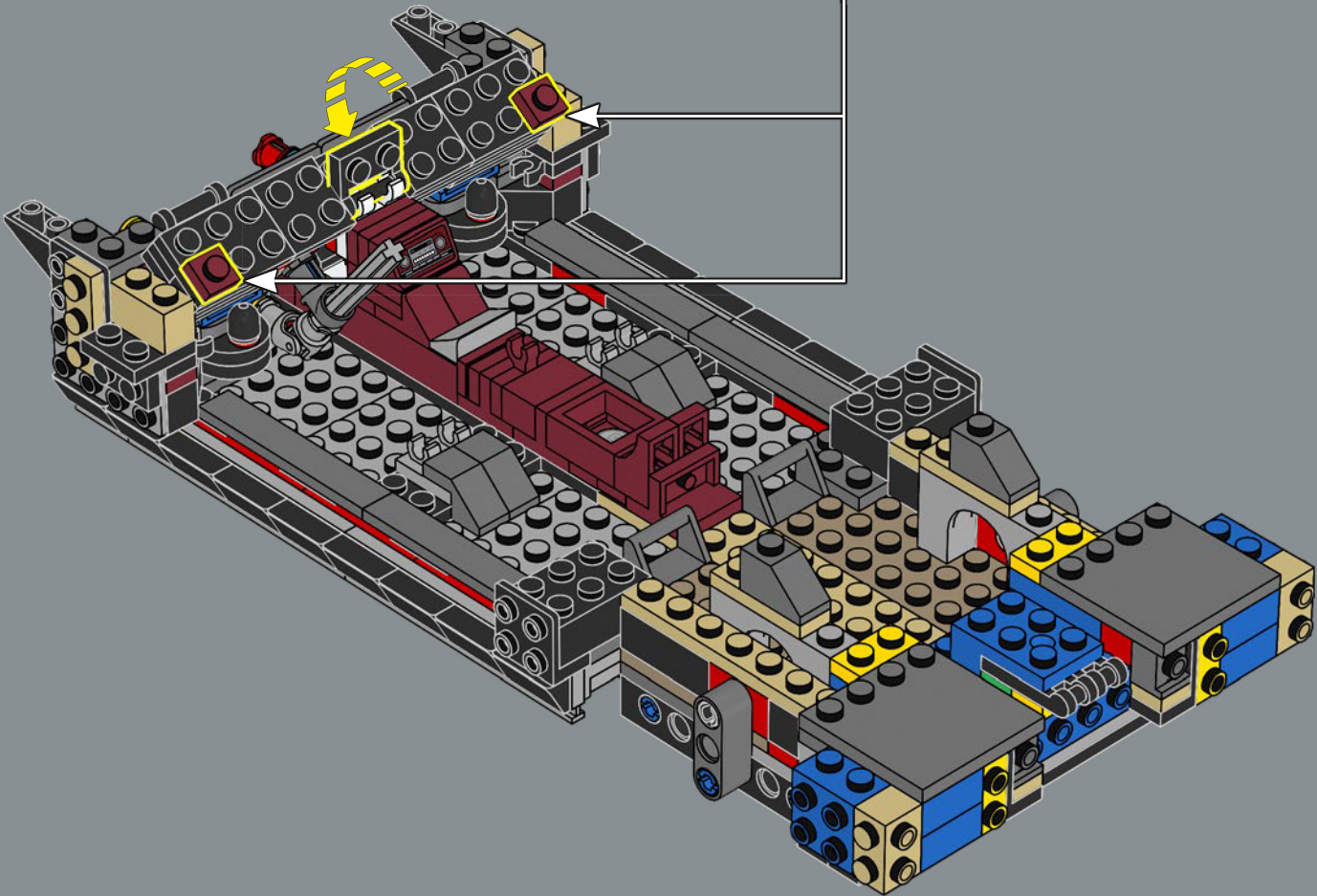
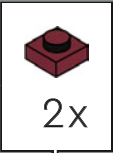

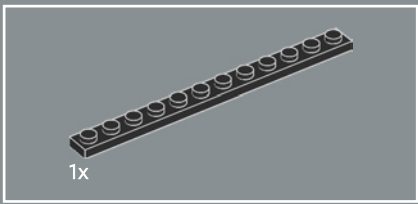

66

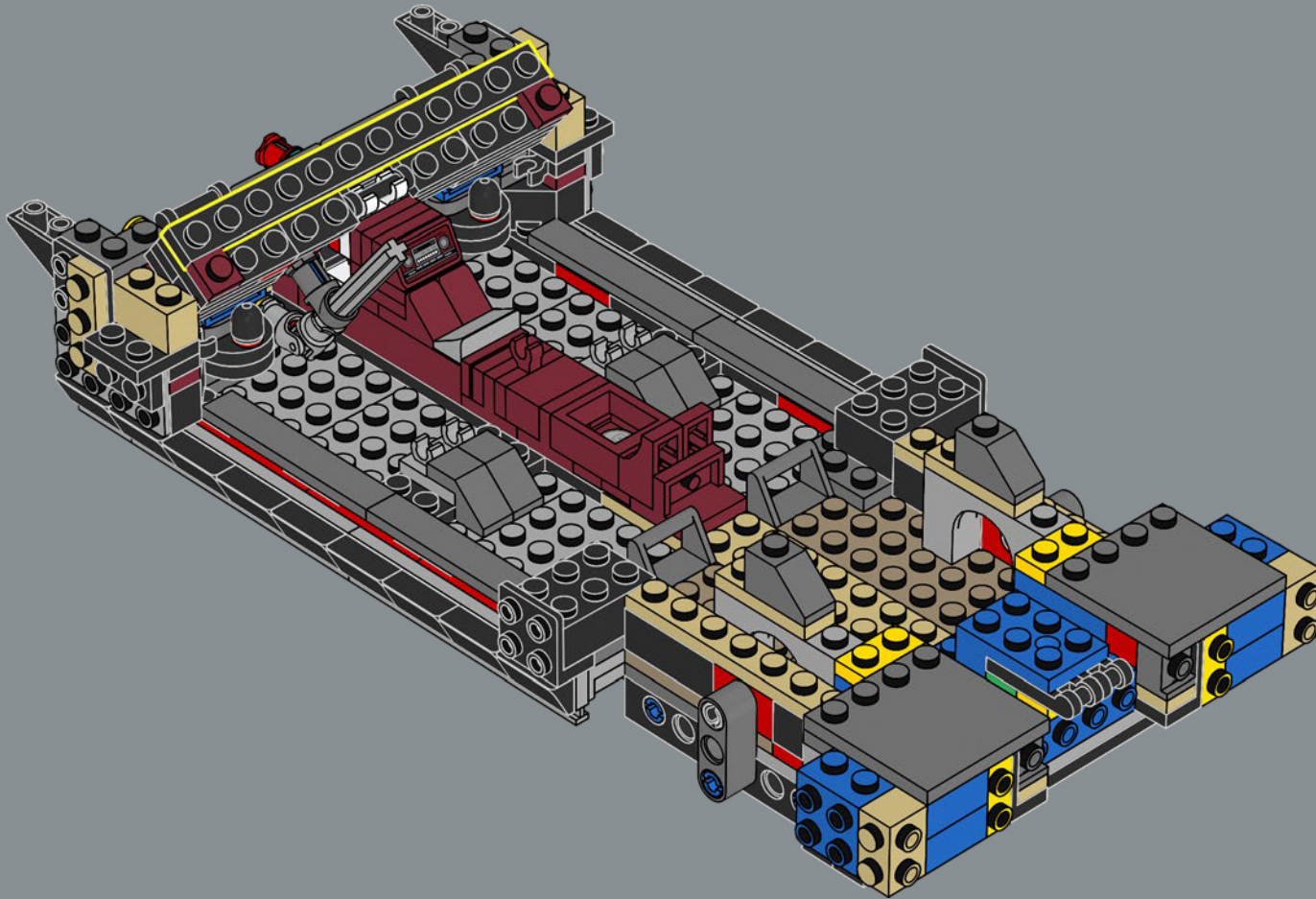

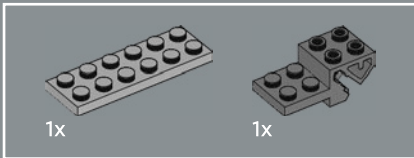
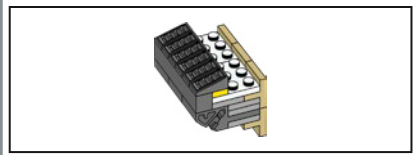

67

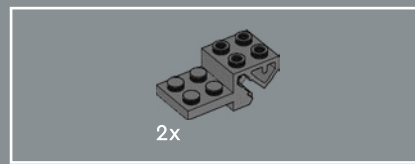
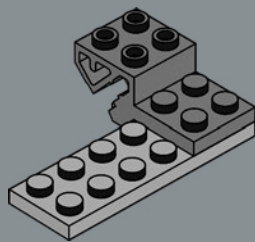

68

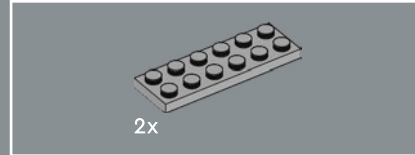
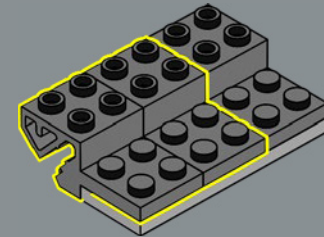

69

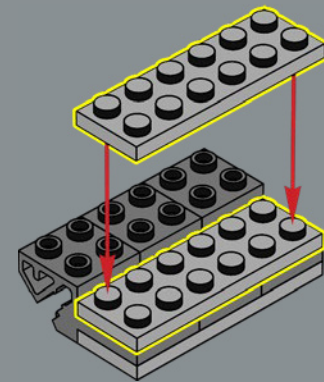

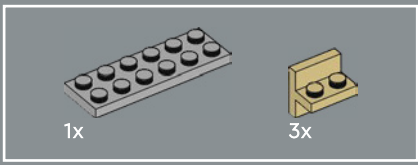

70

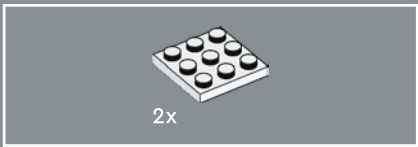
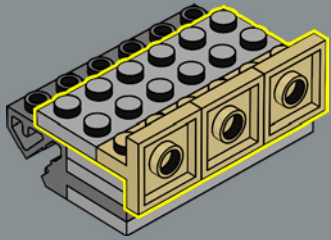

71

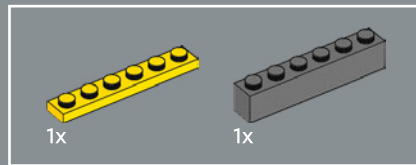
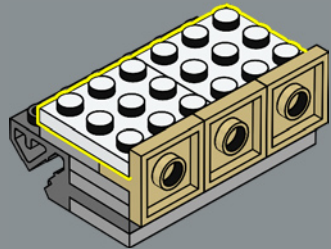

72

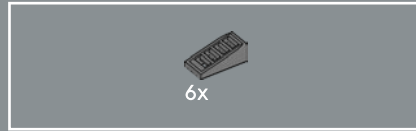
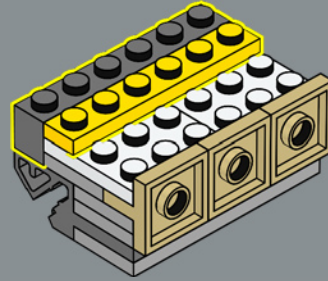

73

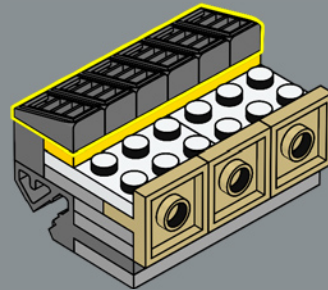

74

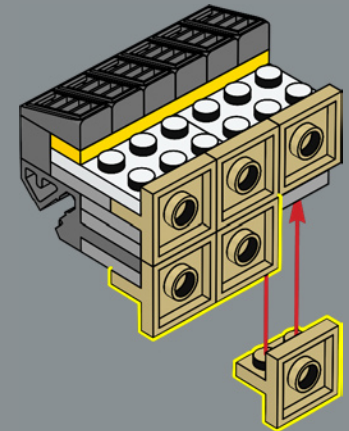

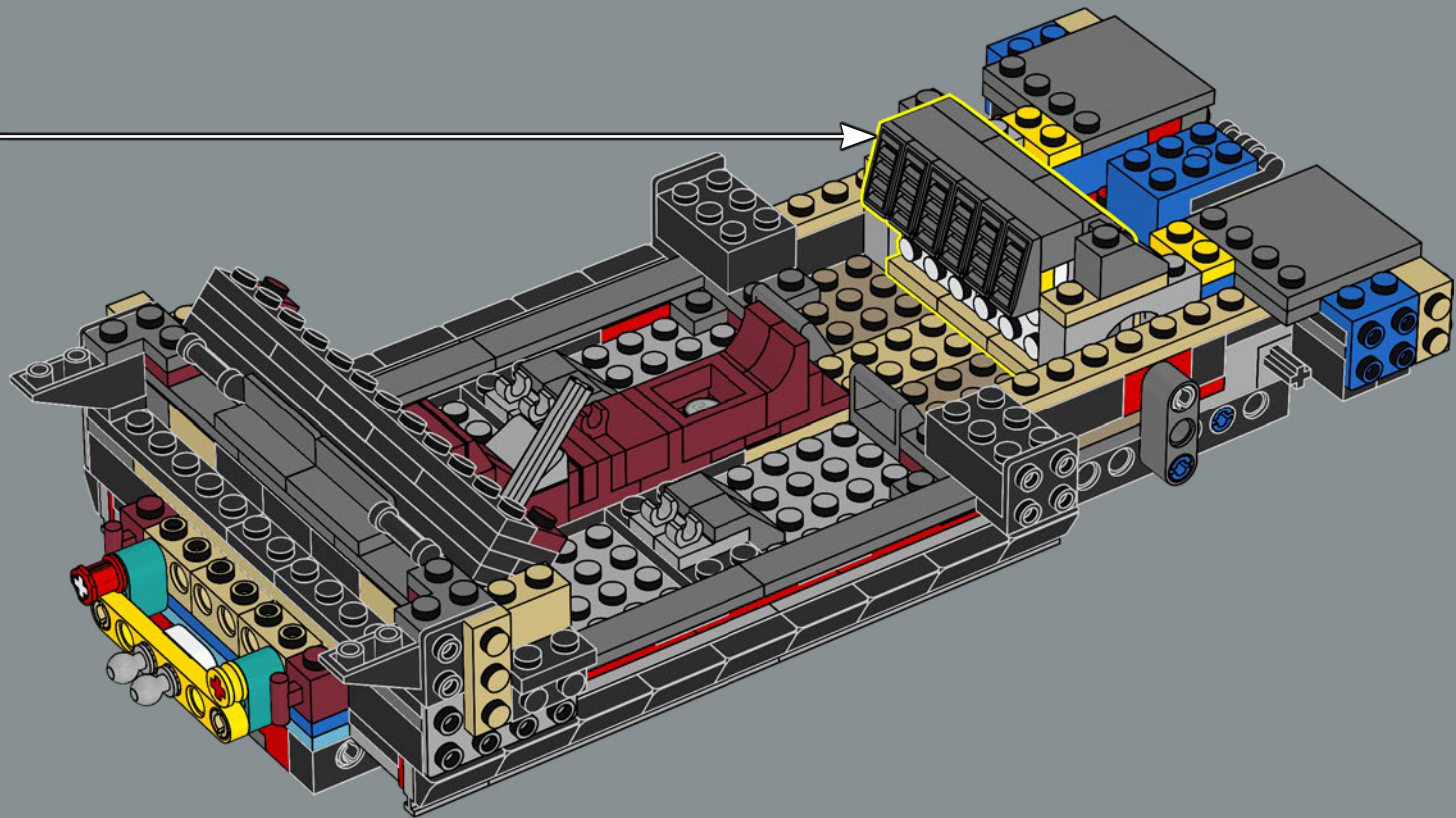

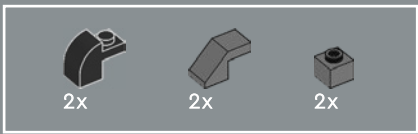

76

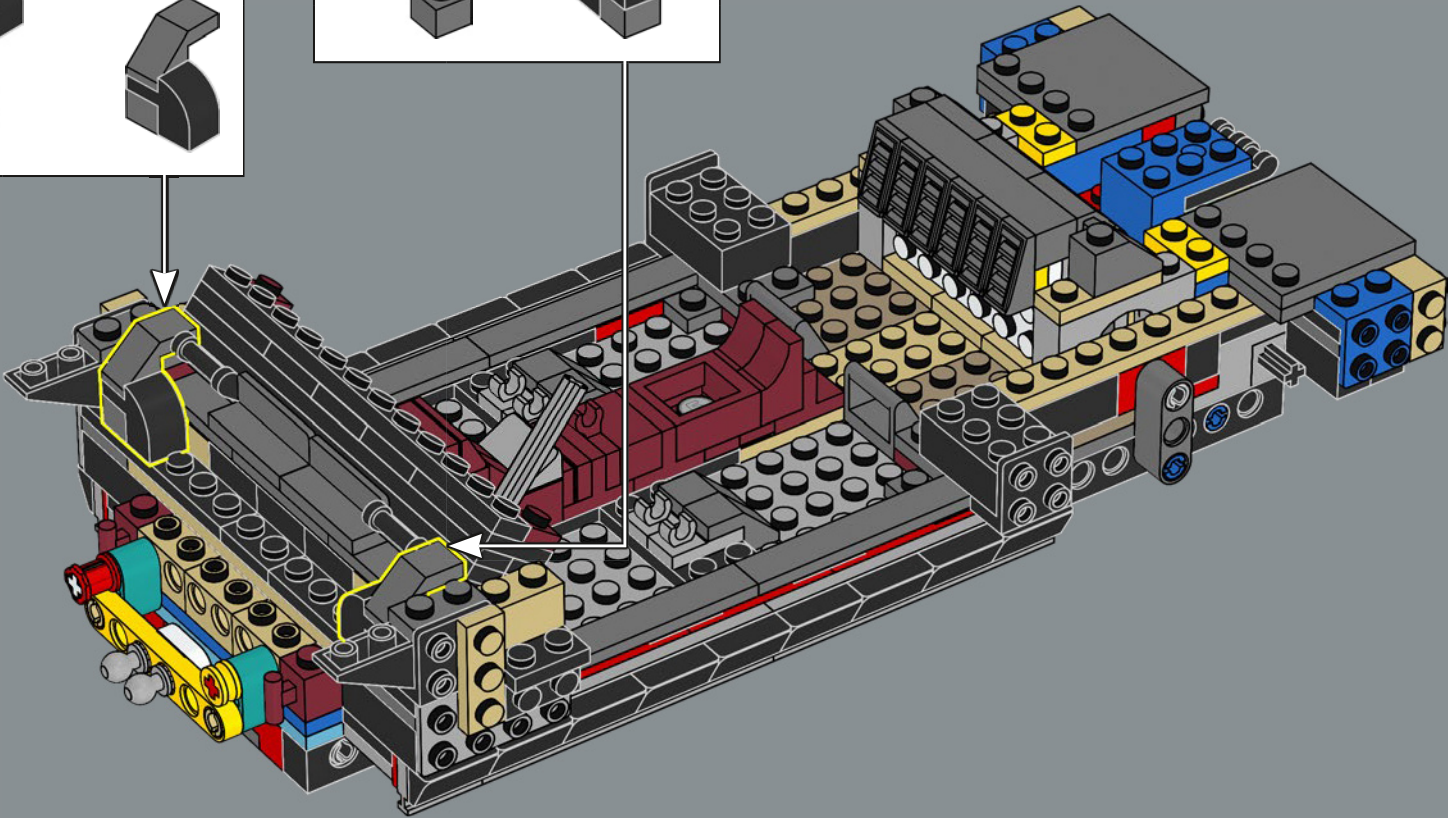
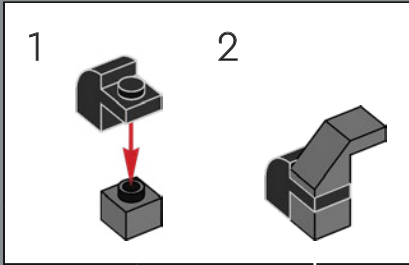
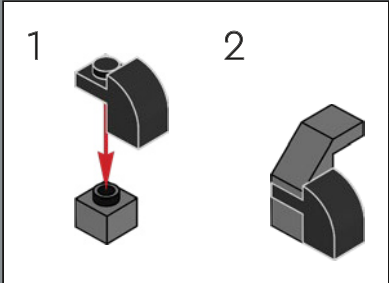

A special Convertible Camaro Z11 served as the official Indianapolis 500 pace car in 1969.

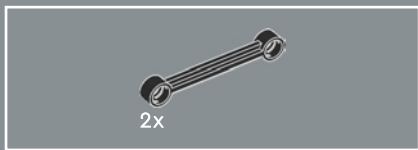

77

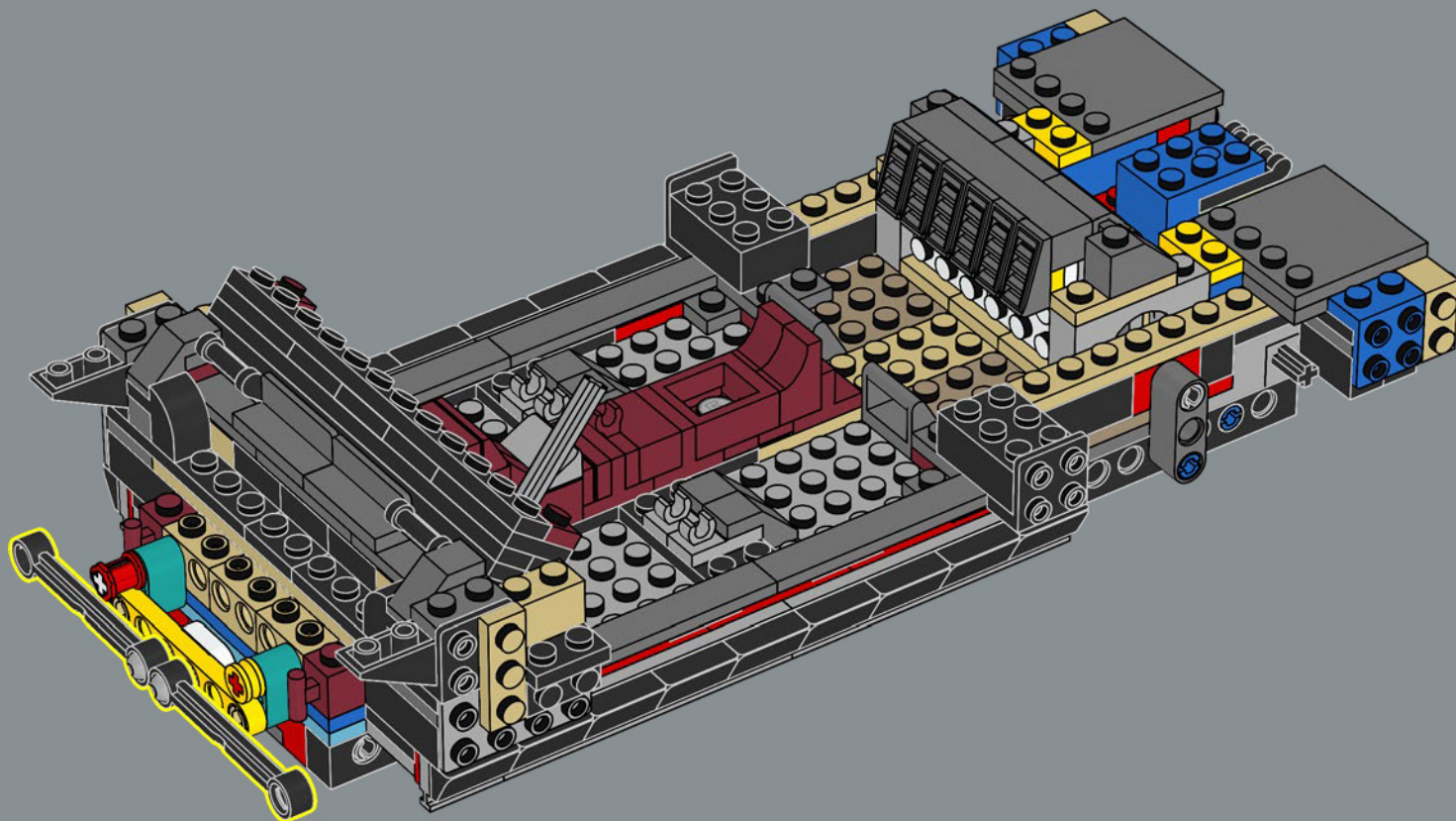

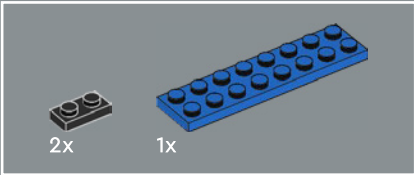
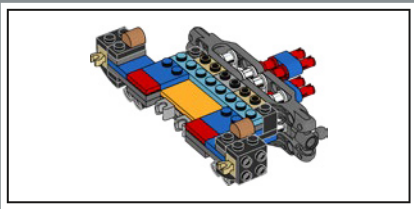

78

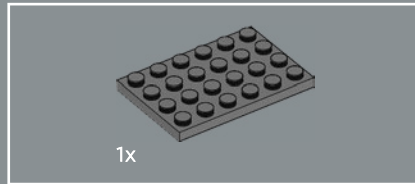
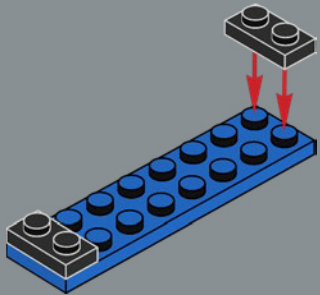

79

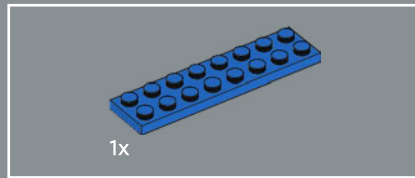
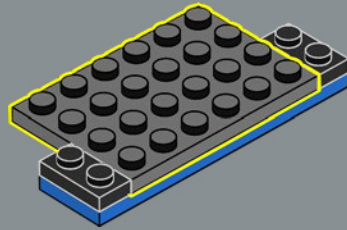

80

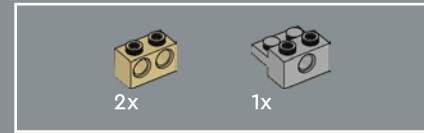
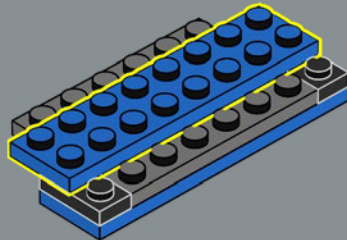

81

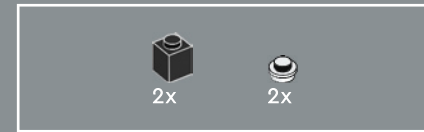
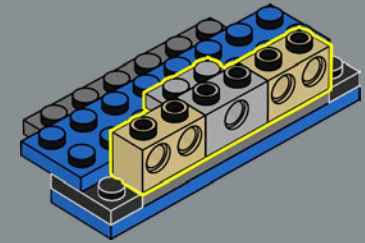

82

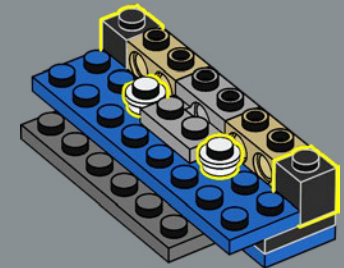



83

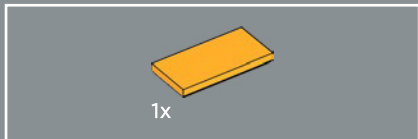
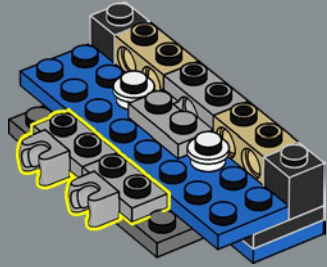

84

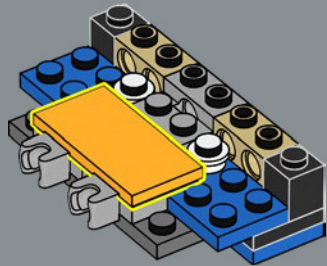

85

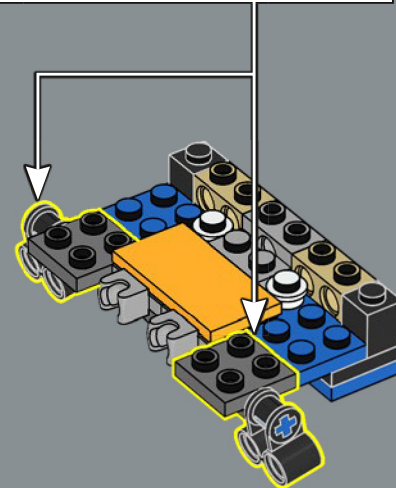
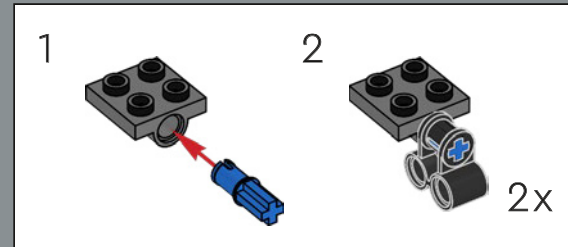

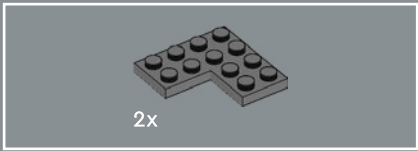

86

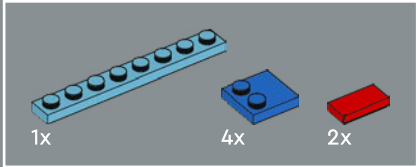
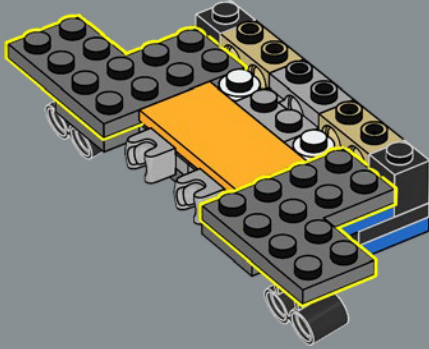

87

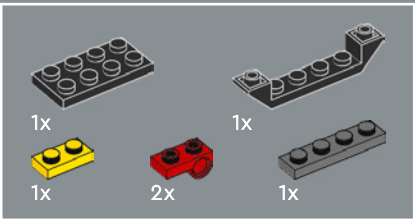
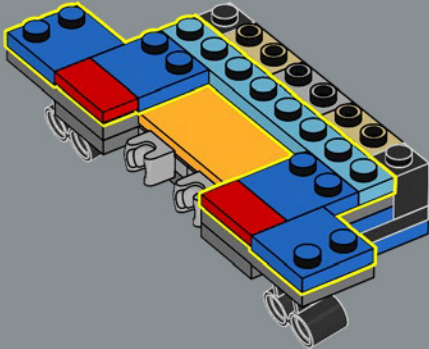

88

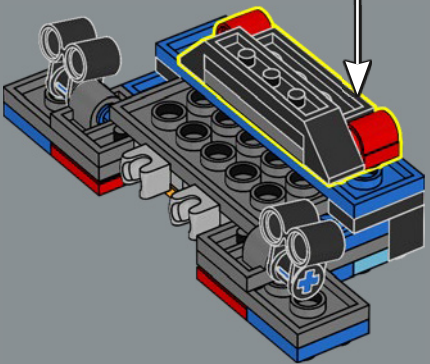
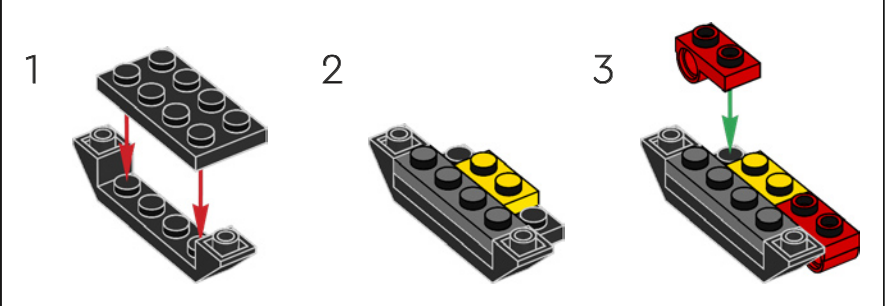

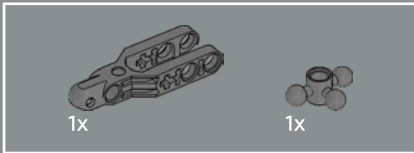
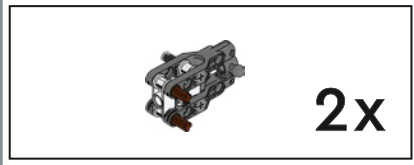
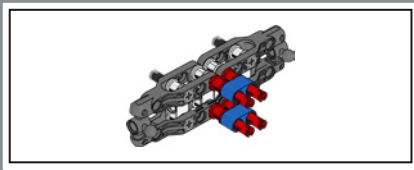

89

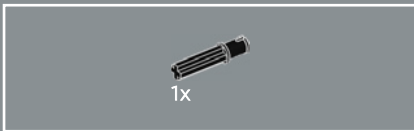
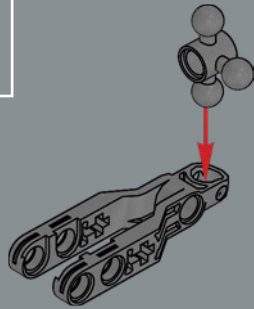

90

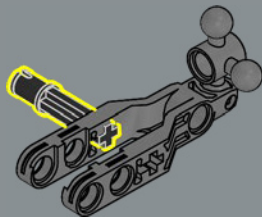

91

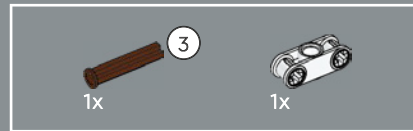
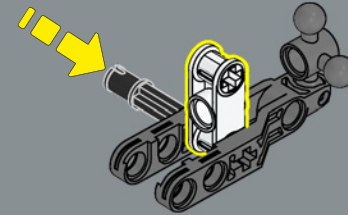

92

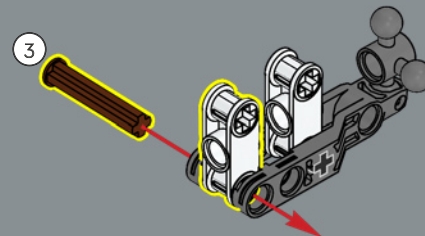



93

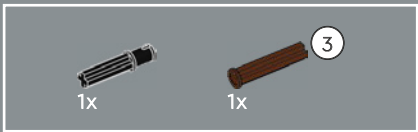
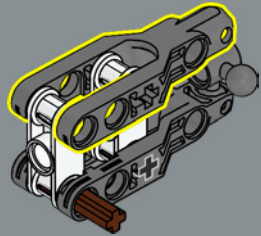

94

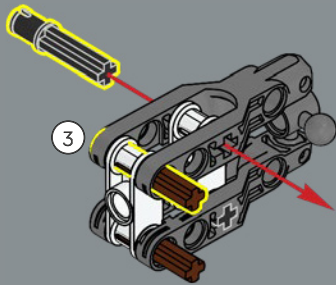

2x

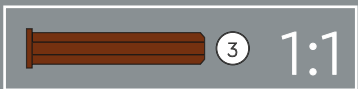

95

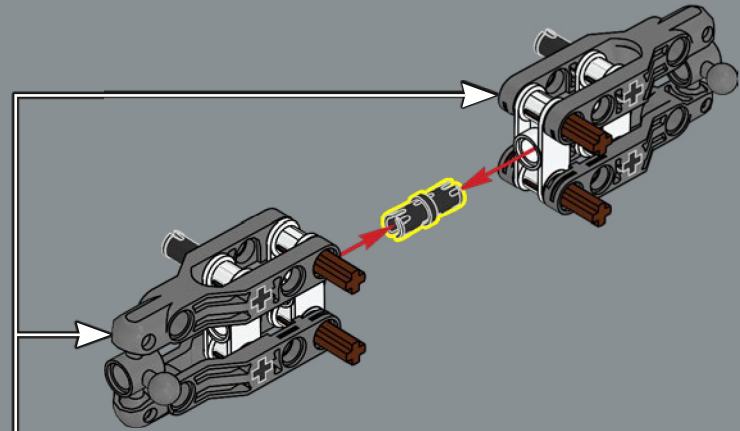



96

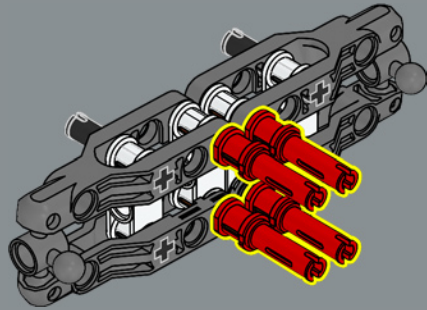

97

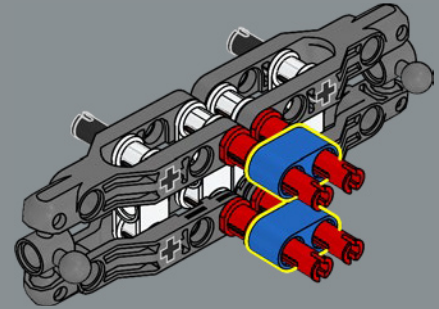

98

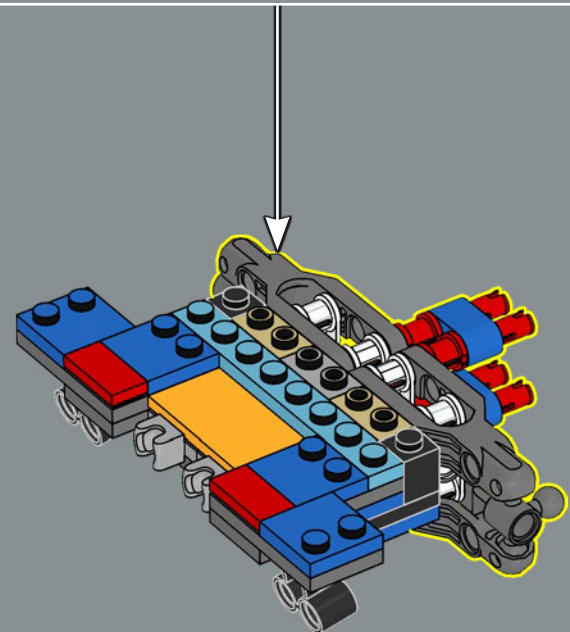

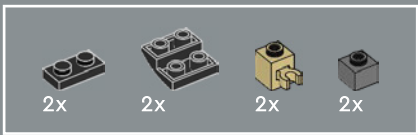

99

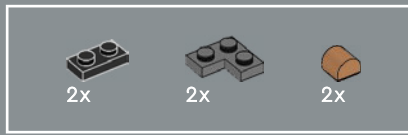
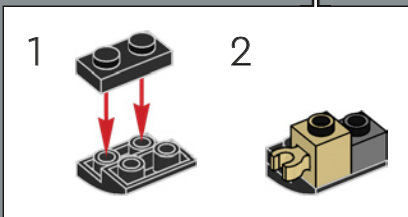
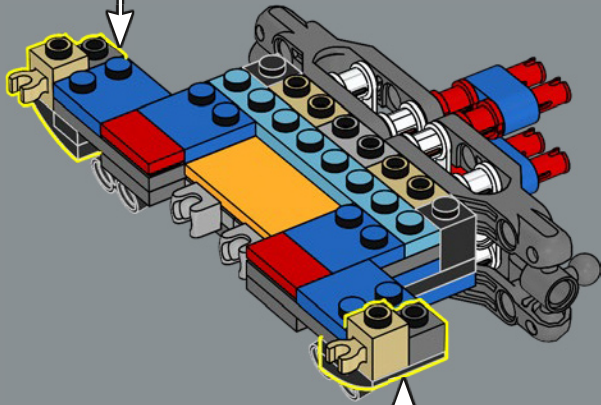
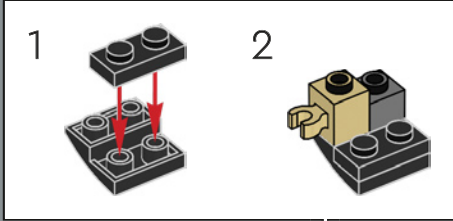

100

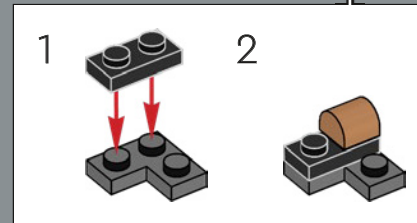
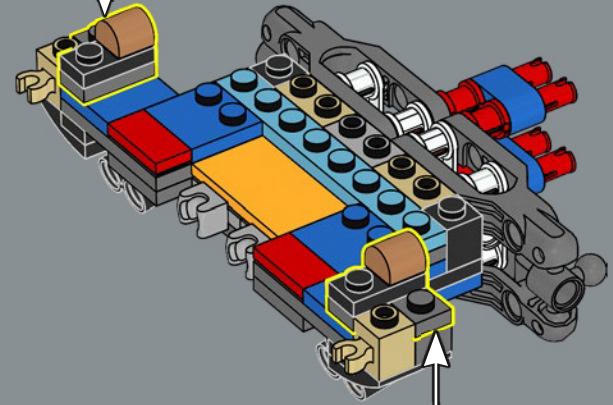
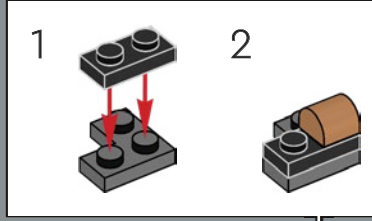



101

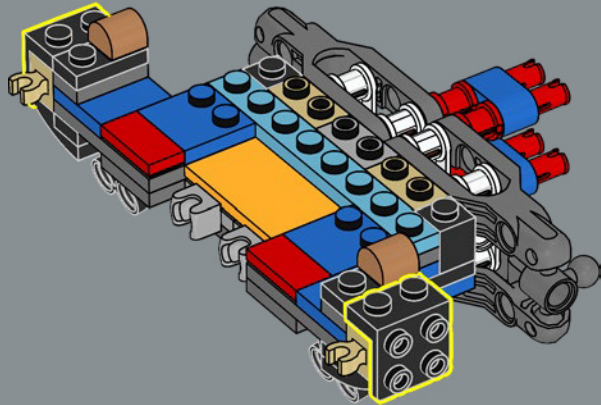

102

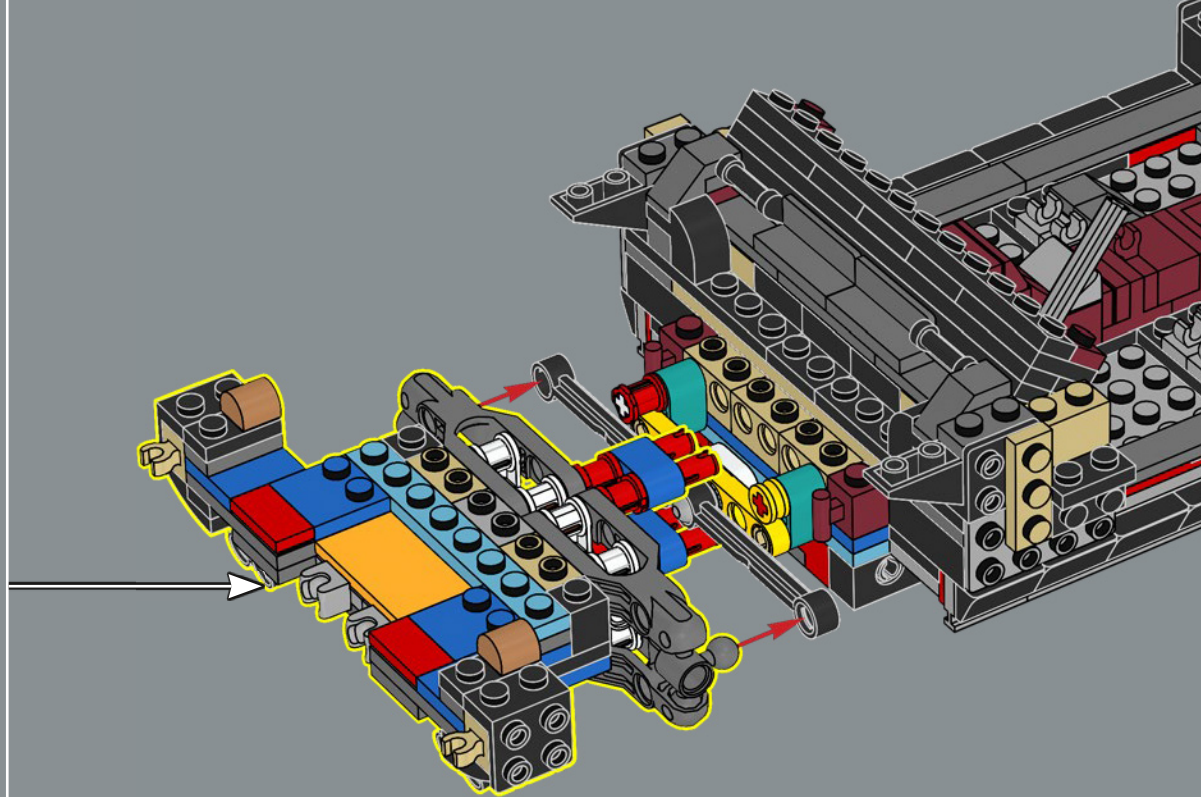

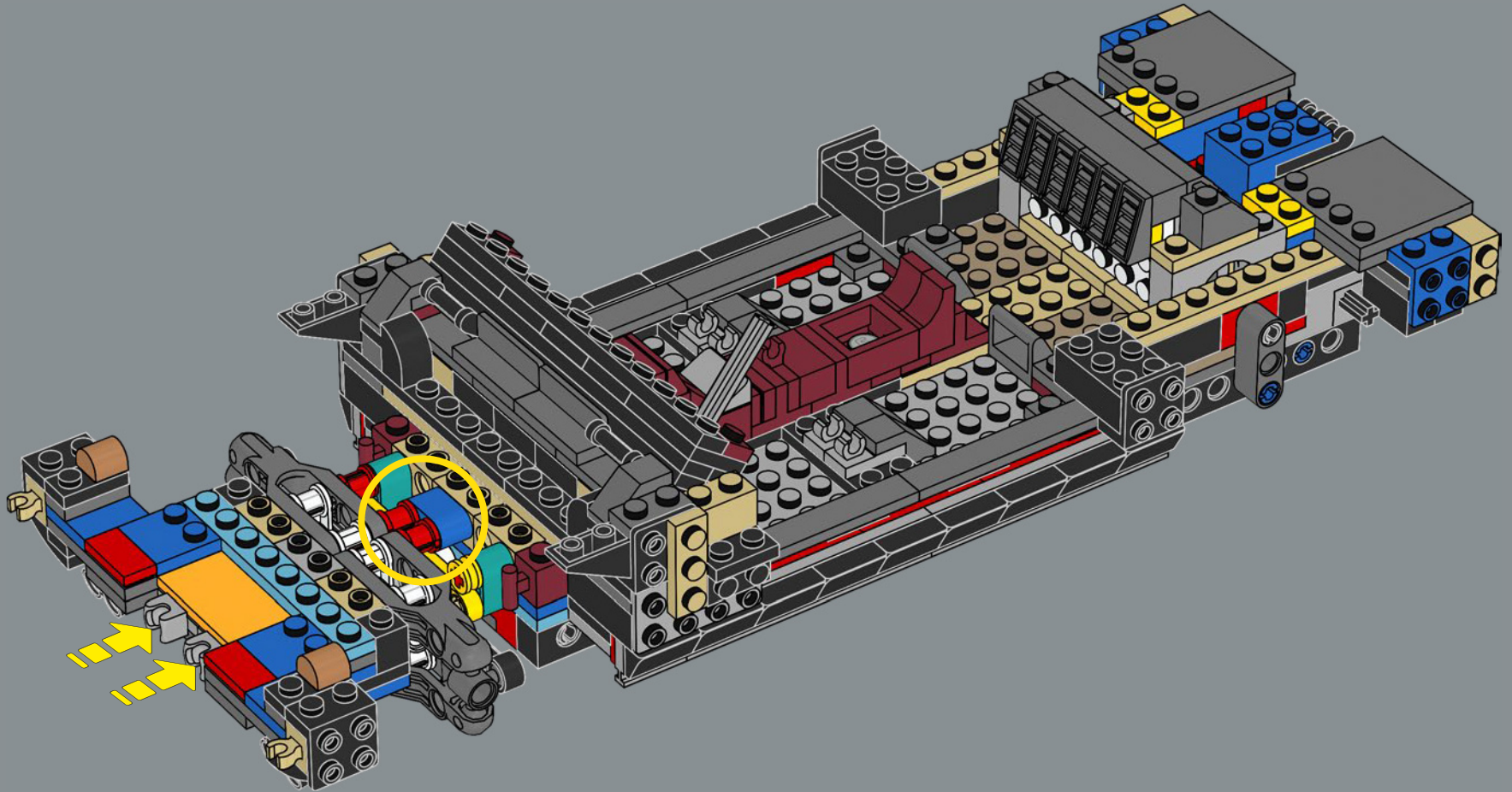

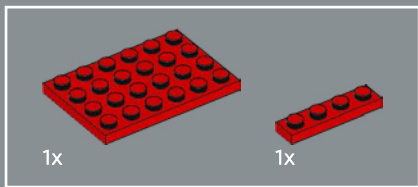

104

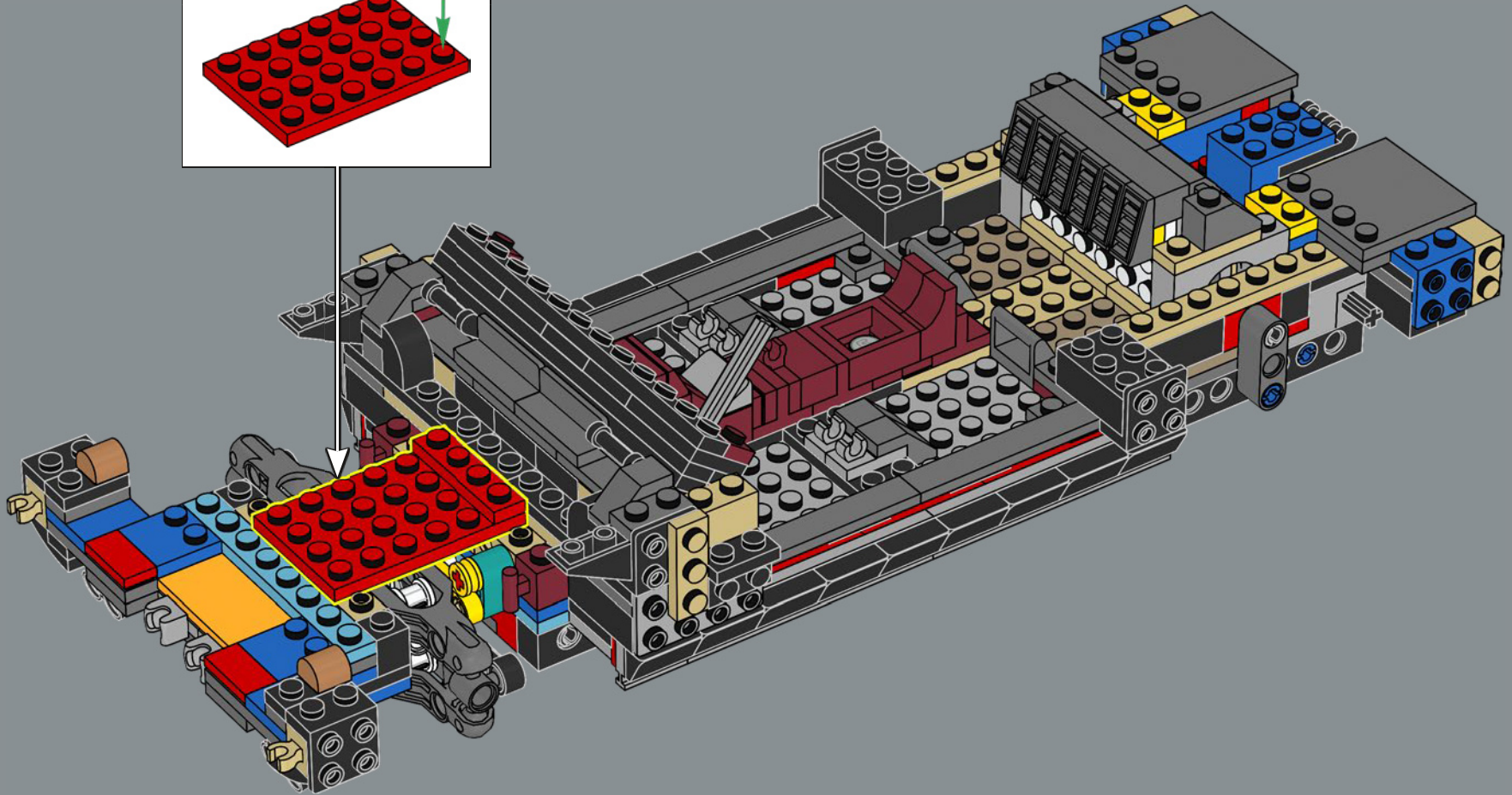
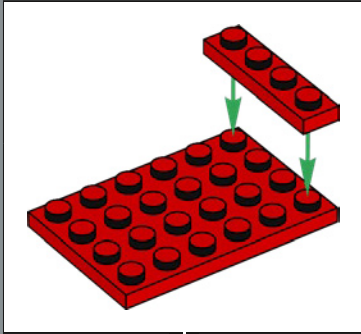

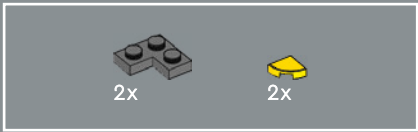

105

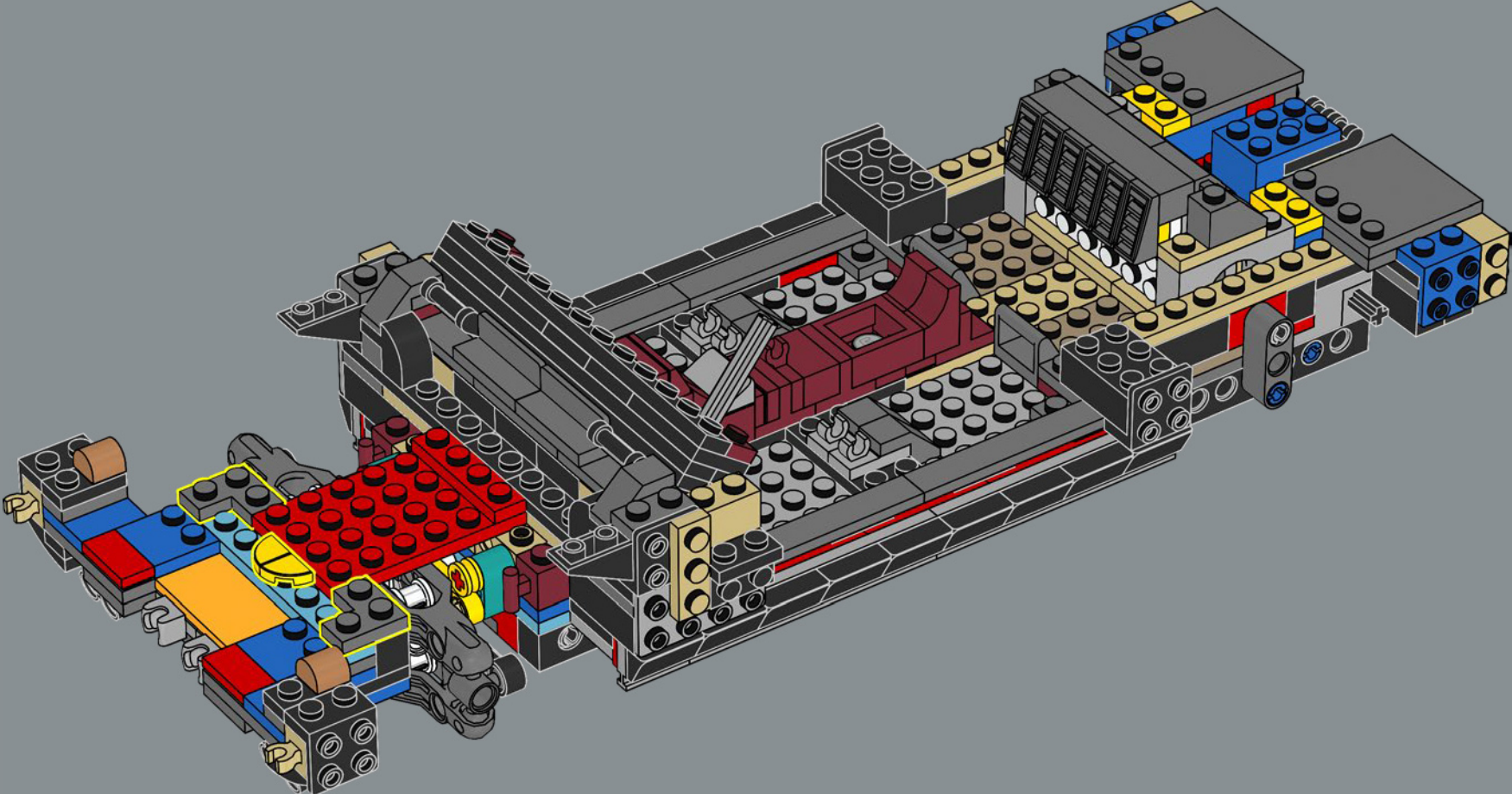

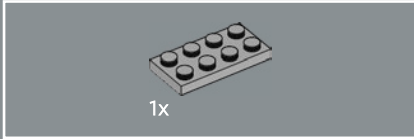
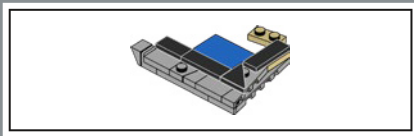

106

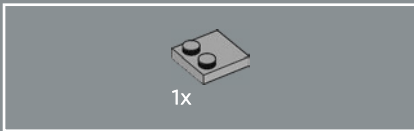

107

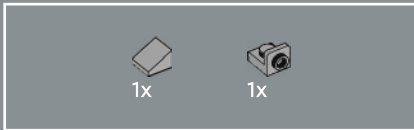
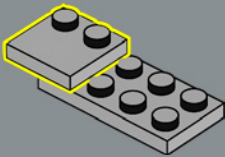

108

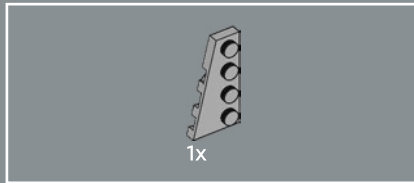
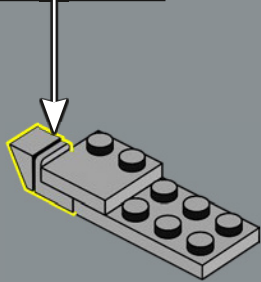
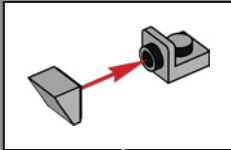

109

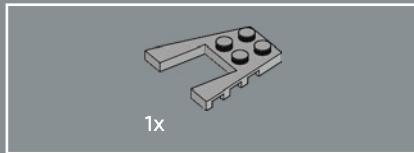
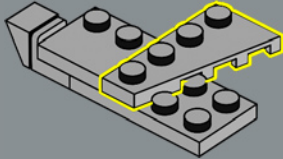

110

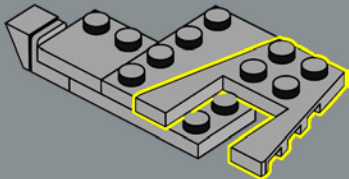

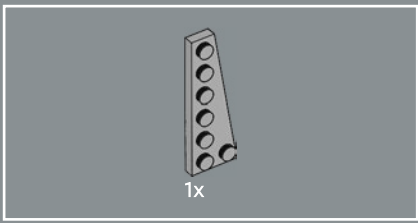

111

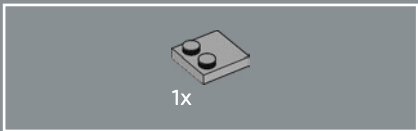
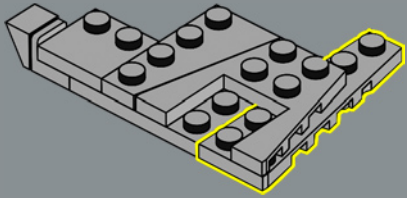

112

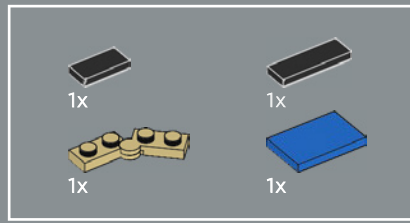
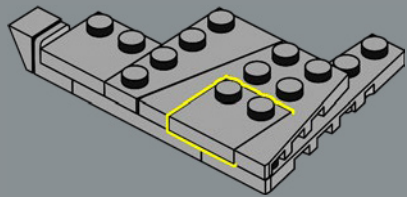

113

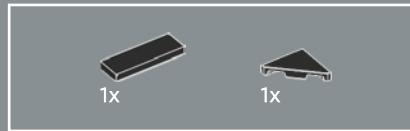
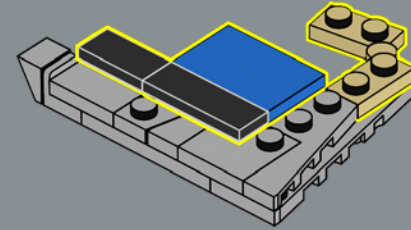

114

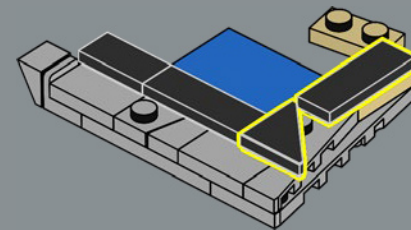

115

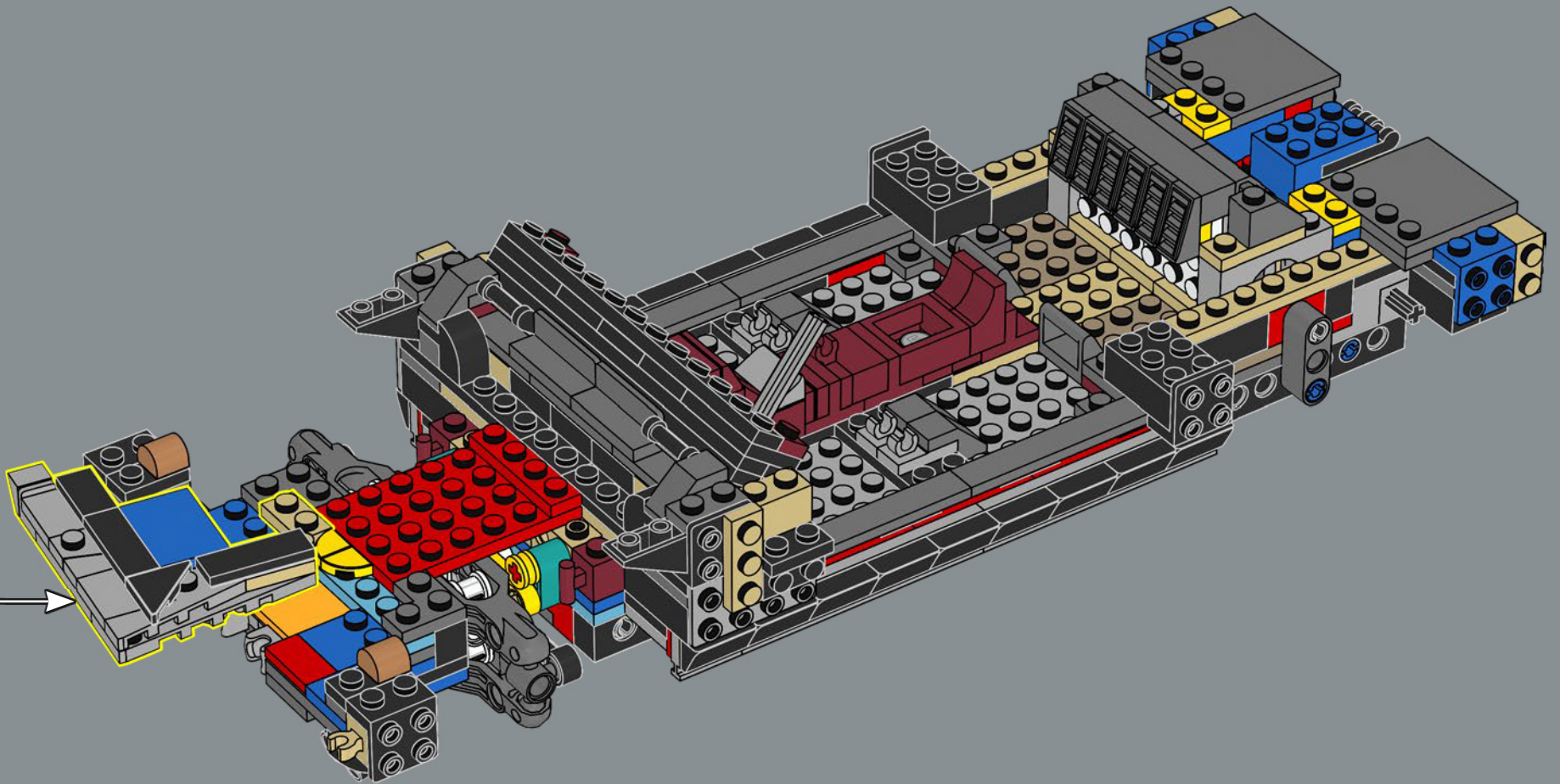

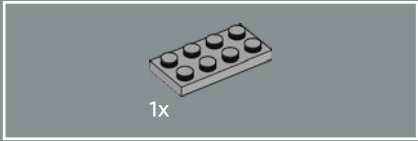
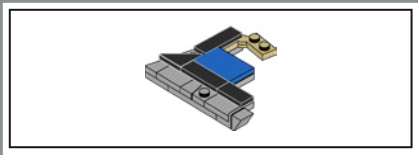

1x

116

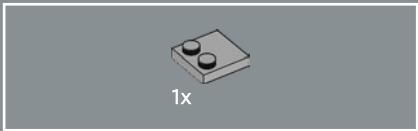

1x

117

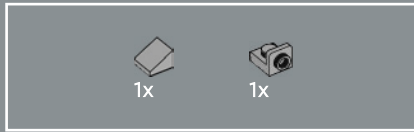
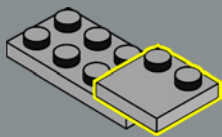

1x

1x

118

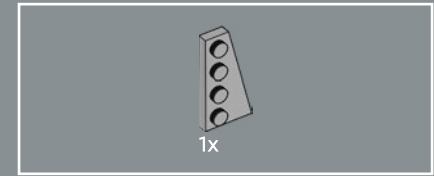
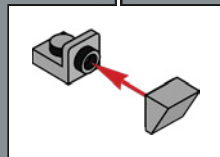
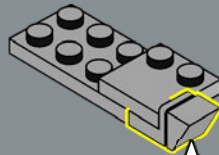

1x

119

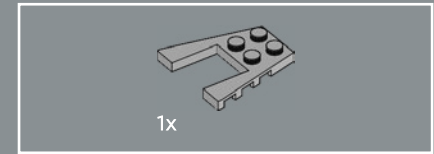
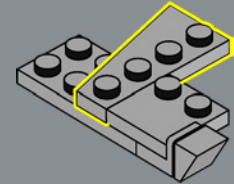

1x

120

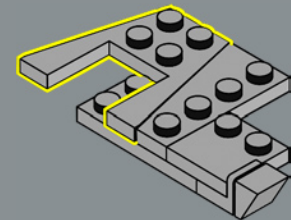

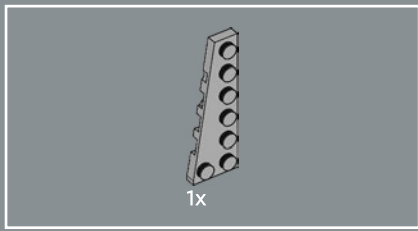

121

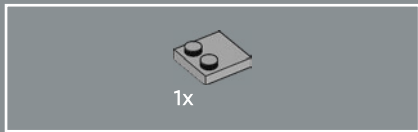
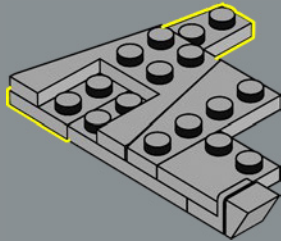

122

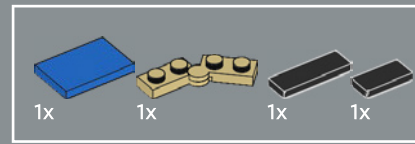
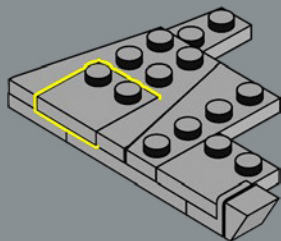

123

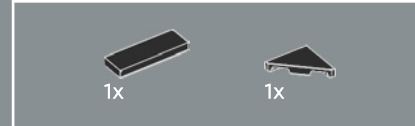
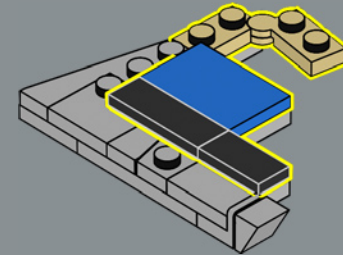

124

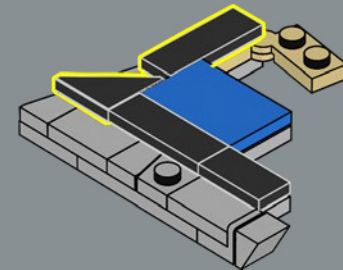

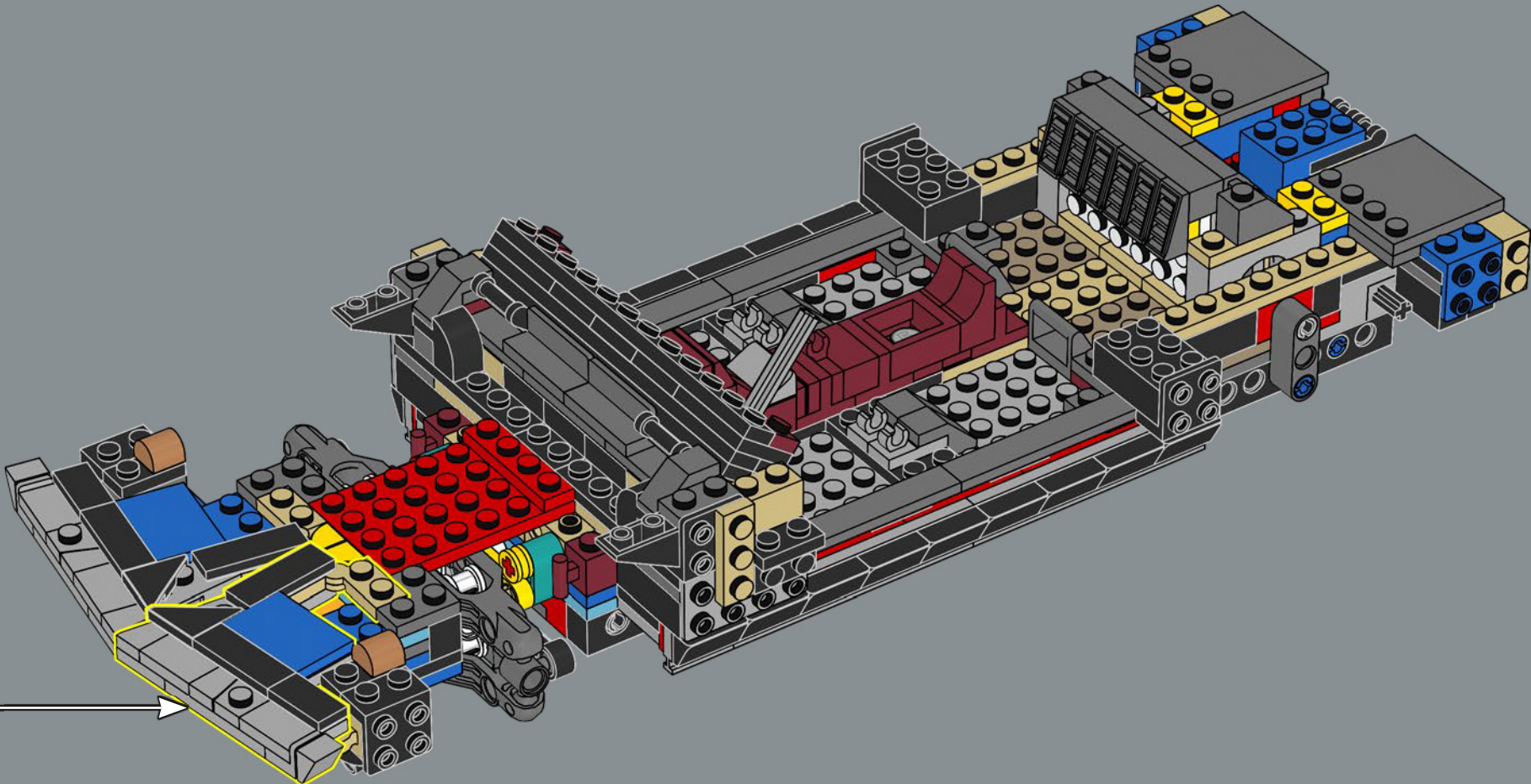

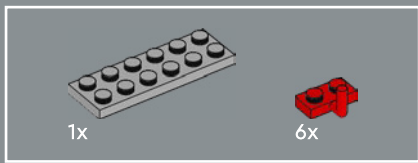

126

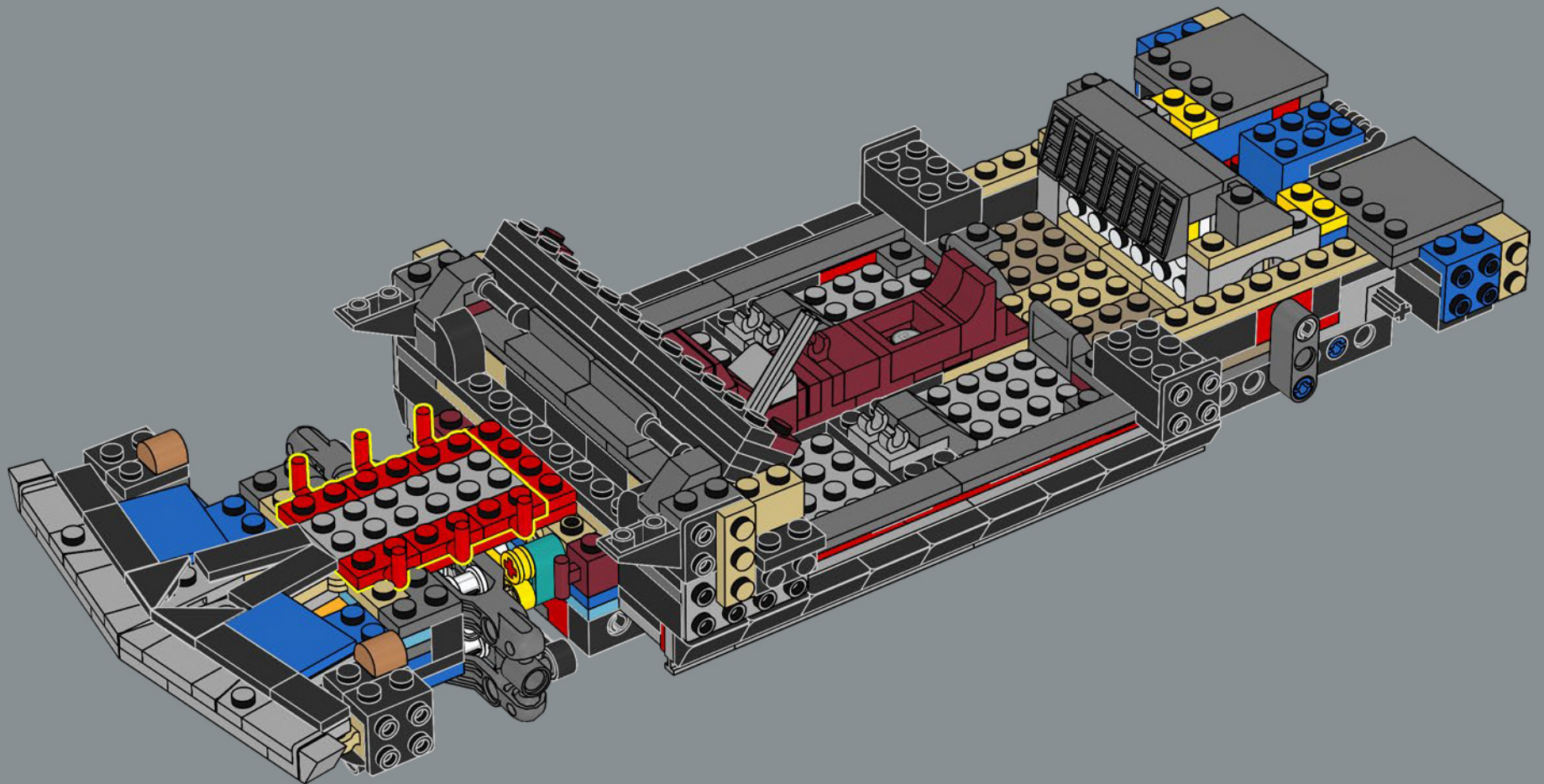

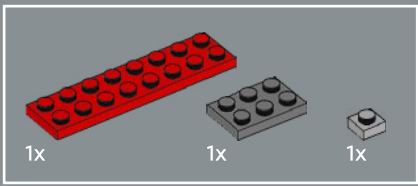

127

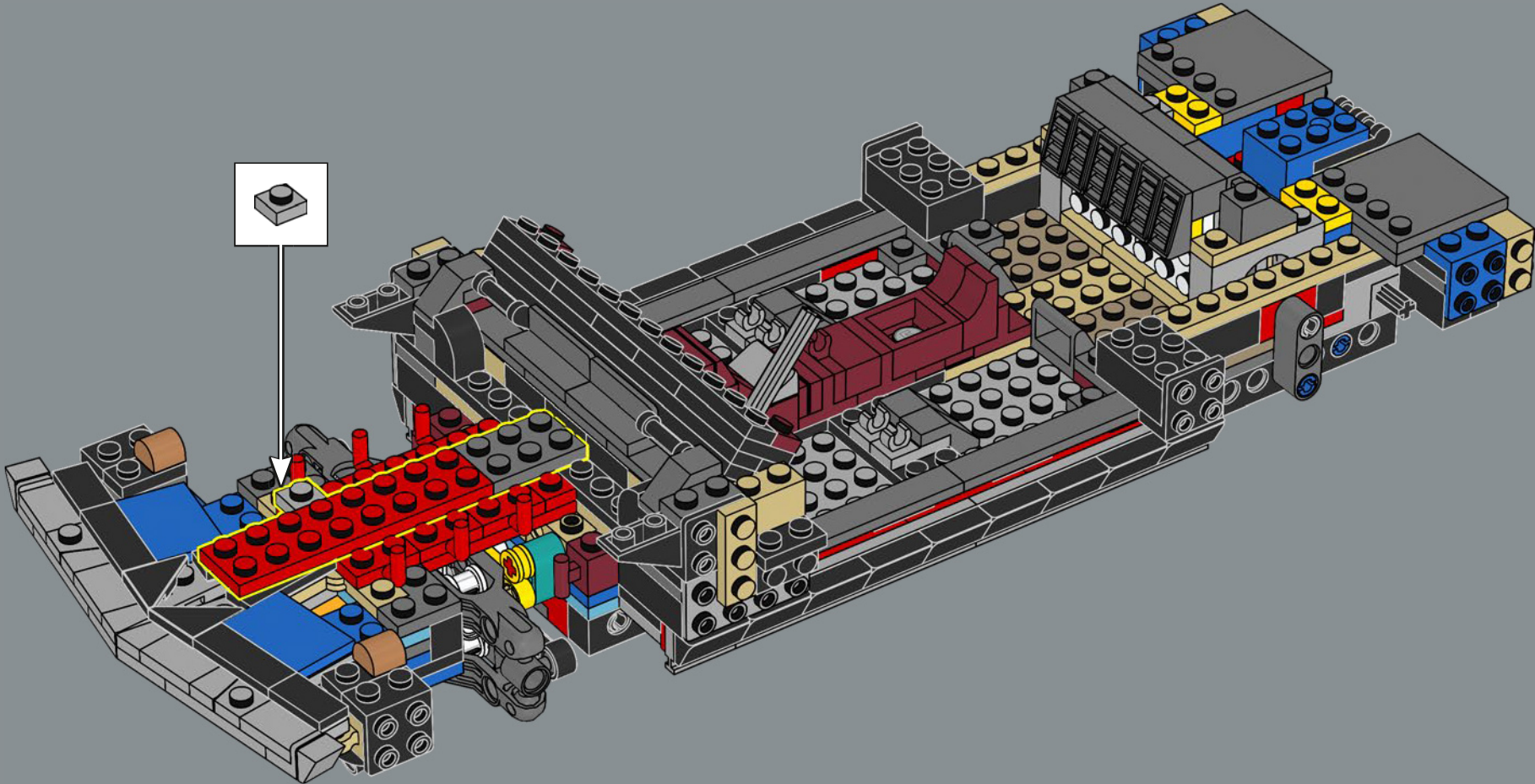

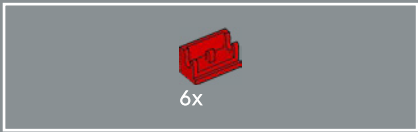

128

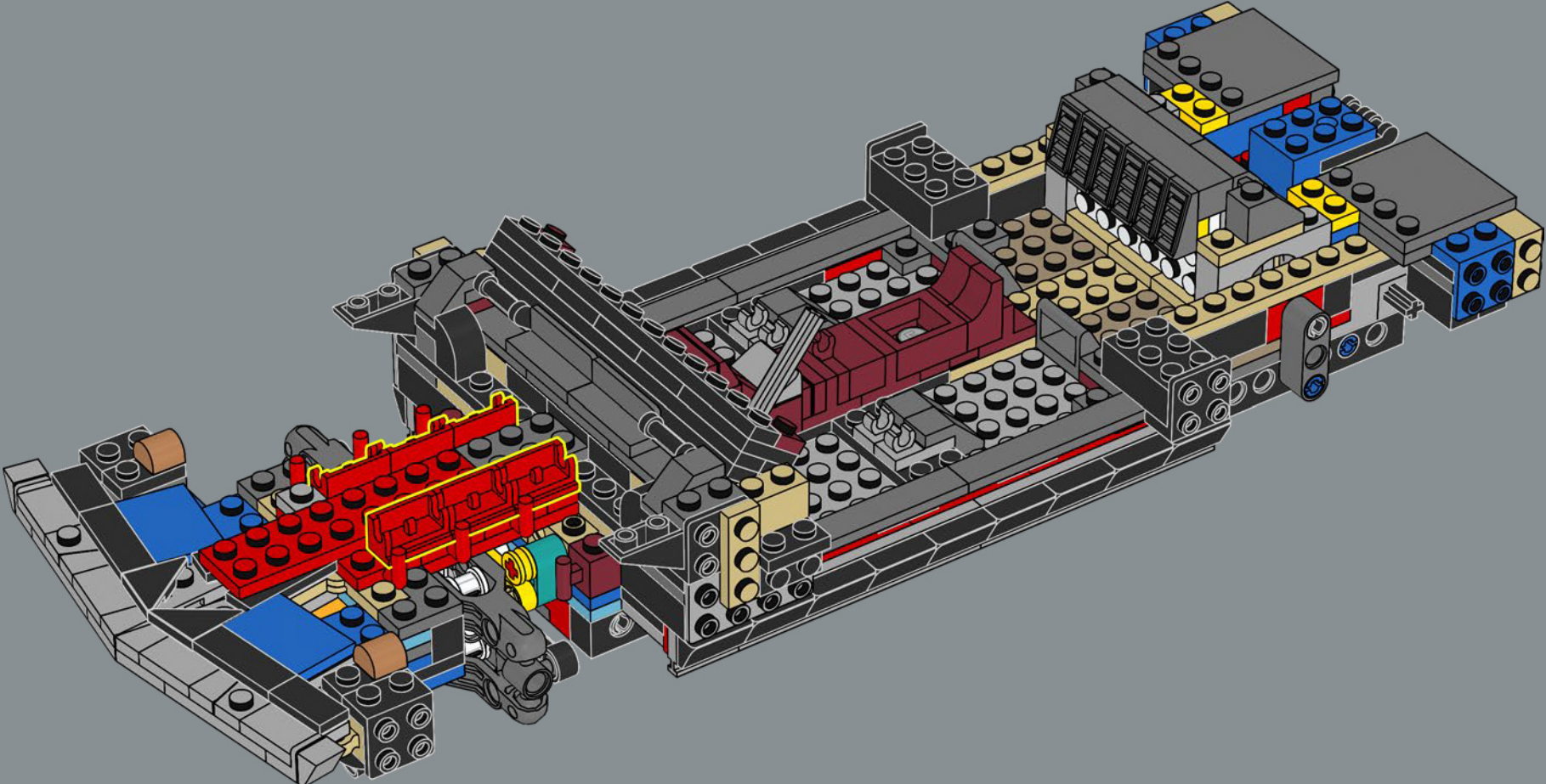

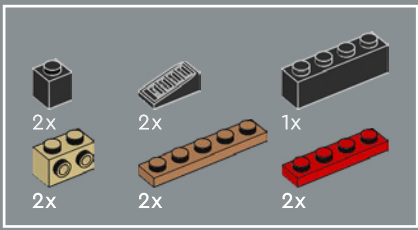

129

1

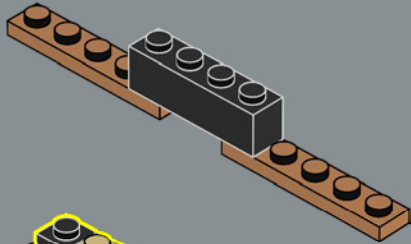

2

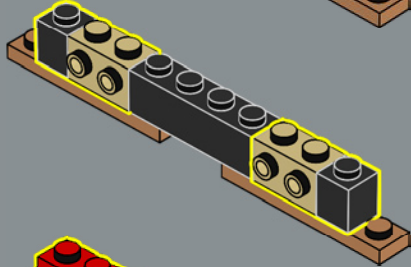

3

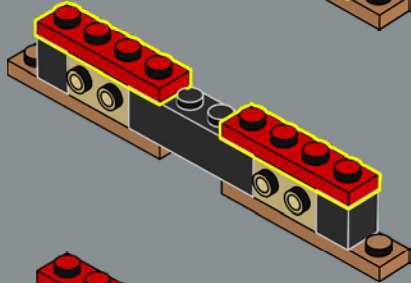

4

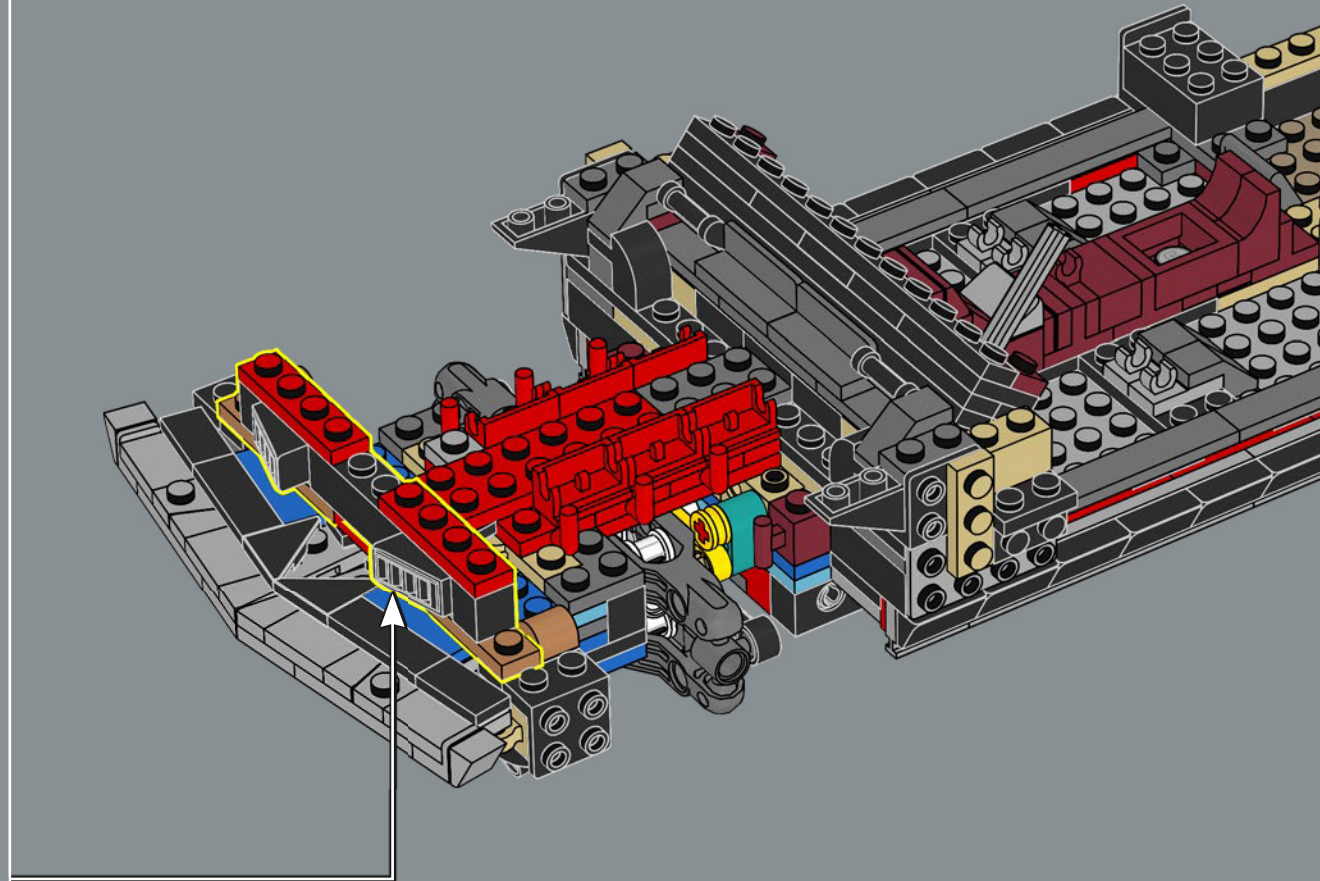
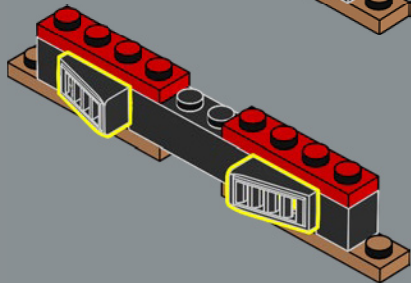

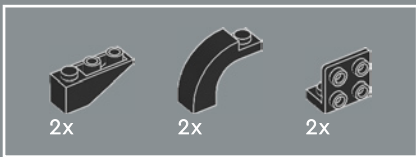

130

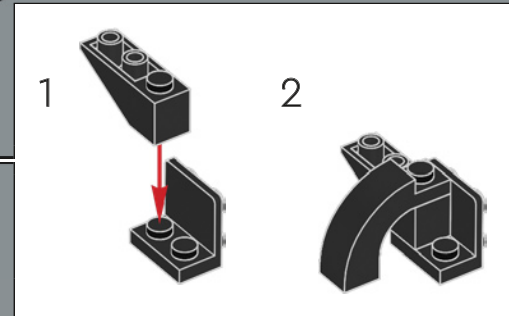
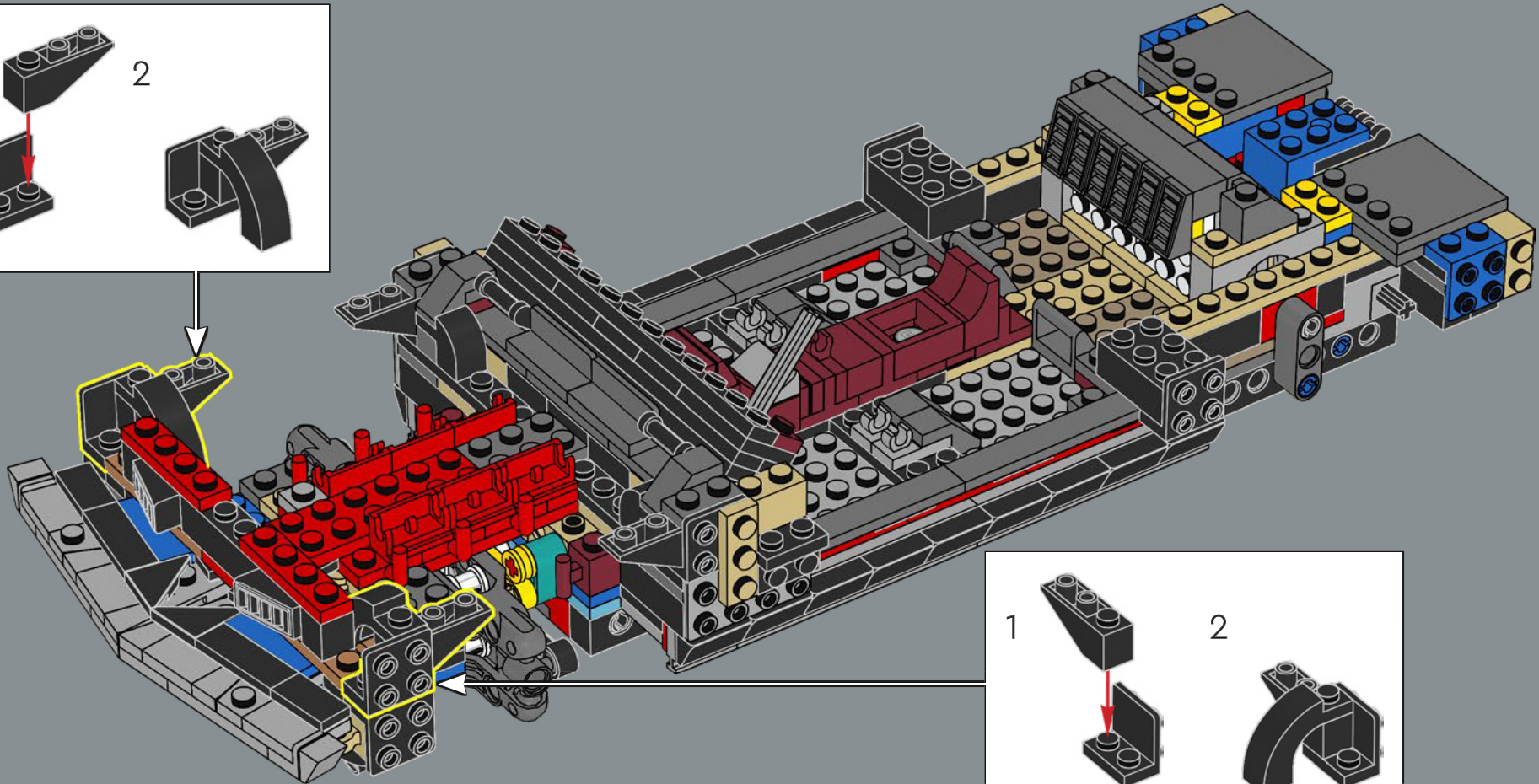
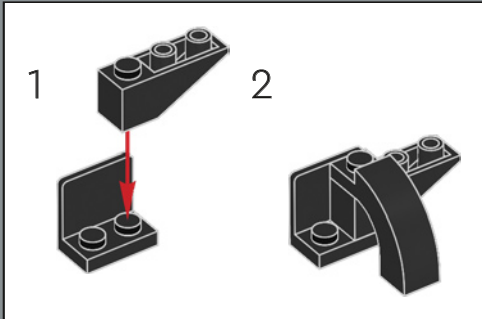

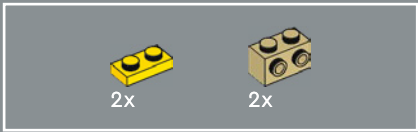

131

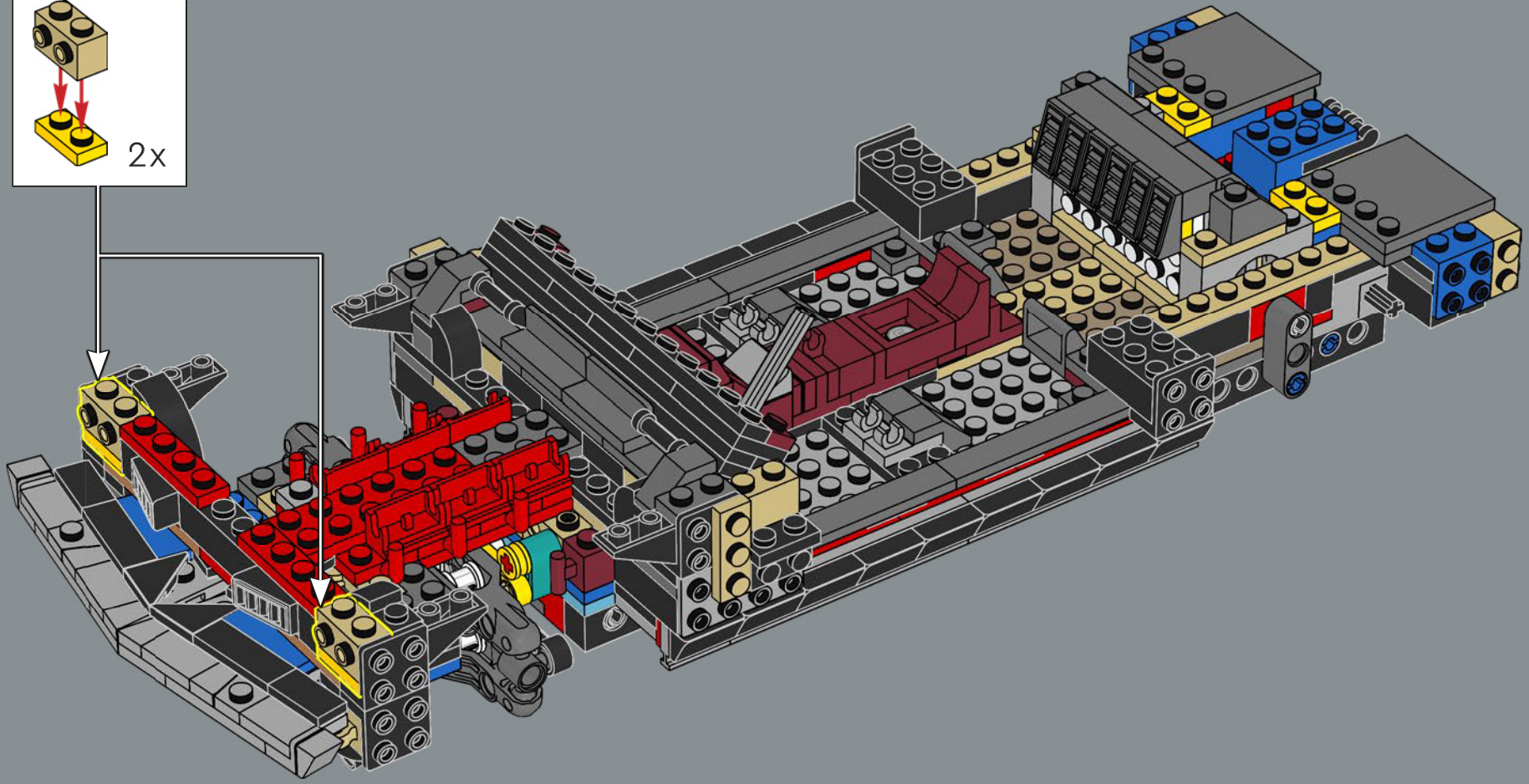
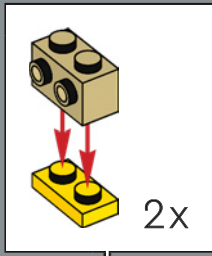

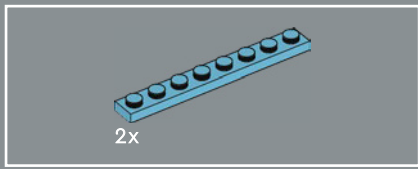

132

The unveiling of the Chevrolet Camaro to the press in 1966 was the world's first large-scale teleconference, with over 200 journalists joining from 14 US cities.

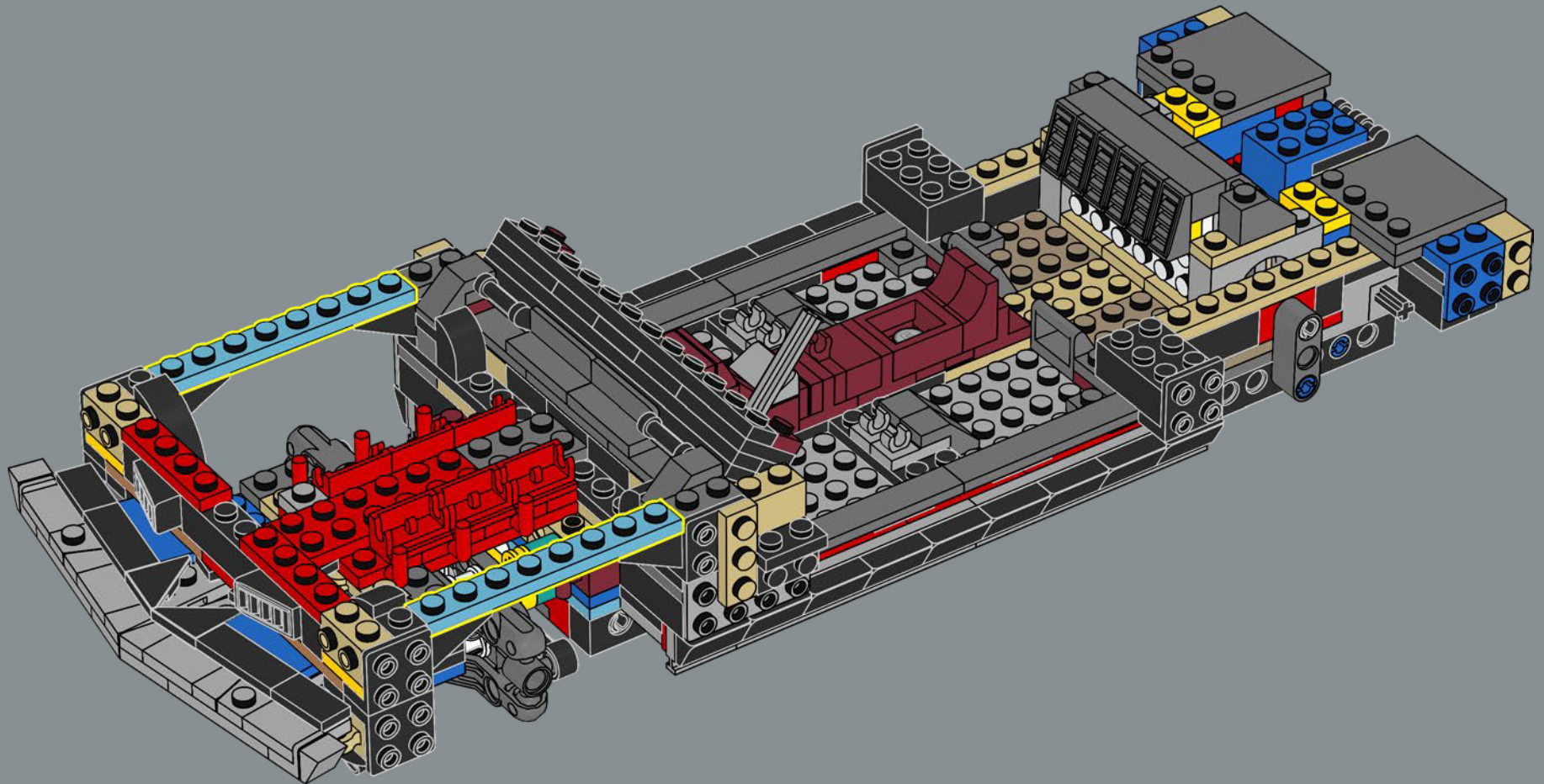



133

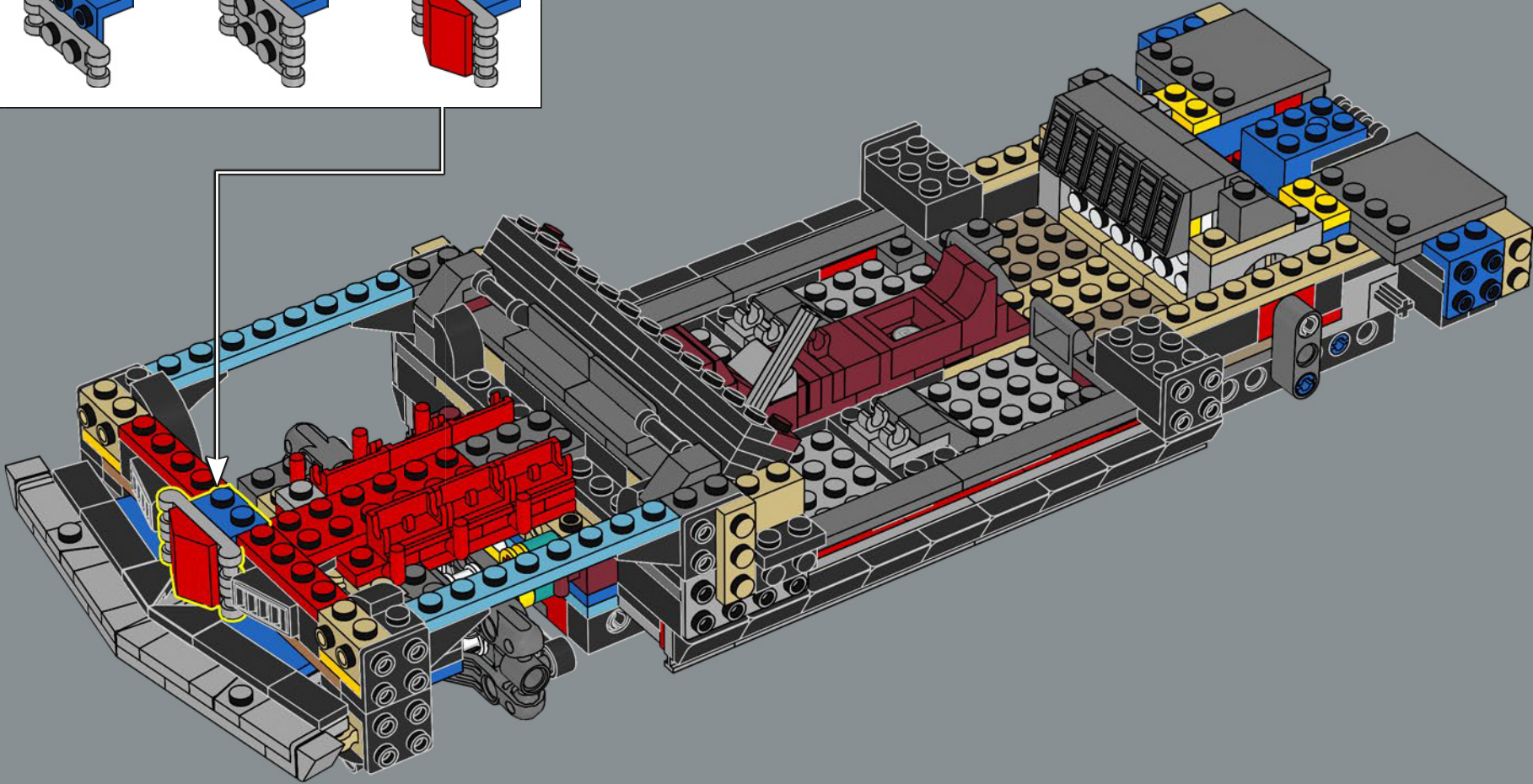
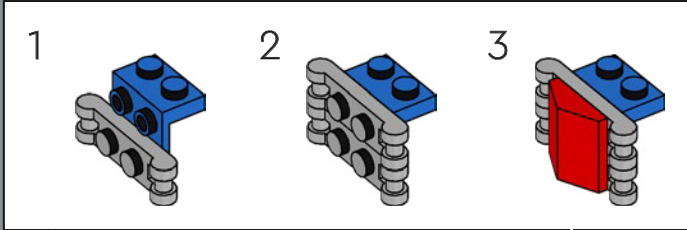



134

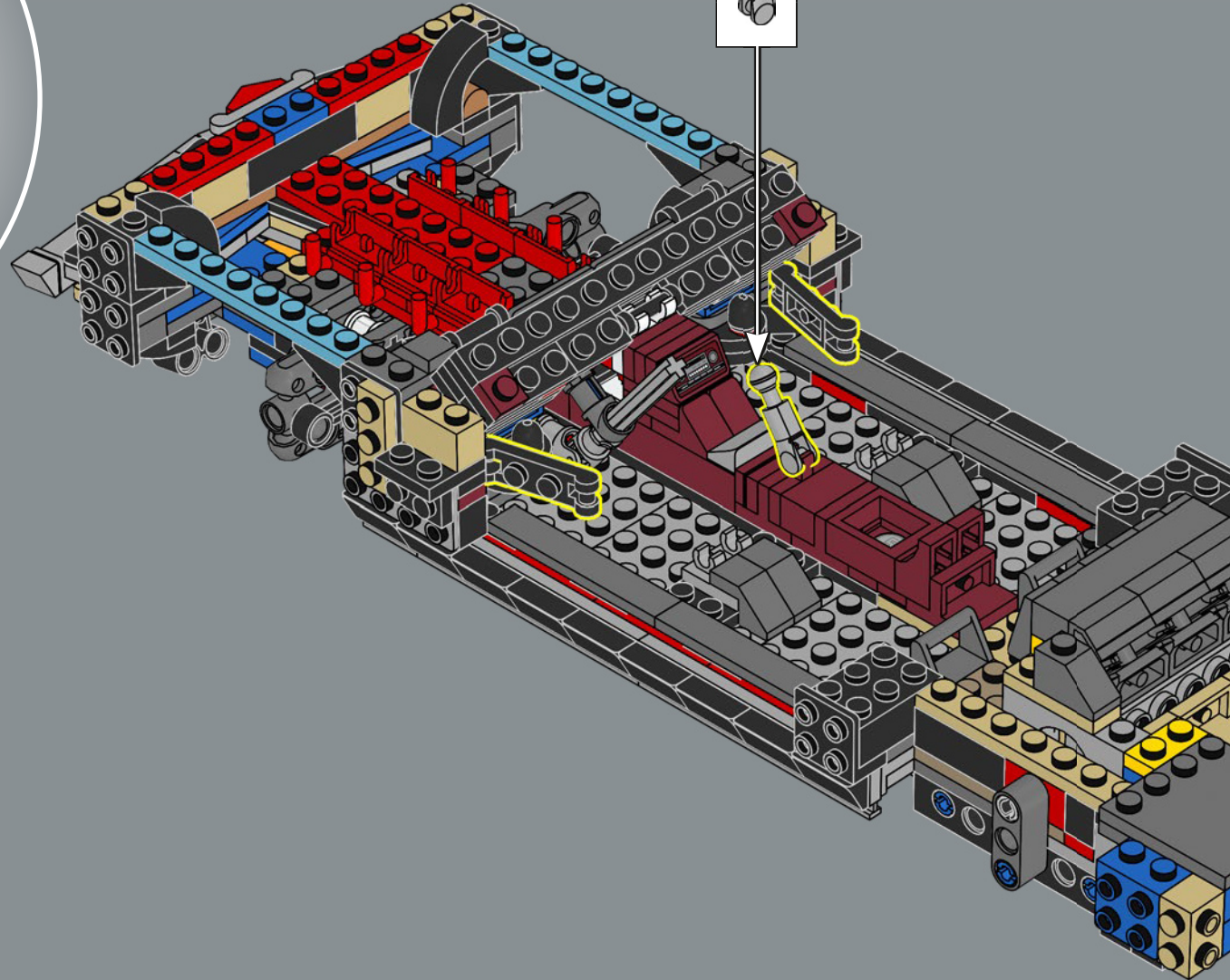
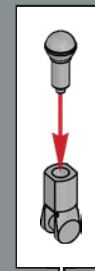

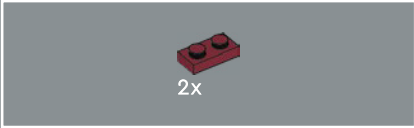
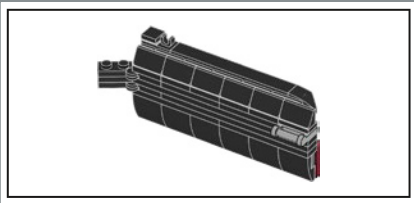

135

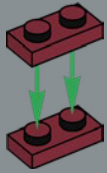

136

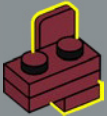

137

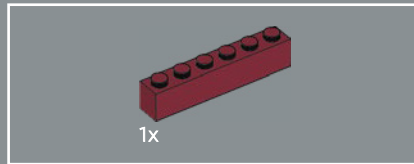
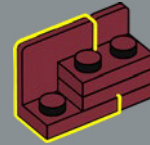

138

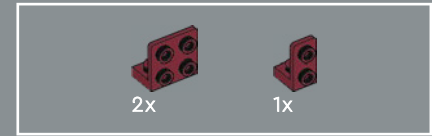
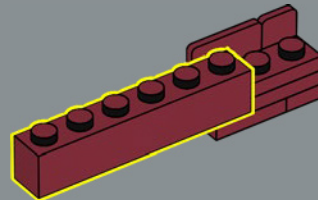

139

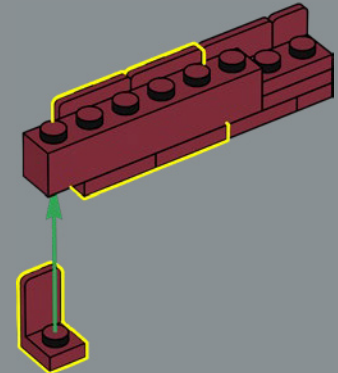



140

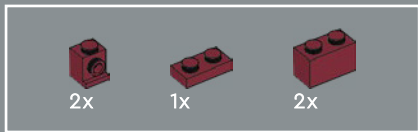
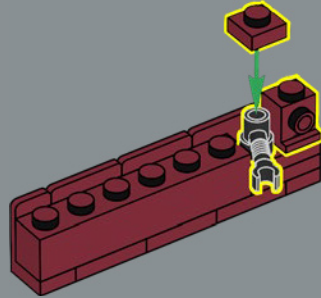

141

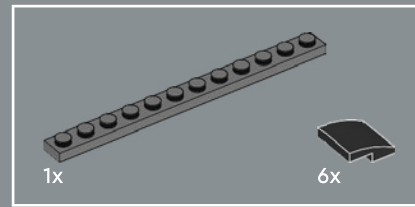
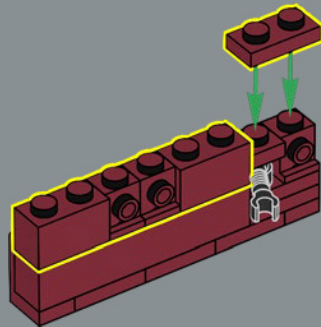

142

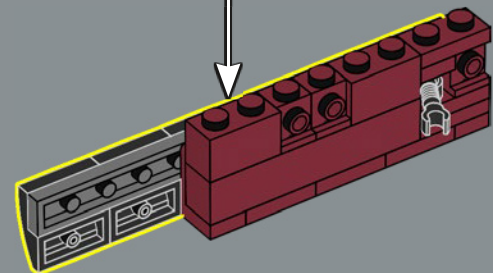
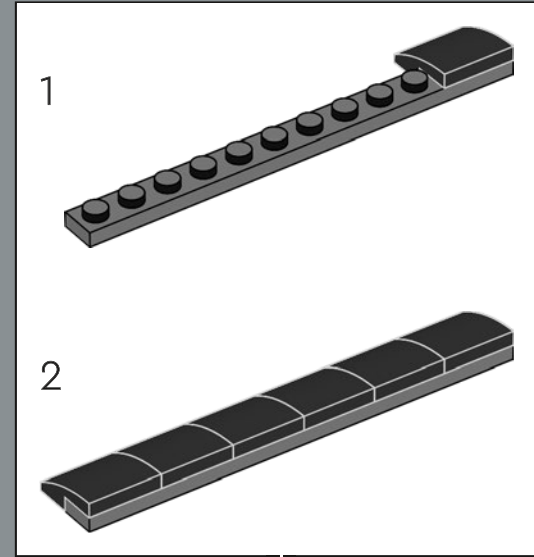

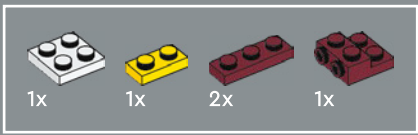

143

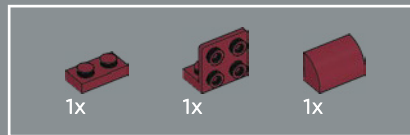
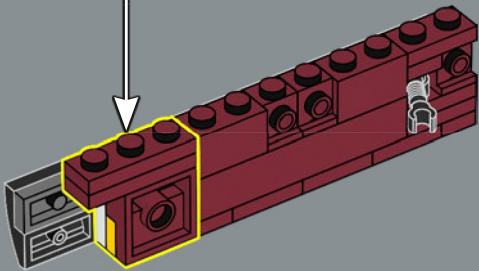
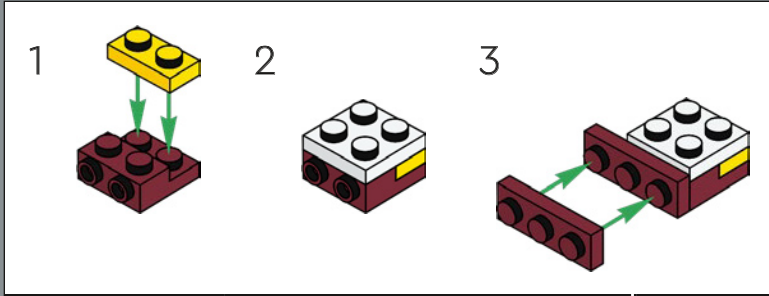

144

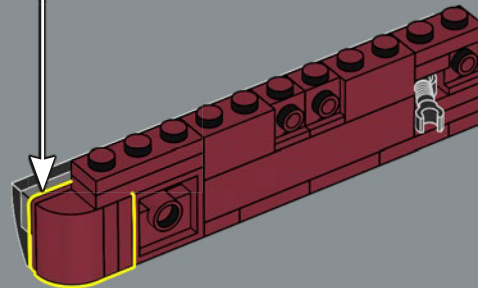
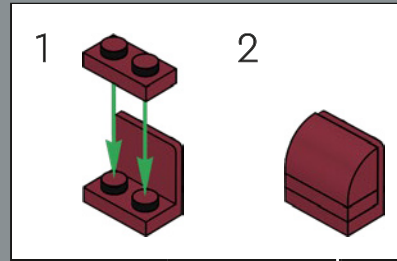

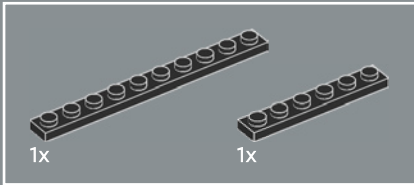
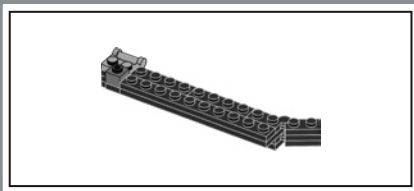

145

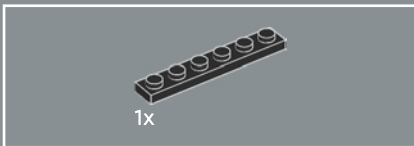
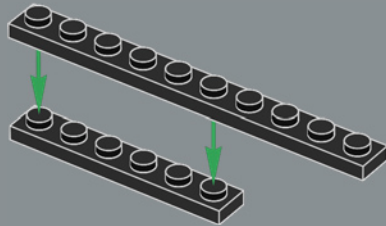

146

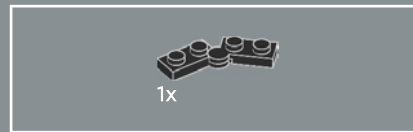
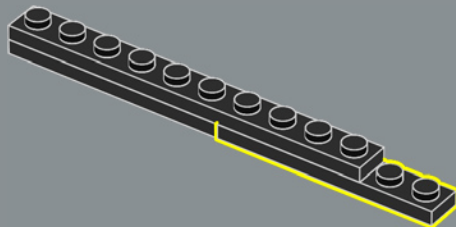

147

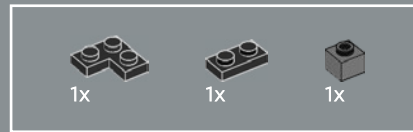
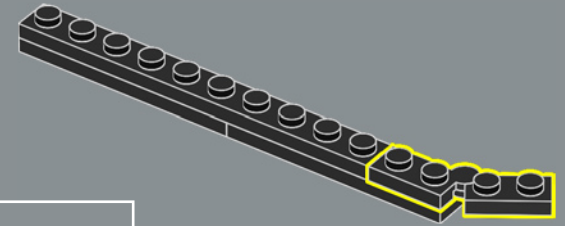

148

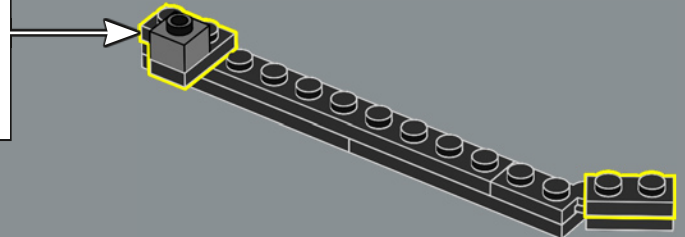
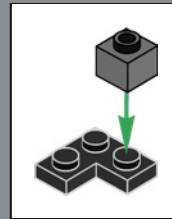

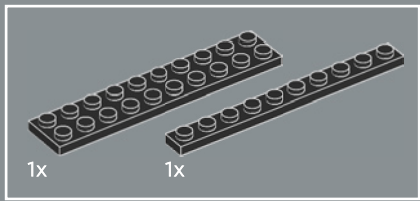

149

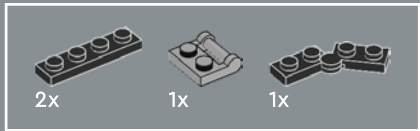
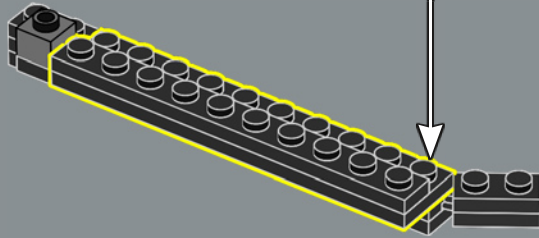
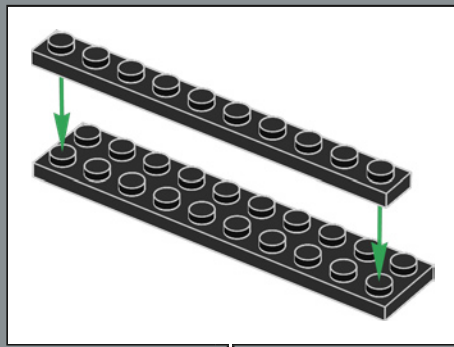

150

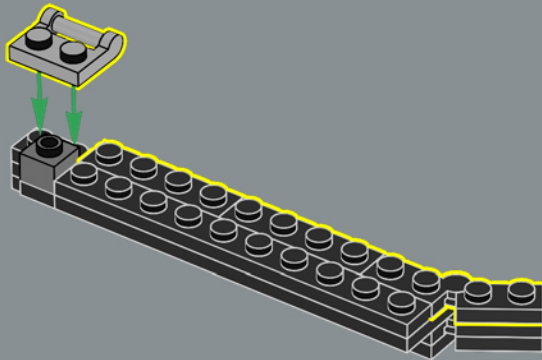

151

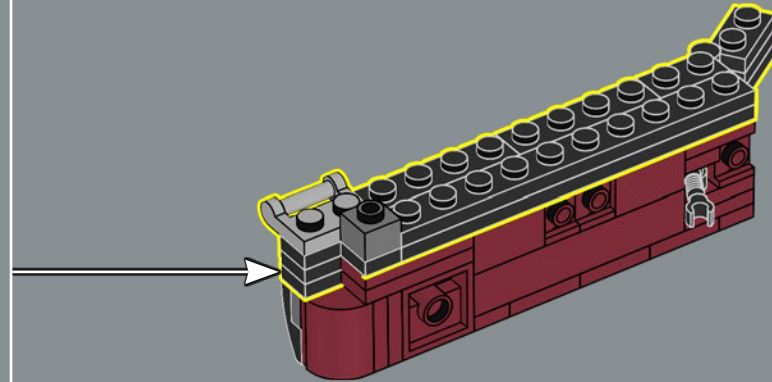

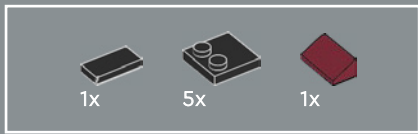

152

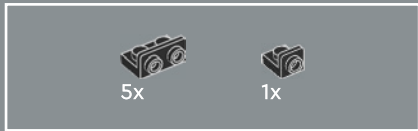
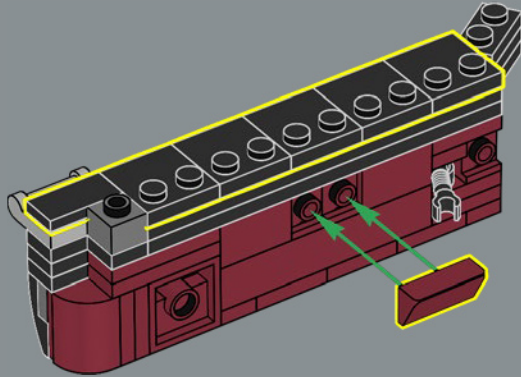

153

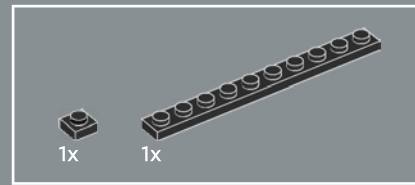
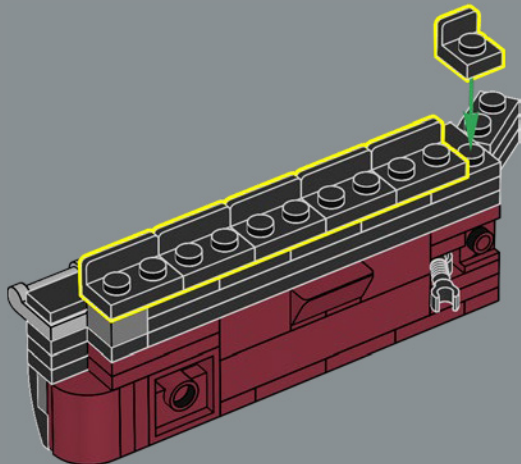

154

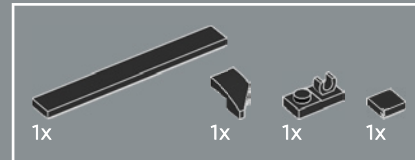
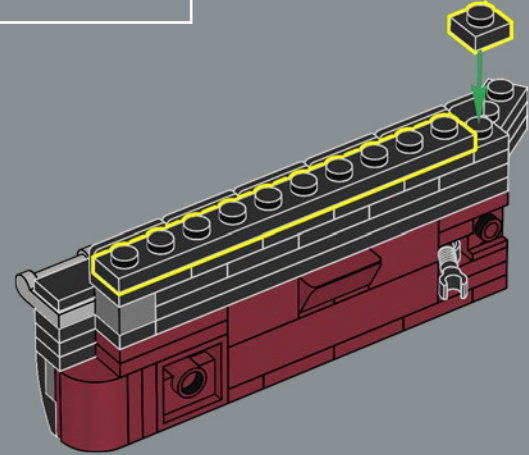

155

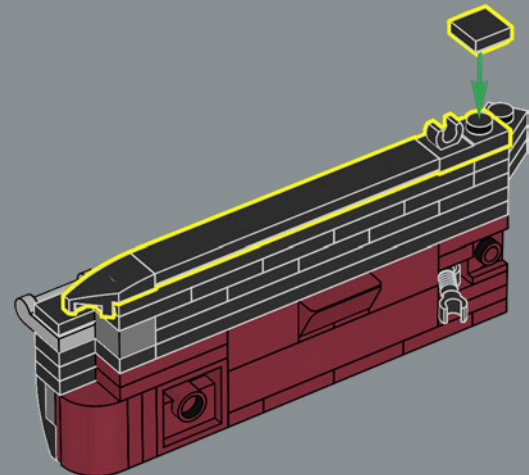



6x

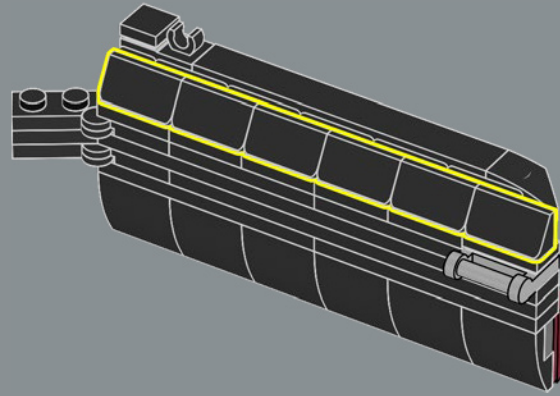

156

157

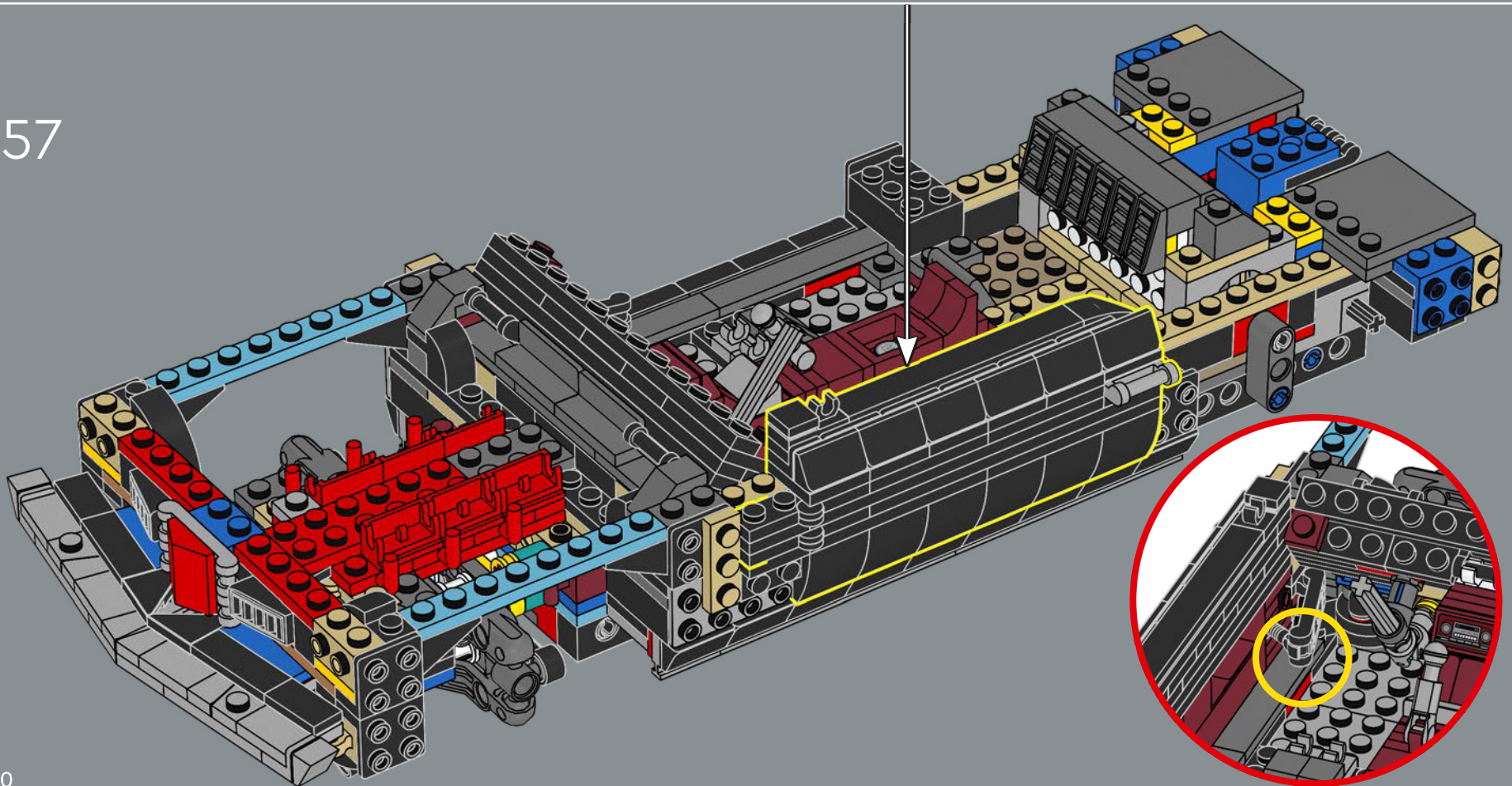



158

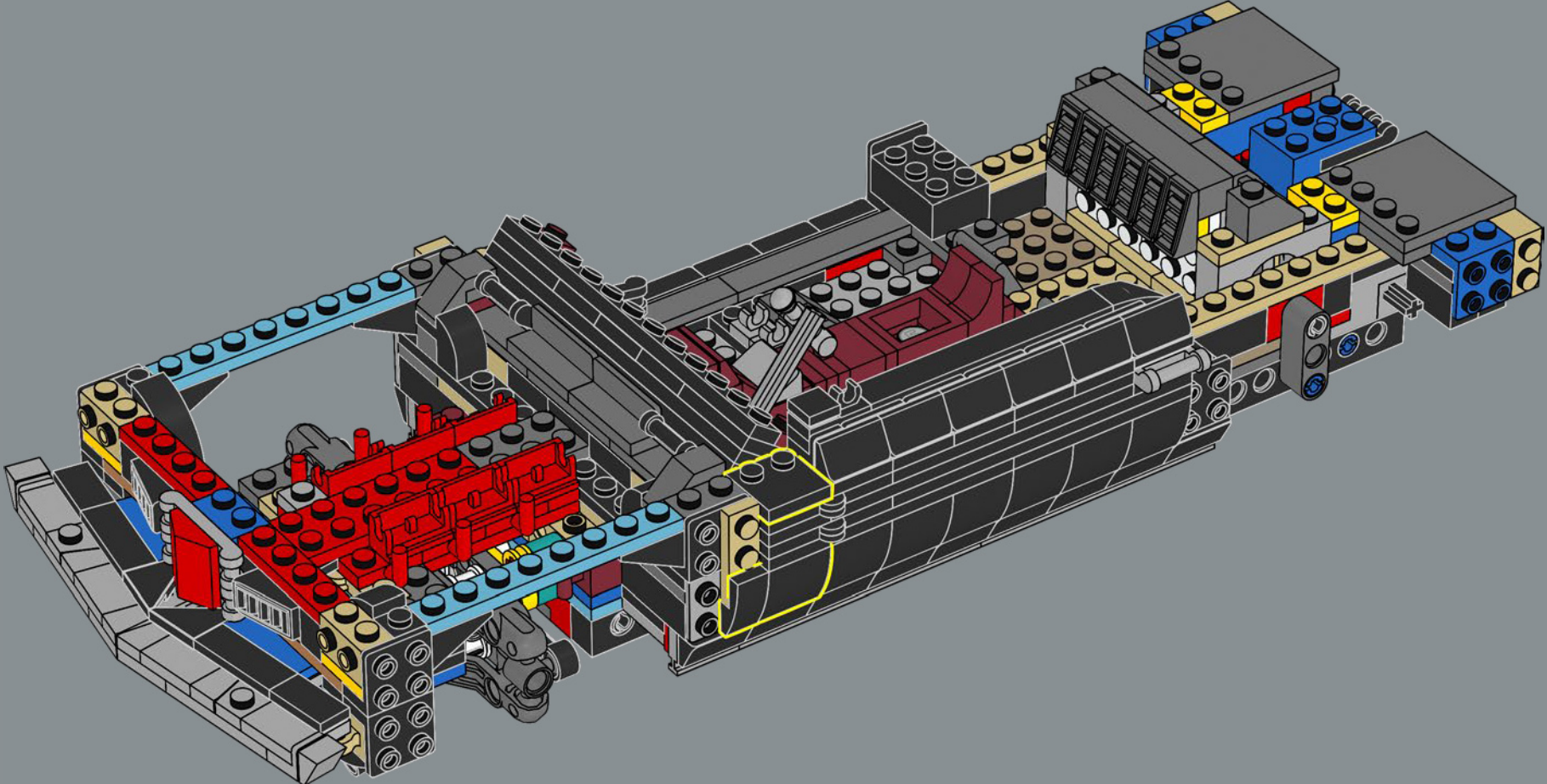

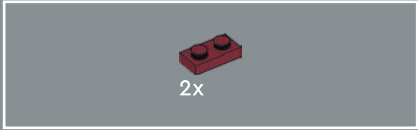
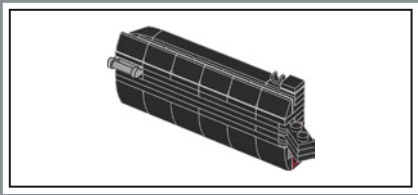

159

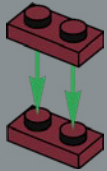

160

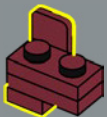

161

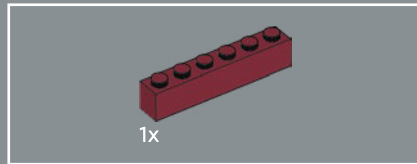
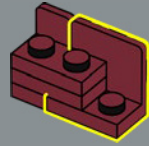

162

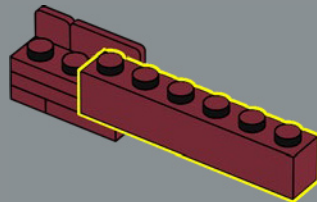

163

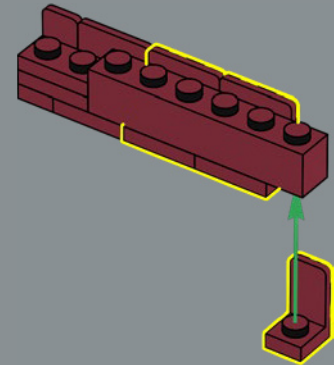



164

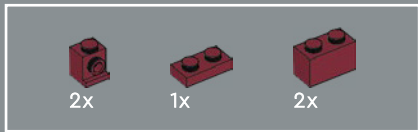
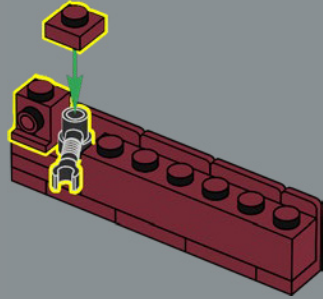

165

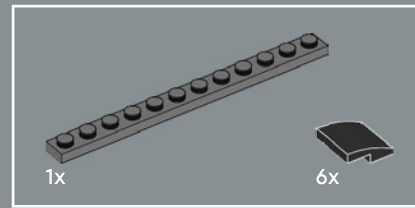
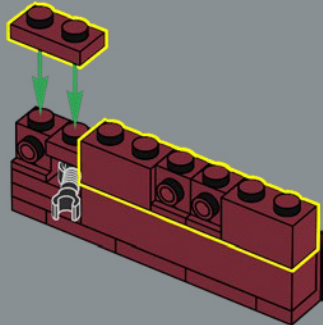

166

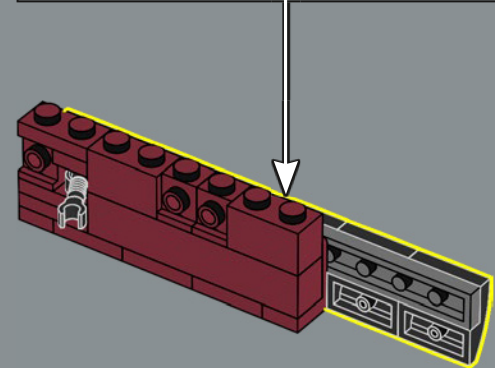
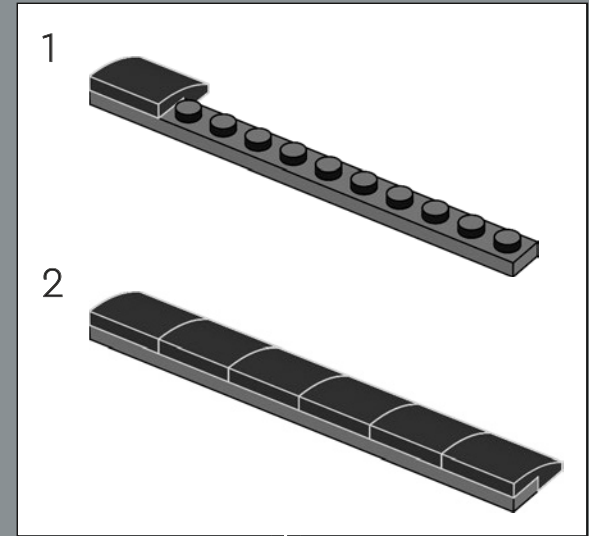

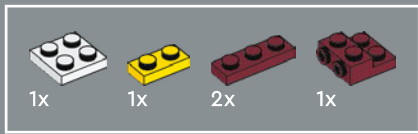

167

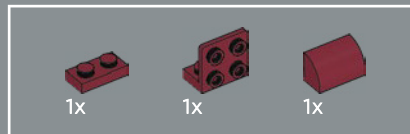
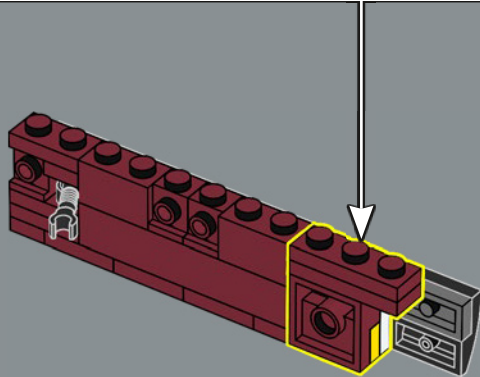
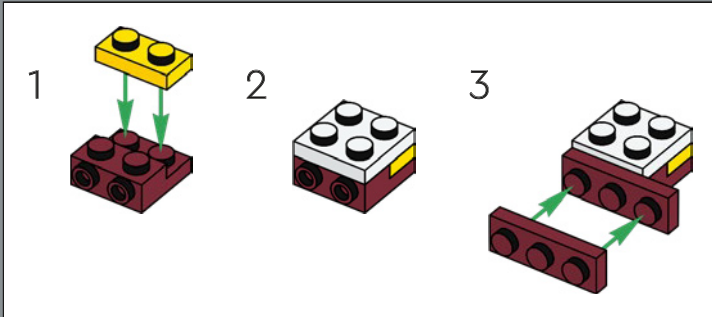

168

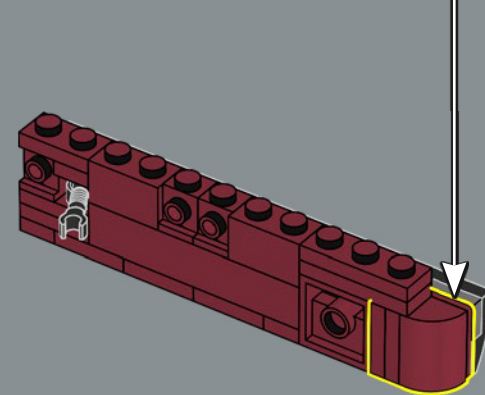
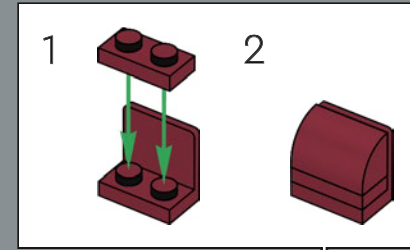

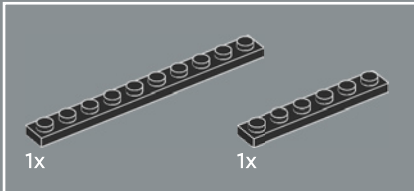
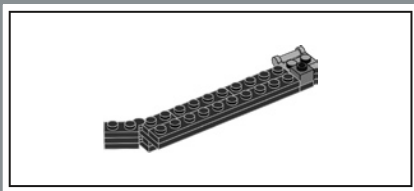

169

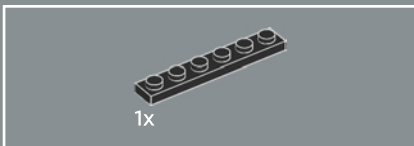
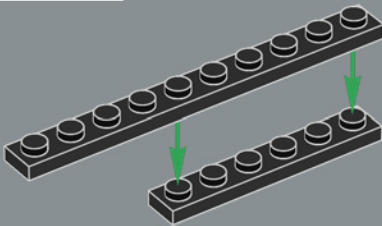

170

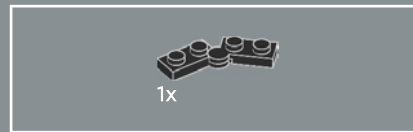
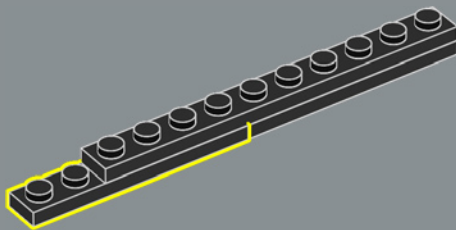

171

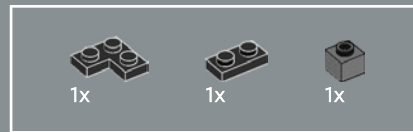
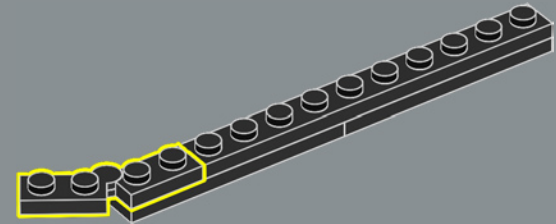

172

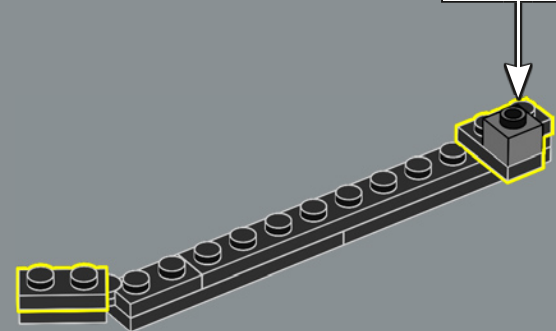
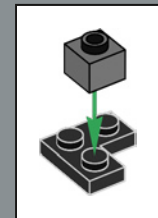

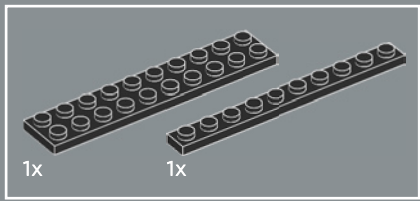

173

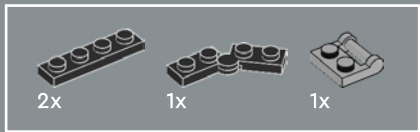
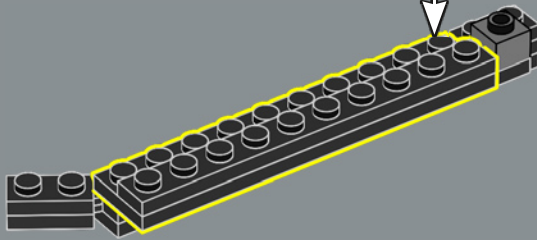
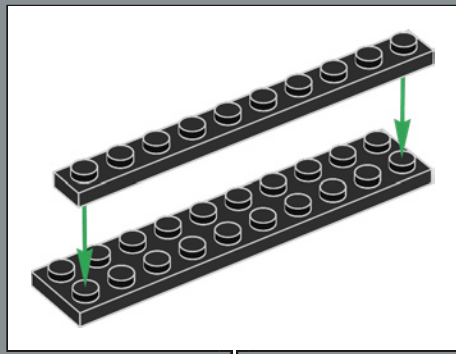

174

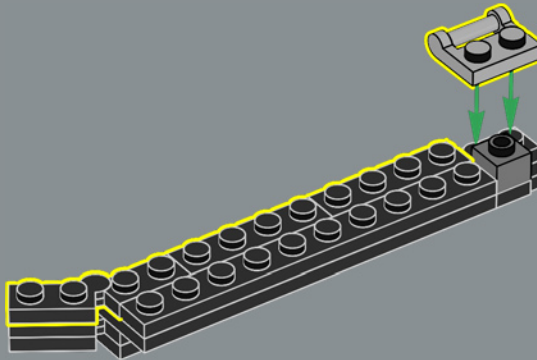

175

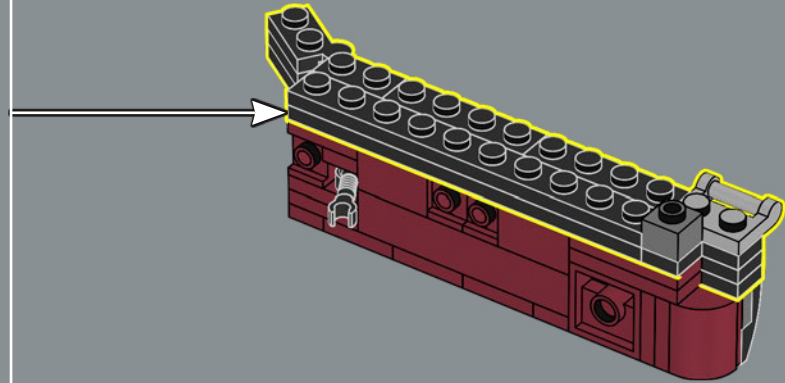

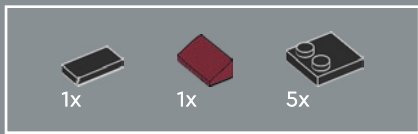

176

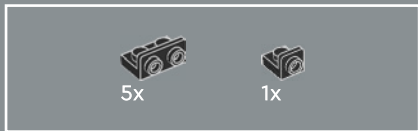
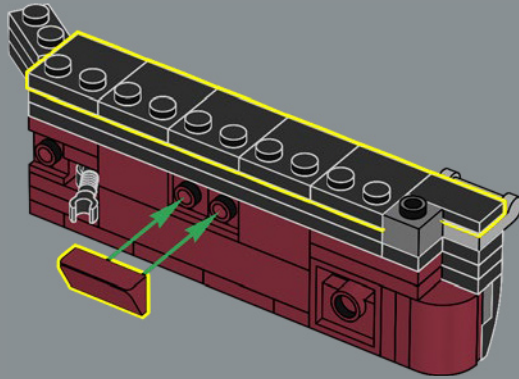

177

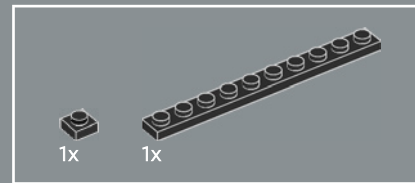
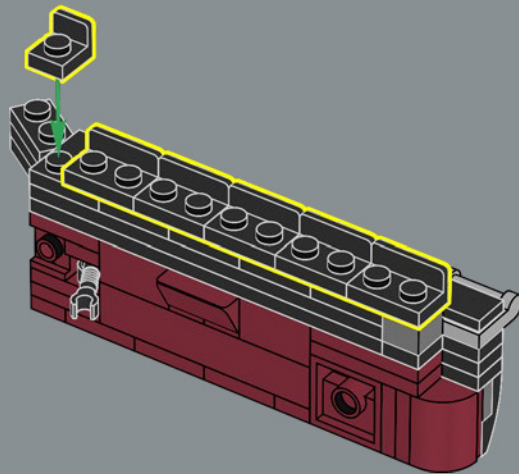

178

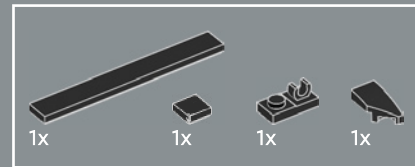
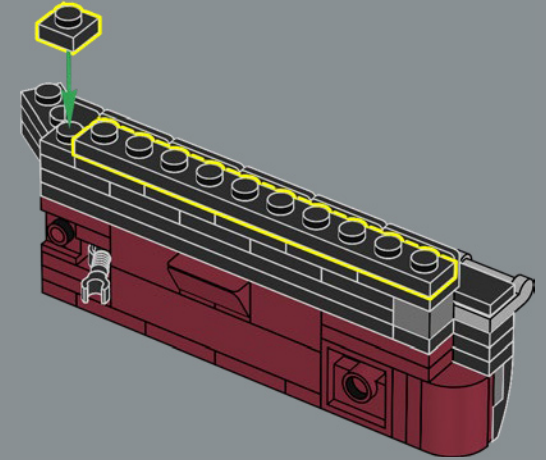

179

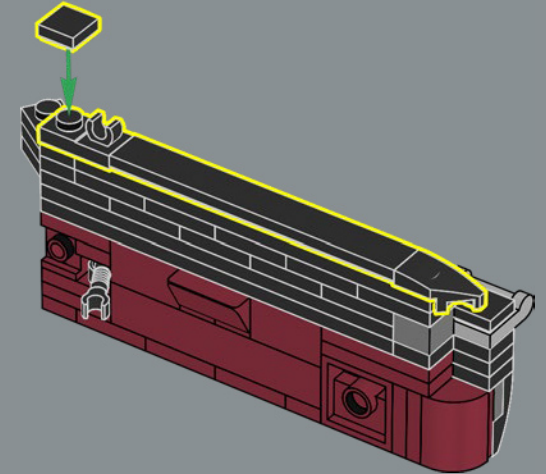



6x

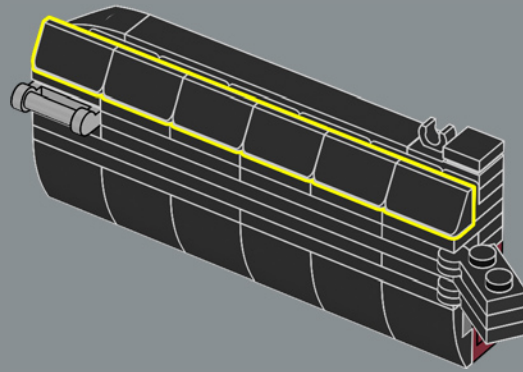

180

181

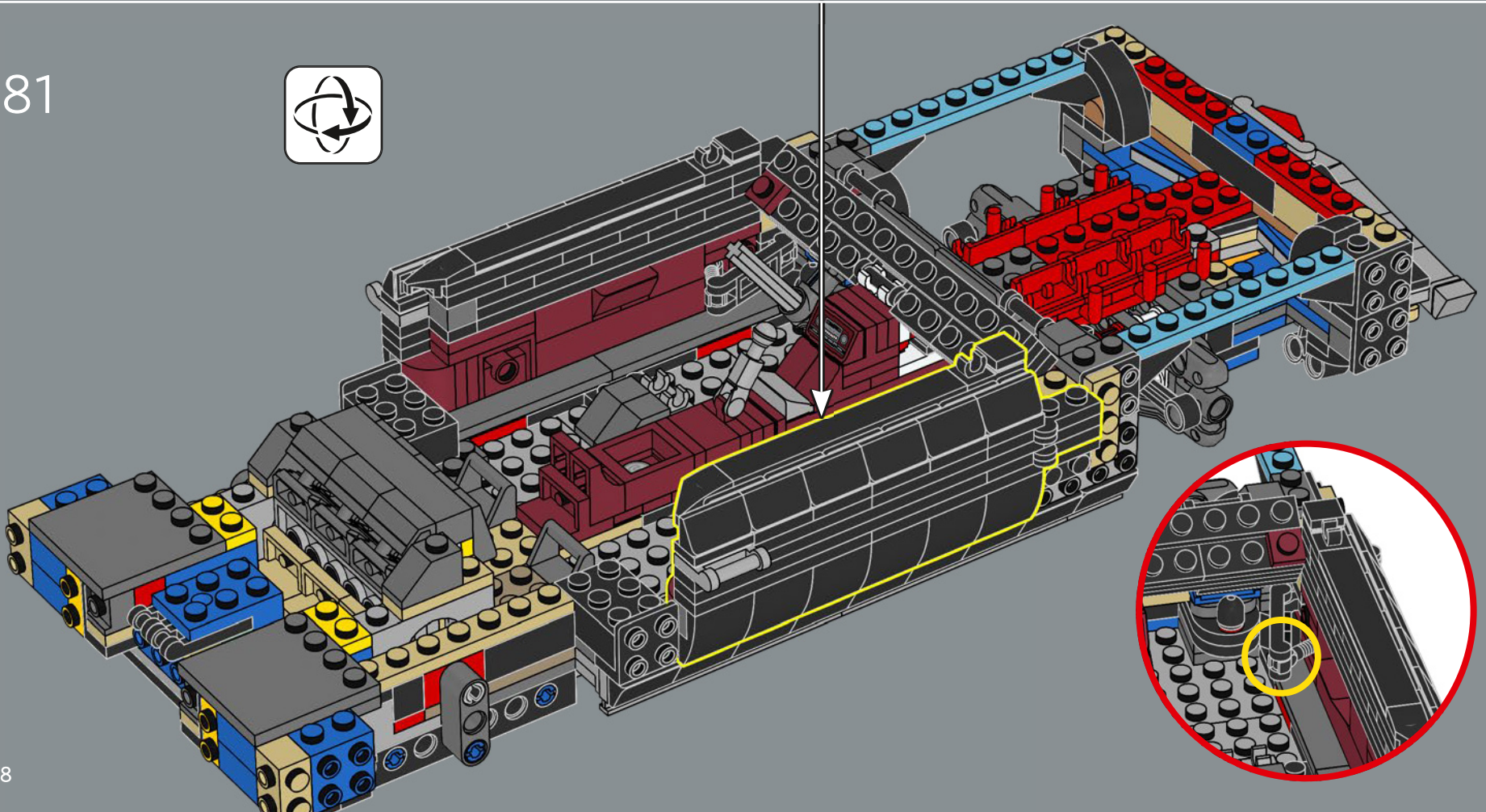



Between all the models and packages, original Camaro buyers had 80 different factory options to choose from.

182

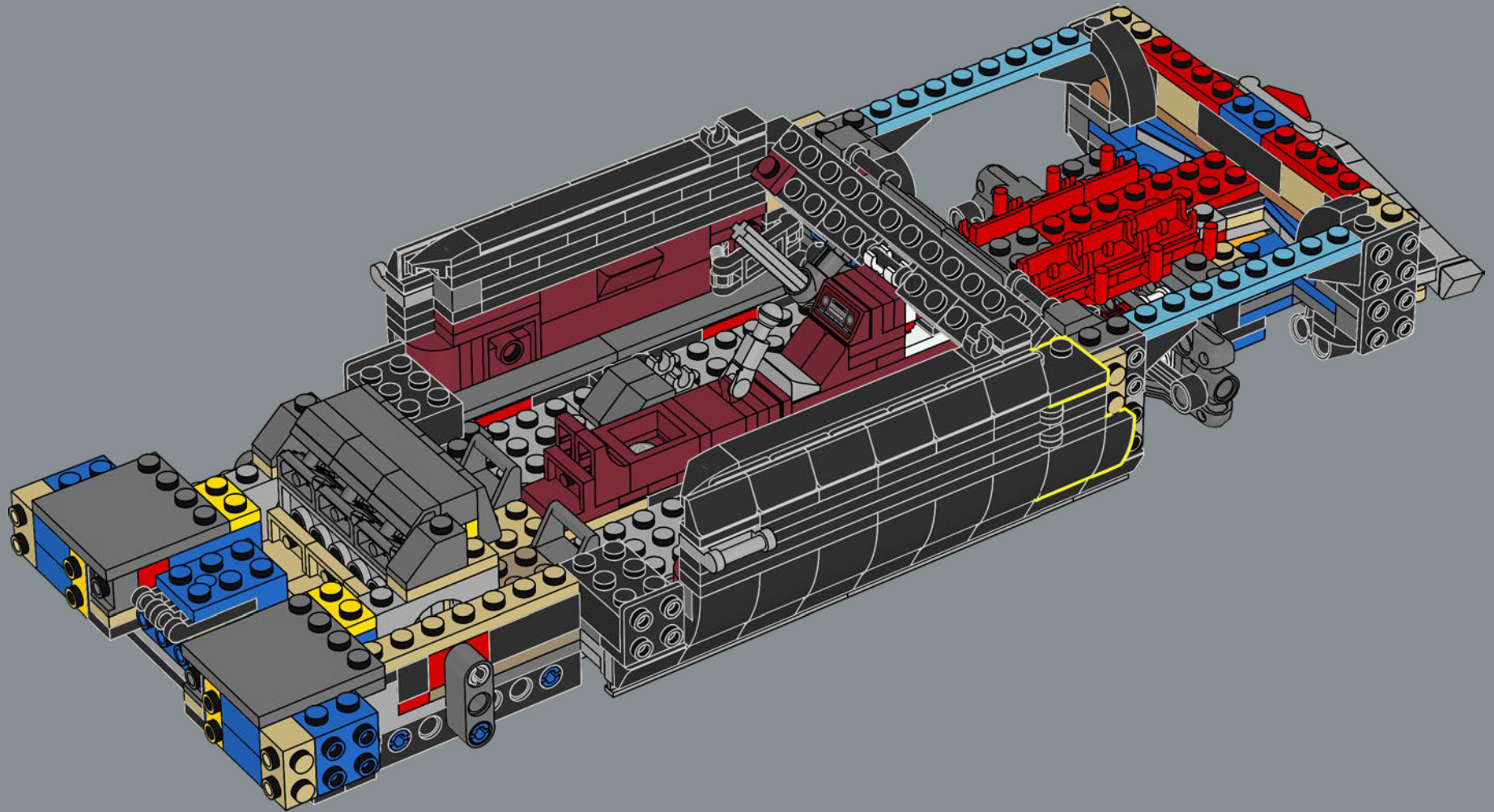

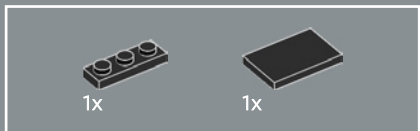

183

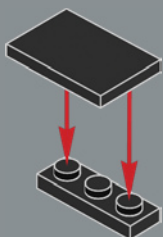

184

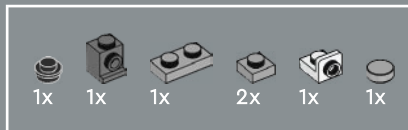
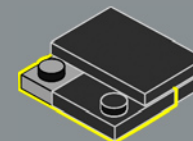

185

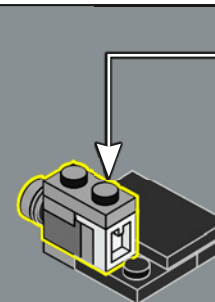
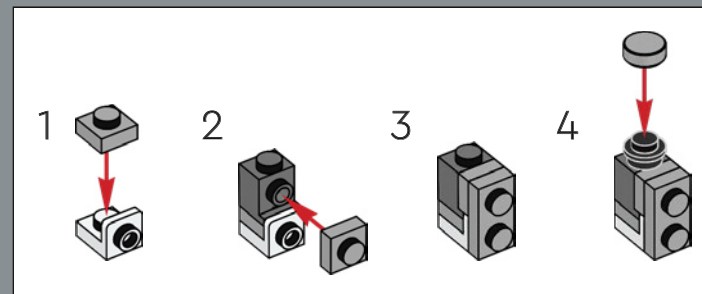

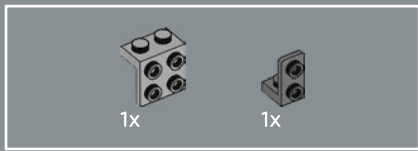

186

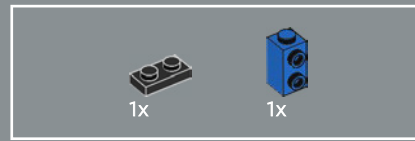
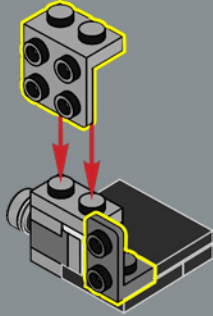

187

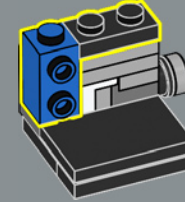

188

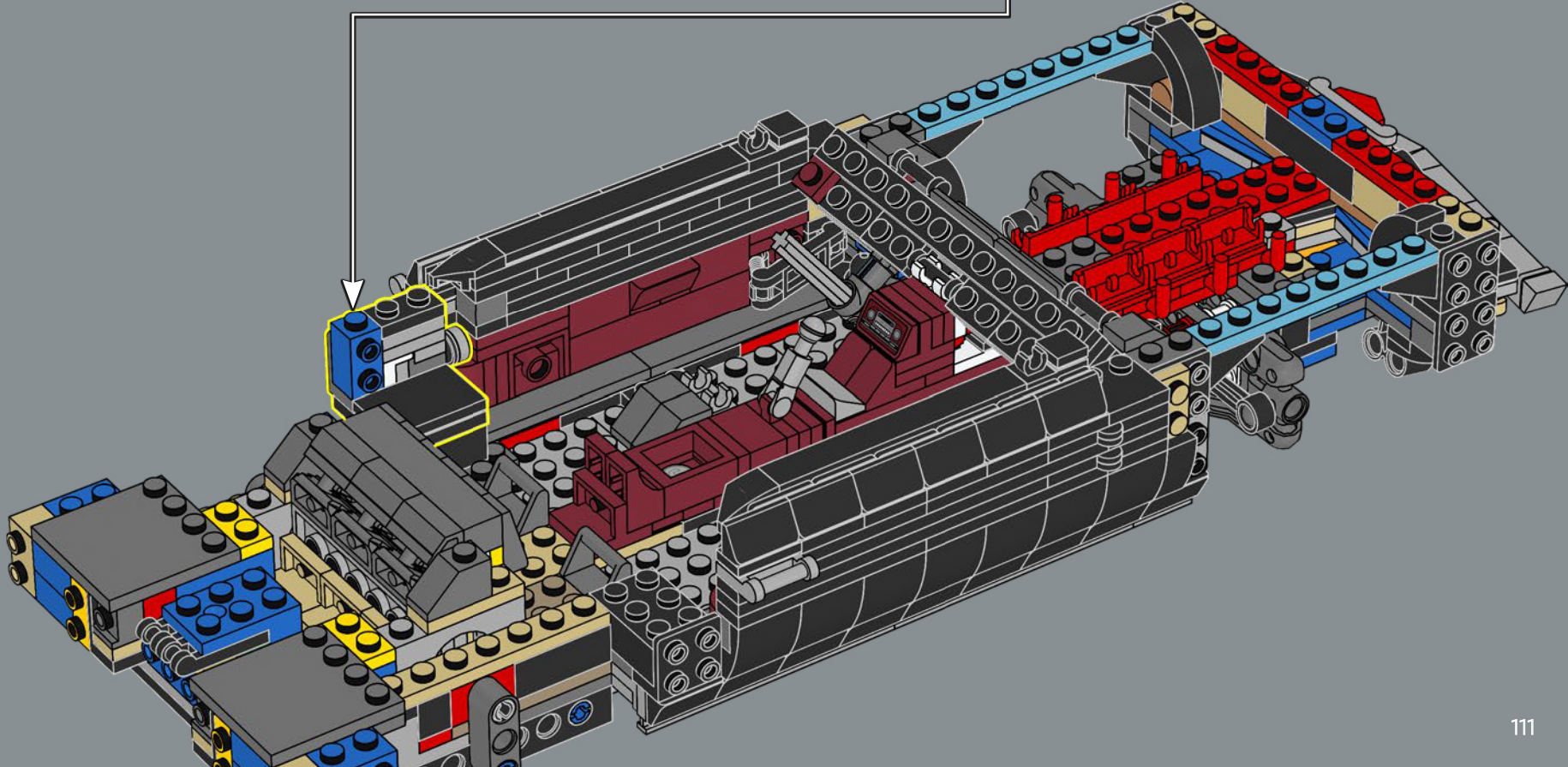

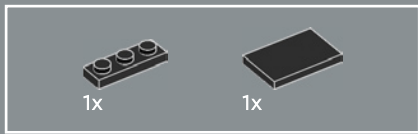

189

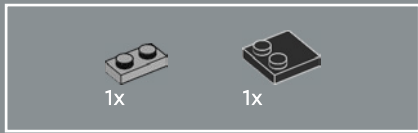
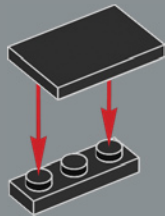

190

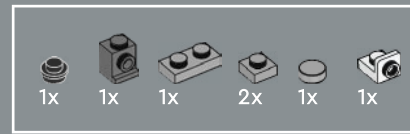
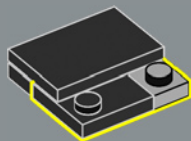

191

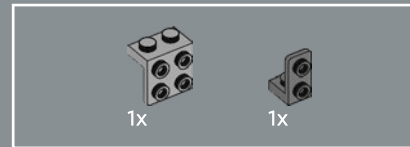
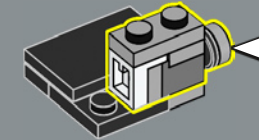
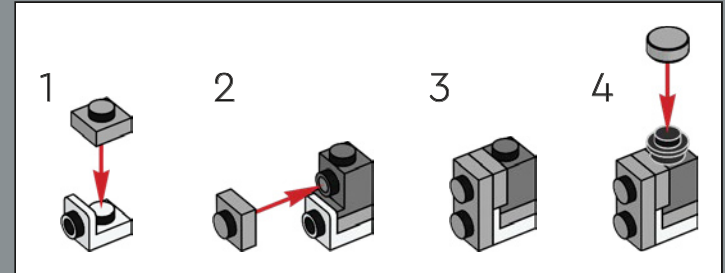

192

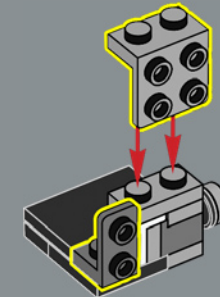

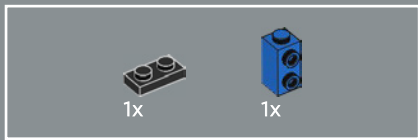

193

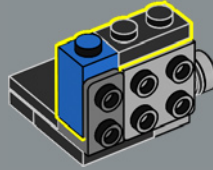

194

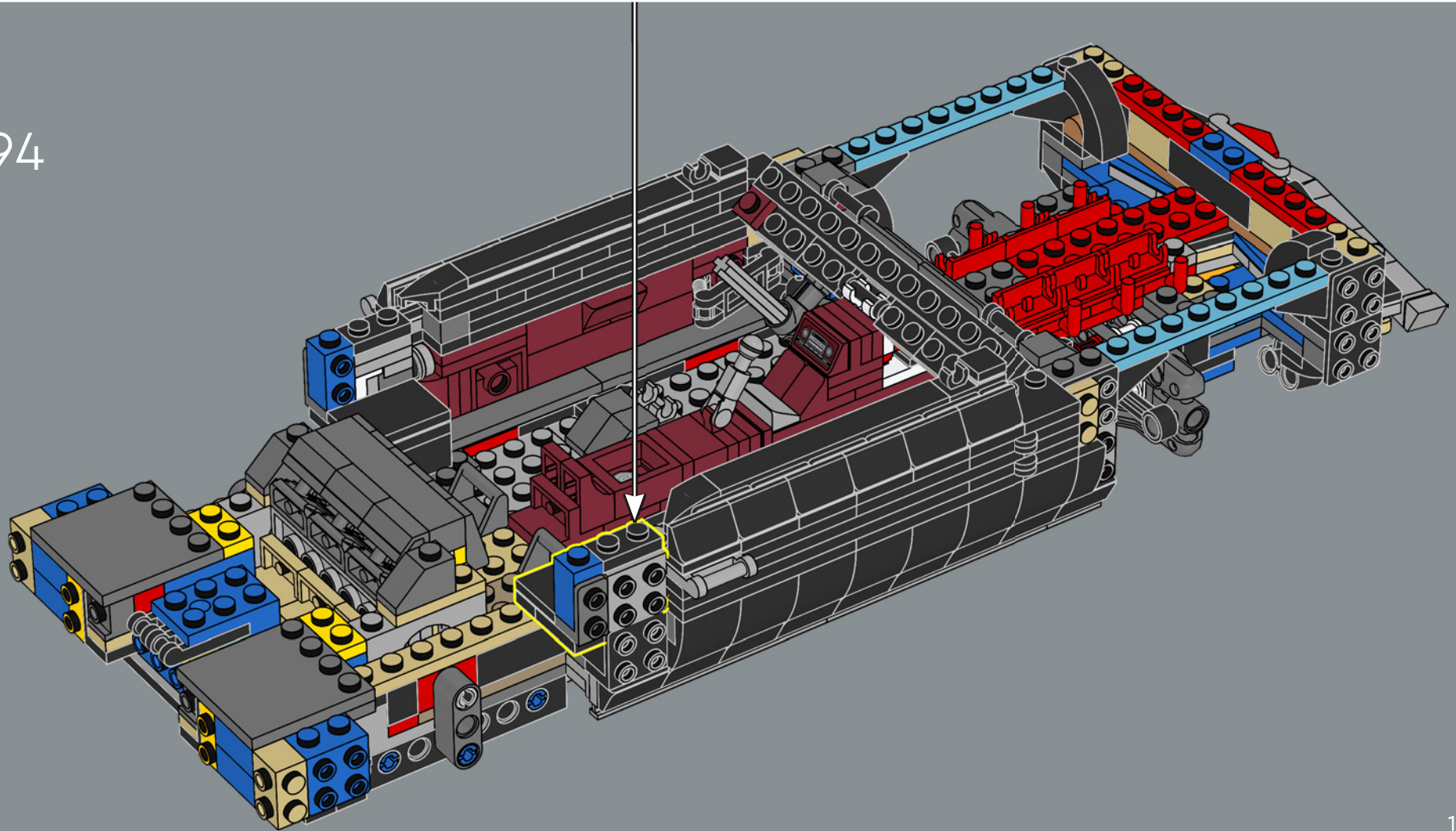

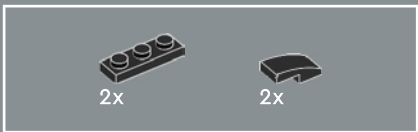

195

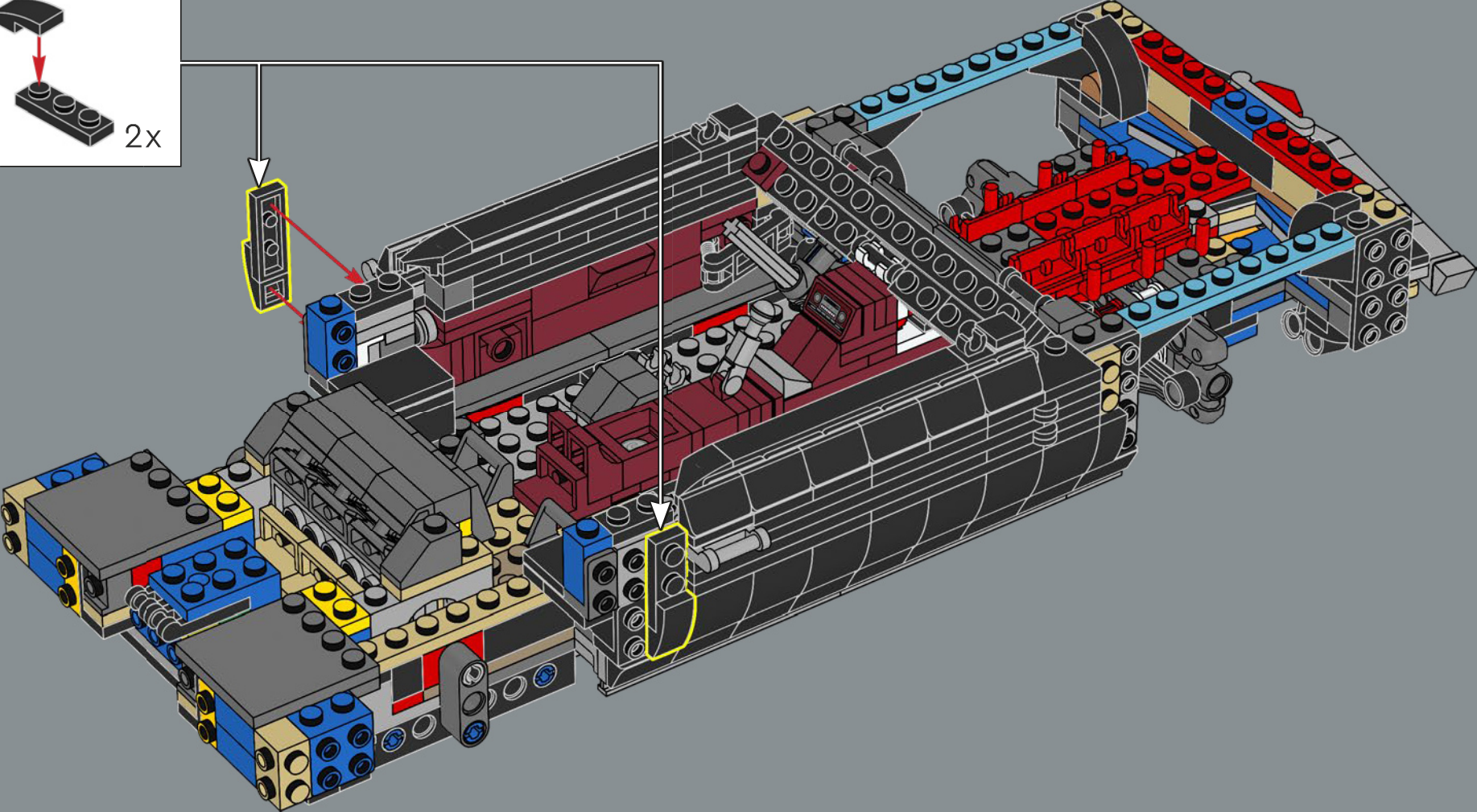
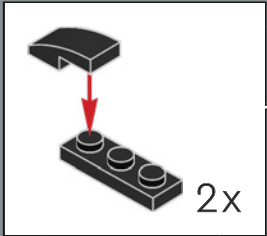

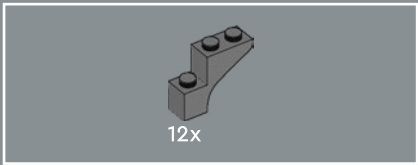

196

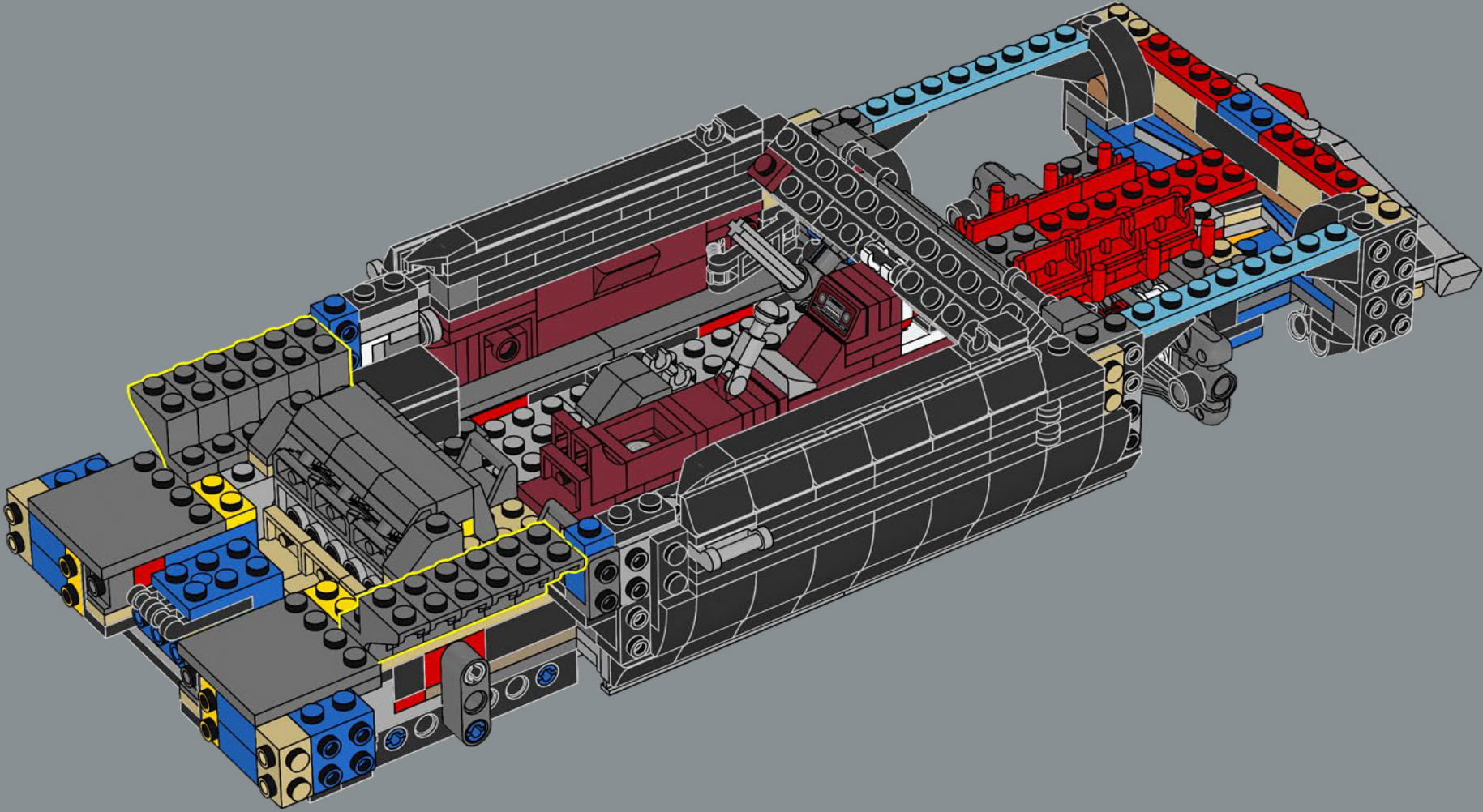

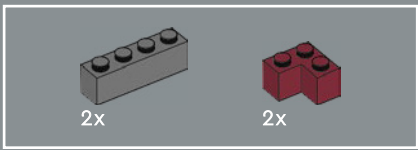

197

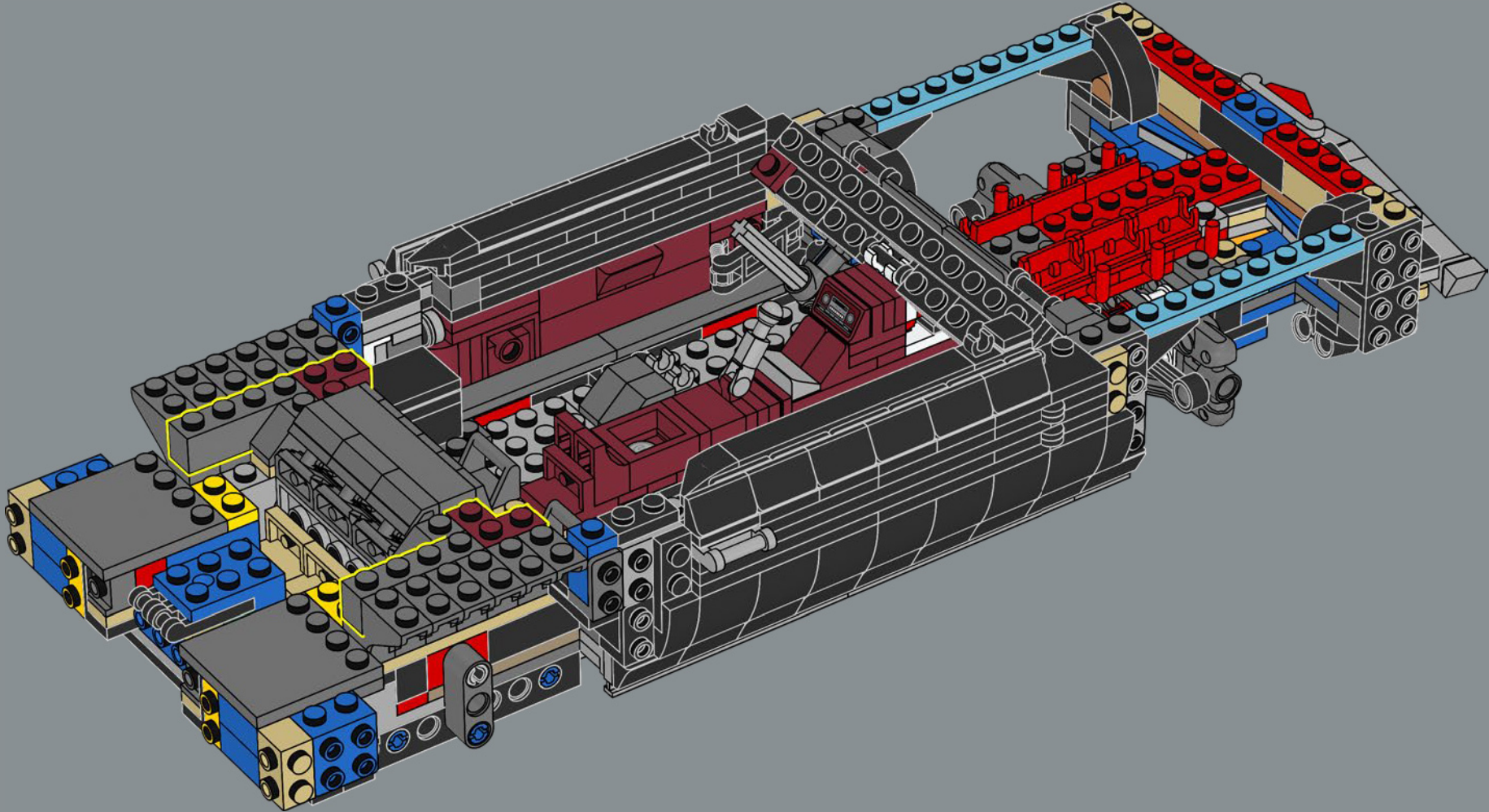

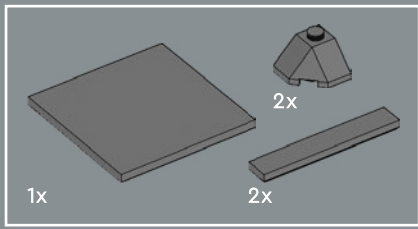

198

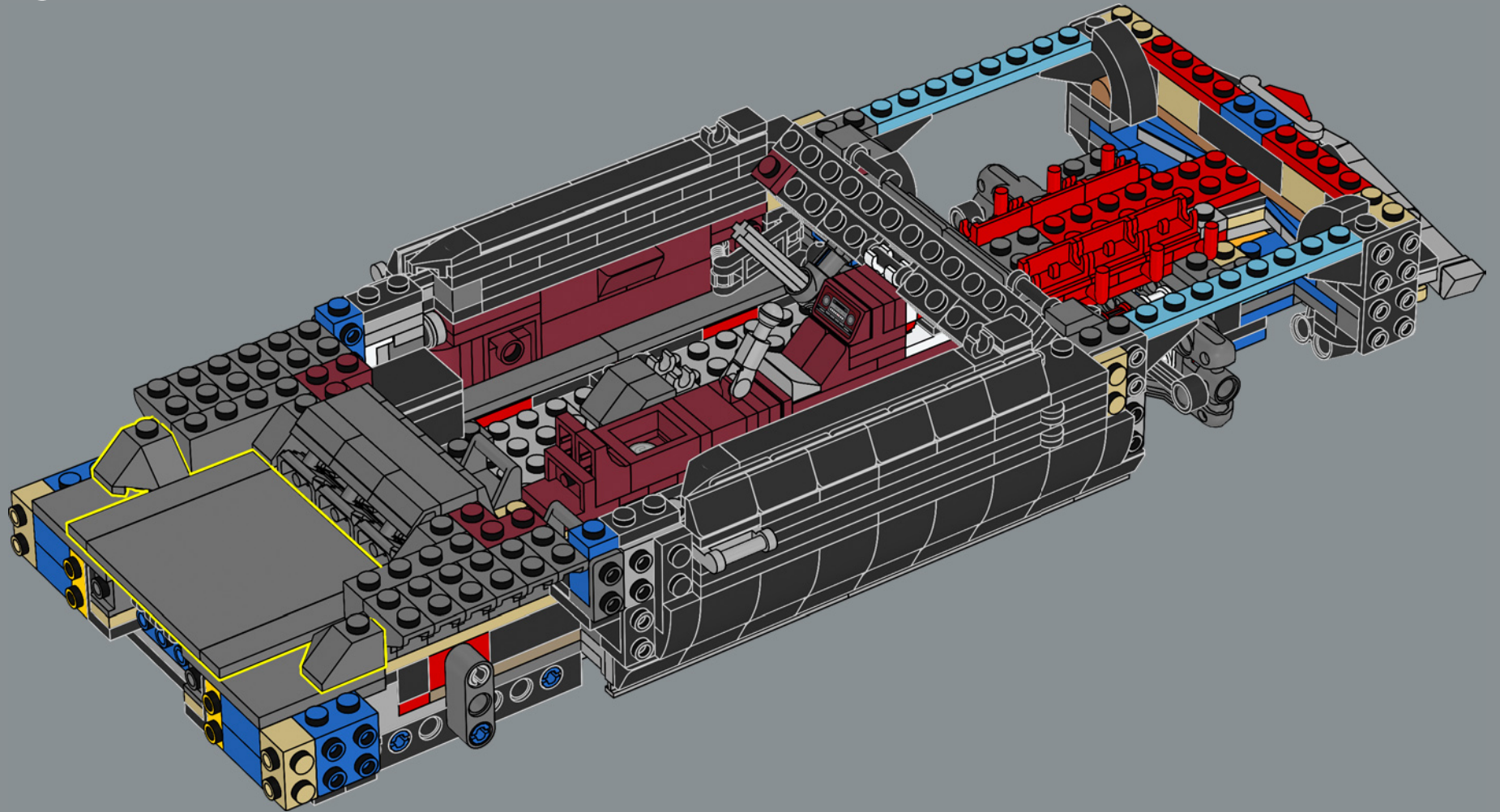

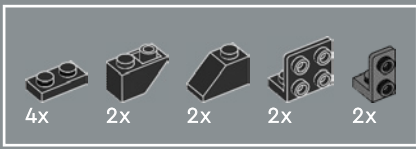

199

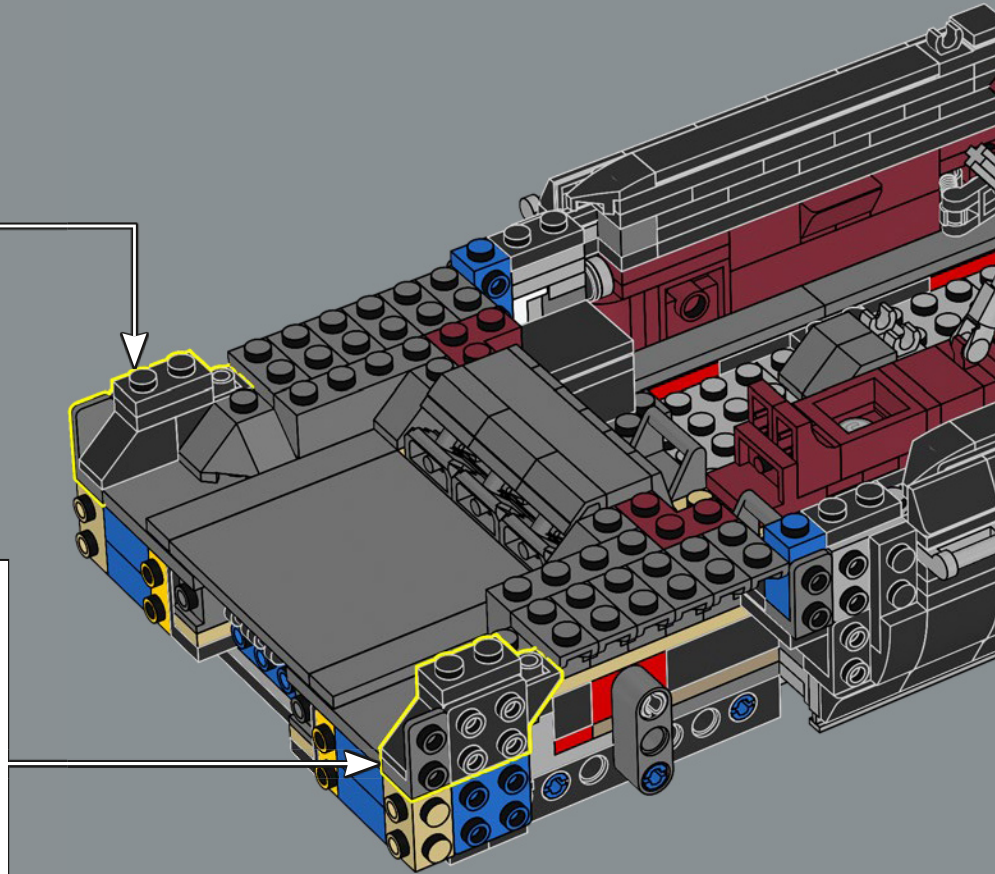
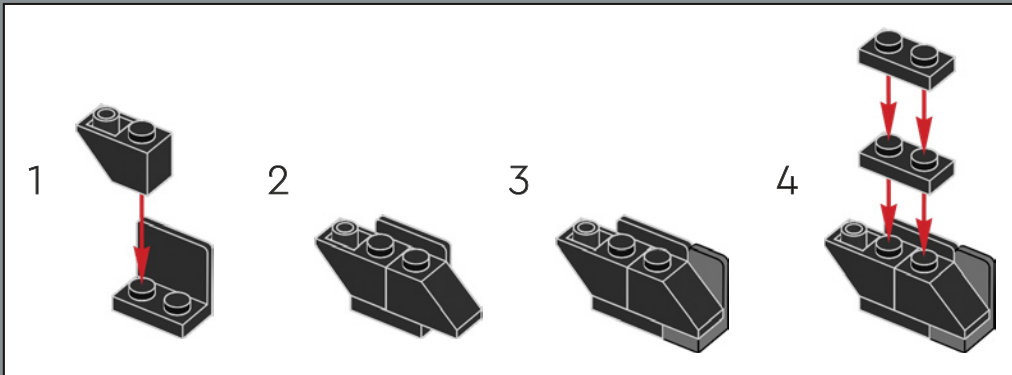
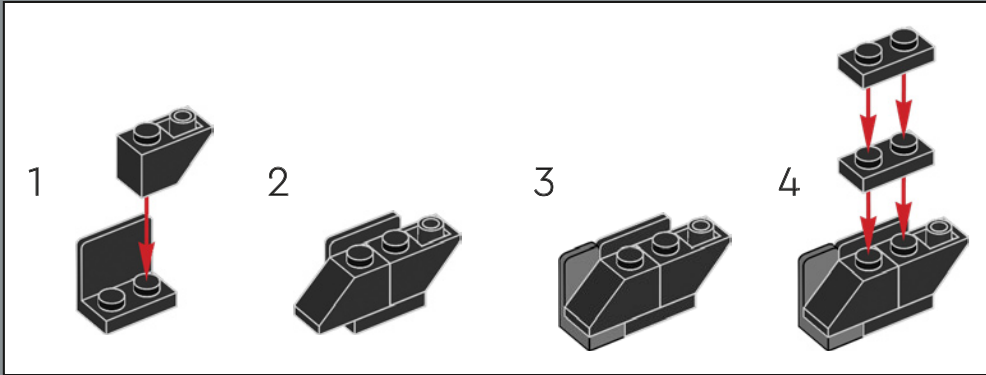

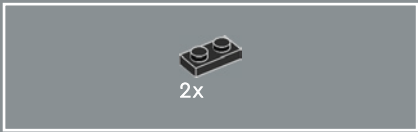

200

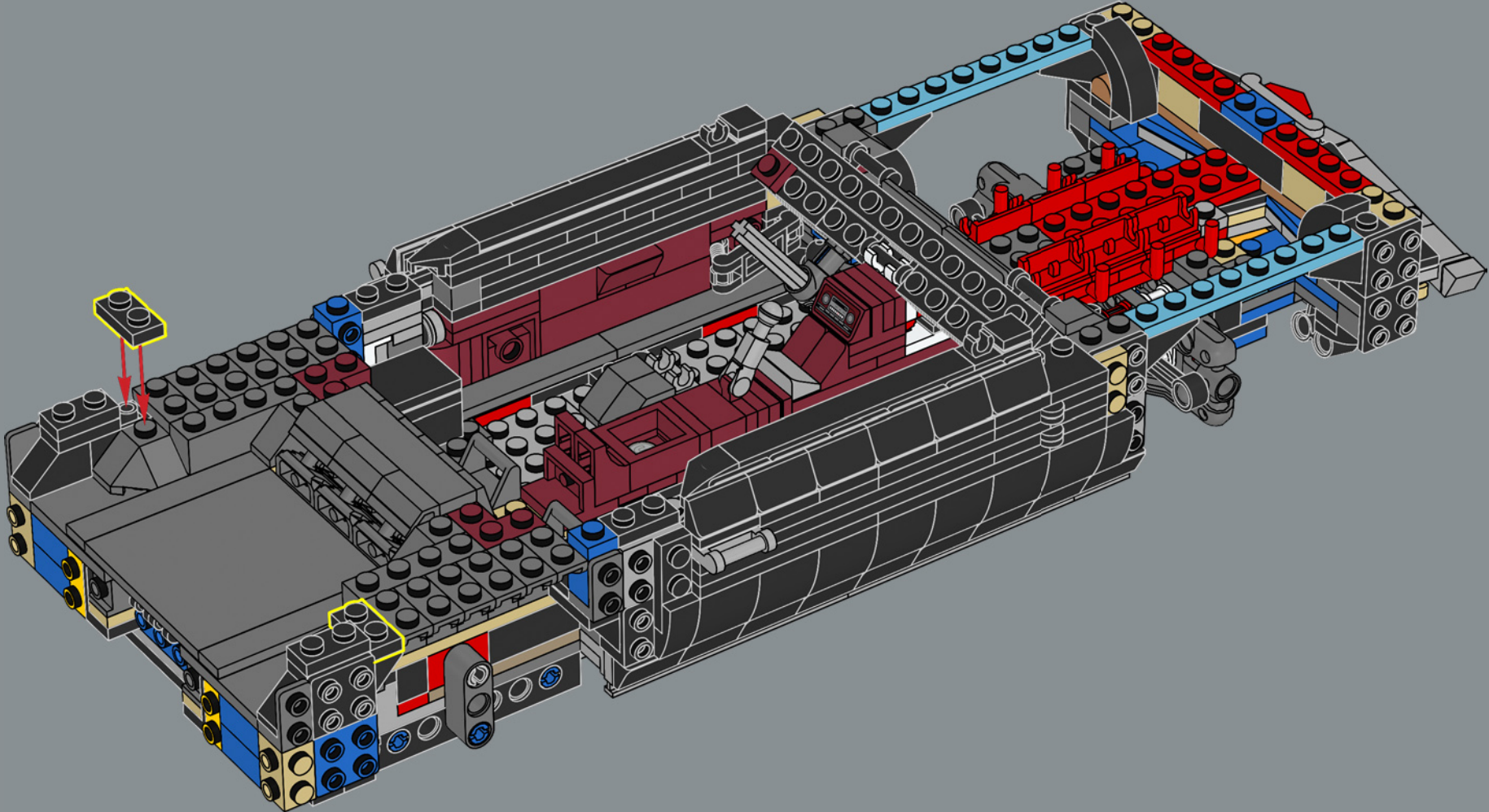



2x

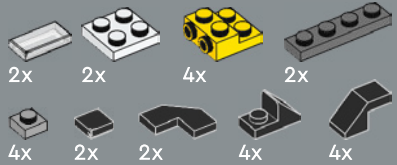

201

1

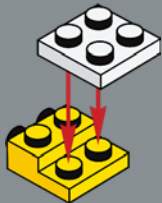

2

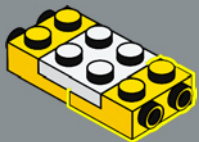

3

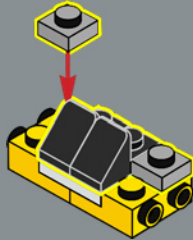

4

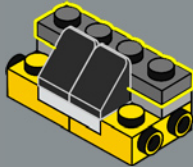

5

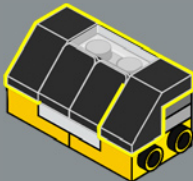

2x

6

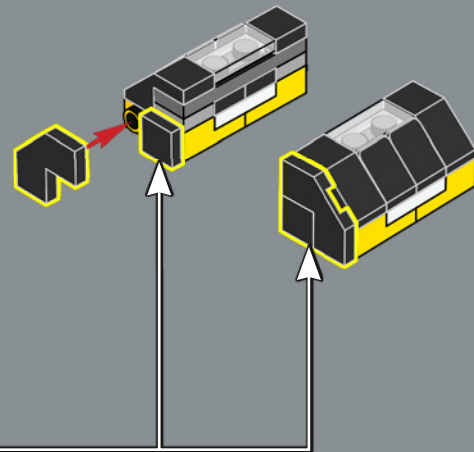

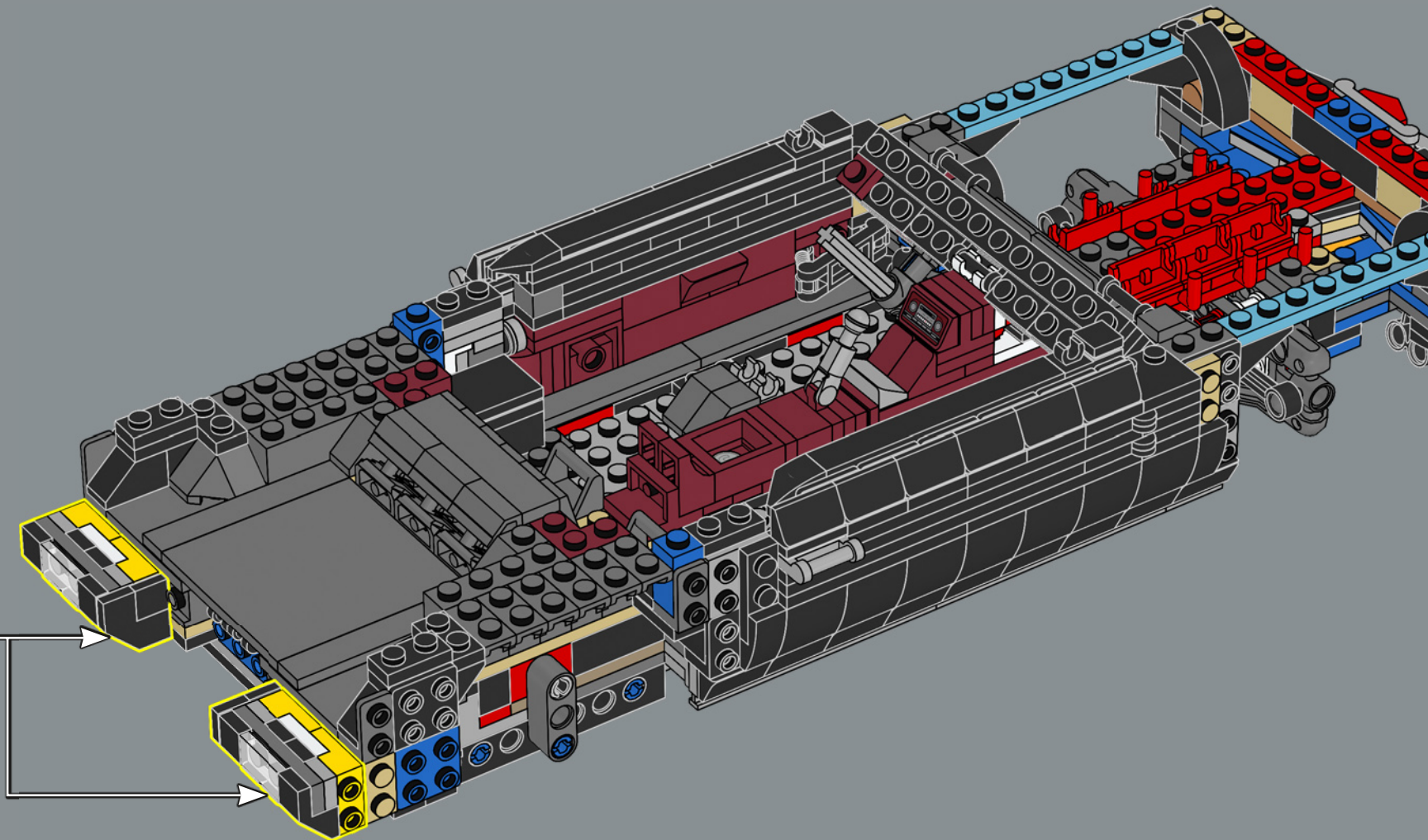



202

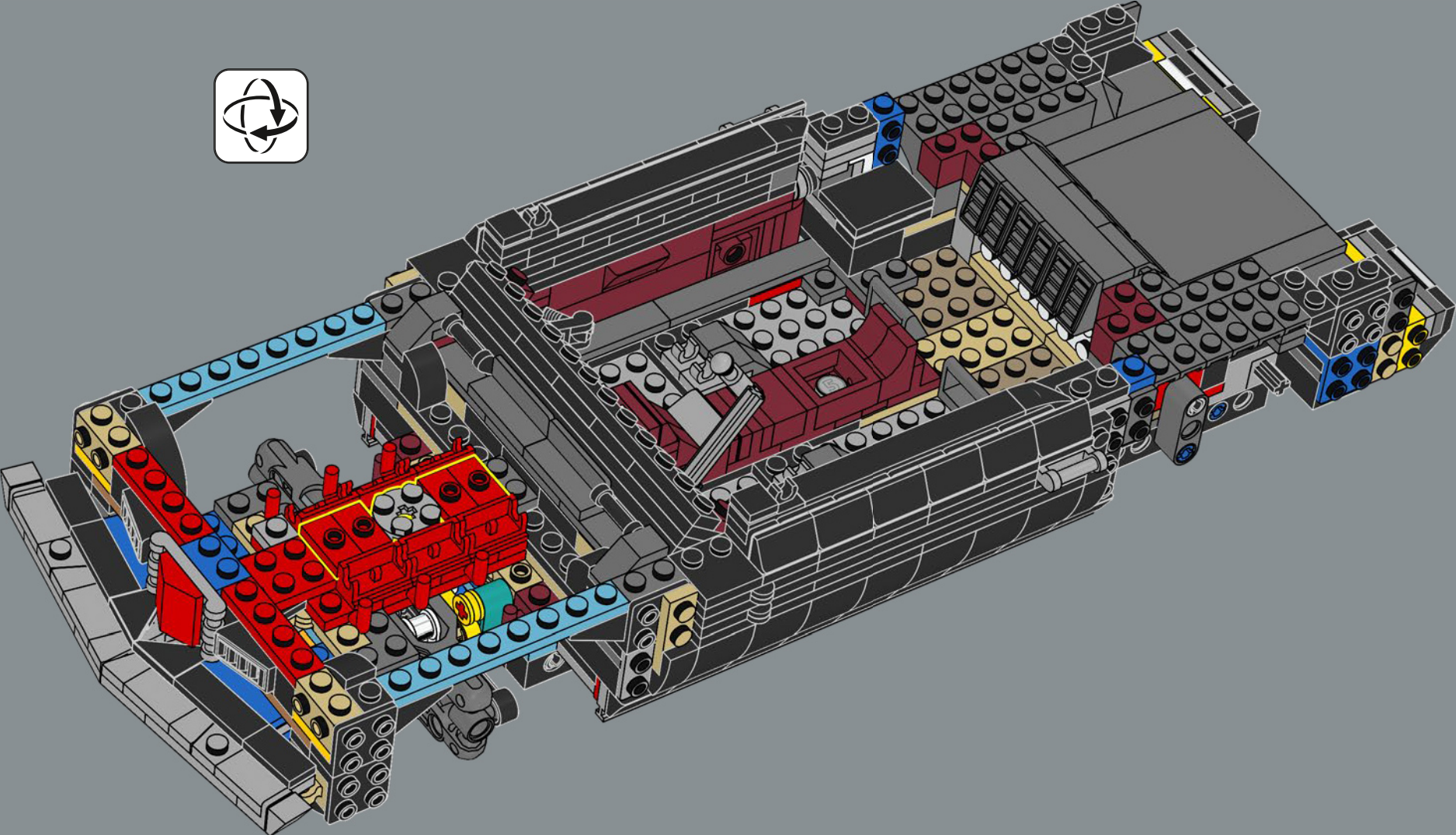

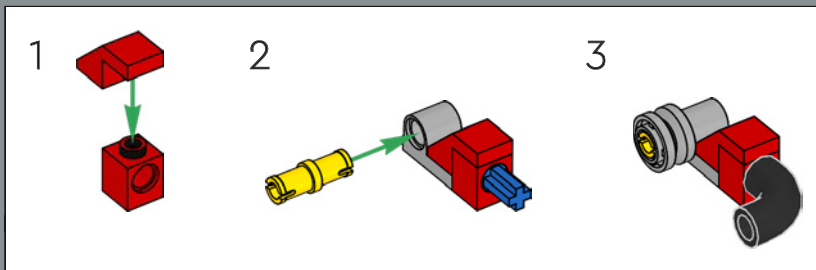
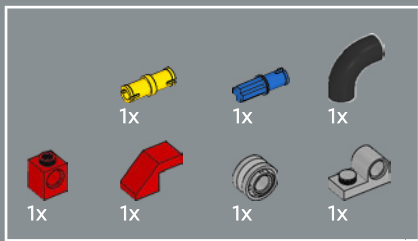

203

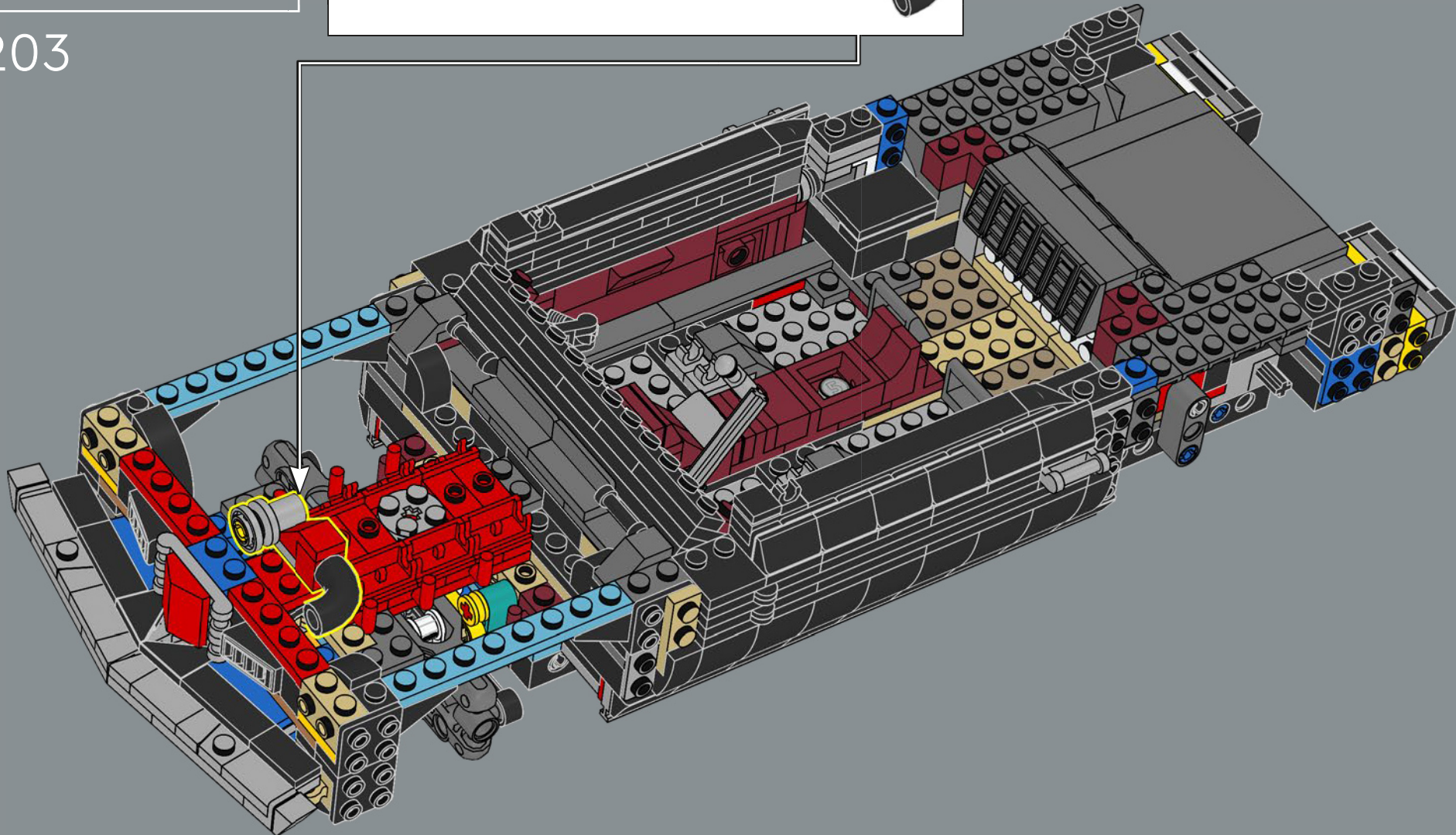

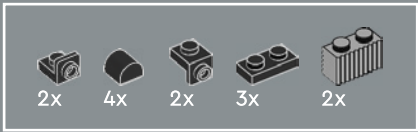

204

1

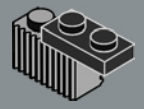

2

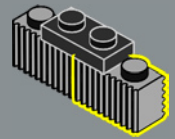

3

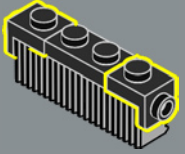

4

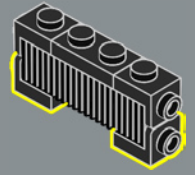

5

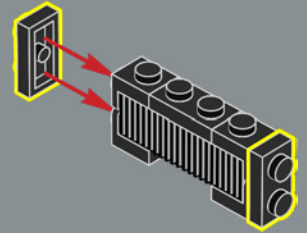

6

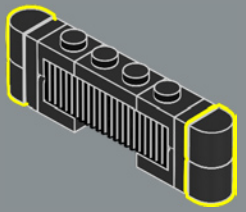

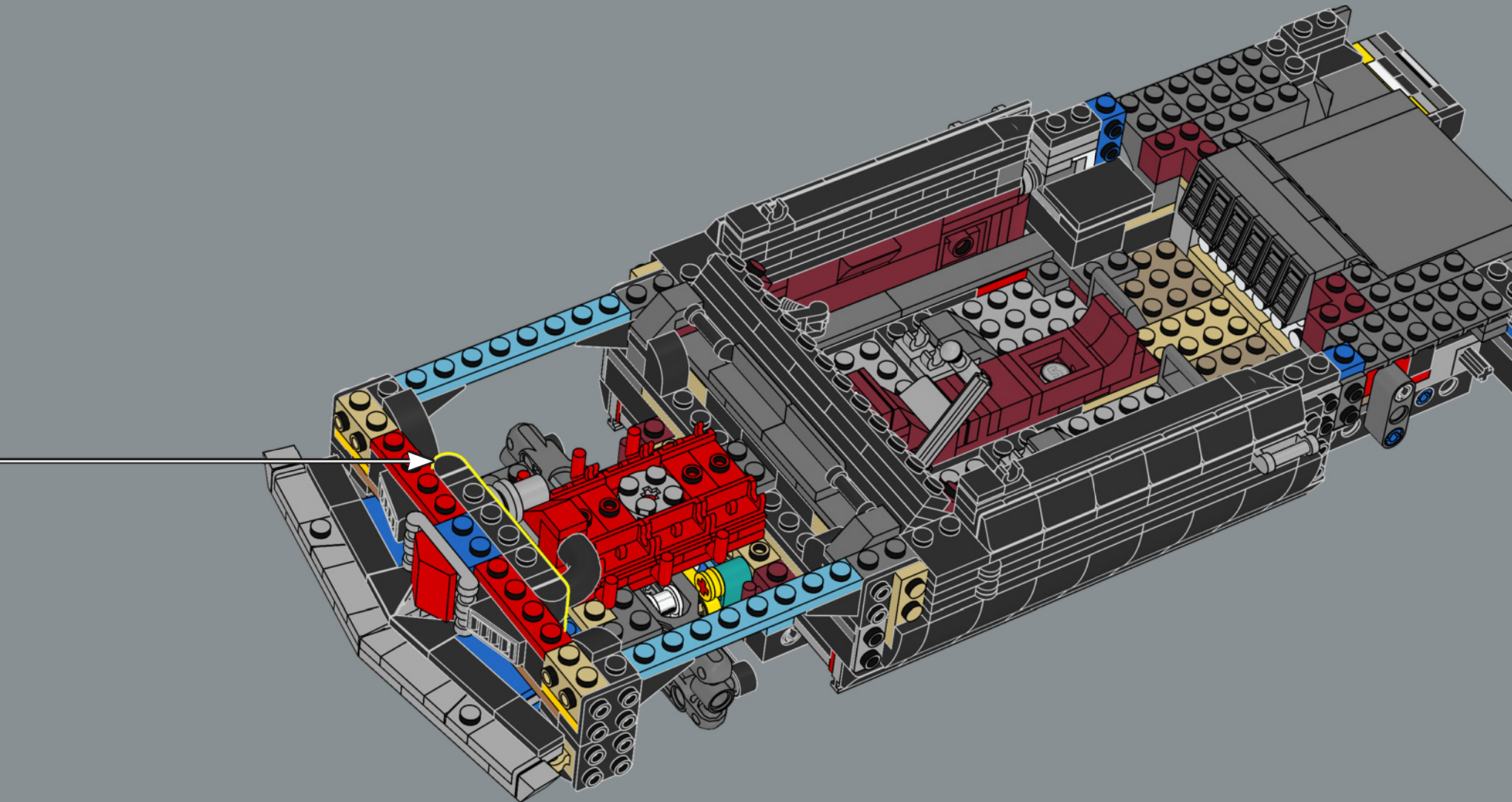

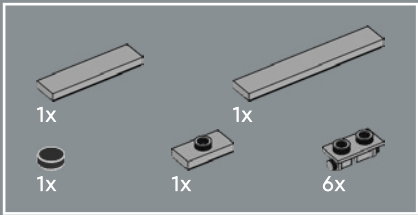

205

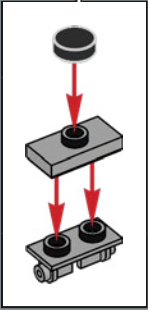
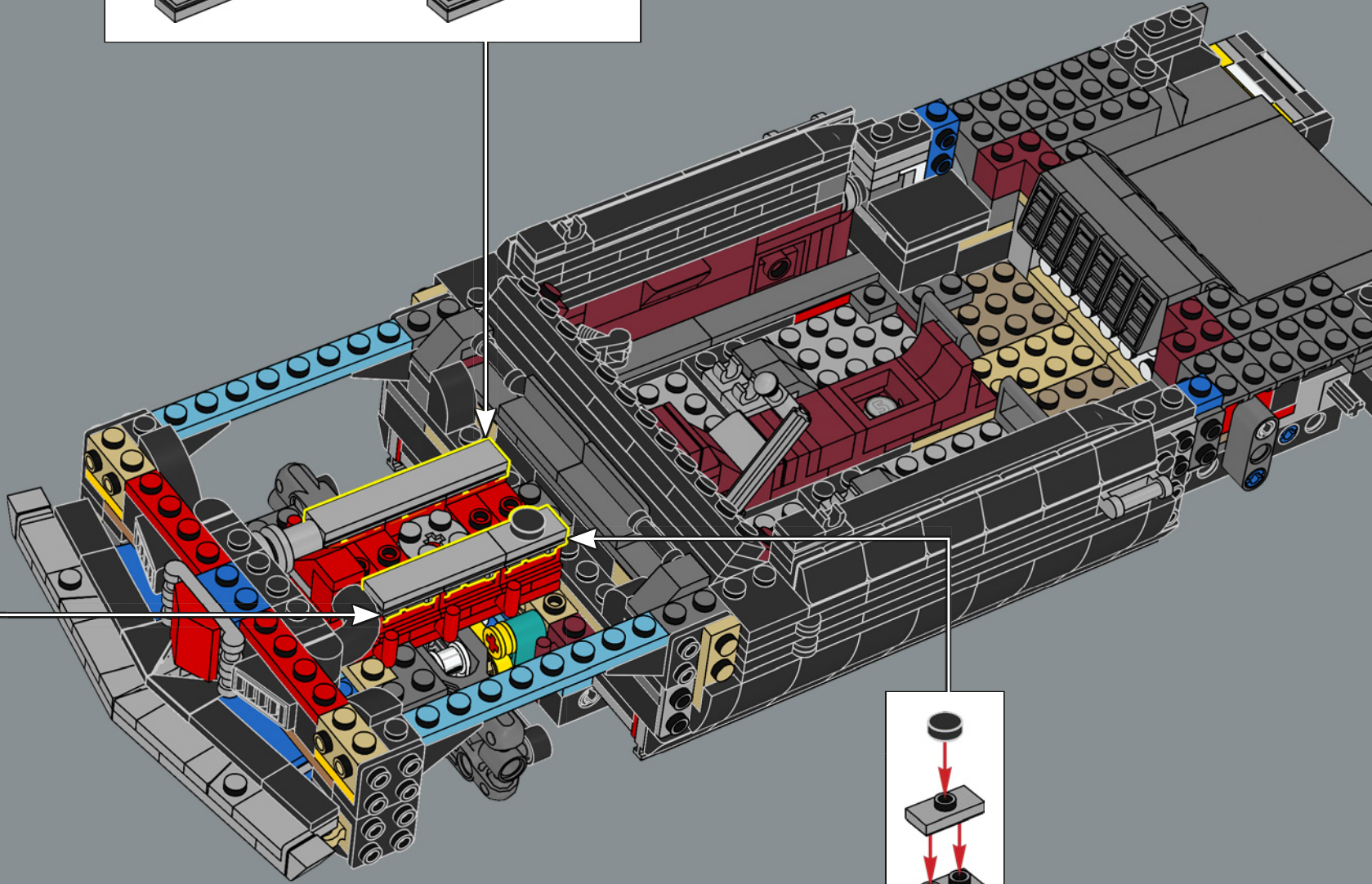
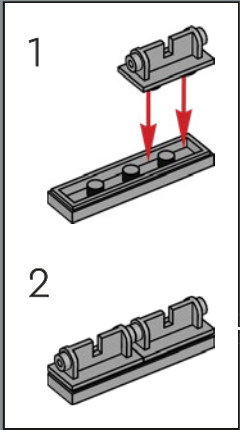
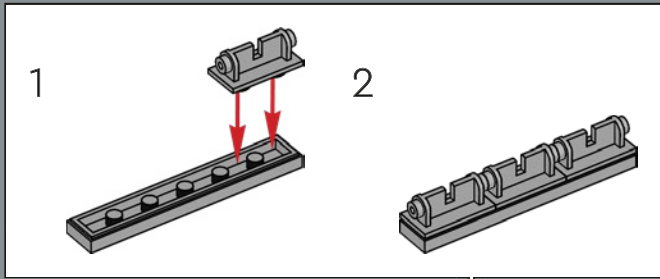

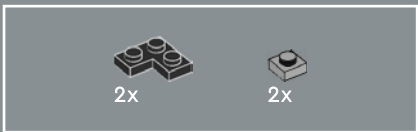

206

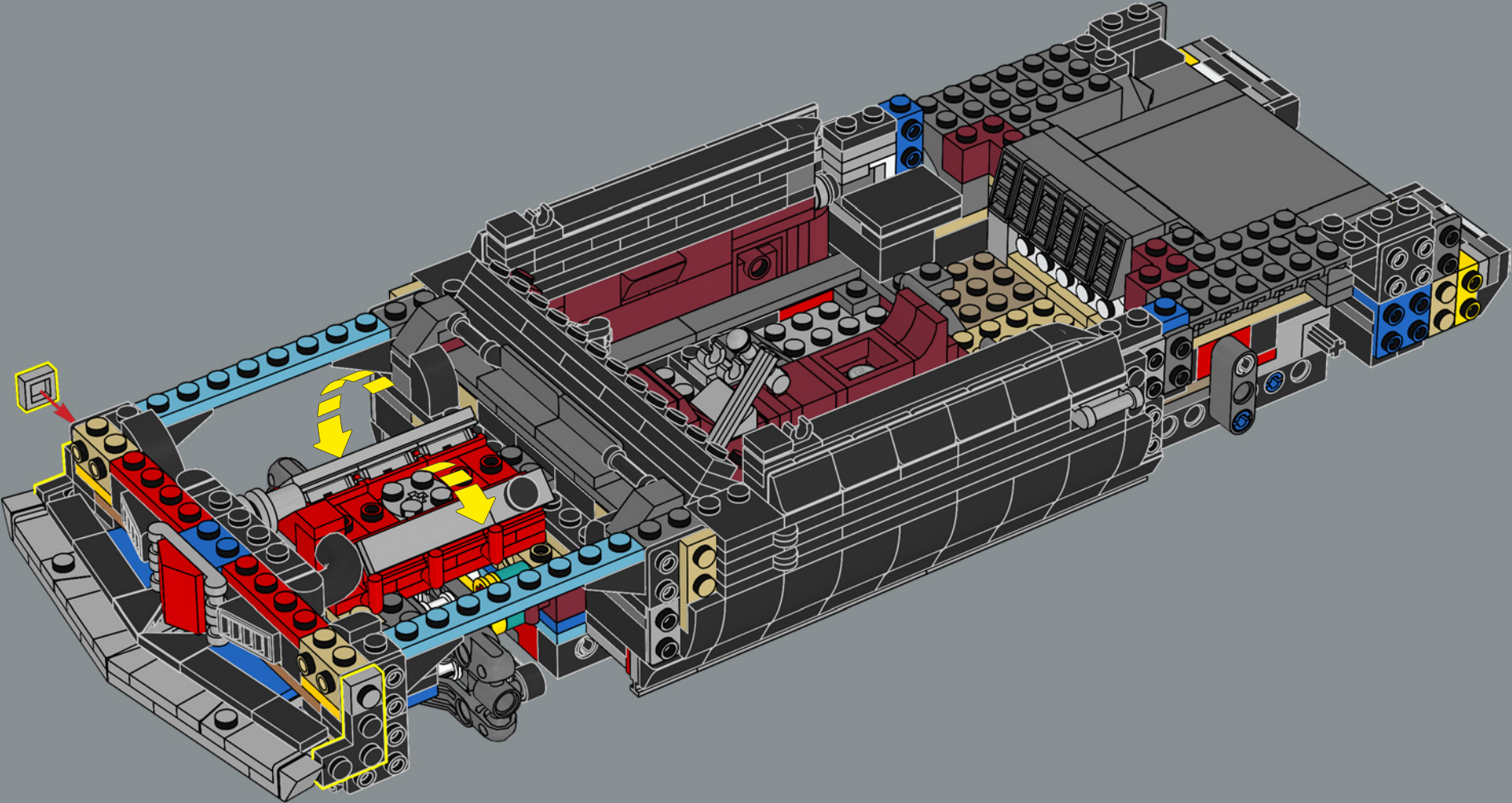



207

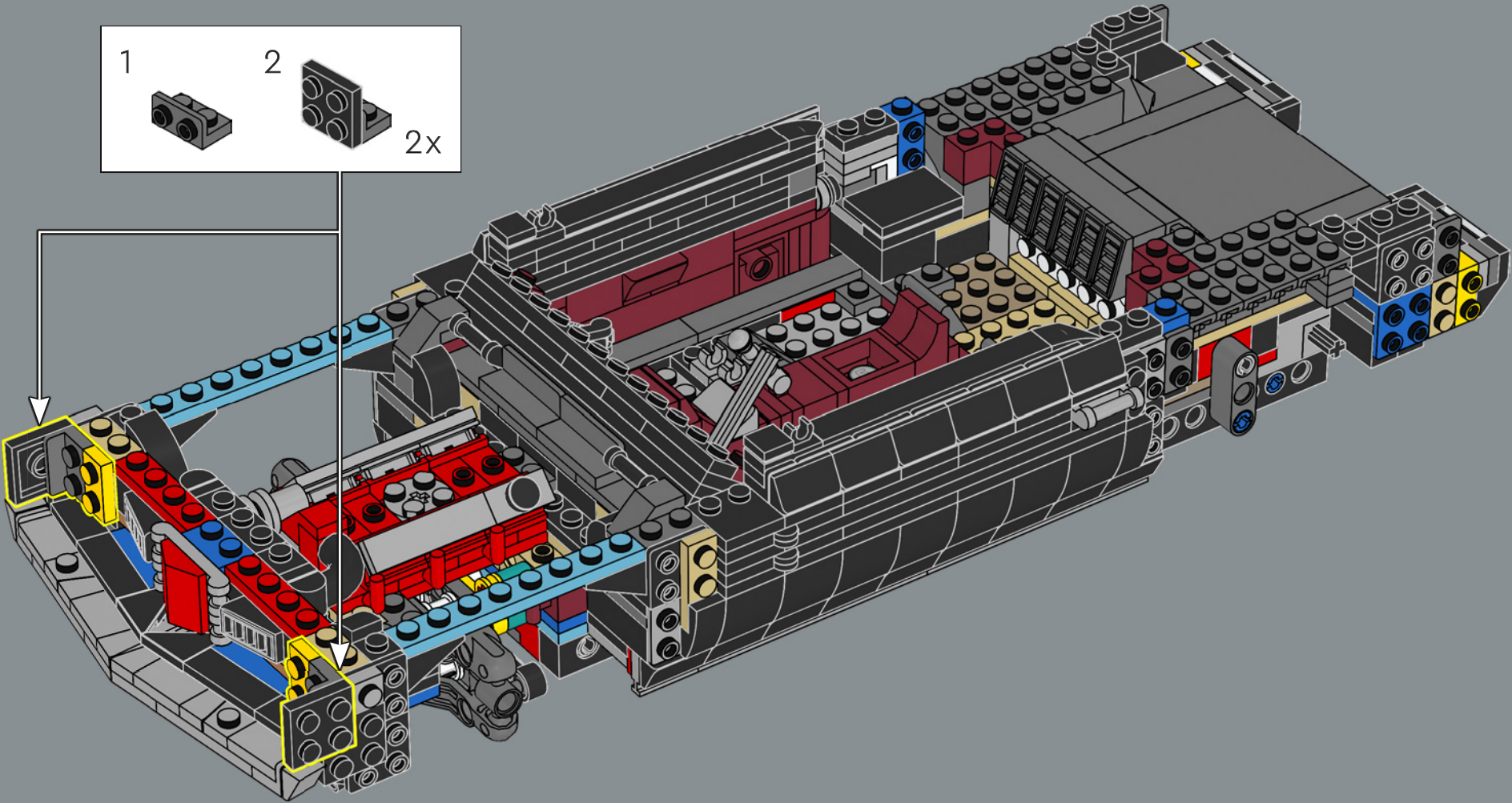
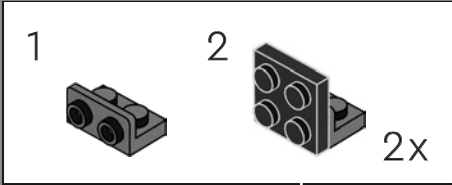

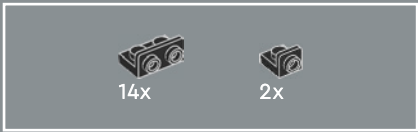

208

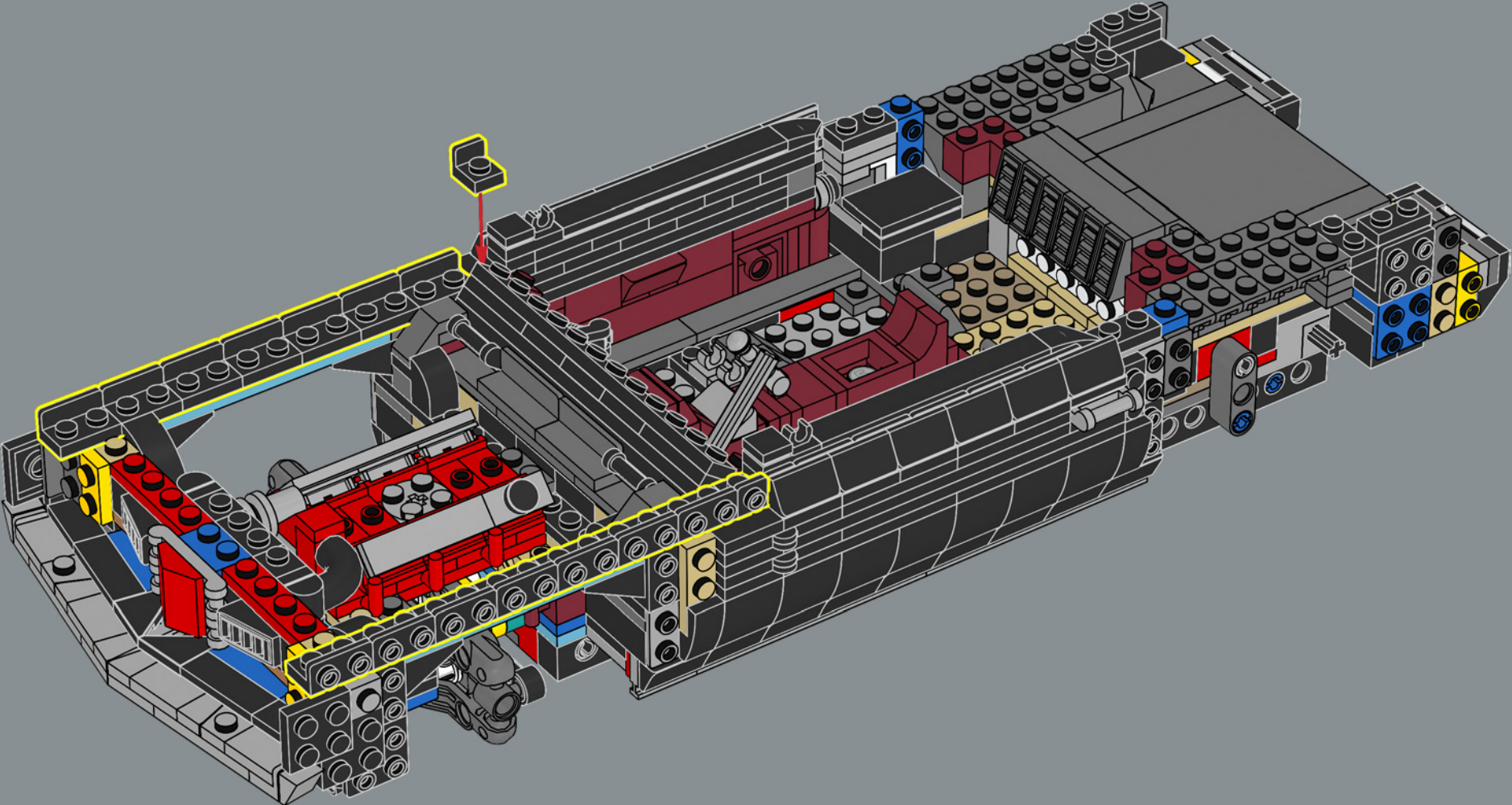

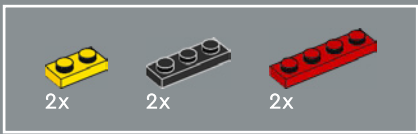

209

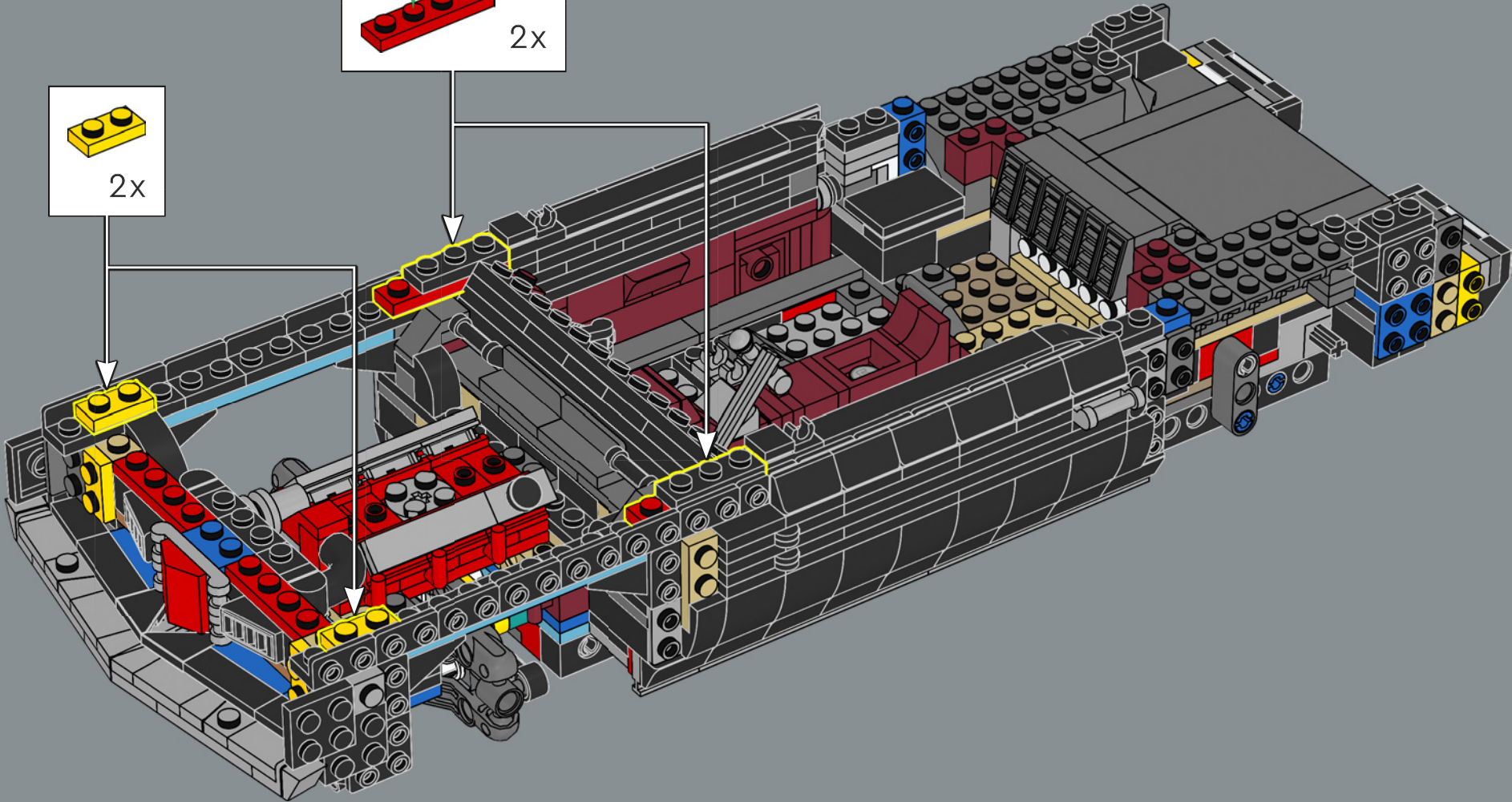
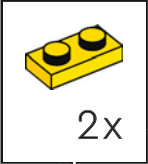
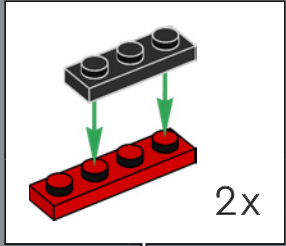



210

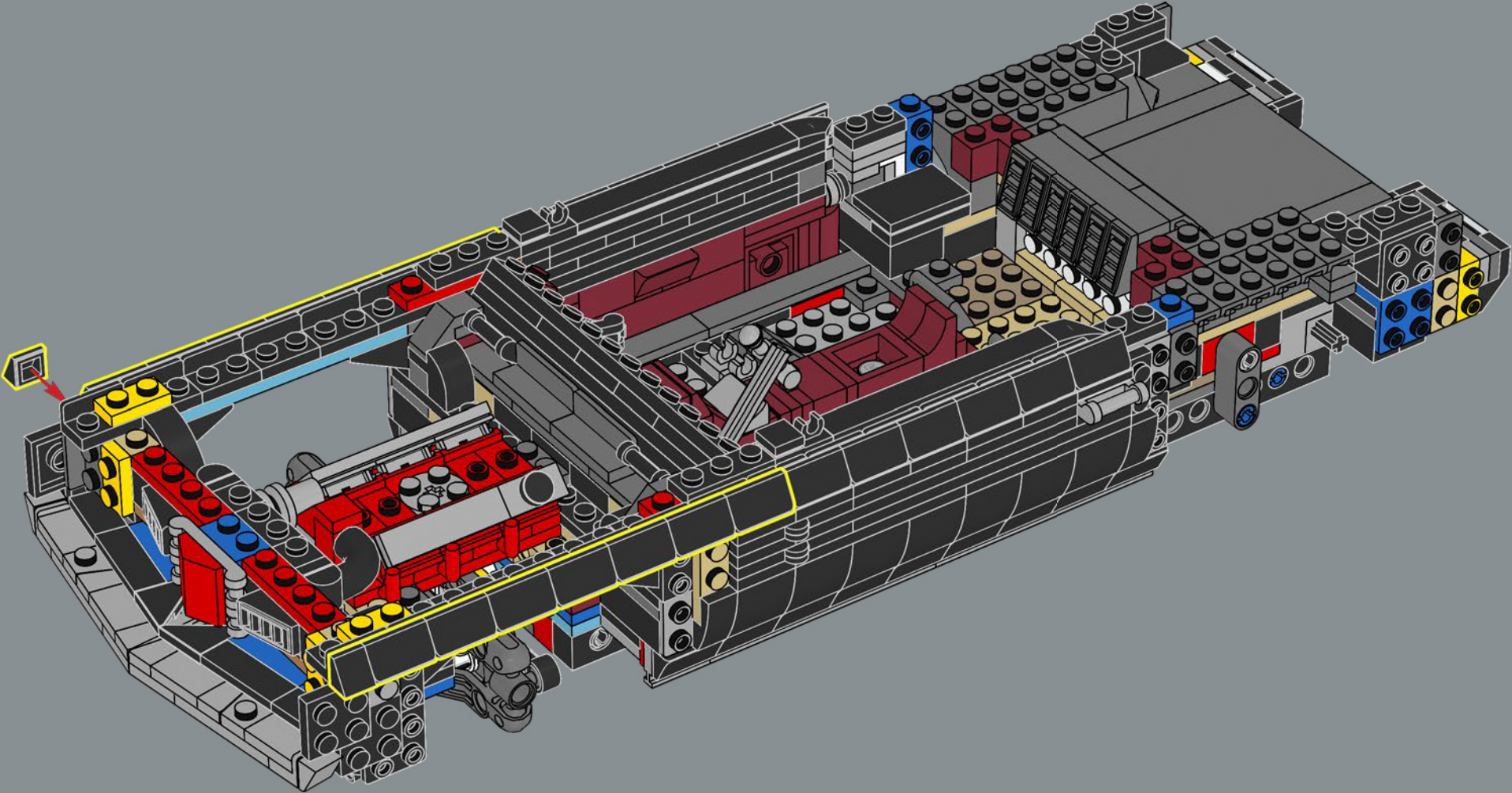

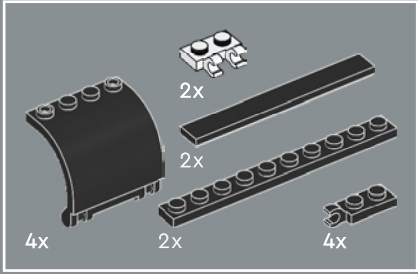
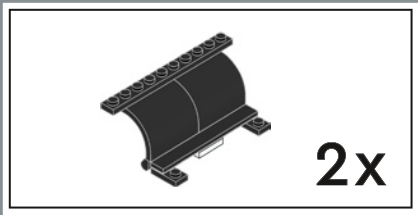

211

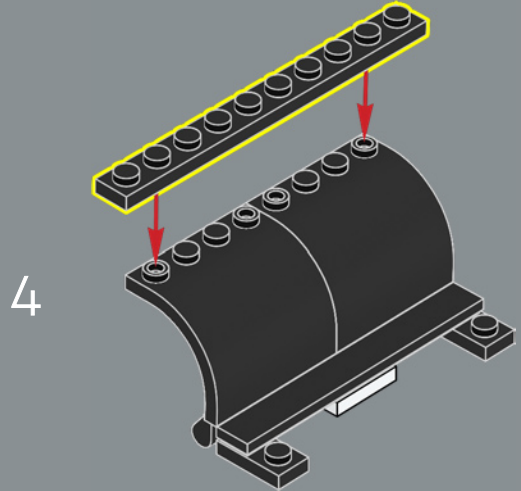
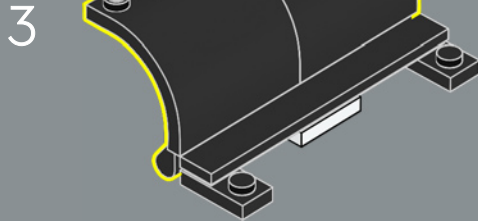
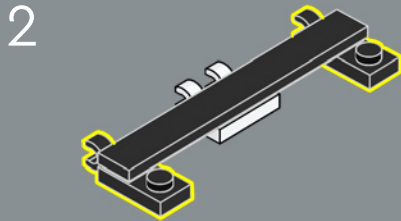
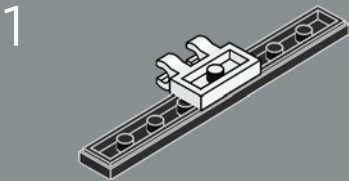

2x

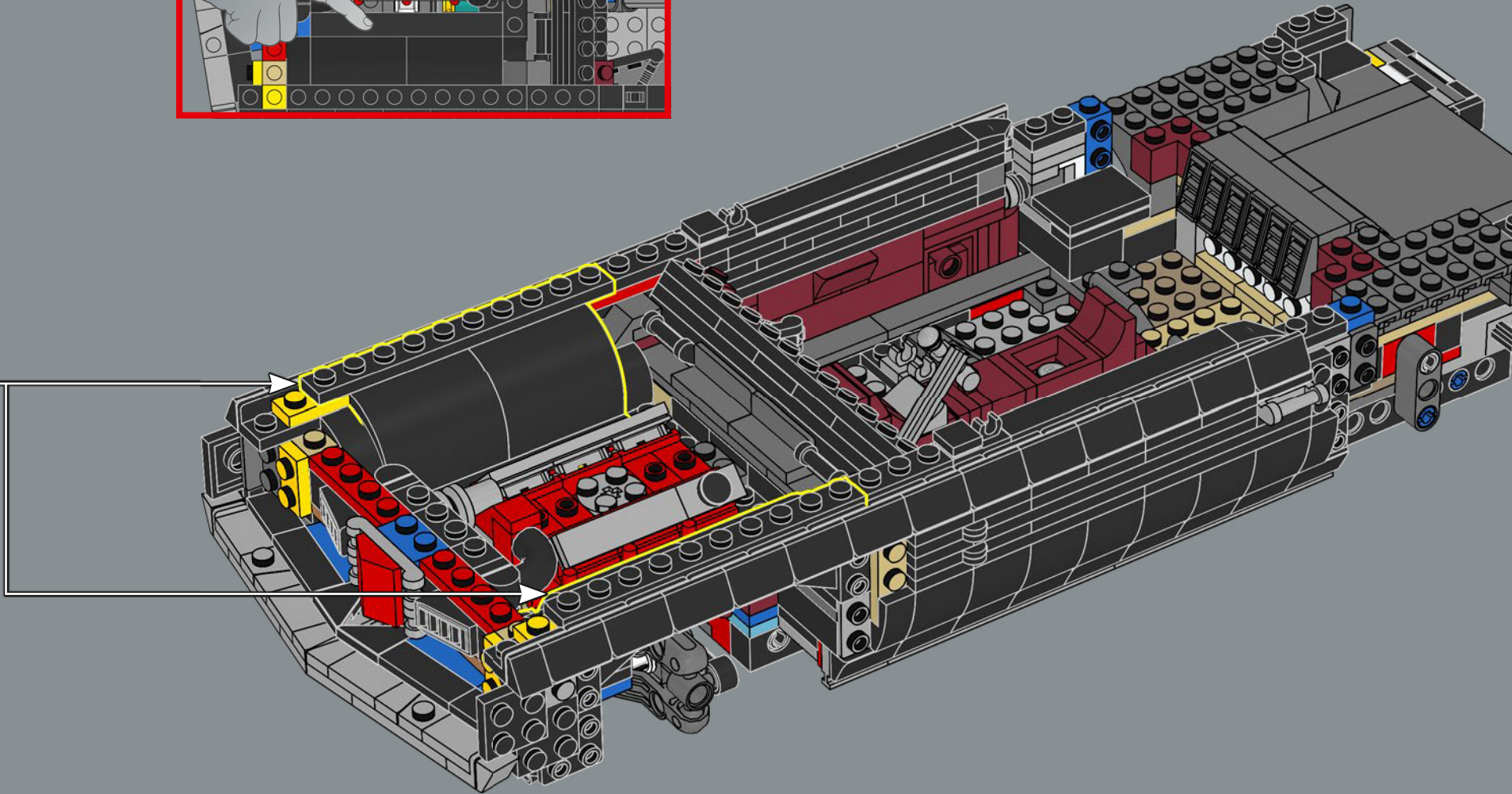
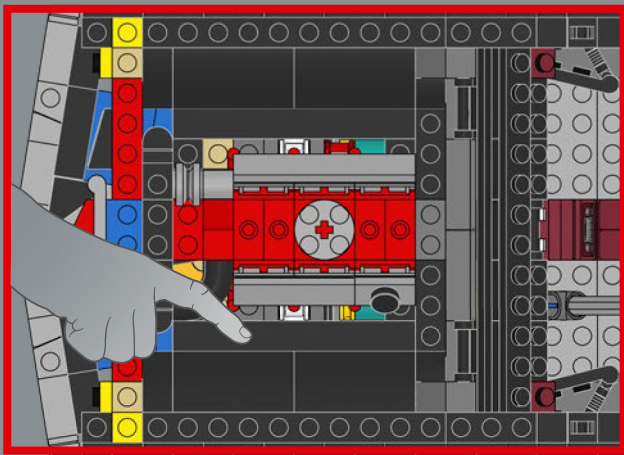

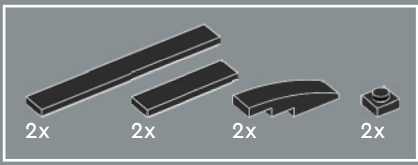

212

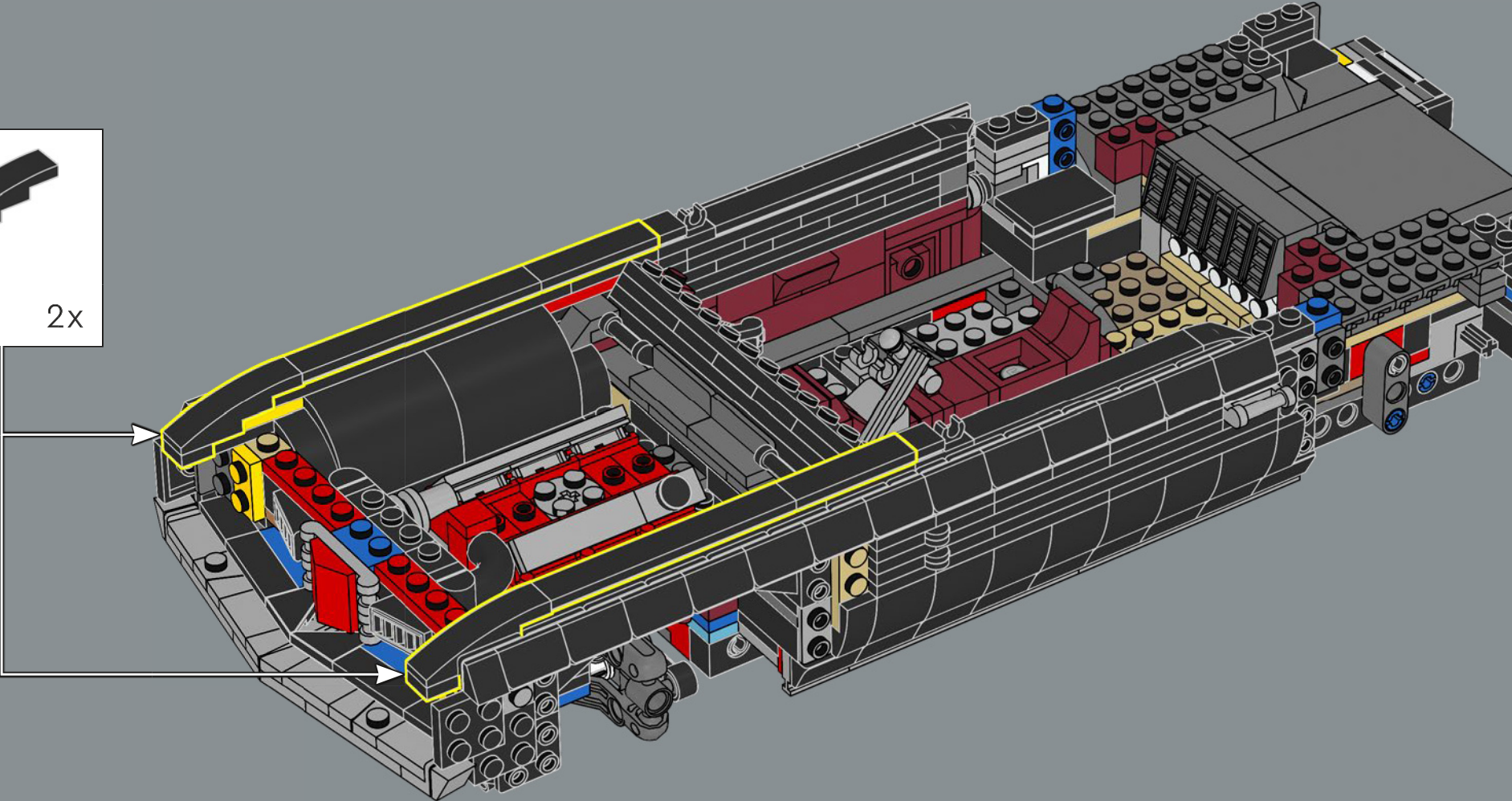
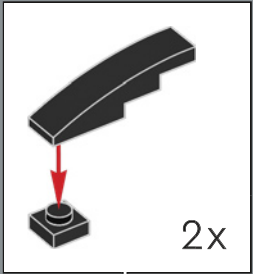

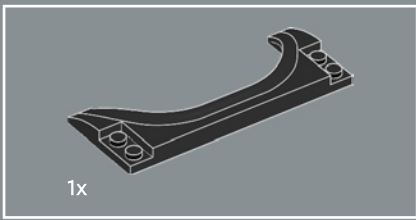

213

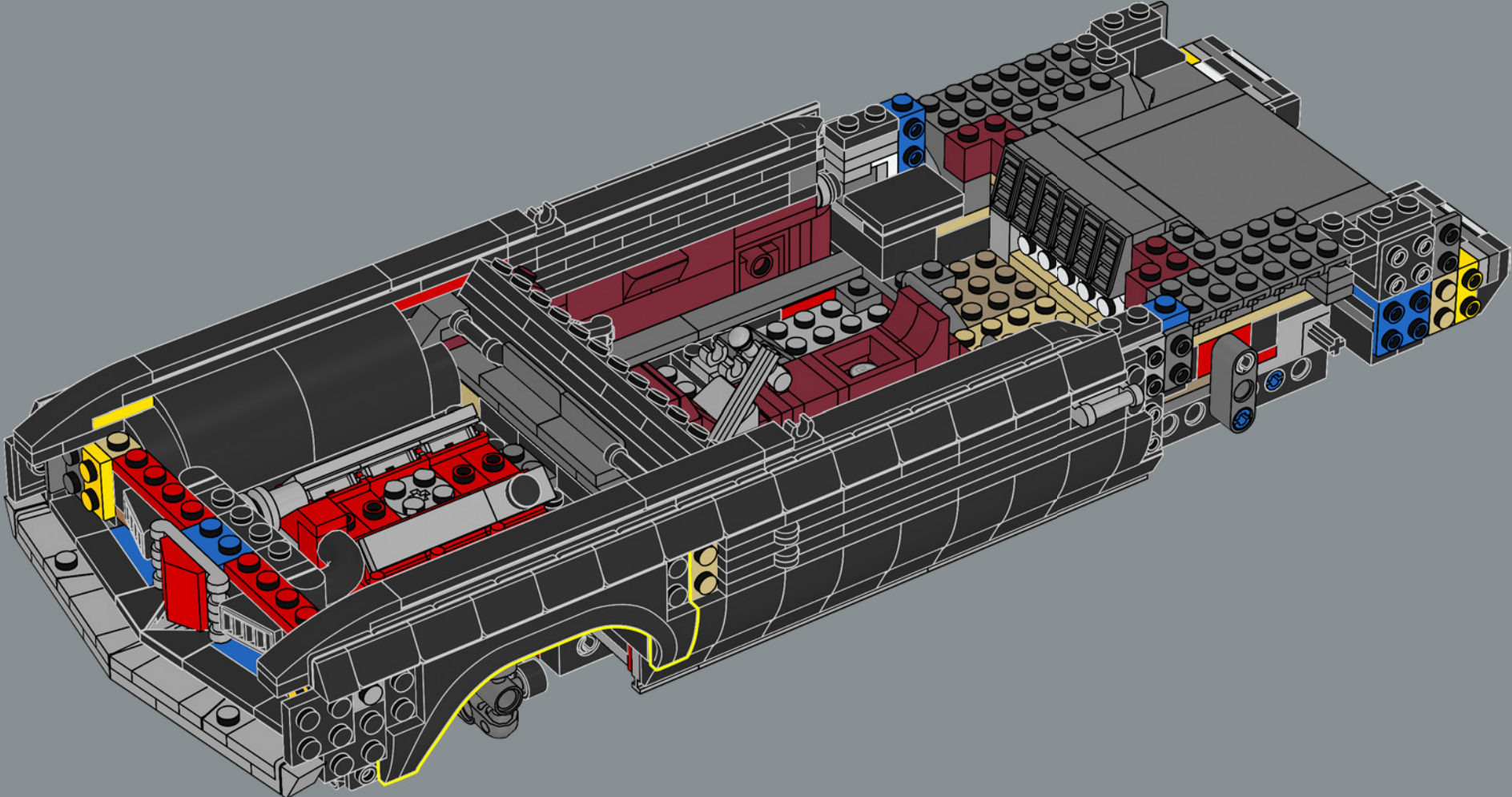

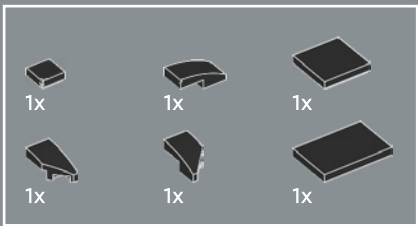

214

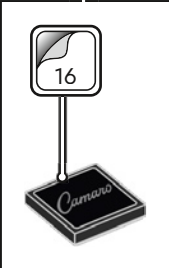
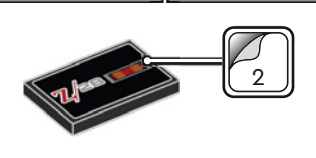
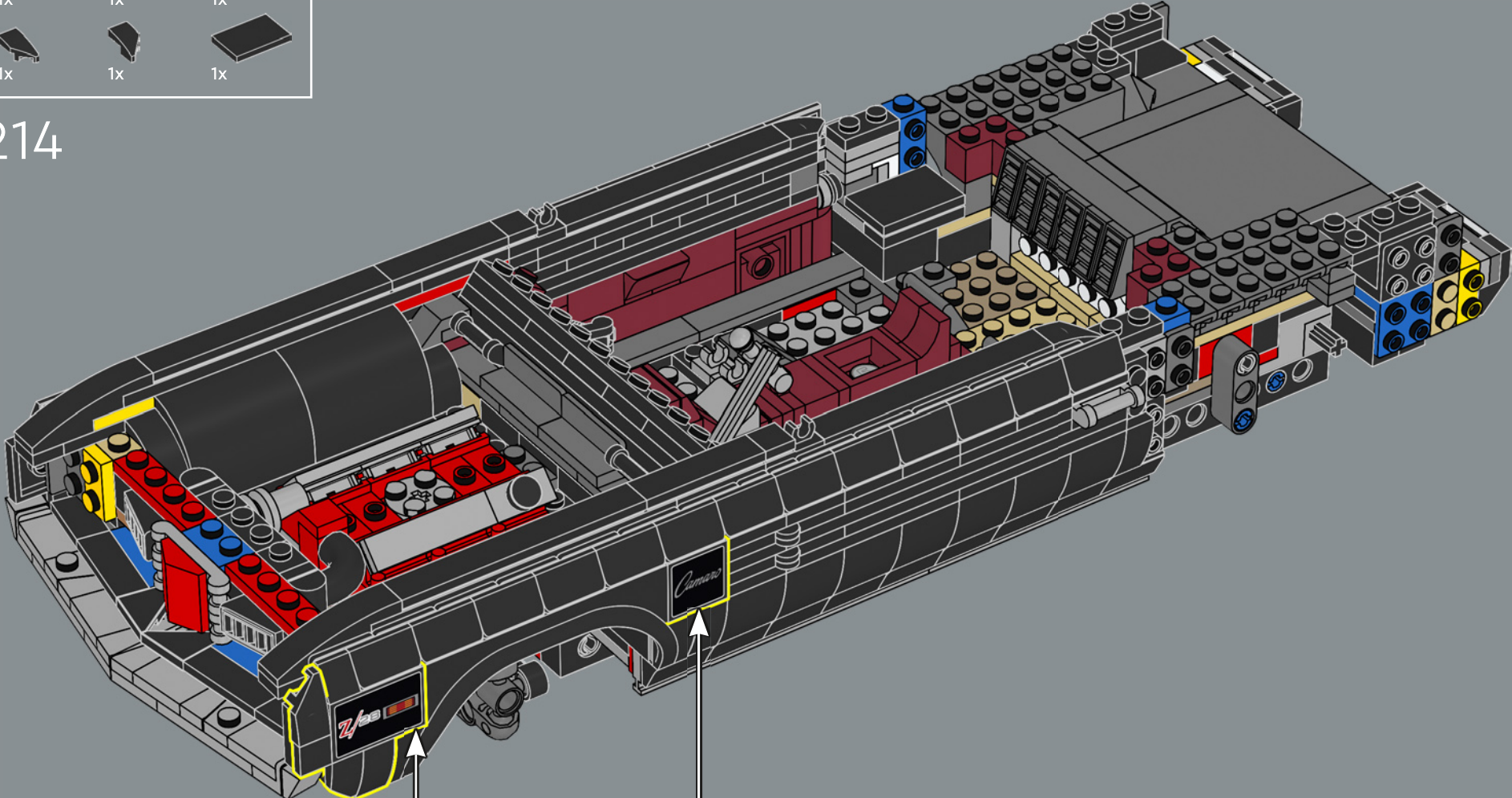

Chevrolet originally also considered producing an estate version of the Camaro.

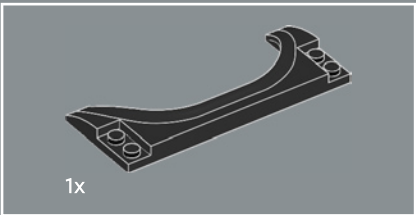

215

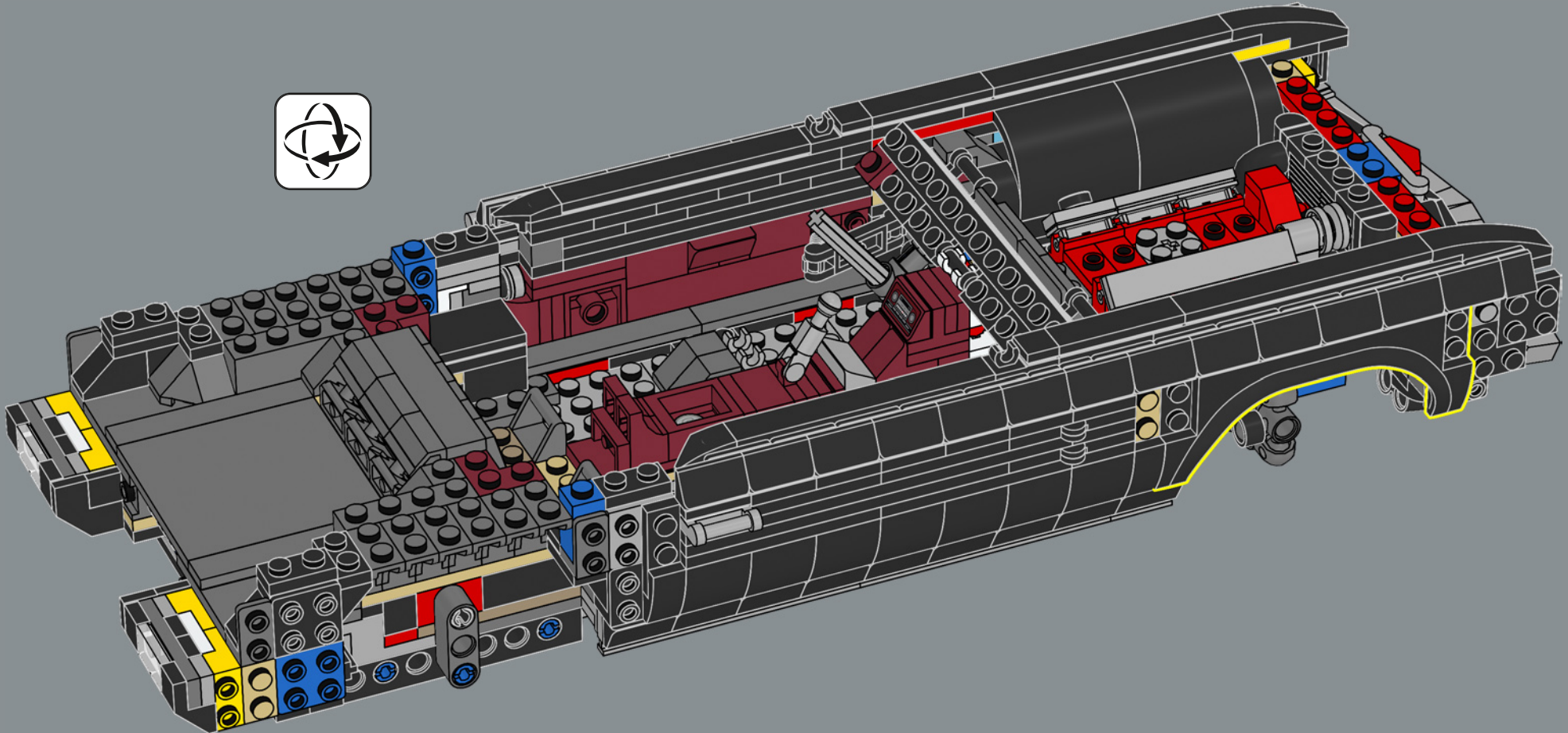

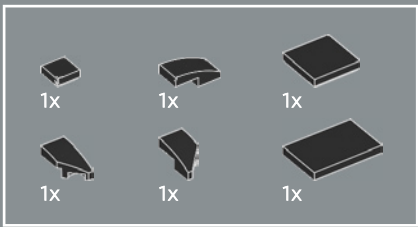

216

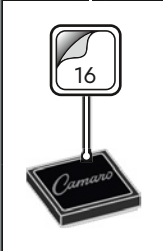
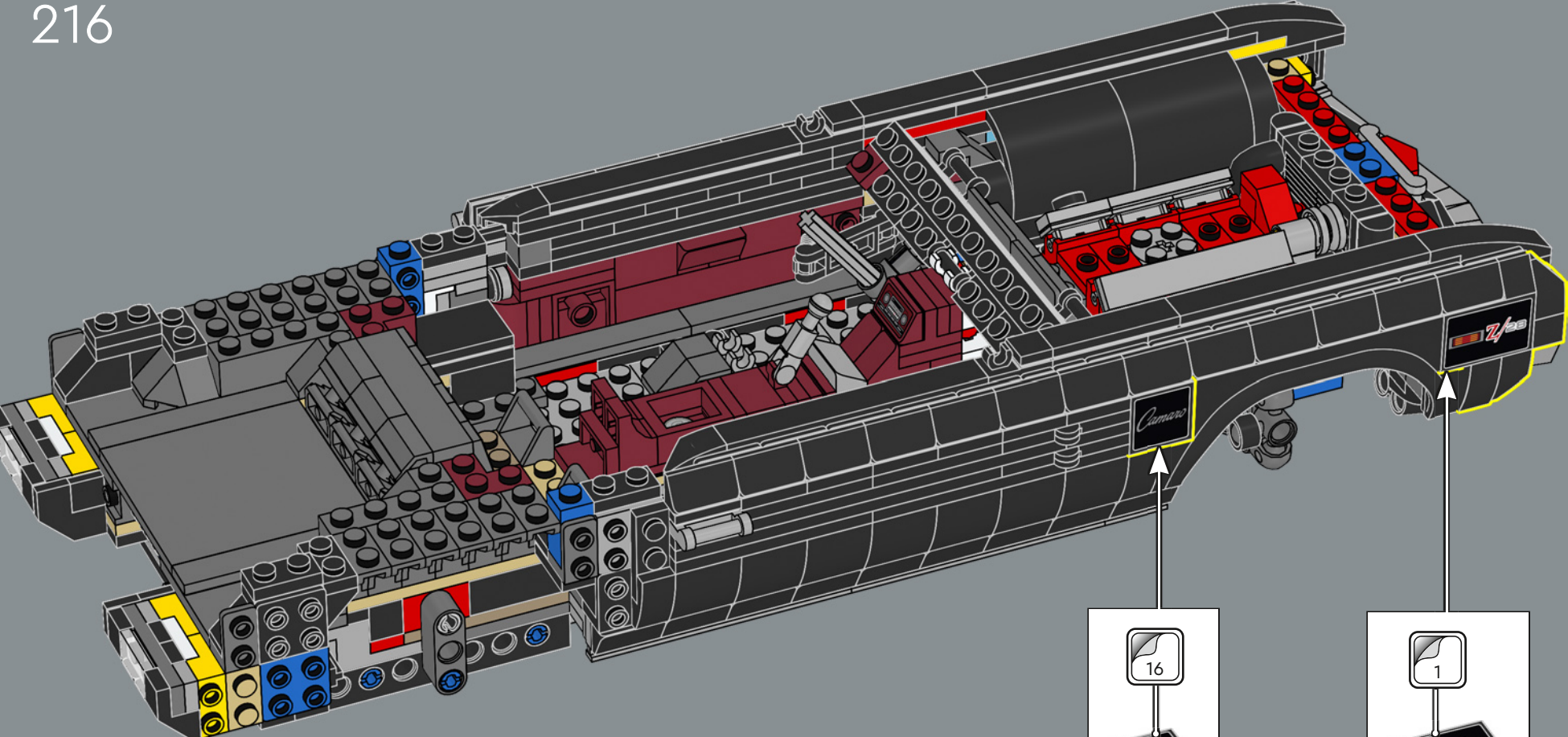

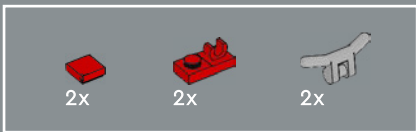

217

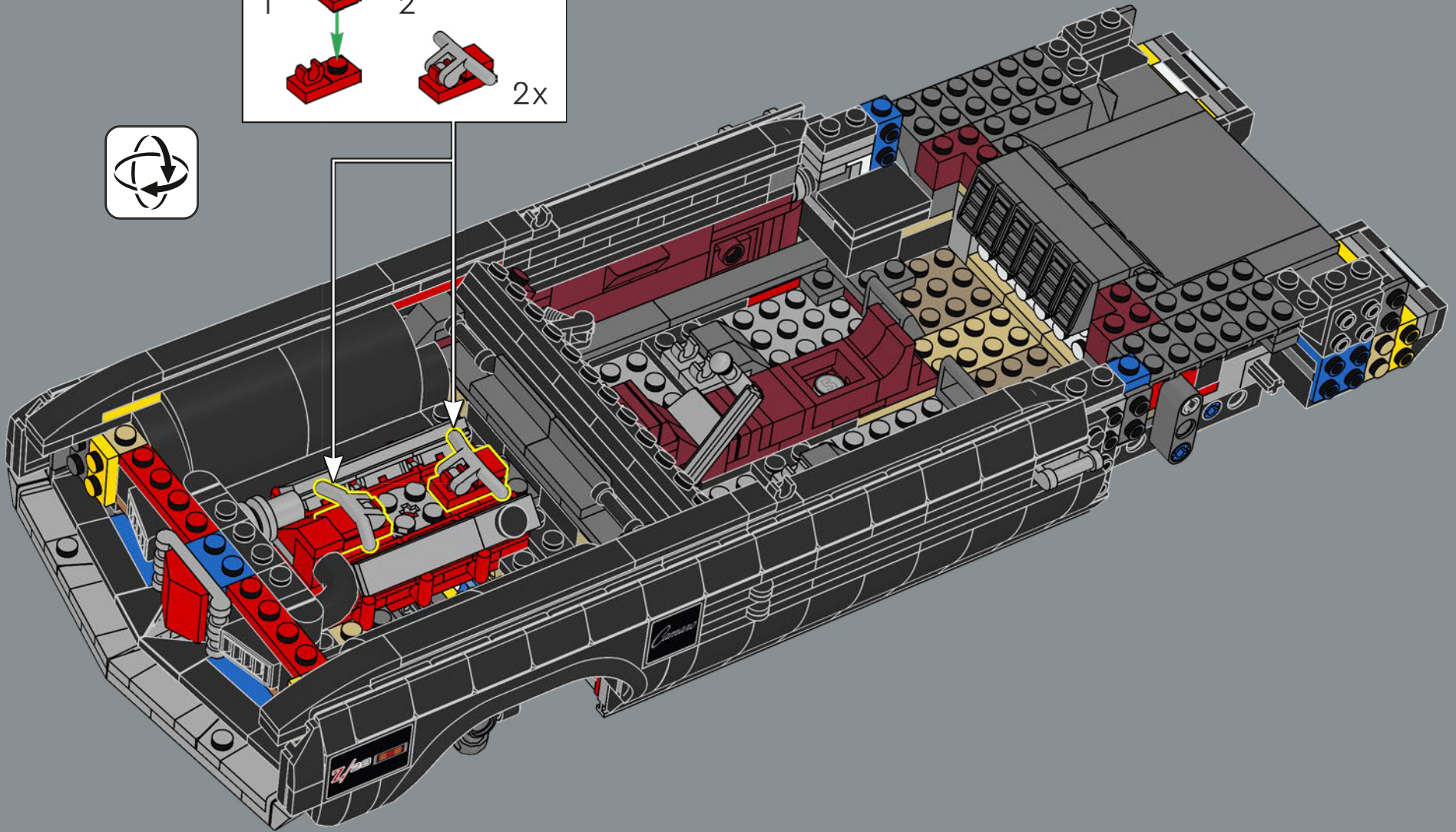
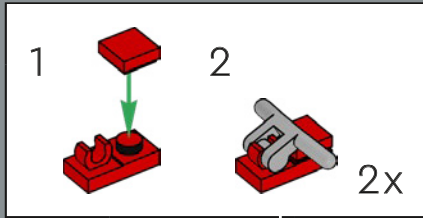

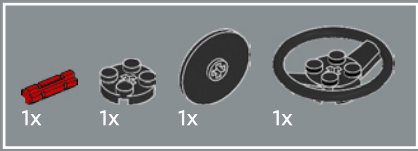

218

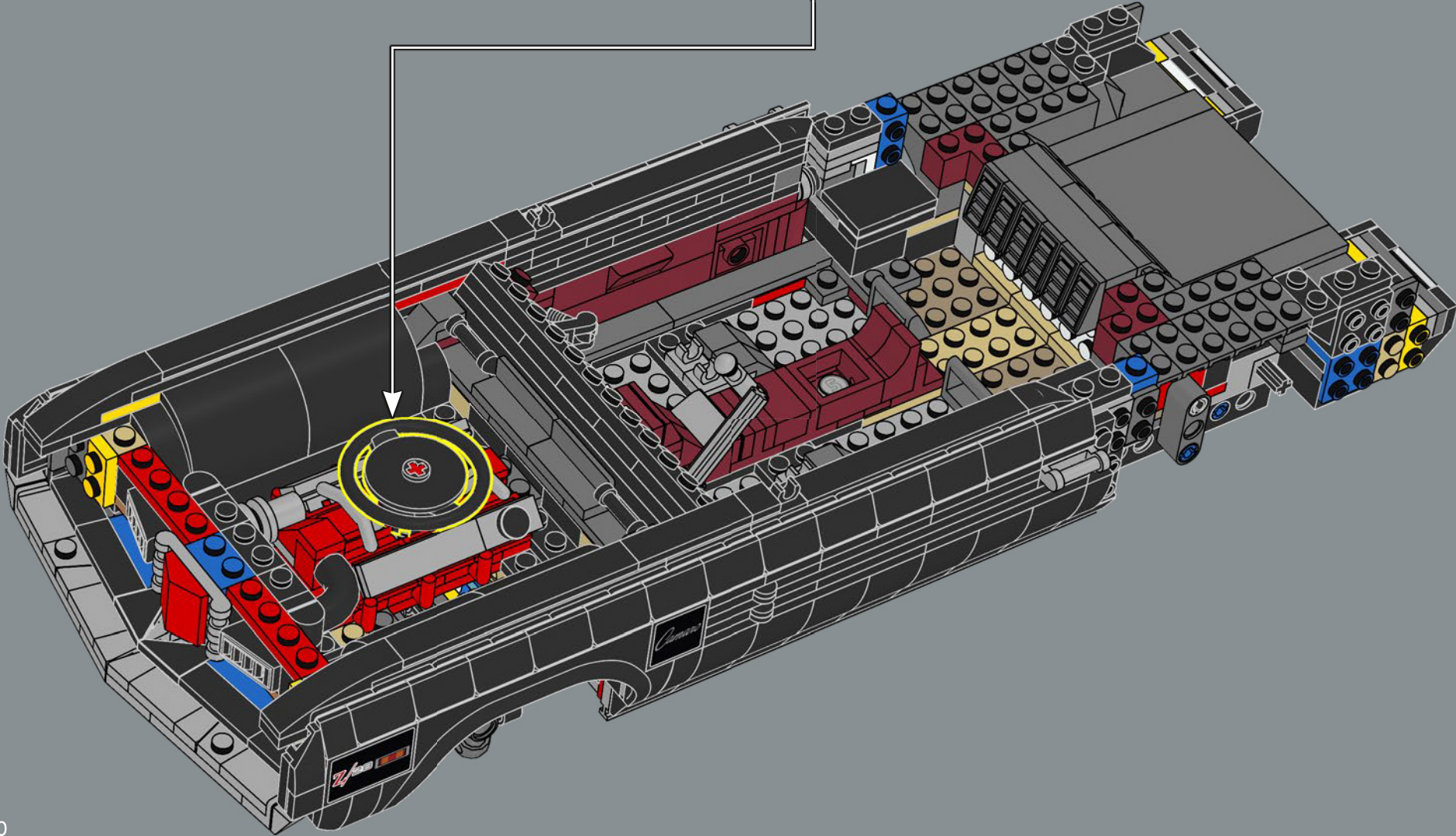
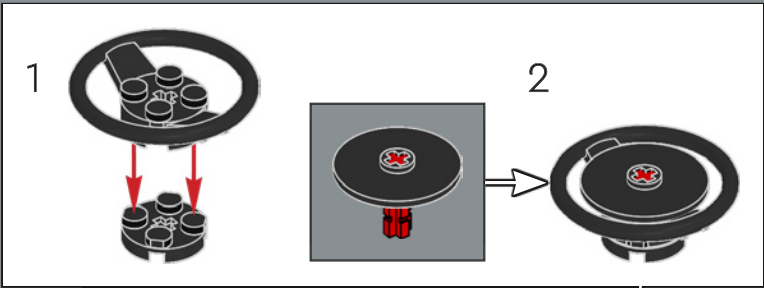

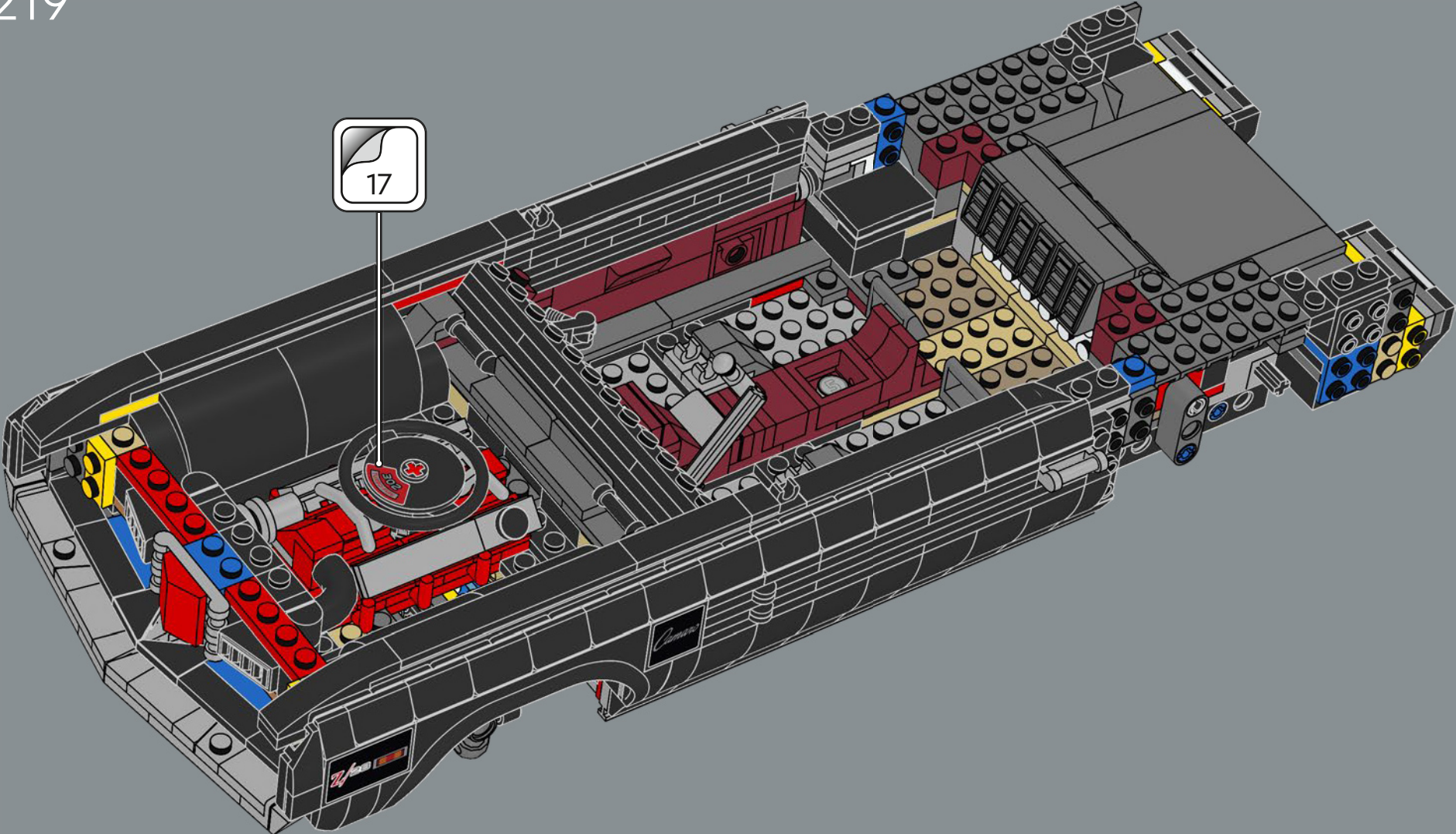

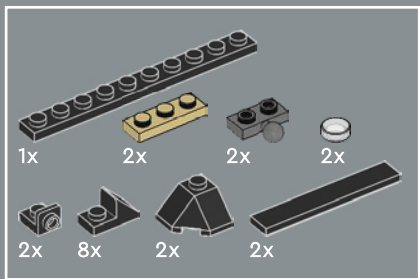

220

1

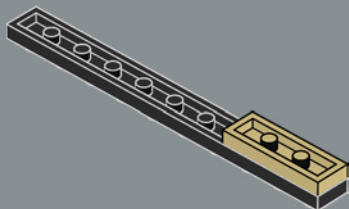

2

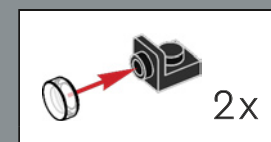
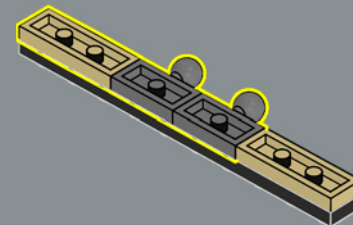

3

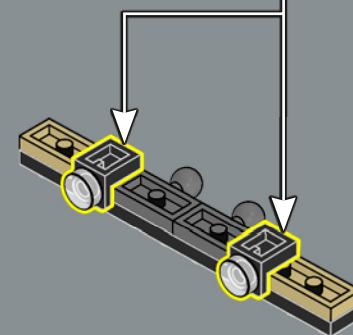

4

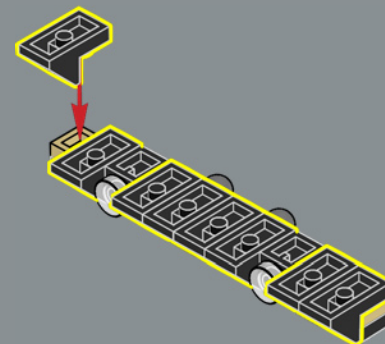

5

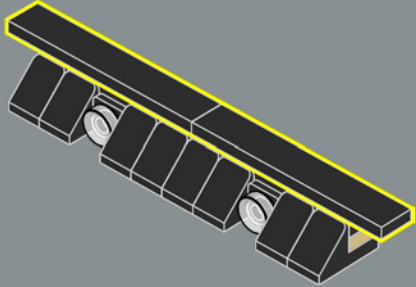

6

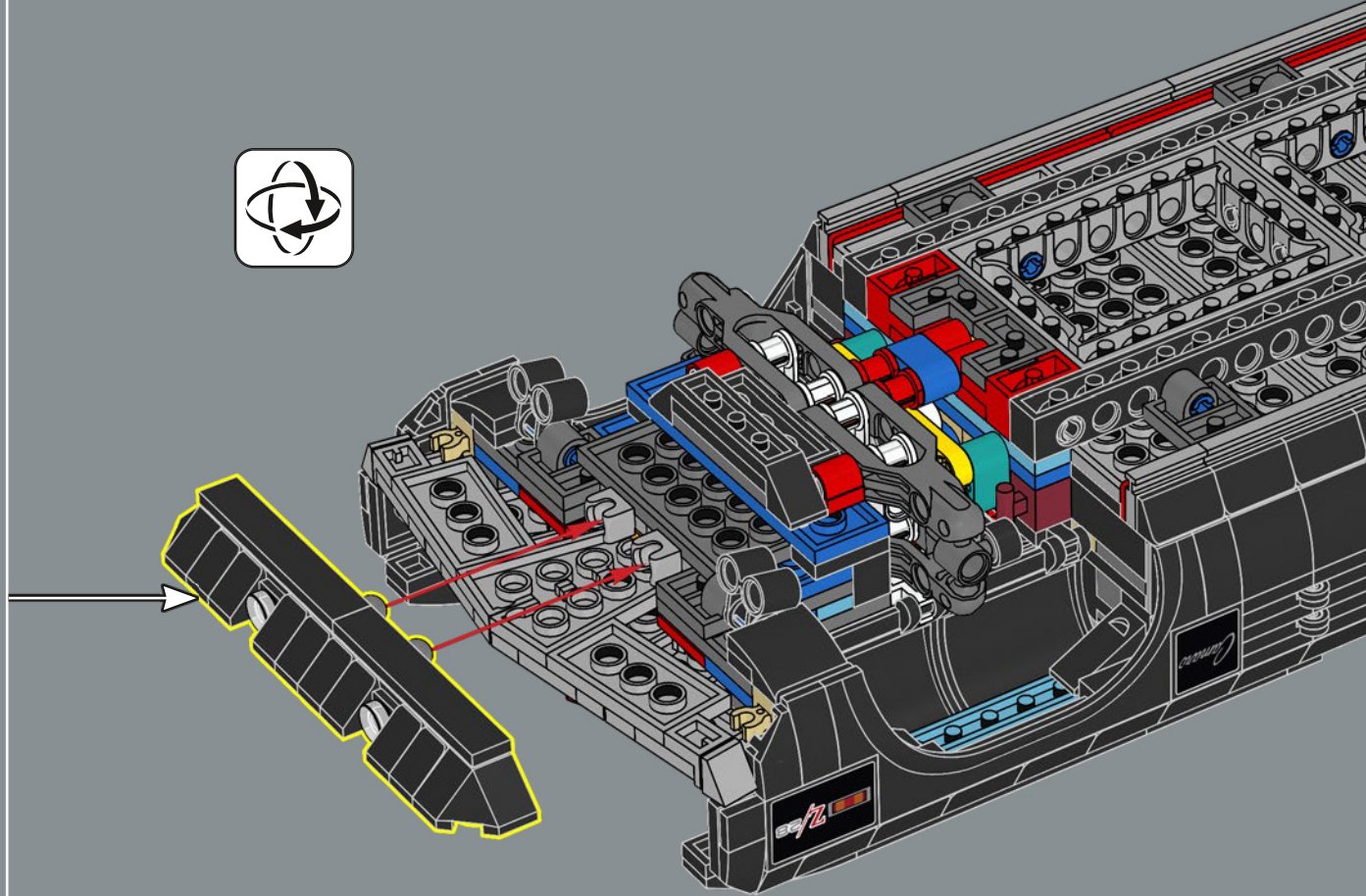
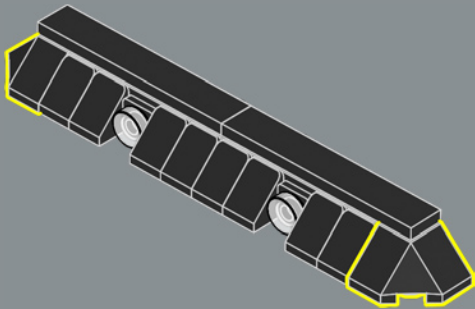

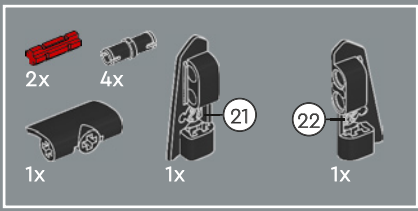

221

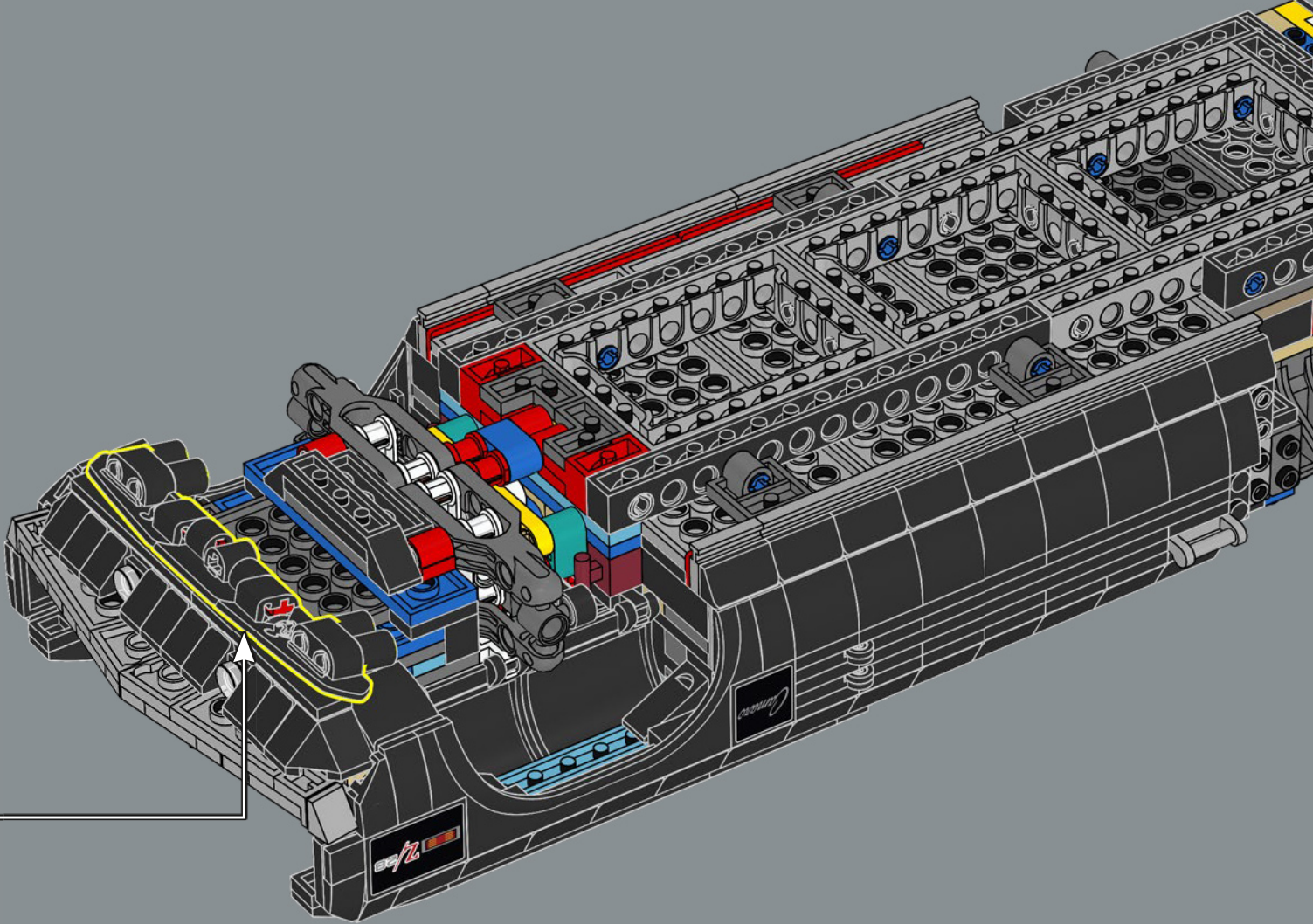
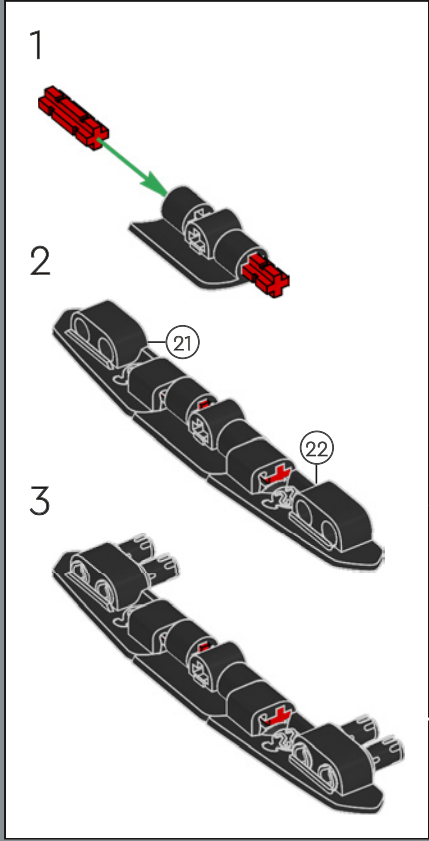



222

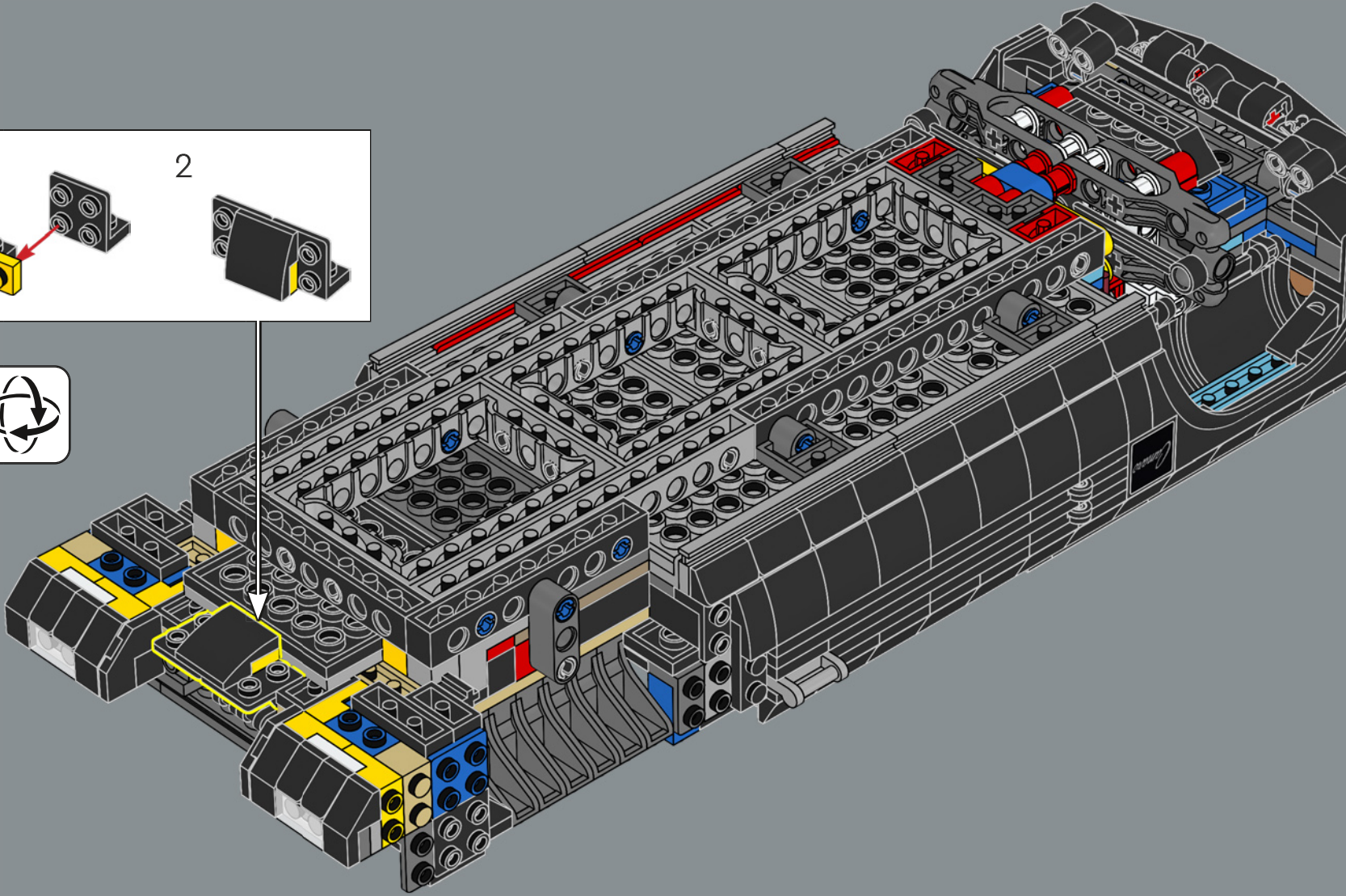
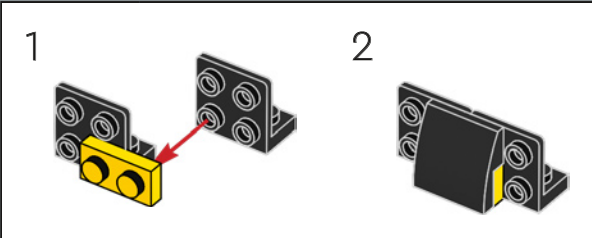

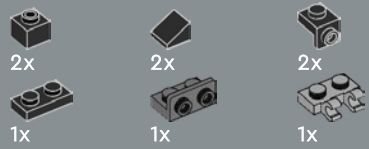

223

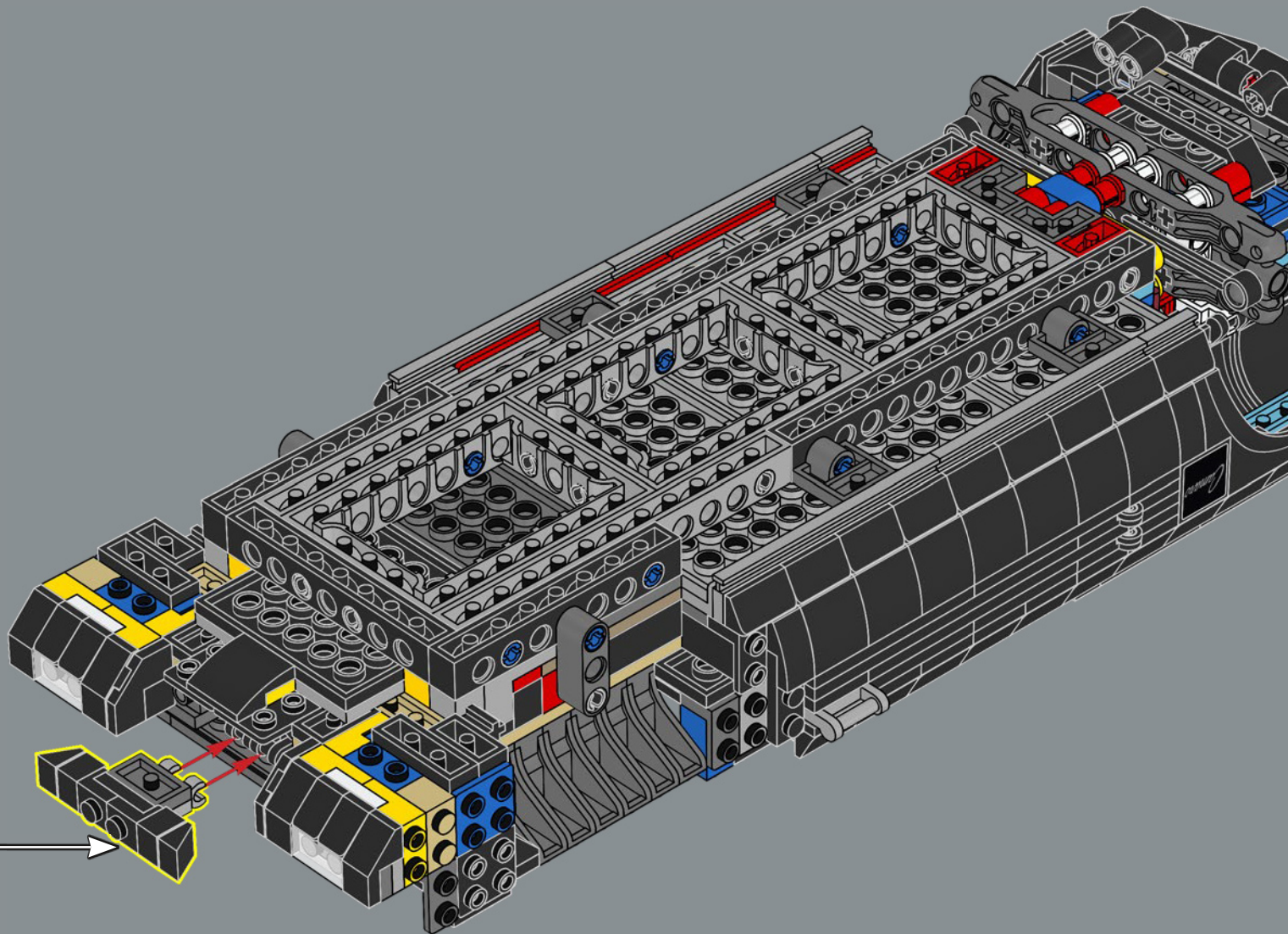
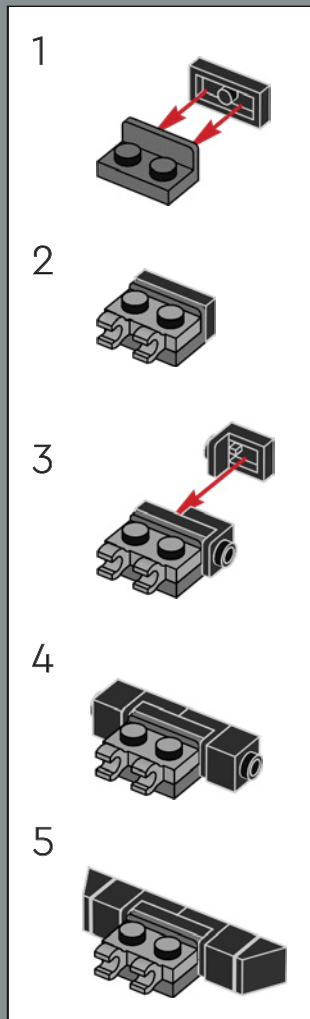

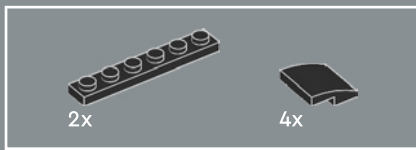

224

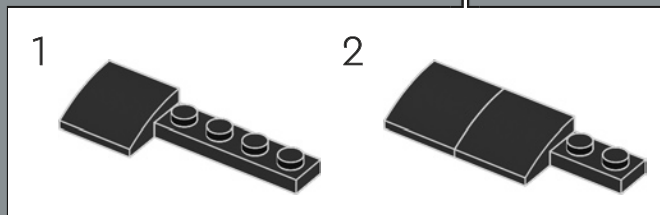
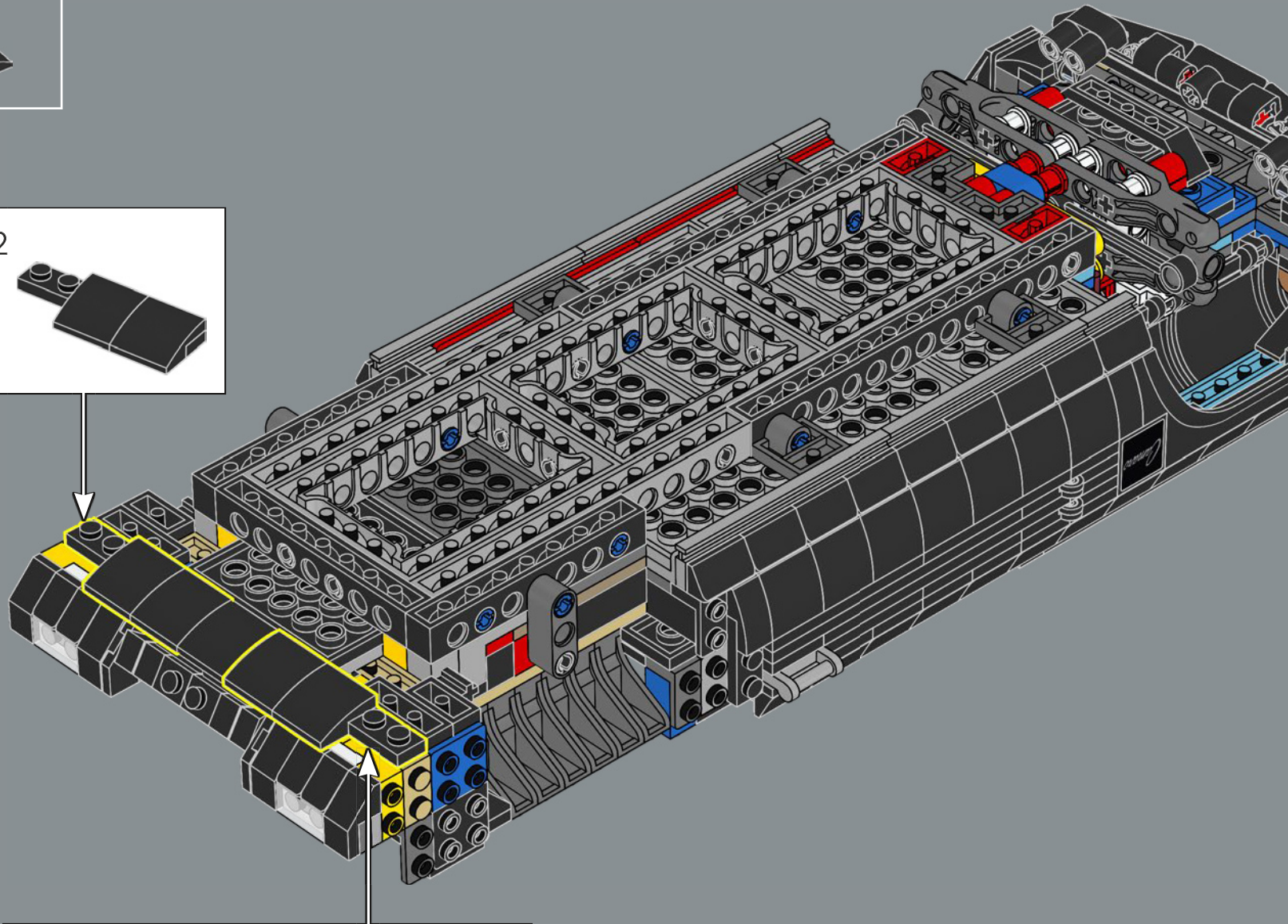
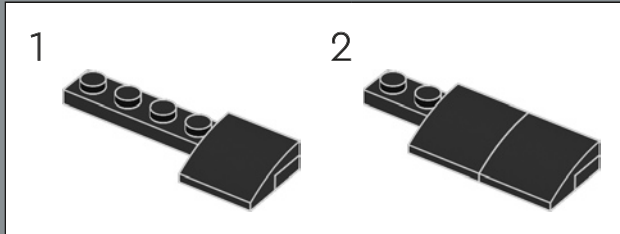



225

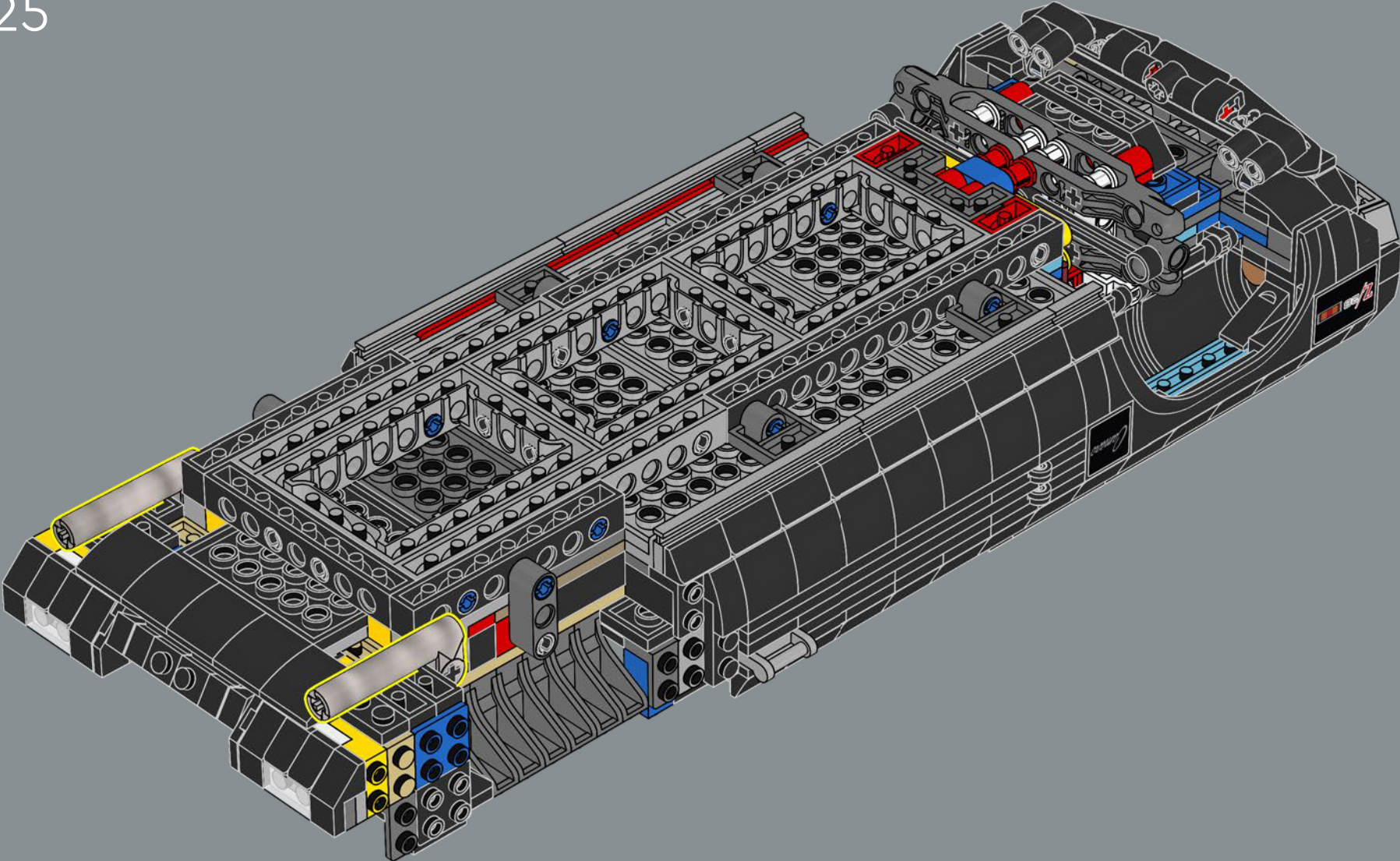

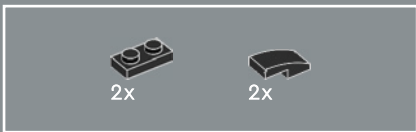

226

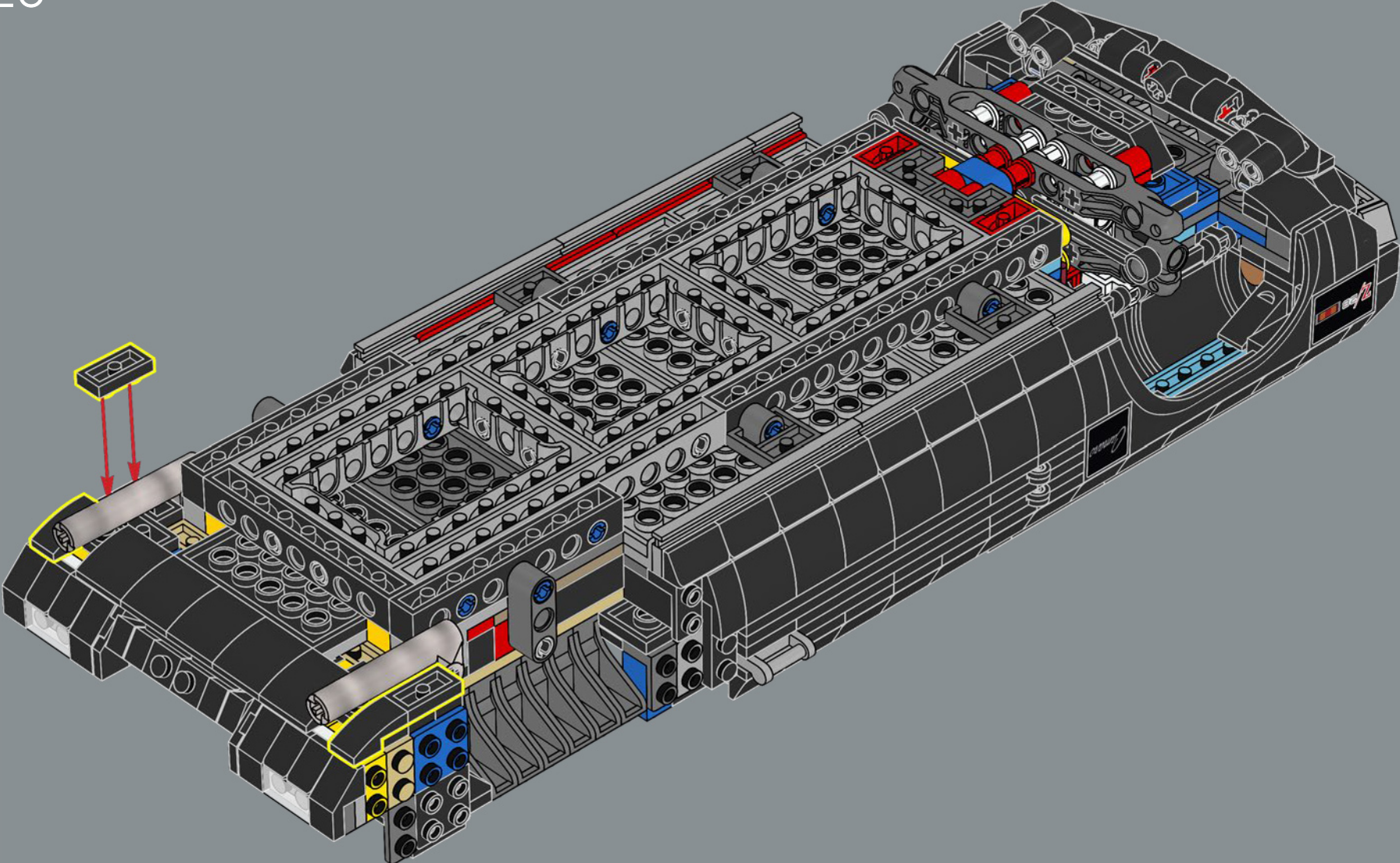

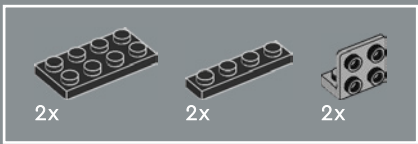

227

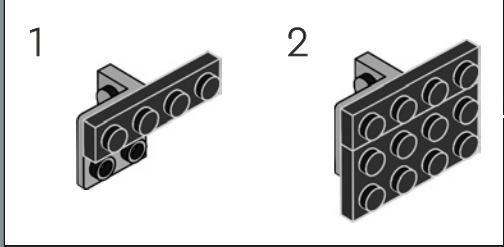
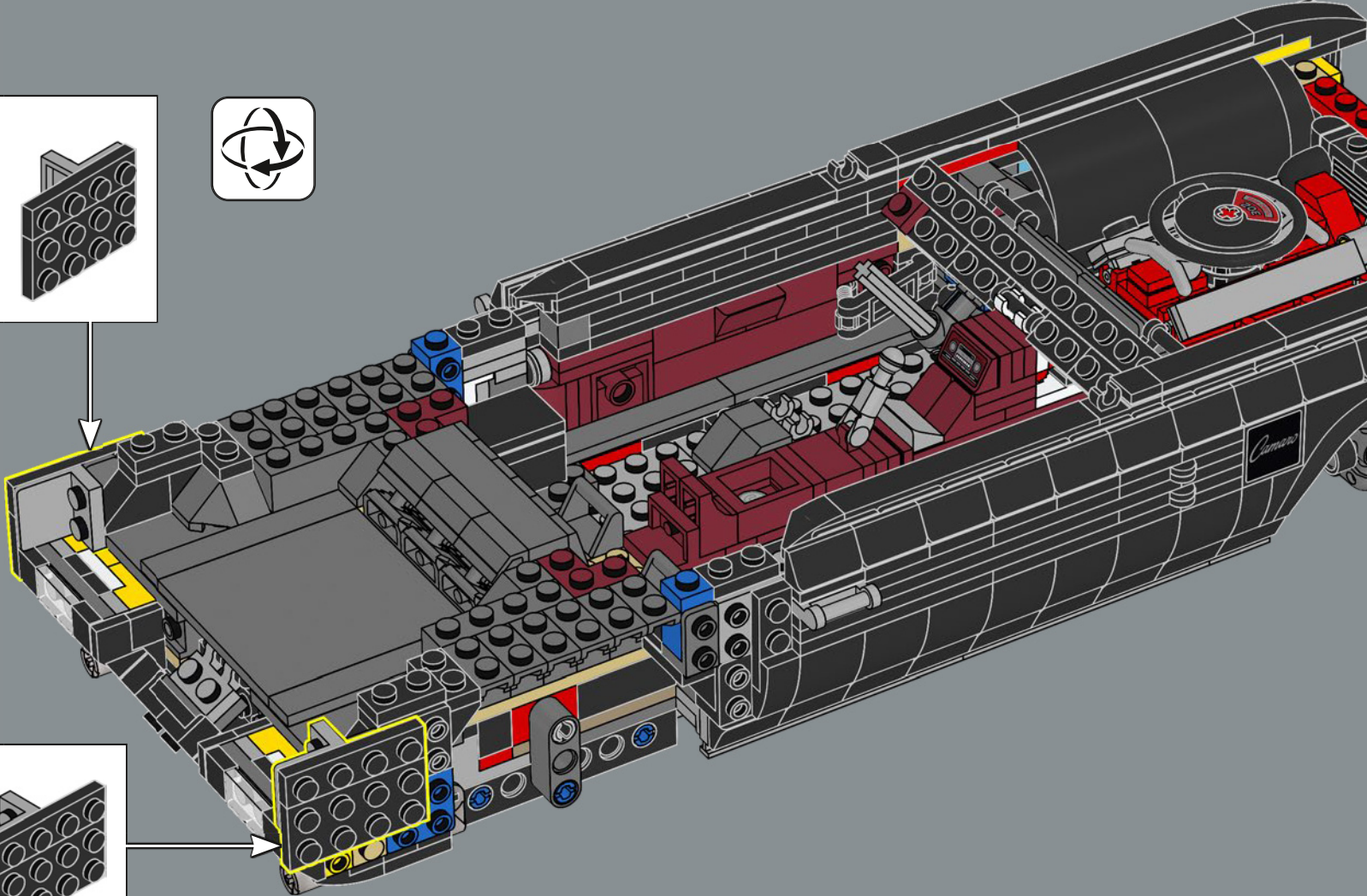
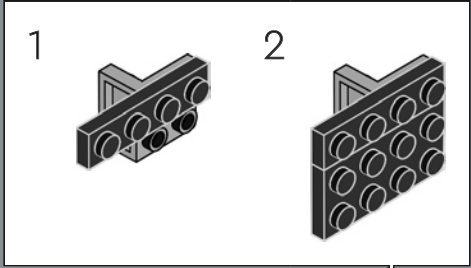

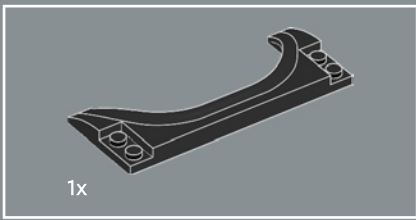

228

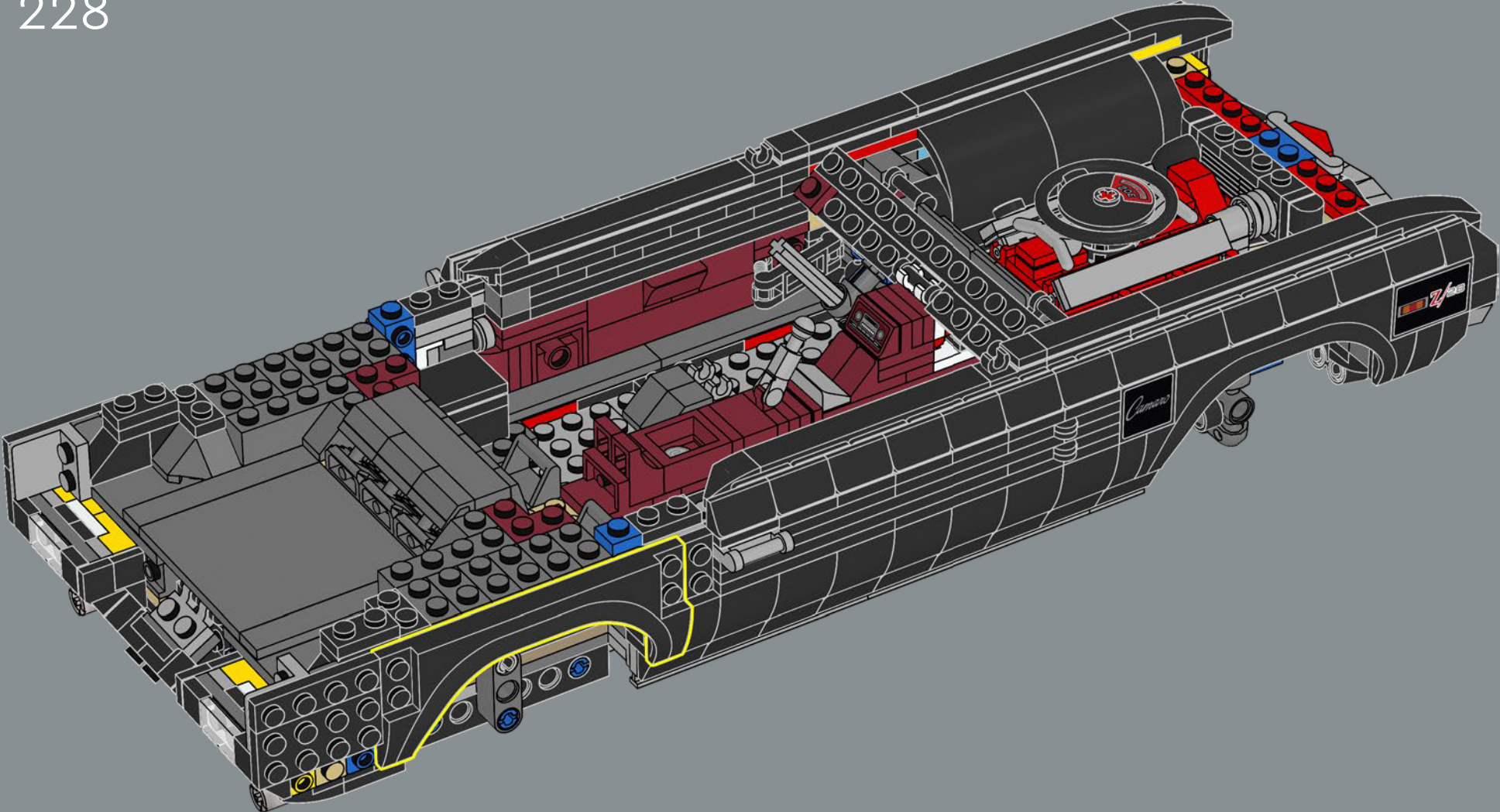

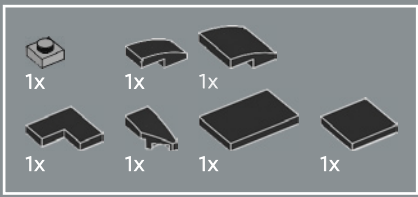

229

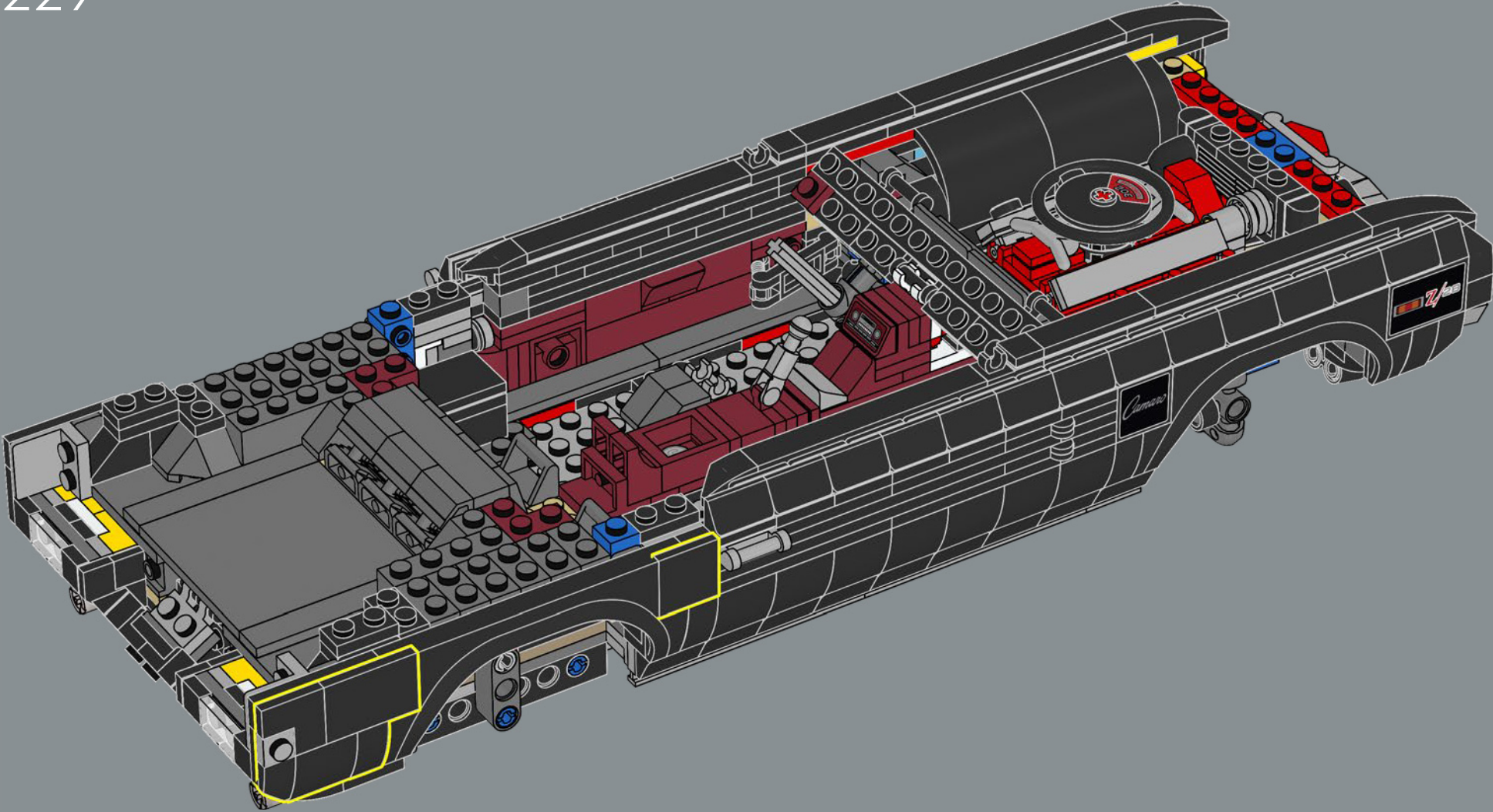

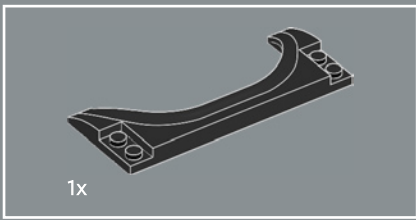

230

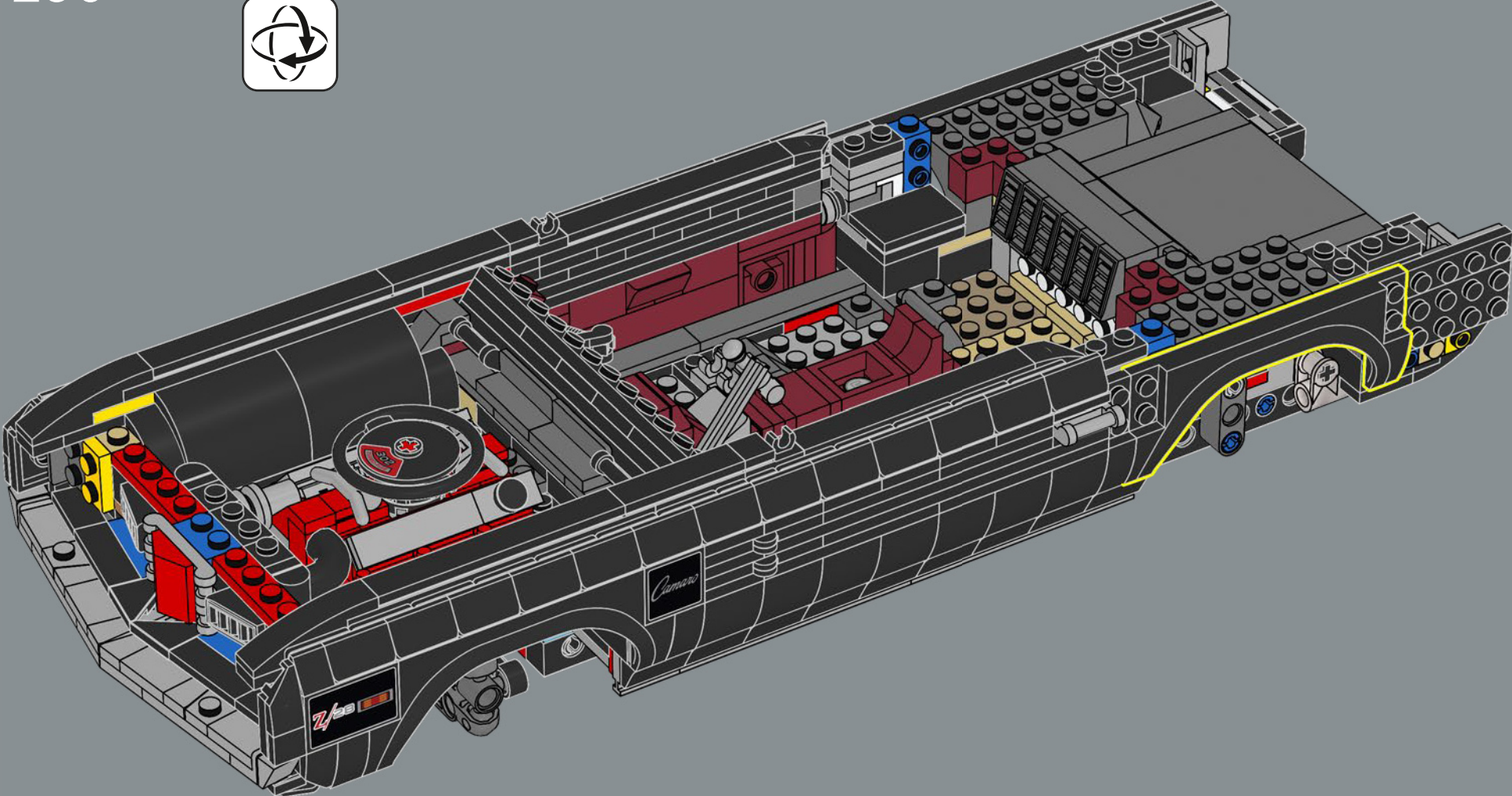

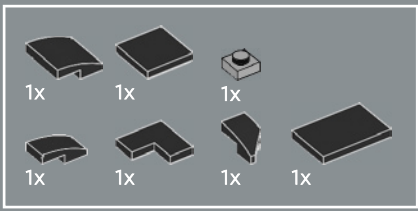

231

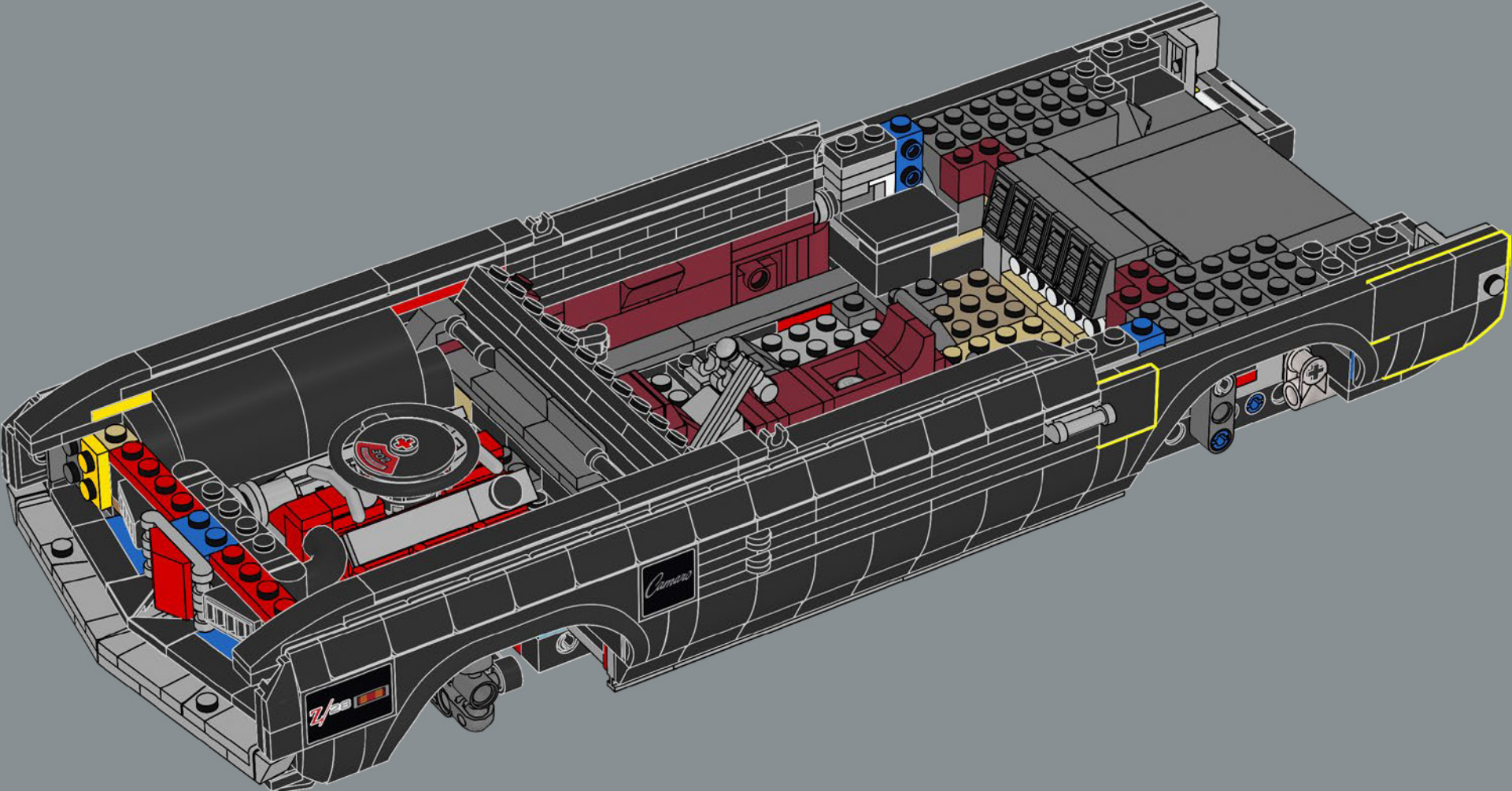

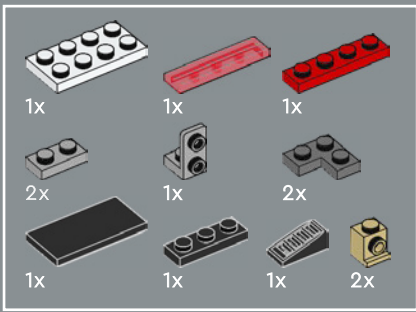

232

1



2



3

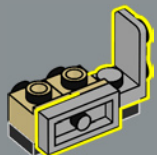

4

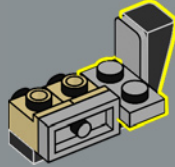

5

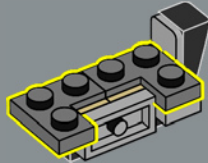

6

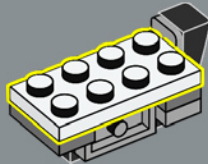

7

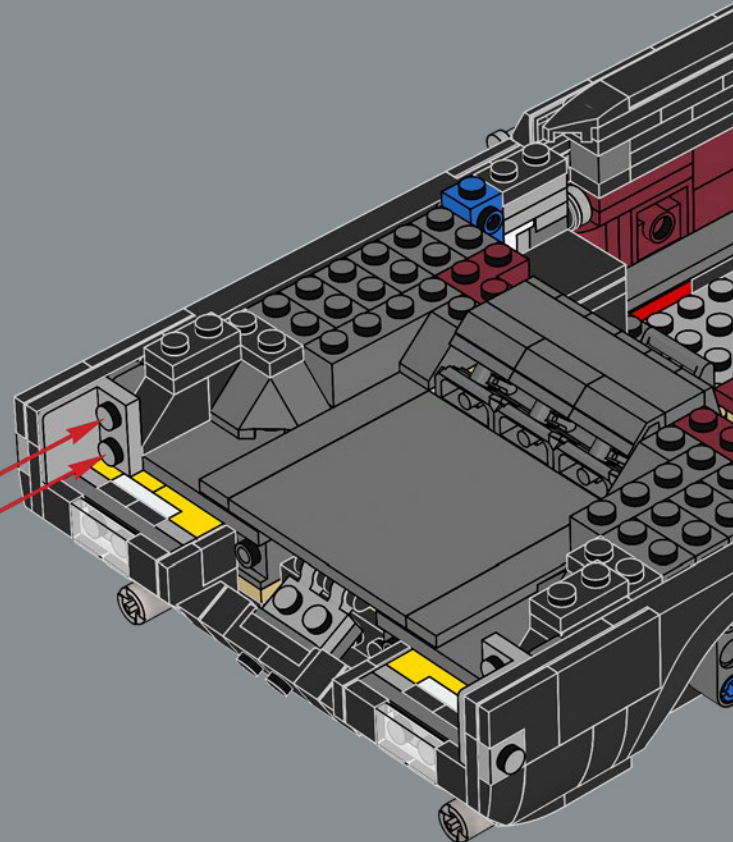
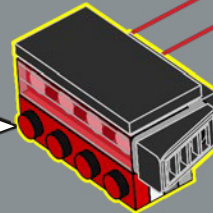
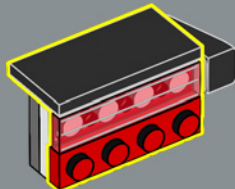

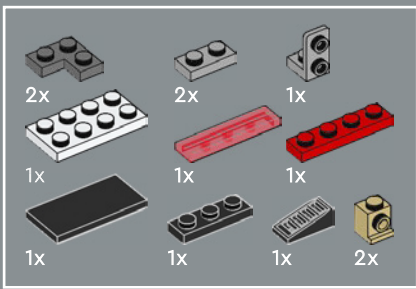

233

1



2



3

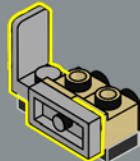

4

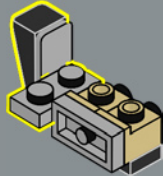

5

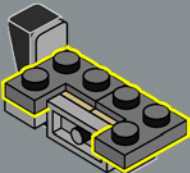

6

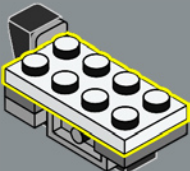

7

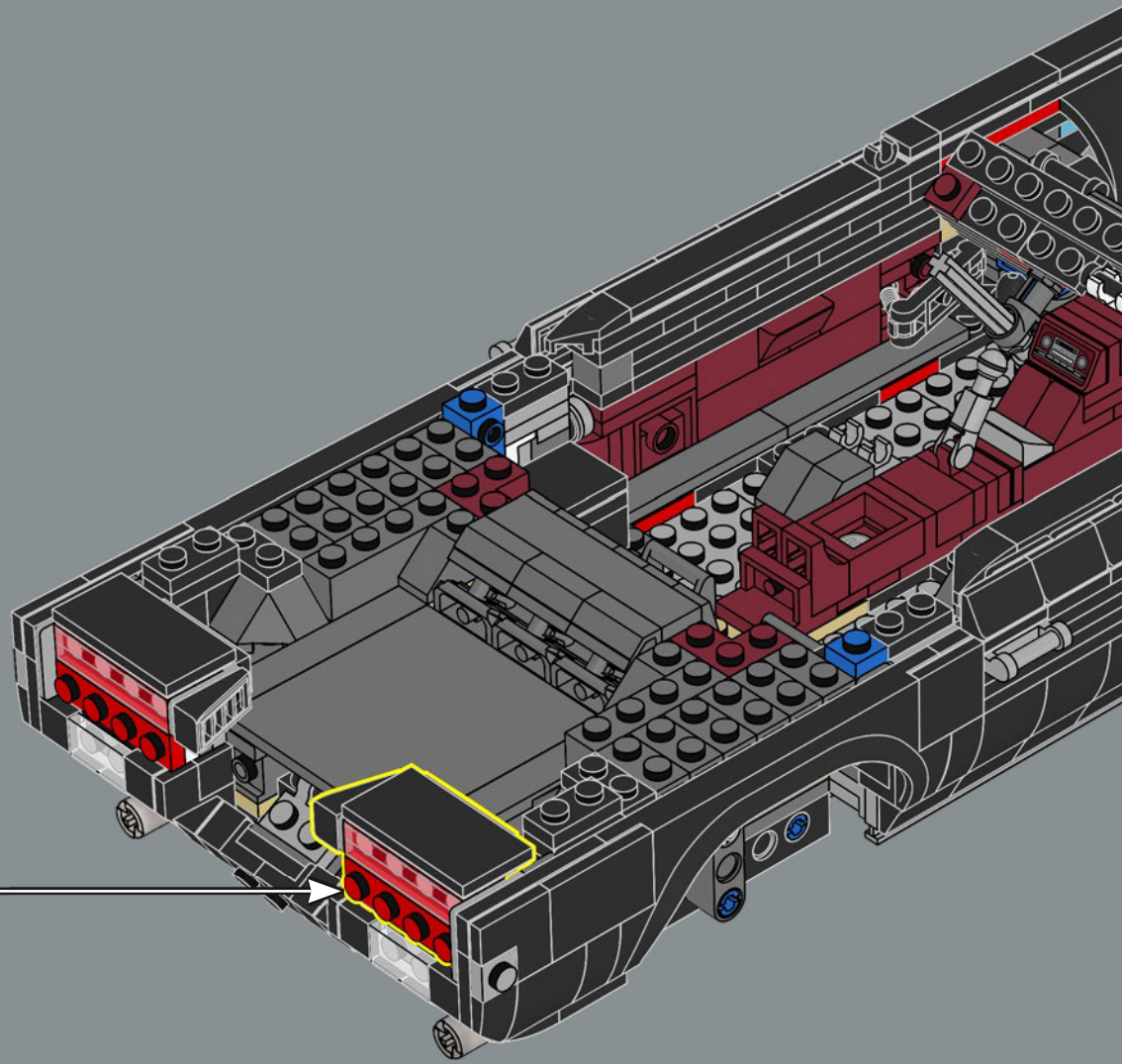
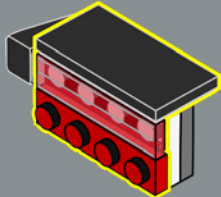

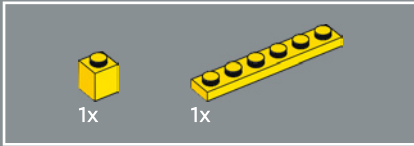
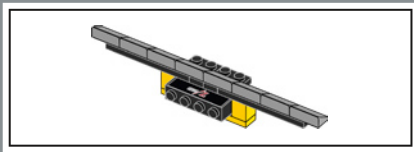

234

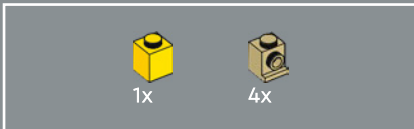
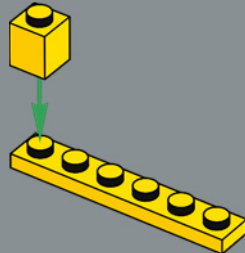

235

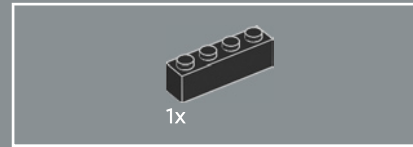
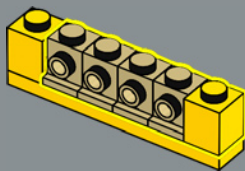

236

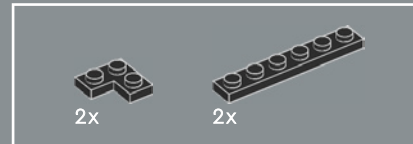
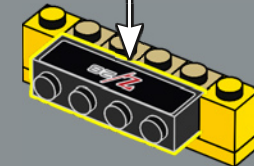
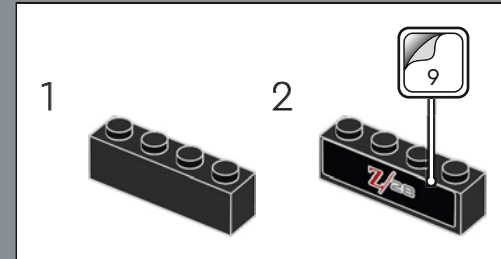

237

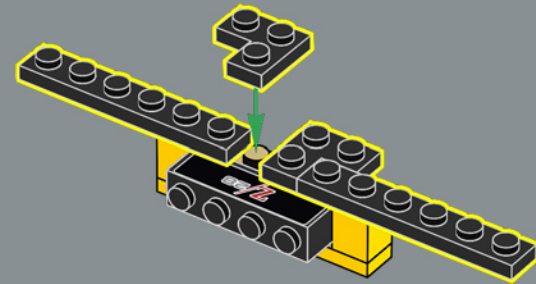



2x

238

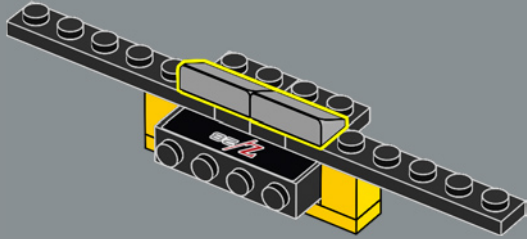

6x

239

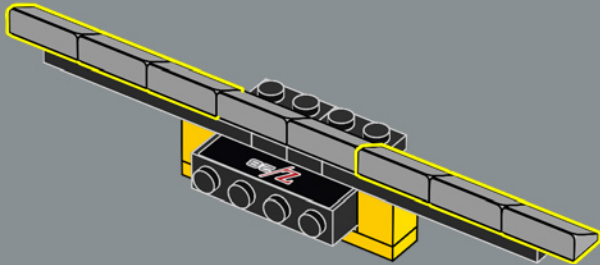

240

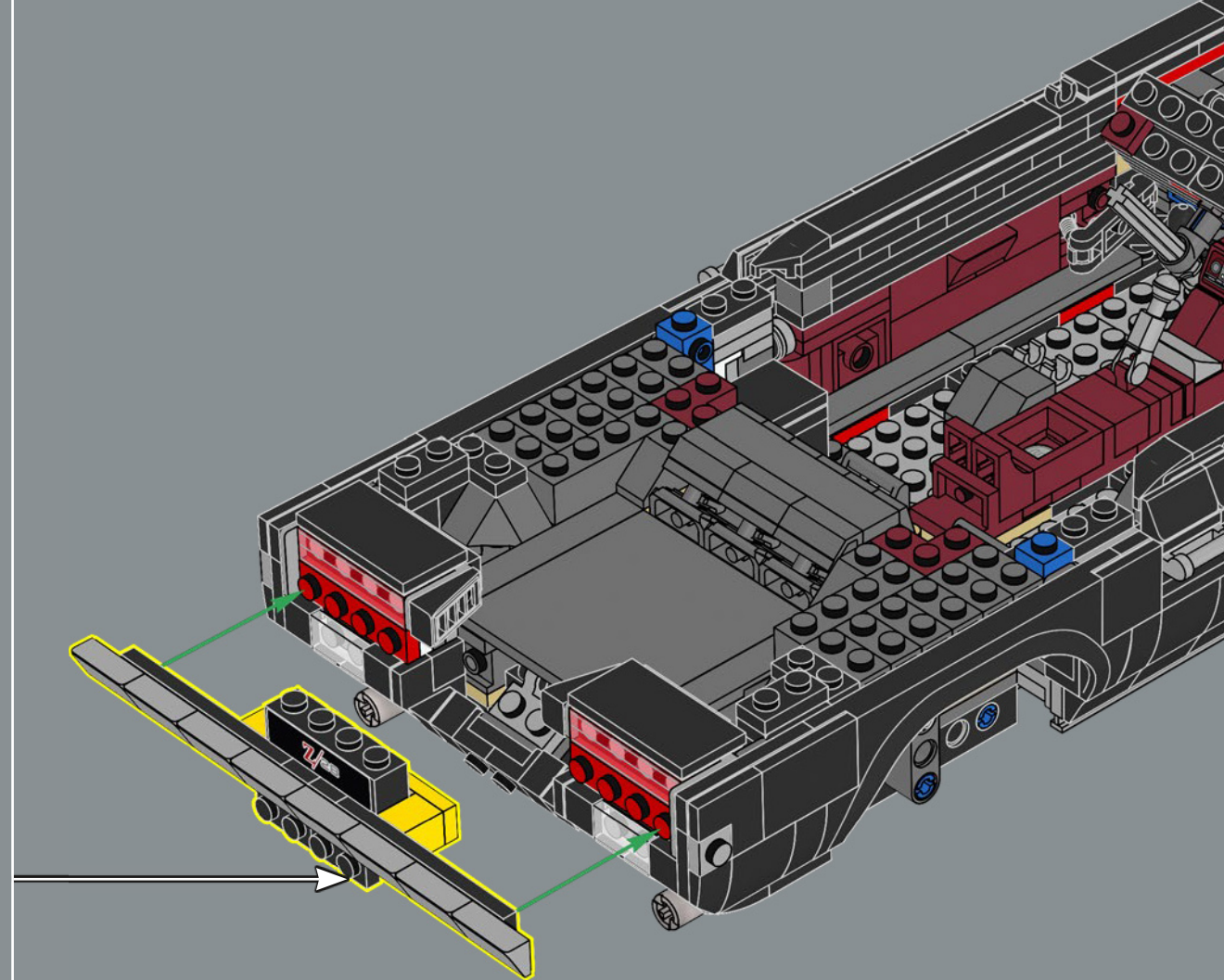

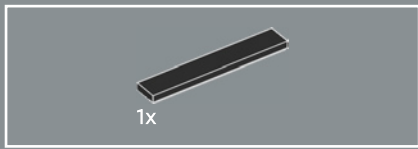

241

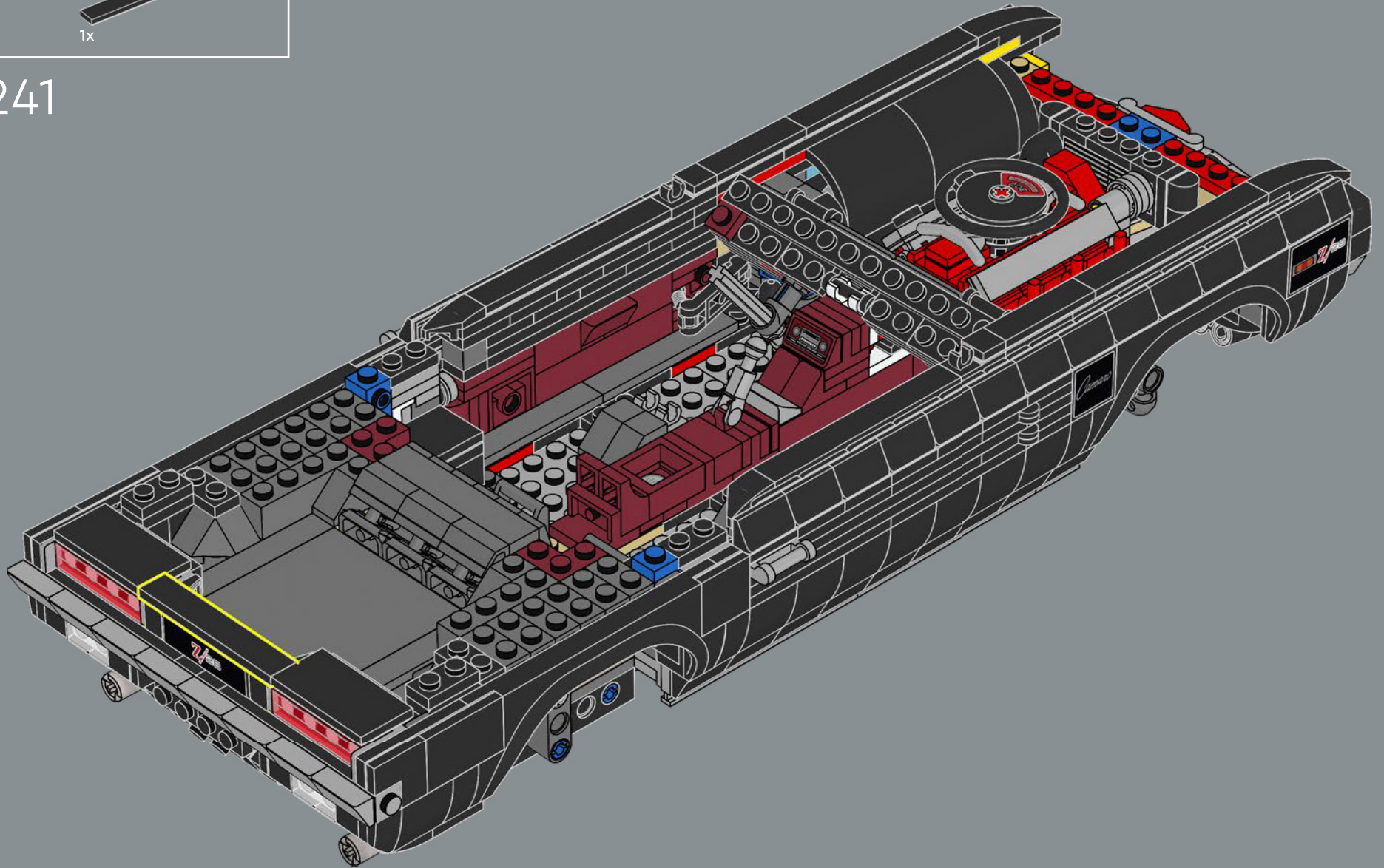

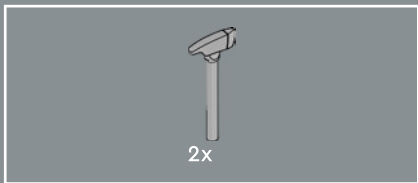

242

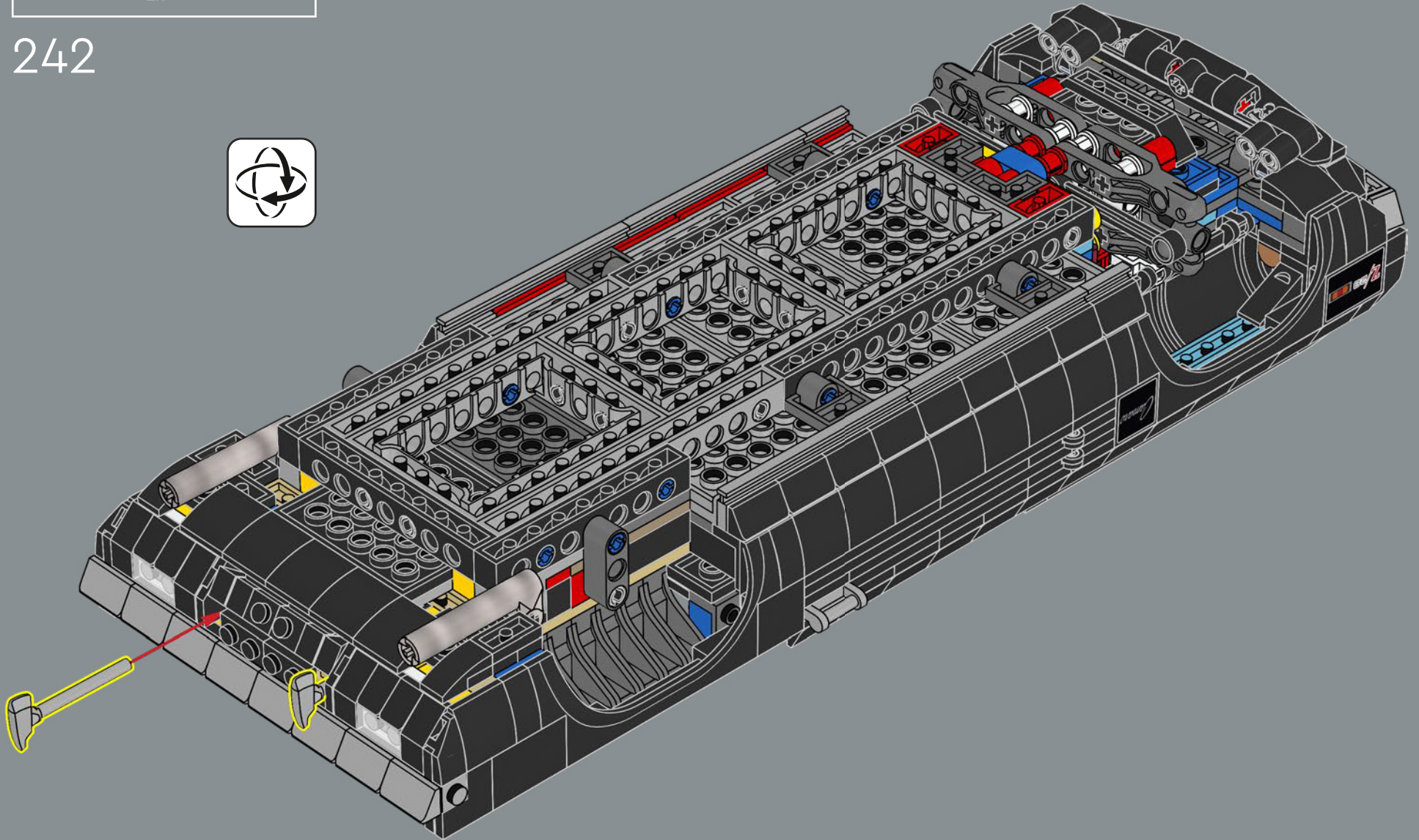

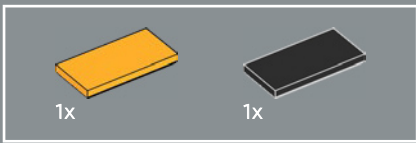

Unlike most Chevrolets, the first 3 generation Camaros weren't built in Detroit, they were manufactured in the Norwood, Ohio and Van Nuys, California plants.

243

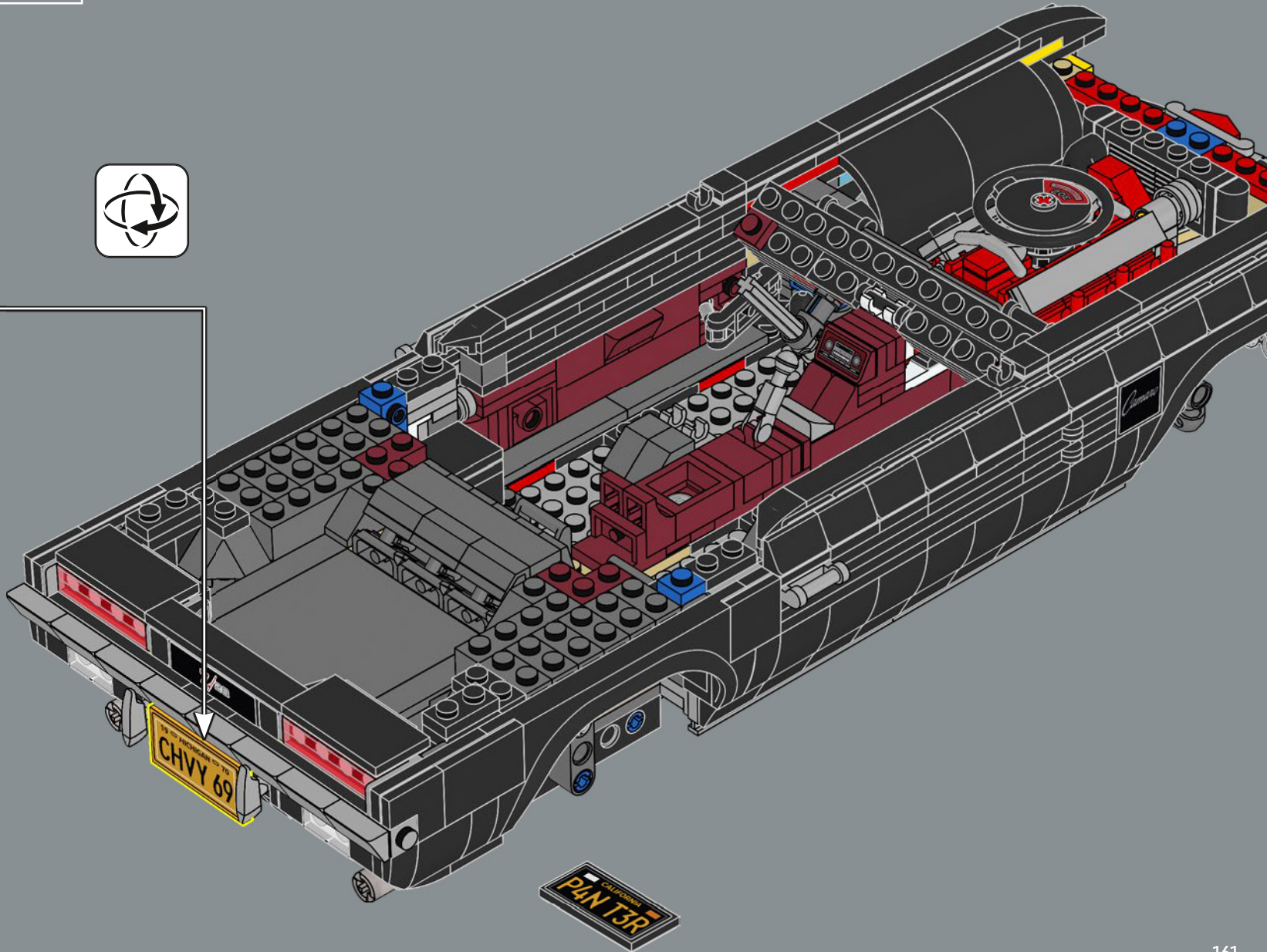
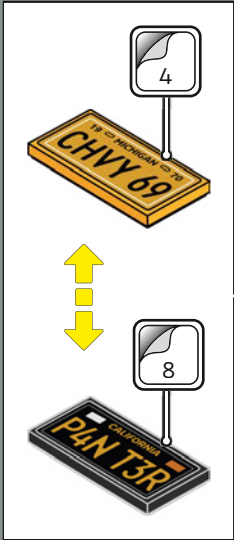

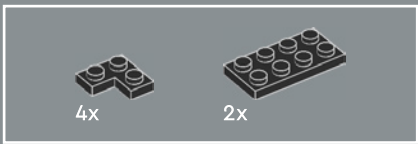

244

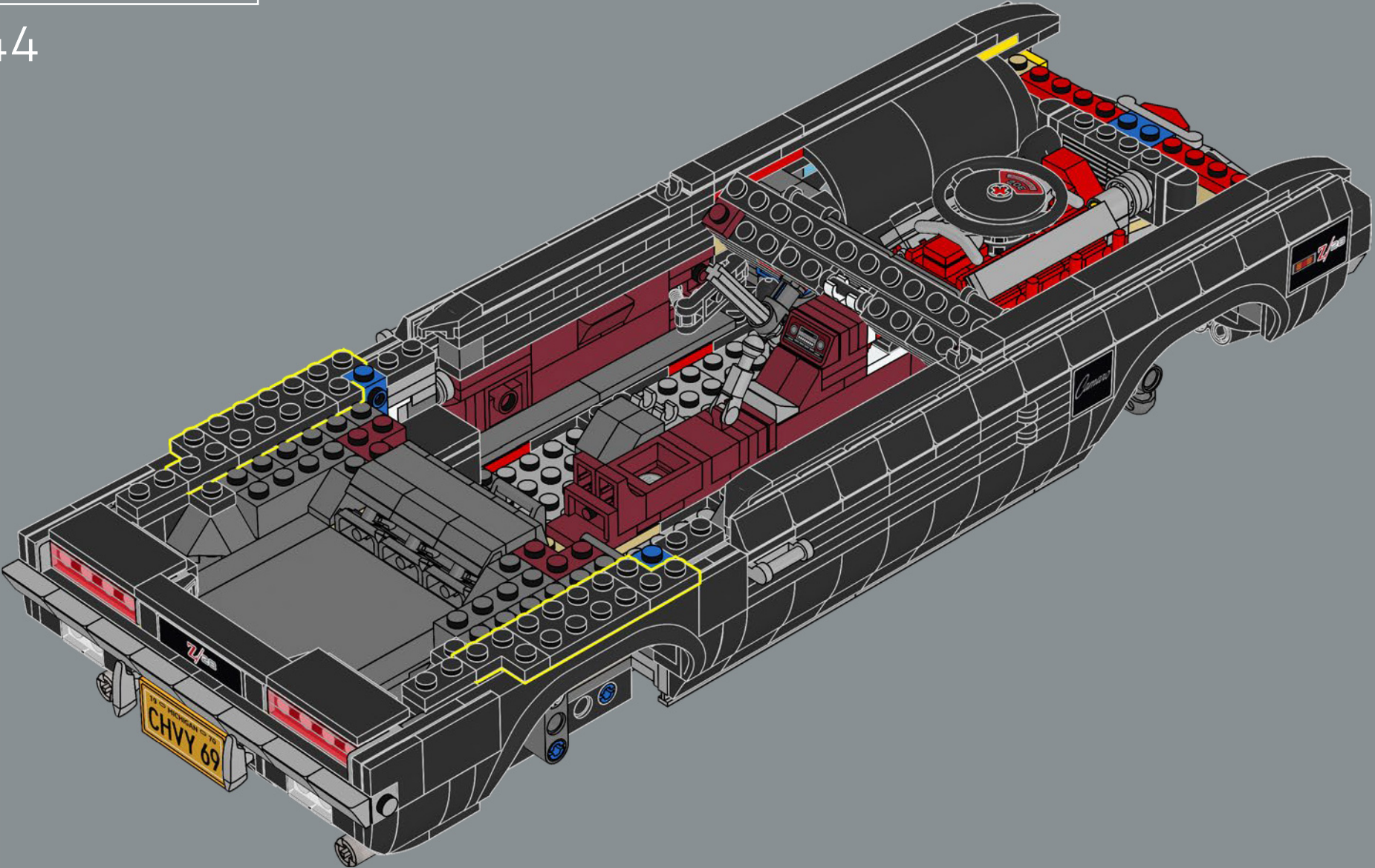

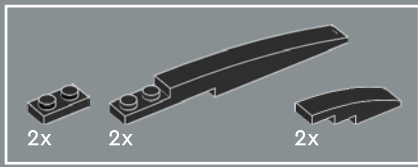

245

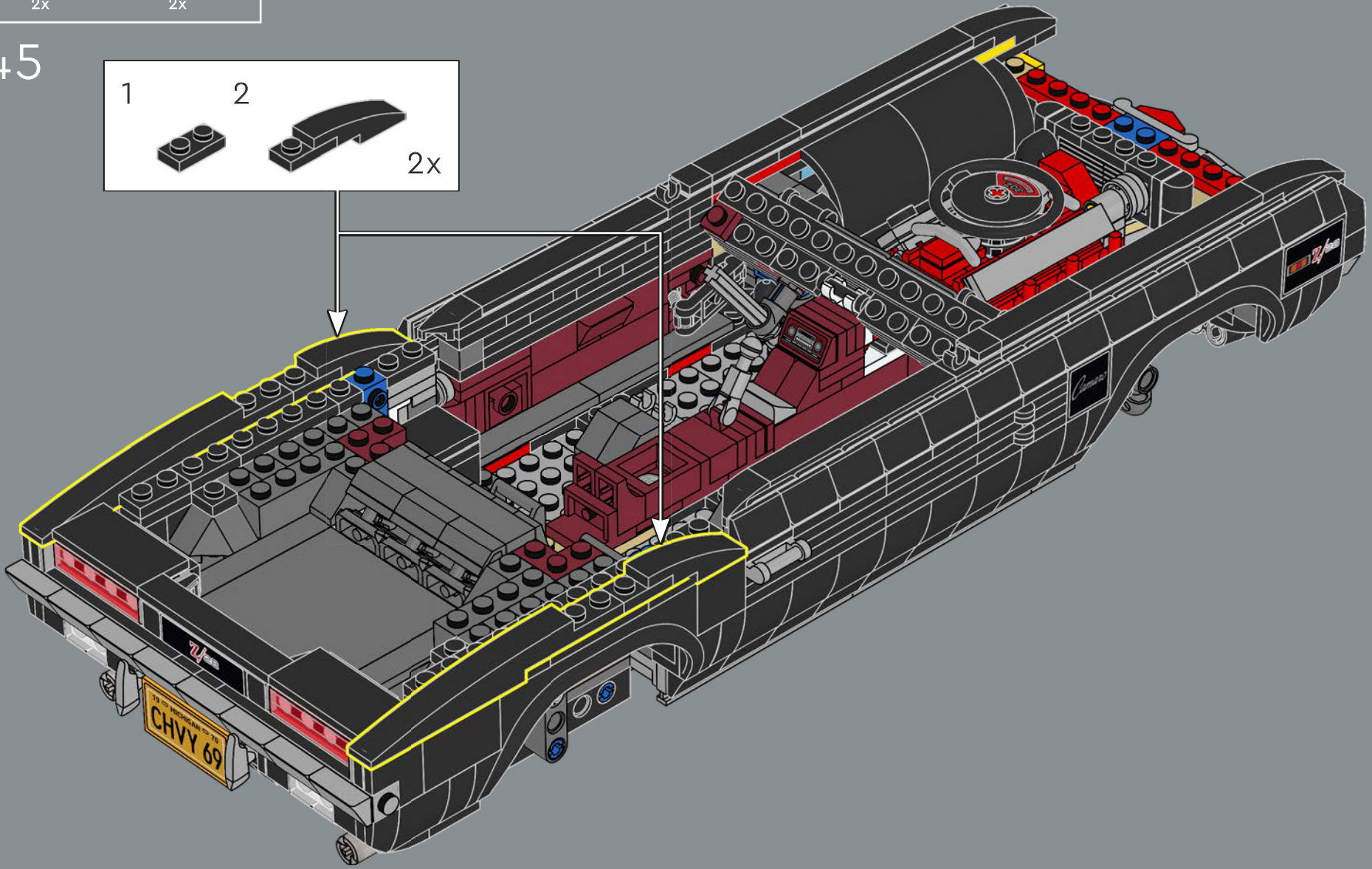
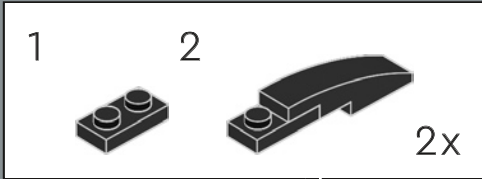

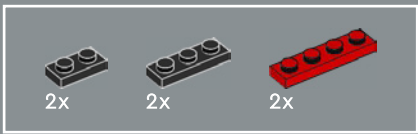

246

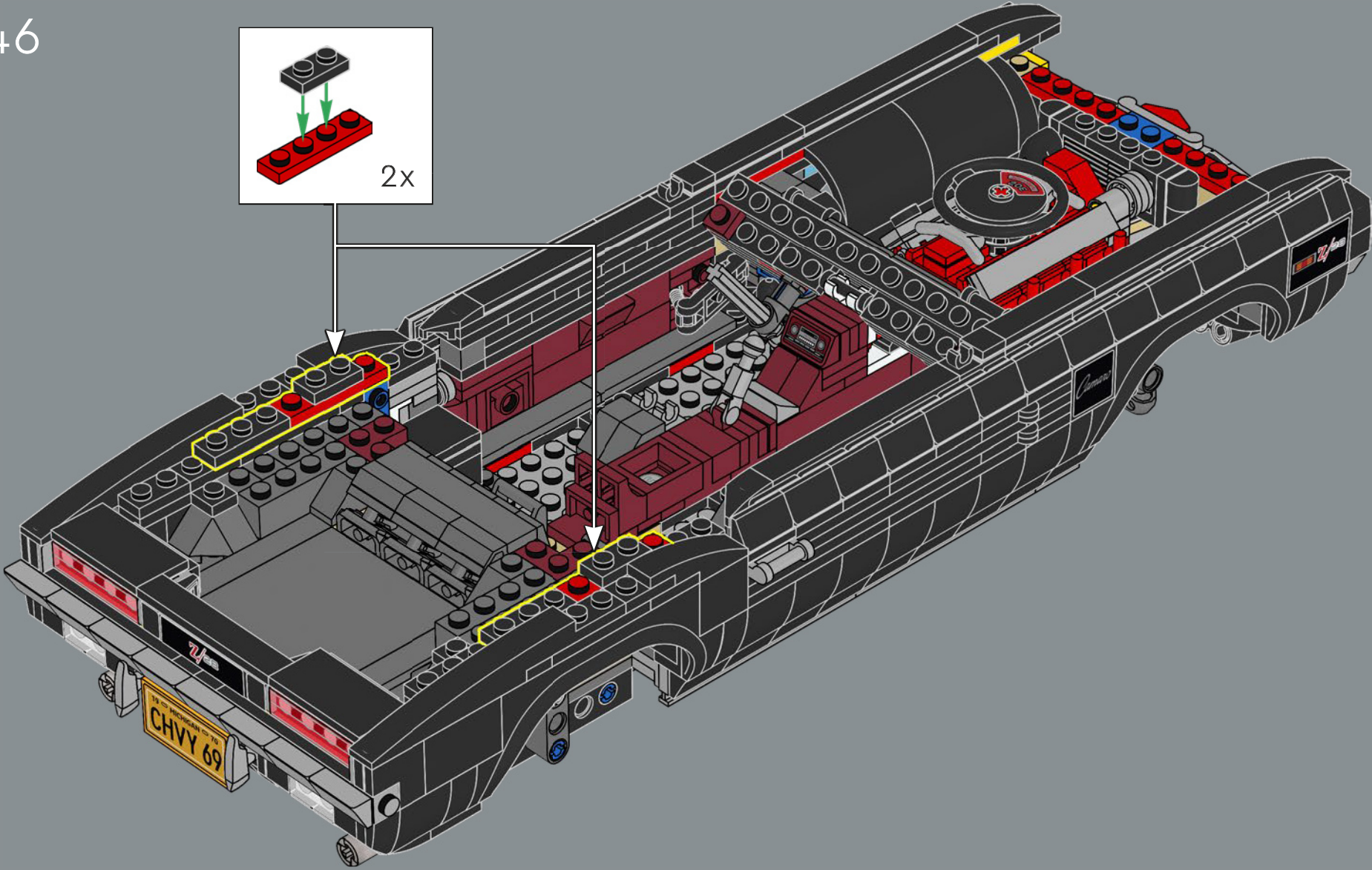
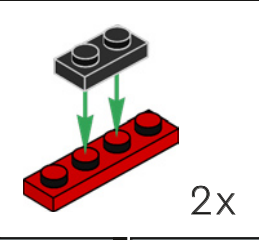

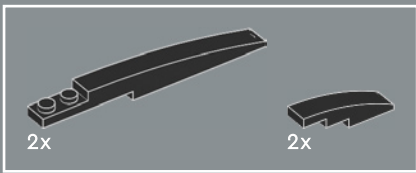

247

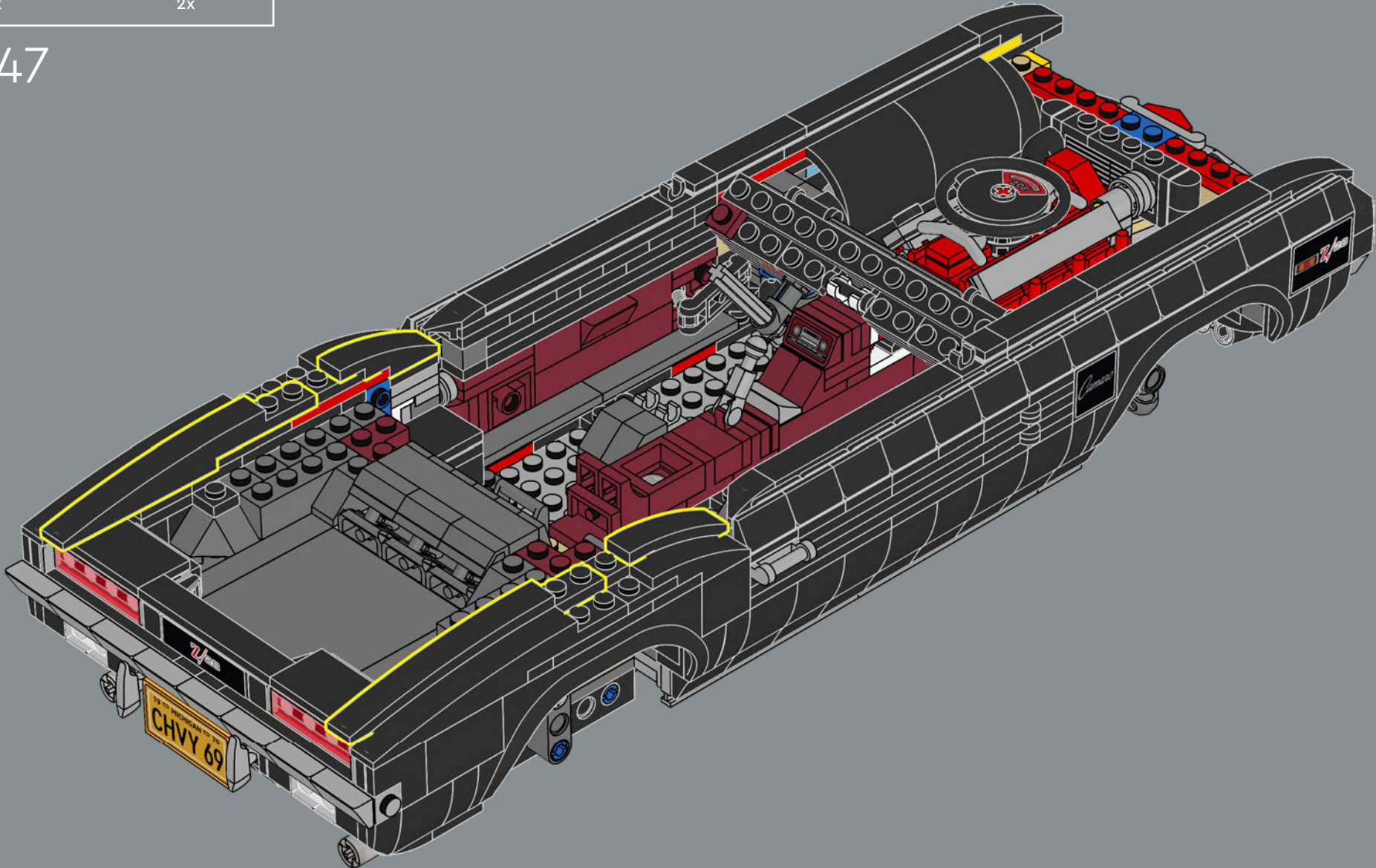

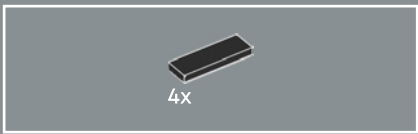

248

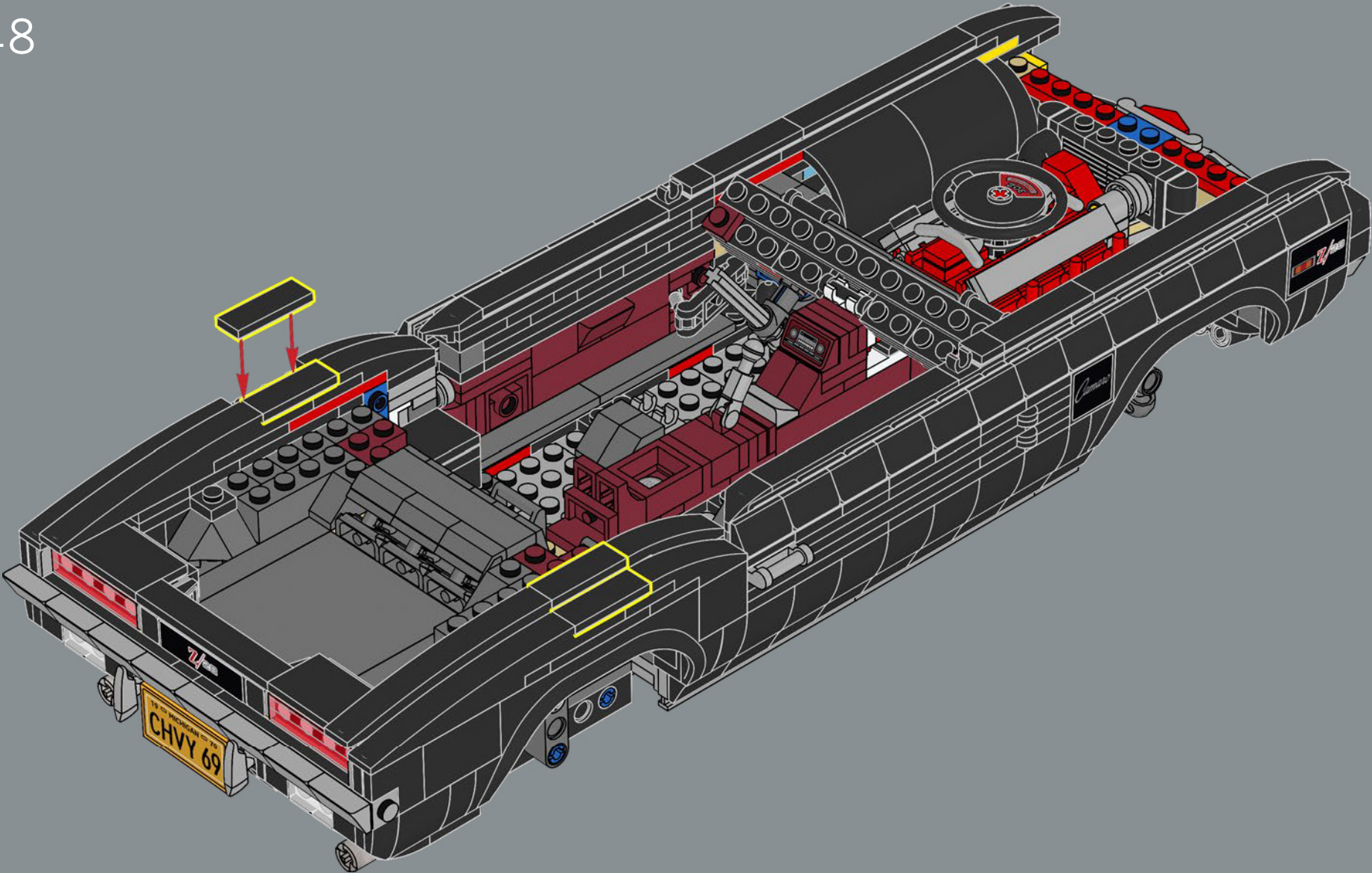

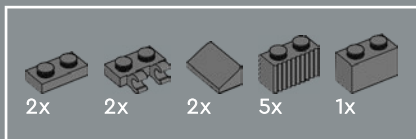

249

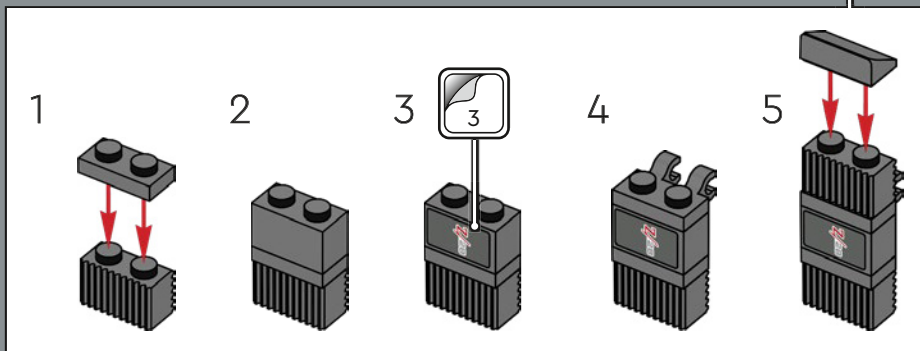
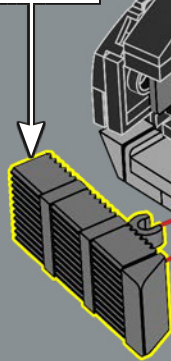
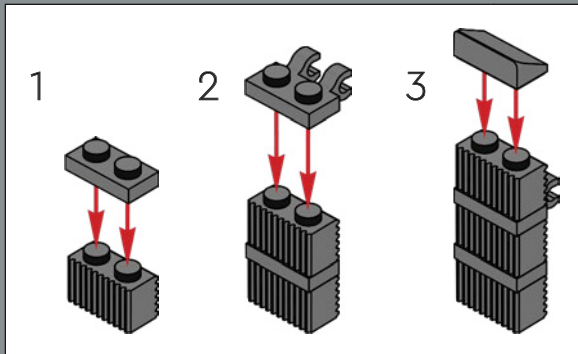

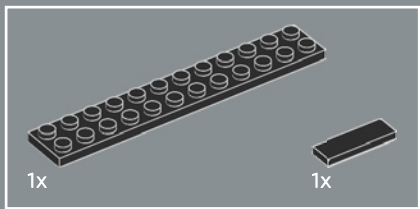

250

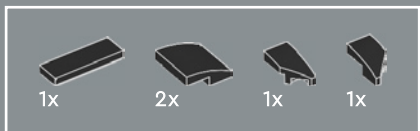
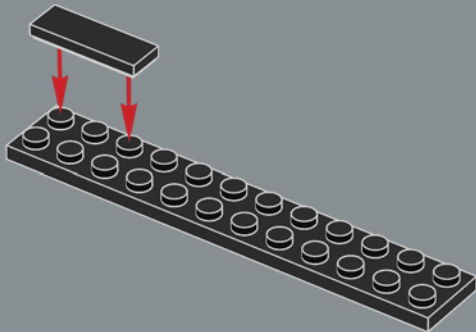

251

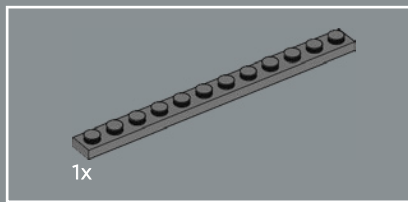
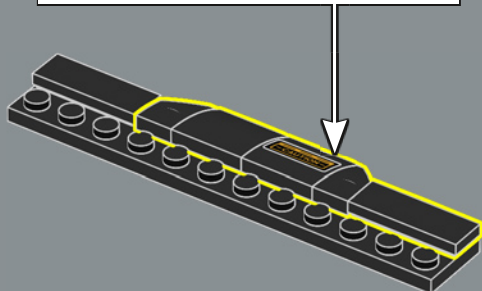
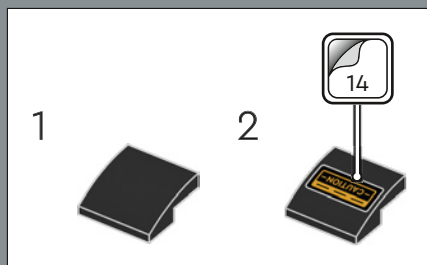

252

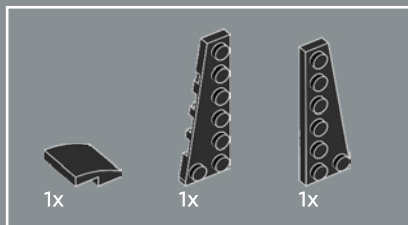
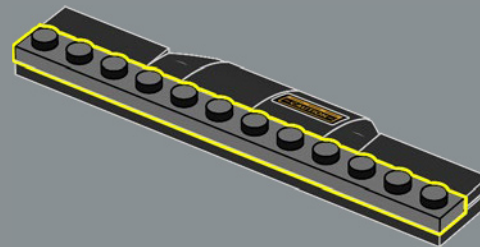

253

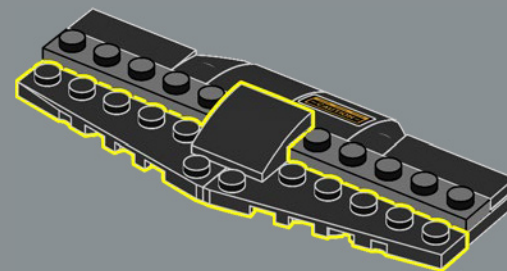



254

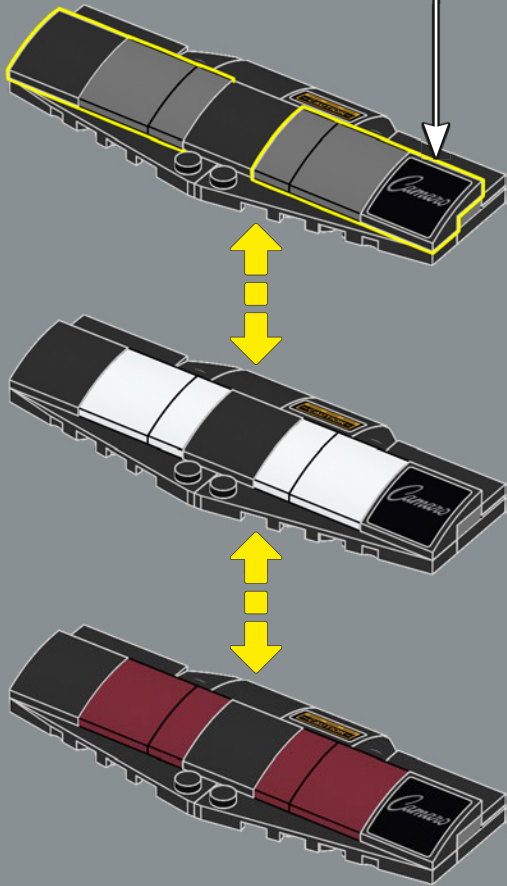
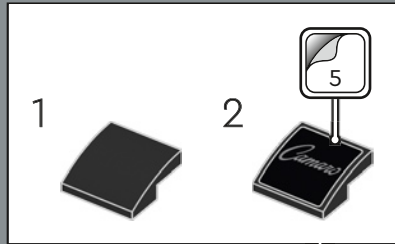

255

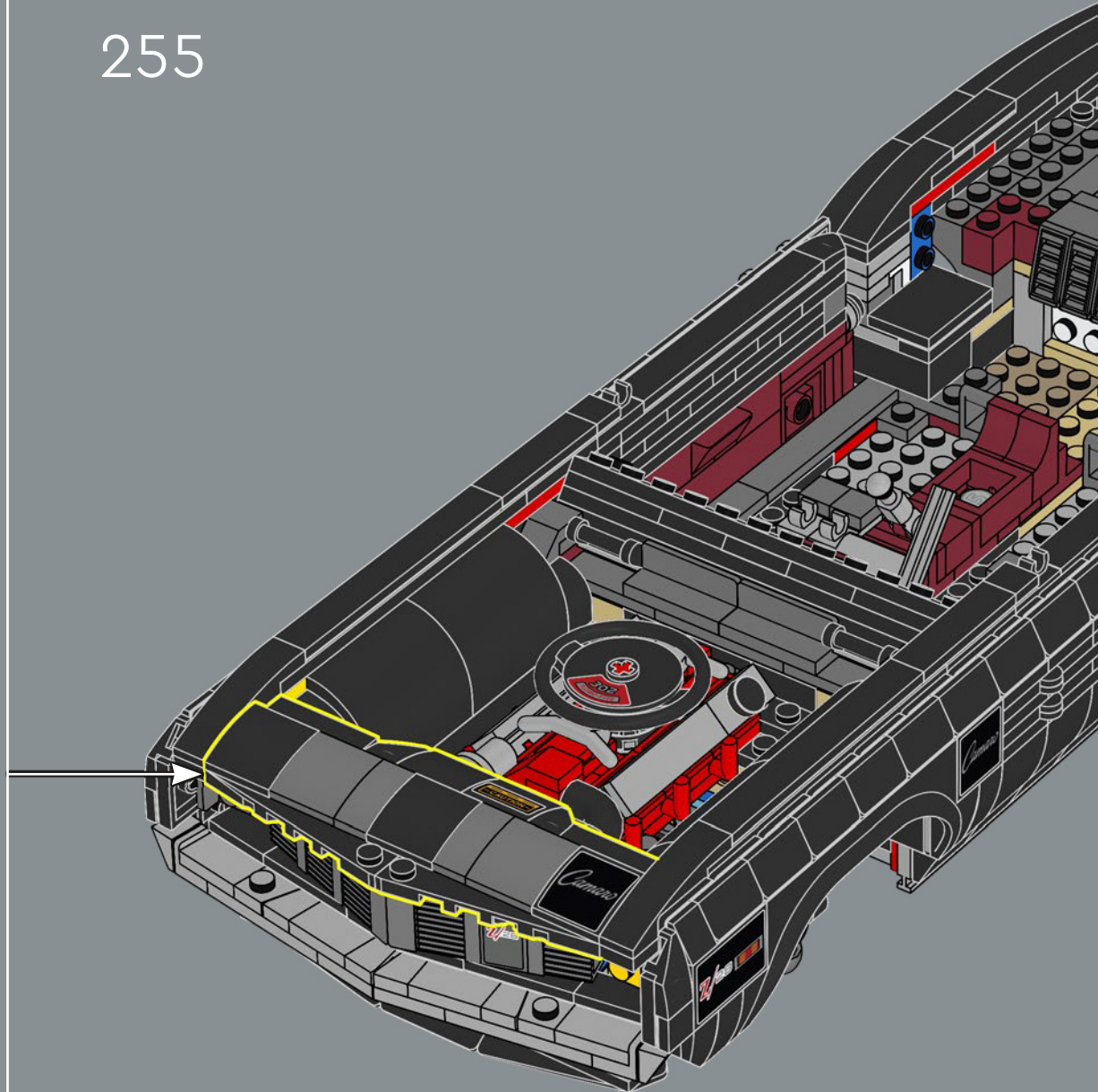

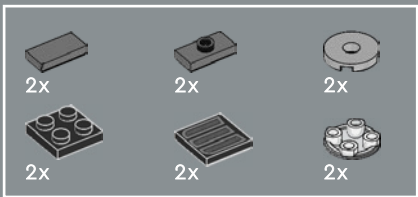

256

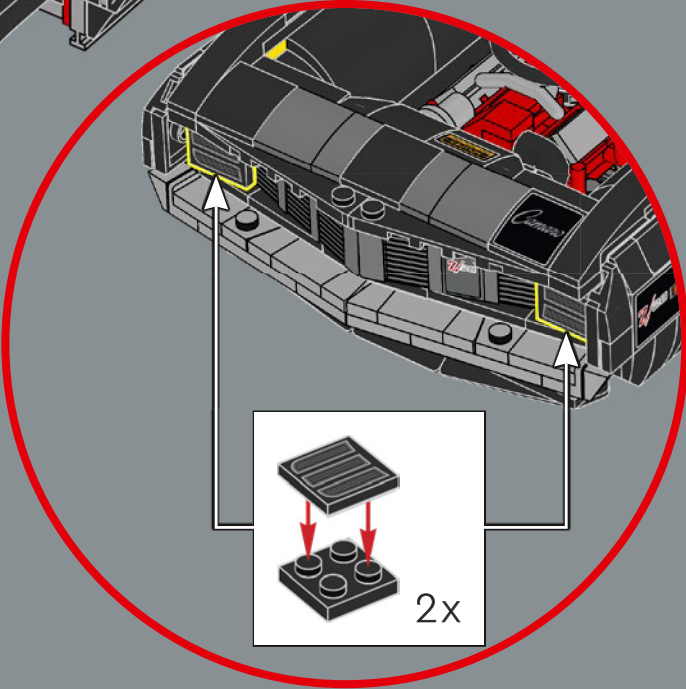
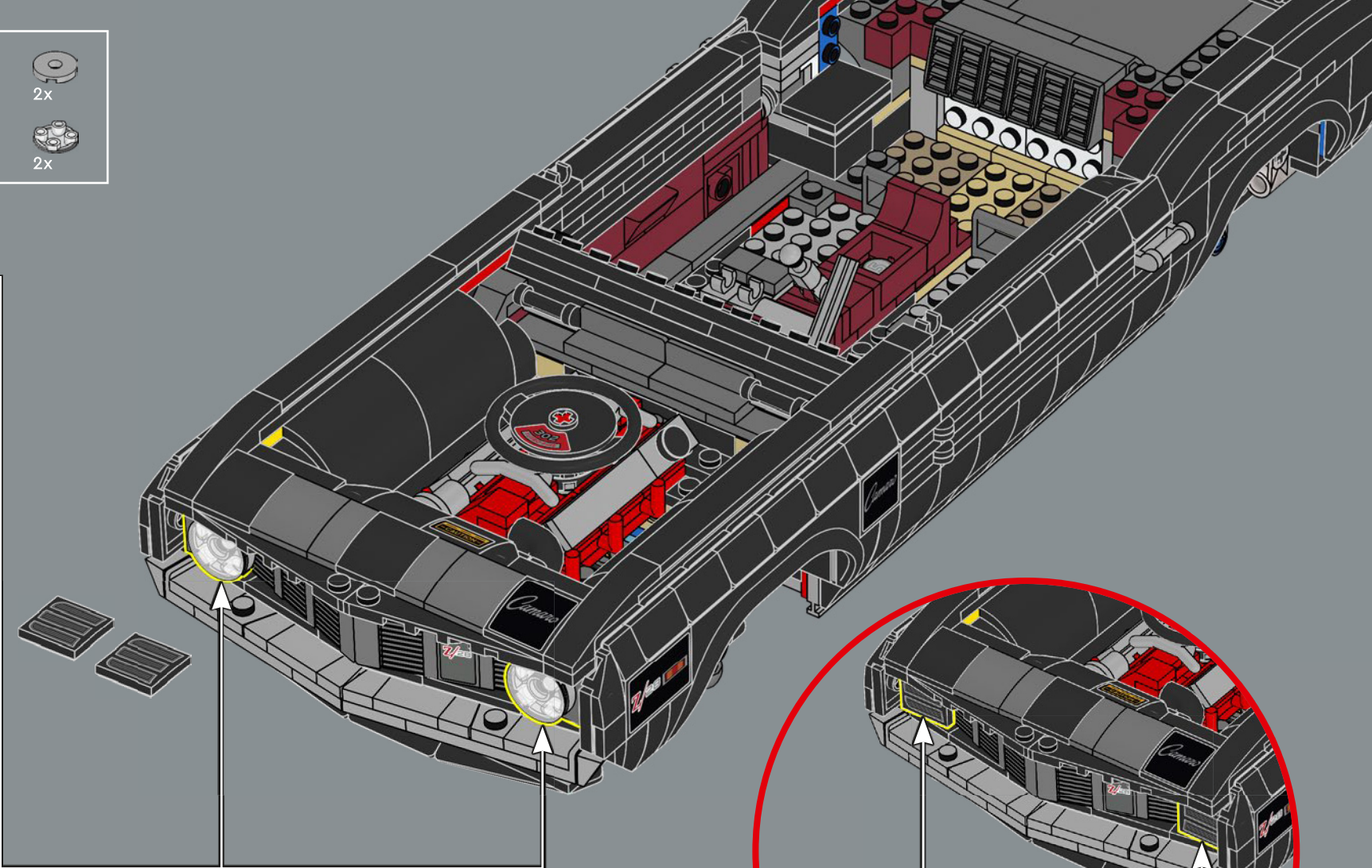
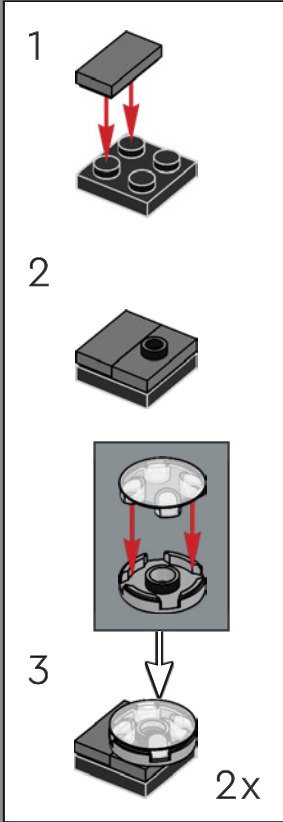

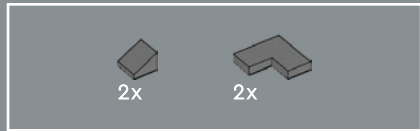

257

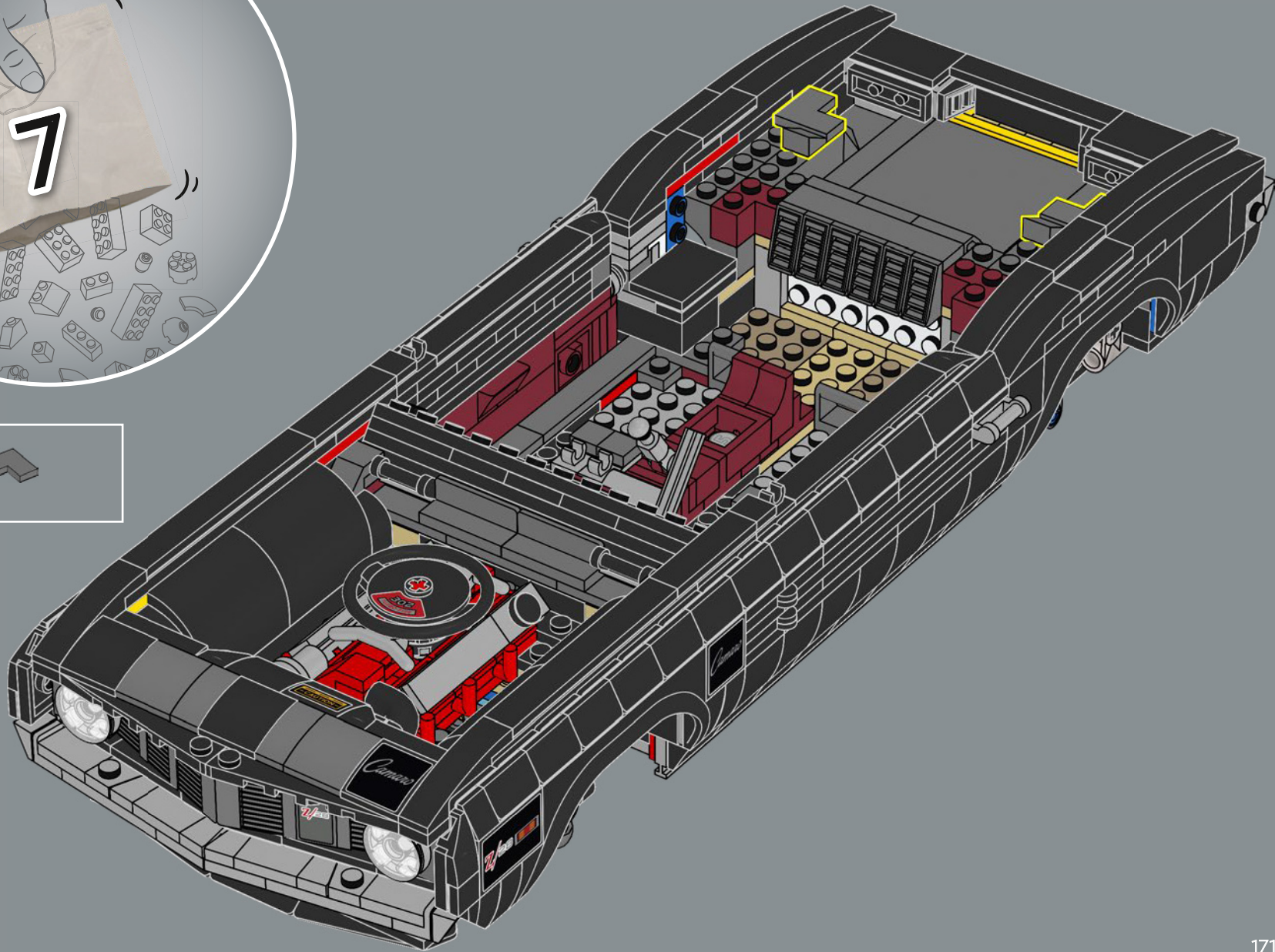

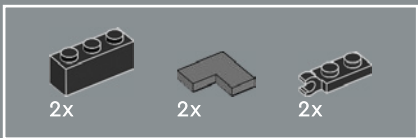

258

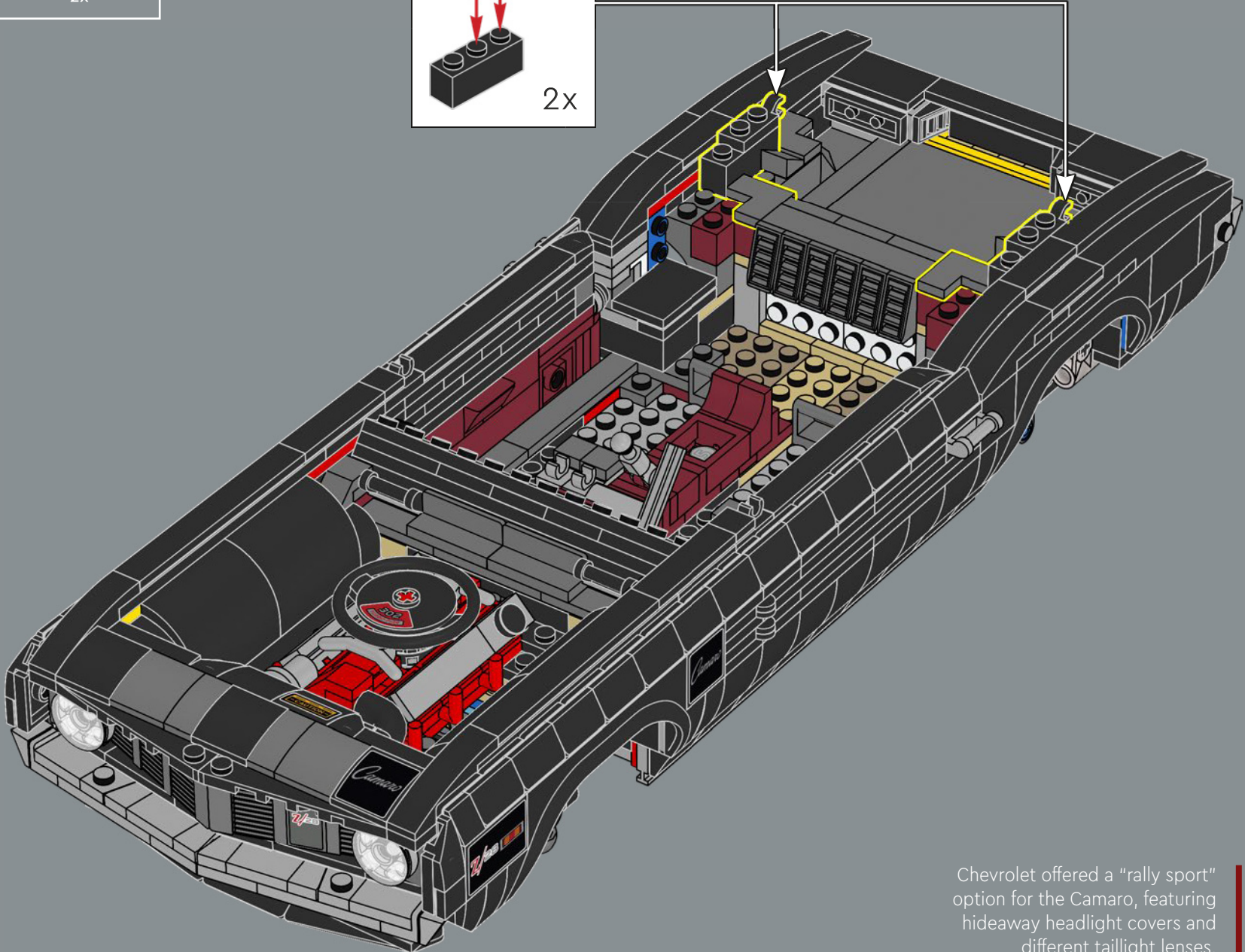
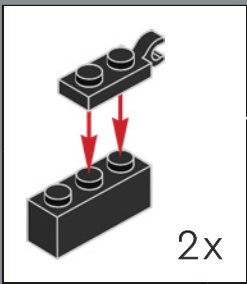

Chevrolet offered a "rally sport" option for the Camaro, featuring hideaway headlight covers and different taillight lenses.

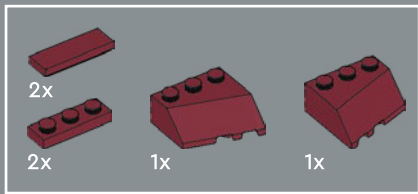

259

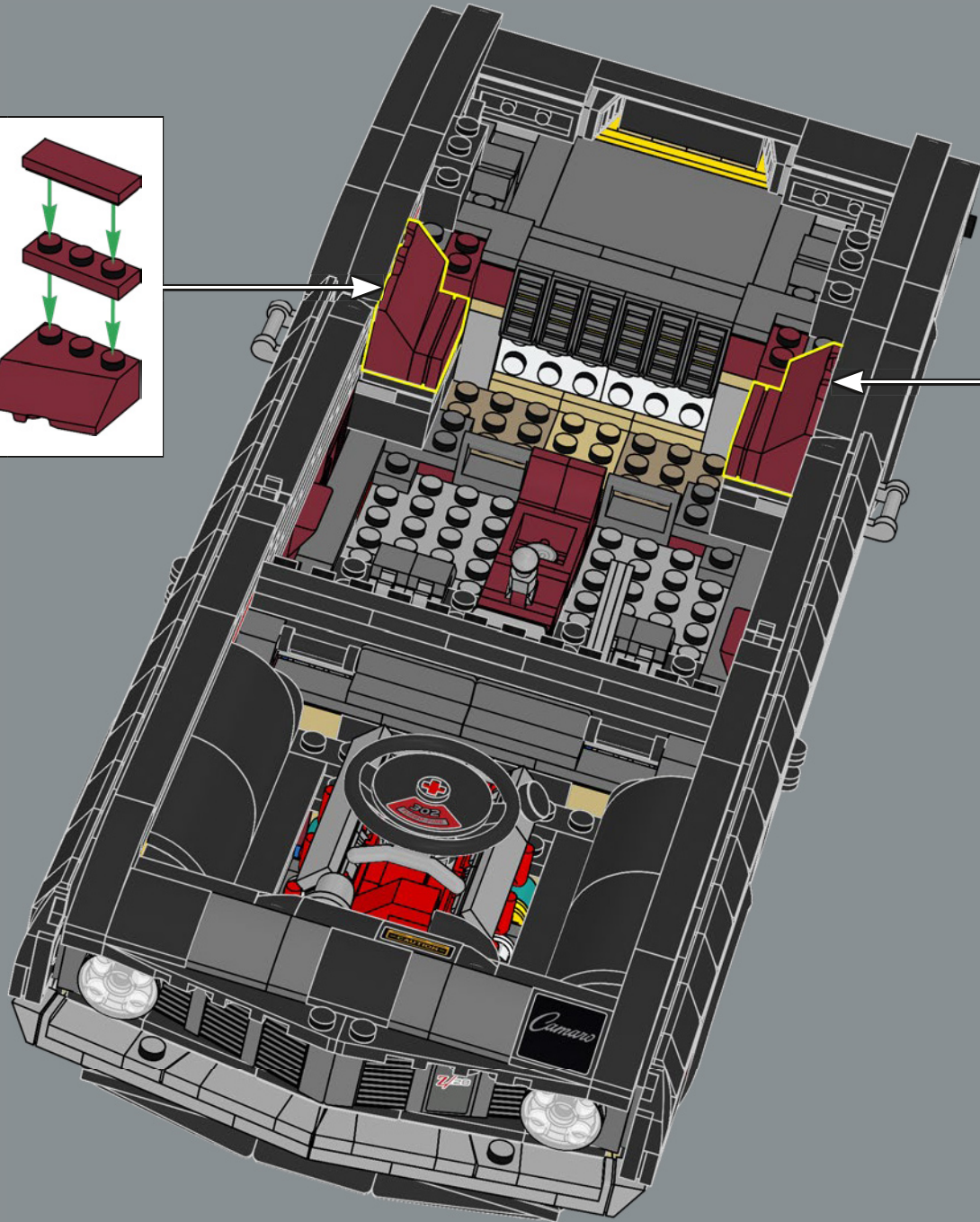
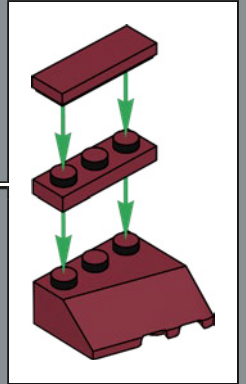
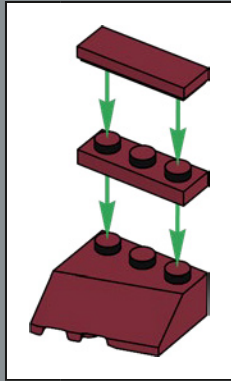

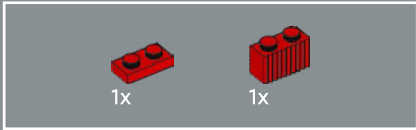

260

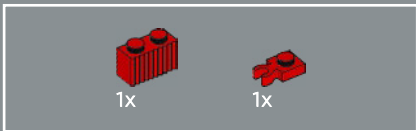

261

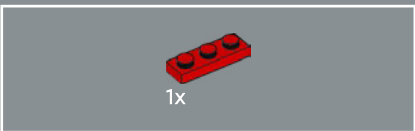
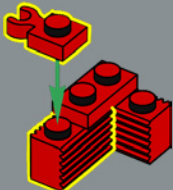

262

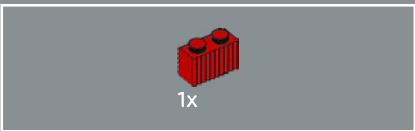
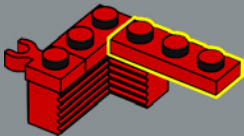

263

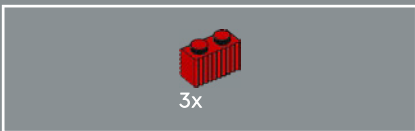
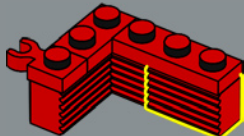

264

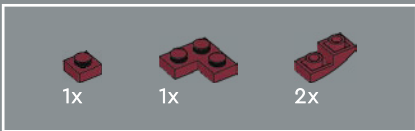
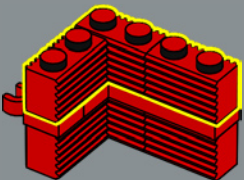

265

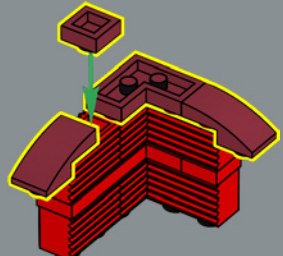

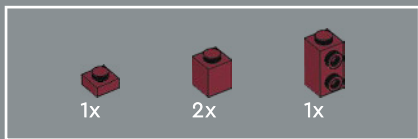

266

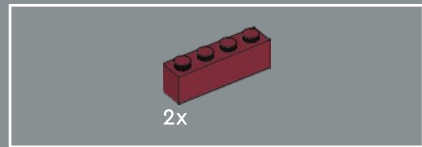
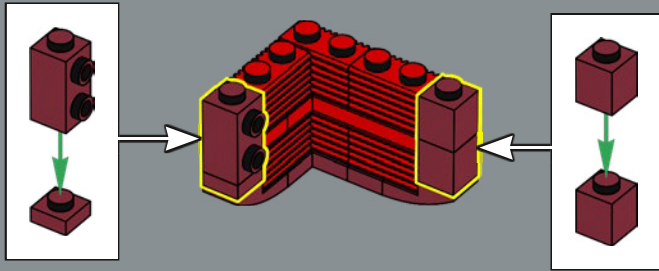

267

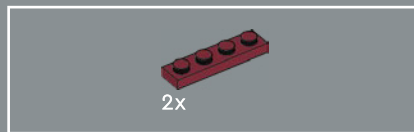
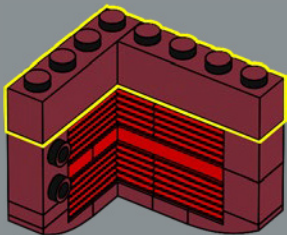

268

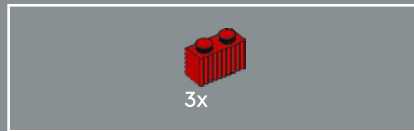
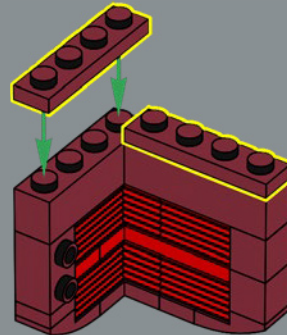

269

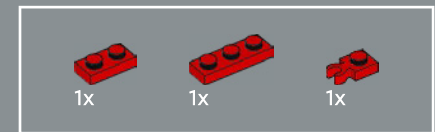
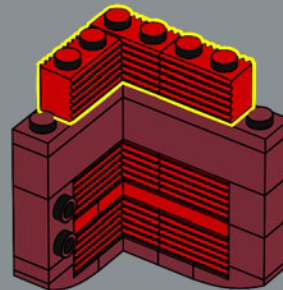

270

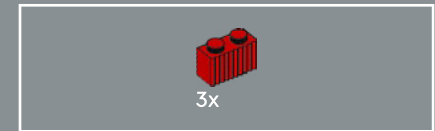
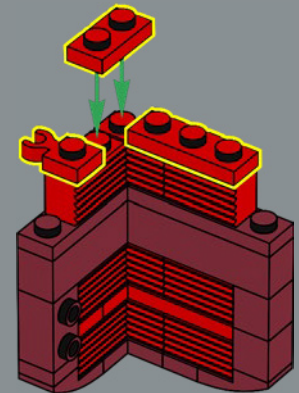

271

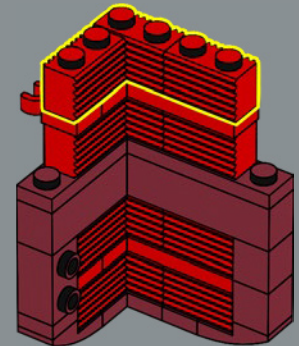



4x

272

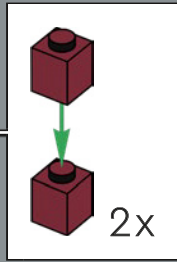
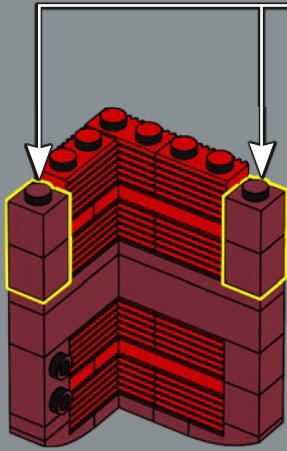

2x

1x

2x

1x

273

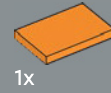
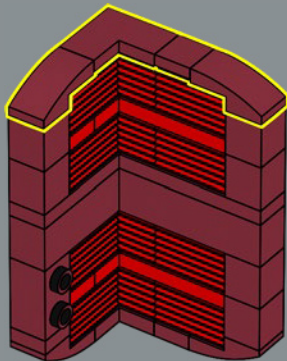

1x

274



15

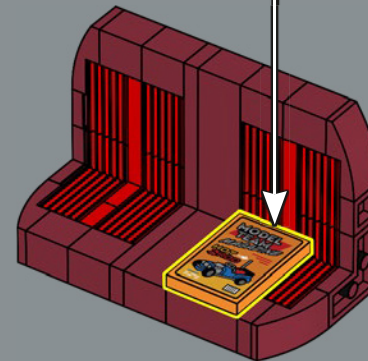

275

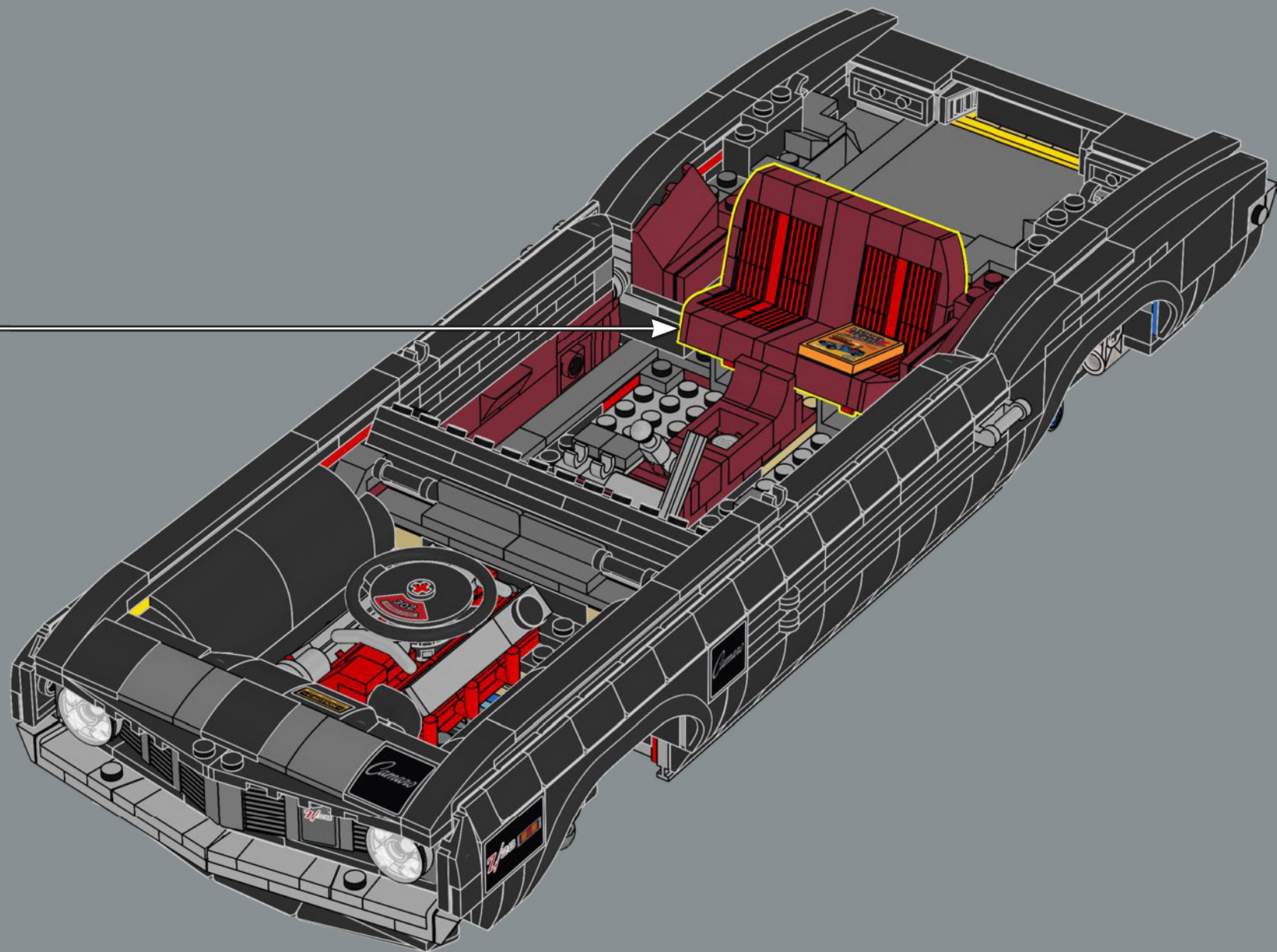

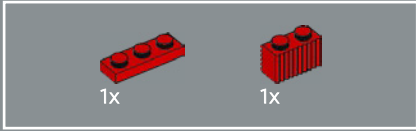

276

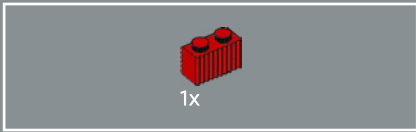
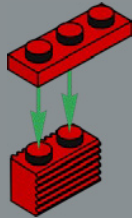

277

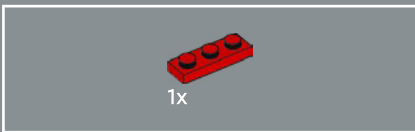
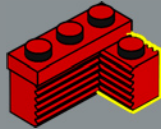

278

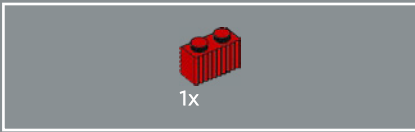
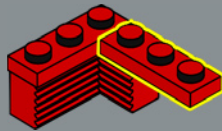

279

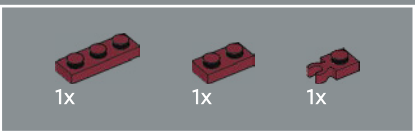
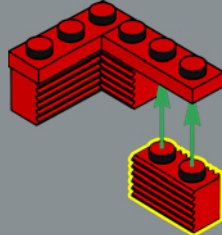

280

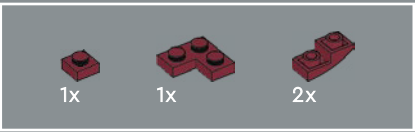
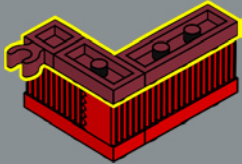

281

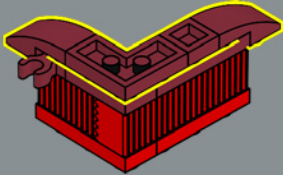



282

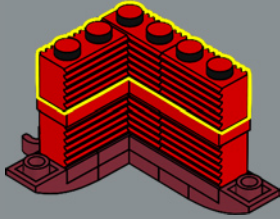

283

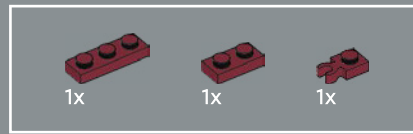
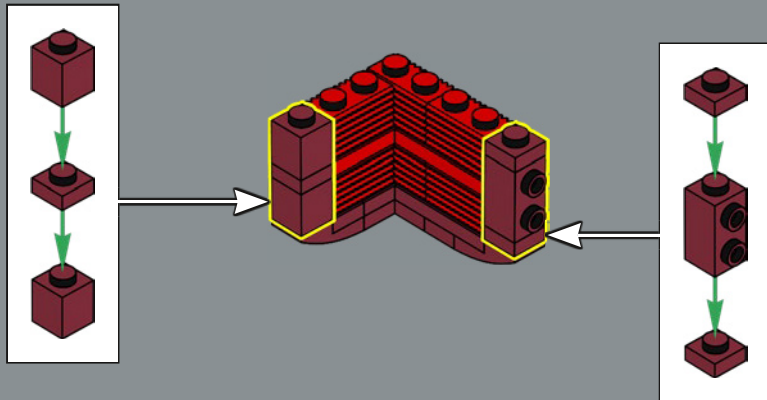

284

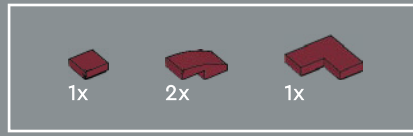
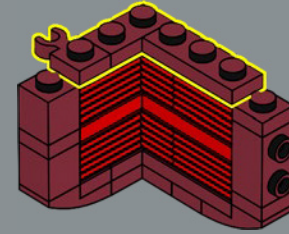

285

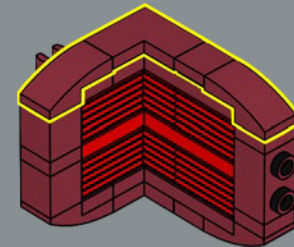



1x

286

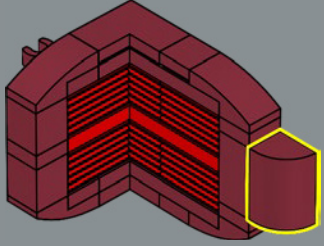

1x

287

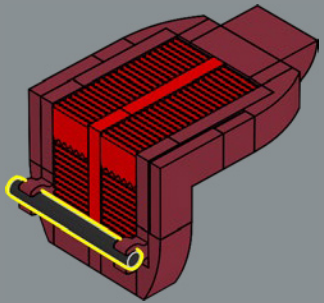

288

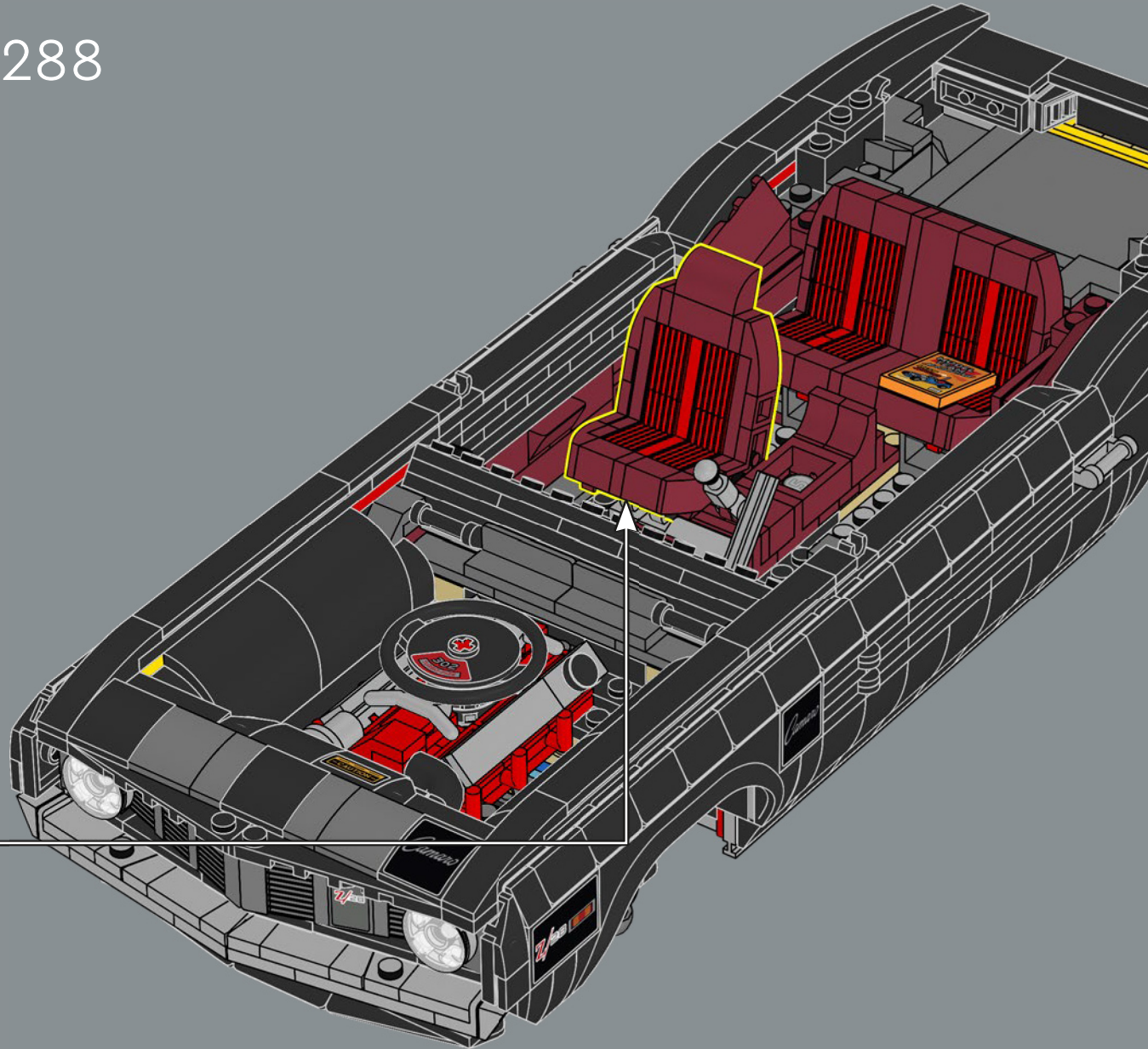

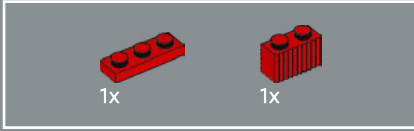

289

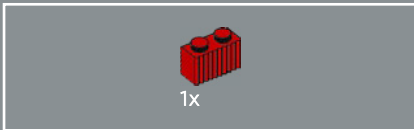
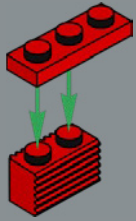

290

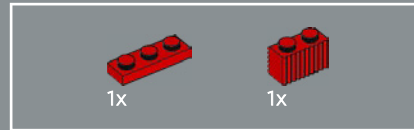
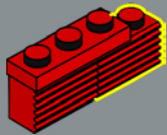

291

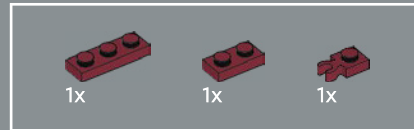
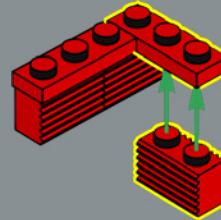

292

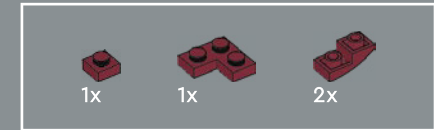
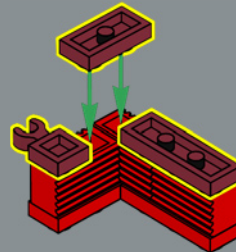

293

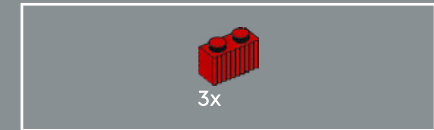
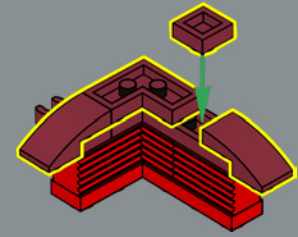

294

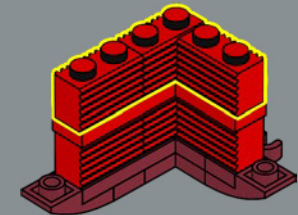



295

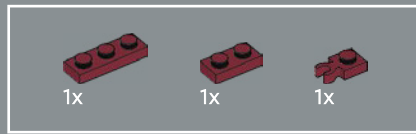
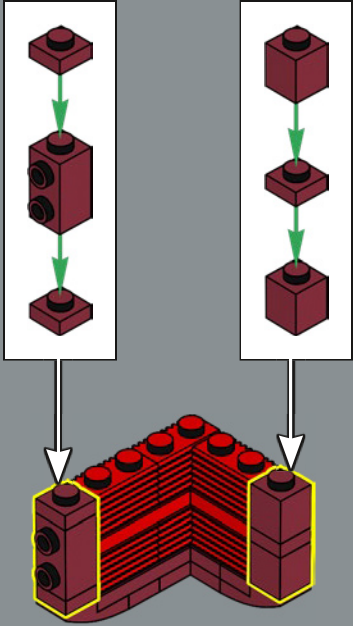

296

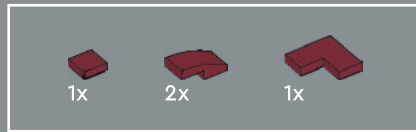
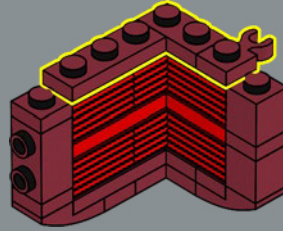

297

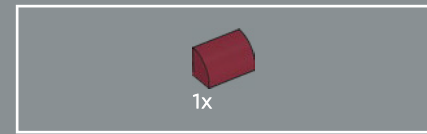
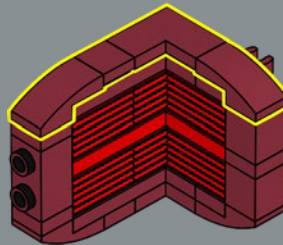

298

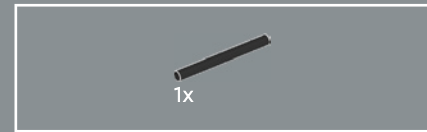
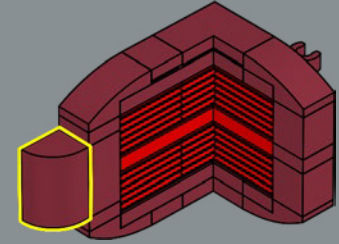

299

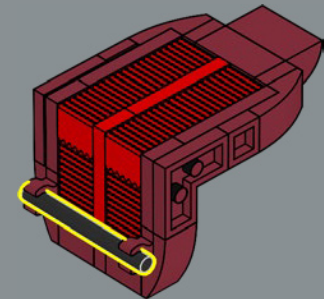

300

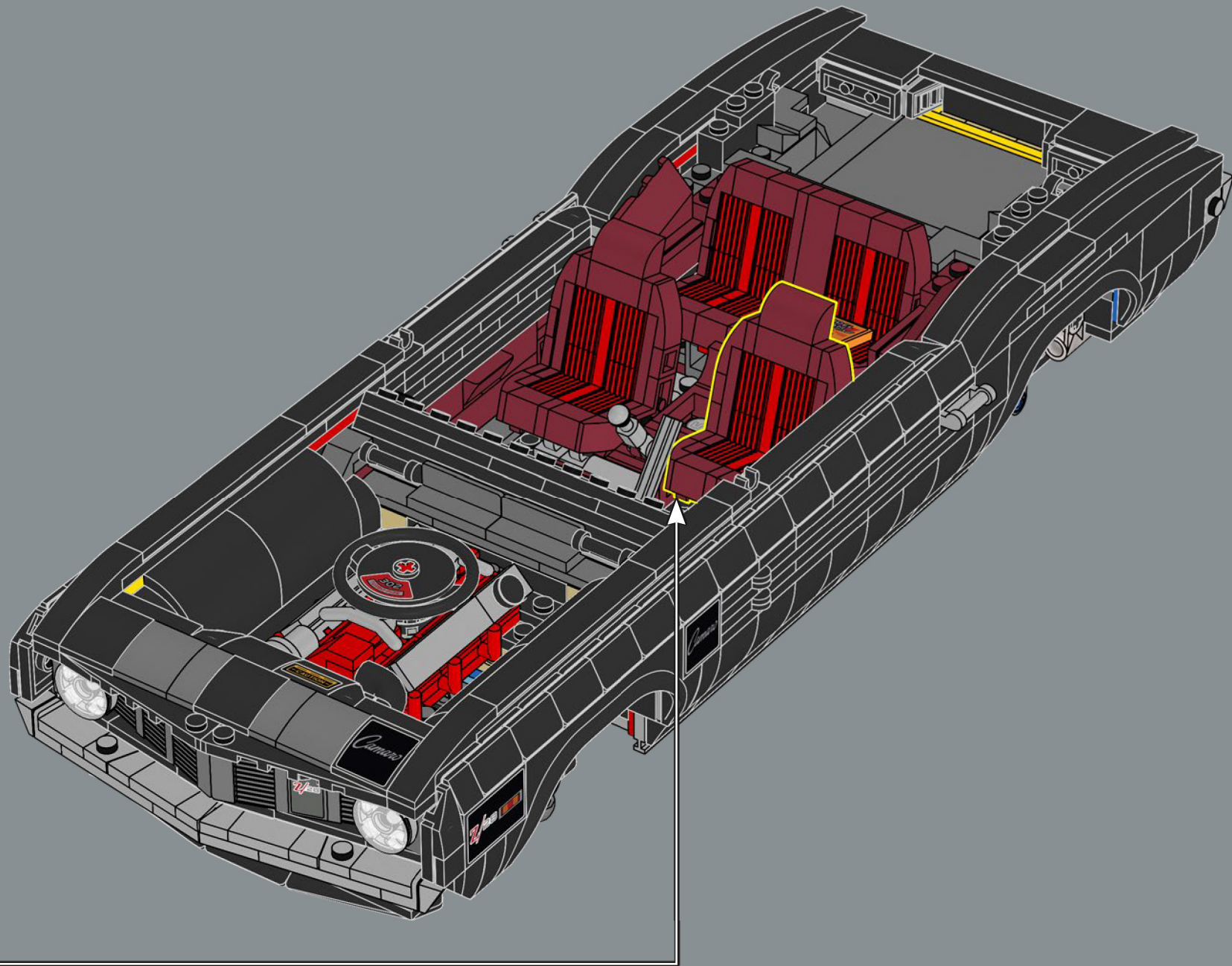

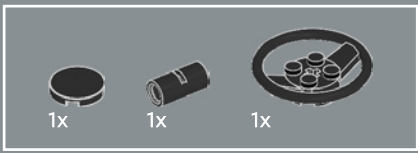

301

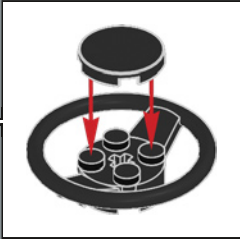
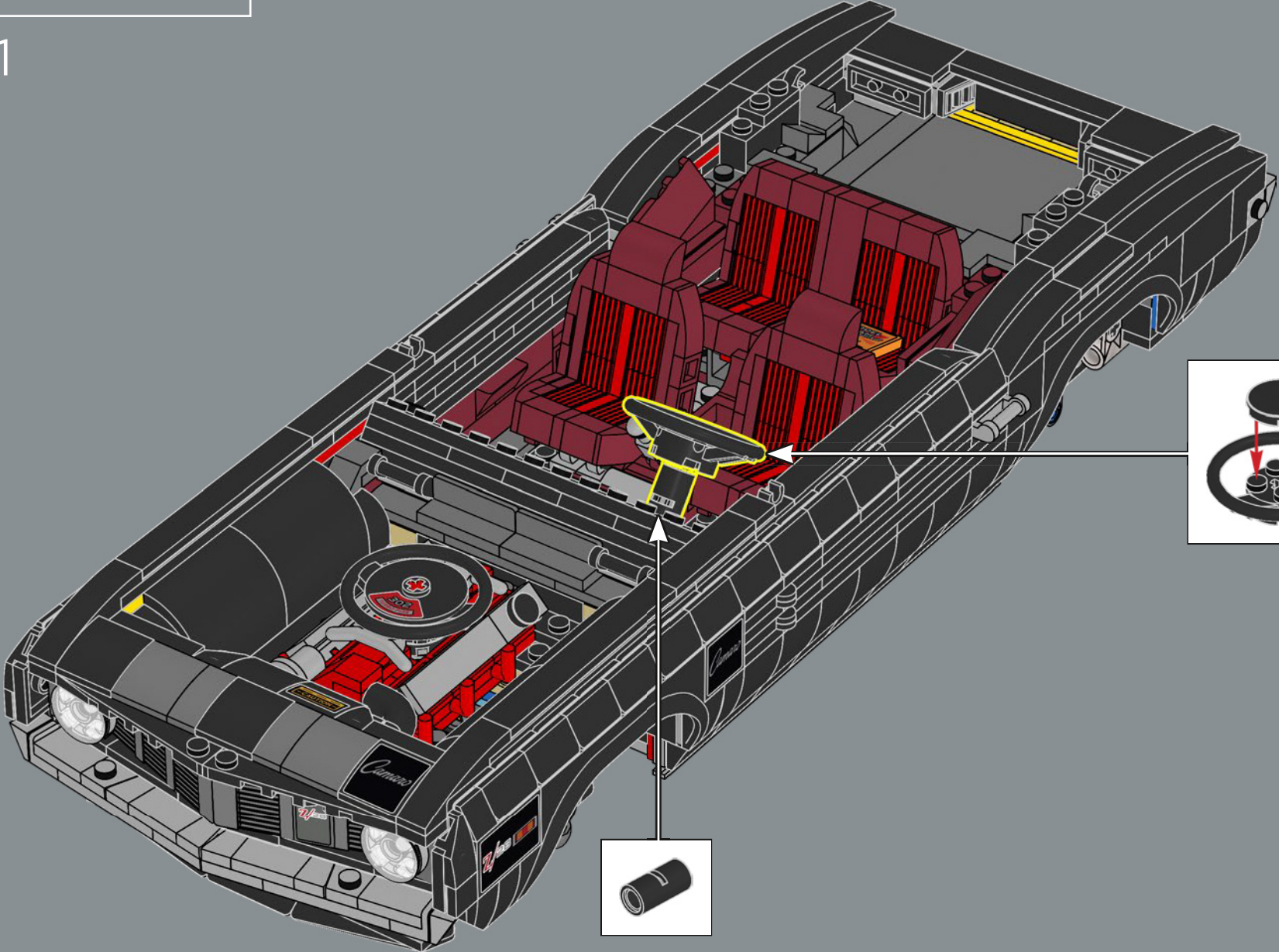

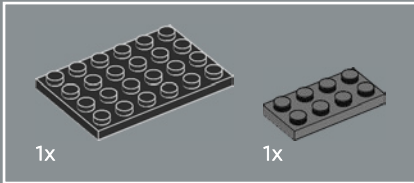
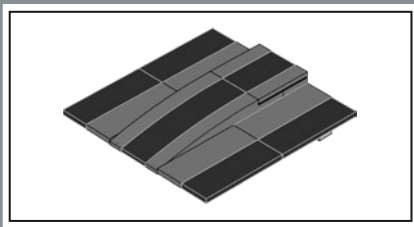

302

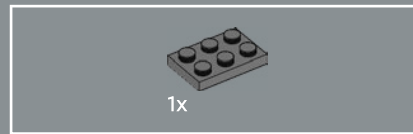
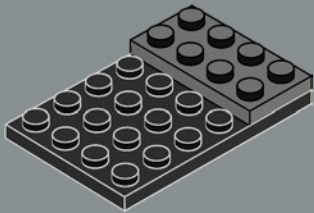

303

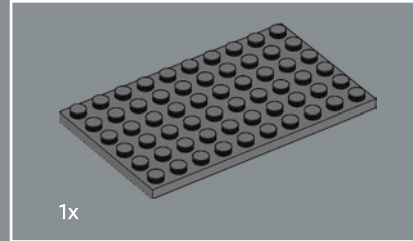
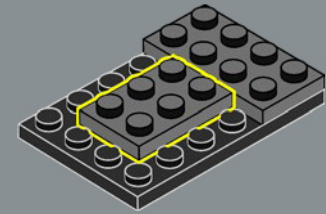

304

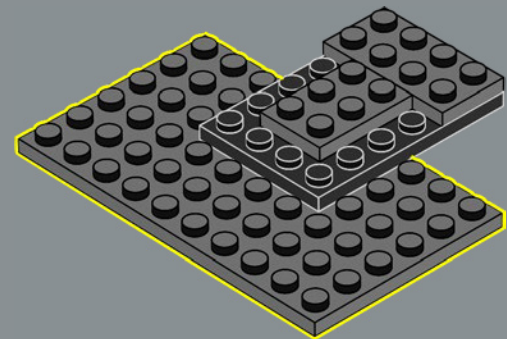

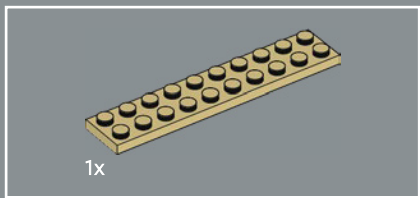

305

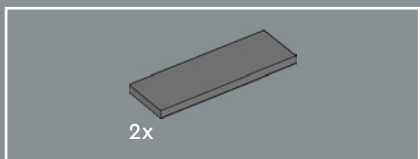
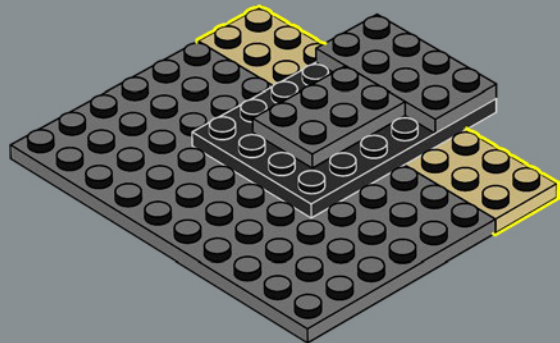

306

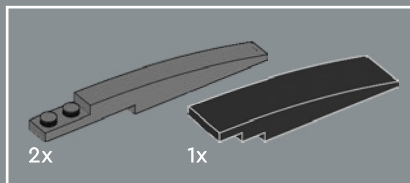
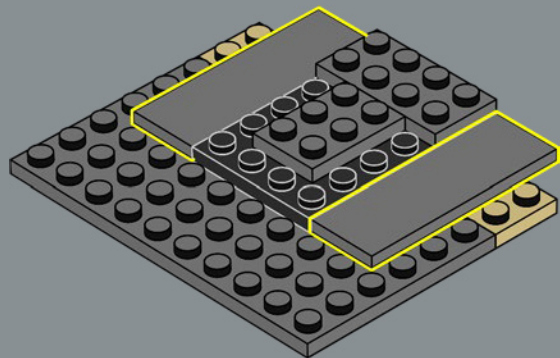

307

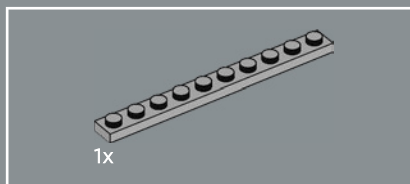
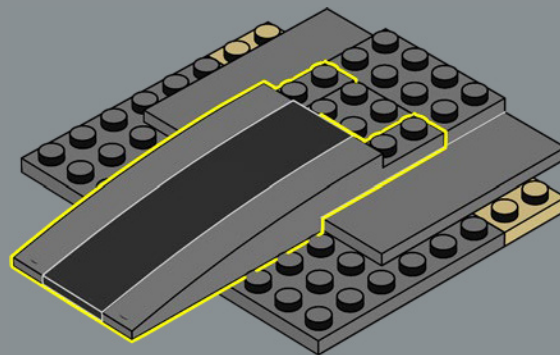

308

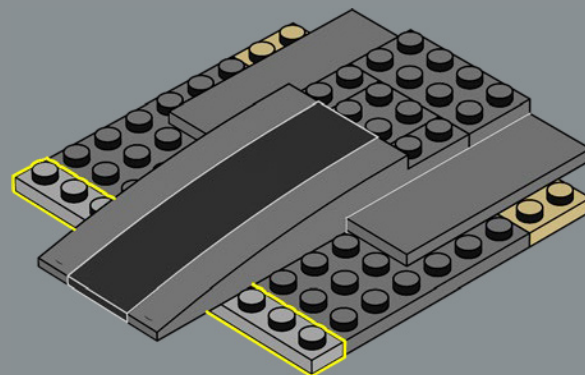

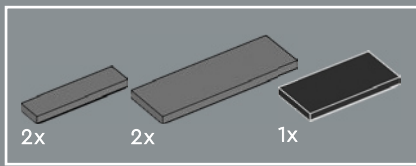

309

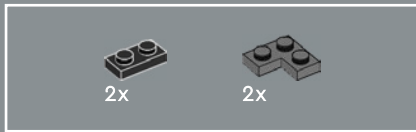
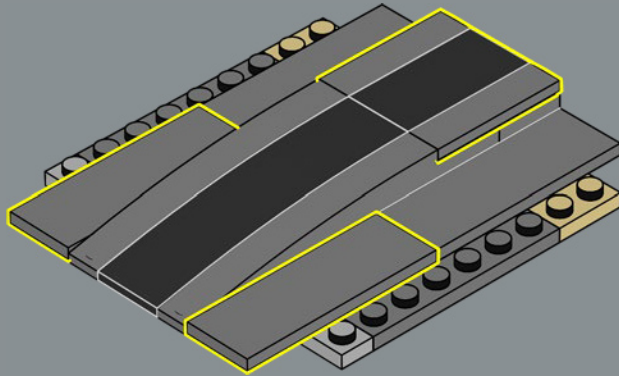

310

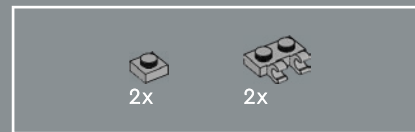
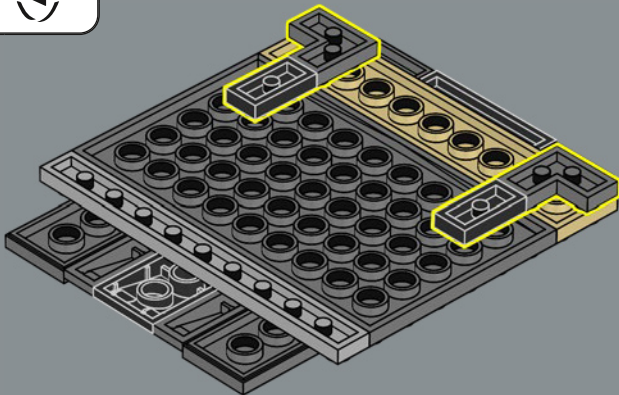

311

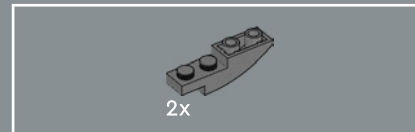
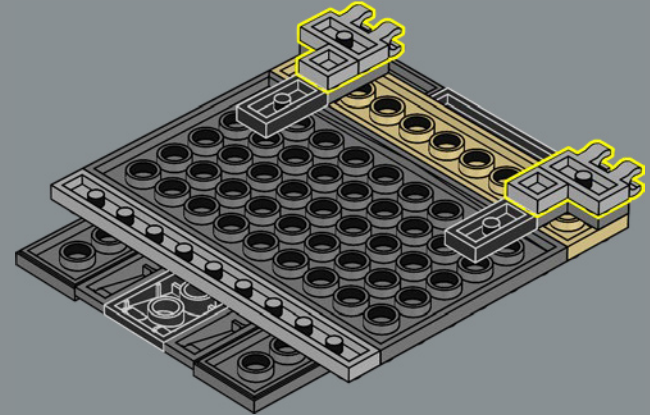

312

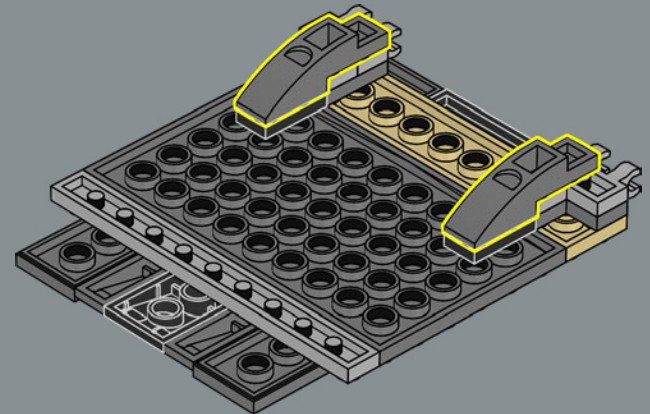

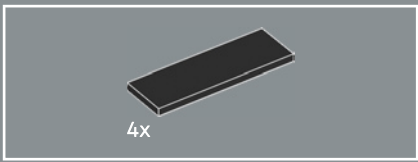

313

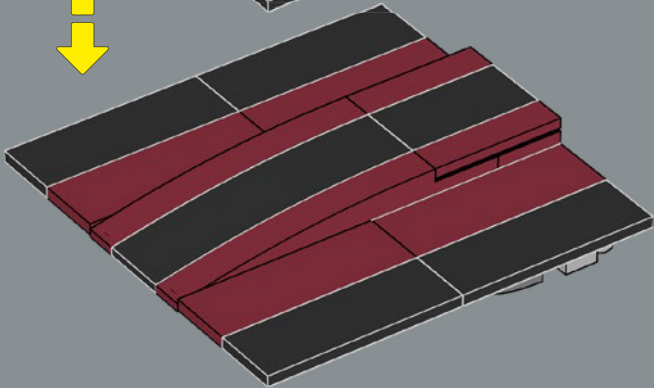
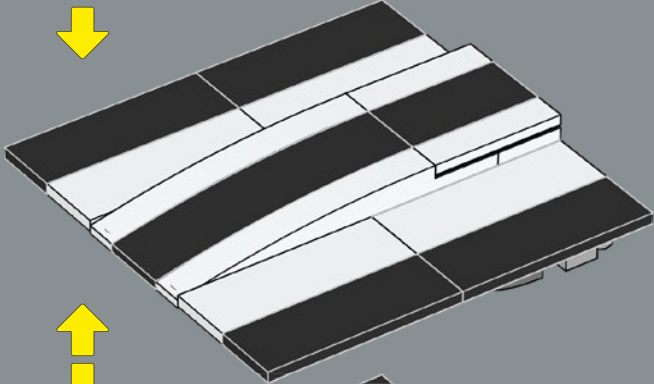
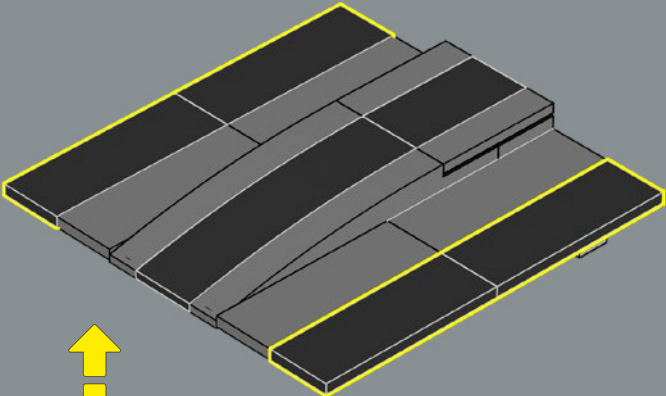

314

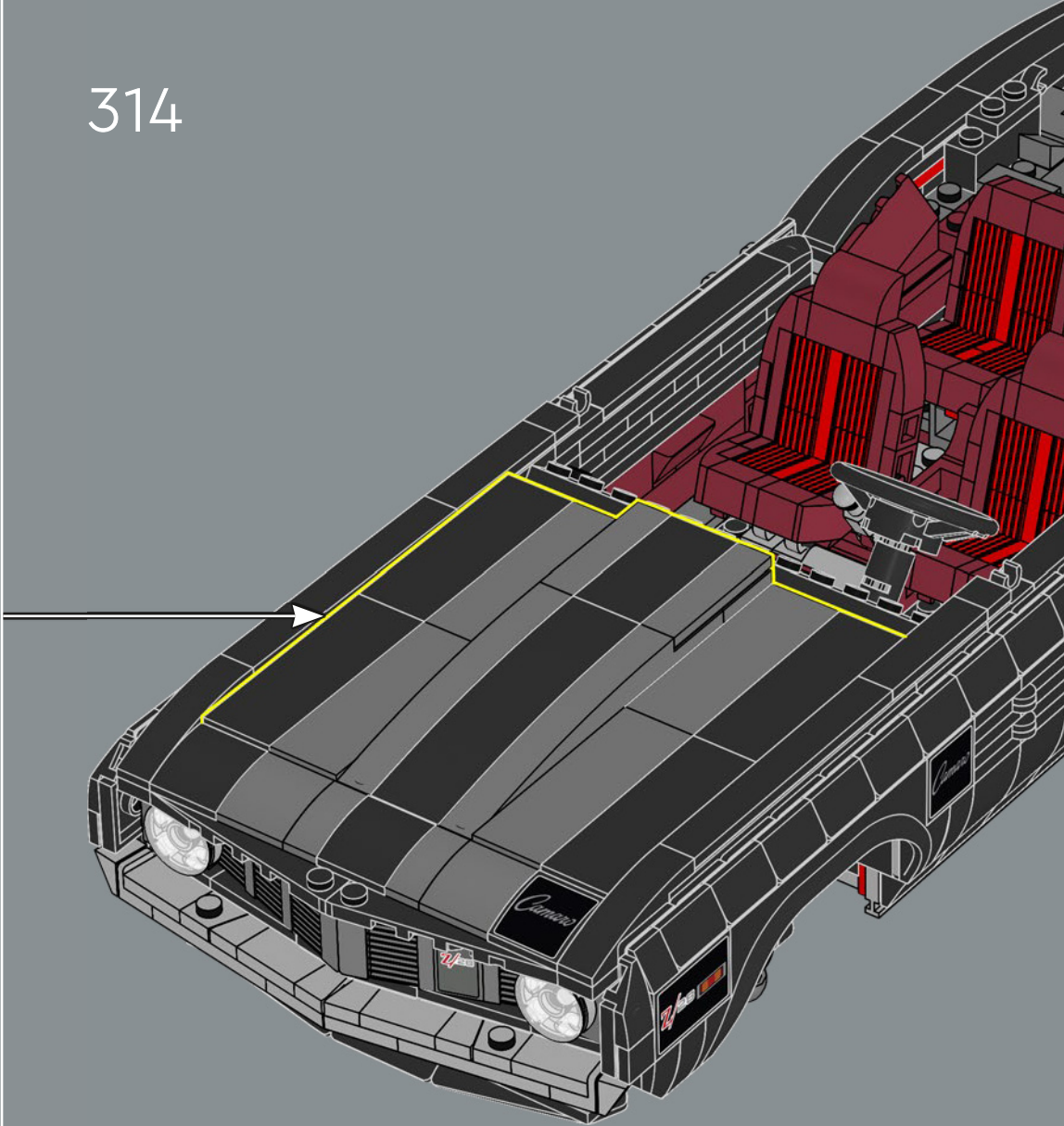

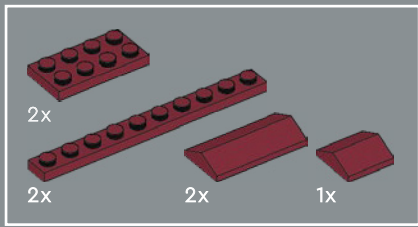

315

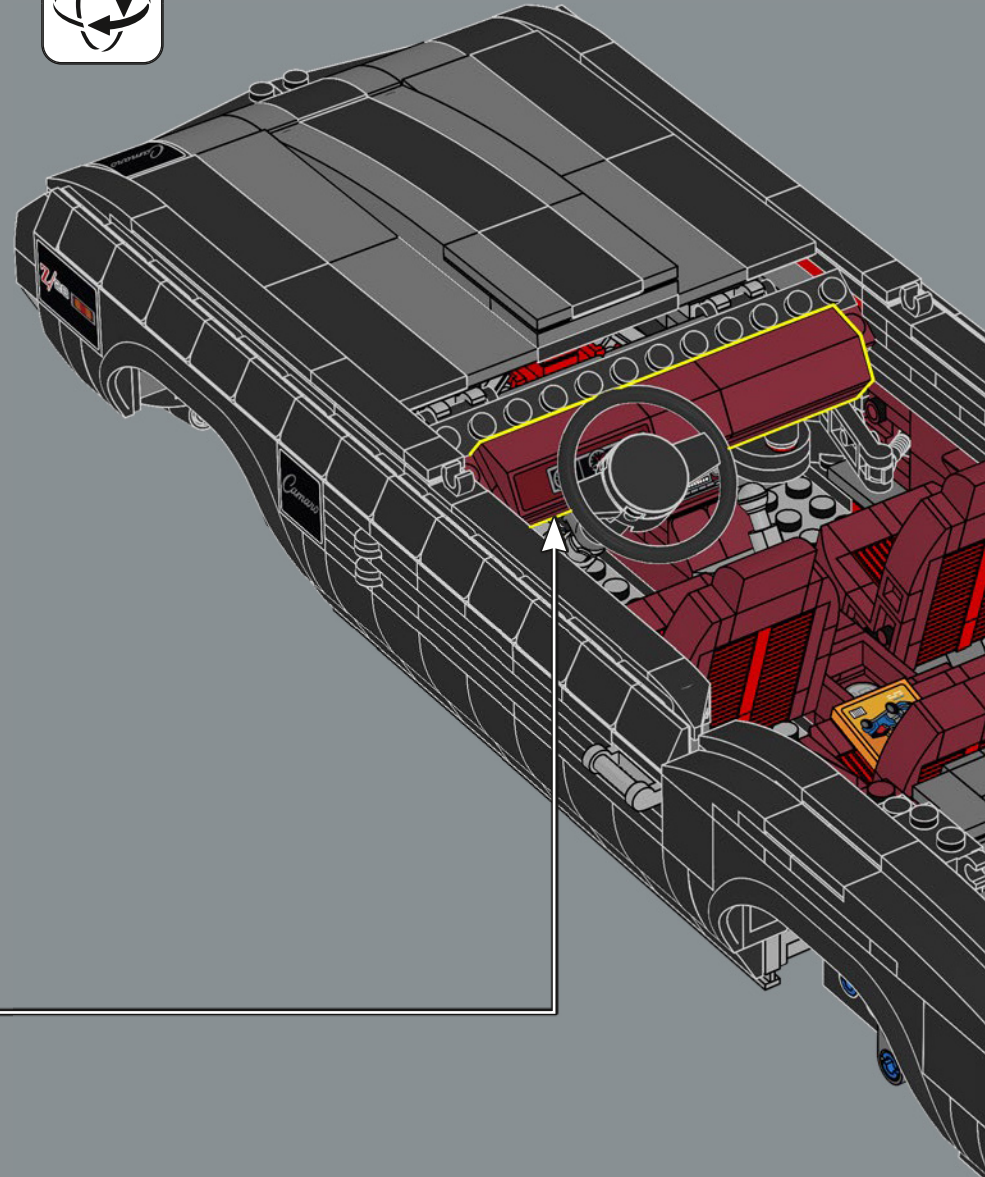
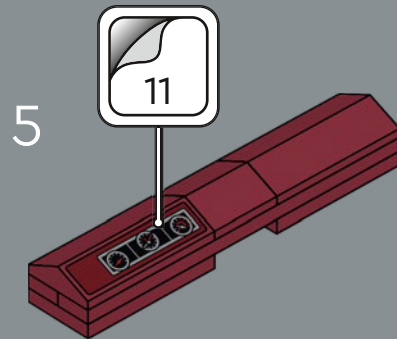
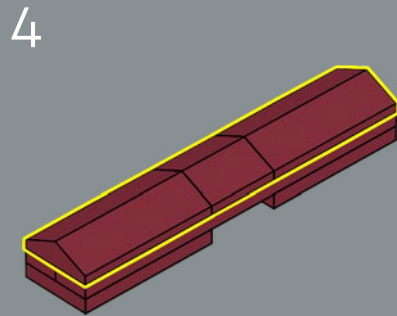
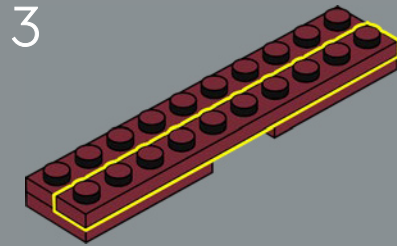
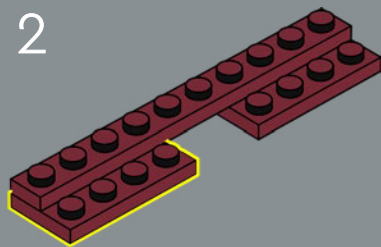
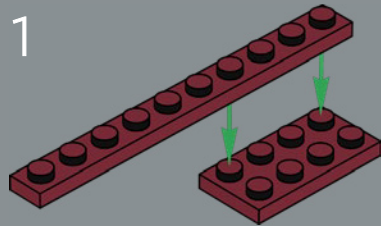

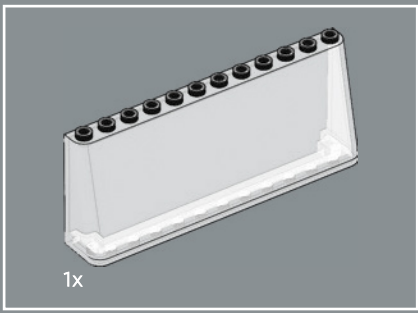

316

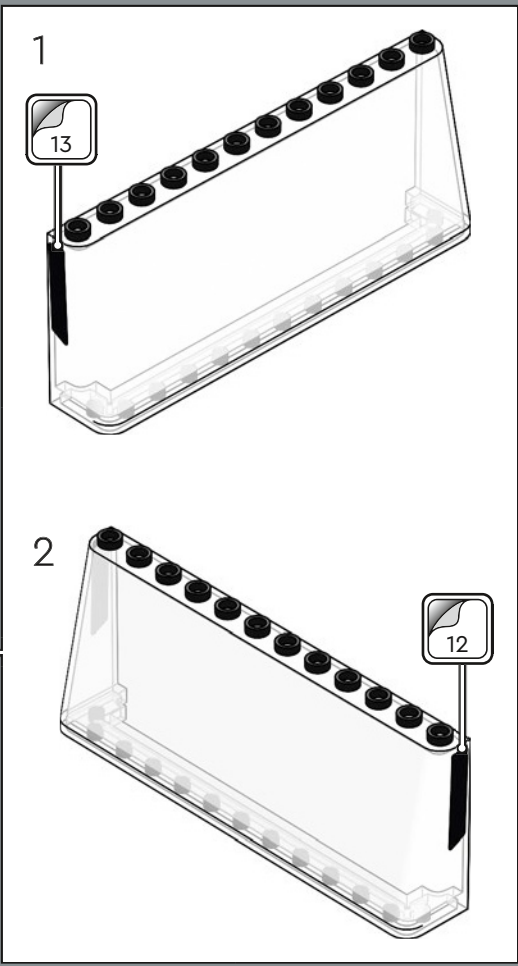
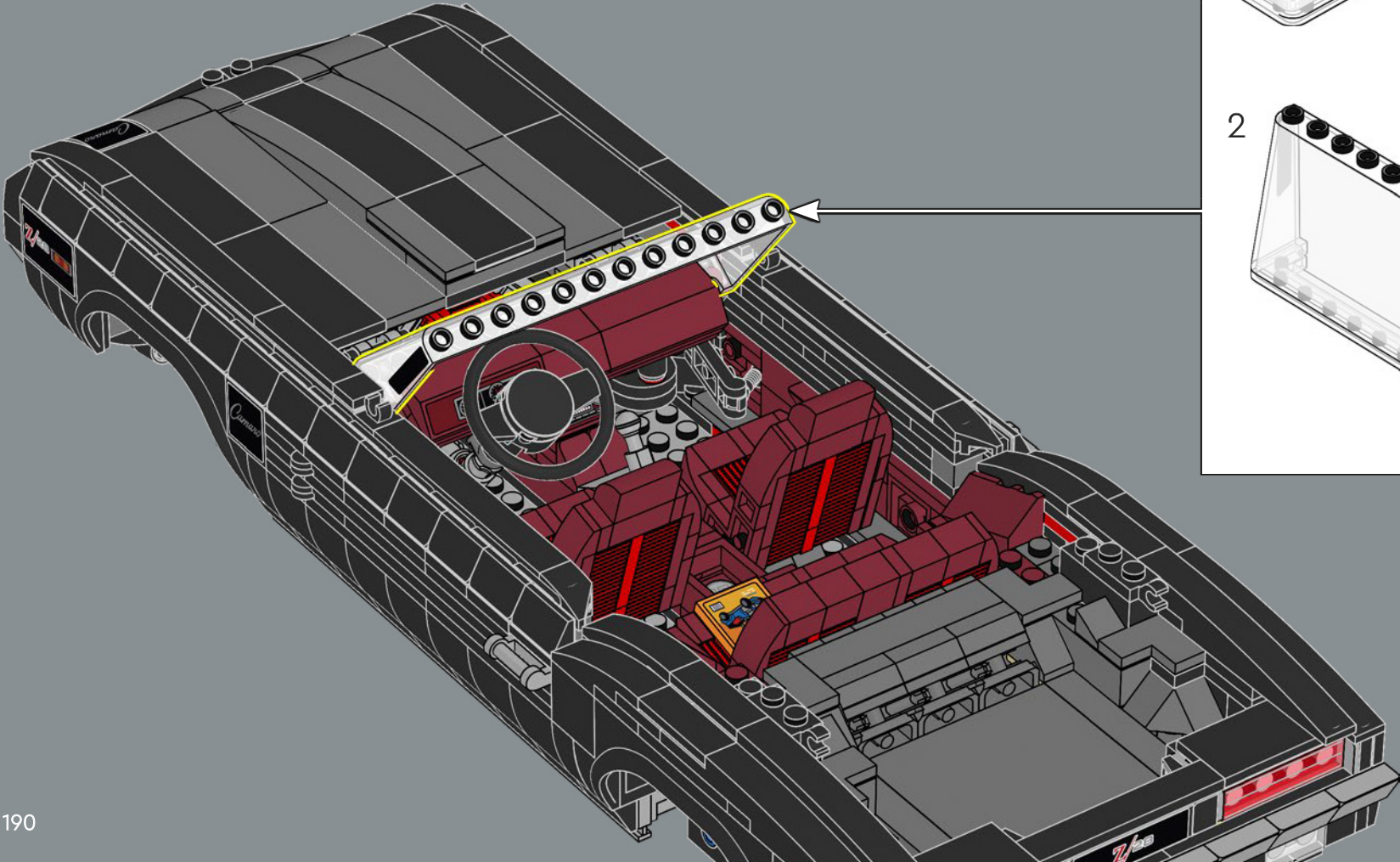

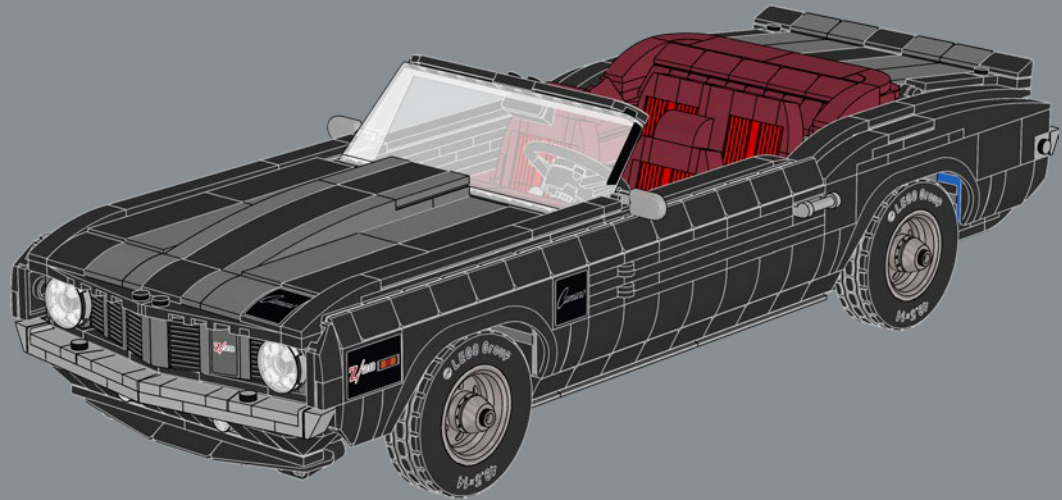
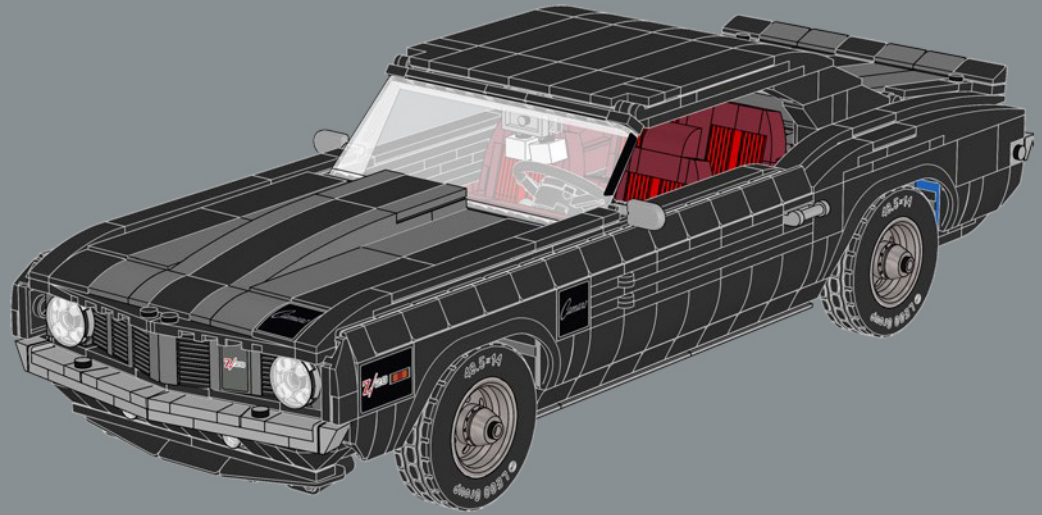

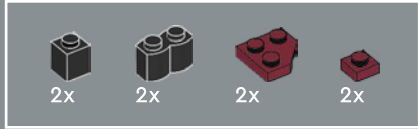
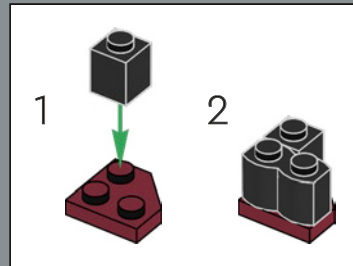

317

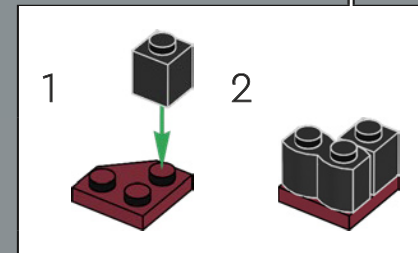
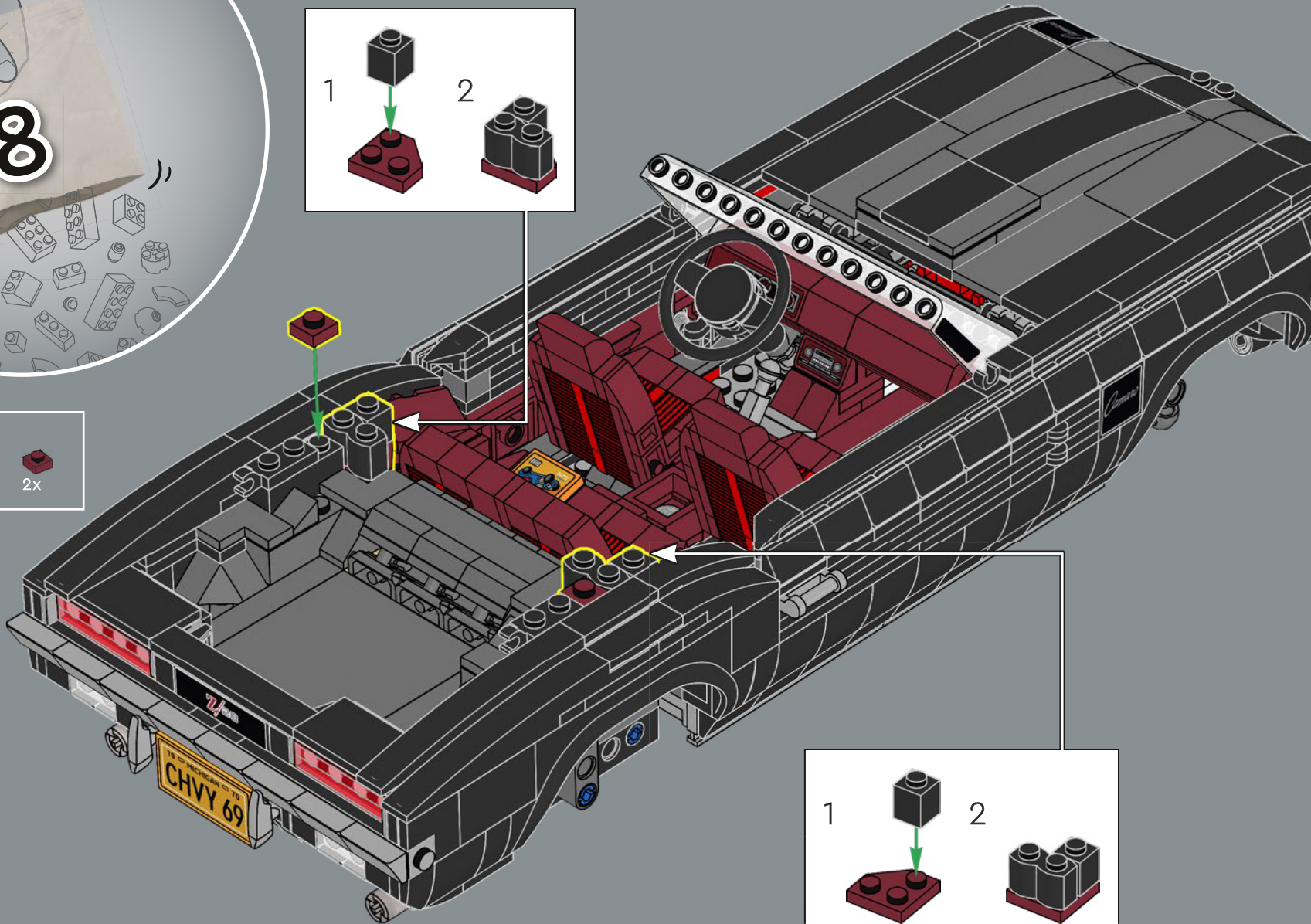

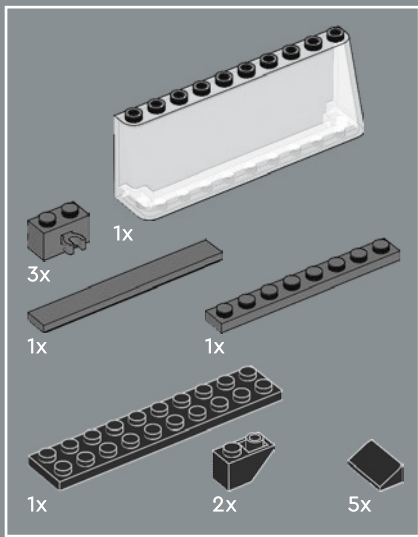

318

1

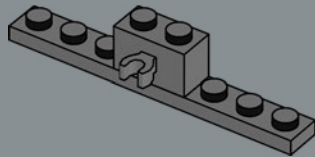

2

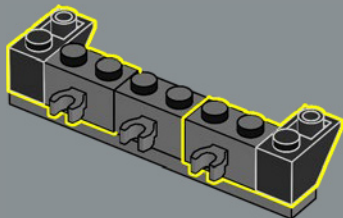

3

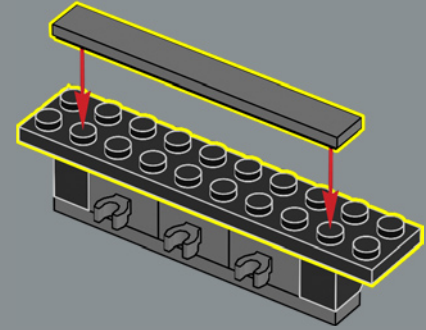

4

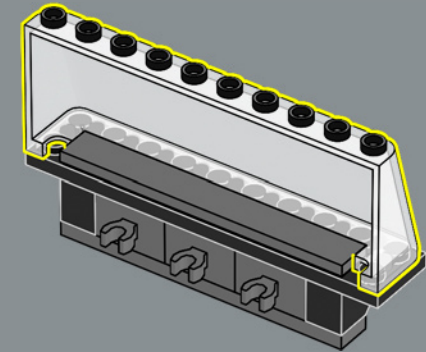

5

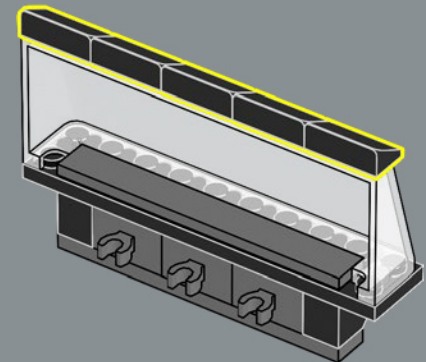

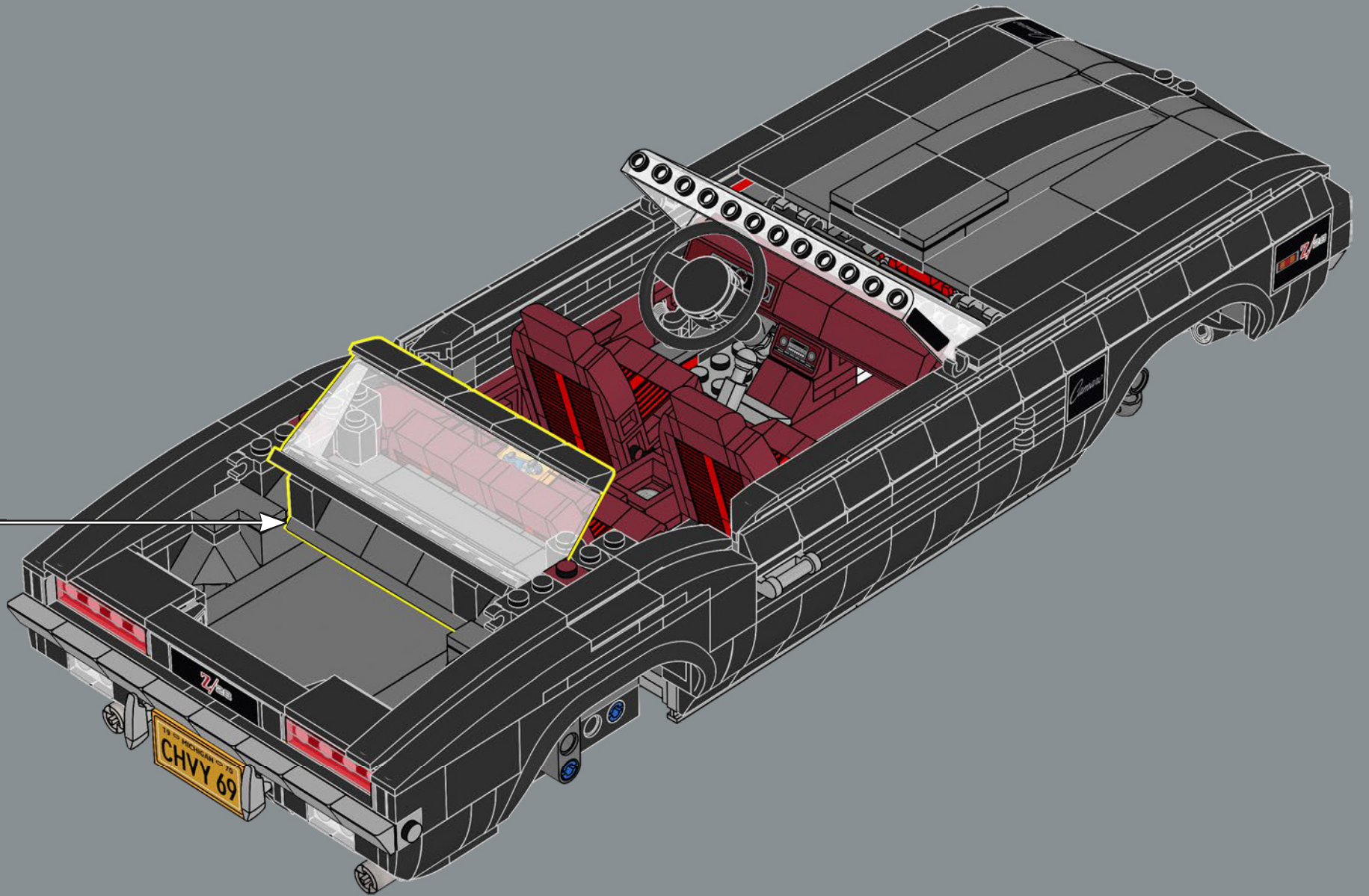

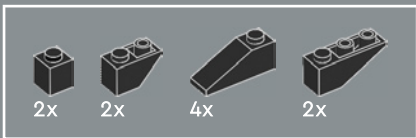

319

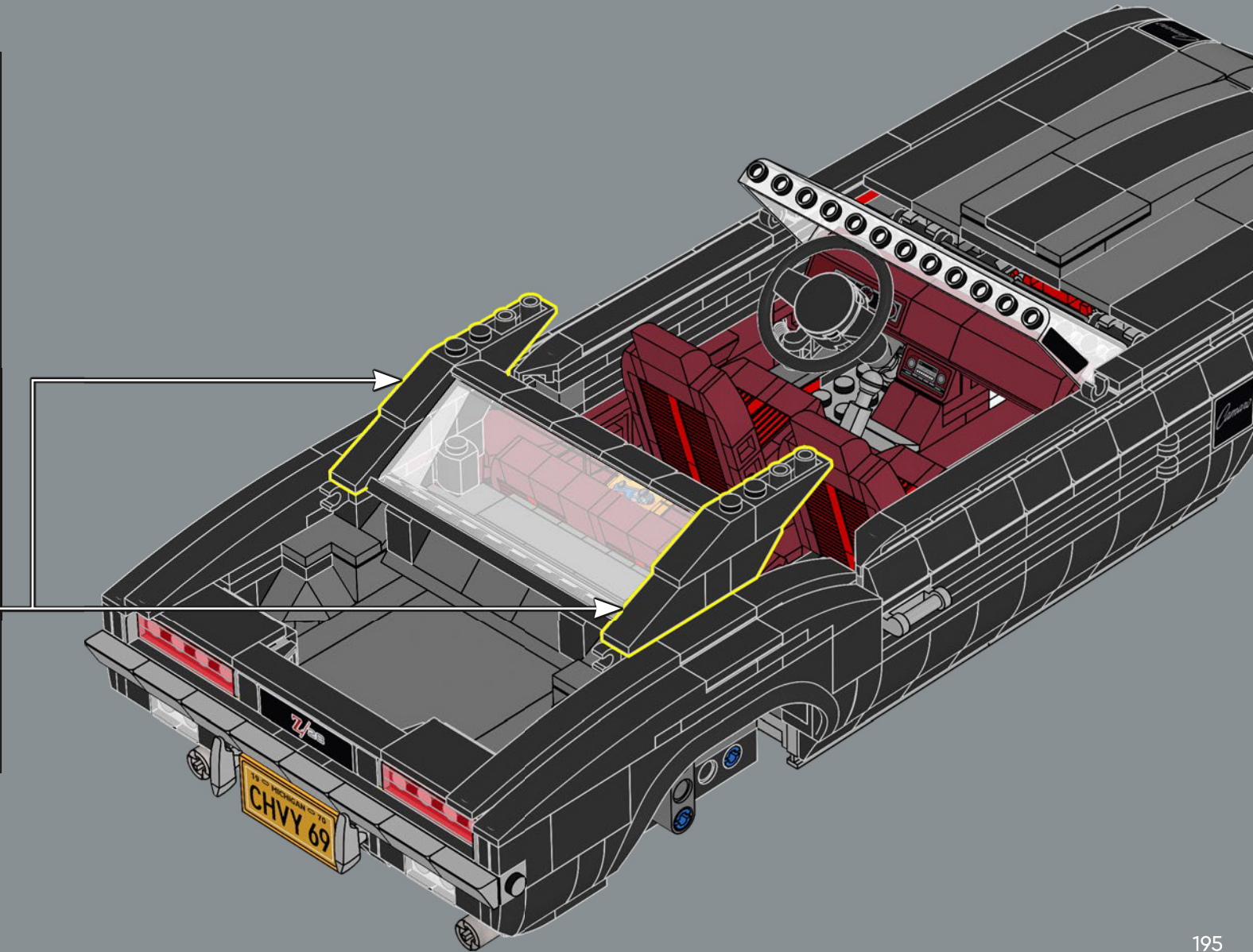
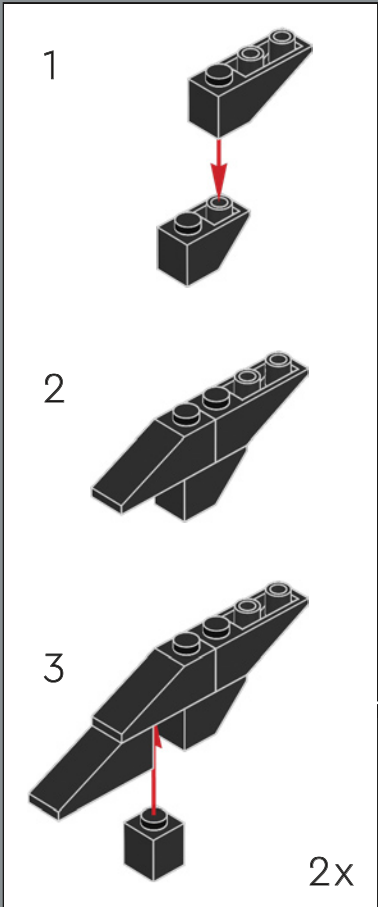

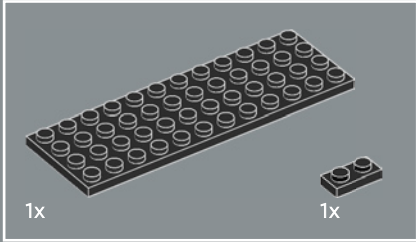
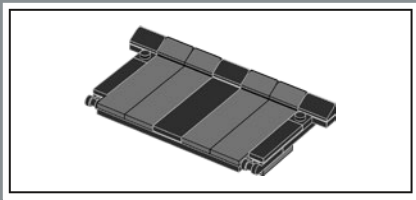

320

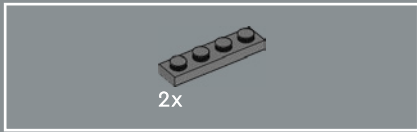
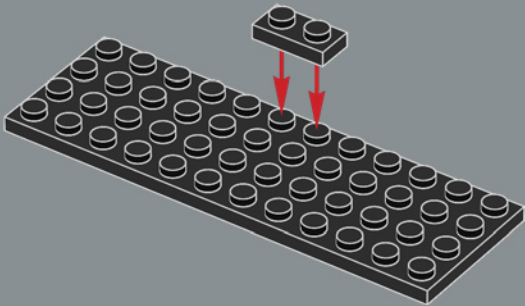

321

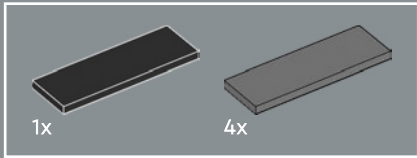
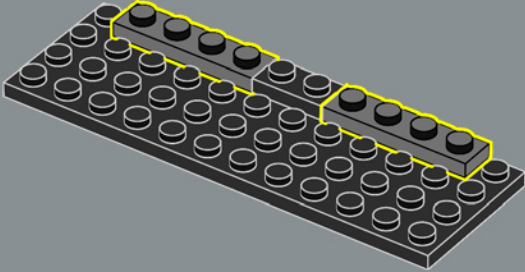

322

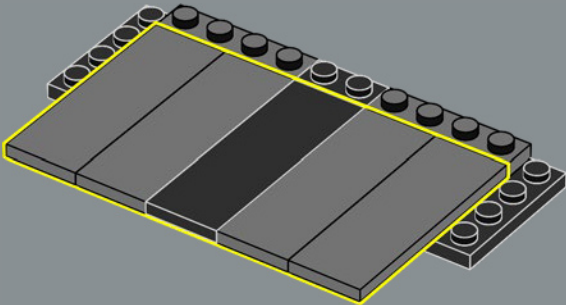

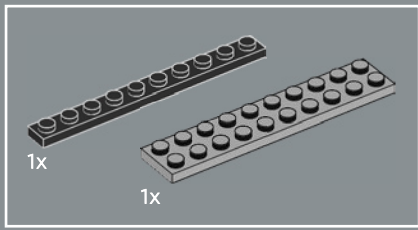

323

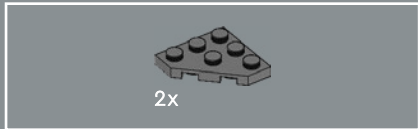
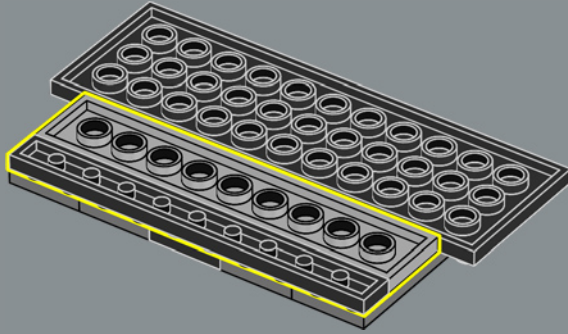

324

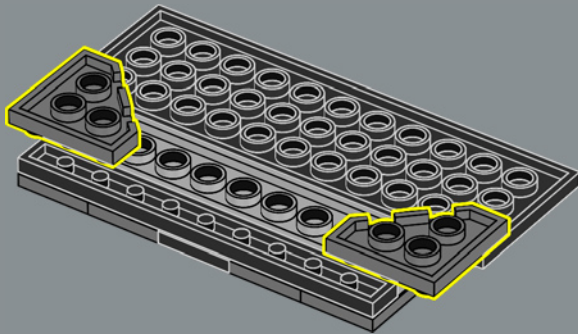

325

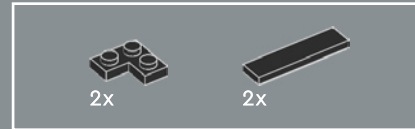
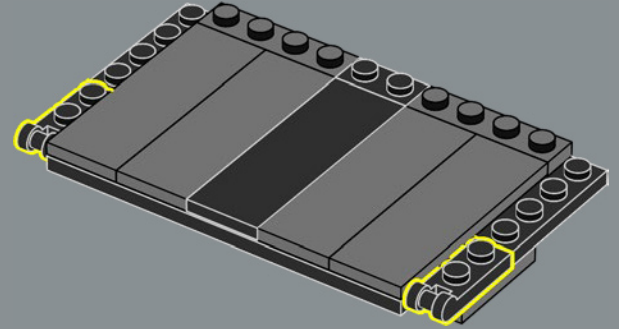

326

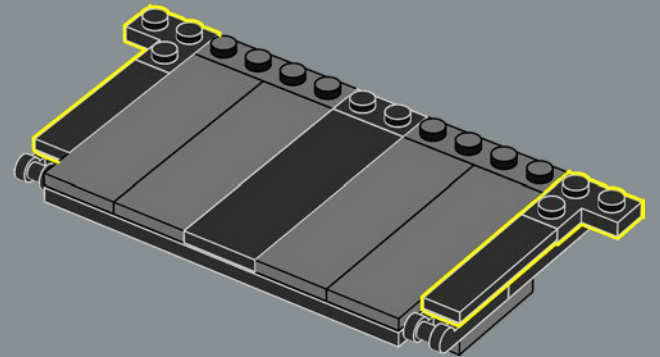

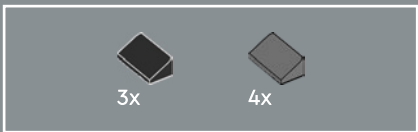

327

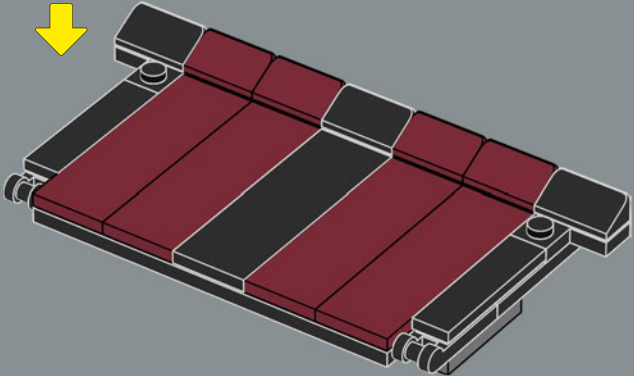
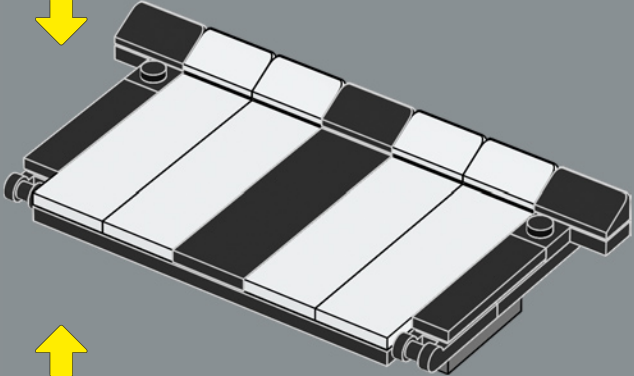
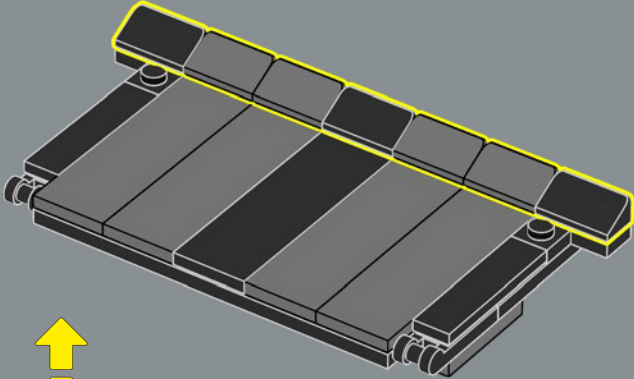

328

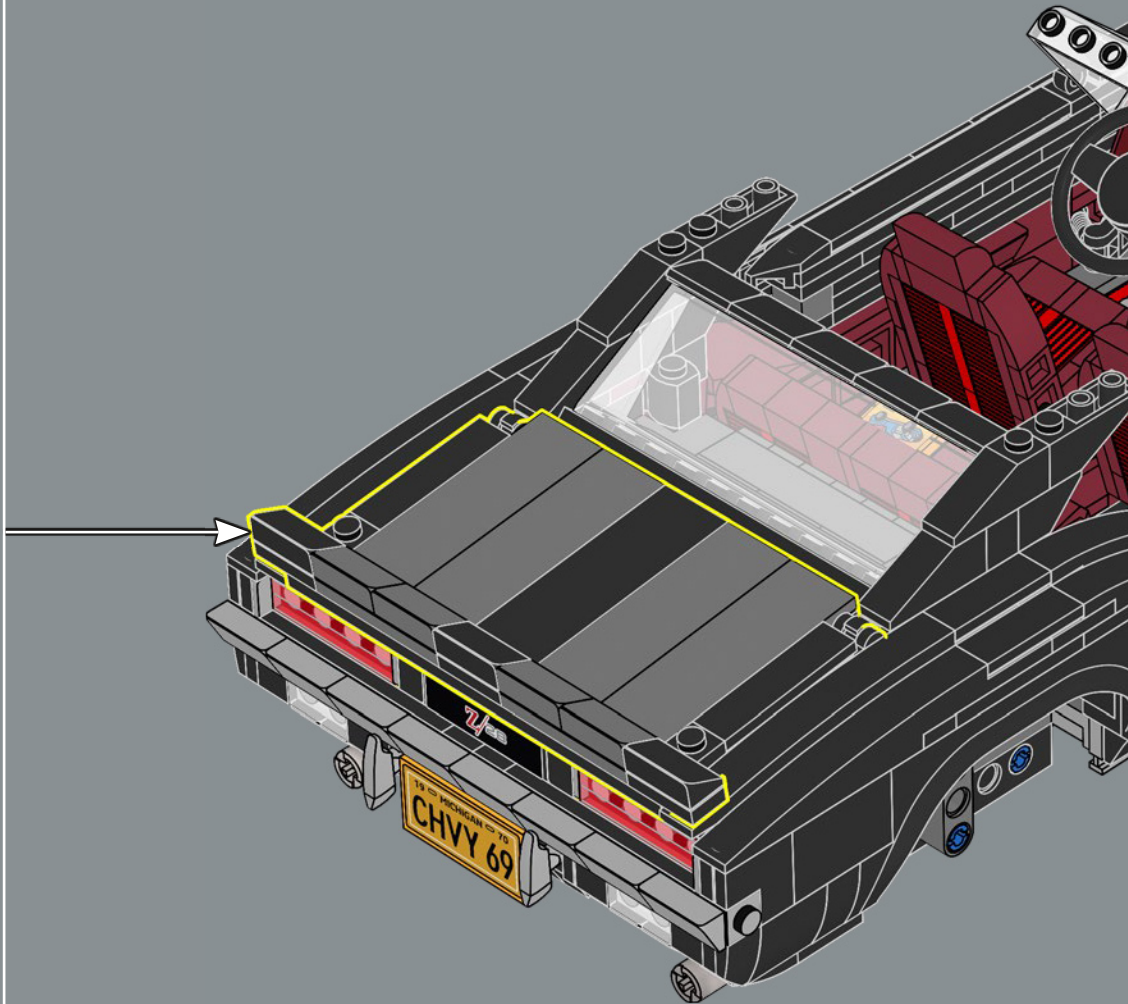

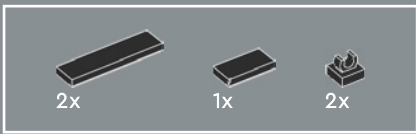

329

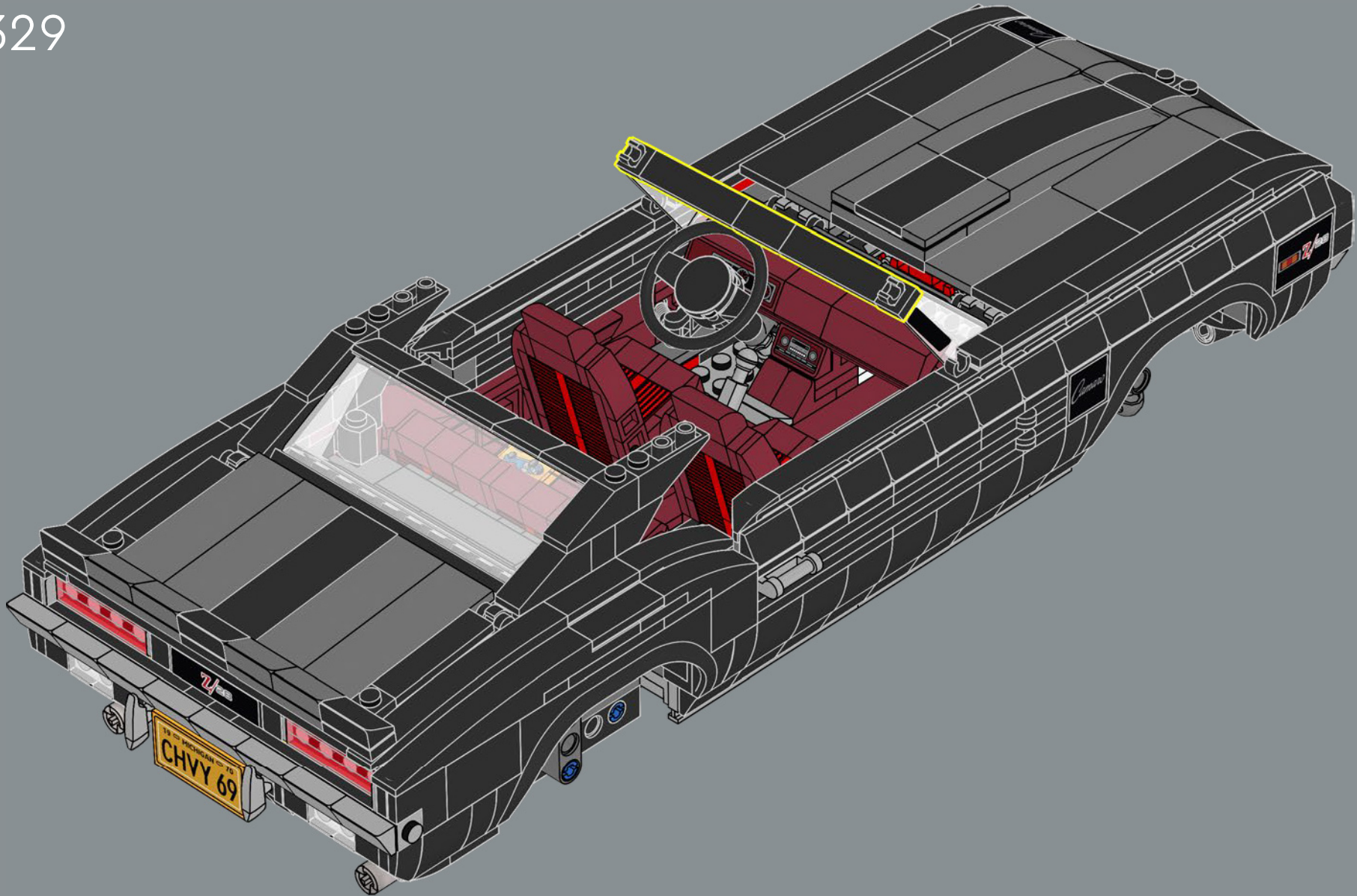

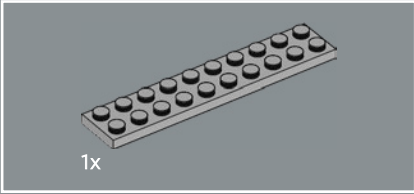
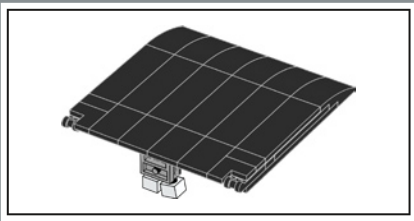

330

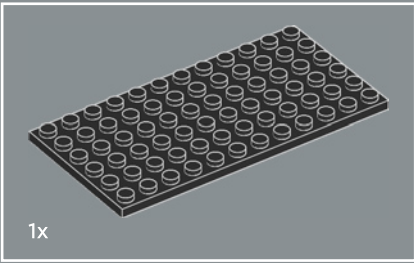
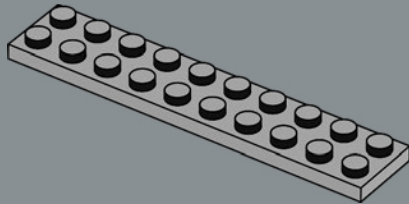

331

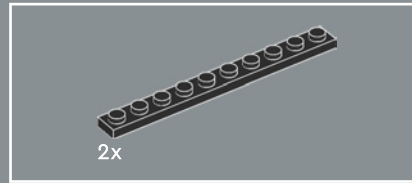
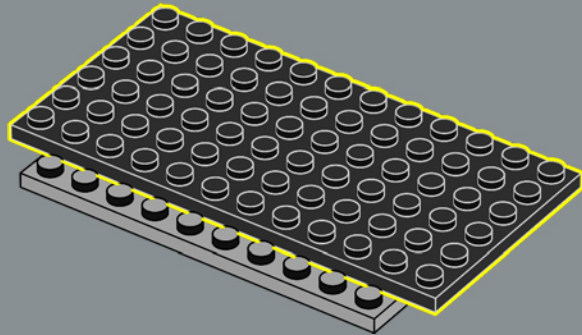

2x

332

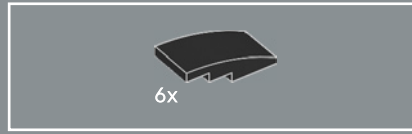
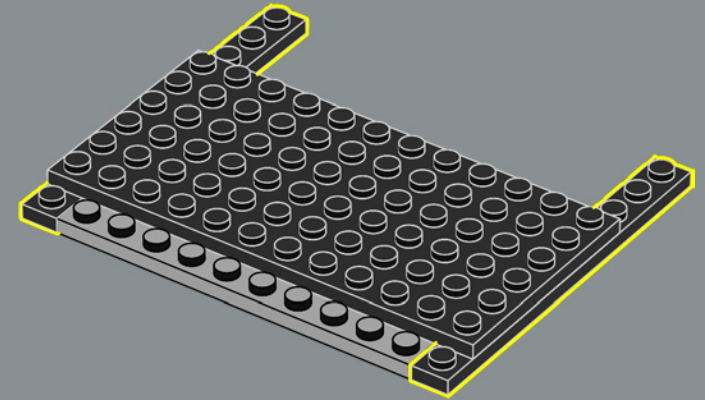

6x

333

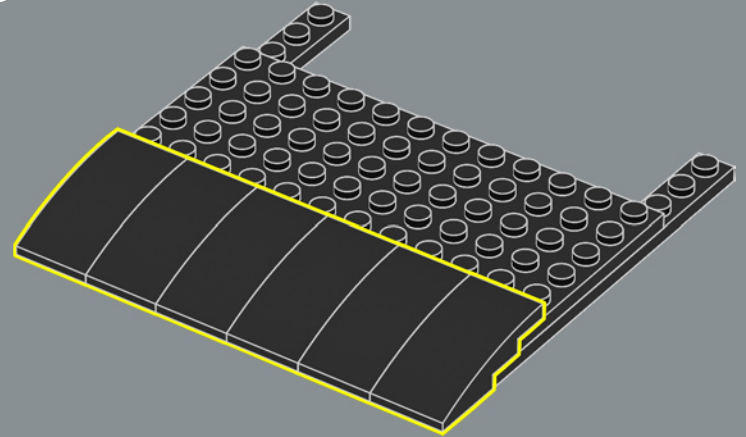

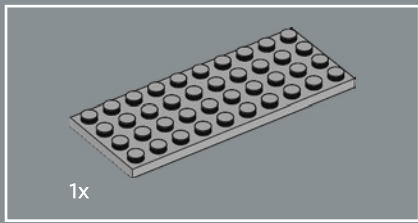

1x

334

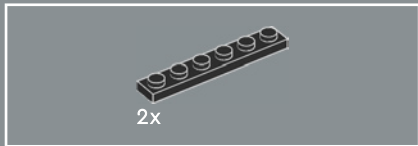
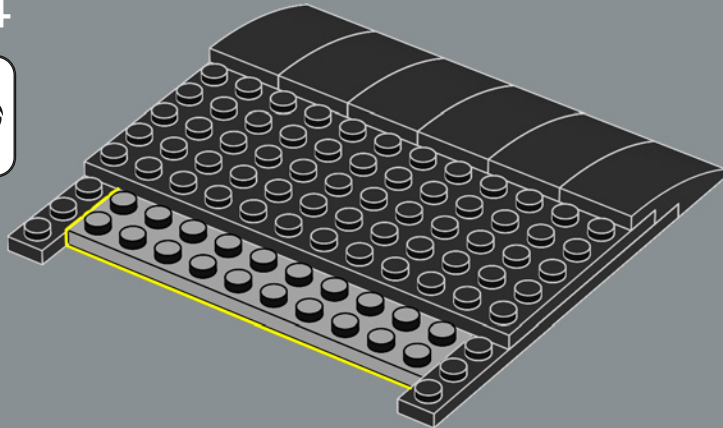

2x

335

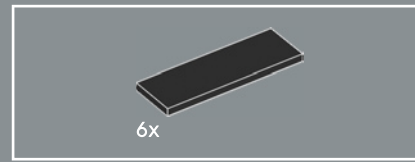
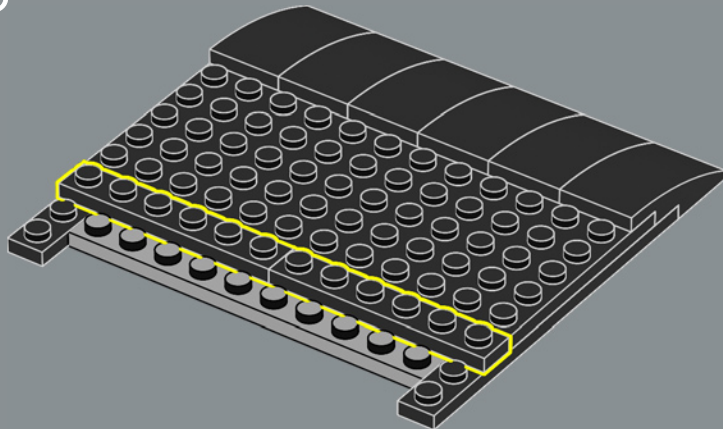

6x

336

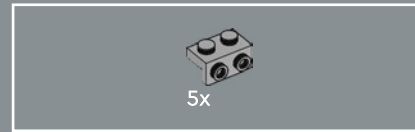
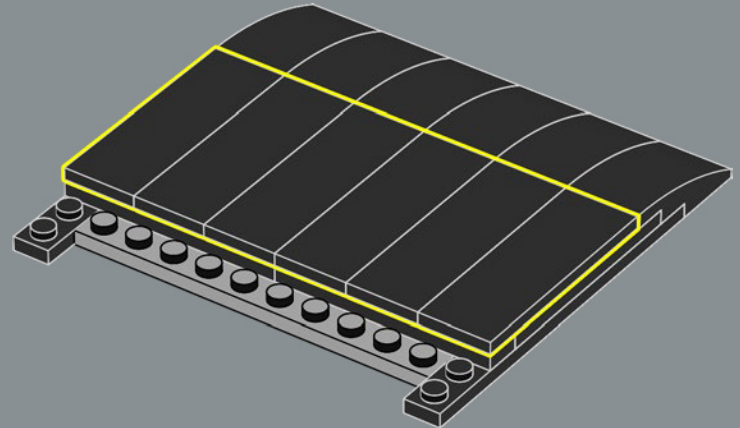

5x

337

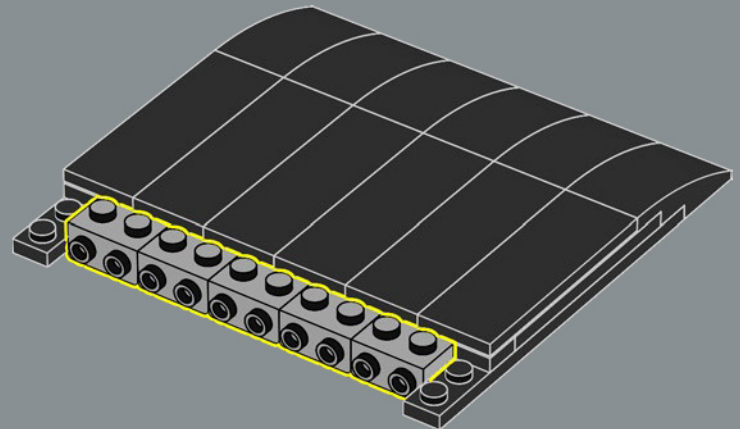

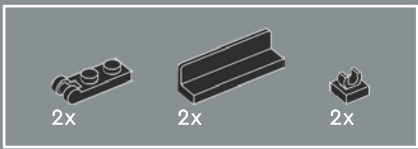

338

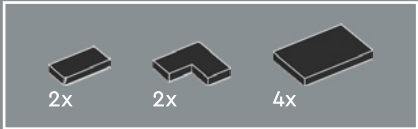
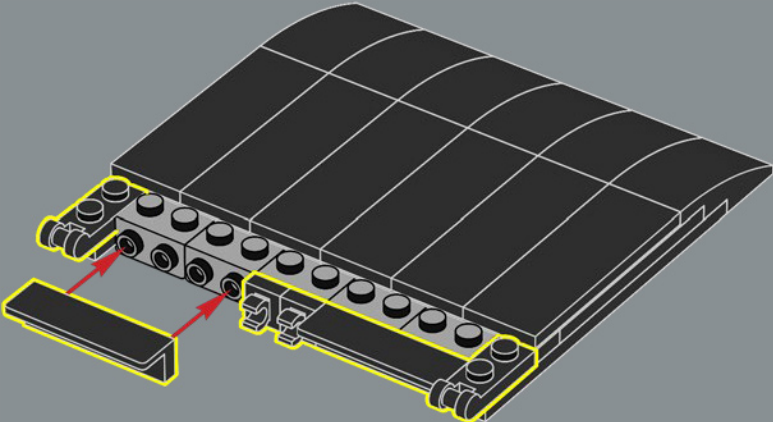

339

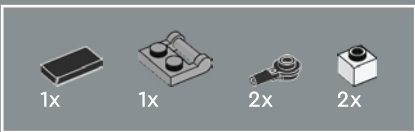
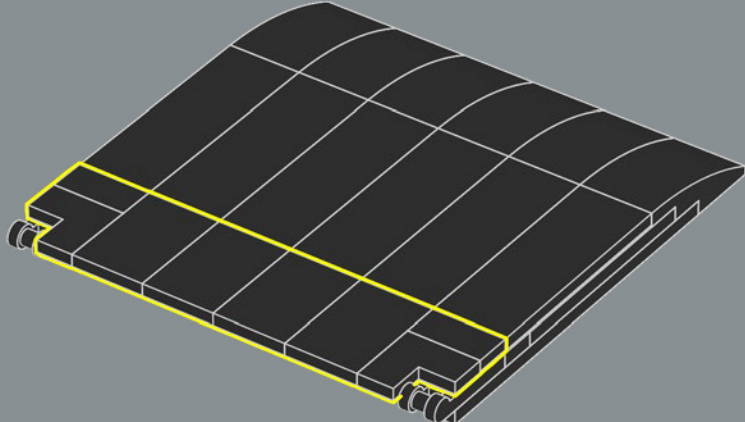

340

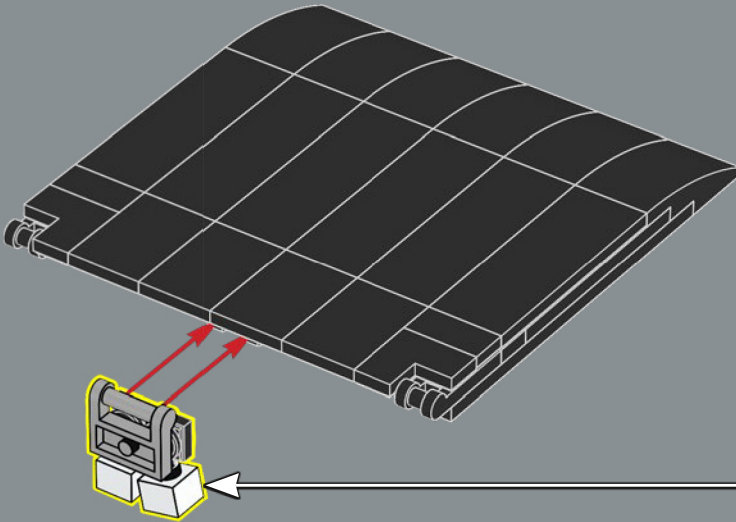
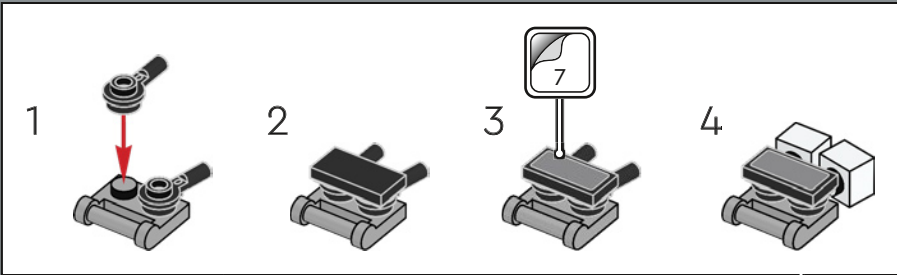

341

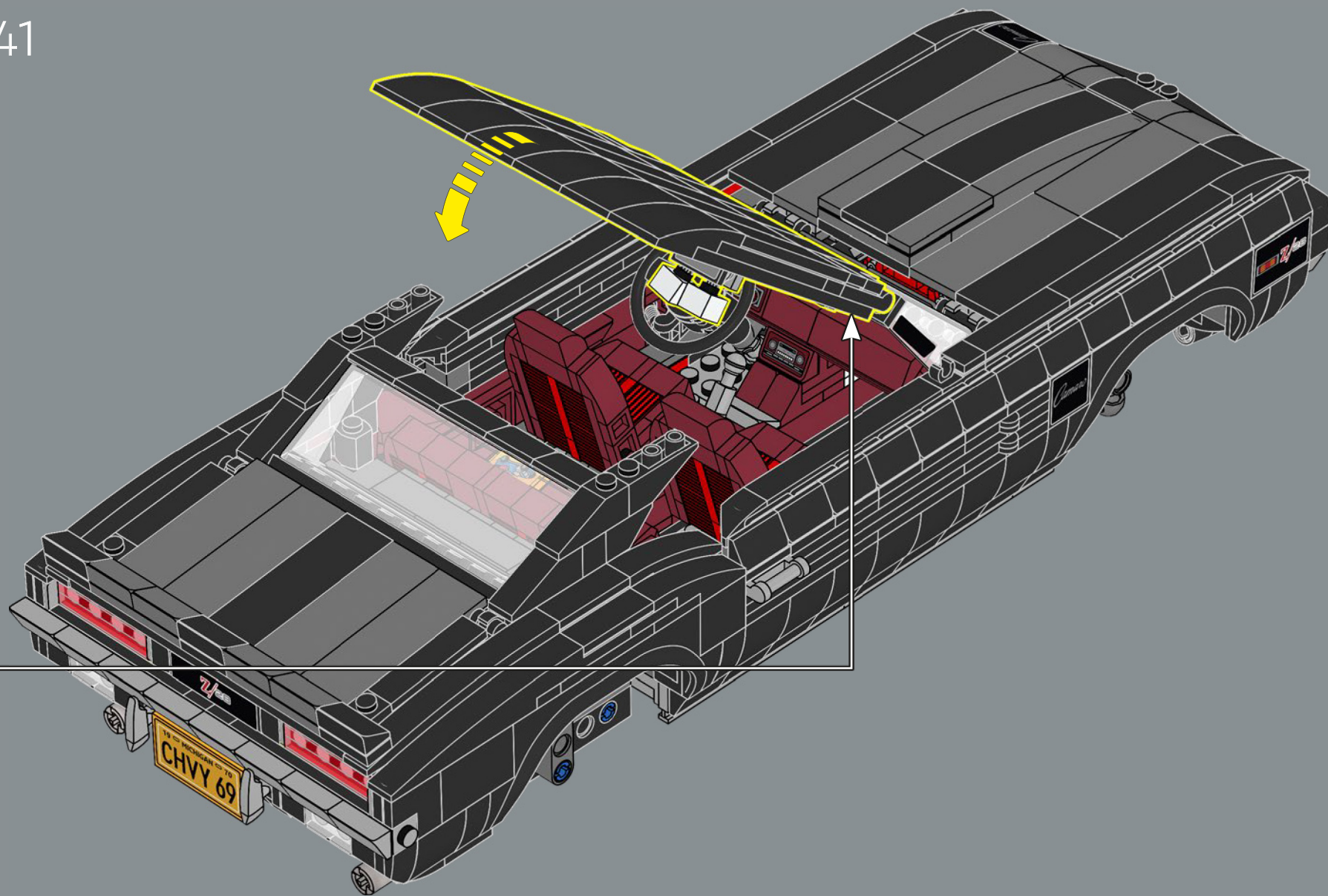

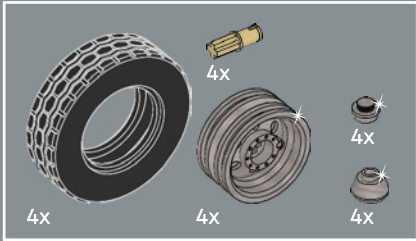
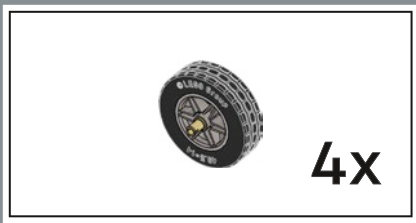

342

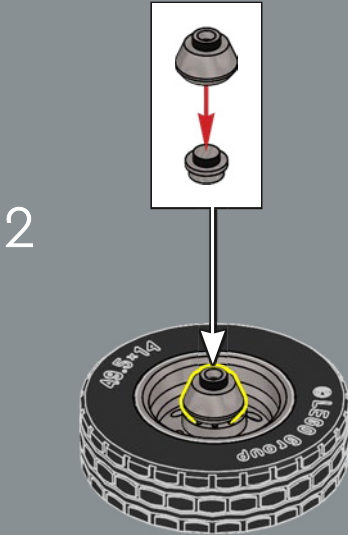
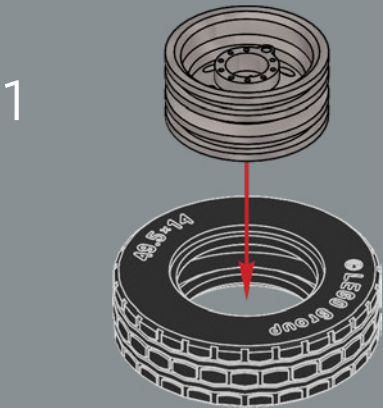

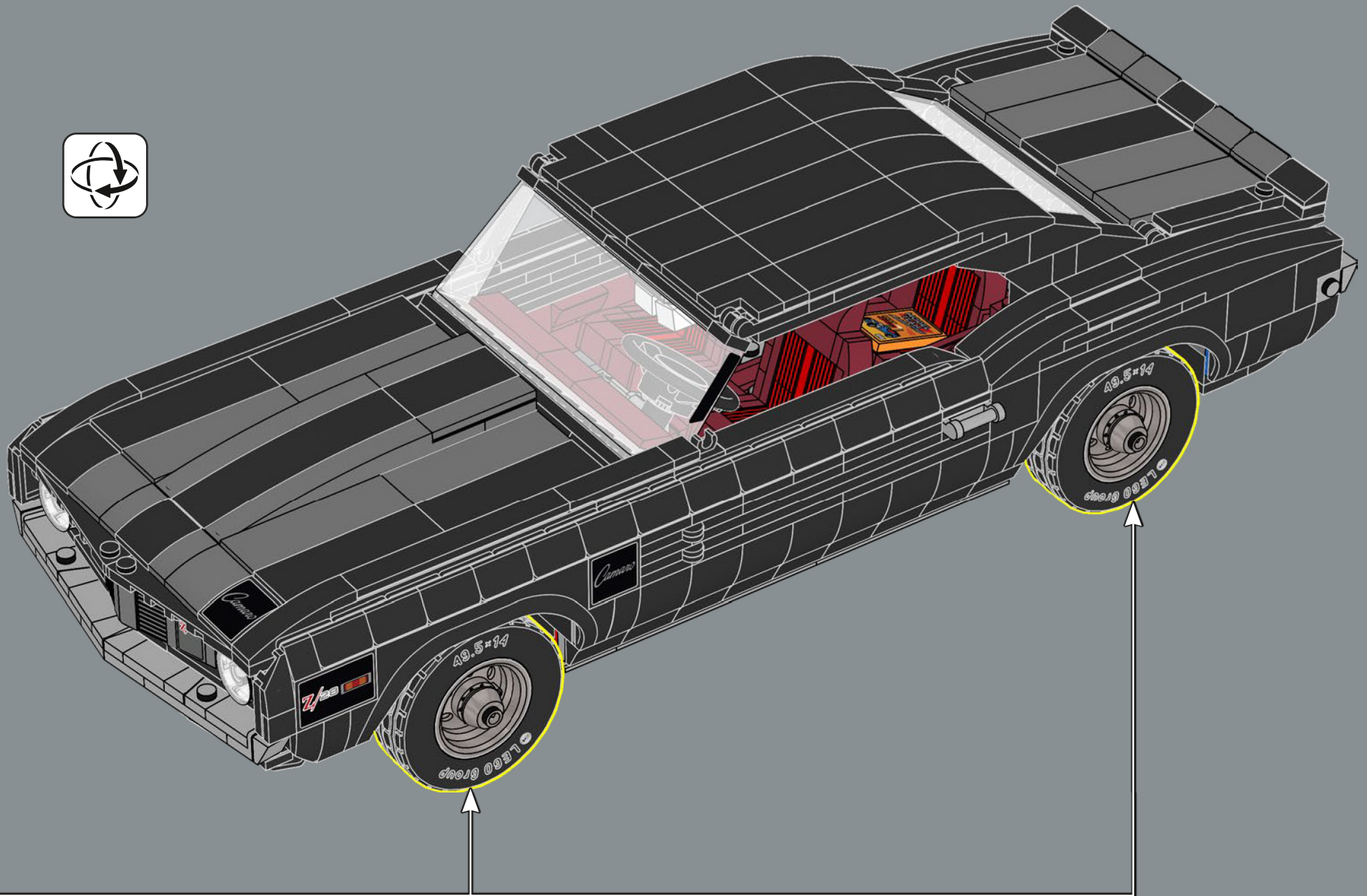



2x

343

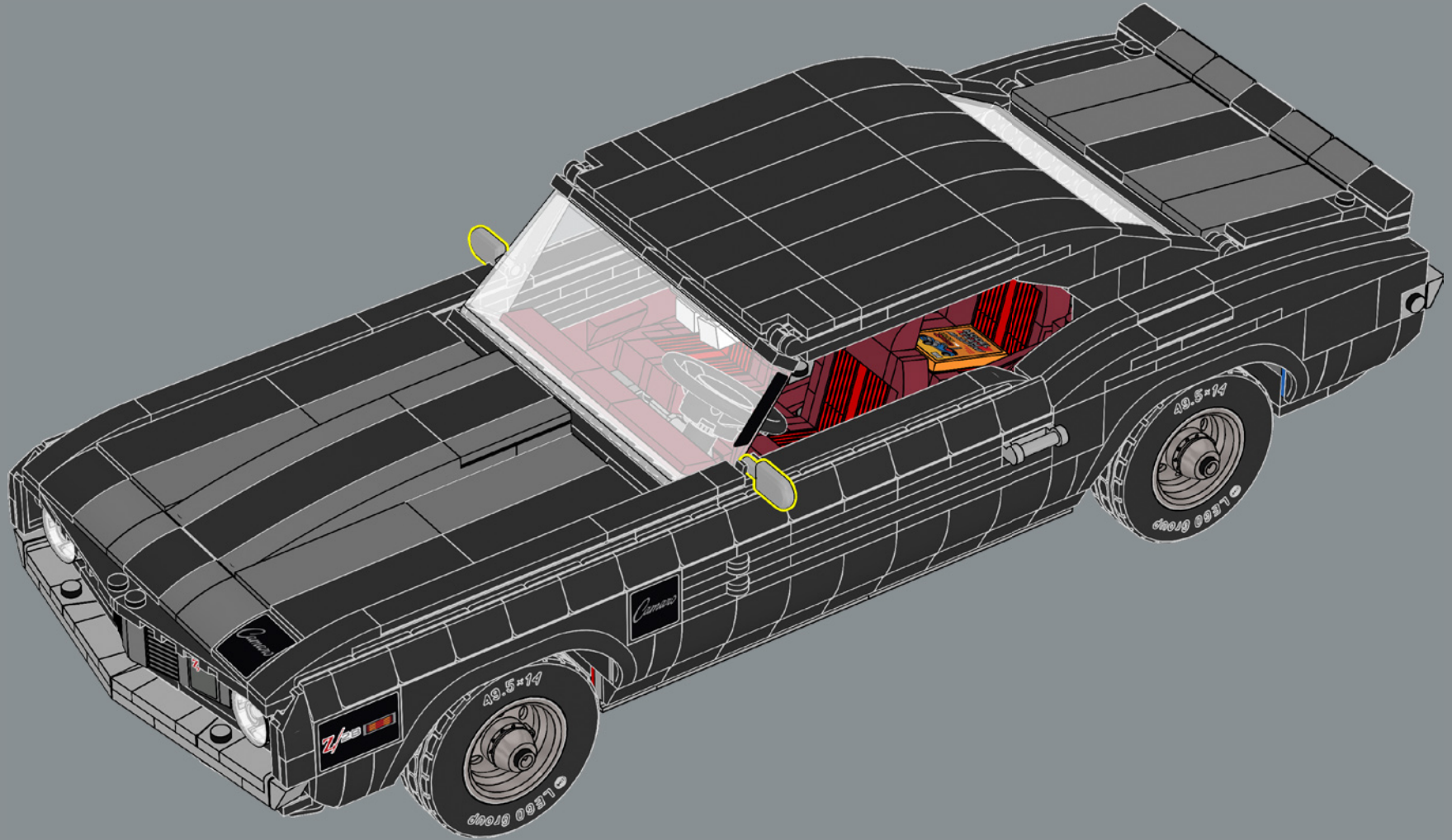

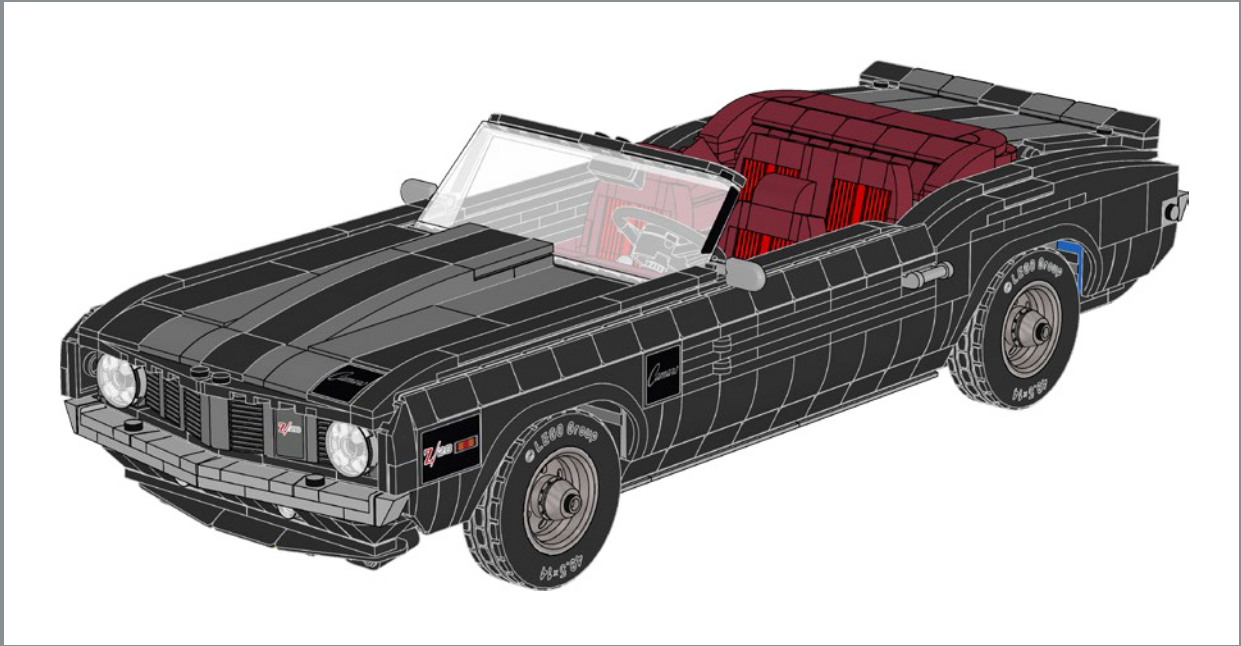

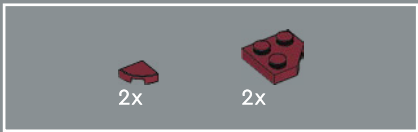

317

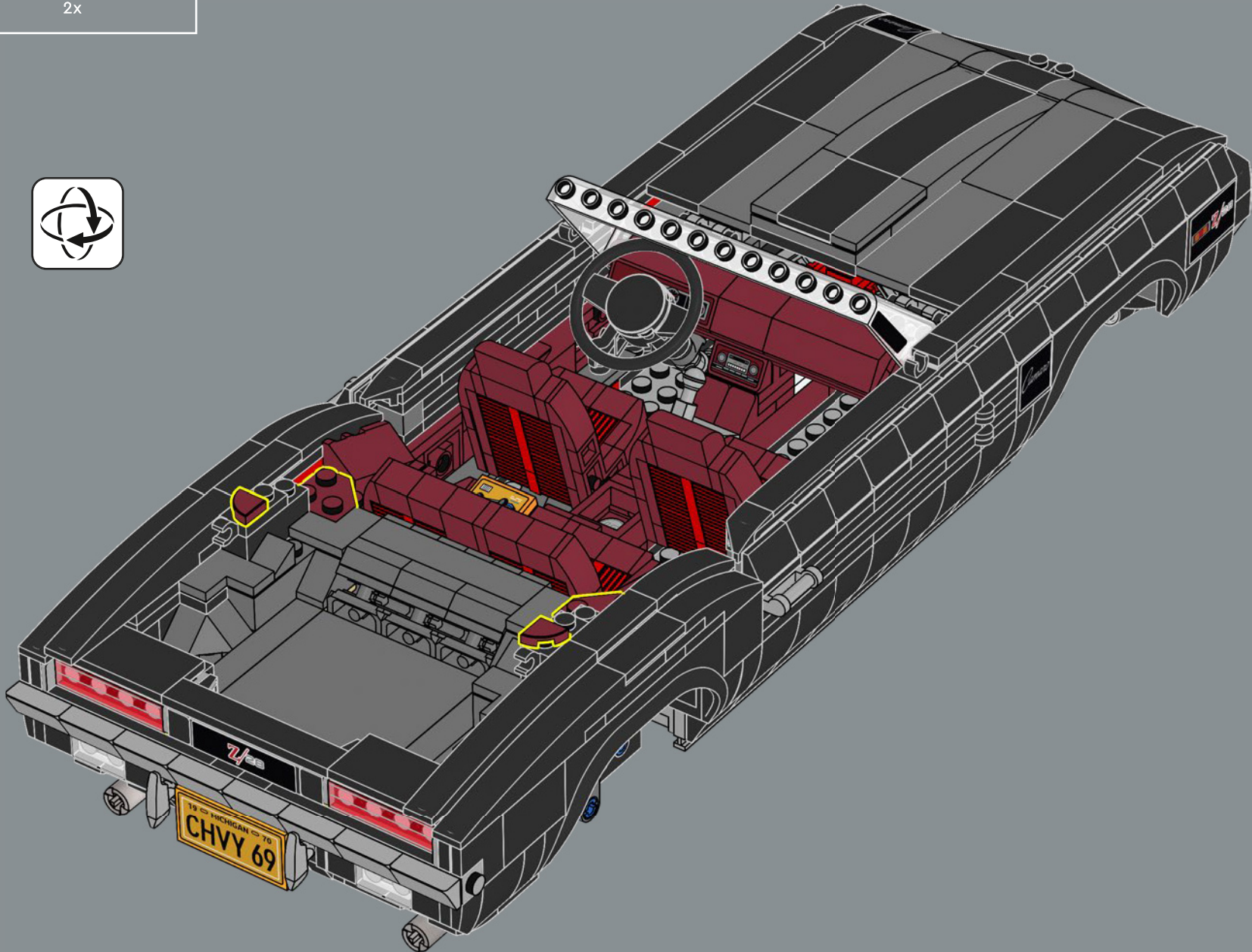

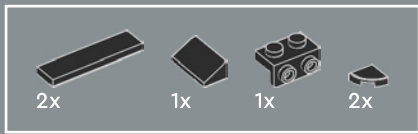

318

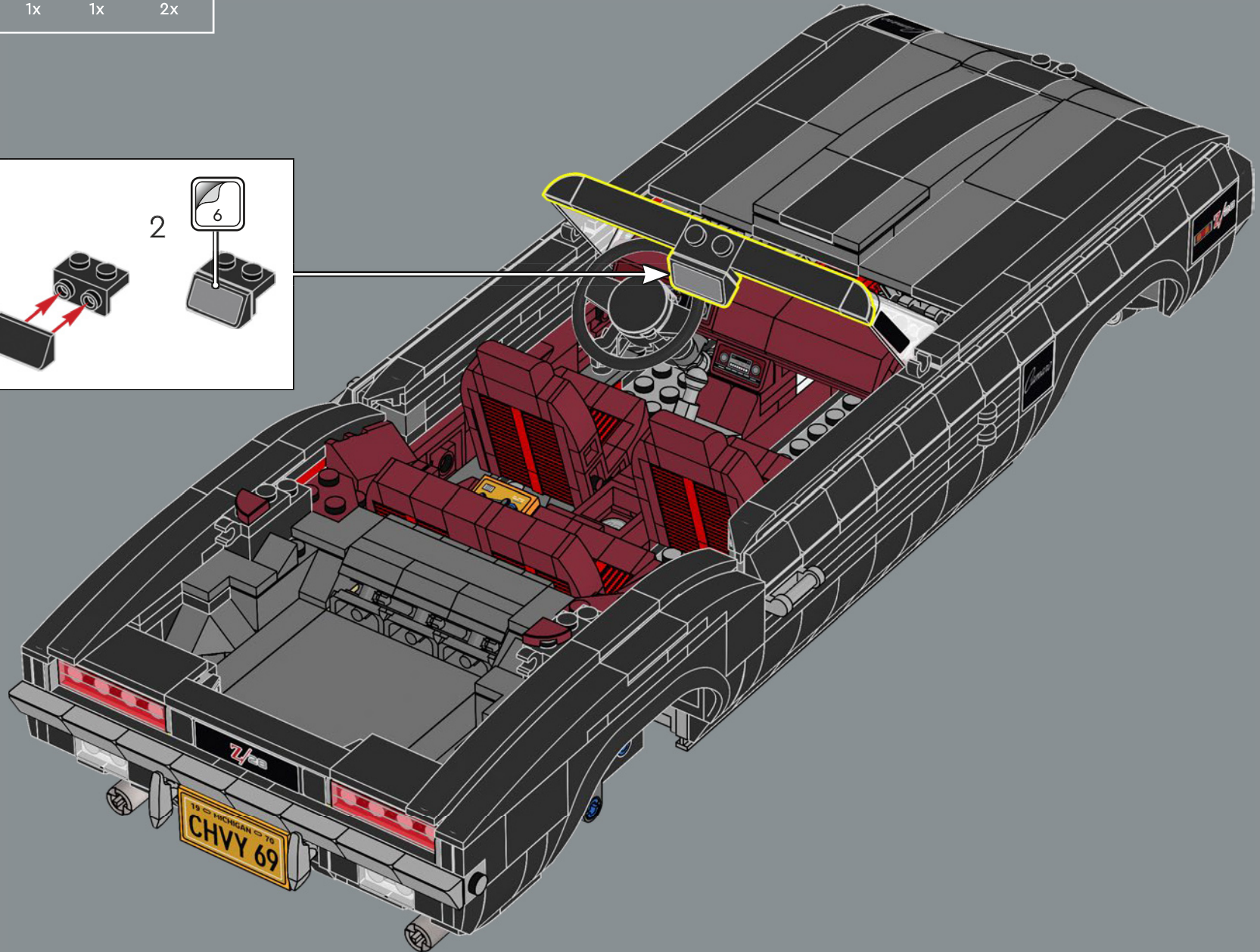
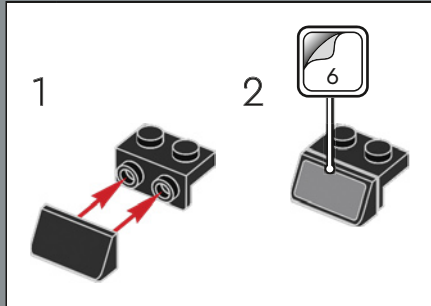

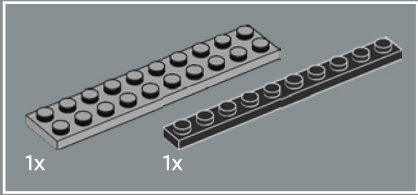

319

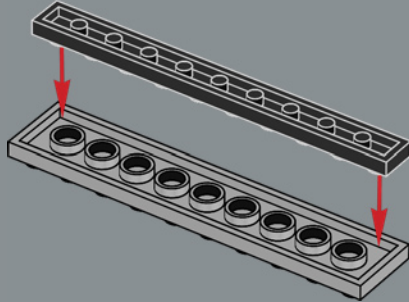

320

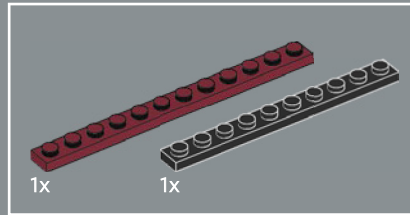
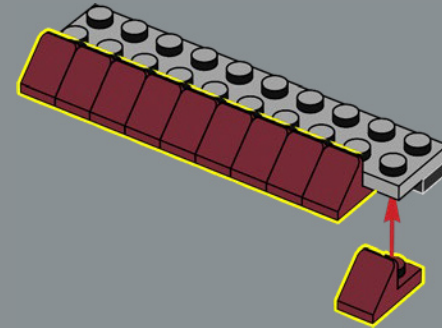

321

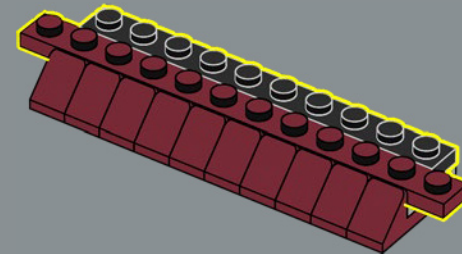

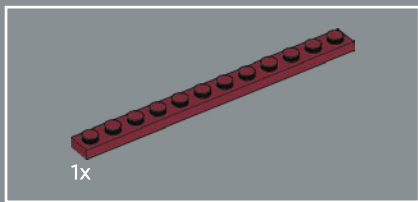

322

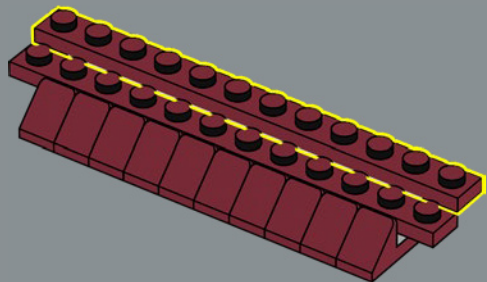

323

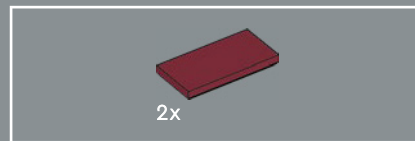
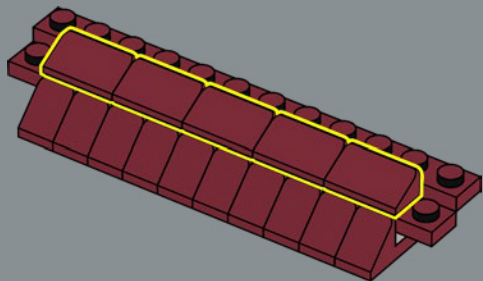

324

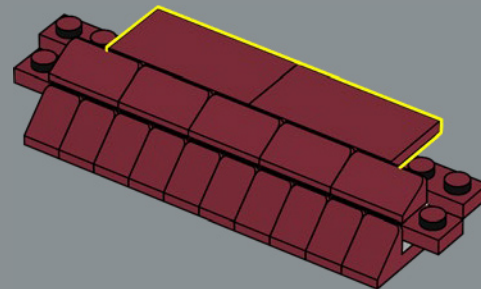

325

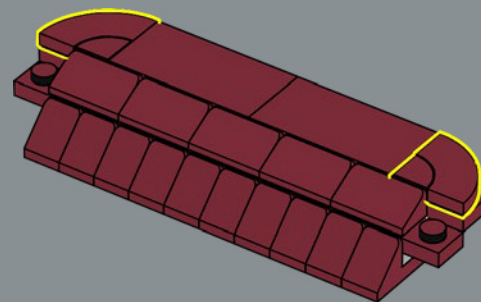

326

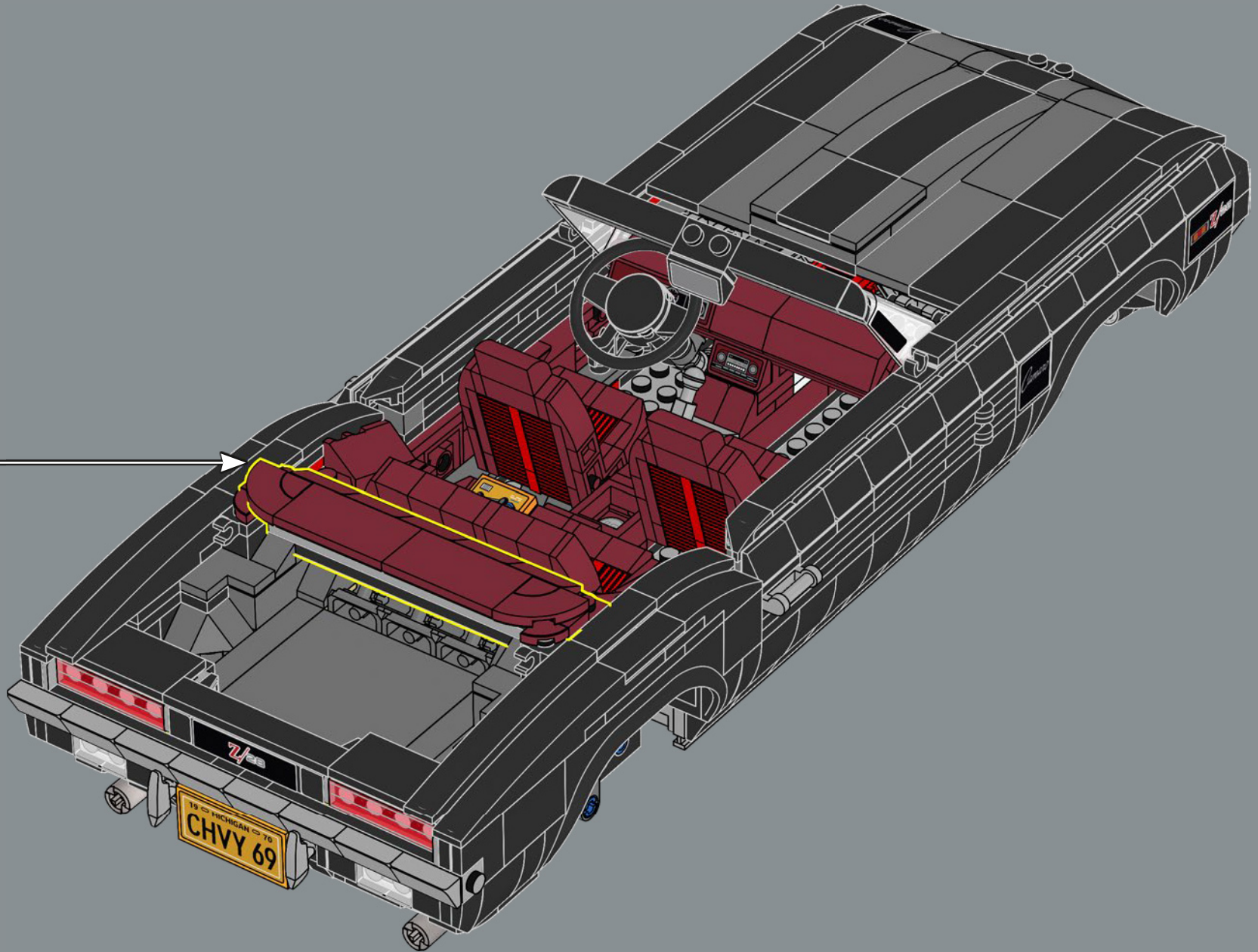

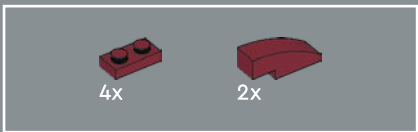

327

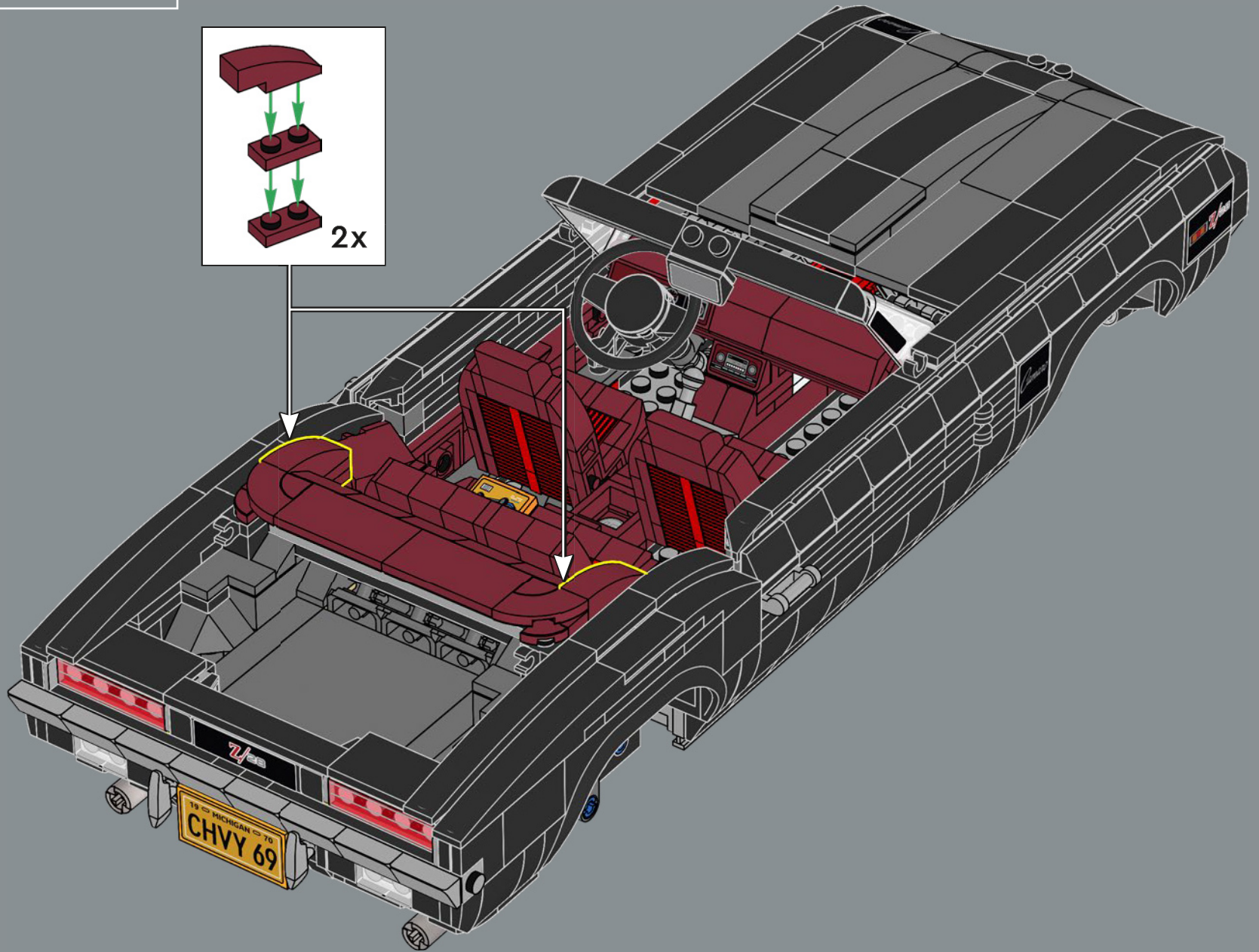
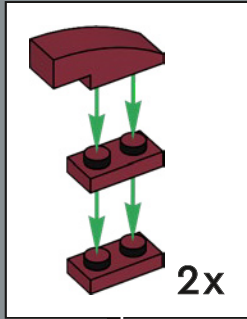

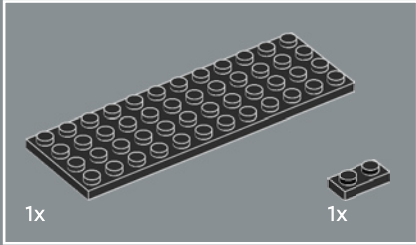
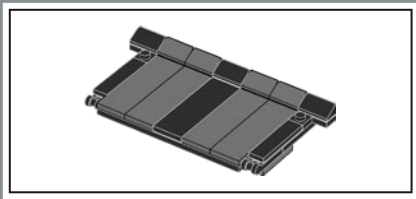

328

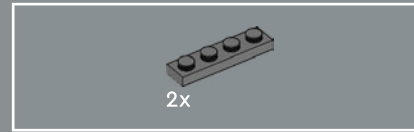
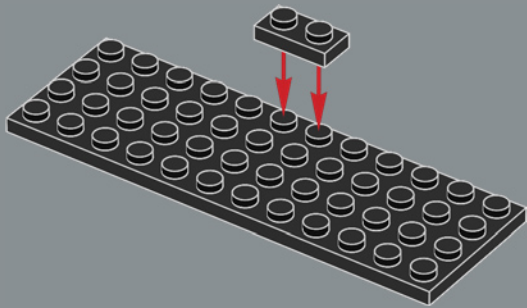

329

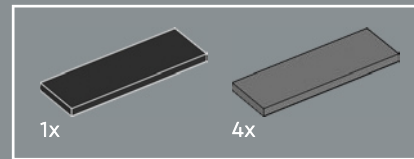
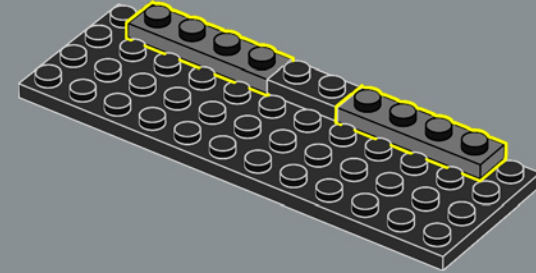

330

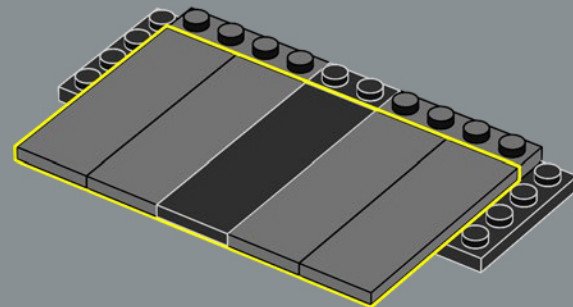

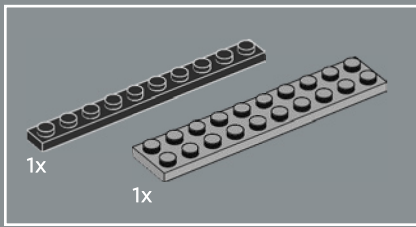

331

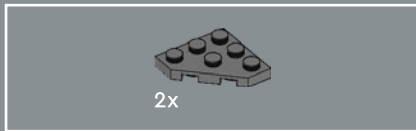
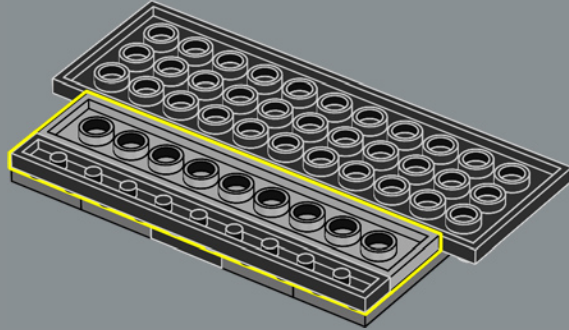

332

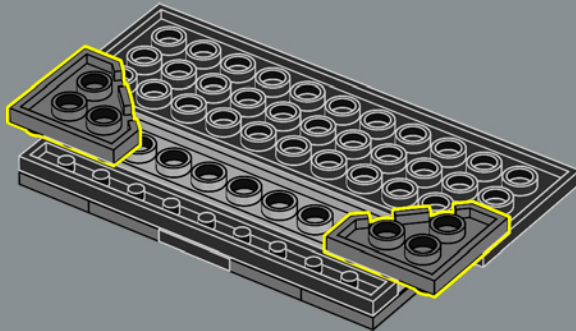

333

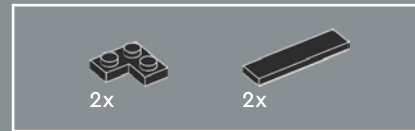
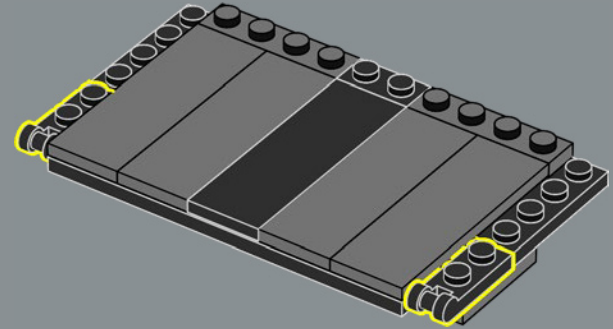

334

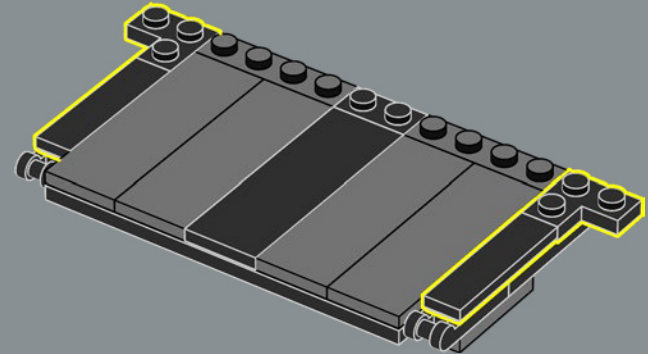



335

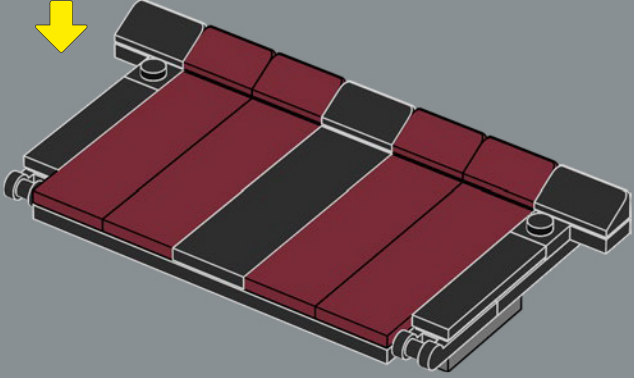
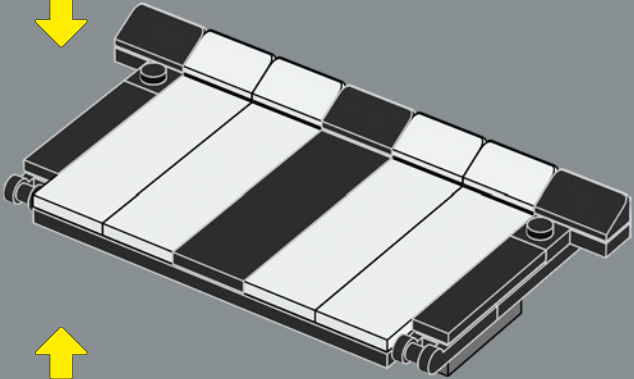
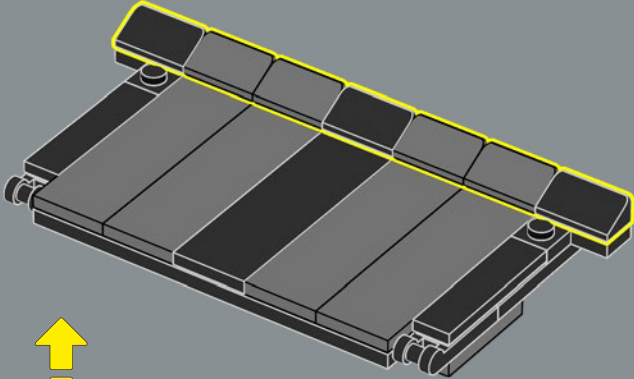

336

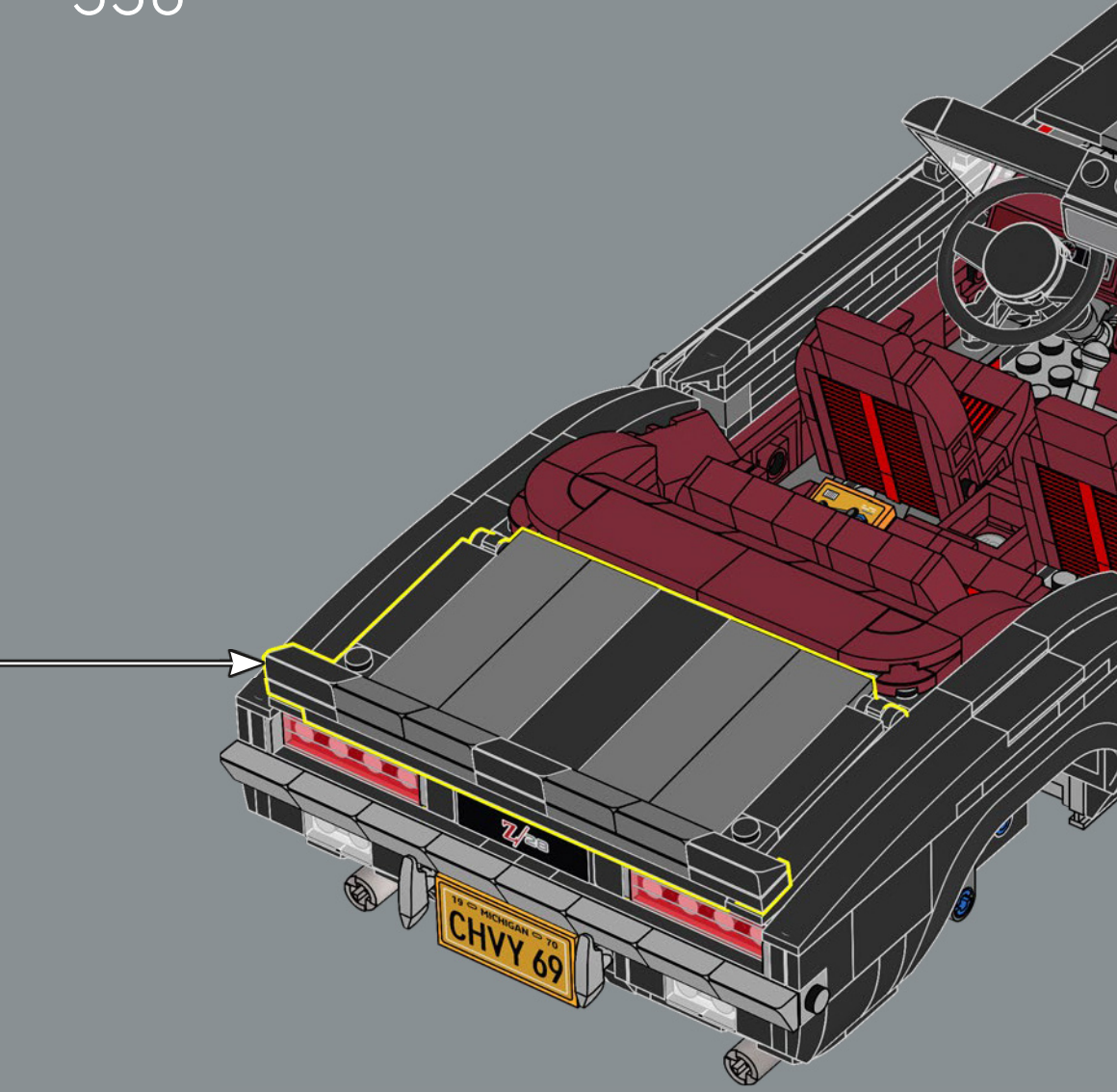

A limited replica production of the Camaro Z11 pace car from the 1969 Indianapolis 500 remains one of the most sought-after Camaro models.

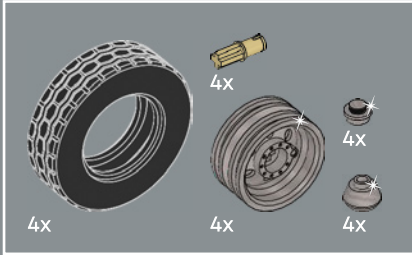
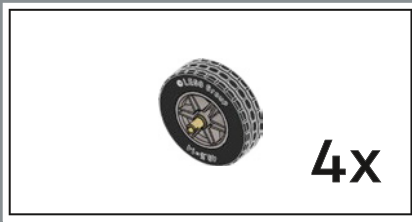

337

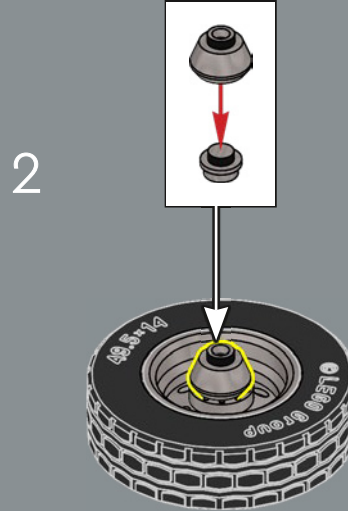
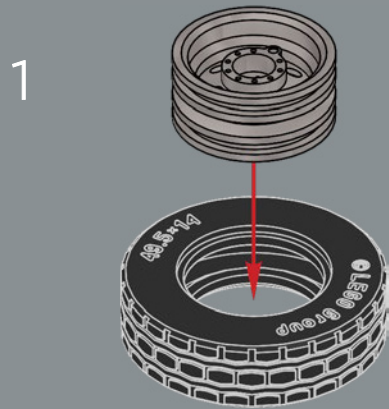

4x

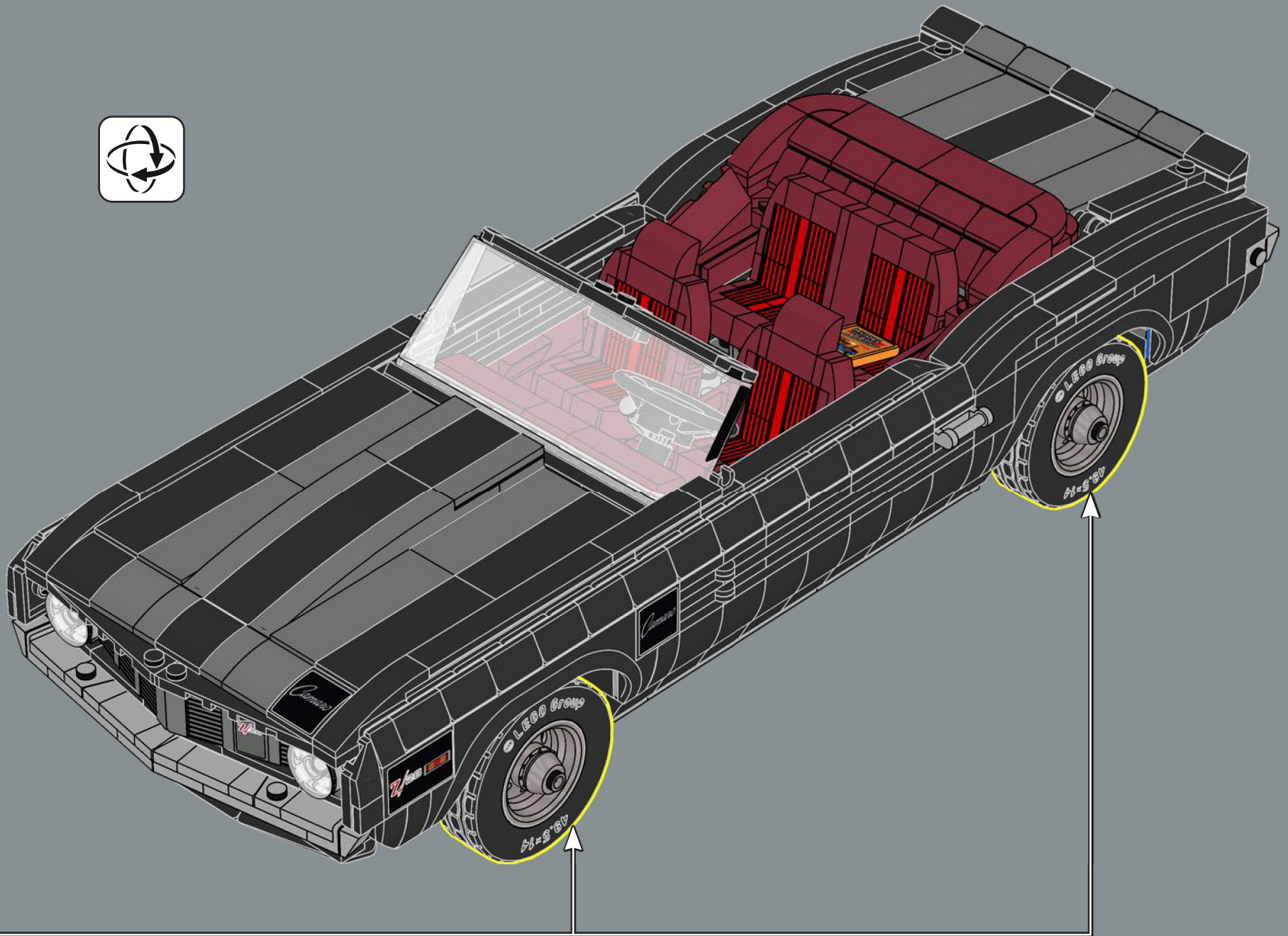



338

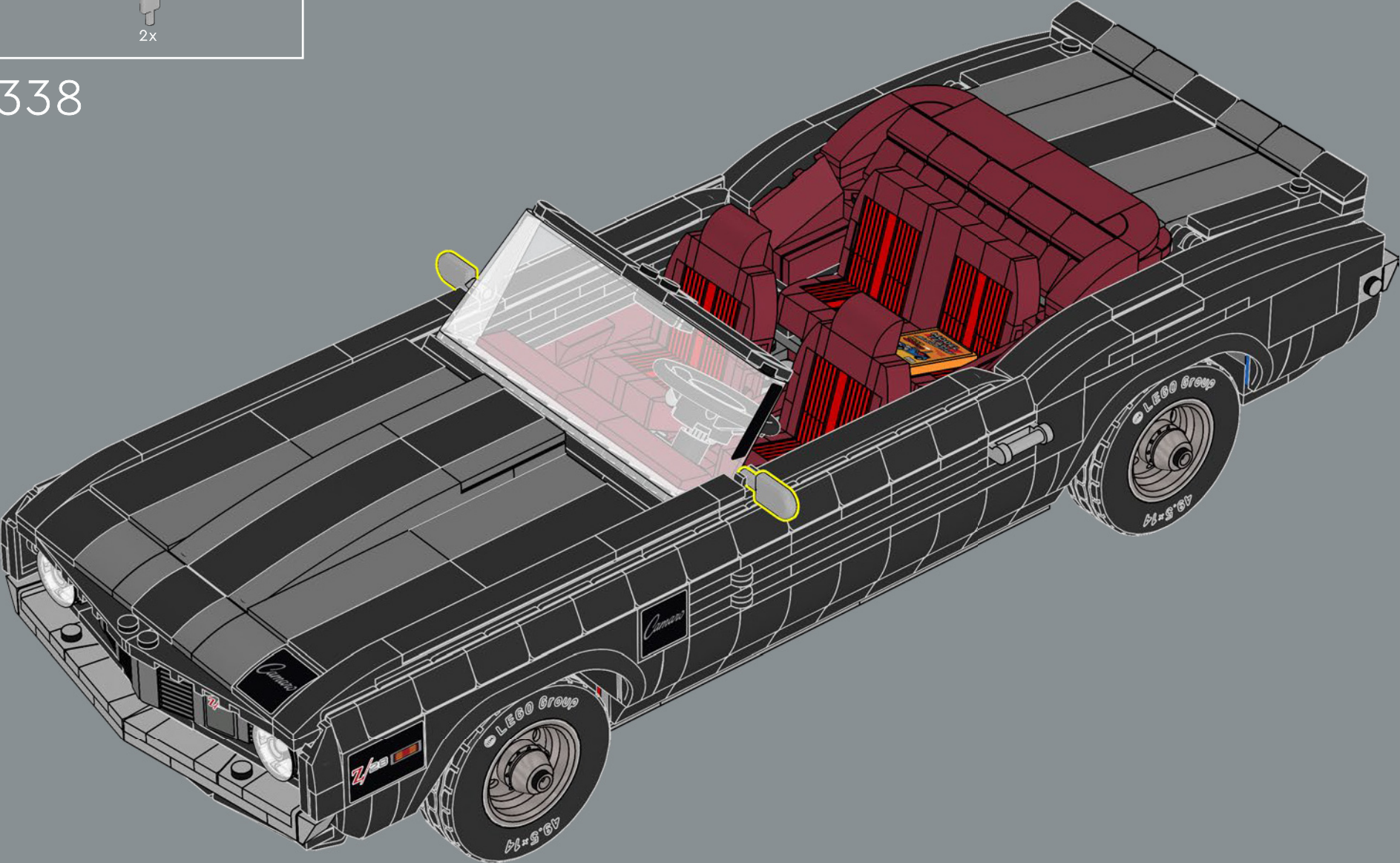

- 4x 4547489
- 2x 6034044
- 2x 6047220
- 4x 6276981
- 2x 6383985
- 4x 302201
- 2x 243101
- 2x 371001
- 2x 6104805
- 3x 302001
- 8x 6332042
- 2x 6035405
- 2x 6242241
- 3x 6347287
- 1x 6265740
- 2x 6146525
- 2x 614101
- 1x 6371416
- 1x 6289797
- 2x 4162465
- 8x 418793
- 2x 6360037
- 8x 6024495
- 6x 4523145
- 8x 4121921
- 3x 4143409
- 3x 4249019
- 6x 6253003
- 2x 6013938
- 4x 4666579
- 2x 6416525
- 24x 6219677
- 2x 300321
- 2x 4558886
- 1x 654121
- 2x 370021
- 2x 6385920
- 1x 6275178
- 1x 330021
- 2x 307021
- 2x 302321
- 4x 6092565
- 2x 306921
- 6x 362321
- 2x 6378120
- 12x 371021
- 1x 303221
- 1x 303421
- 2x 6337002
- 2x 6347308
- 6x 6261351
- 5x 6168634
- 1x 6266205
- 8x 6168619
- 1x 6271820
- 3x 4142865
- 4x 6347789
- 1x 6130002
- 6x 393721
- 2x 300223
- 6x 6290531
- 1x 4212411
- 1x 6171063
- 2x 6057802
- 2x 306923
- 4x 6252060
- 2x 6196596
- 3x 303423
- 3x 6117968
- 4x 4206482
- 10x 6299413
- 2x 393723
- 2x 300524
- 2x 235724
- 2x 654124
- 14x 302324
- 2x 6195183
- 2x 6271167
- 1x 6170294
- 1x 6331822
- 2x 366624
- 6x 6248833
- 10x 300526
- 2x 4644456
- 4x 300426
- 6x 362226
- 2x 300226
- 5x 301026
- 2x 4584274
- 3x 370226
- 4x 4504382
- 53x 4548180
- 2x 4121966
- 4x 6267487
- 6x 366526
- 12x 6069000
- 1x 303926
- 2x 6176768
- 4x 428626
- 6x 428726
- 1x 6064228
- 5x 6181720
- 4x 6273589
- 2x 4107558
- 4x 302426
- 2x 6388352
- 6x 307026
- 44x 302326
- 8x 306926
- 2x 6214807
- 14x 6192346
- 4x 306826
- 2x 6312724
- 10x 302226
- 6x 242026
- 4x 6133722
- 4x 6195271
- 1x 403226
- 5x 6181713
- 2x 6184784
- 10x 6047276
- 26x 6053077
- 2x 6211476
- 2x 4618880
- 2x 6280394
- 1x 6319983
- 1x 6316923
- 1x 6331026
- 6x 6037746
- 6x 4647286
- 1x 6296083
- 4x 6037664
- 6x 243126
- 6x 371026
- 7x 302026
- 4x 4560182
- 2x 6350415
- 3x 663626
- 12x 366626
- 11x 6318582
- 6x 416226
- 1x 303226
- 1x 395826
- 14x 447726

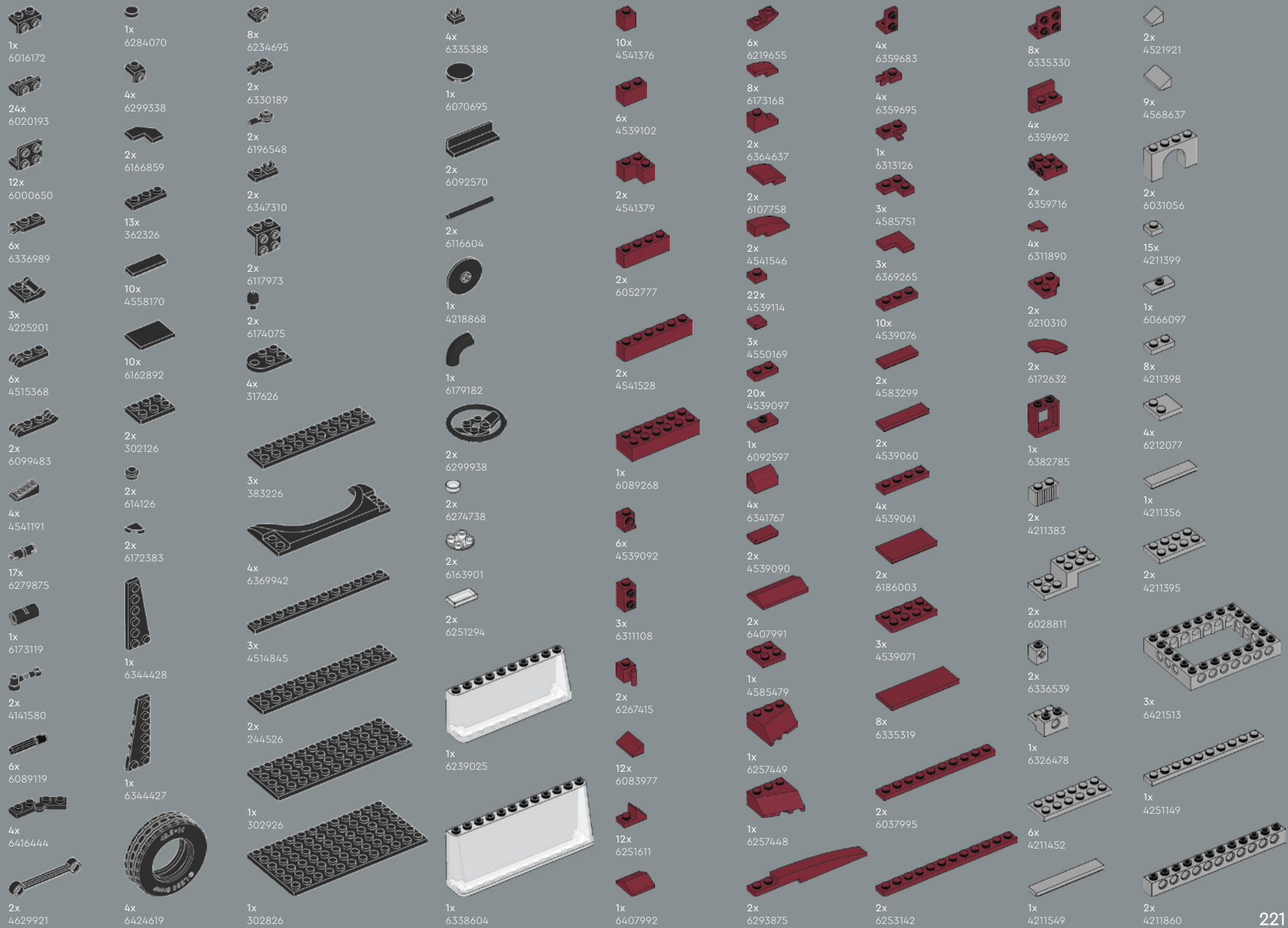

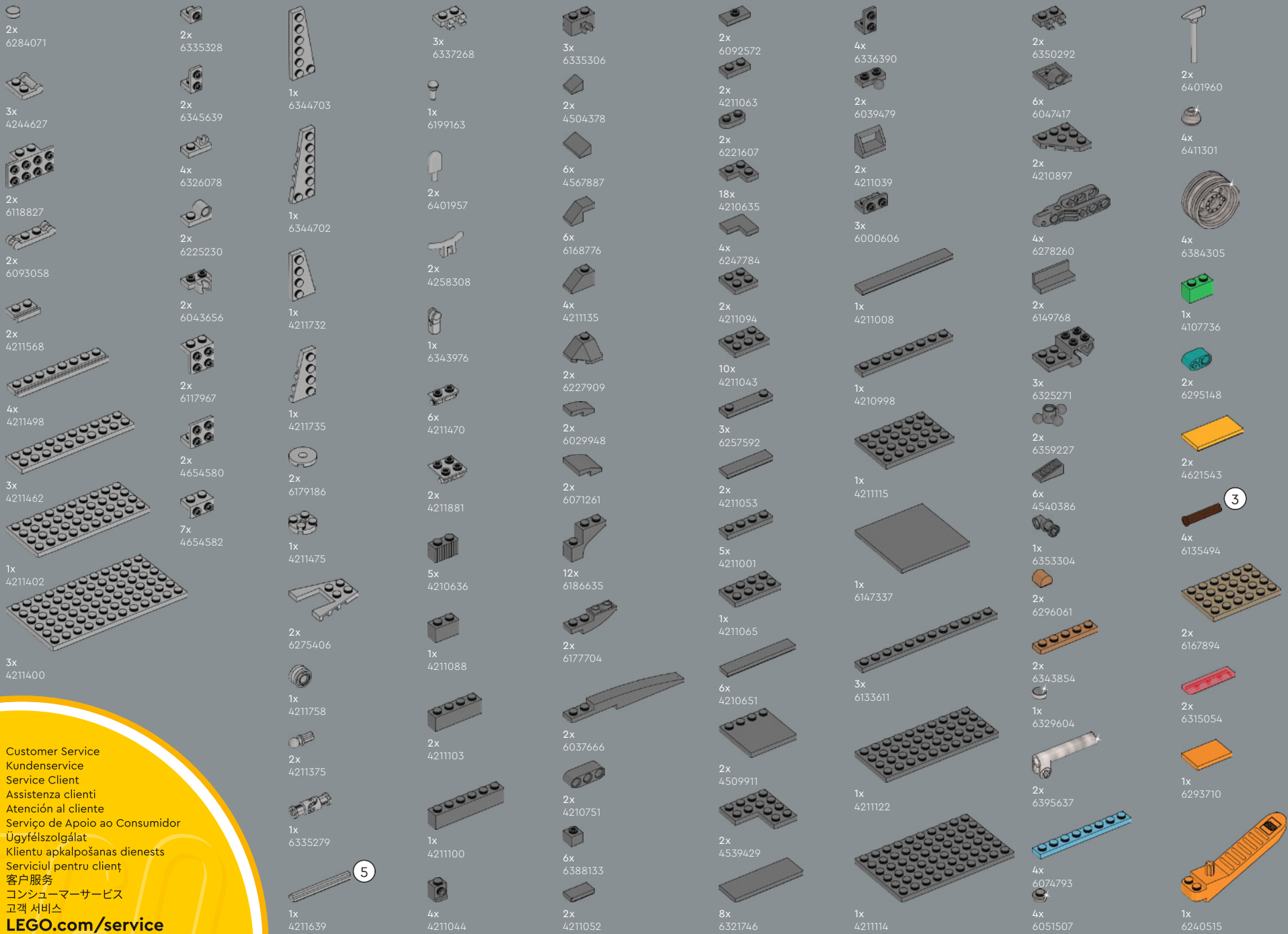

Customer Service
 Kundenservice
 Service Client
 Assistenza clienti
 Atención al cliente
 Serviço de Apoio ao Consumidor
 Ügyfélszolgálat
 Klientu apkalpošanas dienests
 Serviciul pentru clienț
 客户服务
 コンシューマーサービス
 고객 서비스
LEGO.com/service



FEEDBACK AND WIN



FEEDBACK AND WIN

Your feedback will help shape the future development of this product series.

Please visit:

FEEDBACK UND GEWINNEN

Dein Feedback trägt zur Weiterentwicklung dieser Produktreihe bei.

Geh auf:

COMMENTEZ ET GAGNEZ

Vos commentaires nous aideront à concevoir les futurs produits de cette gamme.

Rendez-vous sur :

COMENTA Y GANA

Tu opinión nos ayudará a dar forma al desarrollo de esta serie de productos en el futuro.

Visita:

反馈有奖

您的反馈将有助于我们在今后改进本系列产品。

请访问：

[LEGO.com/productfeedback](https://www.lego.com/productfeedback)

By completing, you will automatically enter a drawing to win a LEGO® set.

Terms & Conditions apply.

Durch Ausfüllen nimmst du automatisch an der Verlosung eines LEGO® Preises teil.

Es gelten die Teilnahmebedingungen.

En envoyant vos commentaires, vous serez automatiquement inscrit(e) à un tirage au sort qui vous permettra de remporter un prix LEGO®.

Offre soumise à conditions.

Al contestar, participarás automáticamente en el sorteo y podrás ganar un set LEGO®.

Sujeto a Términos y Condiciones.

完成我们的反馈调查，即可自动进入抽奖环节，赢取乐高®套装。

适用《条款和条件》。

