



Friends

41741



1



LEGO.com/sustainable-packaging



BUILDER



Apple and the Apple logo are trademarks of Apple Inc., registered in the U.S. and other countries and regions. App Store is a service mark of Apple Inc. Google Play and the Google Play logo are trademarks of Google LLC. Tencent and the Tencent logo are trademarks of Tencent Inc.

[LEGO.com/devicecheck](https://www.lego.com/devicecheck)

EN Ask parents' permission before going online | **DE** Eltern um Erlaubnis bitten, bevor du online gehst | **FR** Demande l'autorisation d'un parent avant d'aller en ligne | **IT** Chiedi il permesso ai tuoi genitori prima di andare online | **ES** Pídeles permiso a tus papás antes de conectarte a Internet | **PT** Pede autorização aos pais antes de acederes online | **JA** オンラインになる前に ほご者の方のきよかをもらおう | **ZH** 上网前应先征得父母的同意 | **KO** 온라인 접속 전에 보호자 동의가 필요합니다 | **RU** Спроси разрешения у родителей, прежде чем заходить в интернет | **PL** Poproś rodziców o zgodę, zanim wejdziesz do Internetu | **CS** Než půjdeš na internet, požádej rodiče o svolení | **SK** Skôr než pôjdeš na internet, vypýtaj si povolenie od rodičov | **HU** Kérj szülői engedélyt, mielőtt online csatlakoznál! | **RO** Cere permisiunea părinților înainte de a te conecta online | **BG** Поискайте разрешение от родител, преди да влезете онлайн | **LV** Pirms došanās tiešsaistē palūdz atļauju vecākiem | **ET** Enne Interneti kasutamist küsi vanematelt luba | **LT** Prieš prisijungdami prie interneto, atsklauskite tėvų



NOVA

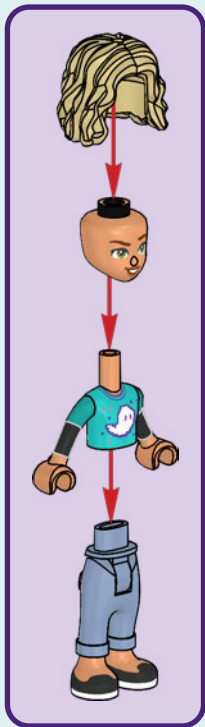

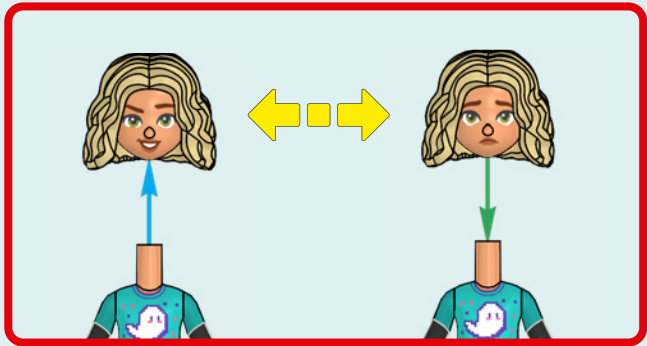
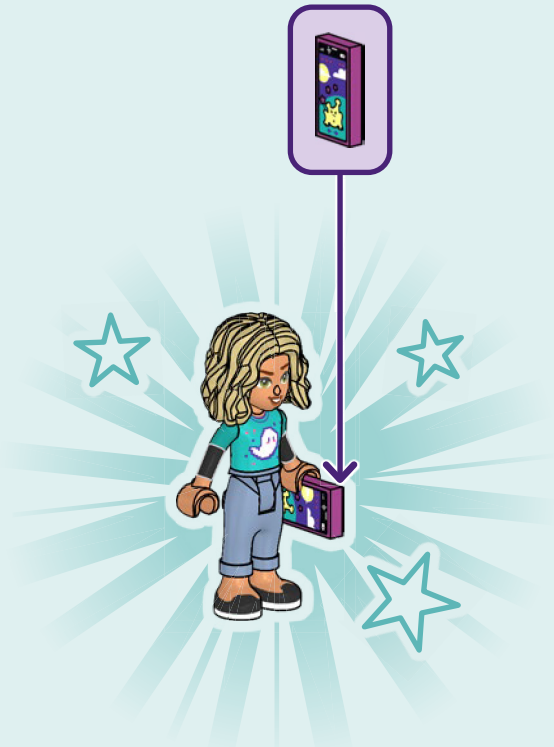

PICKLE

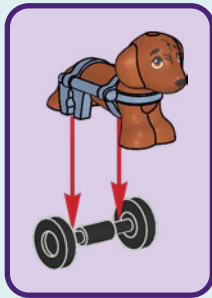

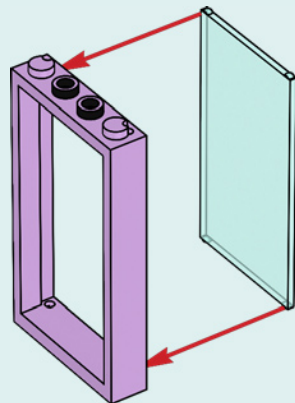
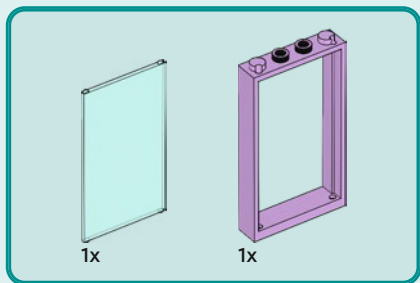
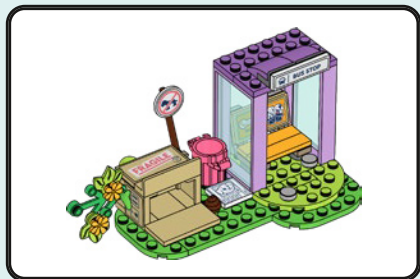

1



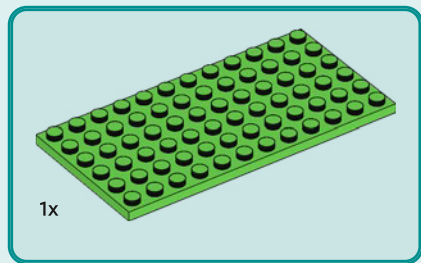

2

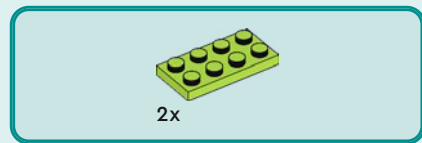
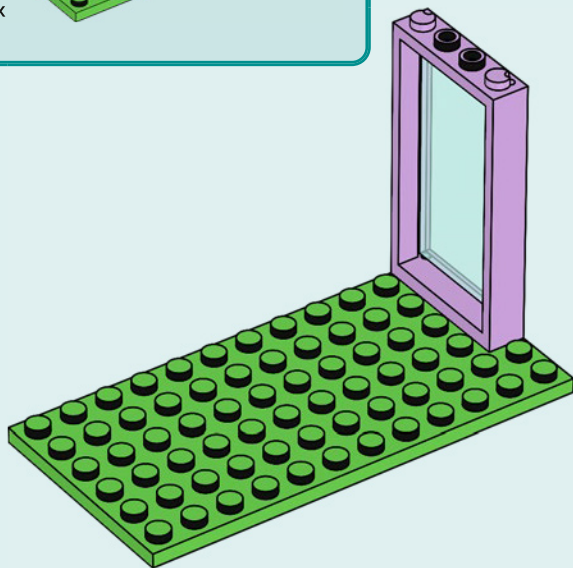

3

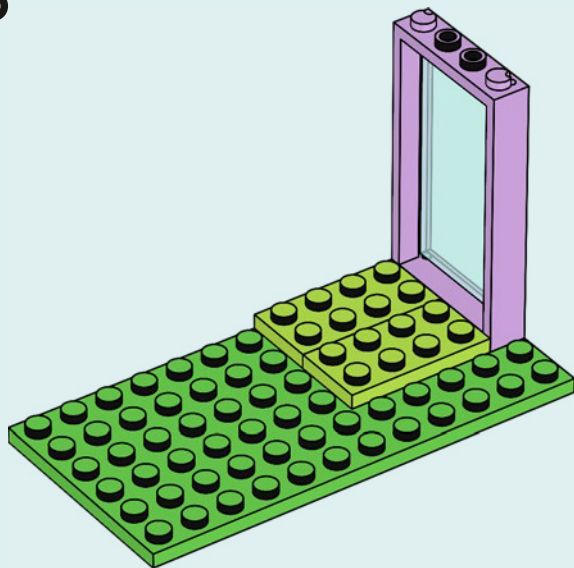



2x



1x

4

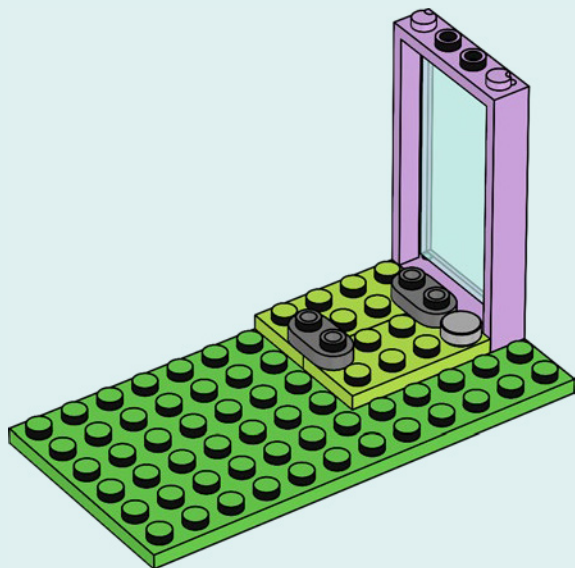

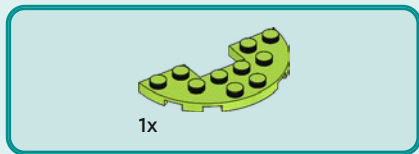

5

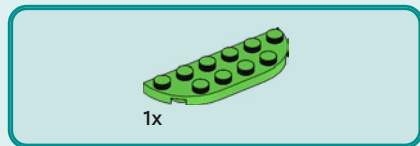
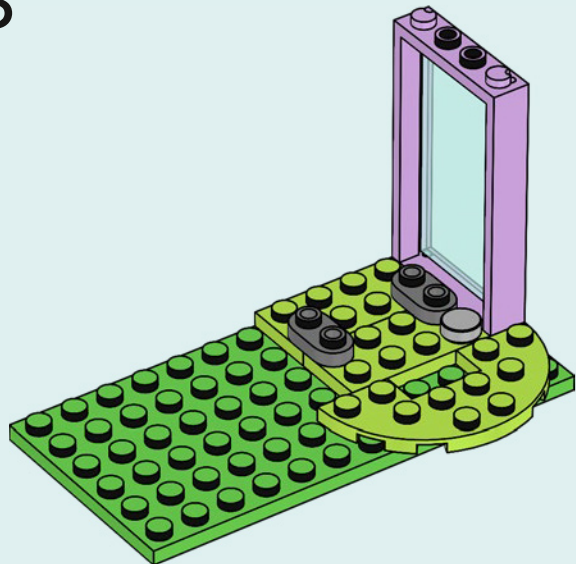

6

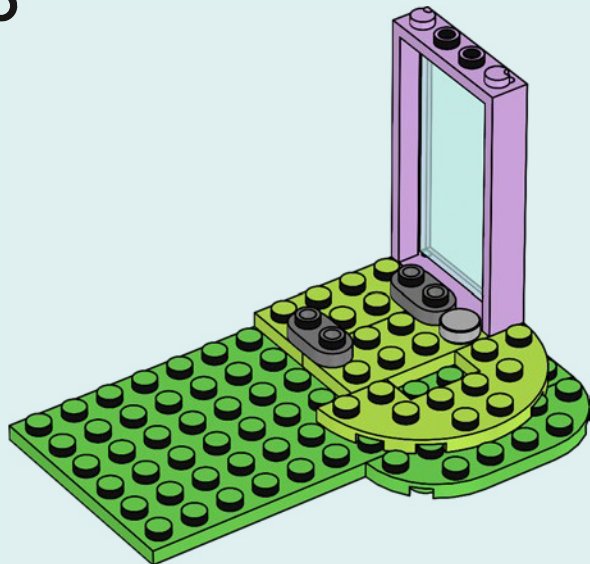



1x



1x

7

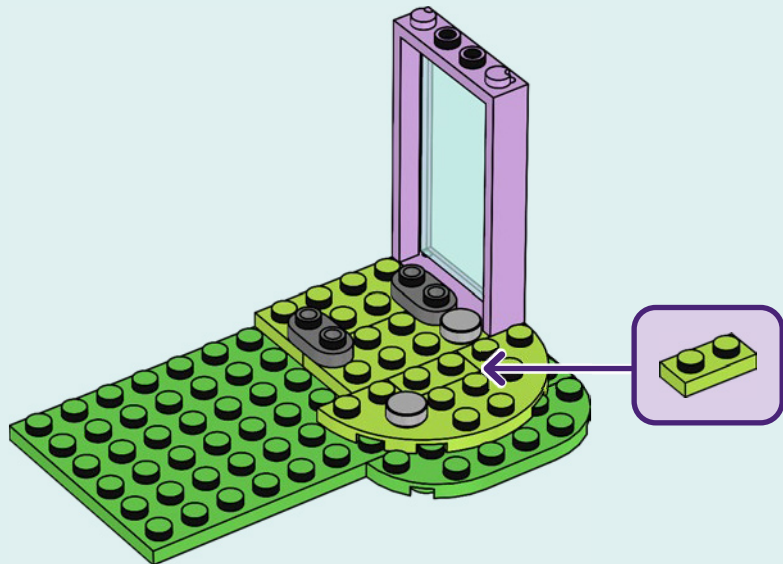



2x

8

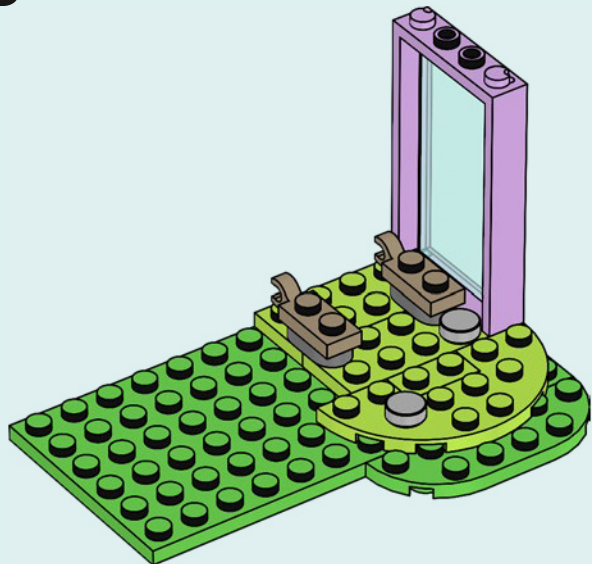

2x

9

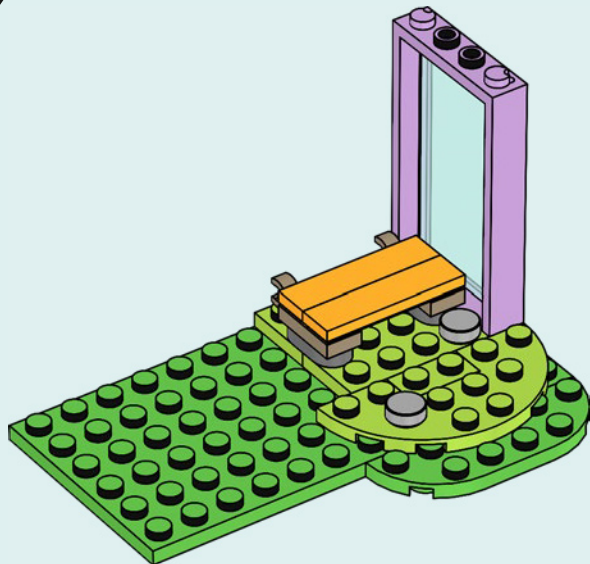

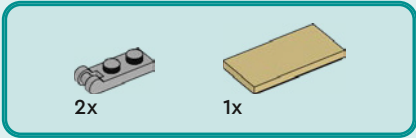

10

1

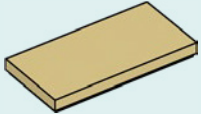

2

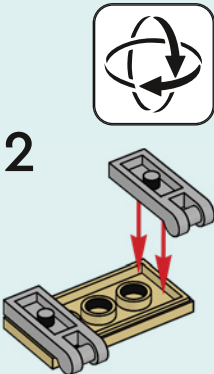

3

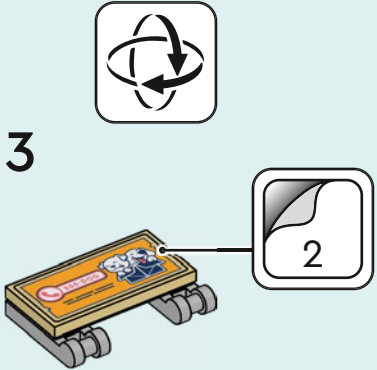

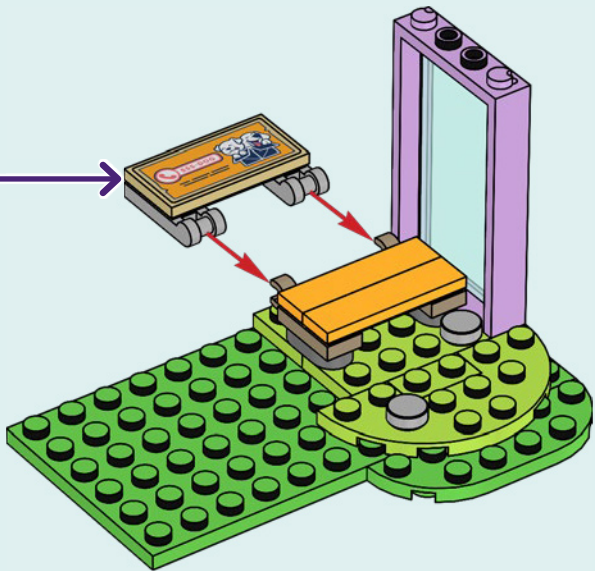

11

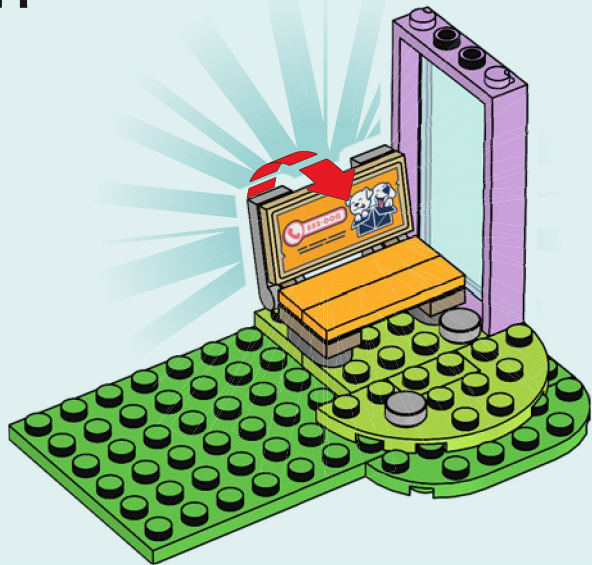

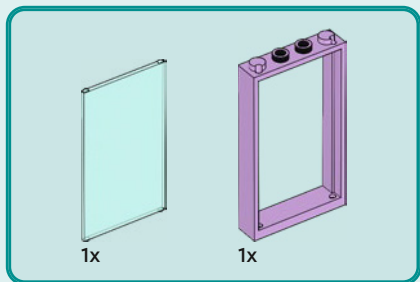

12

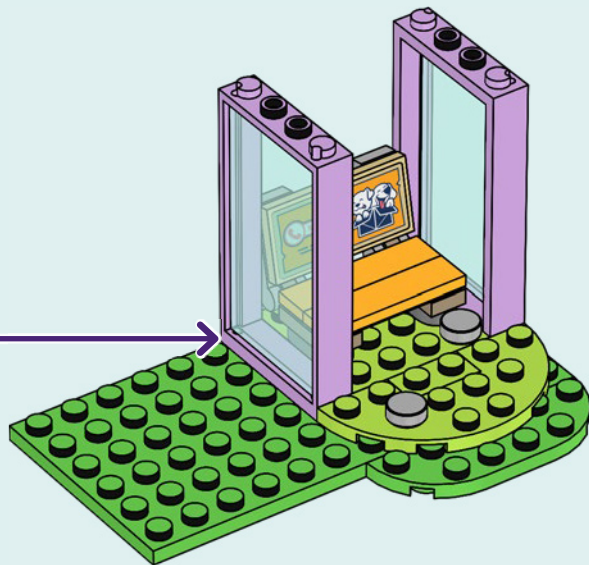
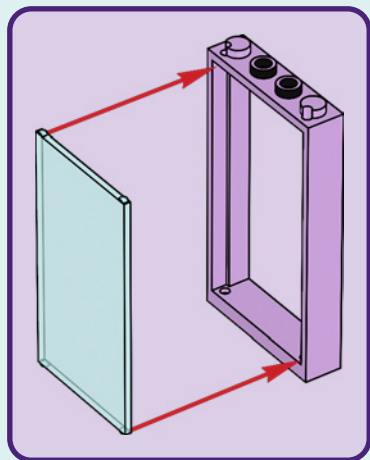

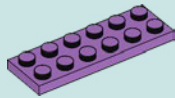

1x

13

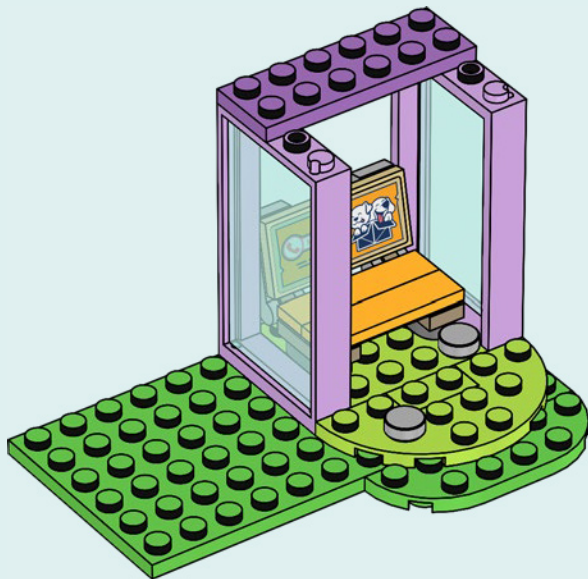

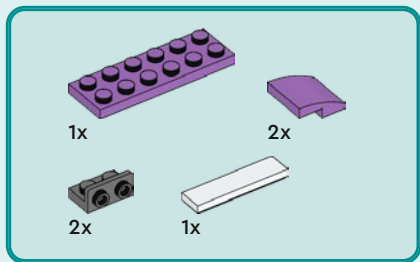

14

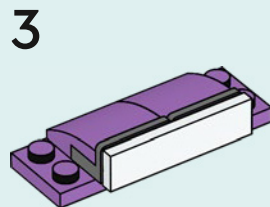
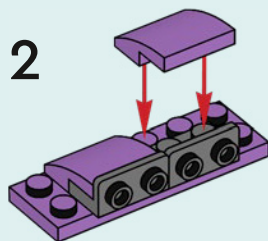
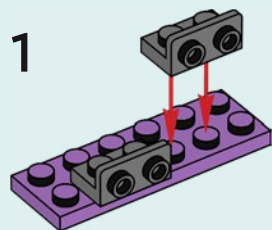

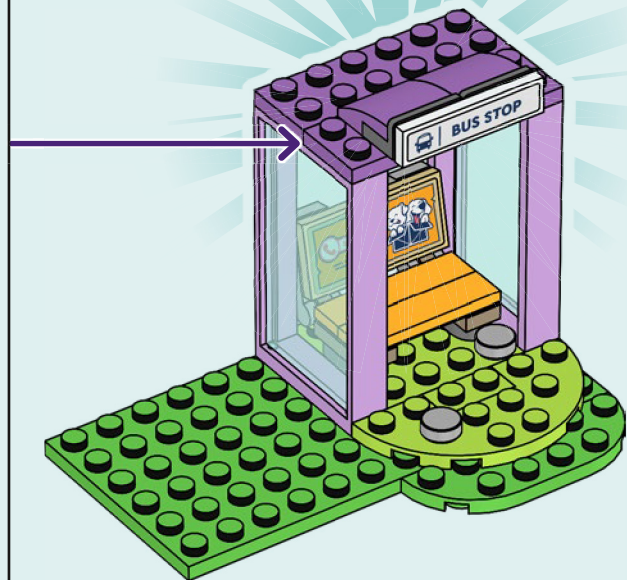
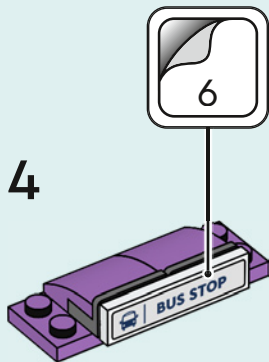



1x



1x

15





16

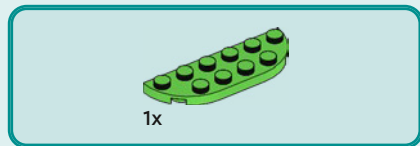
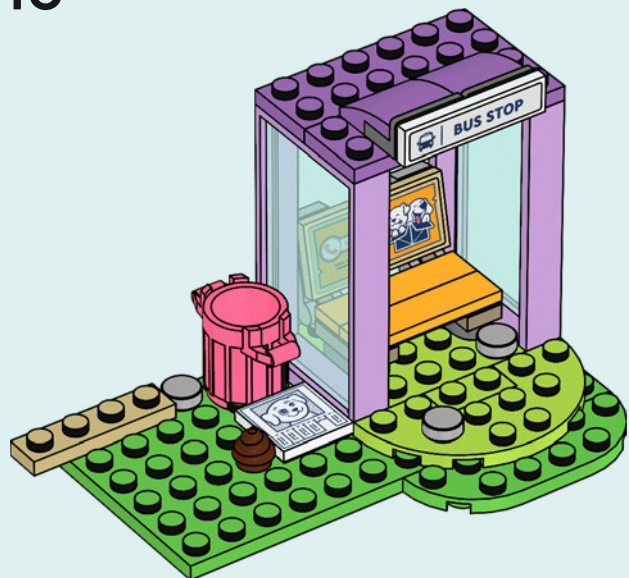

17

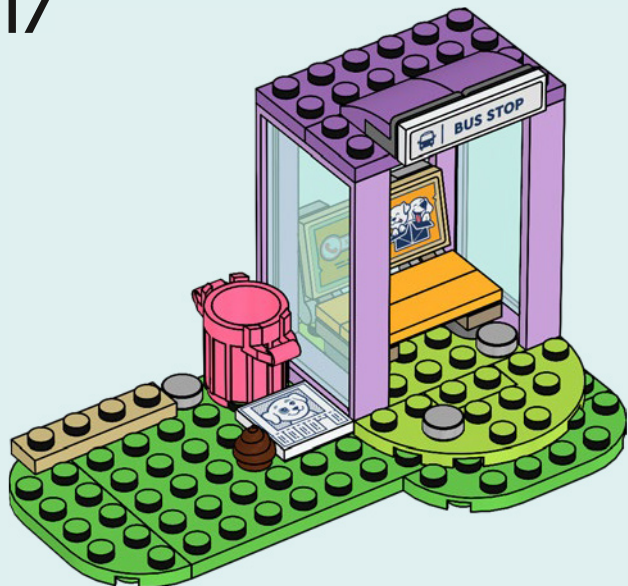



19

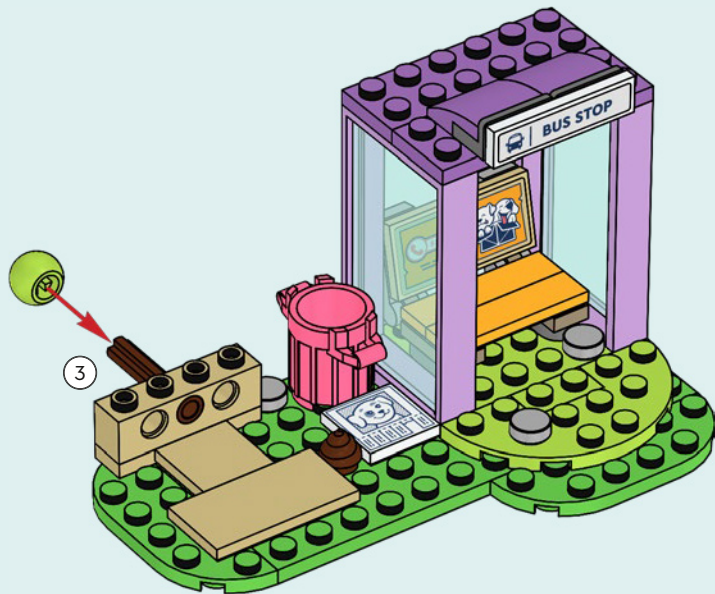



2x

20





1x

21

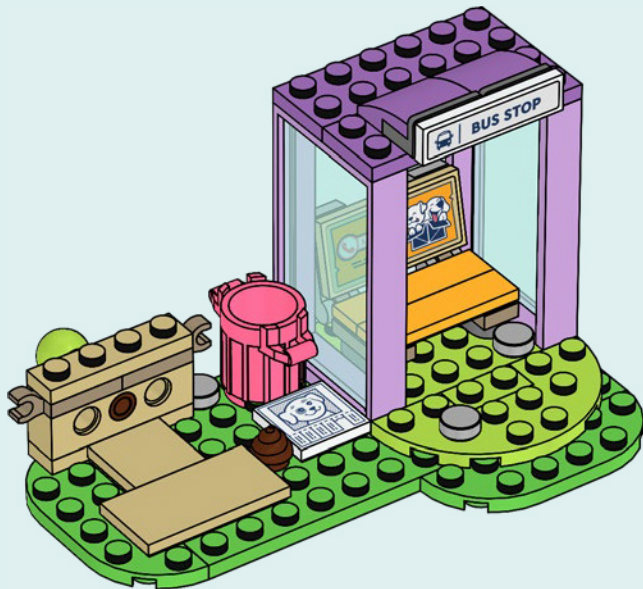

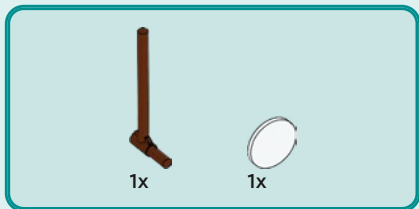

22

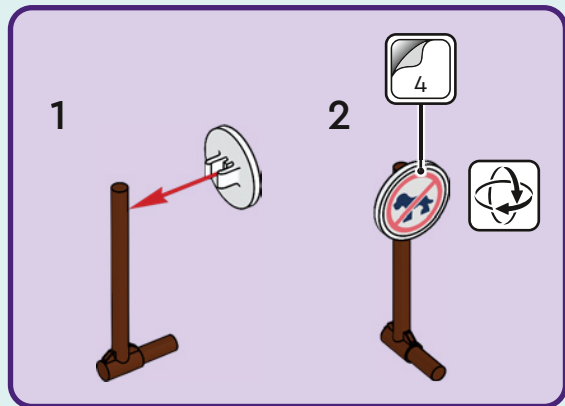



1x

23

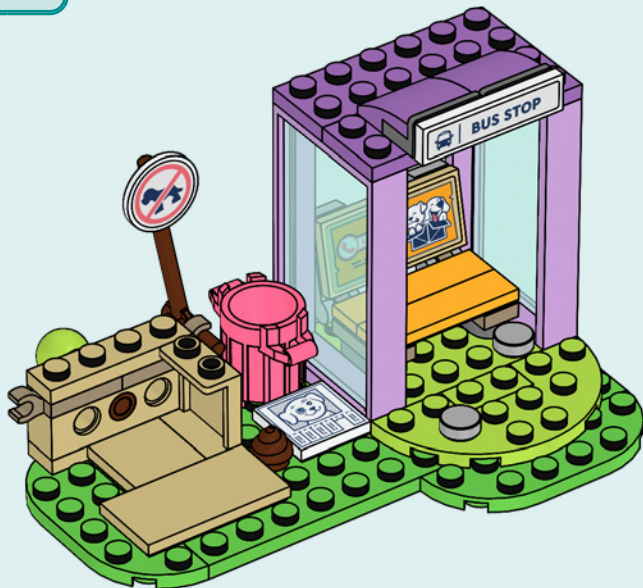



1x

24

1

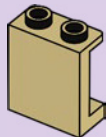

2

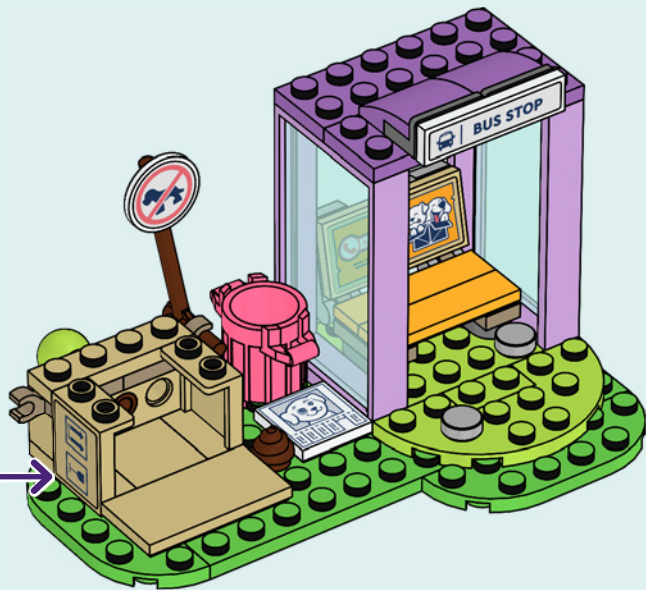

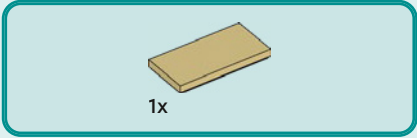

25

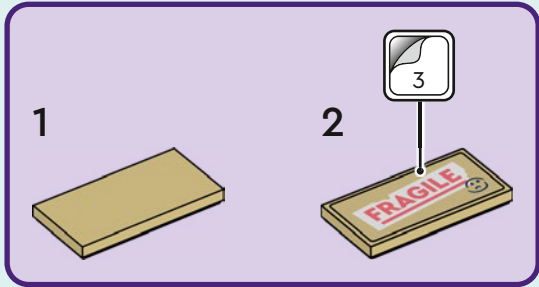



1x

26

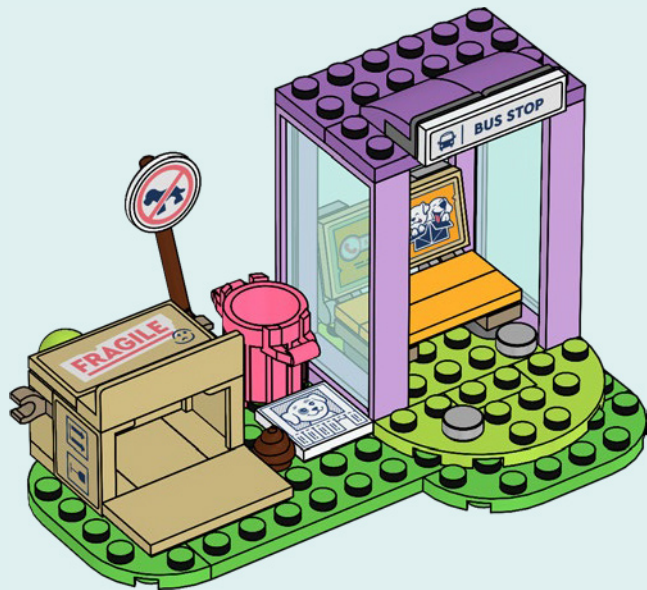

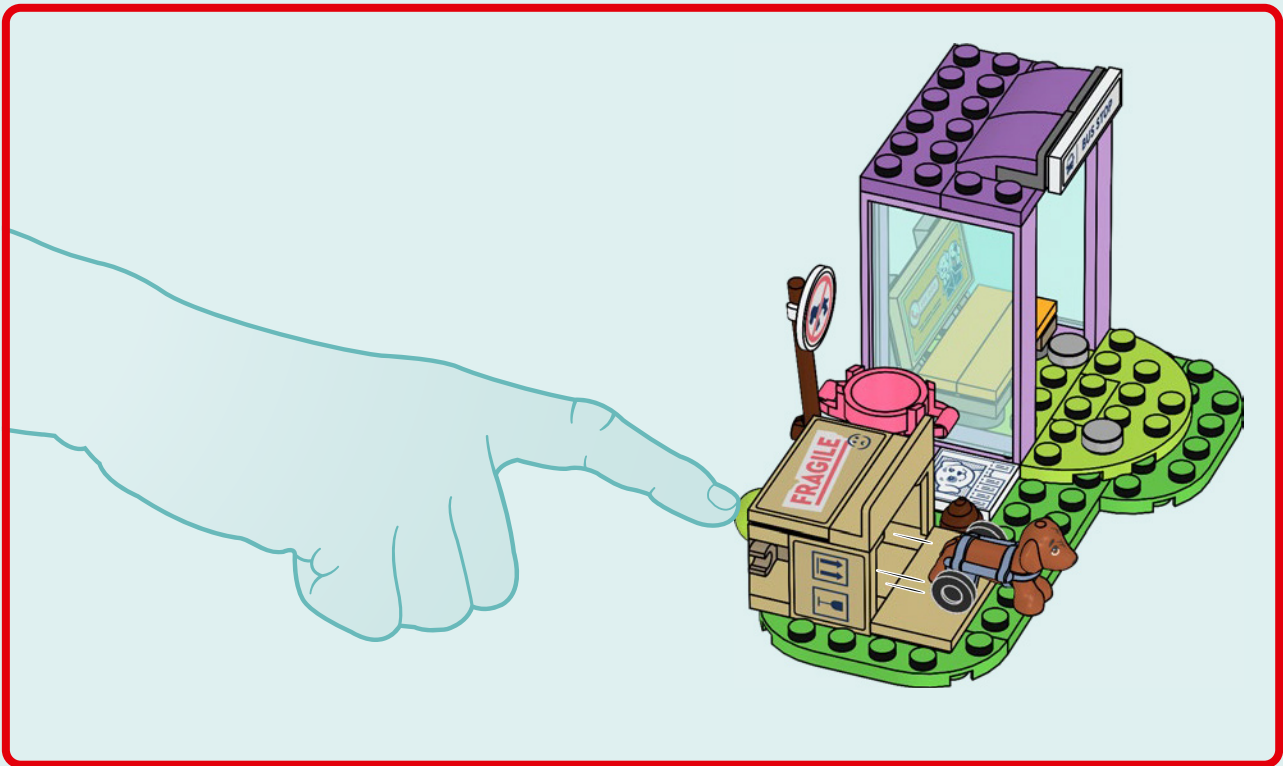

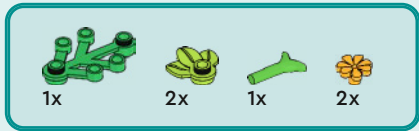

27

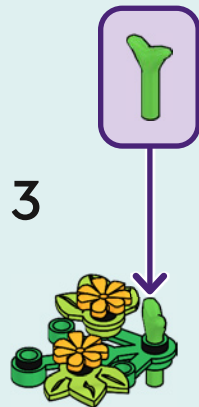
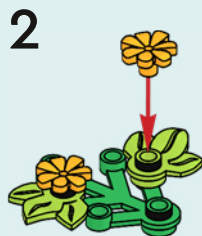
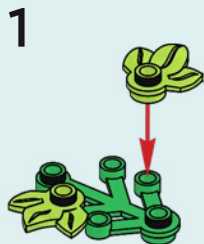

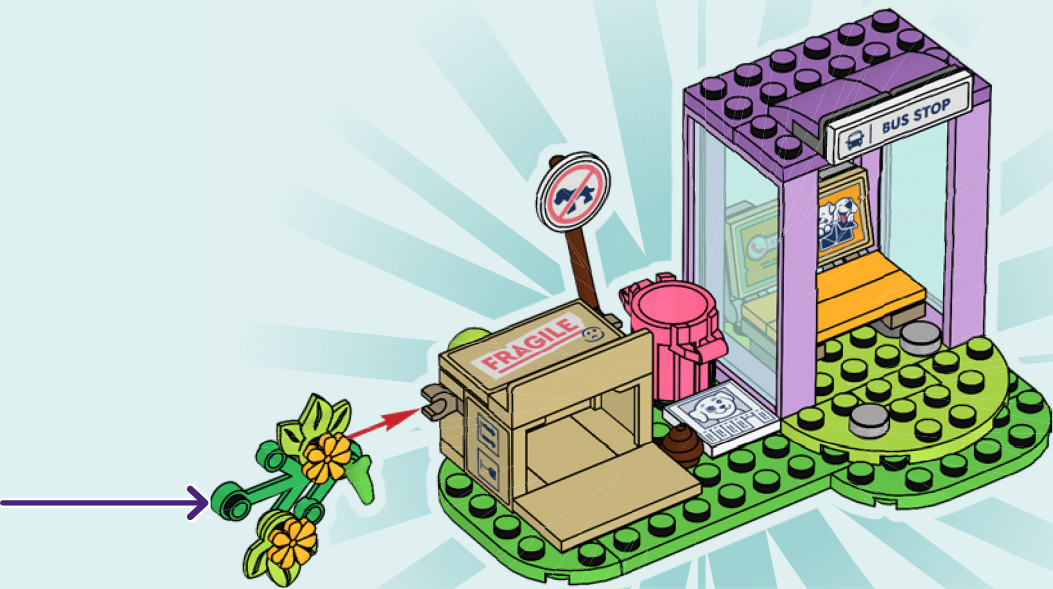



Friends

AUTUMN

ALIYA

PAISLEY

ZAC



LEO

LIANN

OLLY

NOVA



YOU COULD

WIN

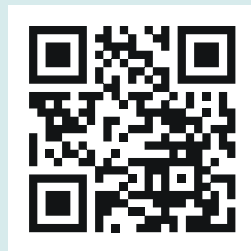

Scan this QR code or go to
LEGO.COM/PRODUCTFEEDBACK
and give us your short feedback about this LEGO® set
for a chance to win a cool LEGO prize.

Terms and Conditions apply*

DE: Du könntest GEWINNEN. Es gelten die Teilnahmebedingungen* **FR: Tu pourrais GAGNER.** Des conditions s'appliquent* **IT: Potresti VINCERE tu.** Termini e condizioni sono applicabili* **ES: Puedes GANAR.** Aplican términos y condiciones* **PT: Poderá GANHAR.** Aplicam-se termos e condições* **JA: プレゼント付き! 利用規約が適用されます*** **ZH: 轻松获奖. 条款和条件适用*** **KO: 상품의 주인이 되어보세요. 소정의 약관이 적용됩니다*** **RU: Вы можете ВЫИГРАТЬ.** Действуют положения и условия* **PL: Szansa na WYGRANĄ.** Obowiązują warunki korzystania* **CS: Máte šanci VYHRÁT.** Platí všeobecné smluvní podmínky* **SK: Máte šancu VYHRAŤ.** Platia všeobecné zmluvné podmienky* **HU: TE IS NYERHETSZ.** Felhasználási feltételek érvényesek* **RO: Ai putea CÂȘTIGA.** Se aplică termeni și condiții* **BG: Можете да СПЕЧЕЛИТЕ.** Има определени правила и условия* **LV: Tu vari LAIMĒT.** Ir spēkā noteikumi un nosacījumi.* **ET: Sul on võimalus VÕITA.** Kehtivad tingimused* **LT: Jūs galite LAIMĖTI.** Taikomos sąlygos*
*LEGO.com/productfeedback-terms



Friends

41741



2

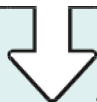
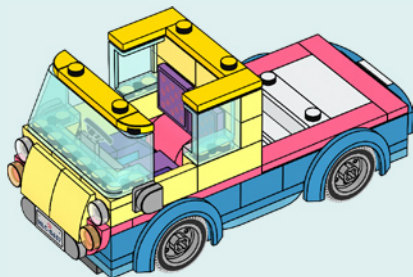
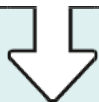

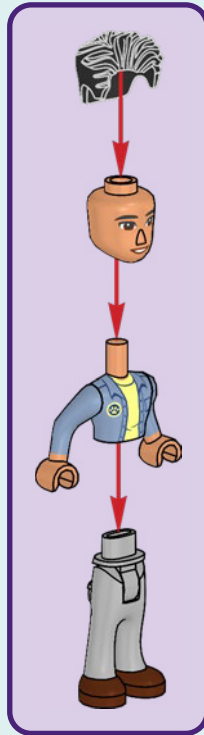

DR. MARLON

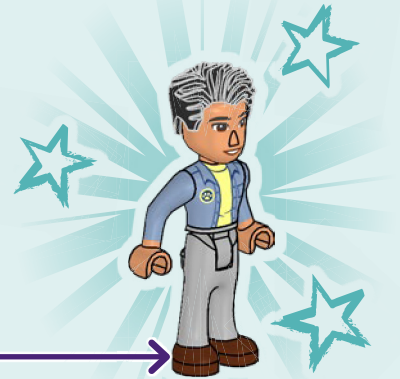

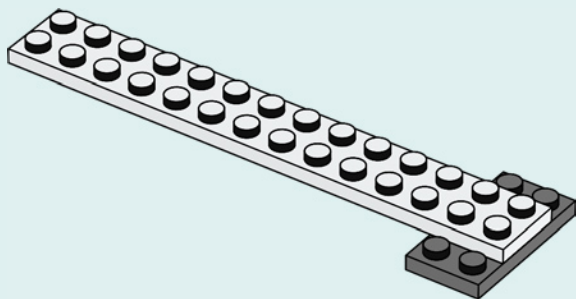
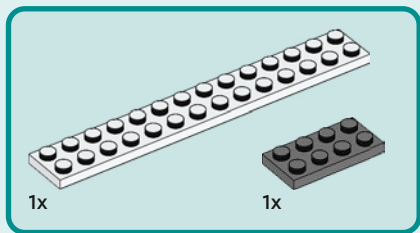
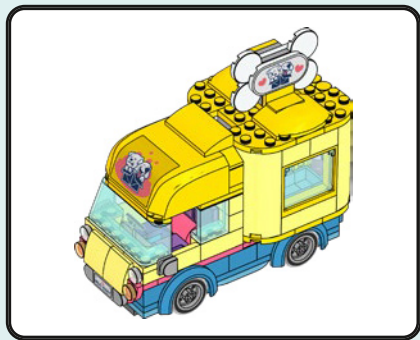

1



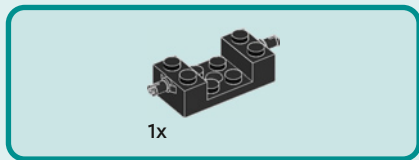

2

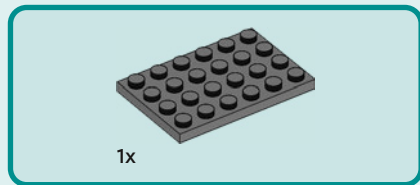
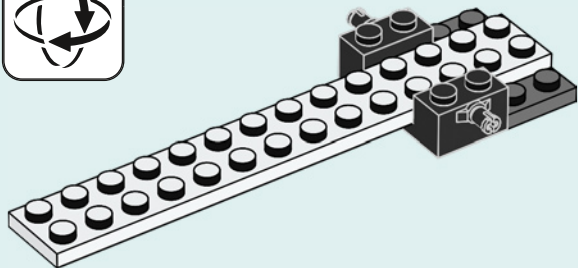

3

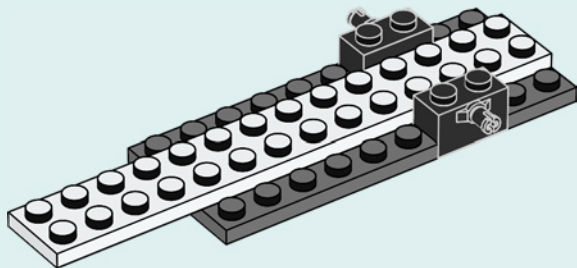

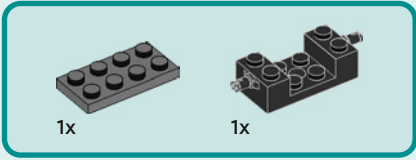

4

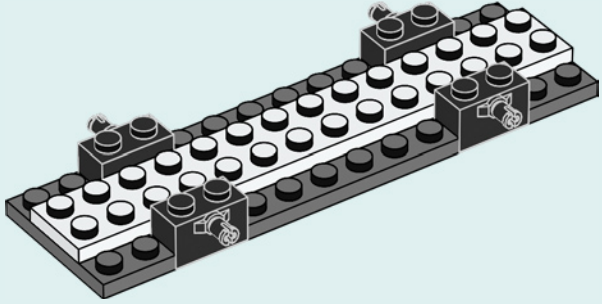



4x

5

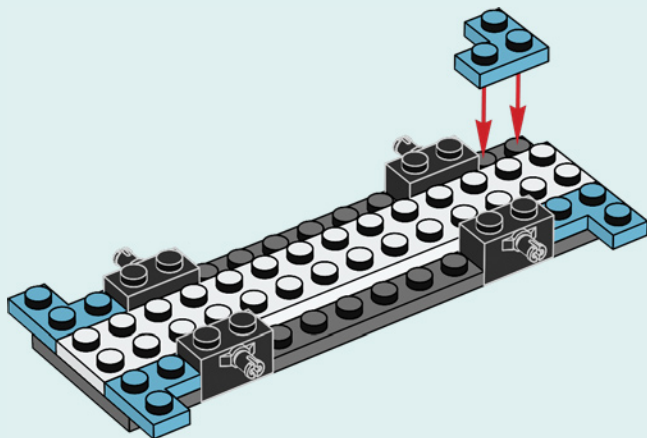



2x

6

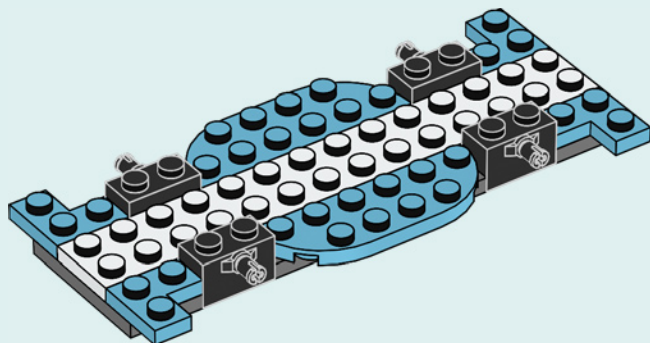

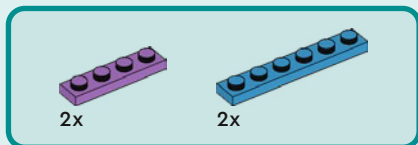

7

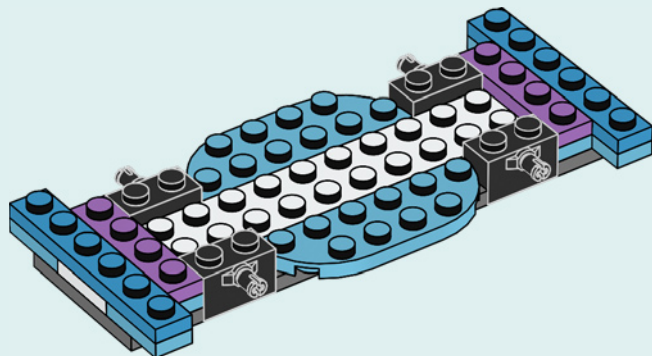

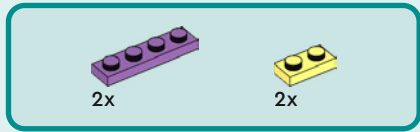

8

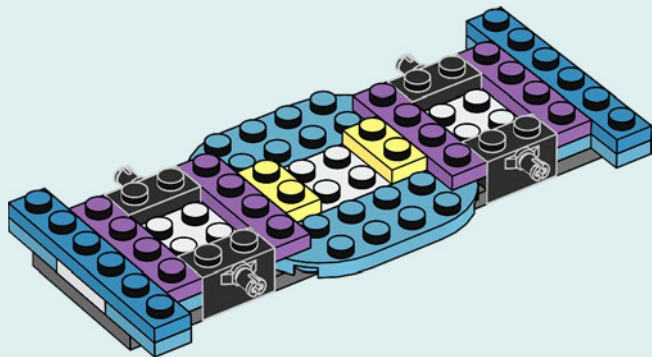

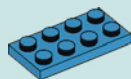

2x

9

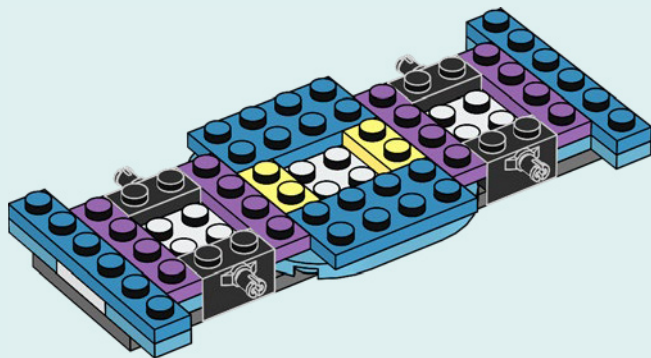

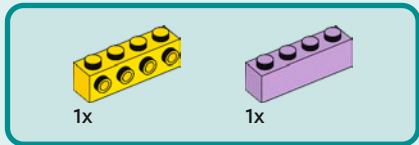

10

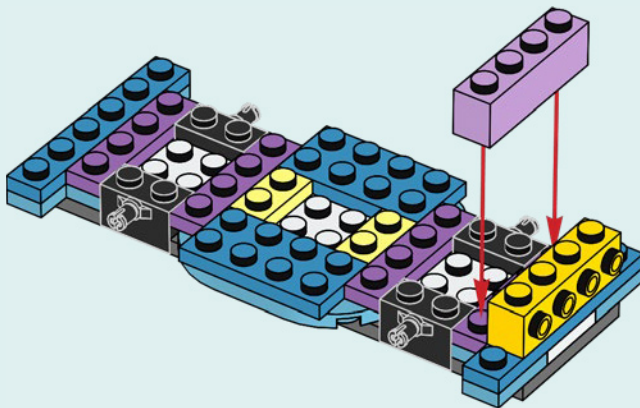



2x

11

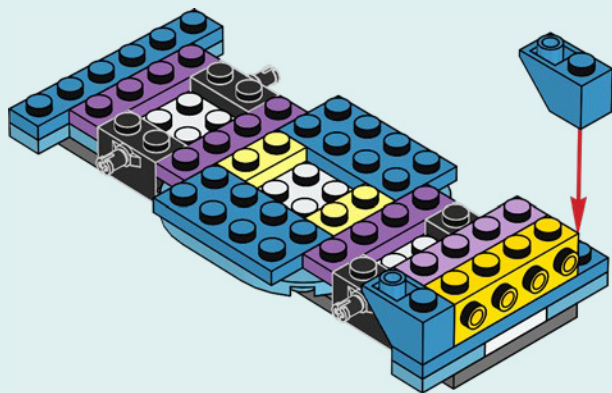

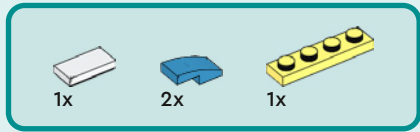

12

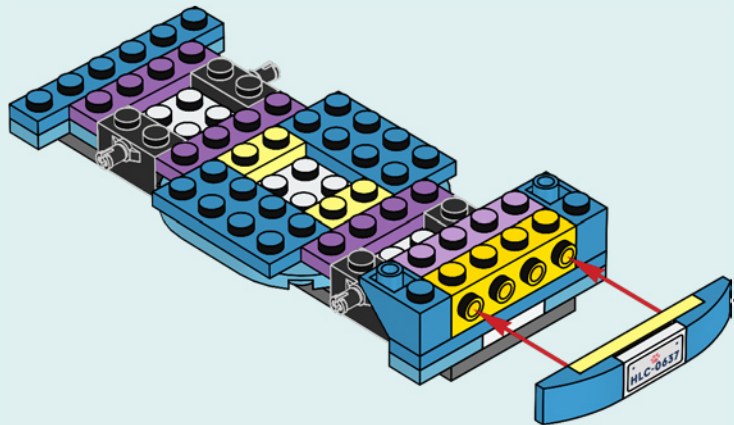
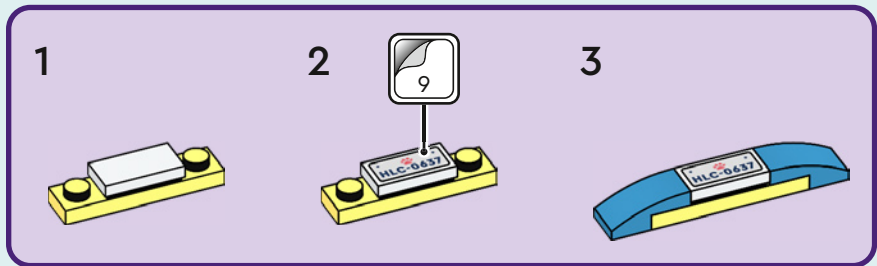

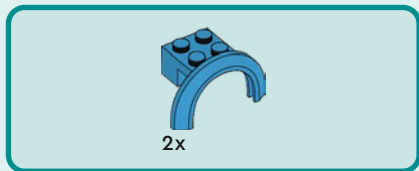

13

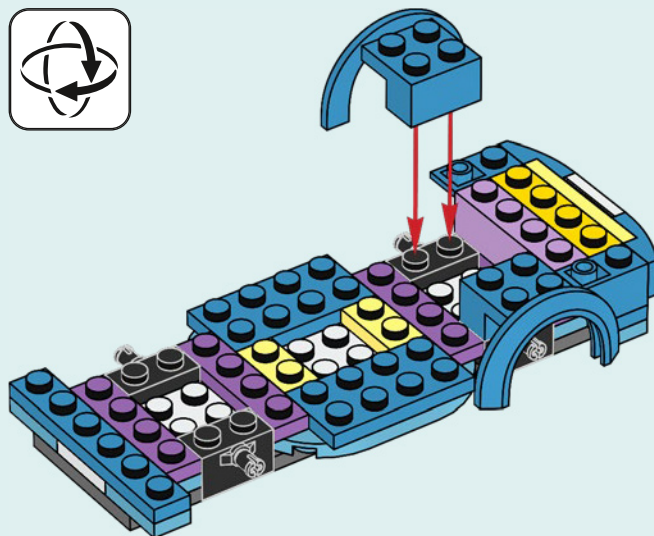



2x

14

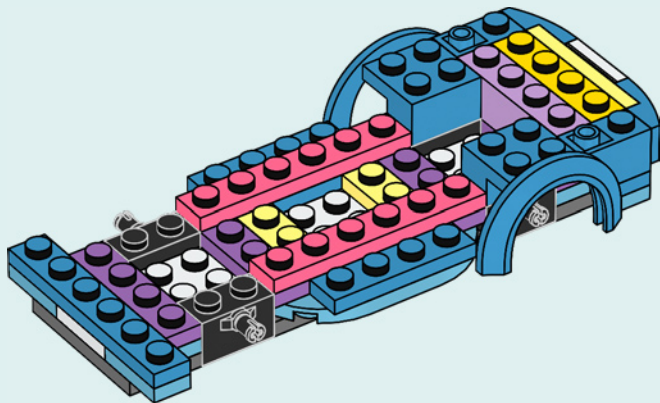

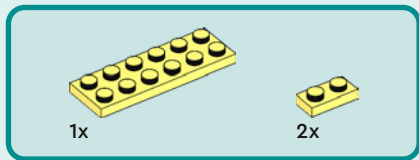

15

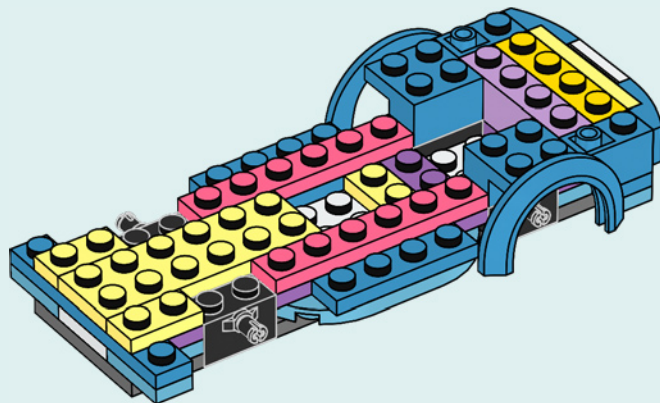



2x

16

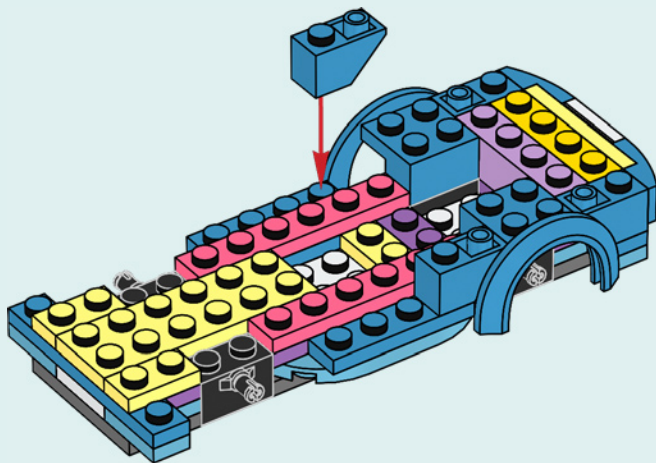



2x



2x

17

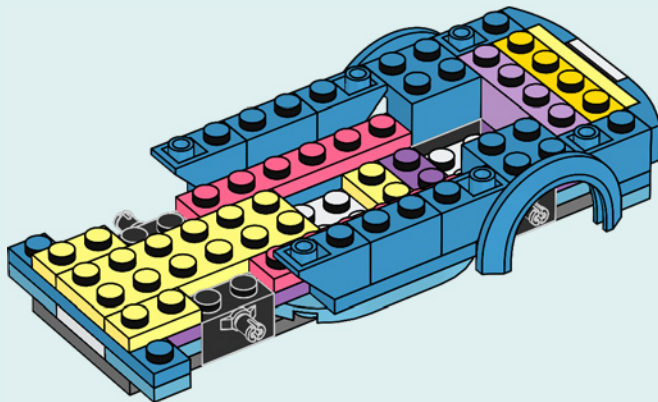

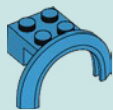

2x

18

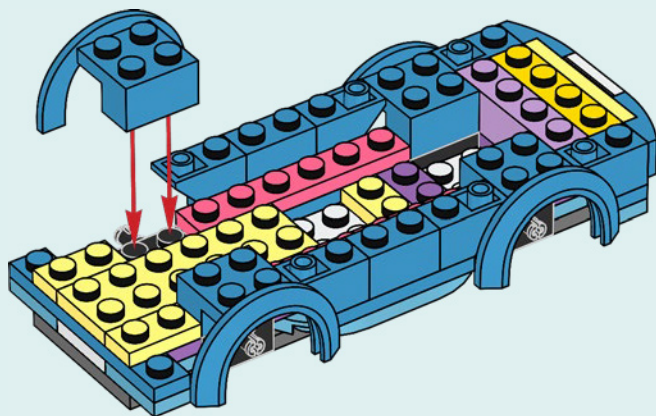



2x

19

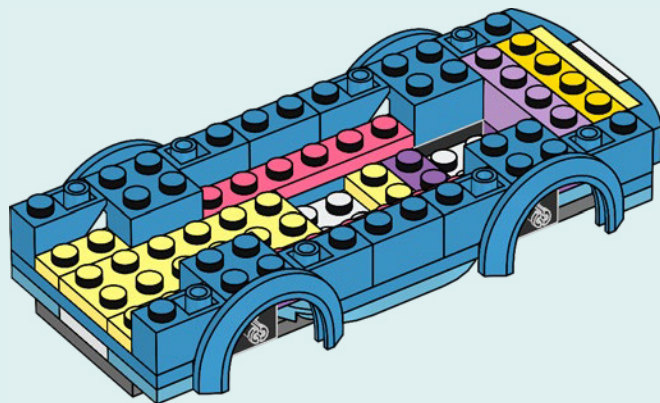

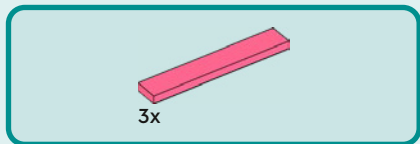

20

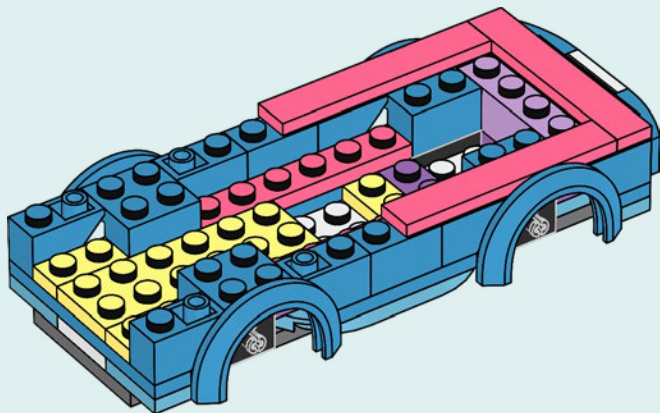

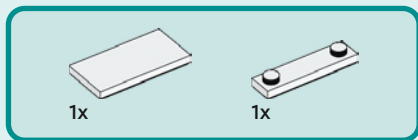

21

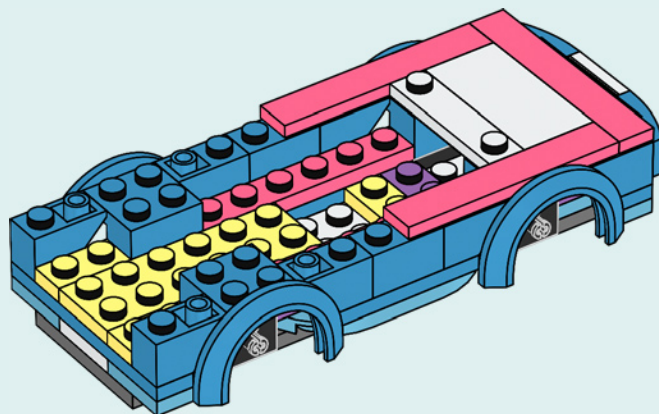

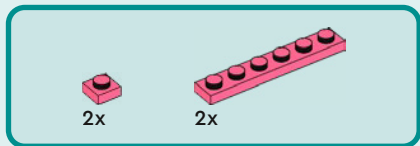

22

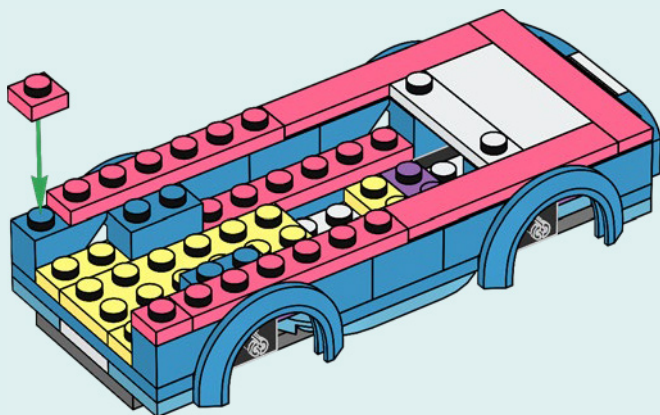

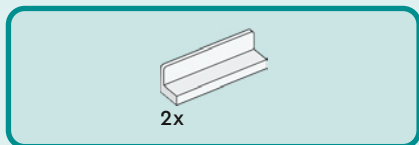

23

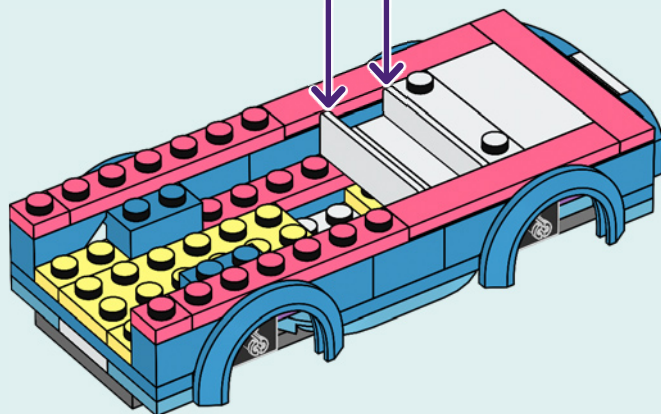
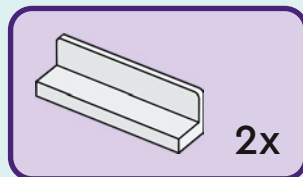



1x

24

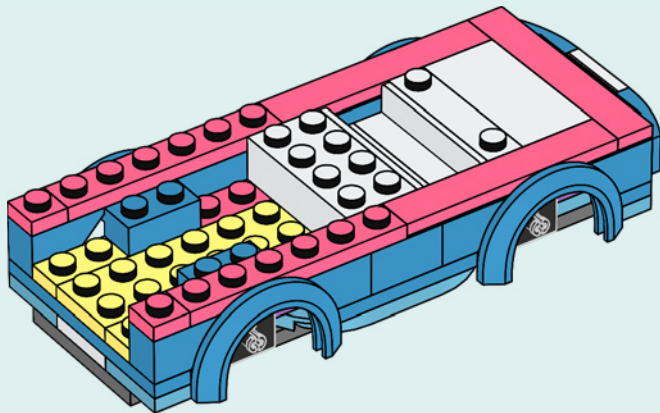



2x

25

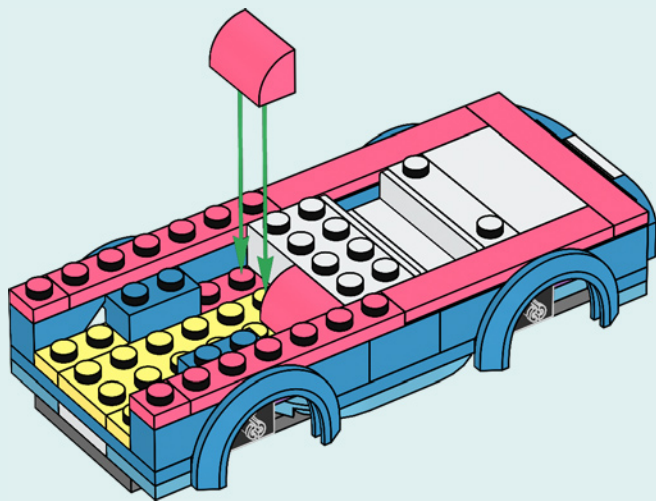



2x



1x

26

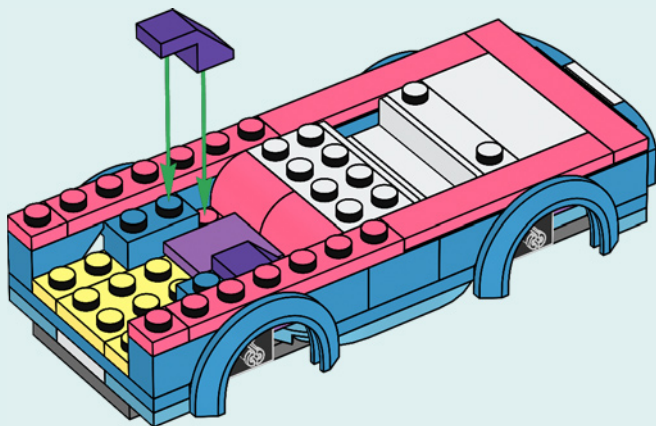



2x



1x

27

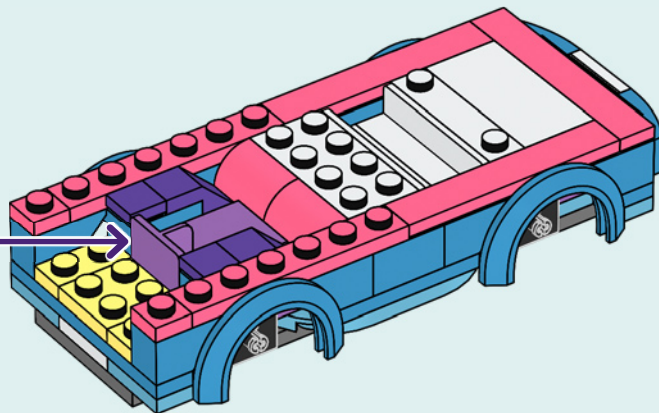
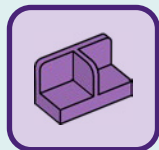

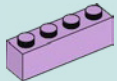

1x

28

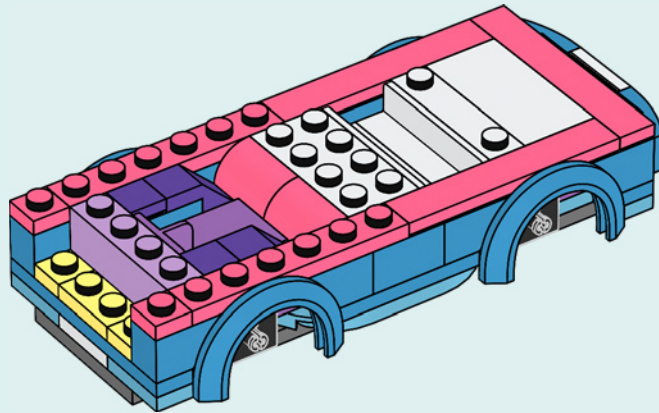

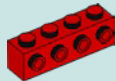

1x

29

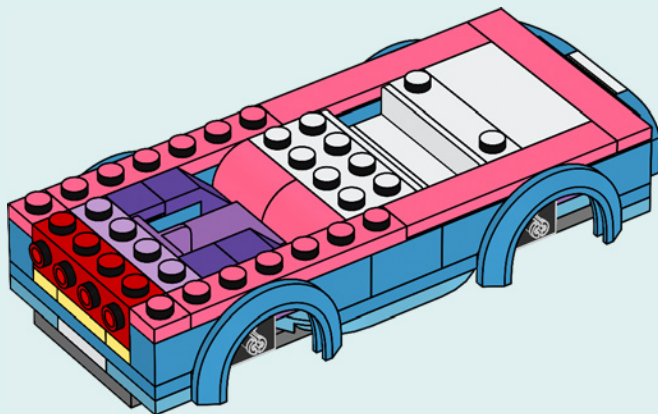



3x

30

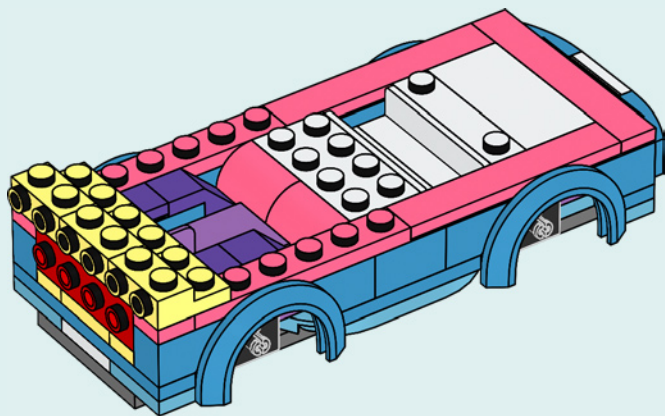

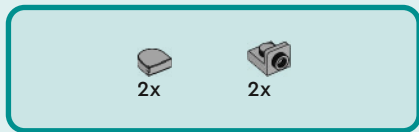

31

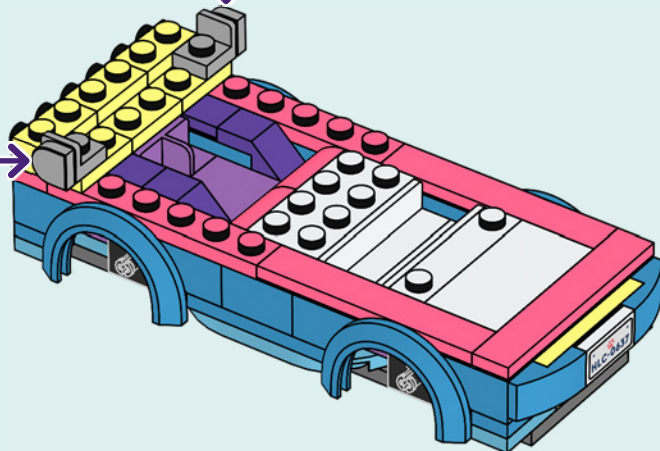
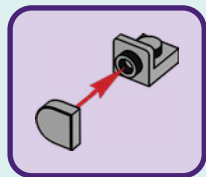
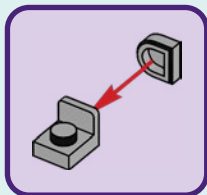



1x



2x

32

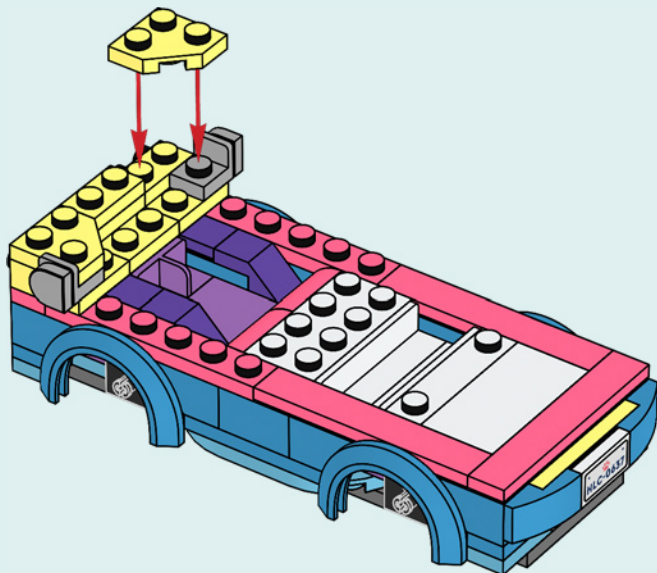



1x

33

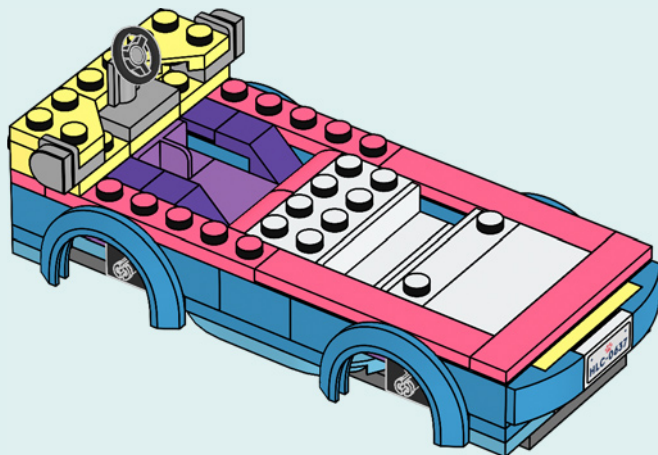



2x



2x

34

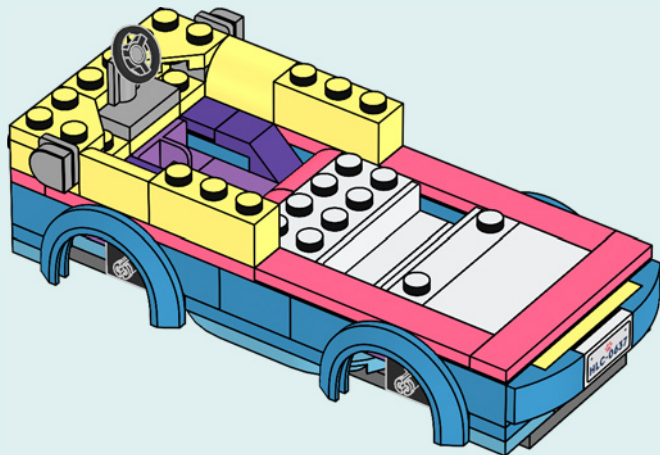



2x



1x

35

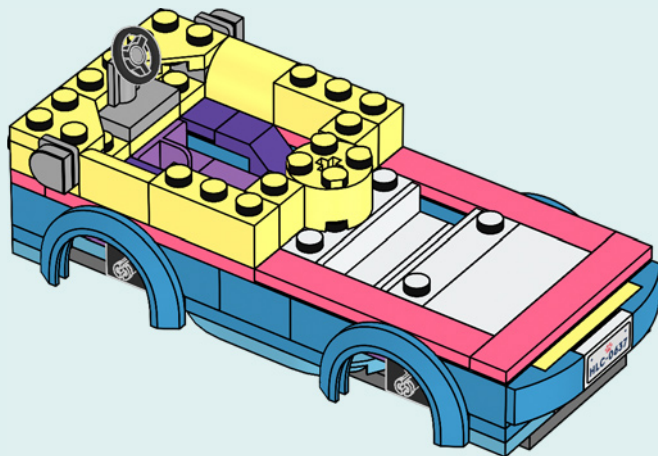



2x

36

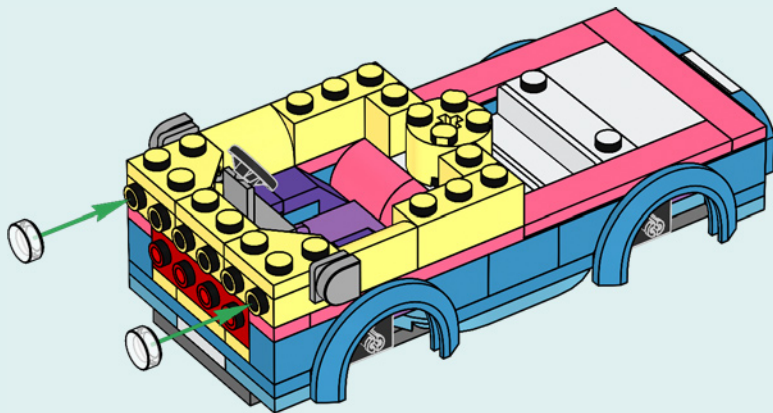

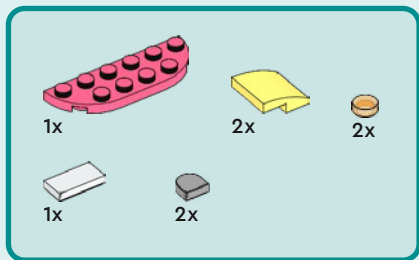

37

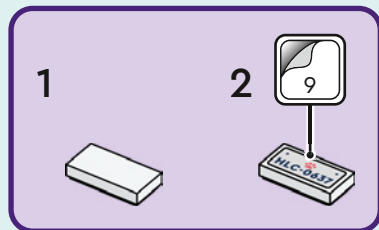

1

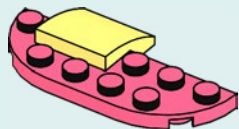

2

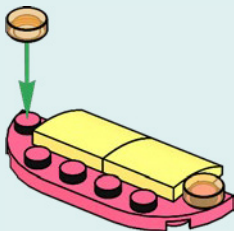

3

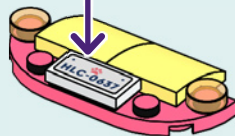

4

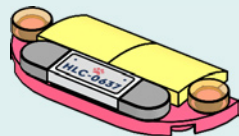

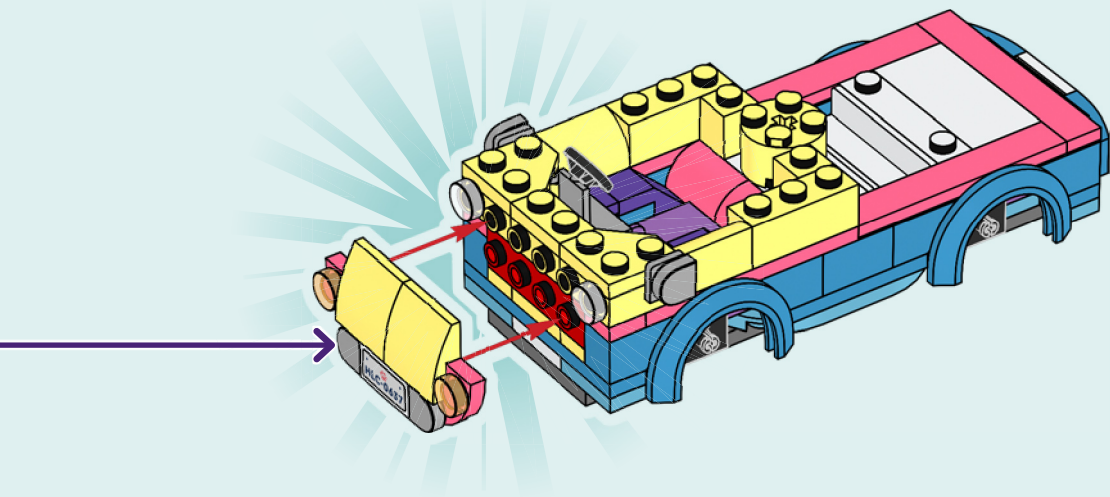

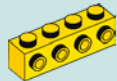

1x



2x

38

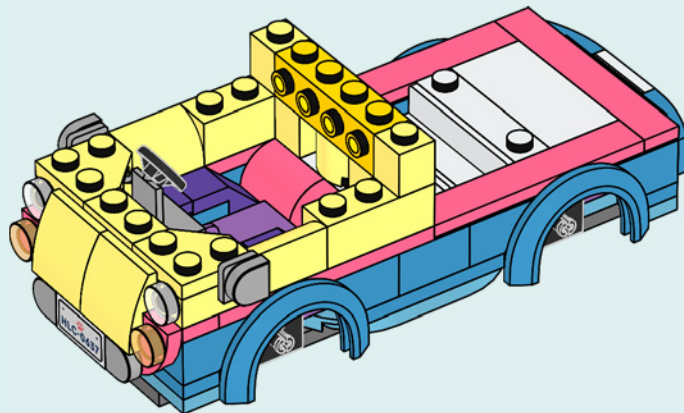



2x

39

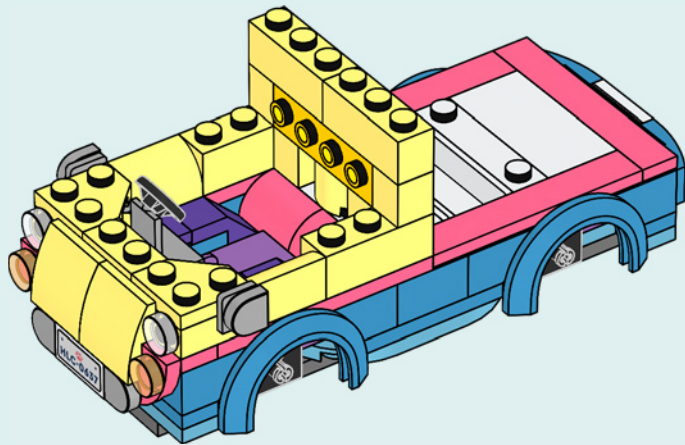



2x

40

1



2

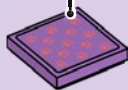

2x

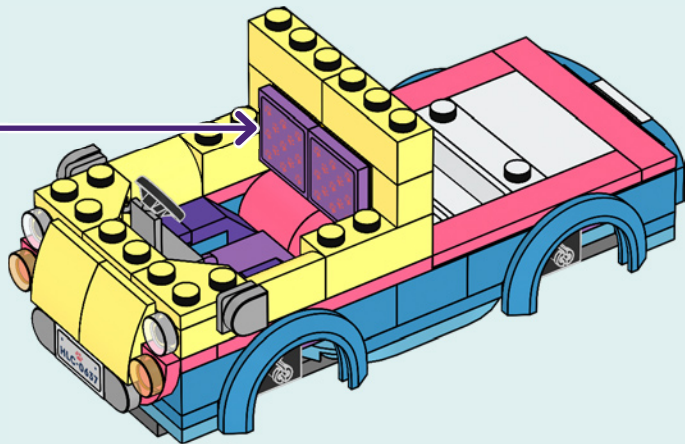



2x

41

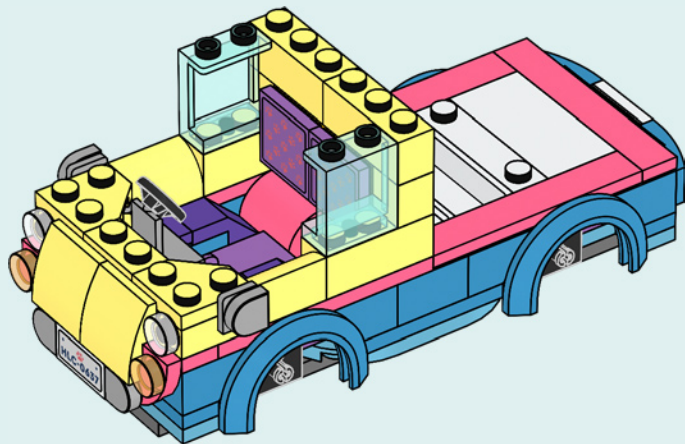



2x



1x

42

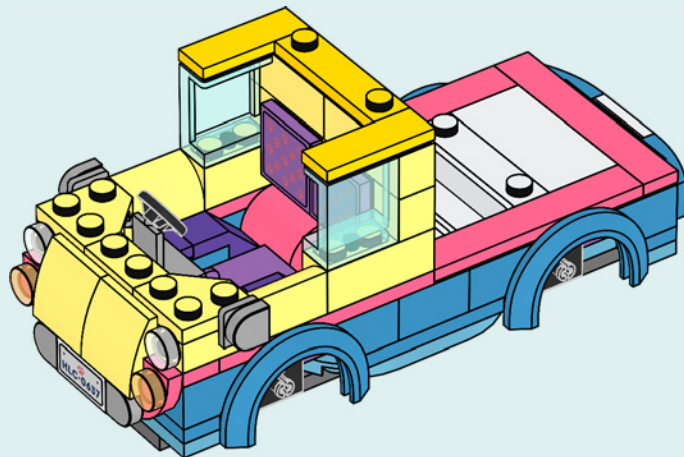

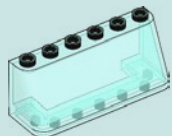

1x

43

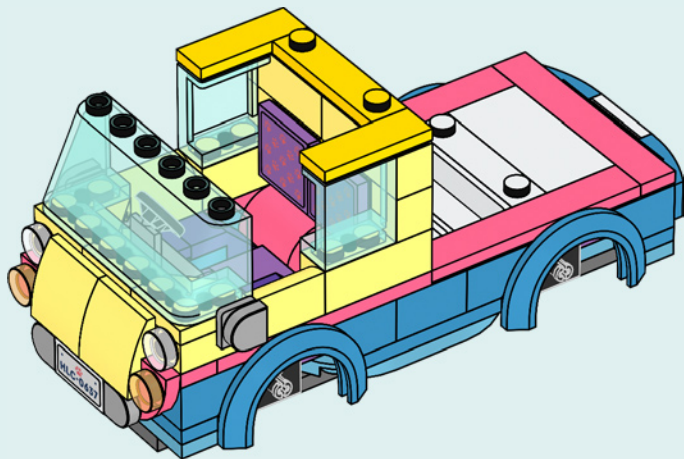



2x



1x

44

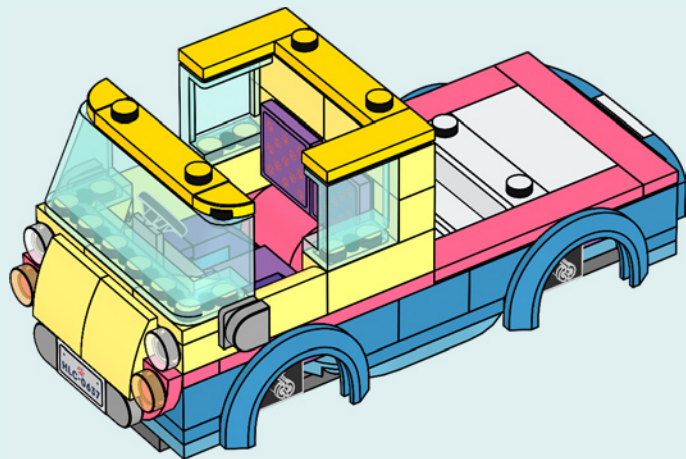



45

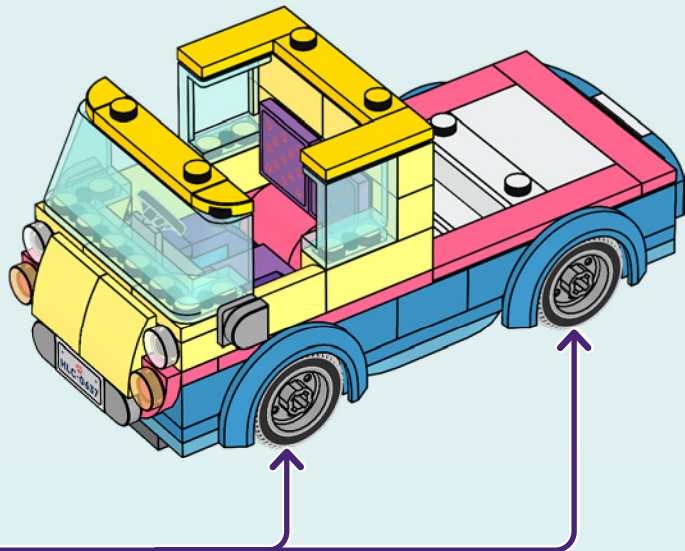
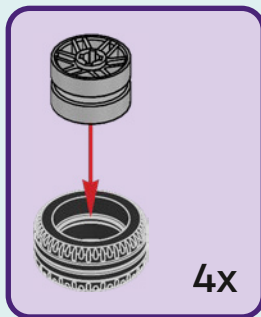



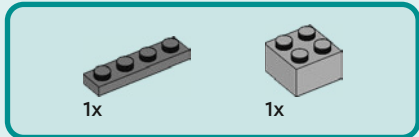
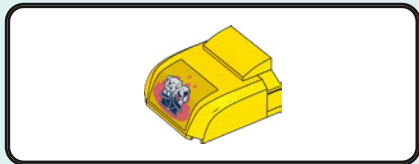

46

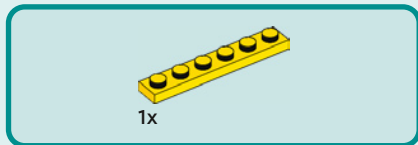
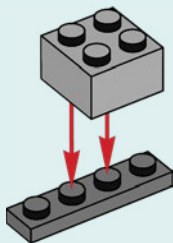

47

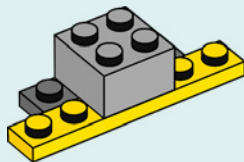



2x

48

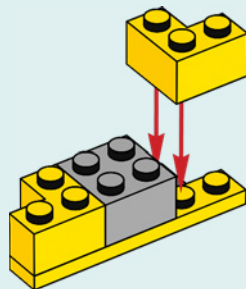

1x

49

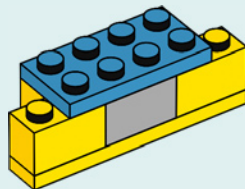

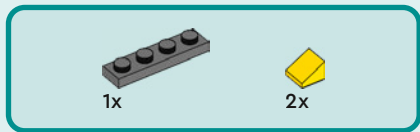

50

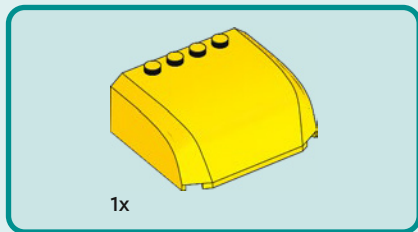
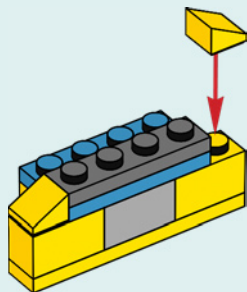

51

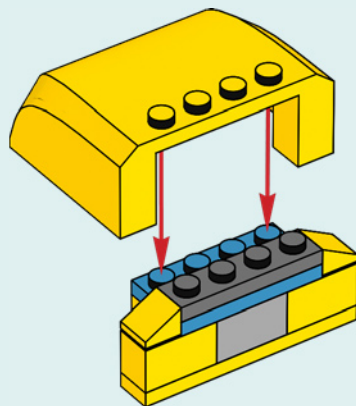

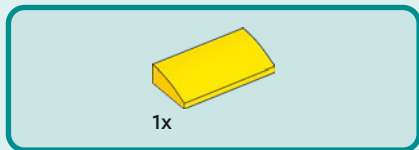

52

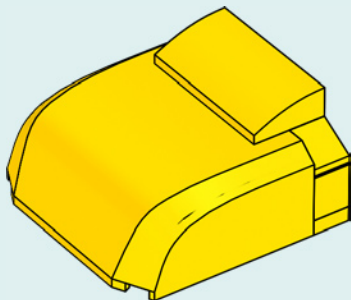

53

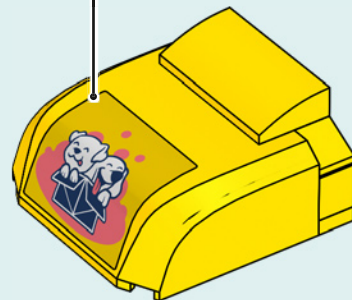

54

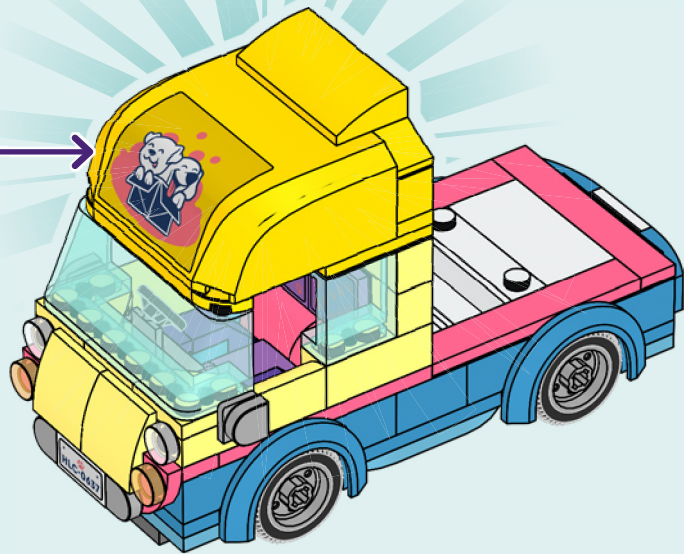

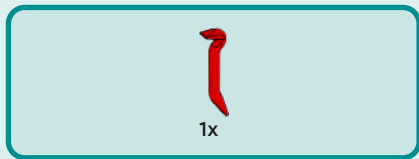

55

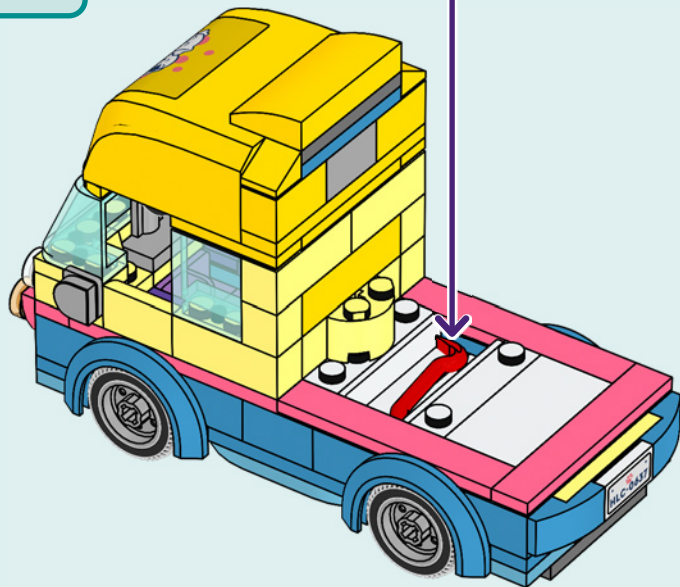

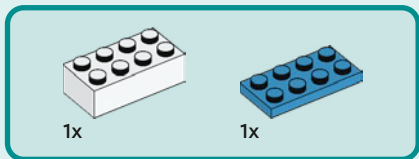
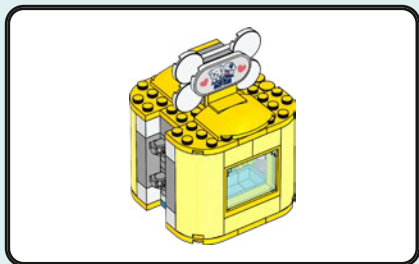

56

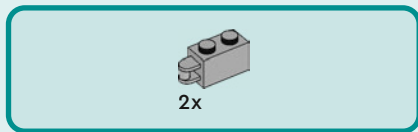
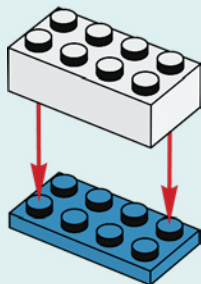

57

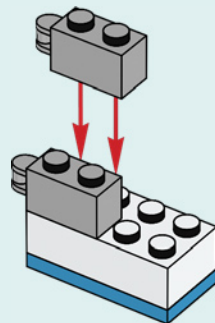



1x

58

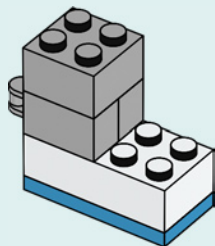

2x

59

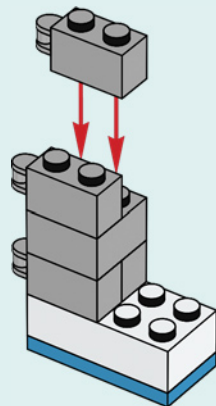

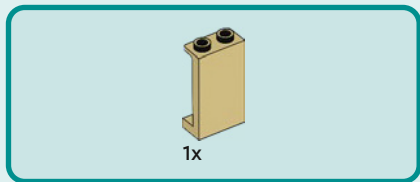

60

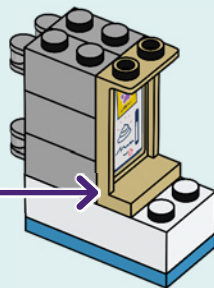
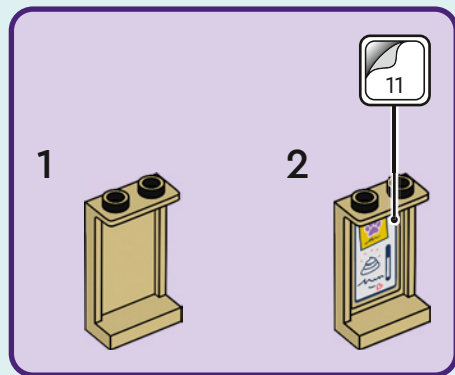



1x

61

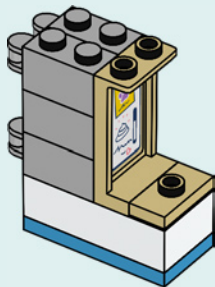

1x

62

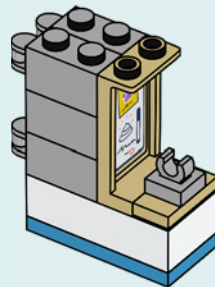



1x

63

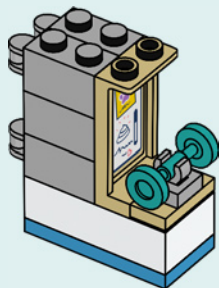

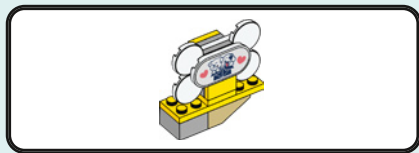

64

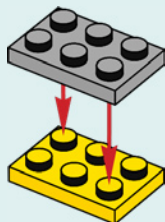

65

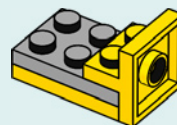

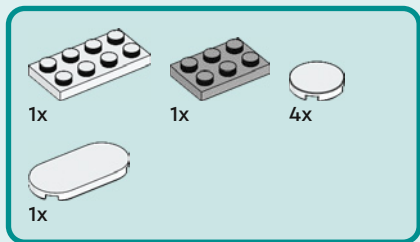

66

1

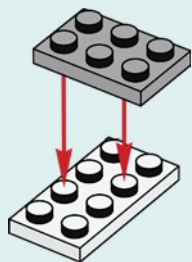

2

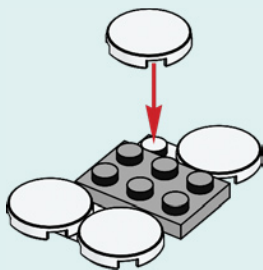

3

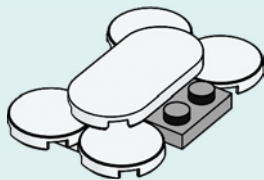

4

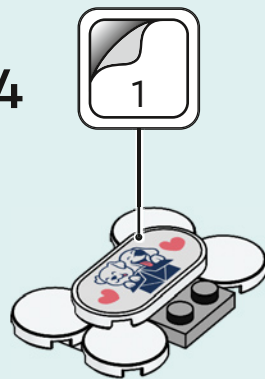



1x

67

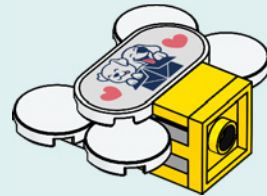



1x

68

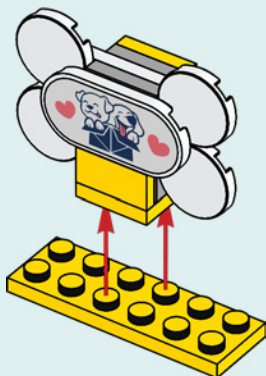



1x

69

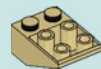
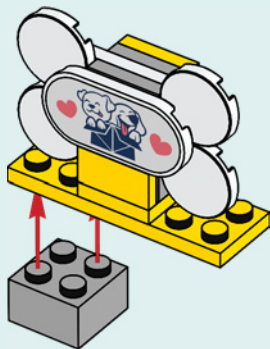

1x

70

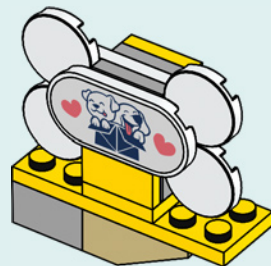

71

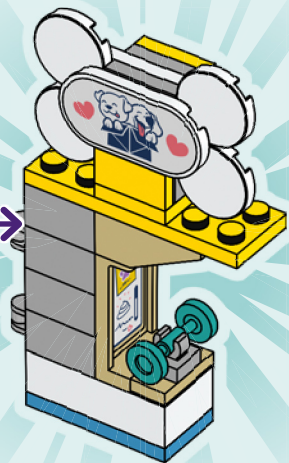

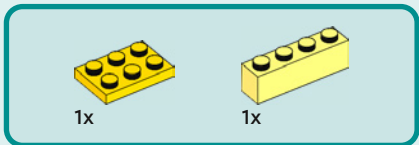

72

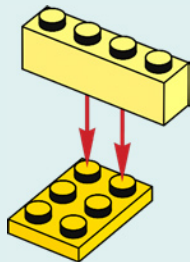

73

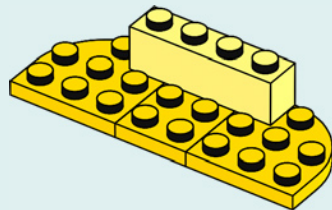



1x

74

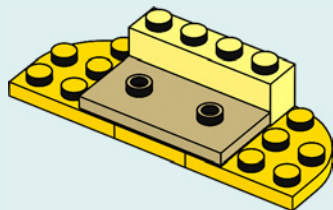

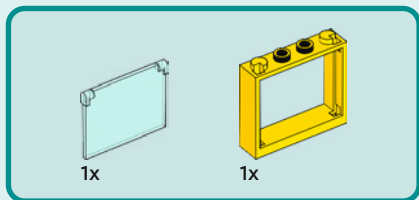

75

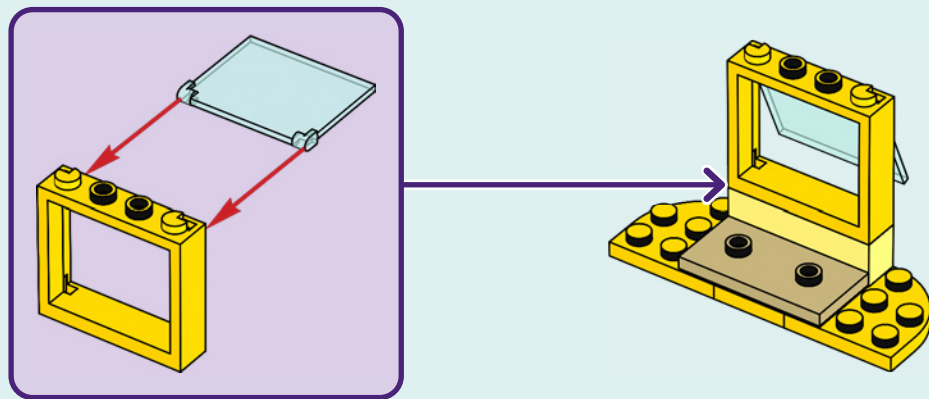



2x

76

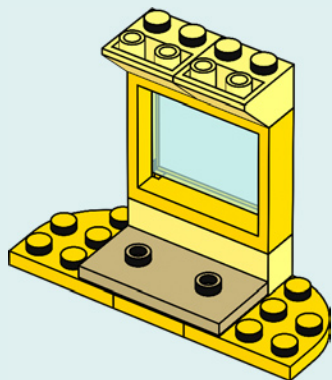

2x

77

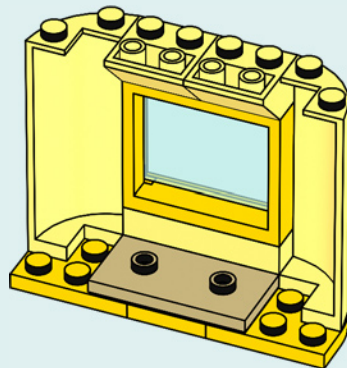



1x



1x

78

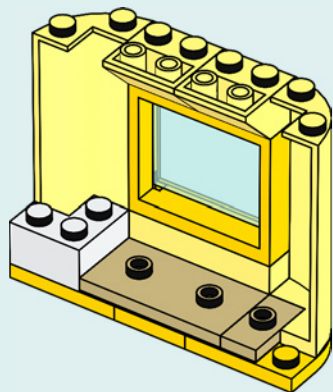

1x

79

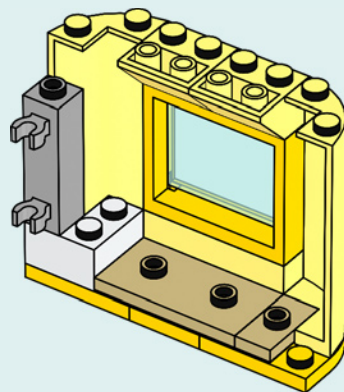

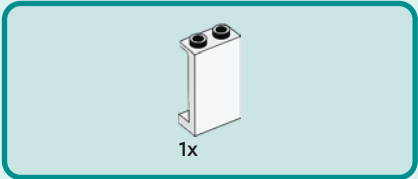

80

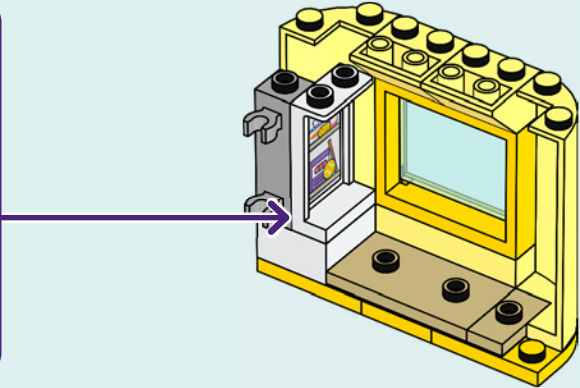
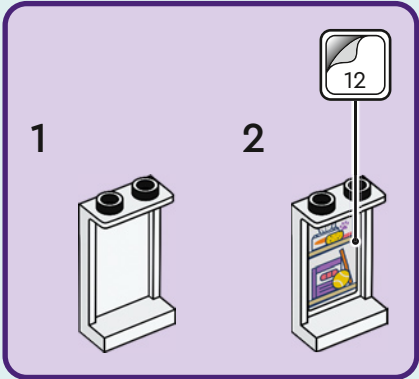



1x

81

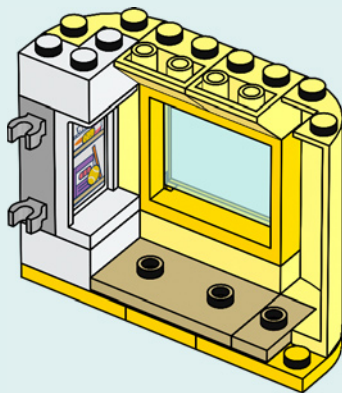



1x



1x



1x



1x

82

1

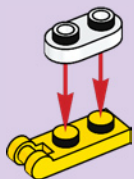

2

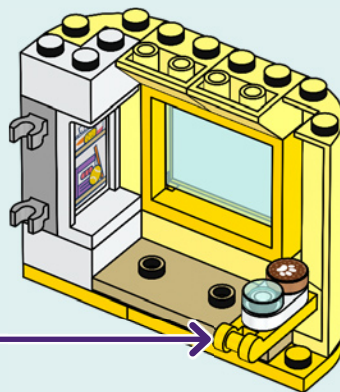

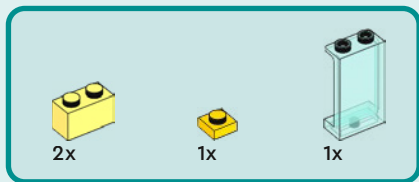

83

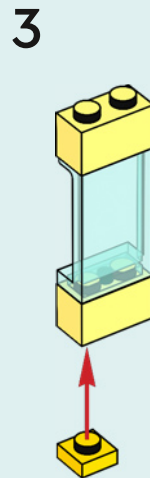
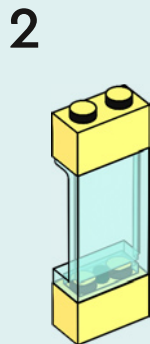
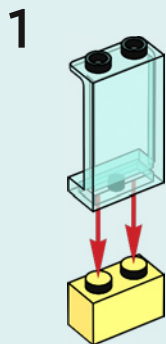

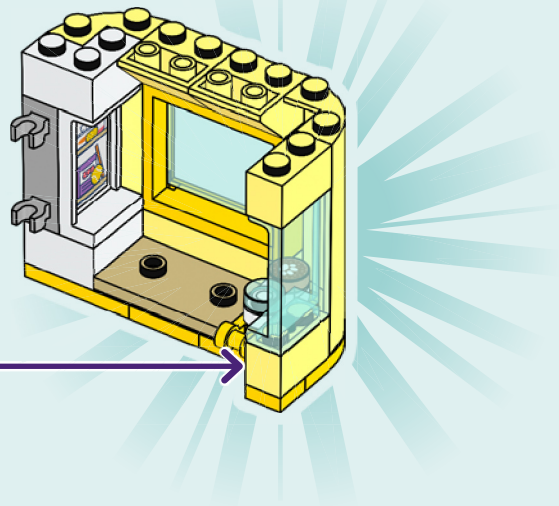

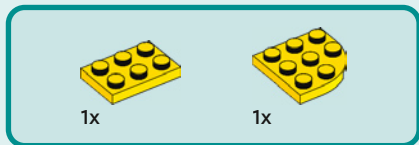

84

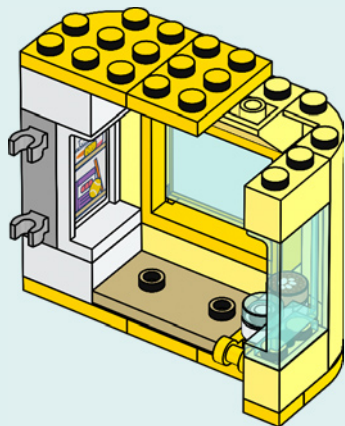

85

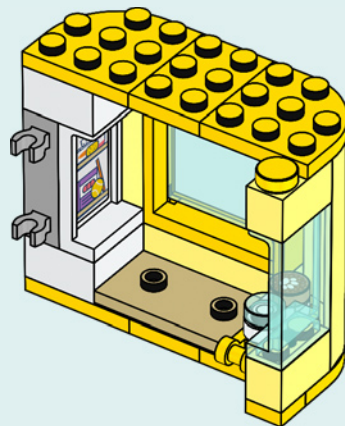

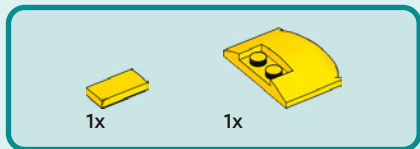

86

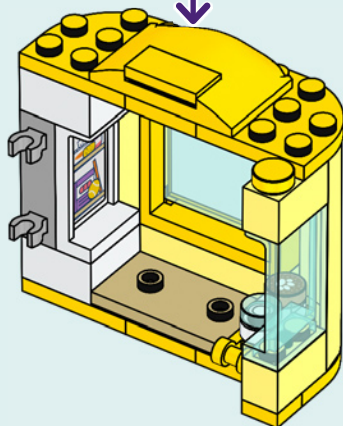
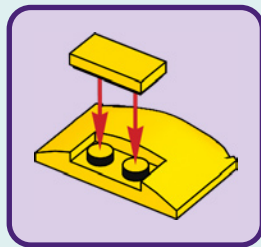



1x



1x

87

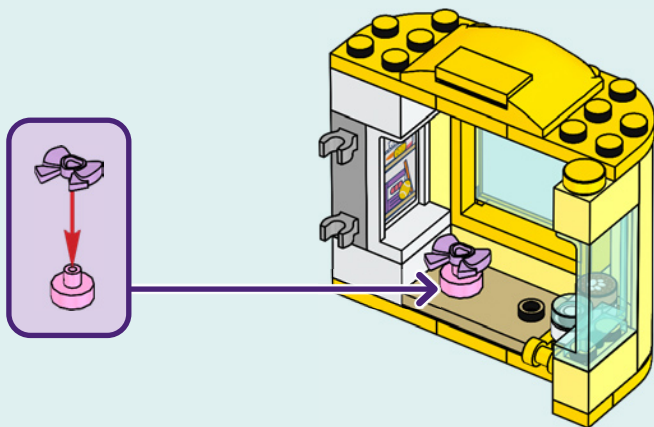



1x



2x

88

1

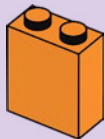

2

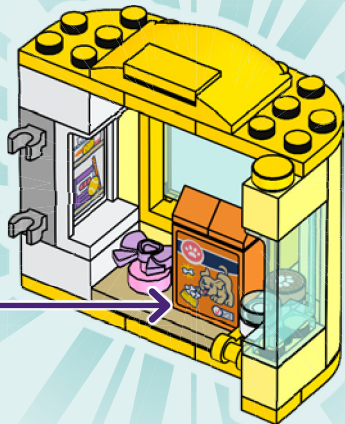

89

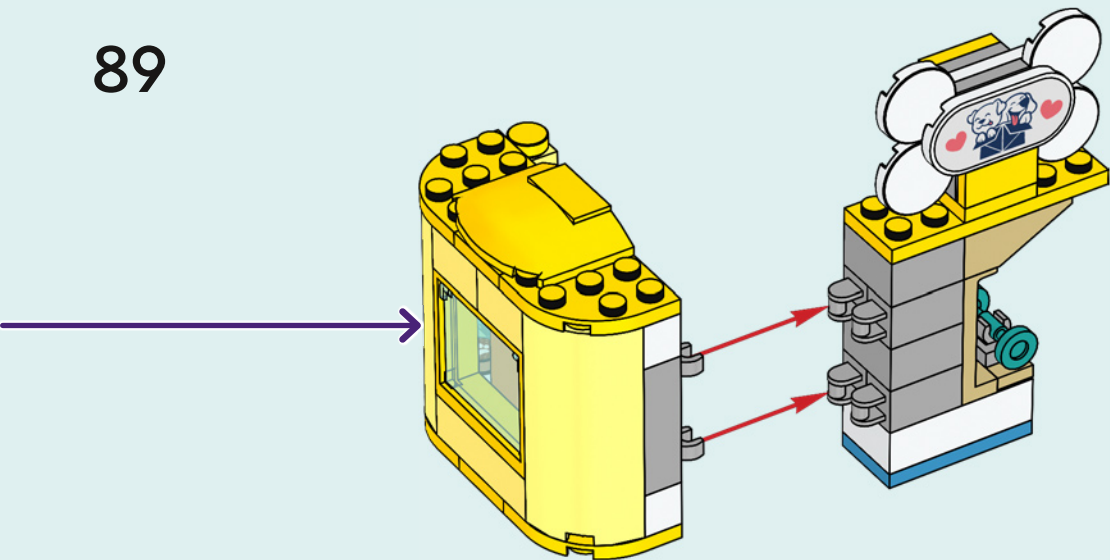

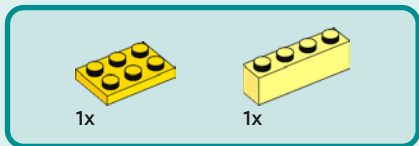
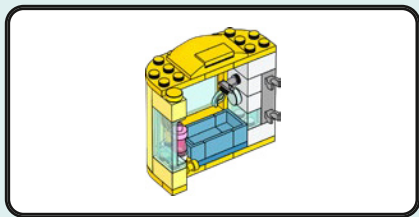

90

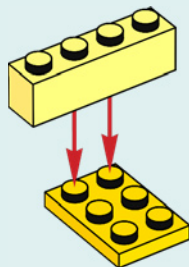

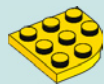

2x

91

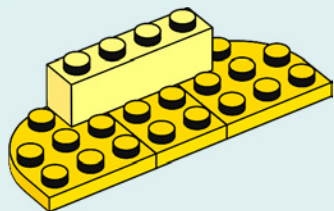

1x

92

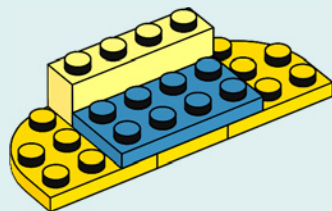

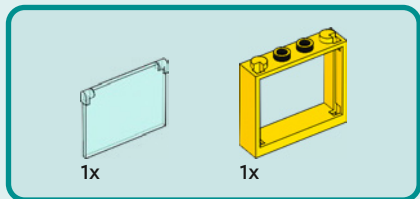

93

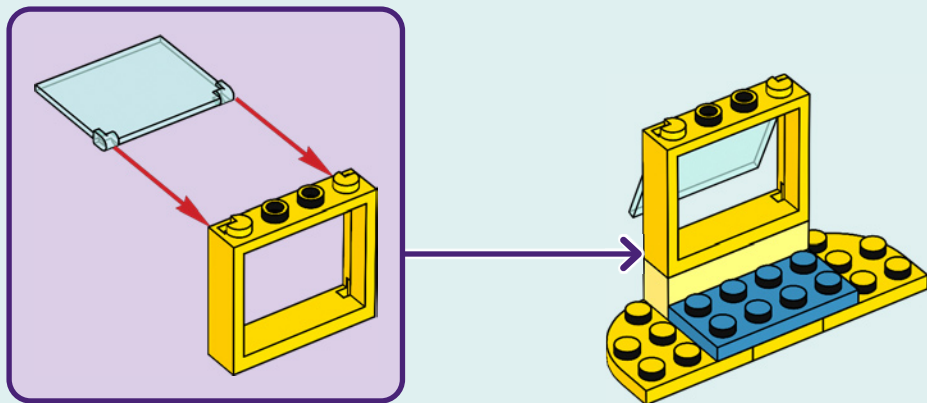



2x

94

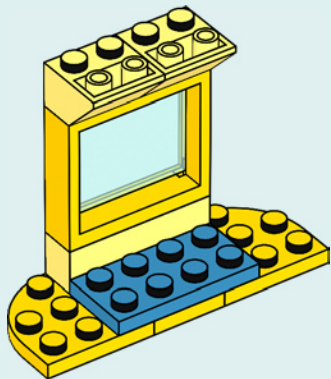

2x

95

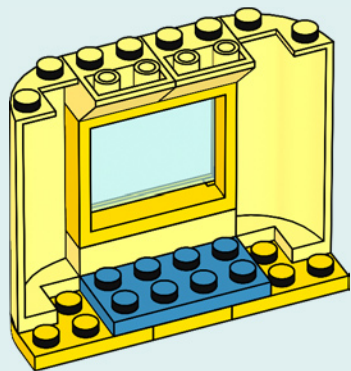



1x



1x

96

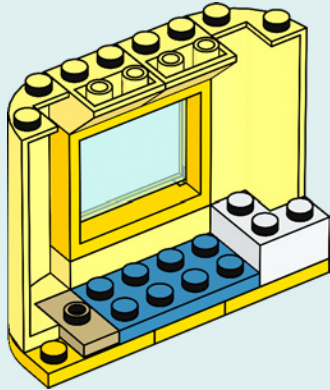

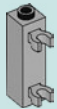

1x

97

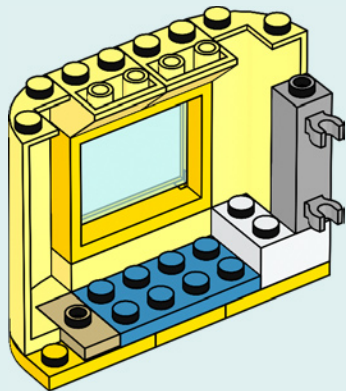

2x



2x

98

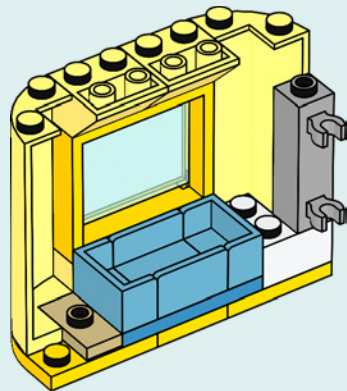

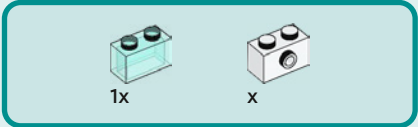
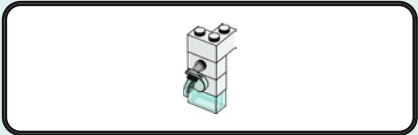

99

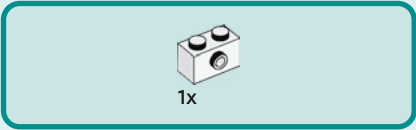
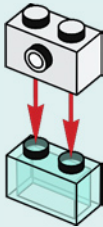

100

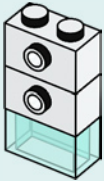



101

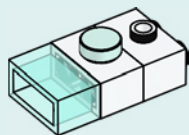

102

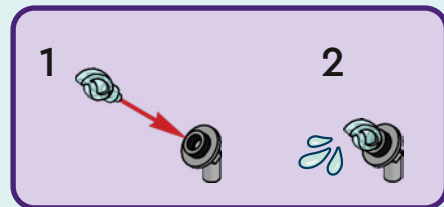



1x

103



104

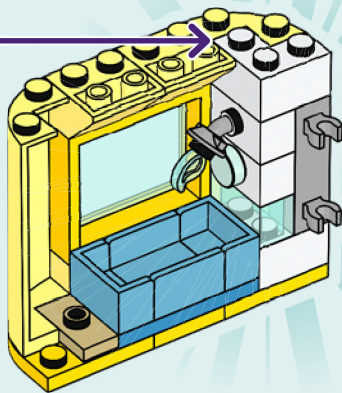

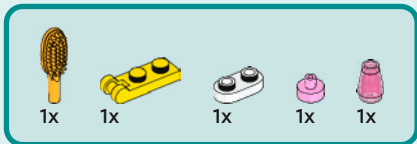

105

1

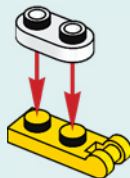

2



3



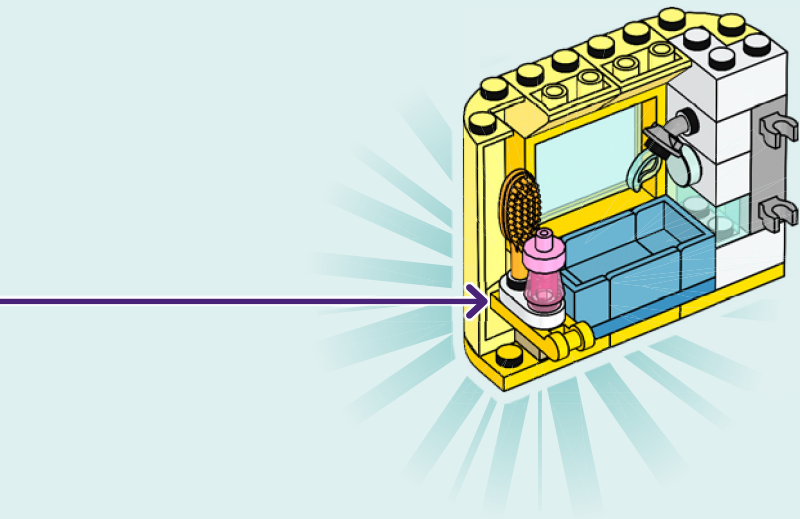



106

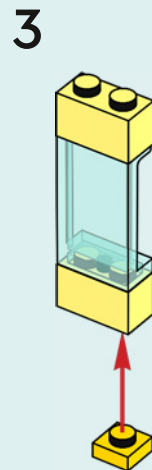
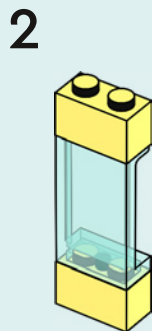
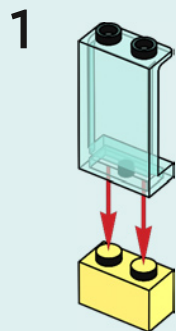

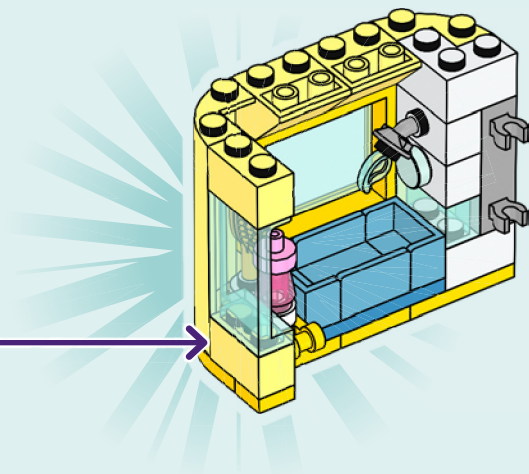

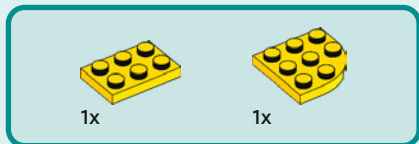

107

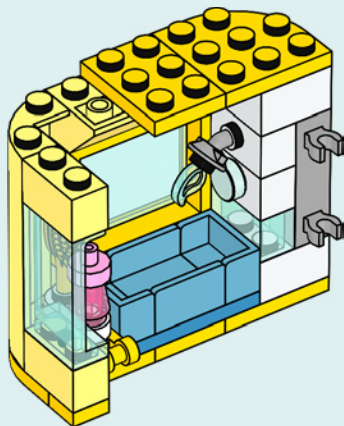

108

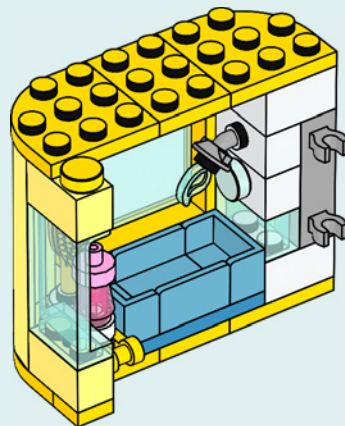

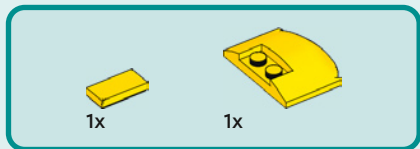

109

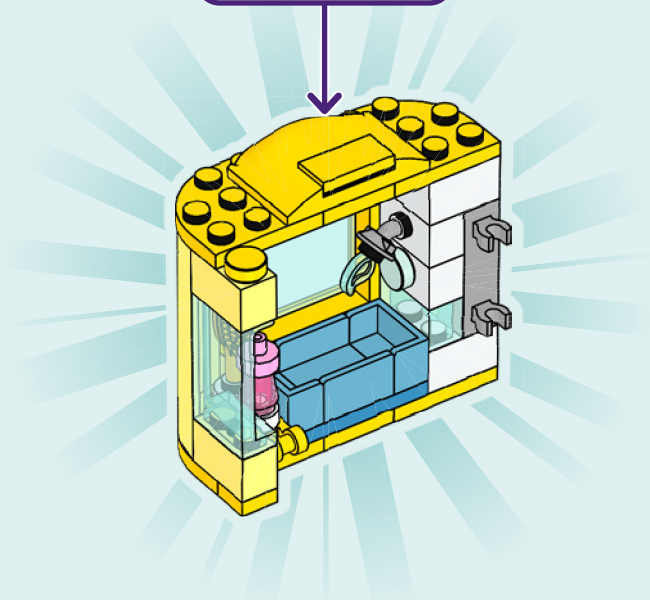
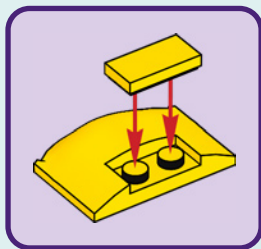

110

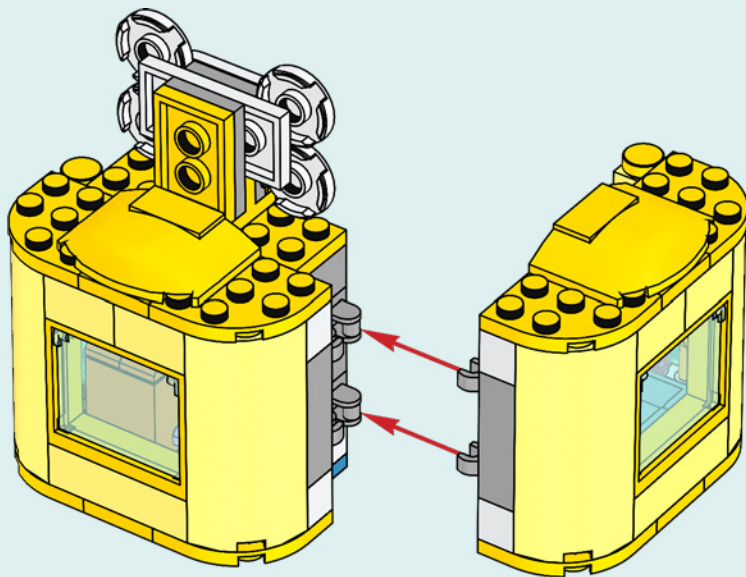

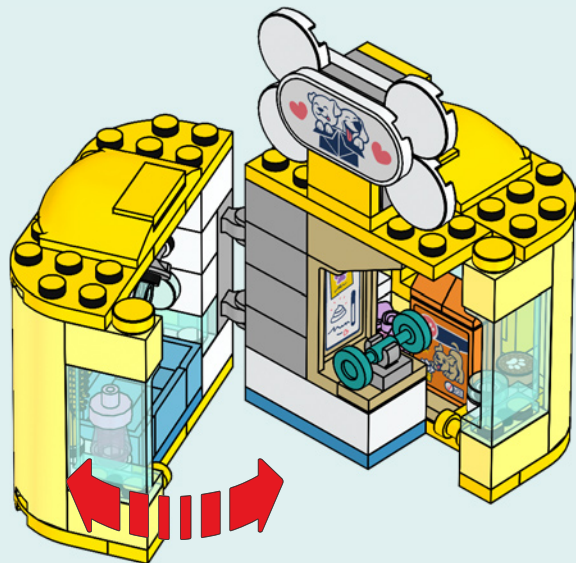

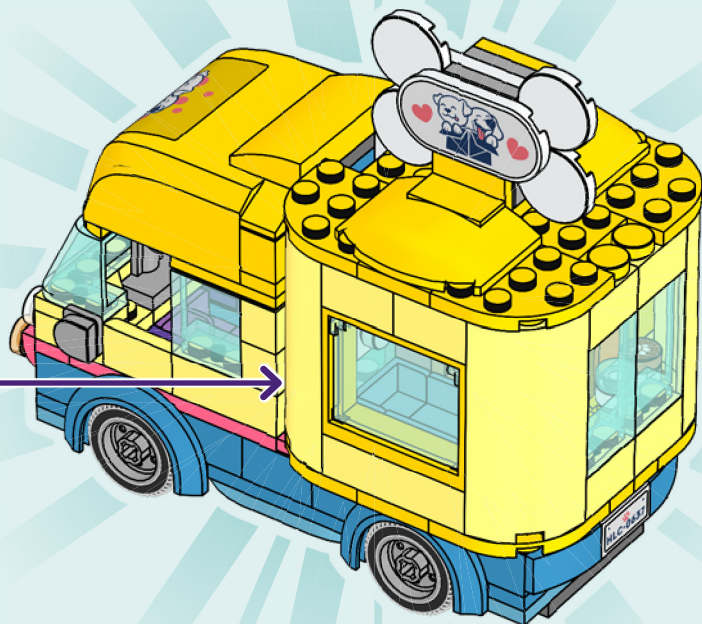

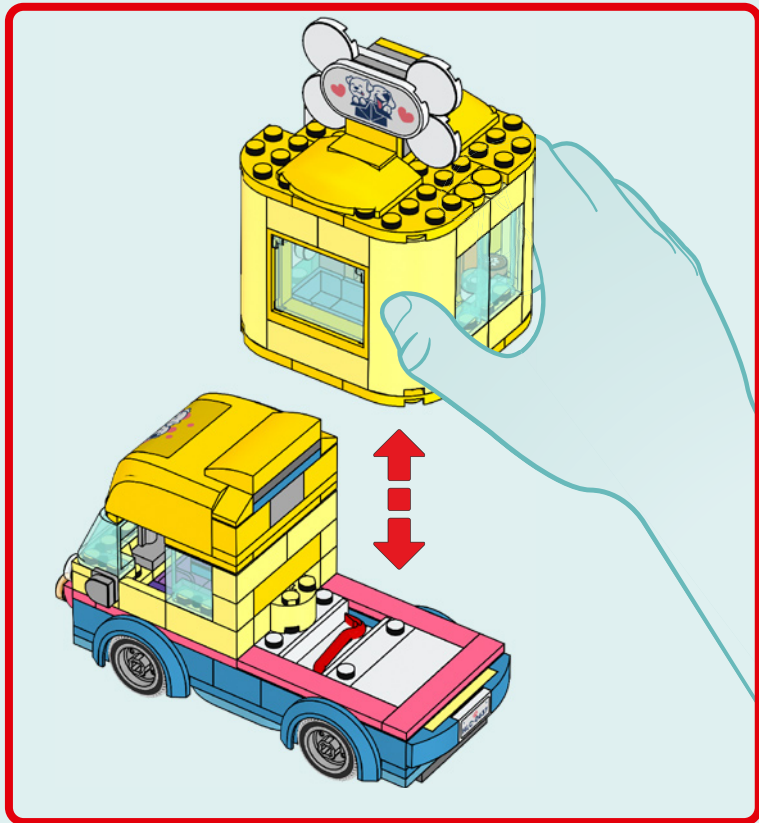

113

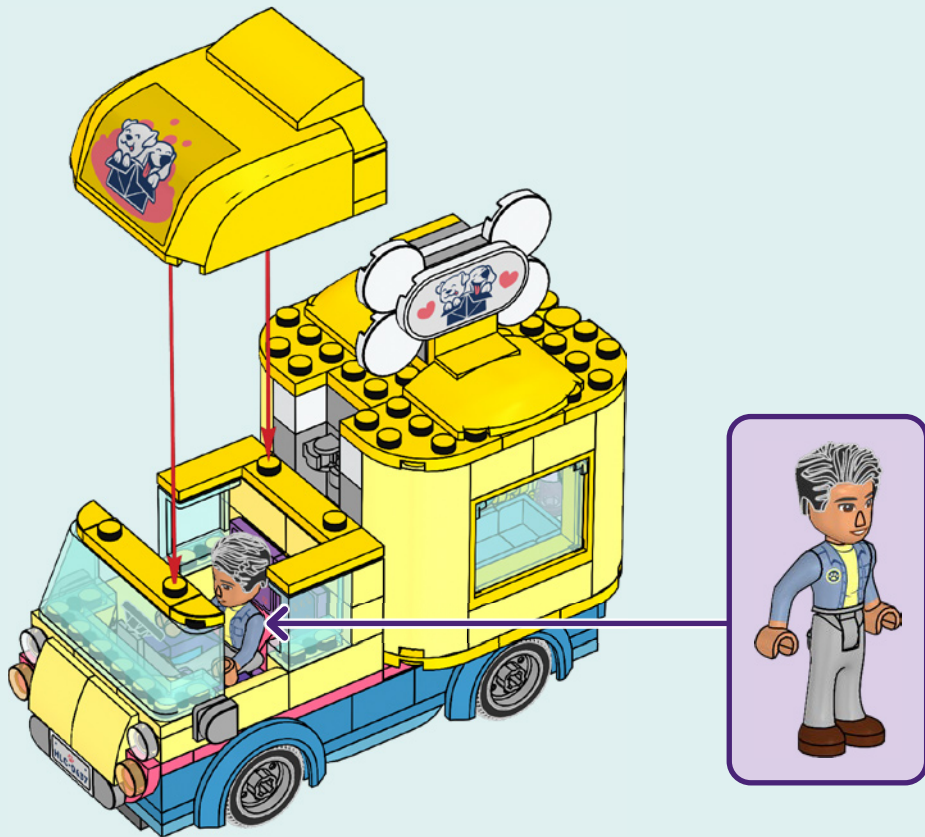

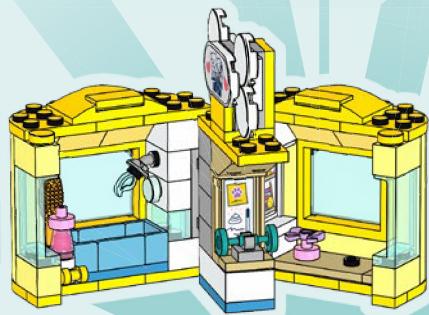
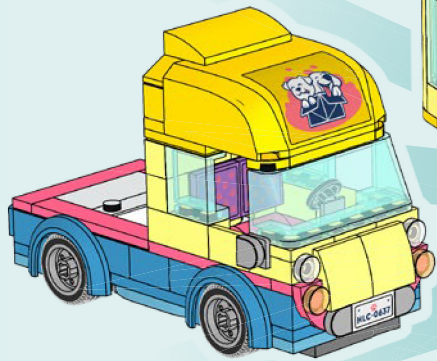



Friends

41731



41728



41743





Friends

41727



41741







1x
6317571



2x
6210272



4x
6044691



2x
306901



1x
4585448



2x
6383982



1x
6416595



4x
235701



1x
6329902



1x
6409761



1x
243101



2x
6061047



1x
6249091



2x
300101



1x
4560178



1x
302001

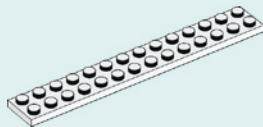

1x
6359065



1x
6409761



2x
6063943



3x
6092587



1x
6300317



1x
4185177



1x
4500453



1x
4234365



2x
4113233



1x
6213676



3x
6122047



1x
6294227



1x
6416619



1x
6416625



1x
6416629



1x
6425365



1x
6429452



1x
4599453



1x
4157223



2x
6284577



2x
4504381



2x
6195183



2x
302424



3x
306924



1x
6253273



2x
235724



2x
4515367



2x
4558172



8x
6167389



5x
302124



2x
4164073



2x
6257598



2x
6316742



2x
6397593



2x
6397593



1x
4597902



1x
366624



1x
366624

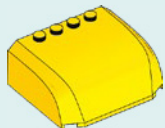

1x
6306879

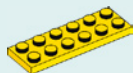

1x
379524



1x
6134617



1x
249626



1x
4226995



4x
6029208



2x
6369923



1x
6268814



1x
4119479



2x
6134287

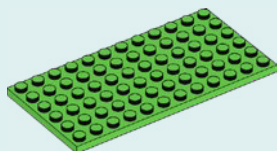

1x
4541414



1x
6416763



2x
6274738



1x
6357780



1x
6274739



2x
6253230



1x
6244910



2x
6239391



2x
6256060



2x
6253735

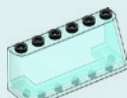

1x
6245193



2x
6223631



1x
6078590



1x
6421682



1x
6337637



1x
4624381



2x
6286831



1x
4164037



2x
4537936



1x
6109765



1x
6416593



1x
6418003



4x
6354662



2x
6274747



1x
4243668



2x
6212994



2x
6072668



1x
6275030



1x
6214343



1x
6135494



1x
6326748



3x
6284071



4x
6250597



1x
6308012



2x
6335328



2x
6320356



1x
6429790



4x
6029209



4x
6198932



3x
4211387

2x
4515369



2x
6221607



2x
6000606



2x
4211065

2x
4211001



1x
4211115



3x
6296521



4x
6022083

4x
6022084



1x
6301835



5x
6201647



2x
6296494



2x
6298528

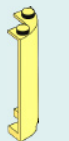

4x
6422378



2x
6296487

4x
6424475



4x
6201646



1x
6248756



2x
6036232

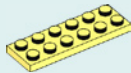

1x
6175294



2x
6167457



2x
6166863



1x
6287856



2x
6230579



8x
6298469



2x
6004943



2x
6137300



4x
6133729



5x
6210675



2x
6151657



2x
6146228



2x
6248486



4x
6293739



2x
6292824



1x
6322818



1x
6177197



2x
6139090



3x
6173813



4x
4619524

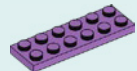

2x
4625027



1x
6023826



2x
6097867

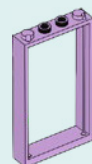

2x
6344416



2x
6258091



2x
6261293



1x
6381709



1x
6386989



4x
6422379



3x
6425367



 [LEGO.com/service](https://www.lego.com/service)