



CITY

60373





 **FR**
DONNEZ
OU
RECYCLEZ

 OU  OU 

ASSOCIATION MAGASIN DÉCHÈTERIE

Adresses sur quefairedemesdechets.fr



LEGO.com/sustainable-packaging



BUILDER



Apple and the Apple logo are trademarks of Apple Inc., registered in the U.S. and other countries and regions. App Store is a service mark of Apple Inc. Google Play and the Google Play logo are trademarks of Google LLC. Tencent and the Tencent logo are trademarks of Tencent Inc.

 LEGO.com/devicecheck

EN Ask parents' permission before going online | **DE** Eltern um Erlaubnis bitten, bevor du online gehst | **FR** Demande l'autorisation d'un parent avant d'aller en ligne | **IT** Chiedi il permesso ai tuoi genitori prima di andare online | **ES** Pídeles permiso a tus papás antes de conectarte a Internet | **PT** Pede autorização aos pais antes de acederes online | **JA** オンラインになる前に ほご者の方のきよかをもらおう | **ZH** 上网前应先征得父母的同意 | **KO** 온라인 접속 전에 보호자 동의가 필요합니다 | **RU** Спроси разрешения у родителей, прежде чем заходить в интернет | **PL** Poproś rodziców o zgodę, zanim wejdiesz do Internetu | **CS** Než půjdeš na internet, požádej rodiče o svolení | **SK** Skôr než pôjdeš na internet, vypýtaj si povolenie od rodičov | **HU** Kérj szülői engedélyt, mielőtt online csatlakoznál! | **RO** Cere permisiunea părinților înainte de a te conecta online | **BG** Поискайте разрешение от родител, преди да влезете онлайн | **LV** Pirms došanās tiešsaistē palūdz atļauju vecākiem | **ET** Enne Interneti kasutamist küsi vanematelt luba | **LT** Prieš prisijungdami prie interneto, atsiklauskite tėvų



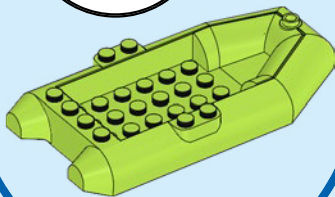
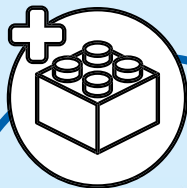

1

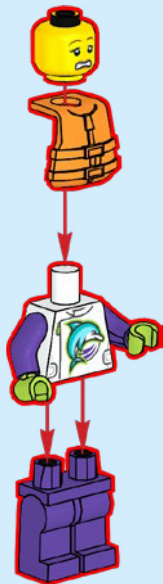

2

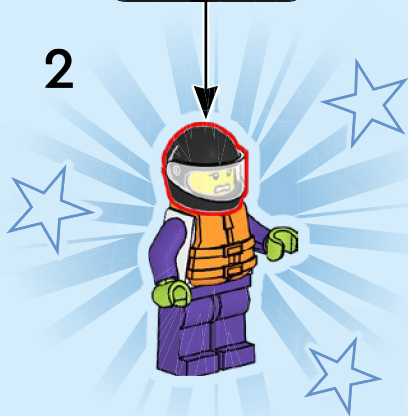
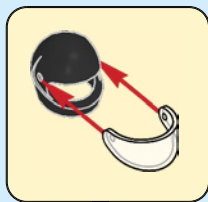

1

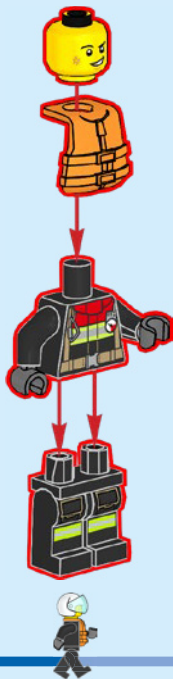

2

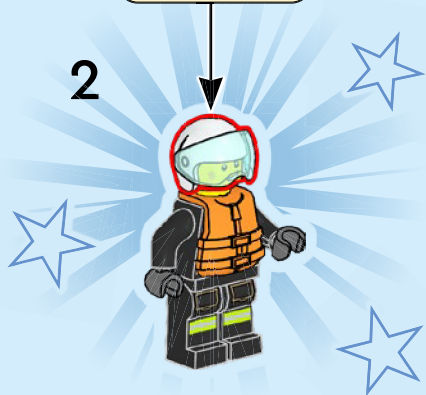
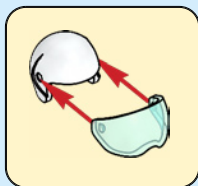



1

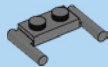

2

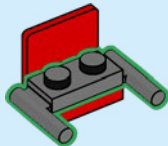

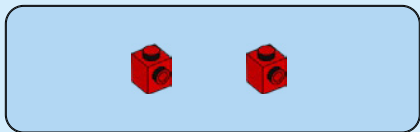

3

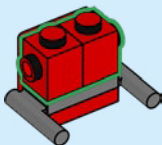

8



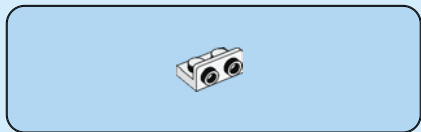

4

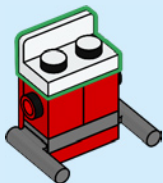

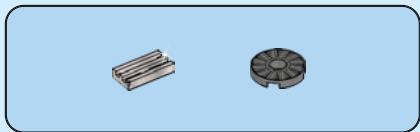

5



10



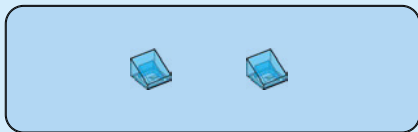

6

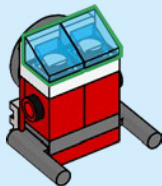
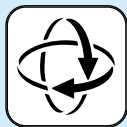

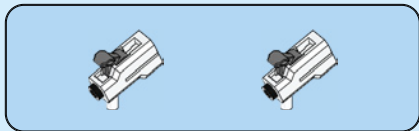

7

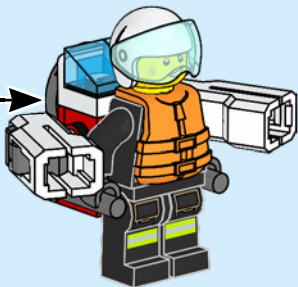

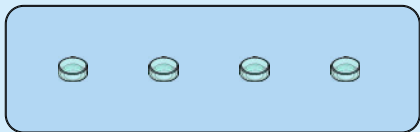

8

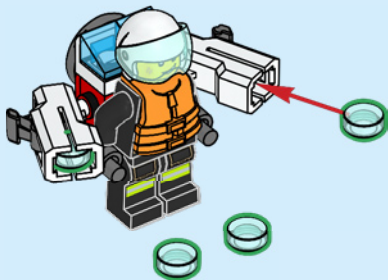

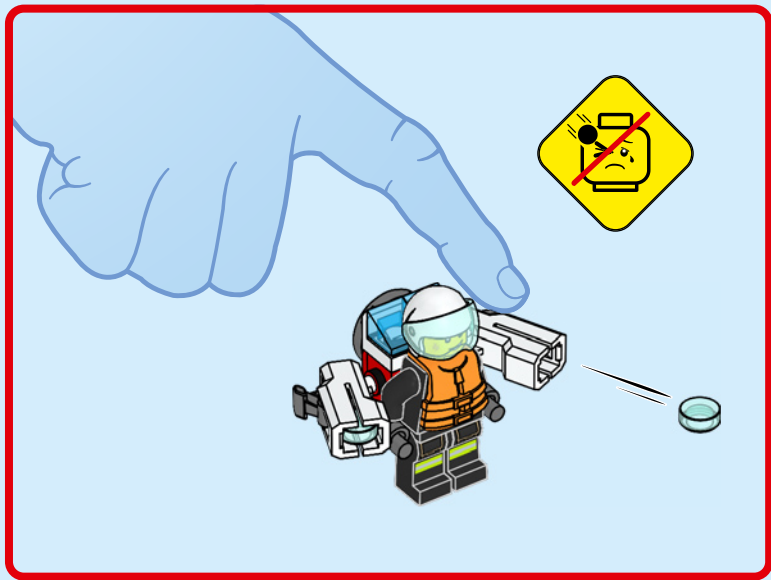

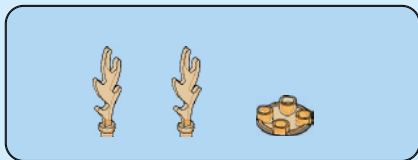

1



2

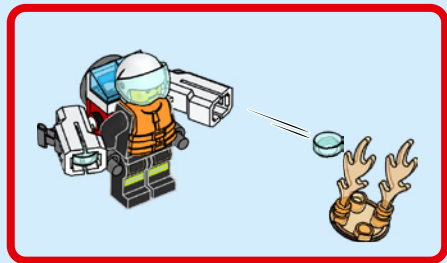

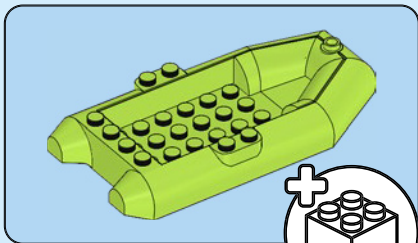

1

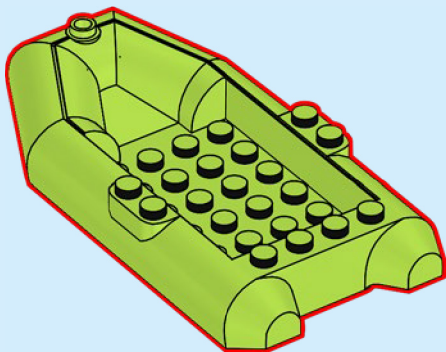

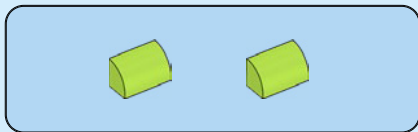

2

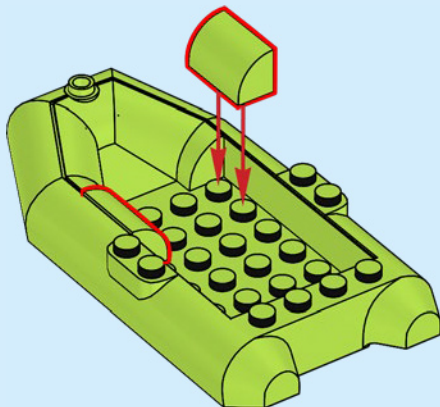

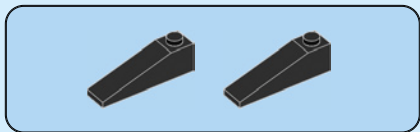

3

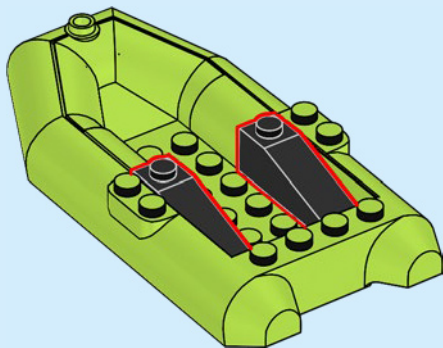

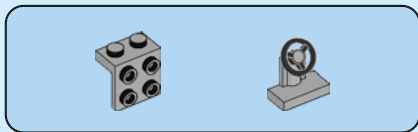

4

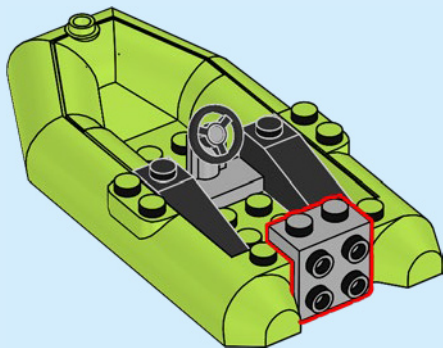



5

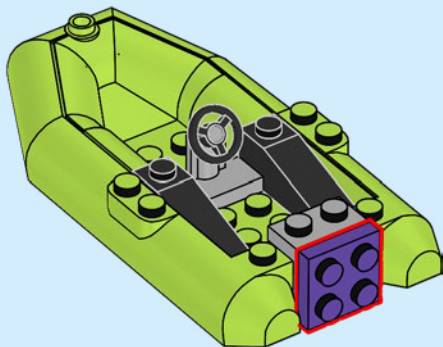

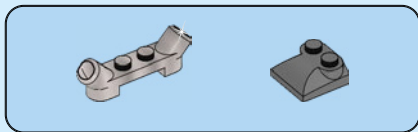

6

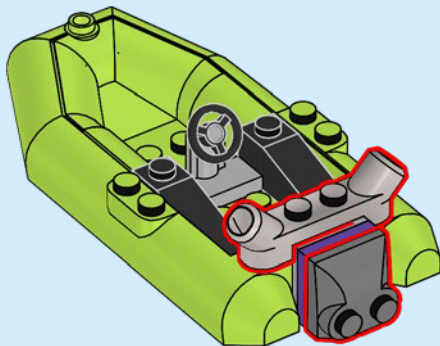



7

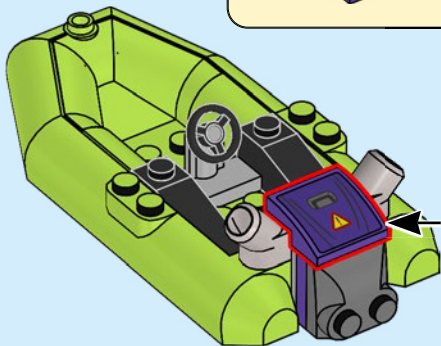
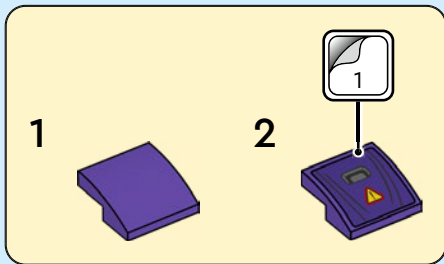

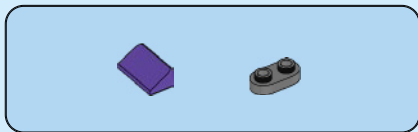

8

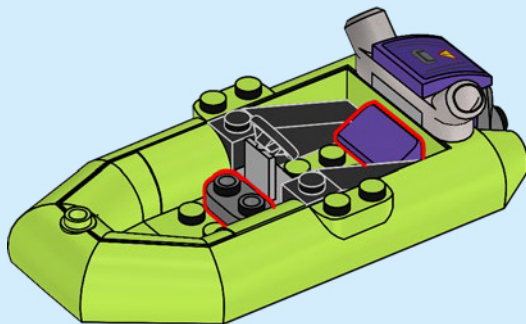



9

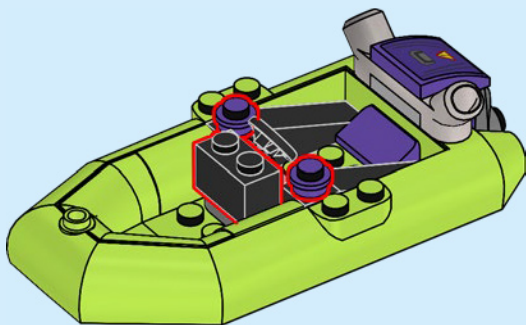

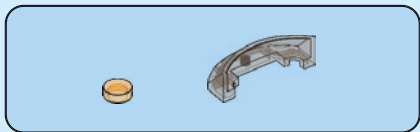

10

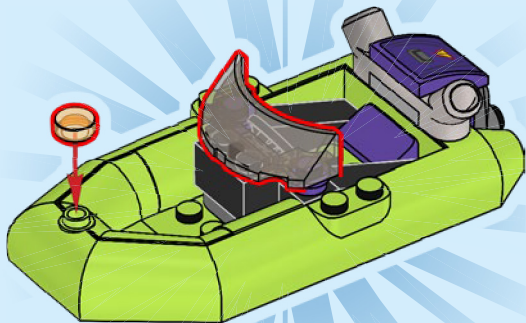



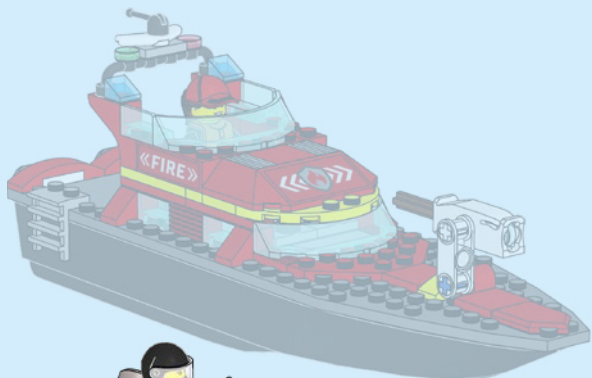

YOU COULD

WIN



Scan this QR code or go to
LEGO.COM/PRODUCTFEEDBACK and give us
your short feedback about this LEGO® set
for a chance to win a cool LEGO prize.

Terms and Conditions apply*

DE: Du könntest GEWINNEN. Es gelten die Teilnahmebedingungen* **FR: Tu pourrais GAGNER.** Des conditions s'appliquent* **IT: Potresti VINCERE tu.** Termini e condizioni sono applicabili* **ES: Puedes GANAR.** Aplican términos y condiciones* **PT: Poderá GANHAR.** Aplicam-se termos e condições* **JA: プレゼント付き! 利用規約が適用されます*** **ZH: 轻松获奖. 条款和条件适用*** **KO: 상품의 주인이 되어보세요. 소정의 약관이 적용됩니다*** **RU: Вы можете ВЫИГРАТЬ.** Действуют положения и условия* **PL: Szansa na WYGRANĄ.** Obowiązują warunki korzystania* **CS: Máte šanci VYHRÁT.** Platí všeobecné smluvní podmínky* **SK: Máte šancu VYHRÁŤ.** Platia všeobecné zmluvné podmienky* **HU: TE IS NYERHETSZ.** Felhasználási feltételek érvényesek* **RO: Ai putea CÂȘTIGA.** Se aplică termenii și condiții* **BG: Можете да СПЕЧЕЛИТЕ.** Има определени правила и условия* **LV: Tu vari LAIMĒT.** Ir spēkā noteikumi un nosacījumi.* **ET: Sul on võimalus VÕITA.** Kehtivad tingimused* **LT: Jūs galite LAIMĖTI.** Taikomos sąlygos*

*[LEGO.com/productfeedback-terms](https://www.lego.com/productfeedback-terms)



CITY

60373



2

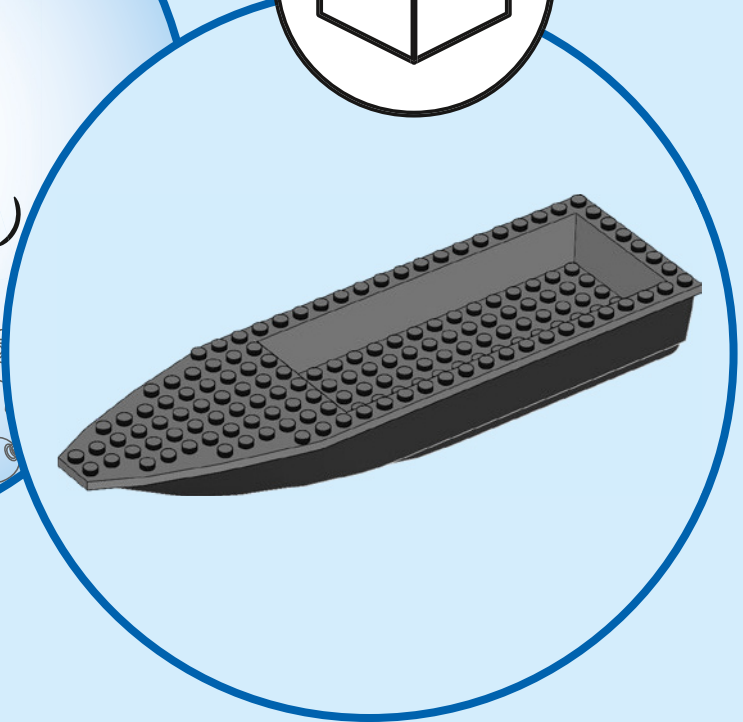
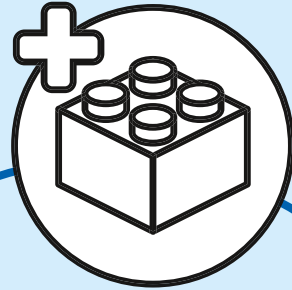

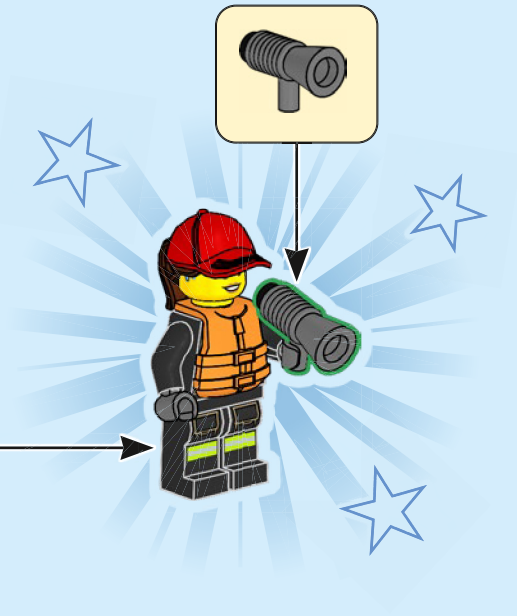
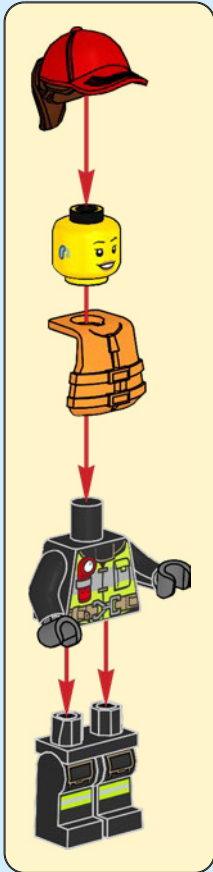

1

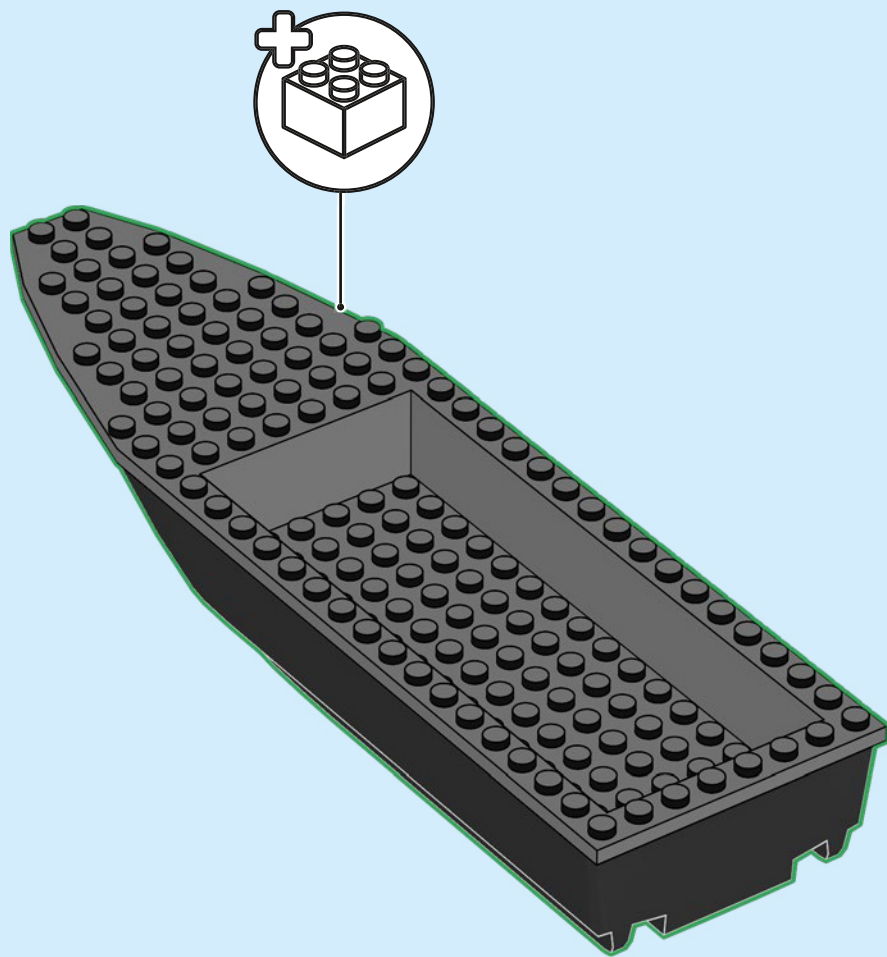

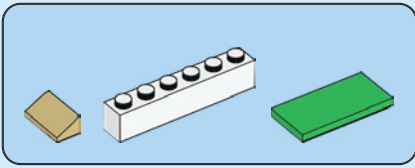

2

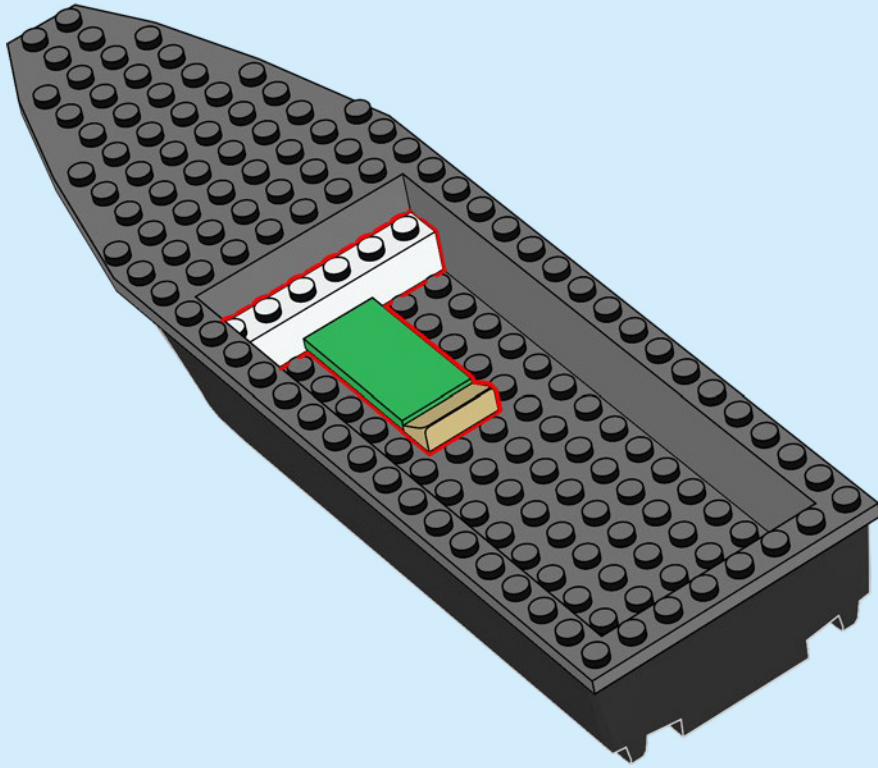

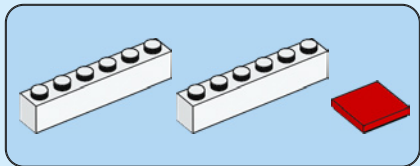

3

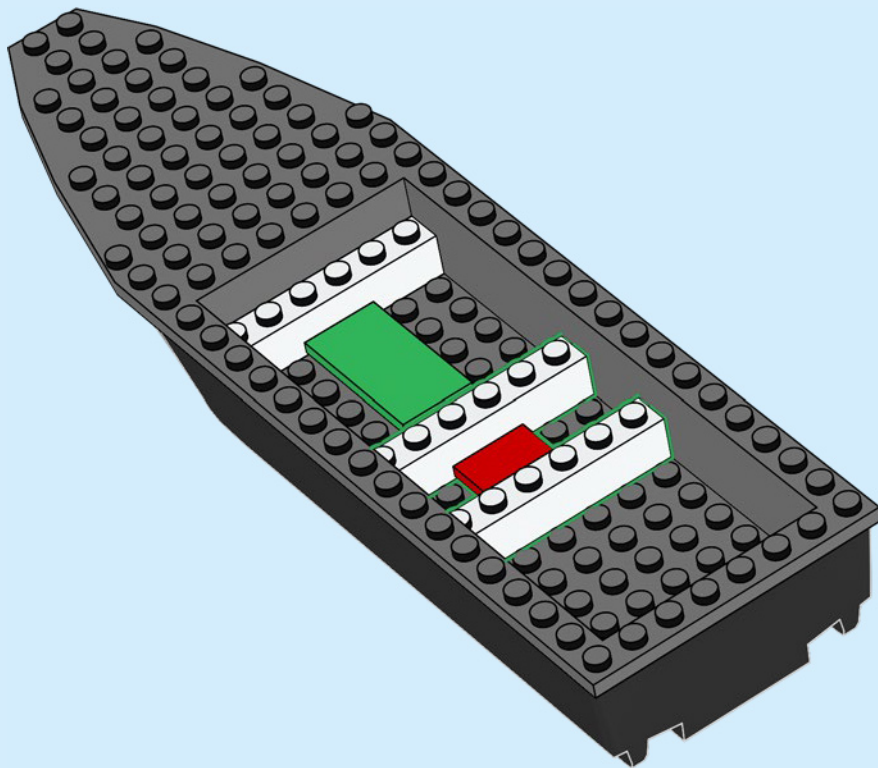

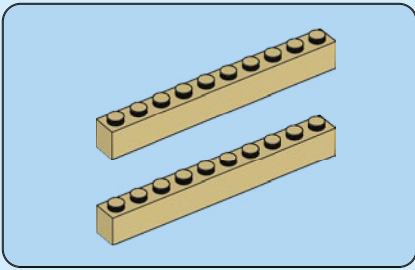

4

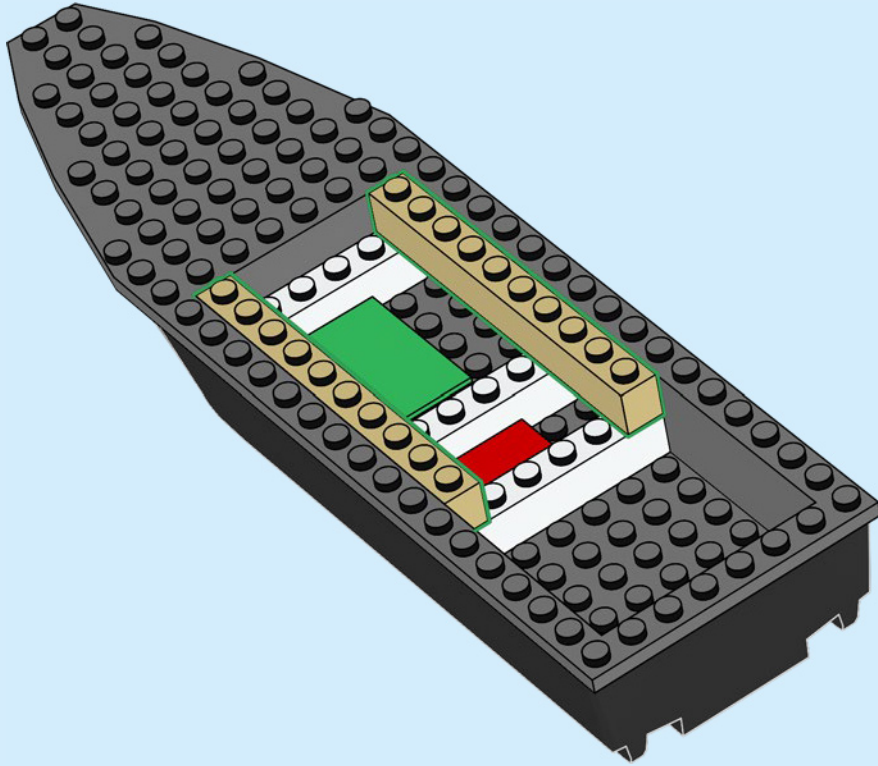

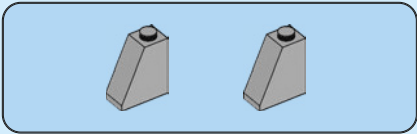

5

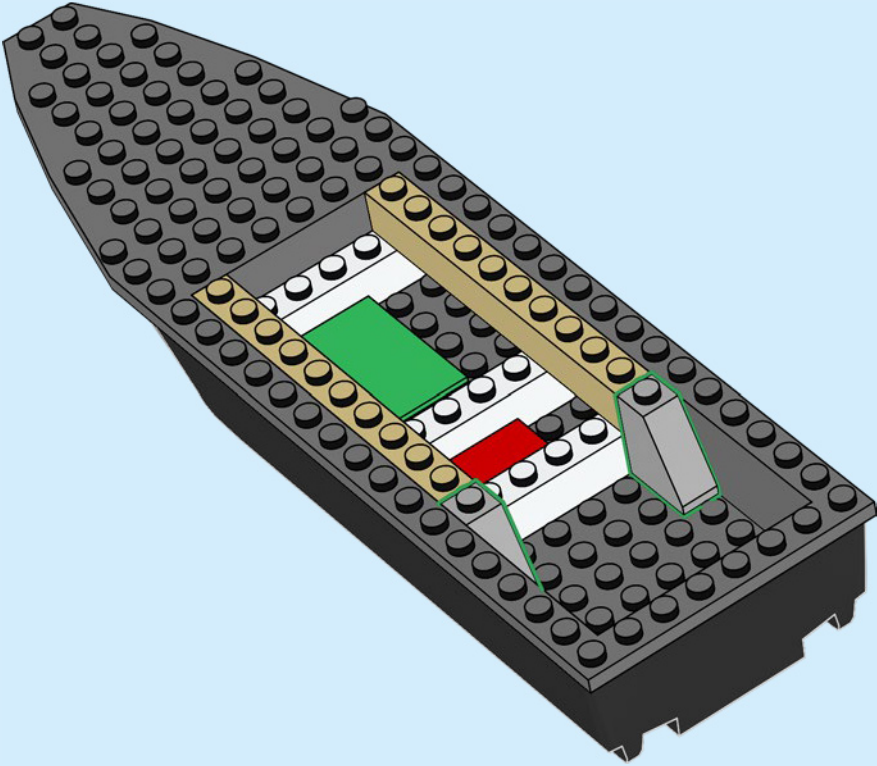

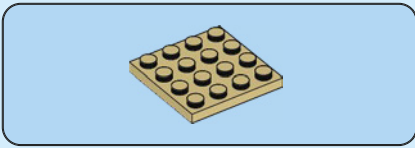

6

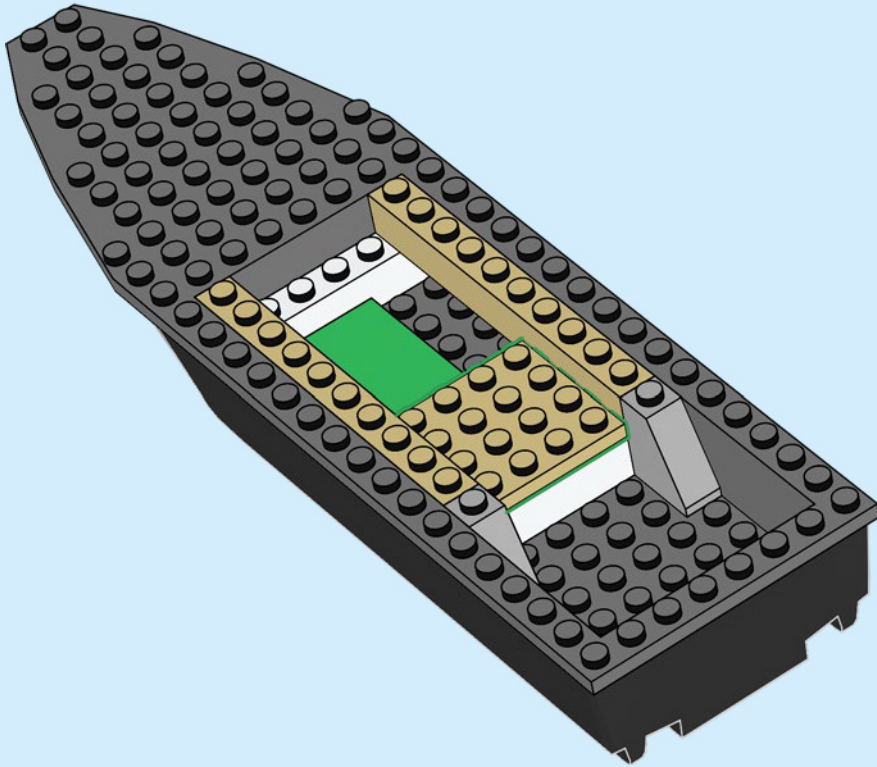

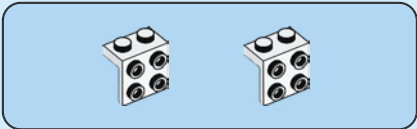

7

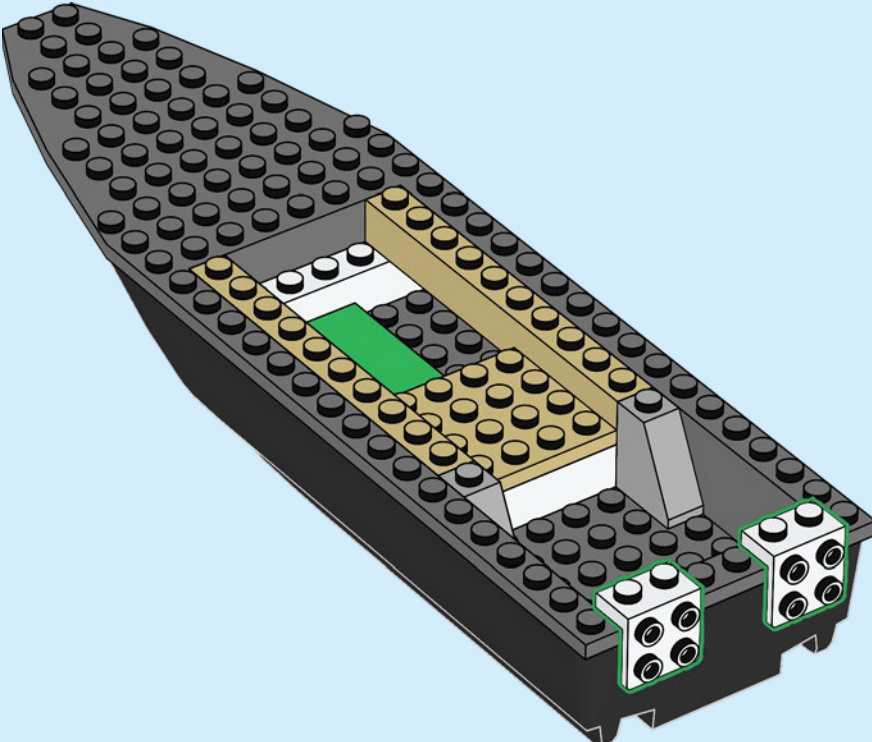

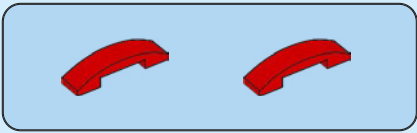

8

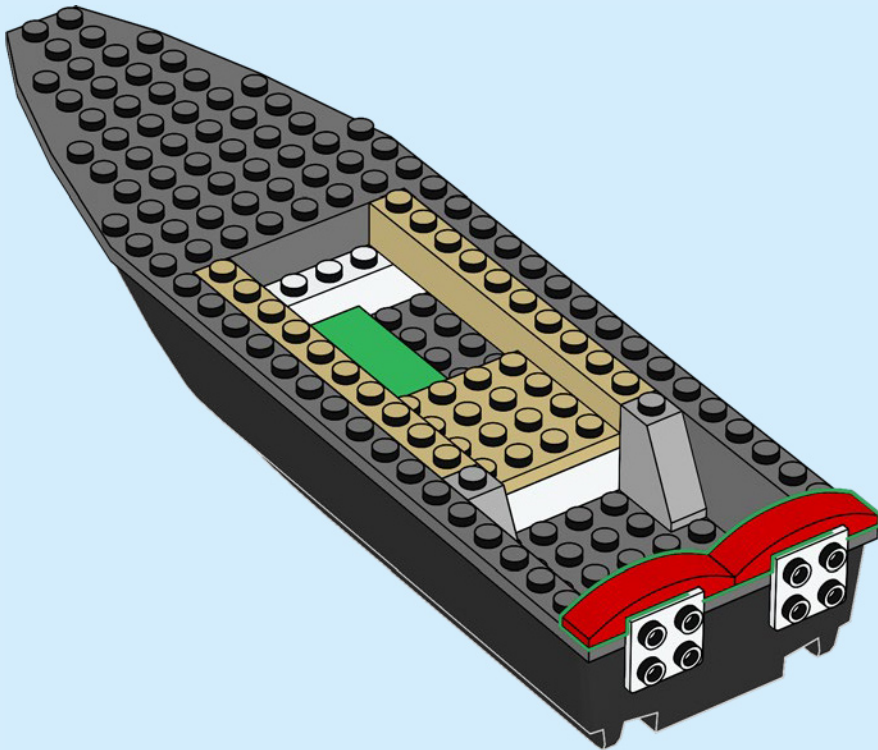

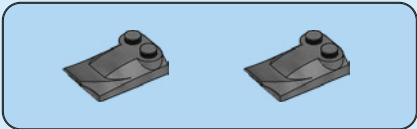

9

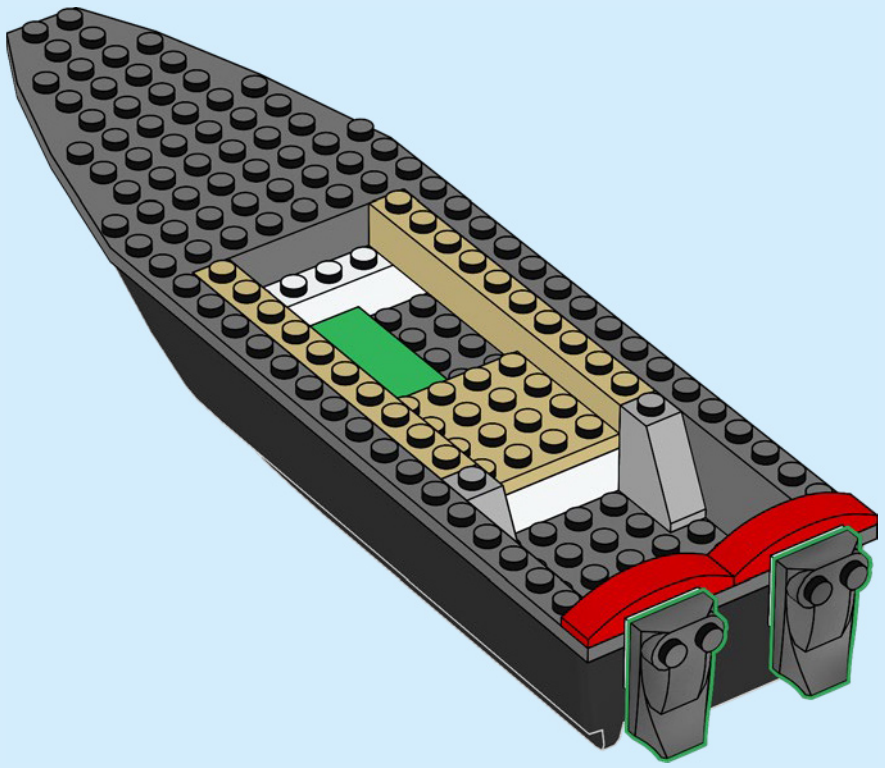

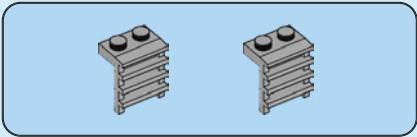

10

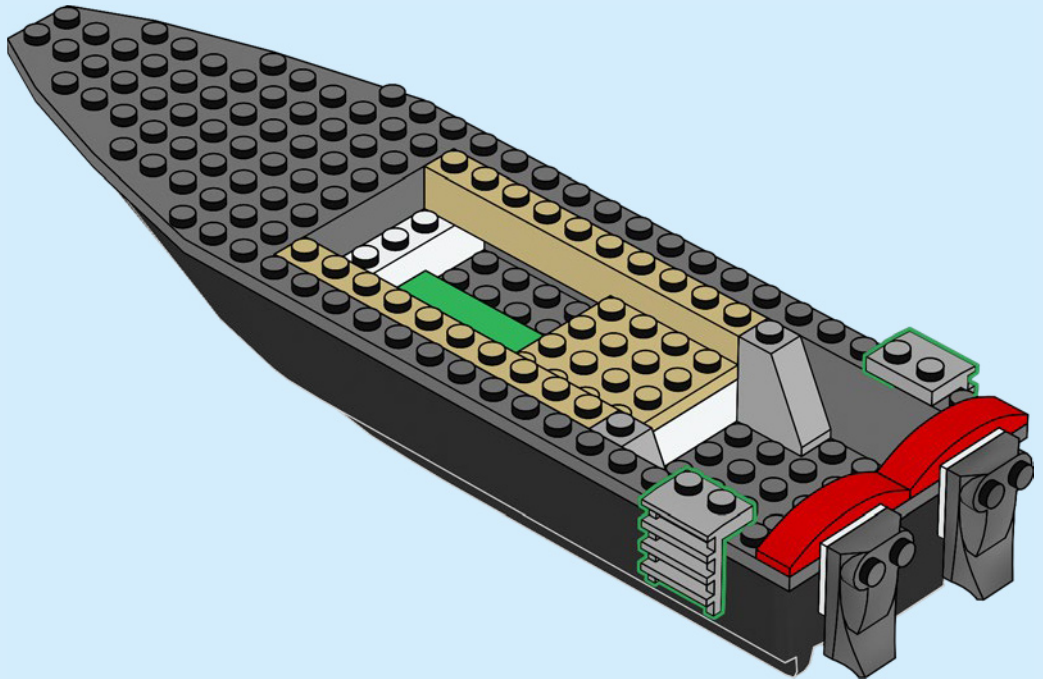

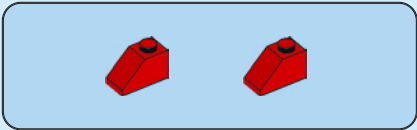

11

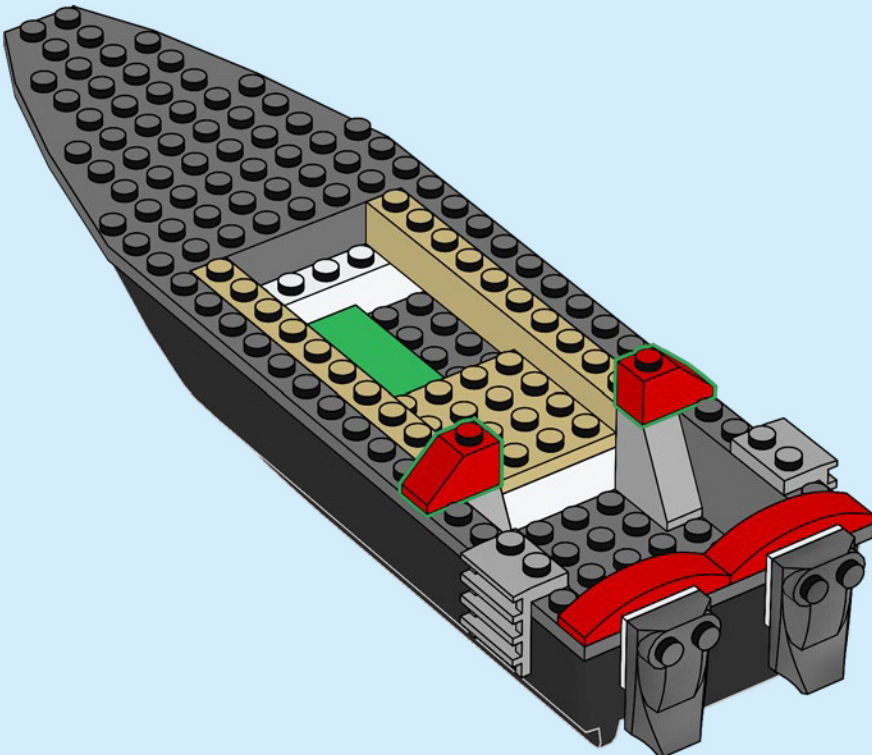

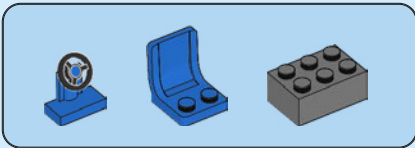

12

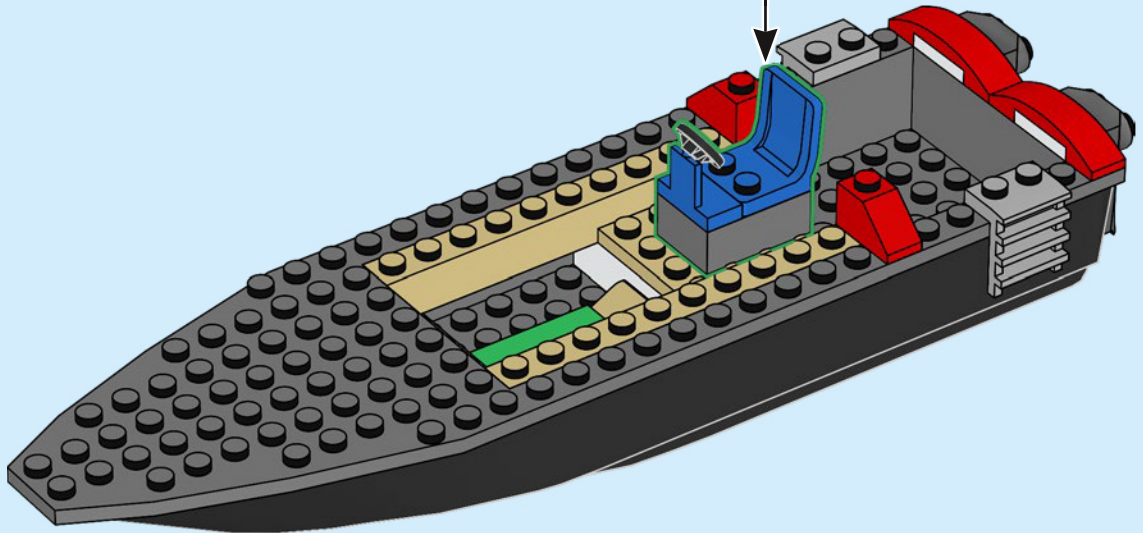
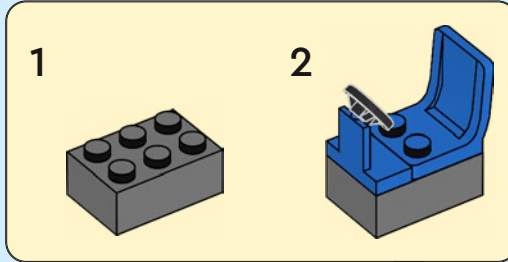

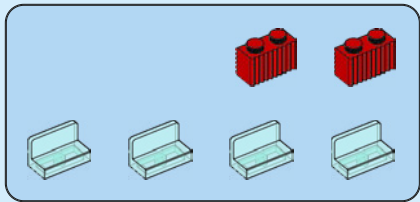

13

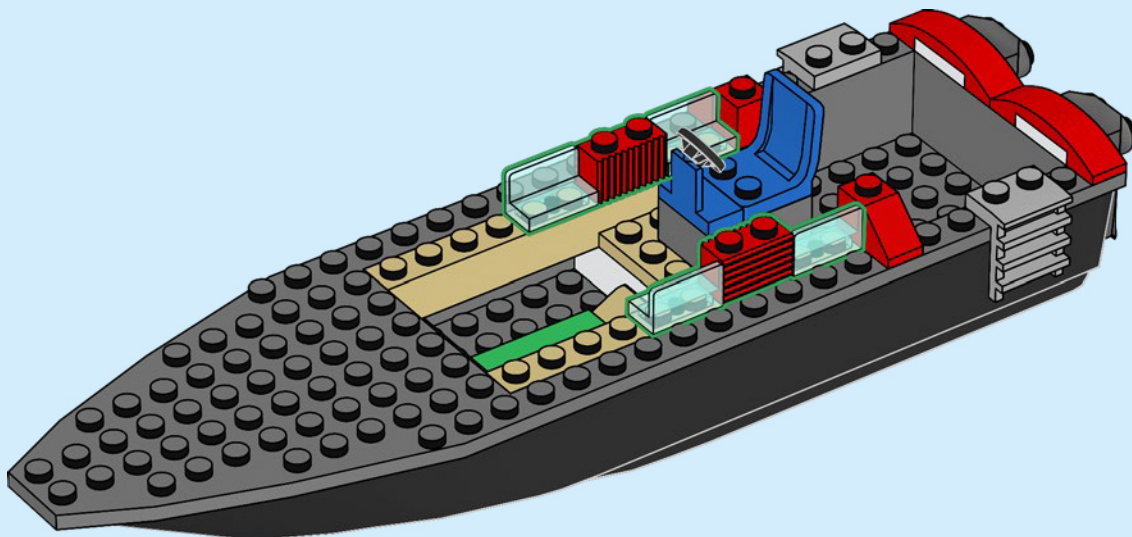

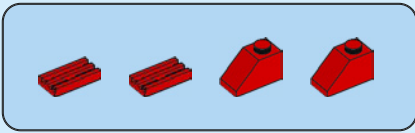

14

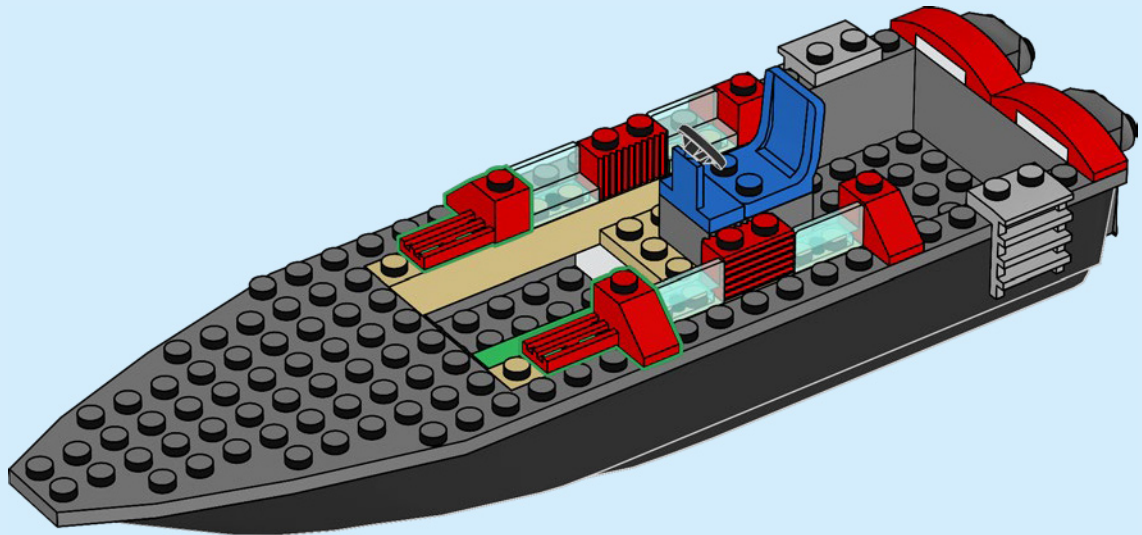

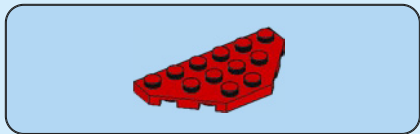

15

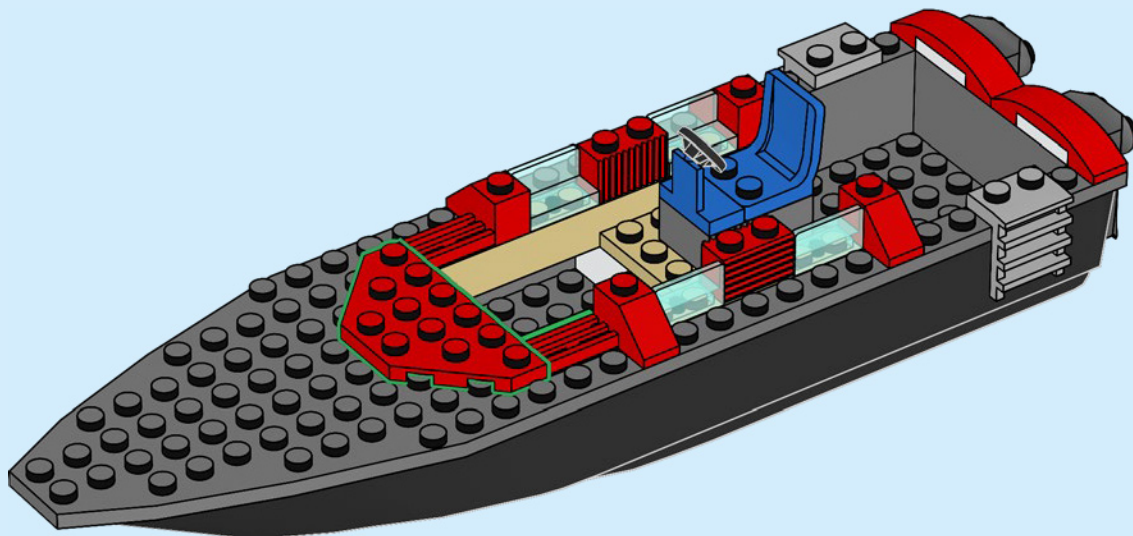

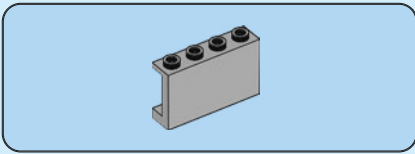

16

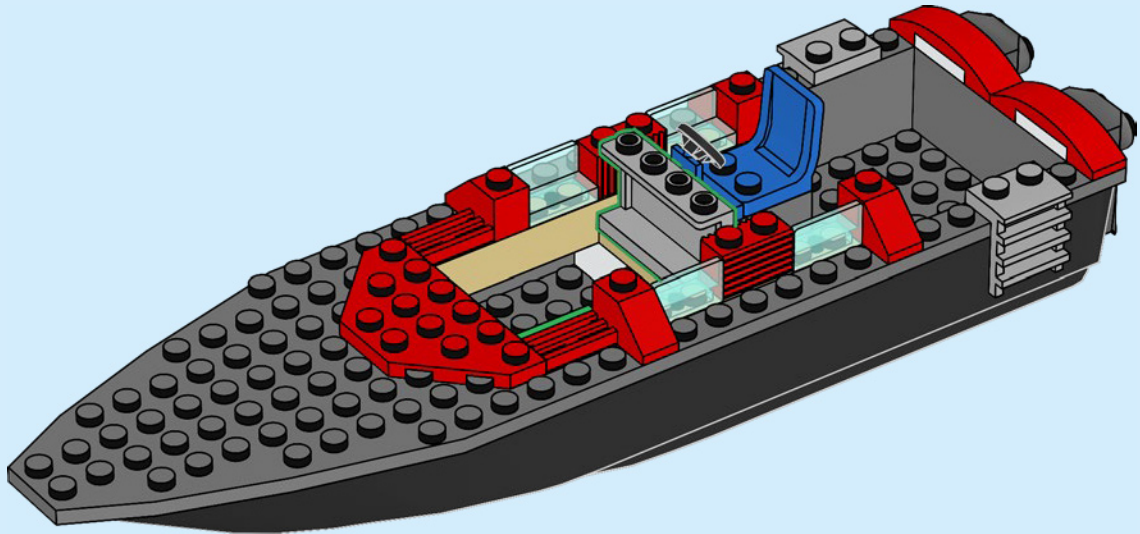

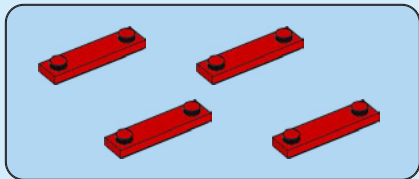

17

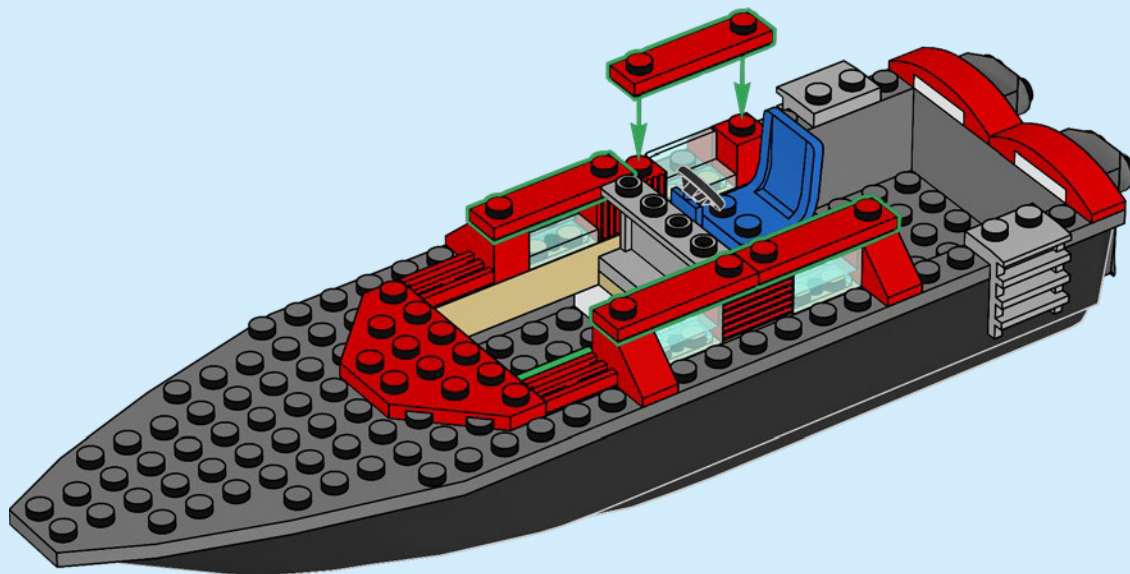

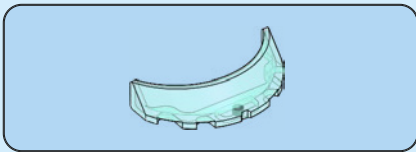

18

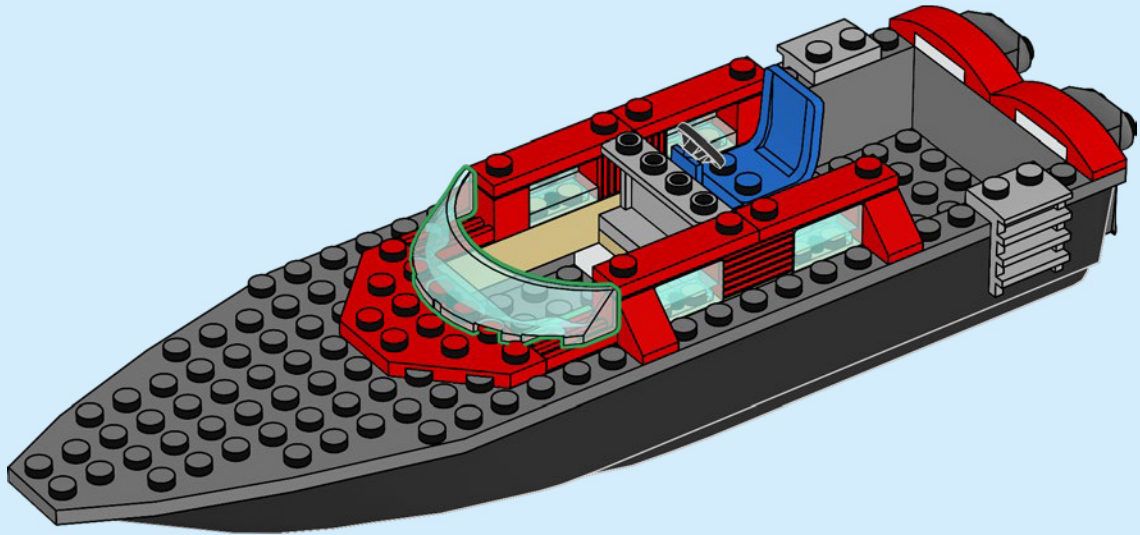

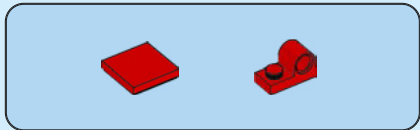

19

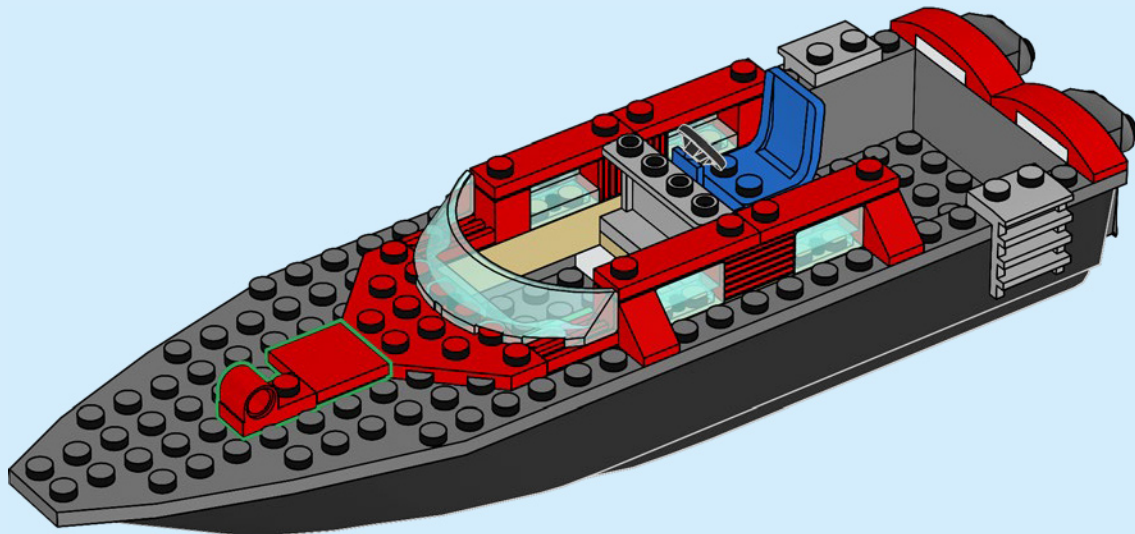

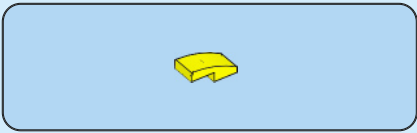

20

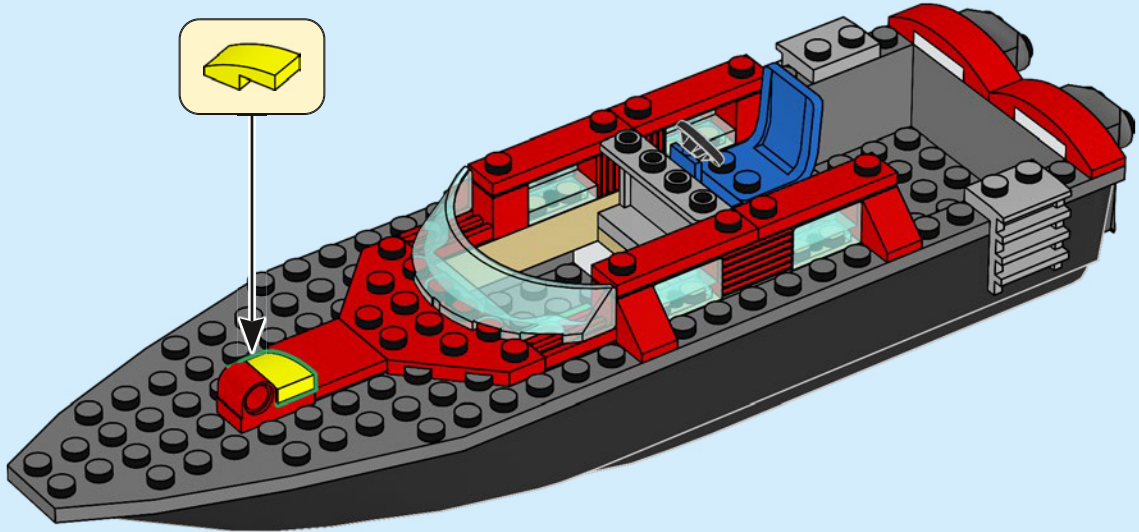

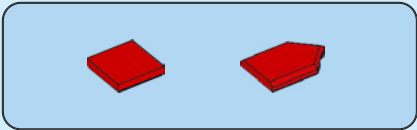

21

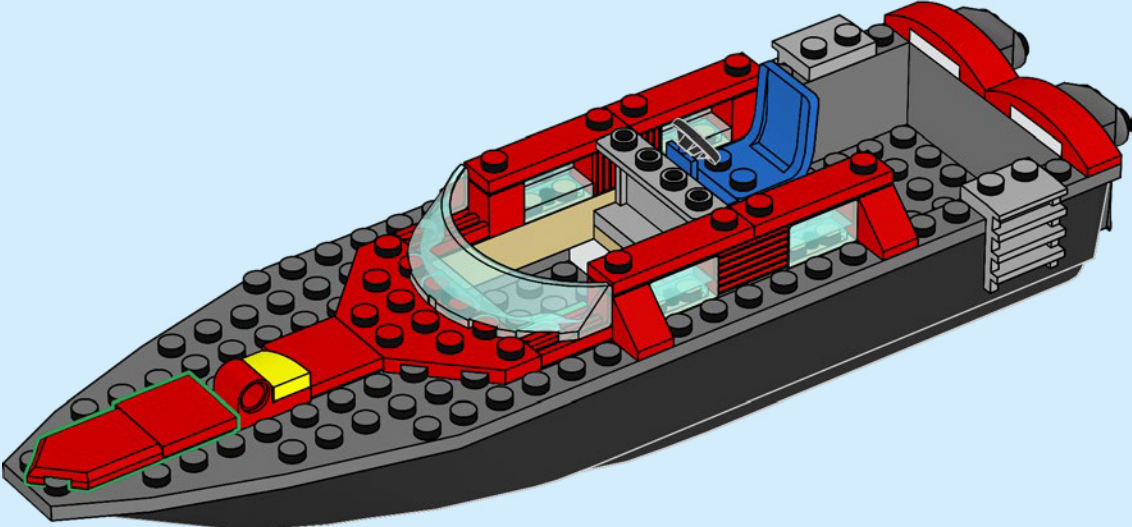

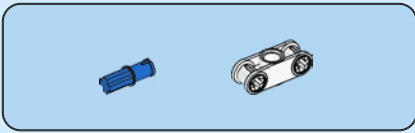

22

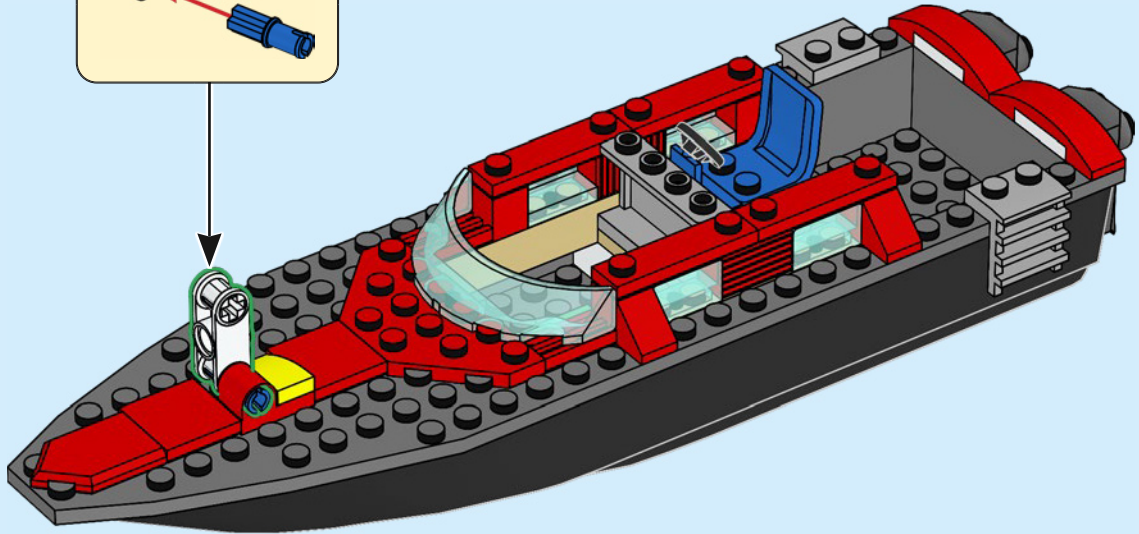
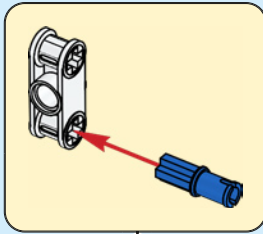

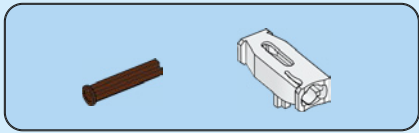

23

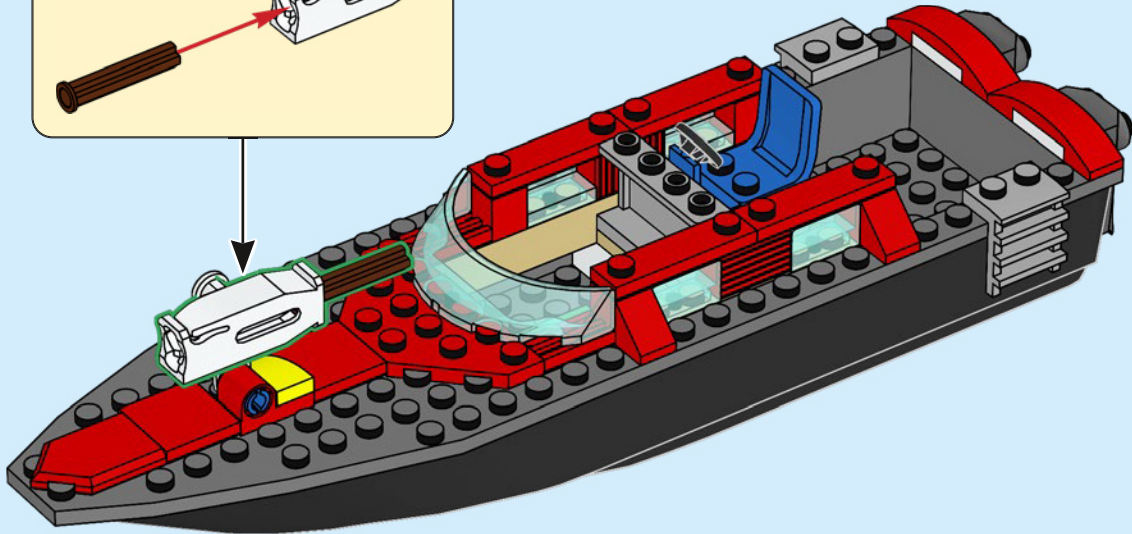
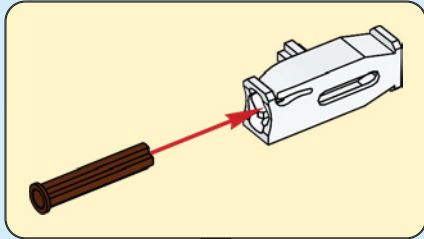

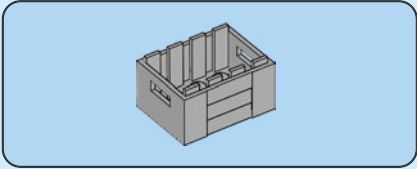
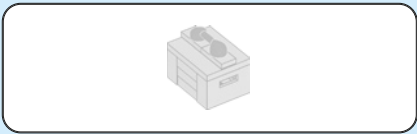

24

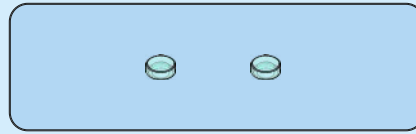
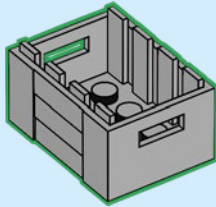

25

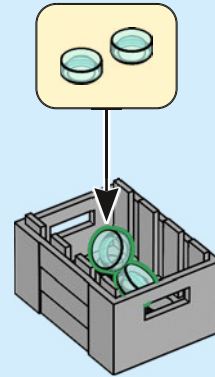

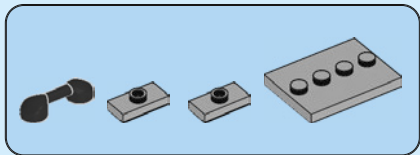

26

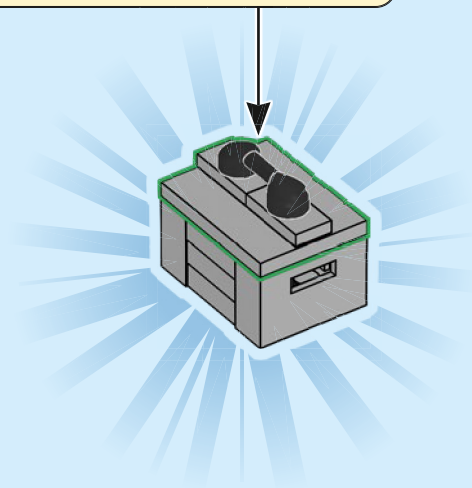
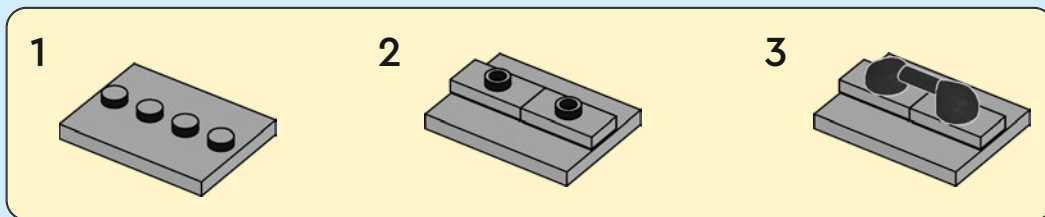

27

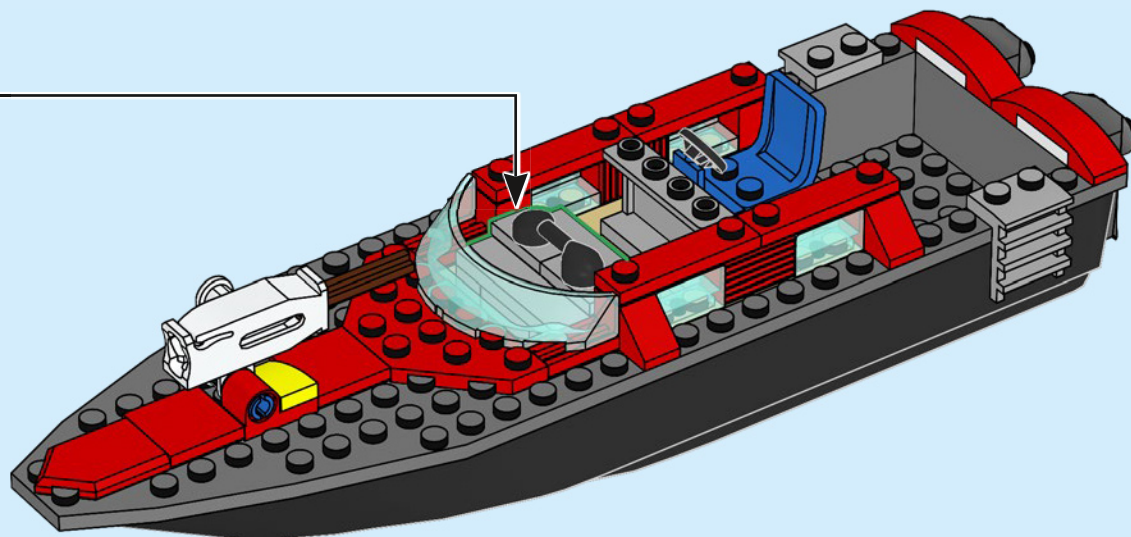

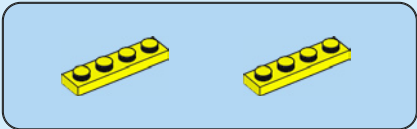

28

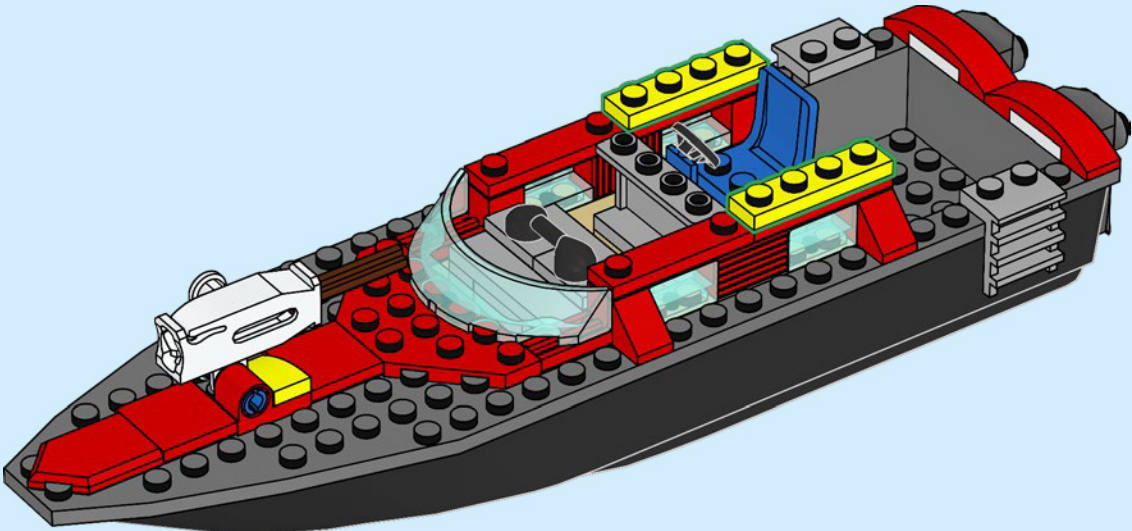



29

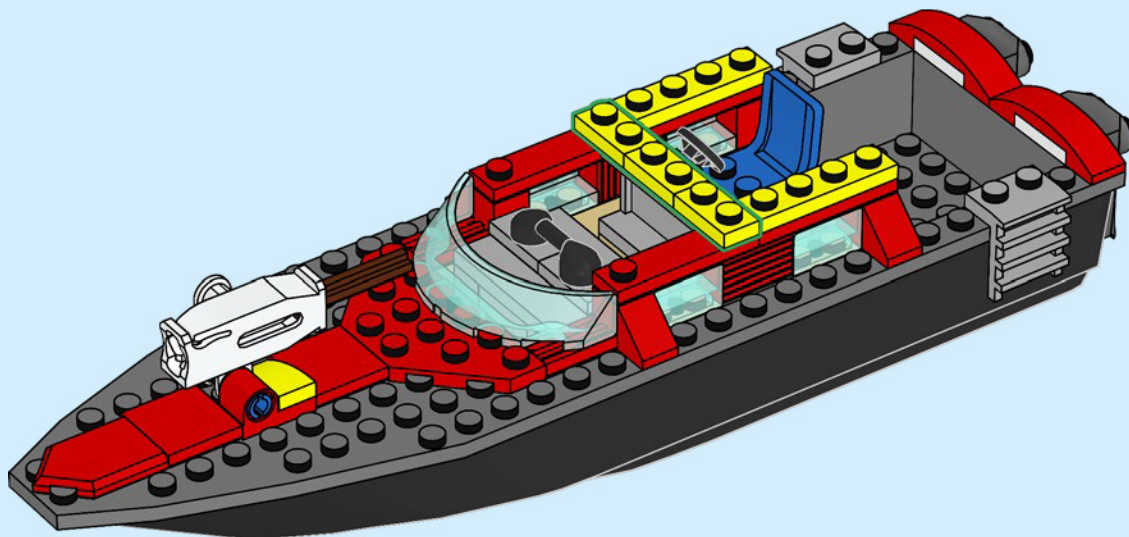

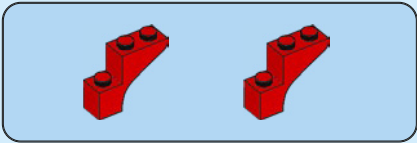

30

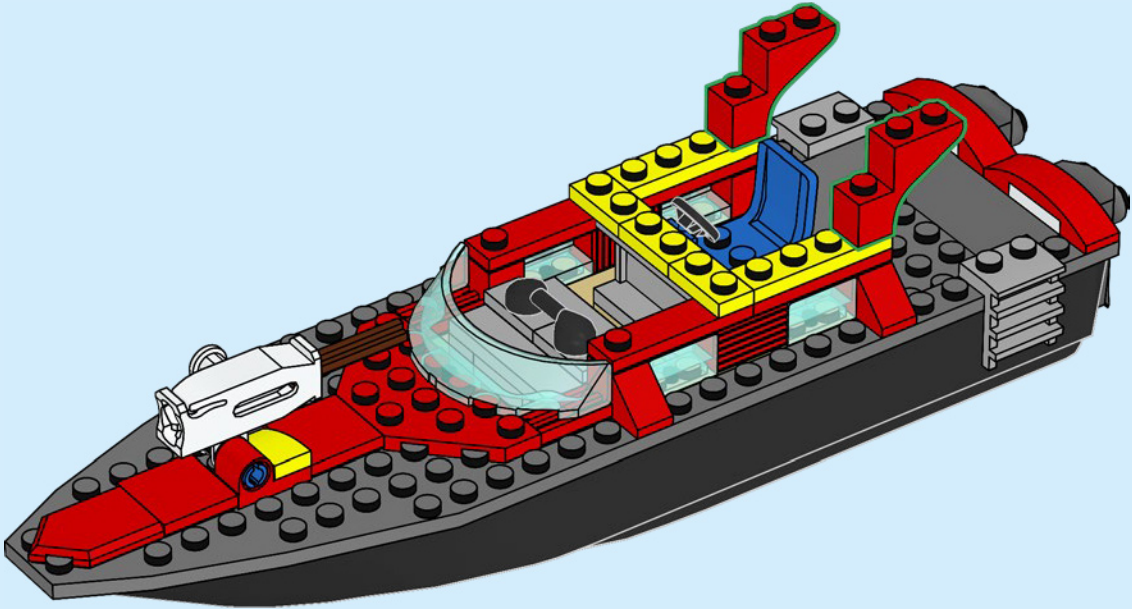

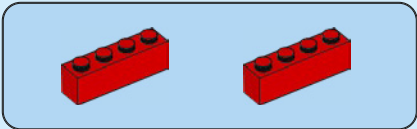

31

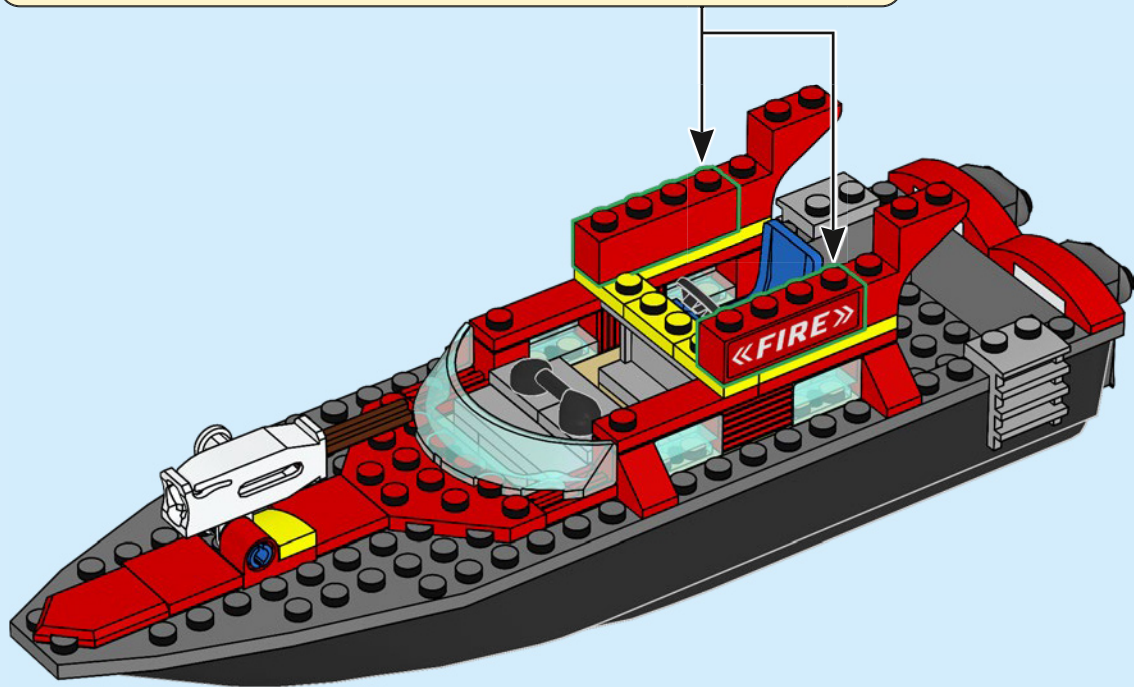
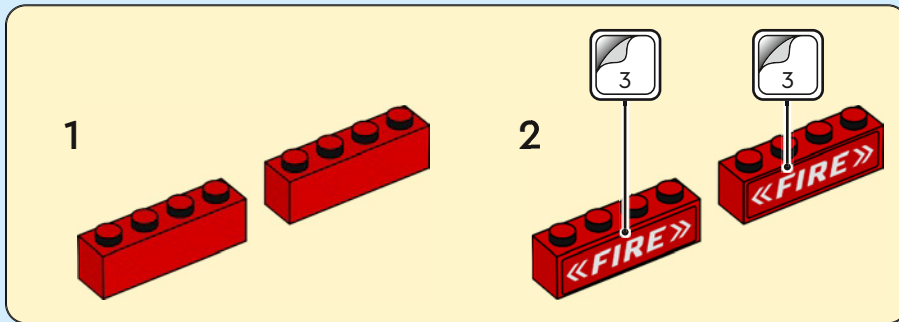

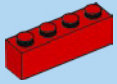

32

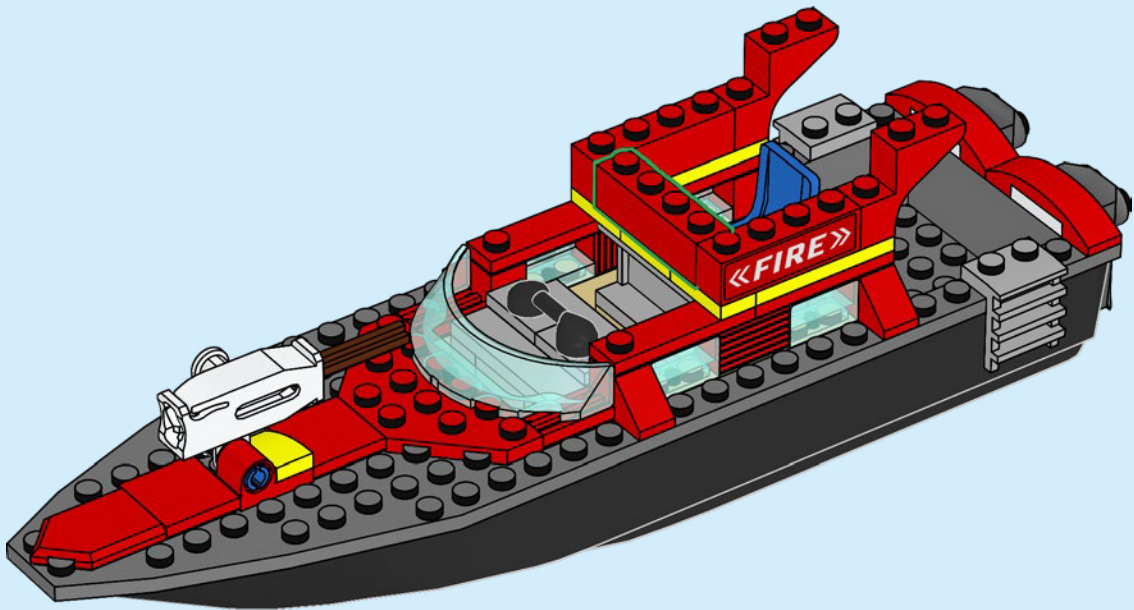

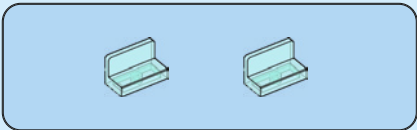

33

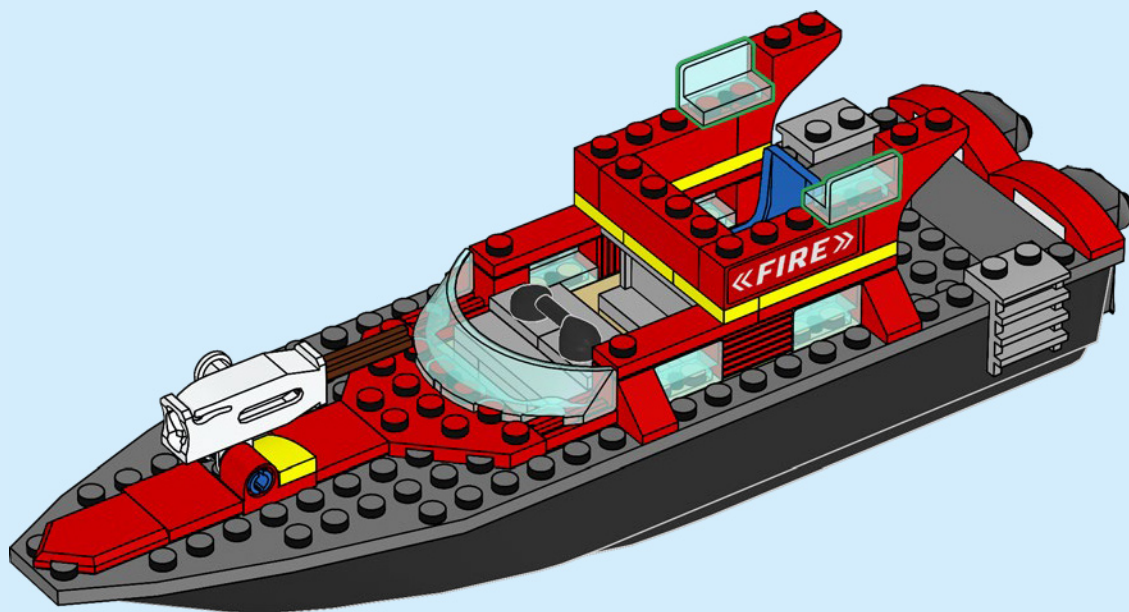

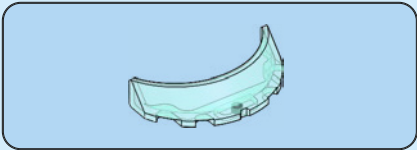

34

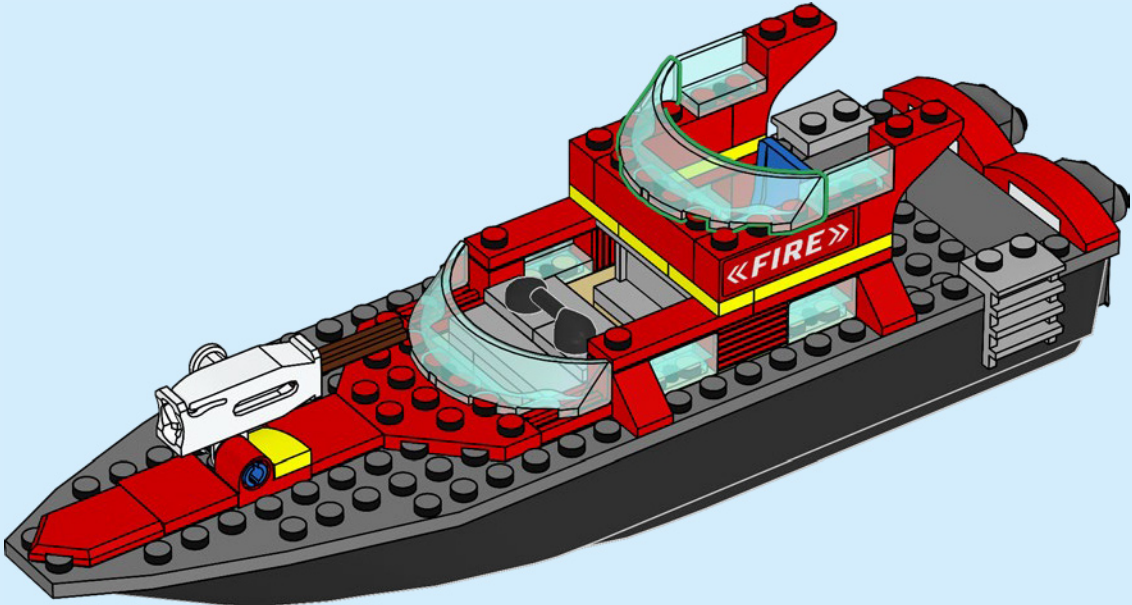



35

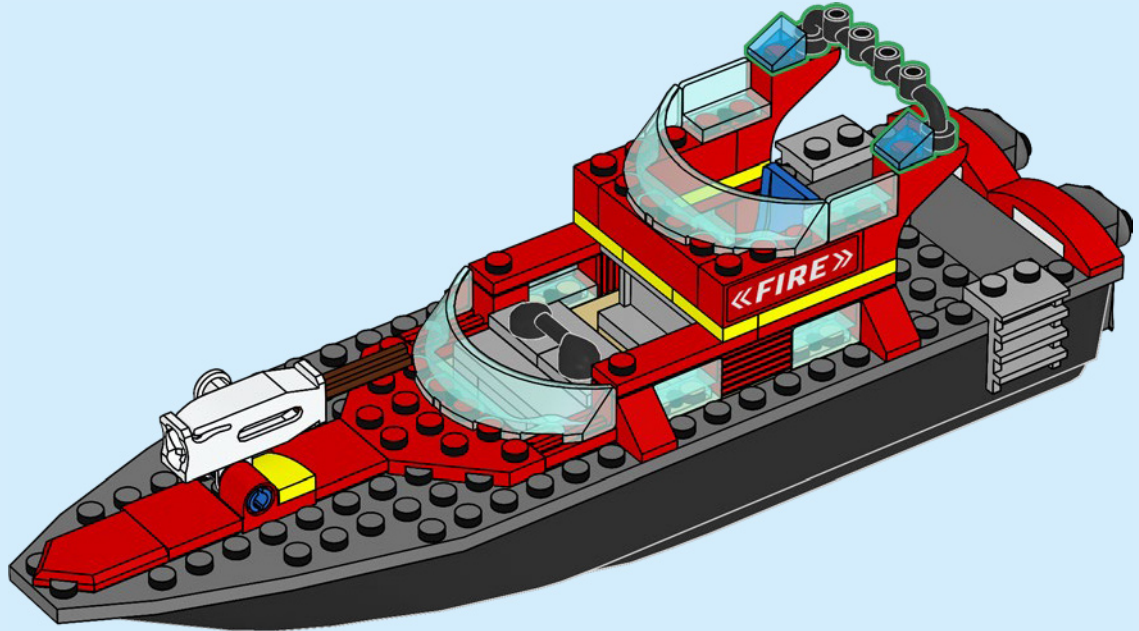



36

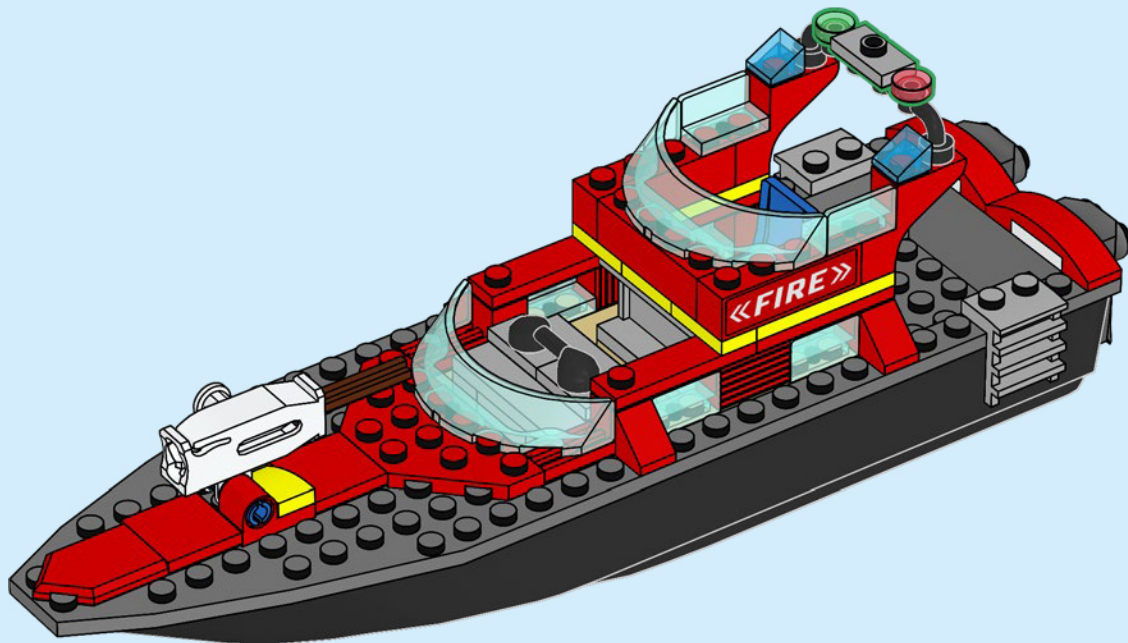

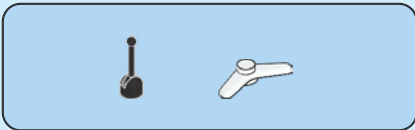

37

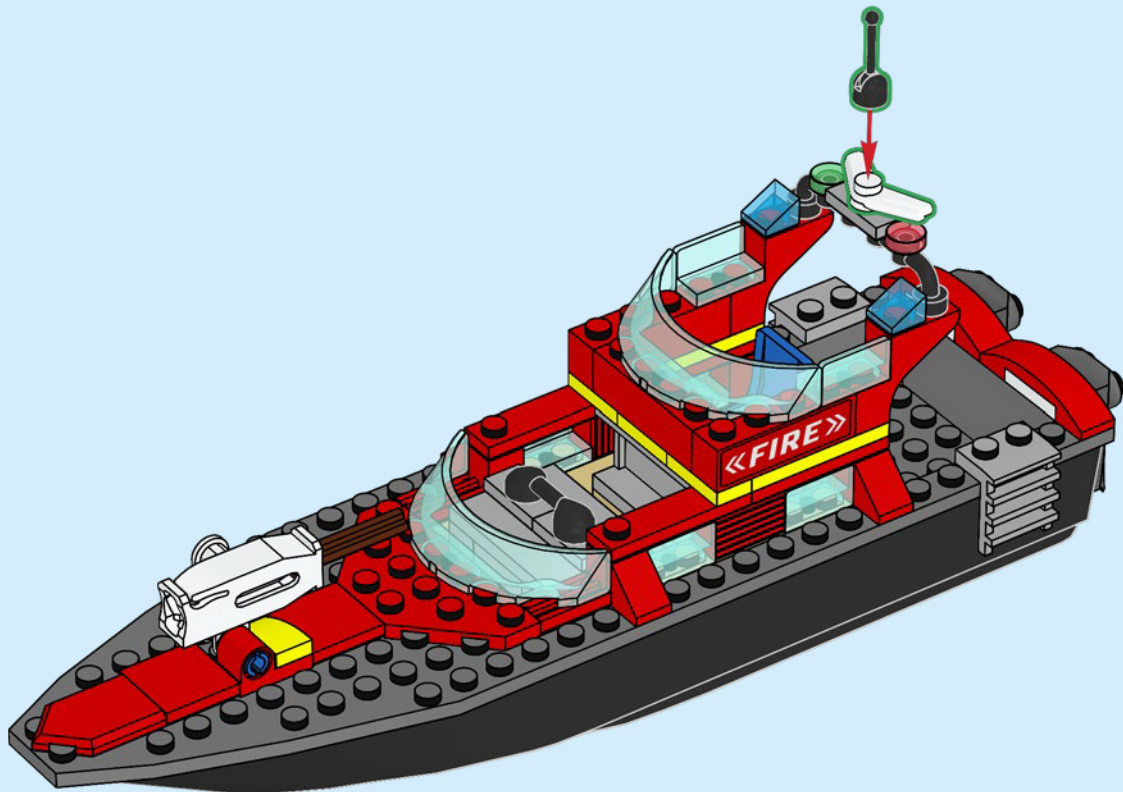

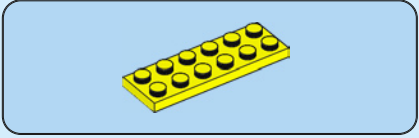

38

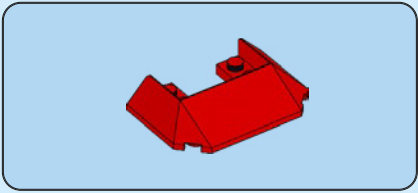
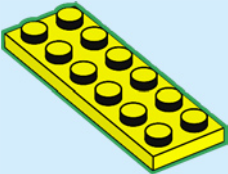

39

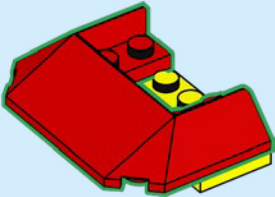

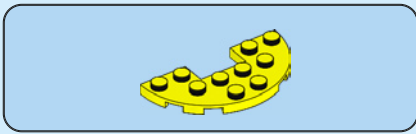

40

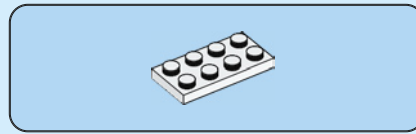
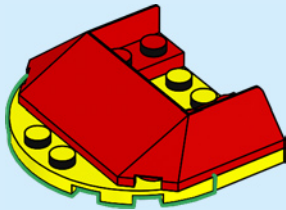

41

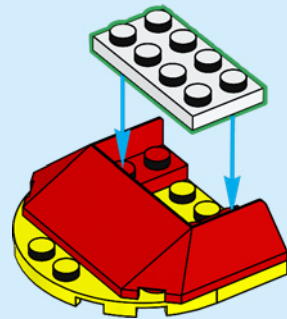

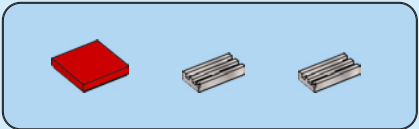

42

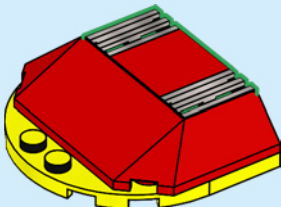

43

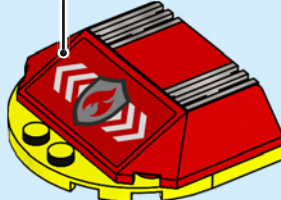

44

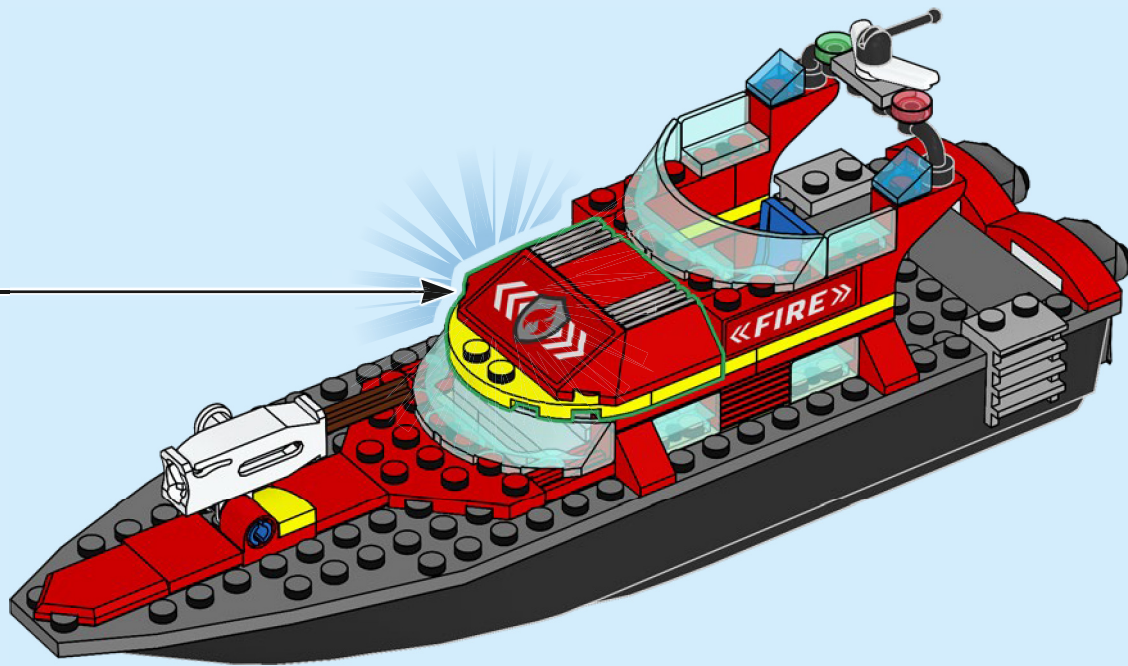



45

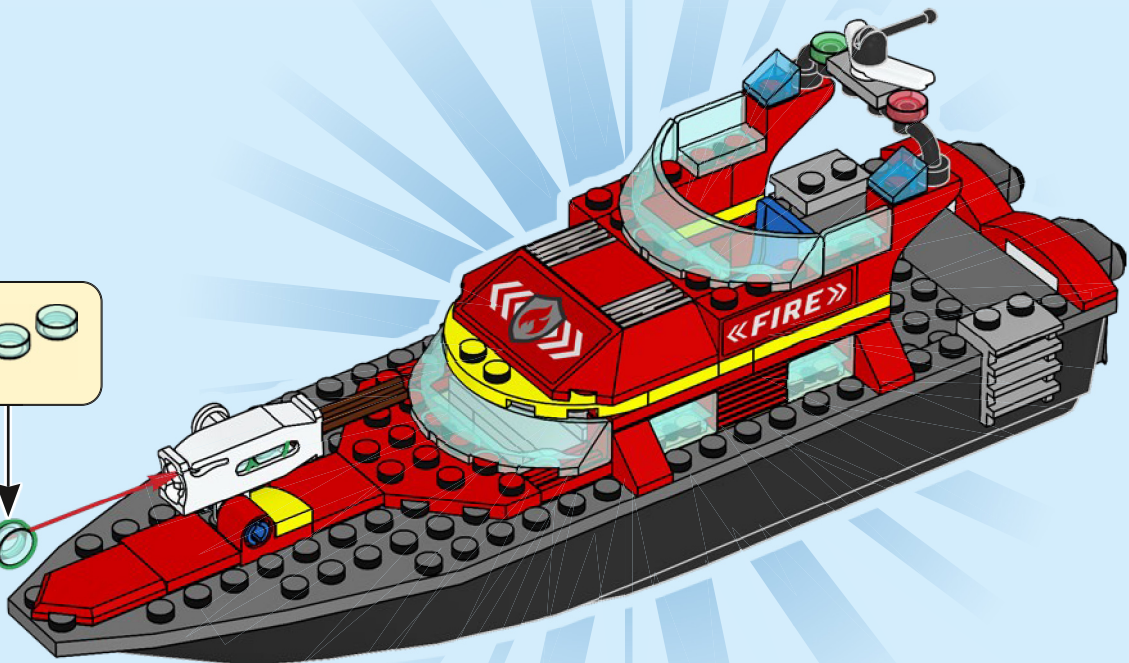

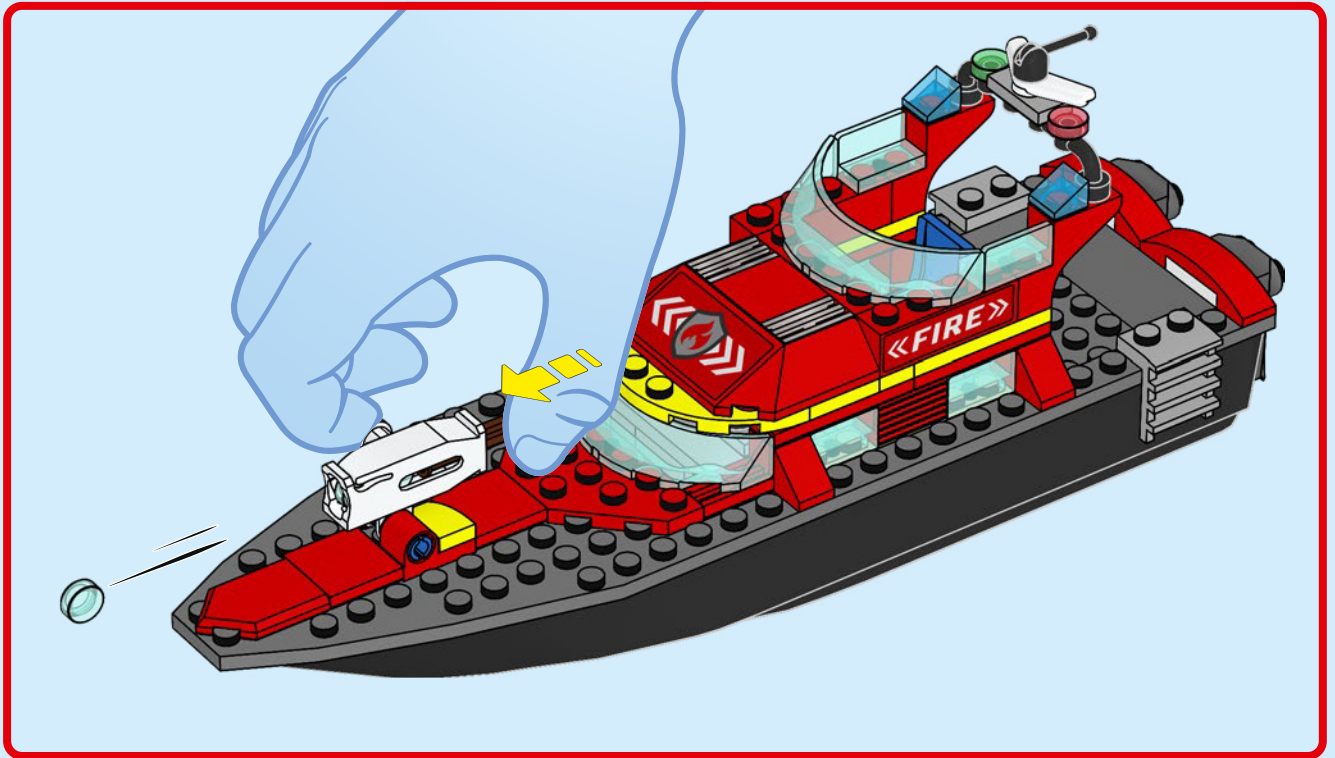

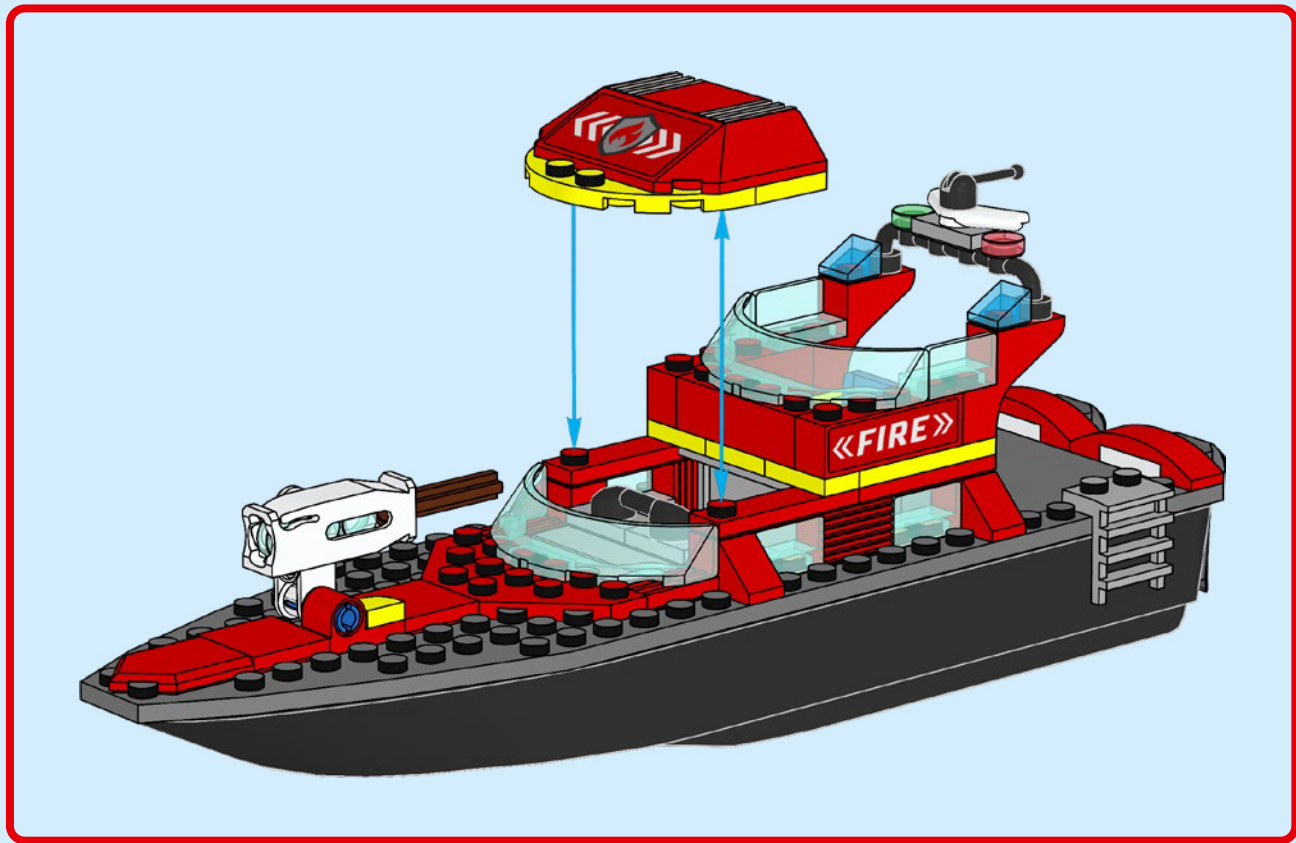



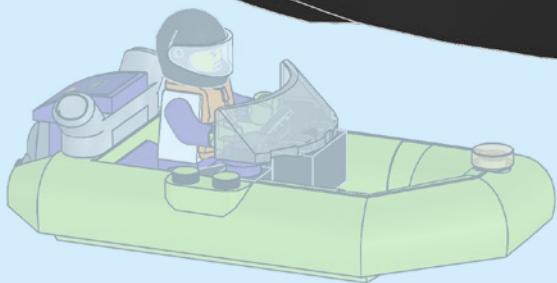
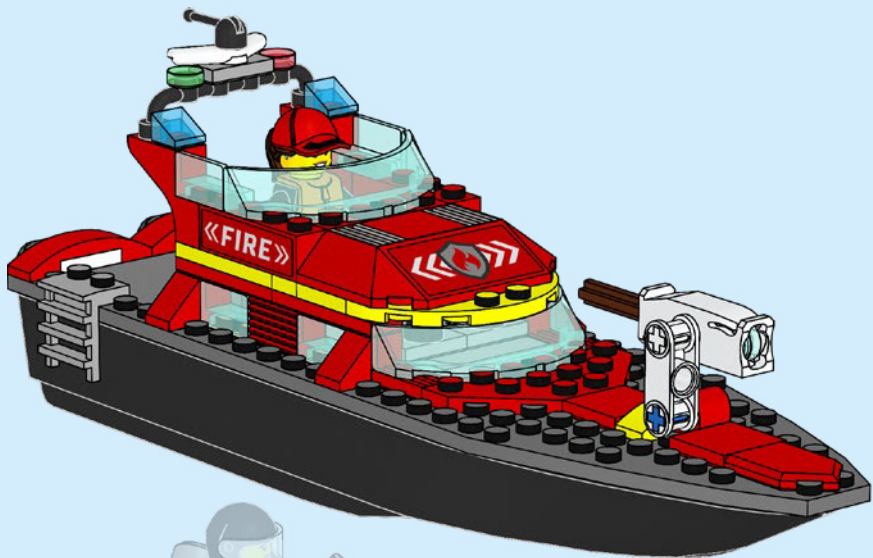



CITY





CITY



60374



60372



60369



60373



60370

1x
4624086

1x
4243824

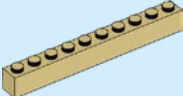
2x
4166138

2x
4558886

2x
6219677



4x
4121934

1x
6099736

2x
241221

1x
6001806

4x
306821

2x
6056816



1x
6294045

3x
301021

2x
4633914

4x
6256923

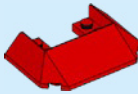
1x
241921

1x
6427263

1x
6252744

1x
6070698

2x
6117940



1x
6211335

1x
6276981

1x
6427399

1x
6427264

1x
302001

3x
300901

1x
4226995

3x
6231925

1x
6244787

1x
6274742

1x
6311265

1x
6123730

1x
6283884

1x
73587

1x
4298619

2x
6143335

1x
300426

1x
6151289

1x
6254472

1x
6332022

2x
4515362

1x
6415609

1x
4566179

1x
6408579

1x
4206482

1x
407923

1x
9566

2x
4566522

1x
4566607

1x
4586410

1x
6182217

1x
6047422

3x
4619636

1x
4632100

2x
6167034

3x
6382324

1x
6378287

2x
6380691

1x
6421396

1x
6391549

1x
6274747

2x
6167741

1x
6171727

1x
6223059

1x
6135494

1x
6258607

9x
6274739

1x
6248530

6x
6246890

2x
6246853

4x
6245256

1x
4210698

1x
6221607

1x
6117346

2x
6361702

1x
4218696

1x
4211105

1x
4263176

2x
6310290

1x
6421395

1x
6421400

1x
6079461

1x
6108560

2x
4515374

3x
6066097

1x
6117967

2x
6285243

1x
6061675



 [LEGO.com/service](https://www.LEGO.com/service)