

3543

LEGO SPORTS



4210079

3540



3541

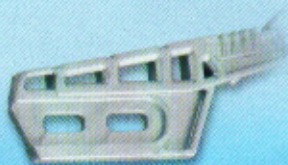

3542



3543

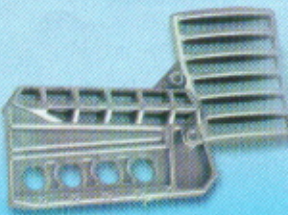

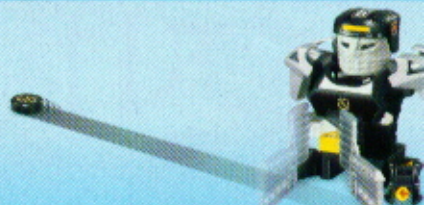
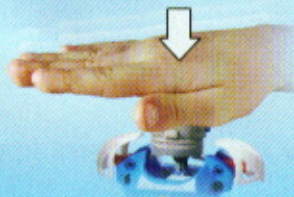

3540 Puck Passer



3541 Slap Shot



3542 Flip Shot



3543 Slammer Goalie



3544 Game Set



3545 Puck Feeder



1

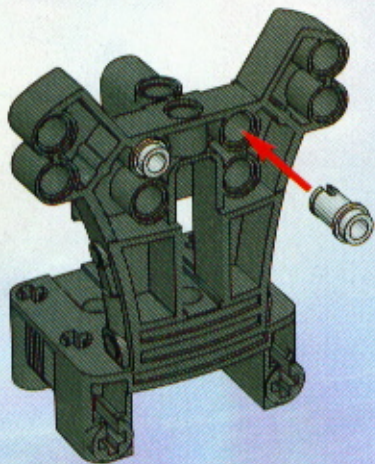

2

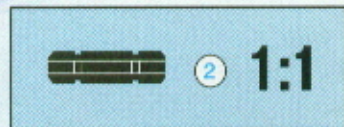
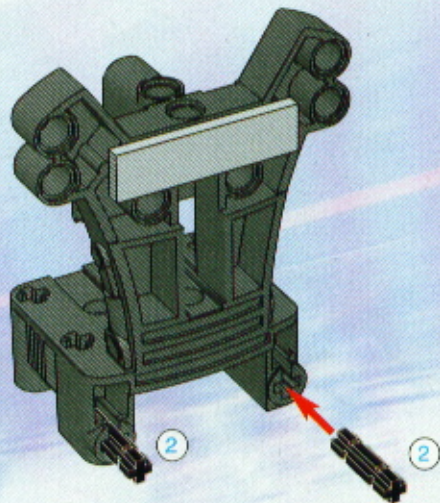

3

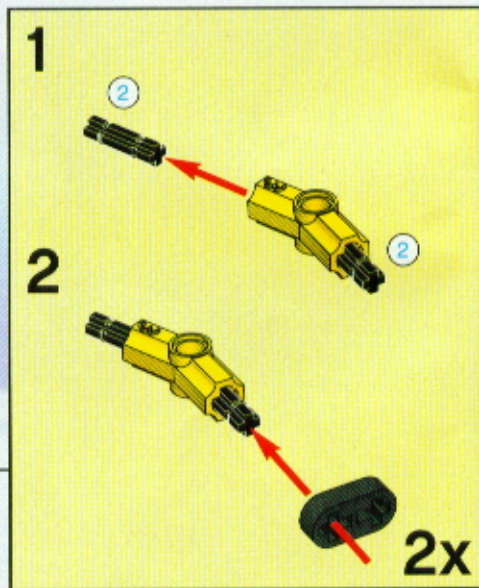
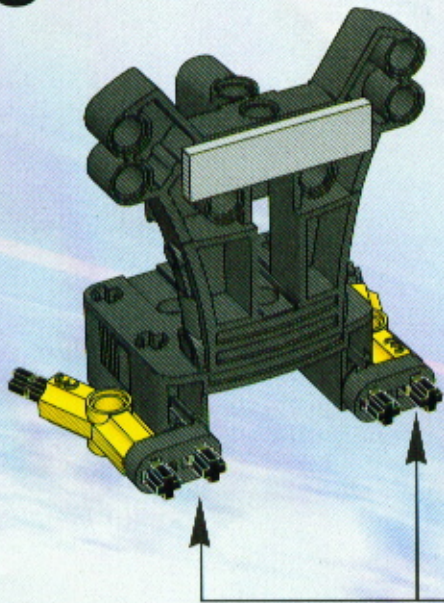



4

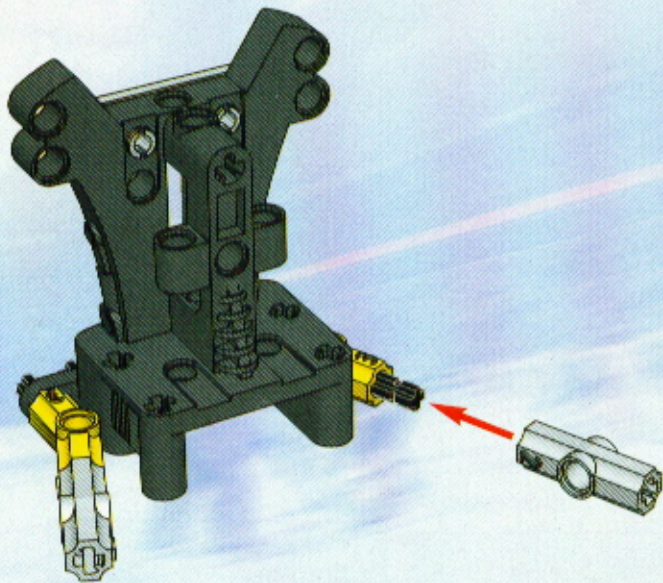

5

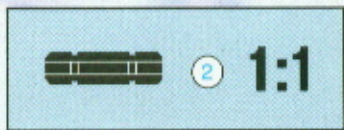
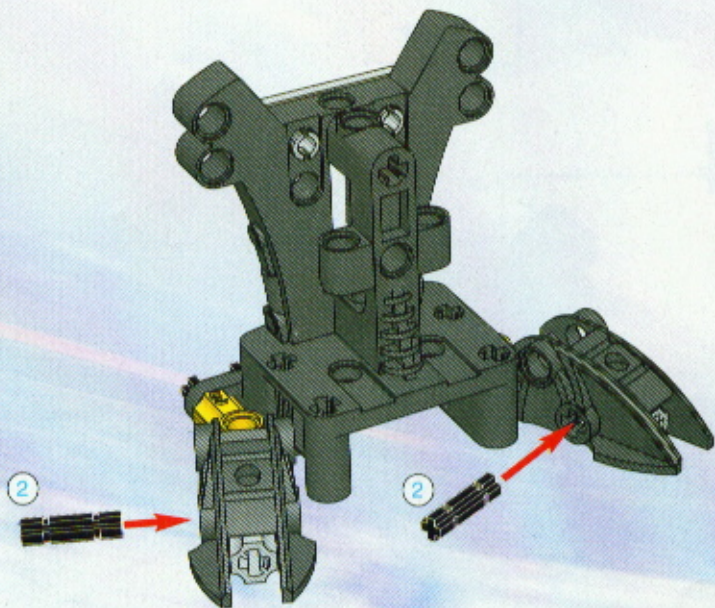

6

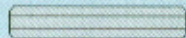
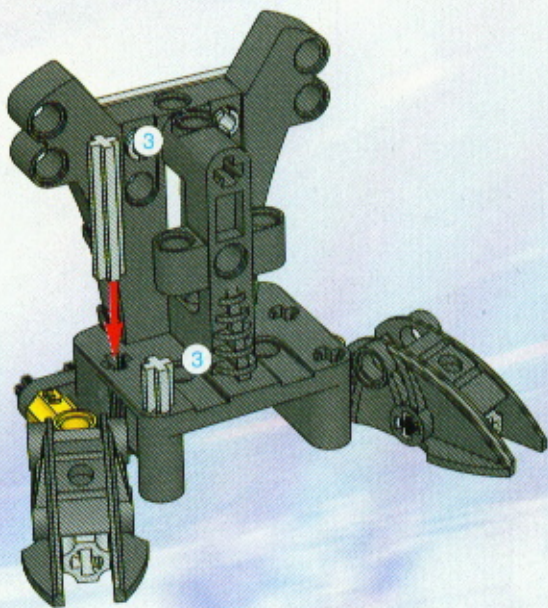

3

1:1

7

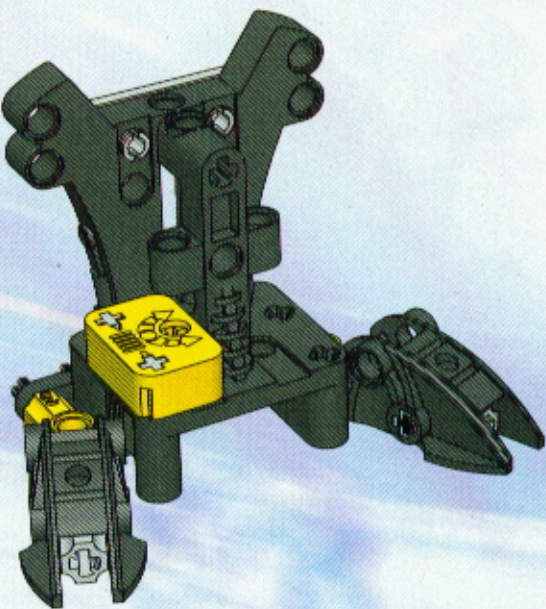

8

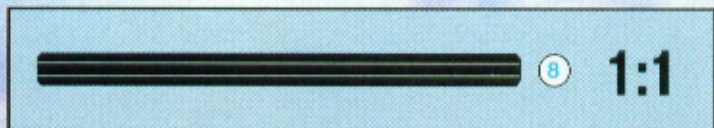
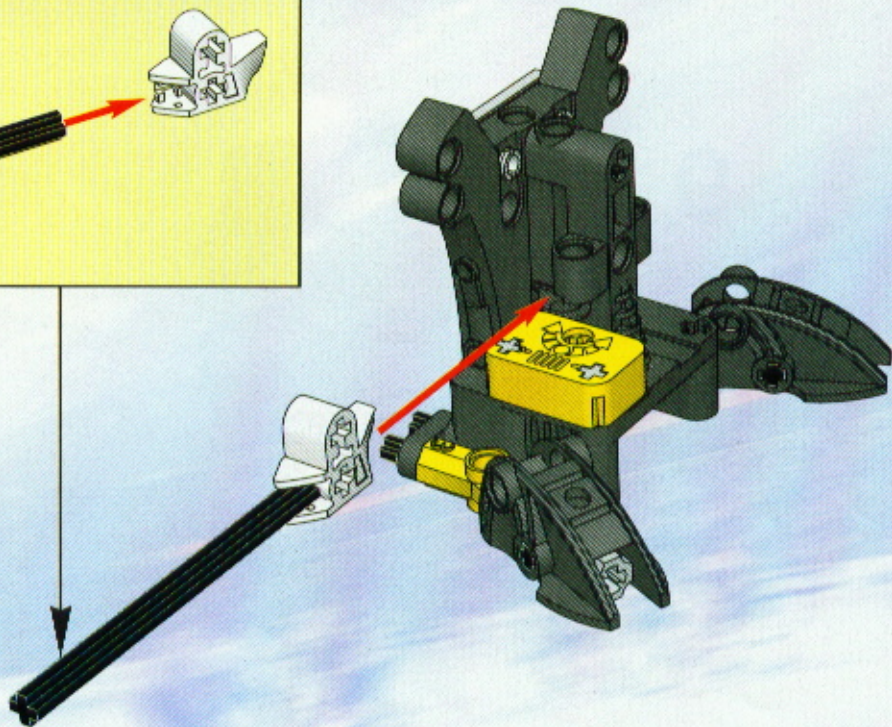
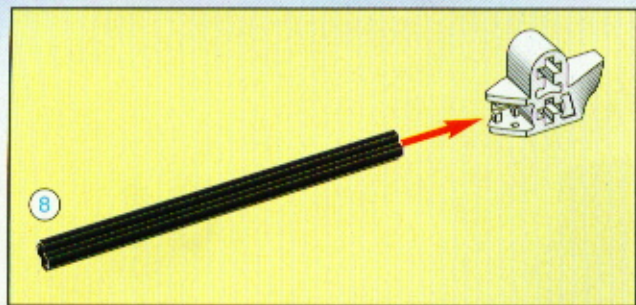

9

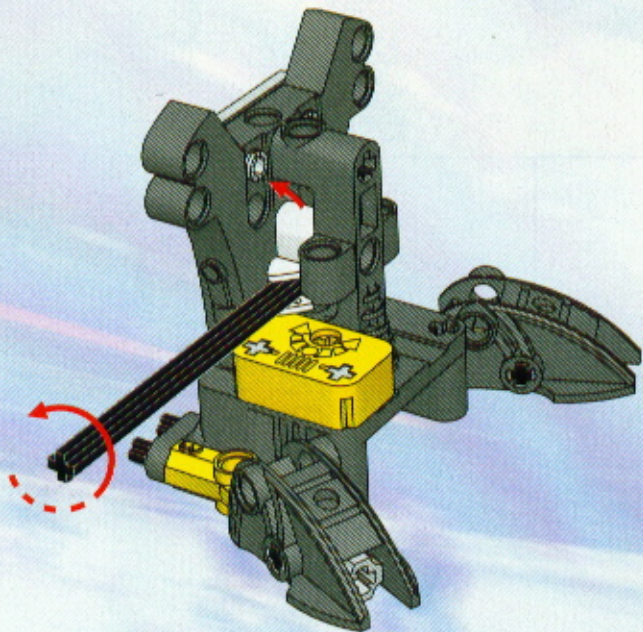

10

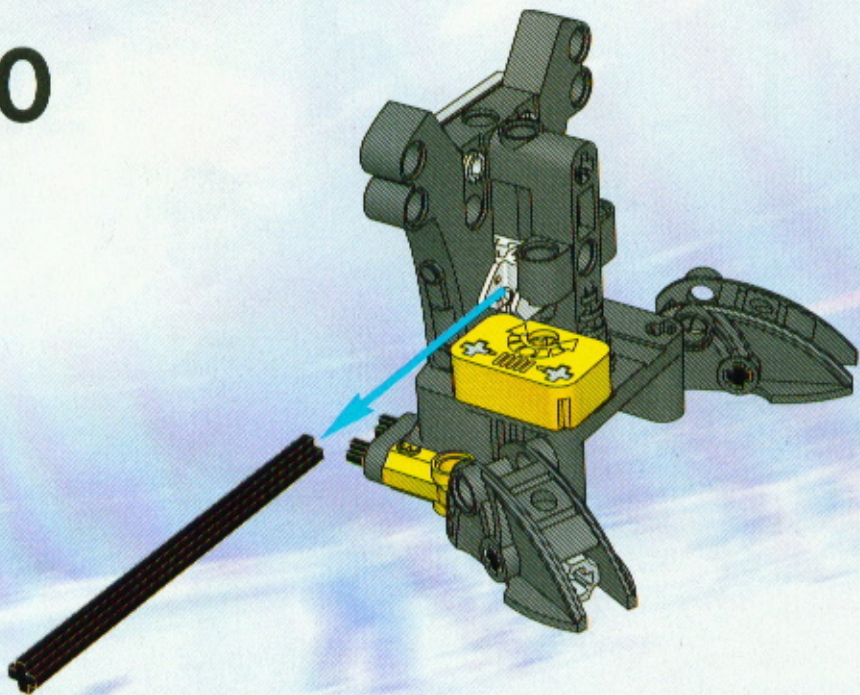

11

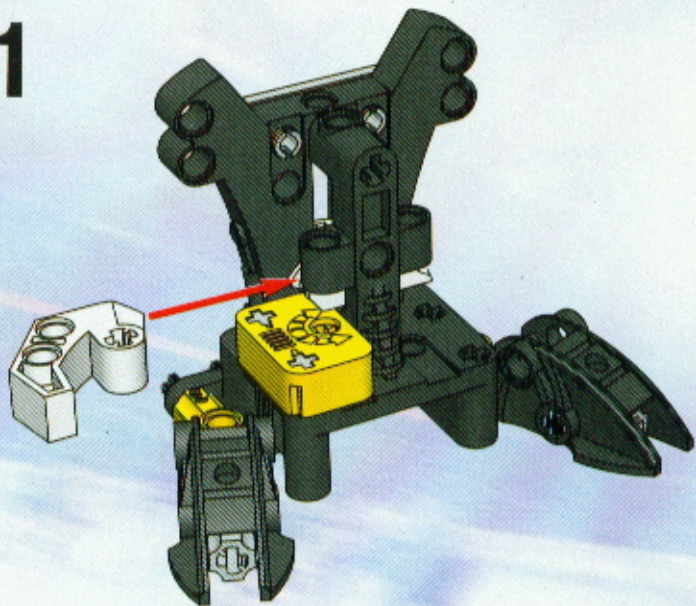

12

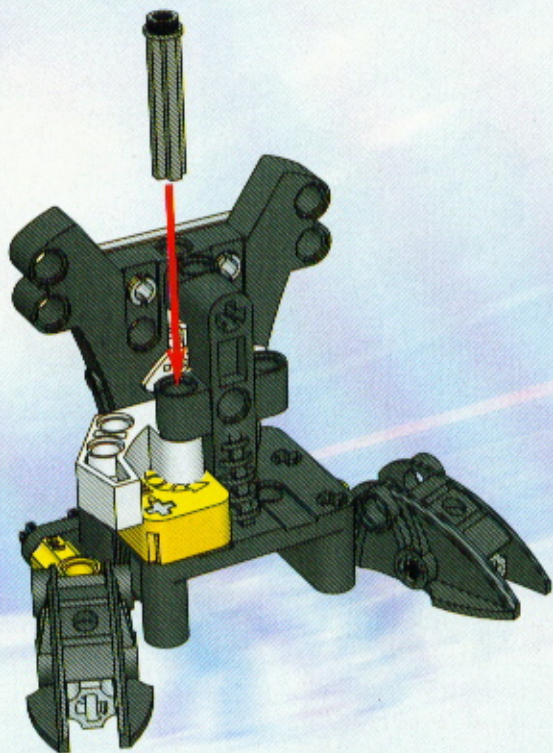

13

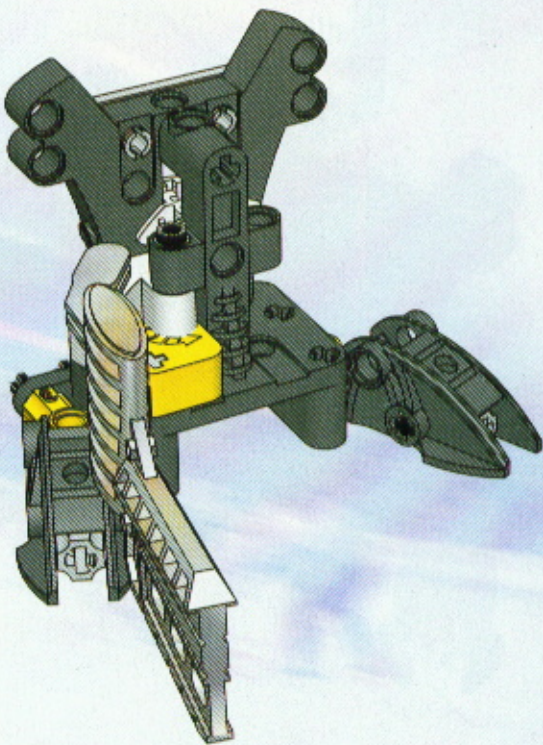

1

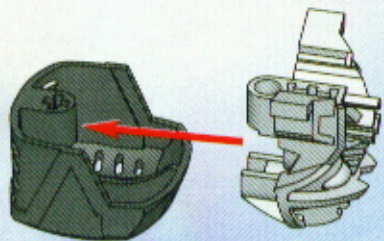

2

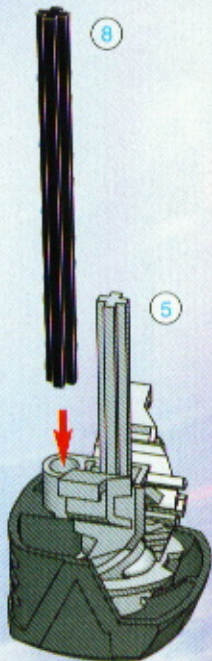

3

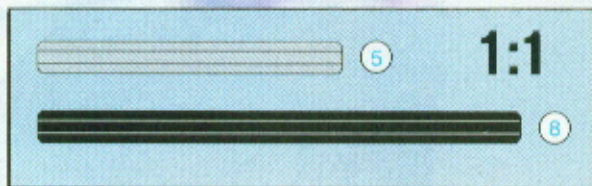
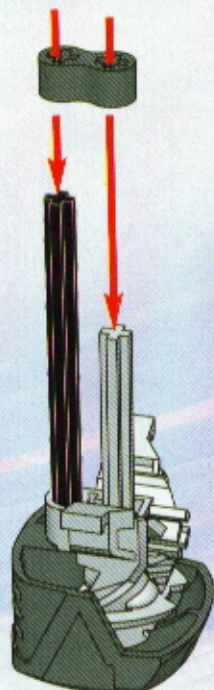

14

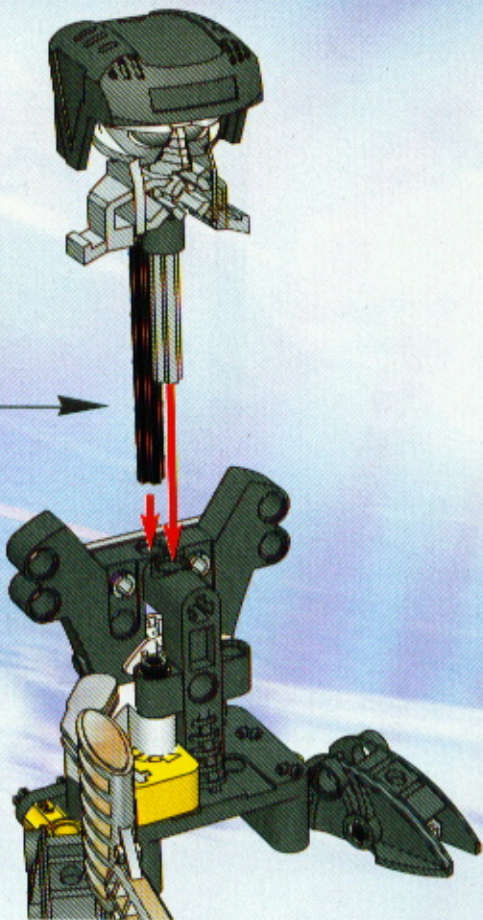

15

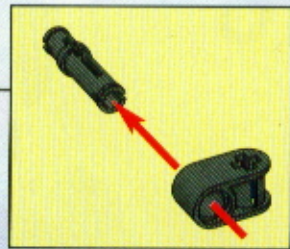
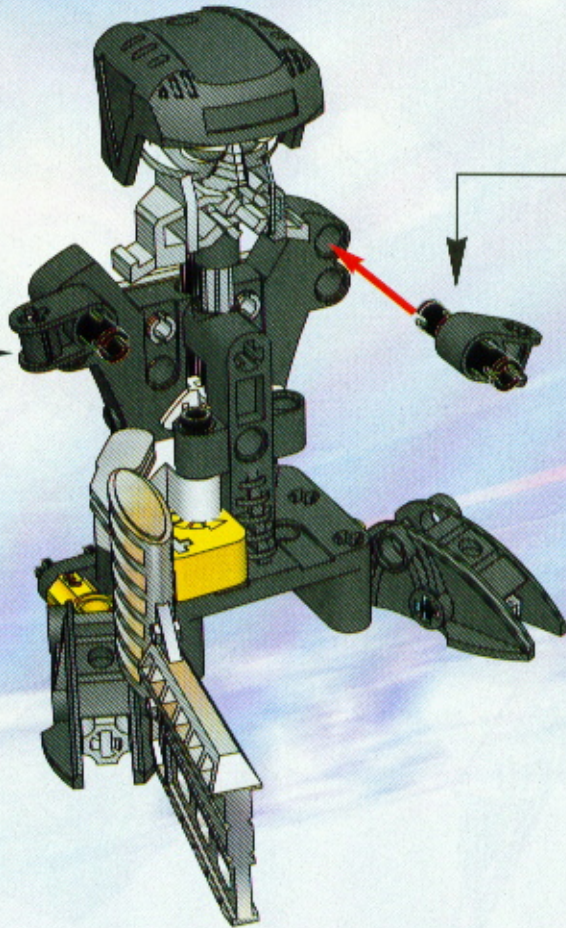

16

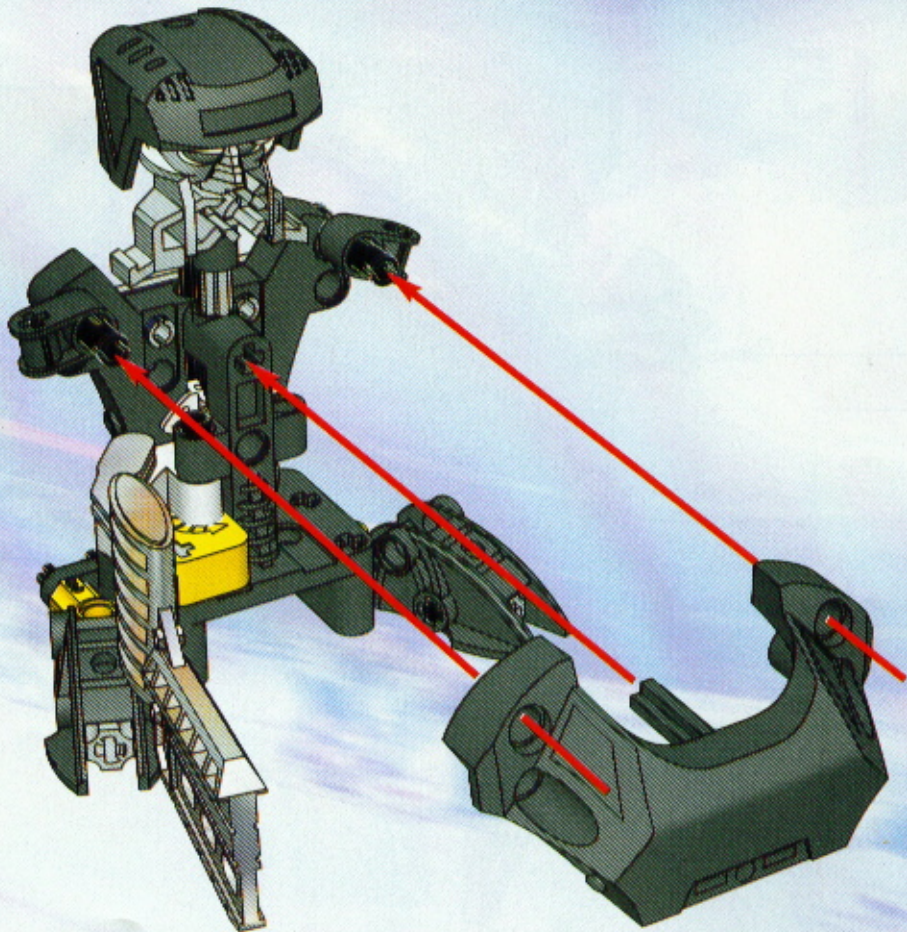

17

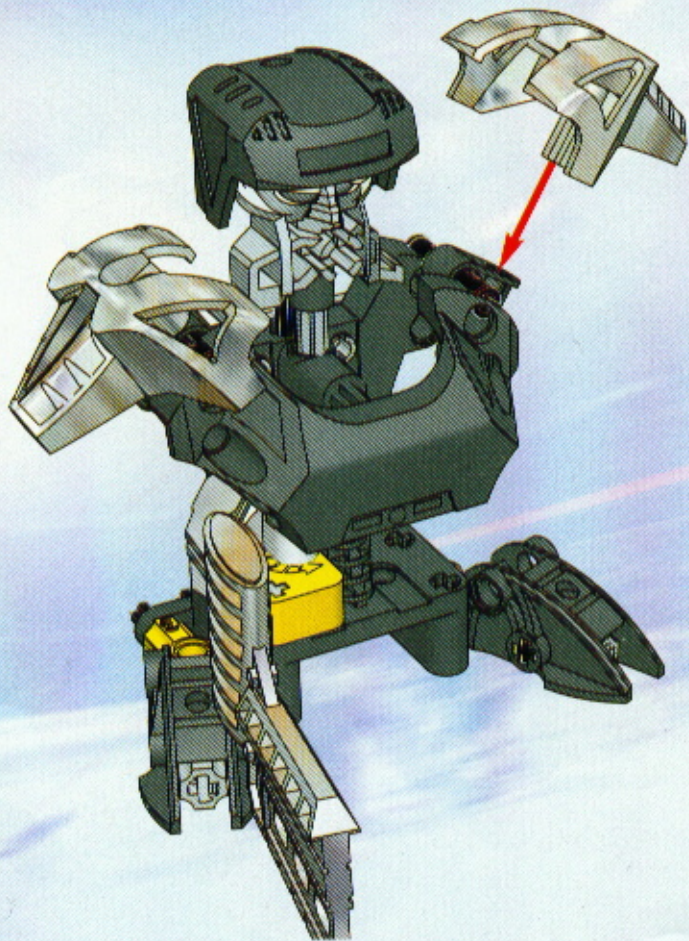

18

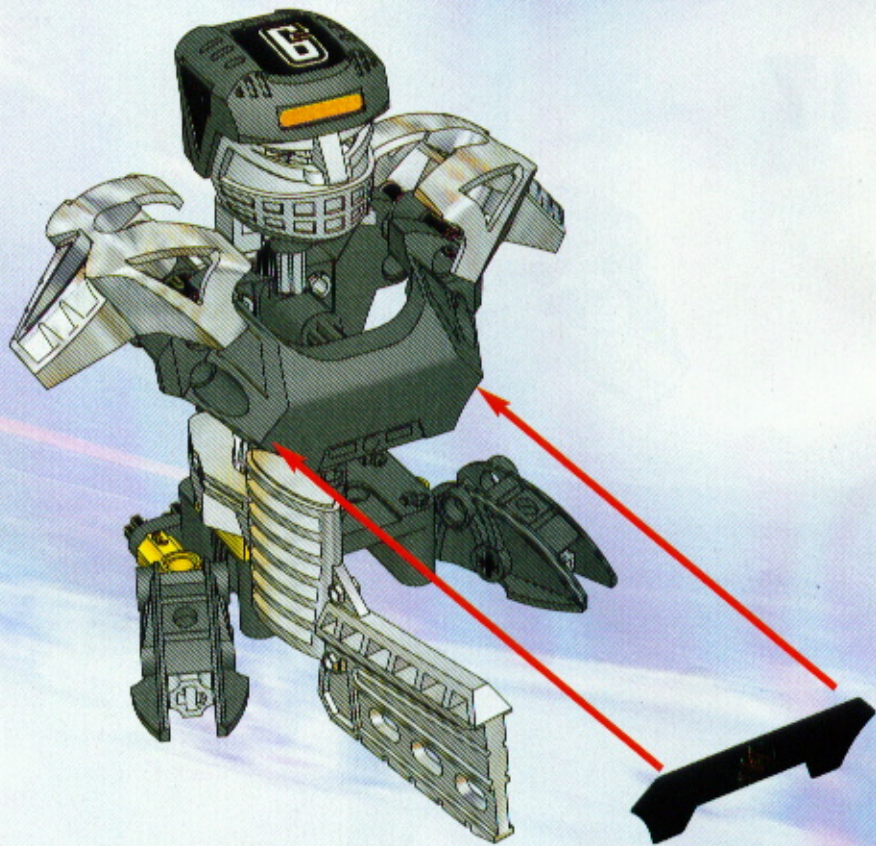

19

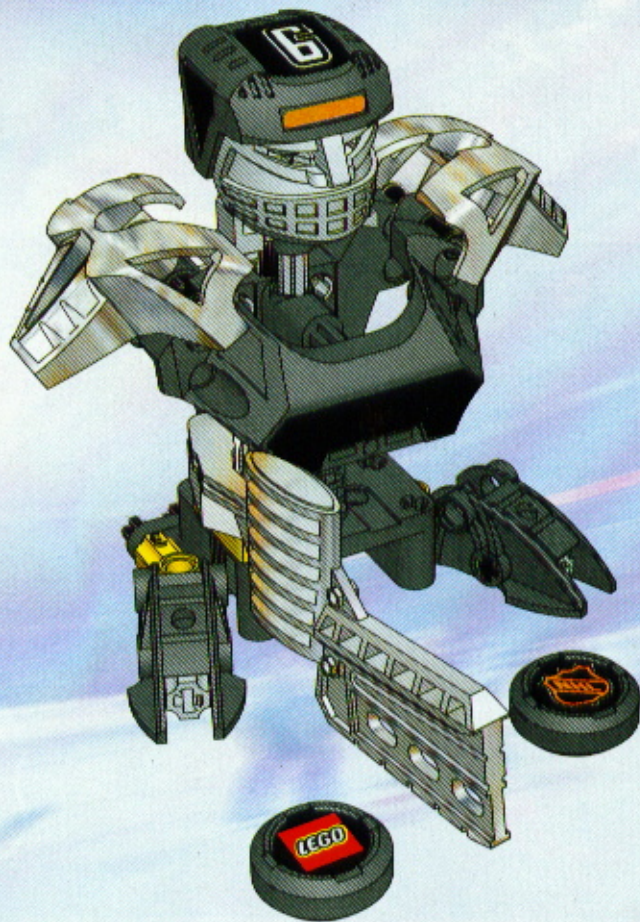

The LEGO logo is displayed in its characteristic white font with a black outline, set against a solid red rectangular background.

www.LEGO.com/sports

nhlpa
.COM



LEGO, the LEGO logo and the Minifigure are trademarks of the LEGO Group.
©2010 The LEGO Group.

NHL and the NHL Shield are registered trademarks of the National Hockey League. All NHL logos and marks and team logos and marks depicted herein are the property of the NHL and the respective teams and may not be reproduced without the prior written consent of NHL Enterprises, L.P. © NHL 2010. All Rights Reserved.

© NHLPA, NHLPA, National Hockey League Players' Association and the NHLPA logo are trademarks of the NHLPA.



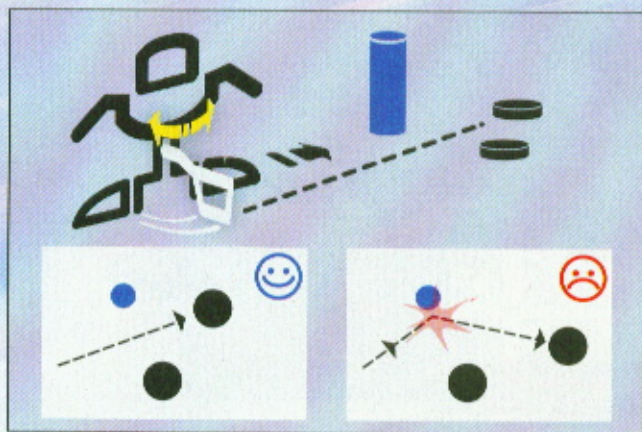
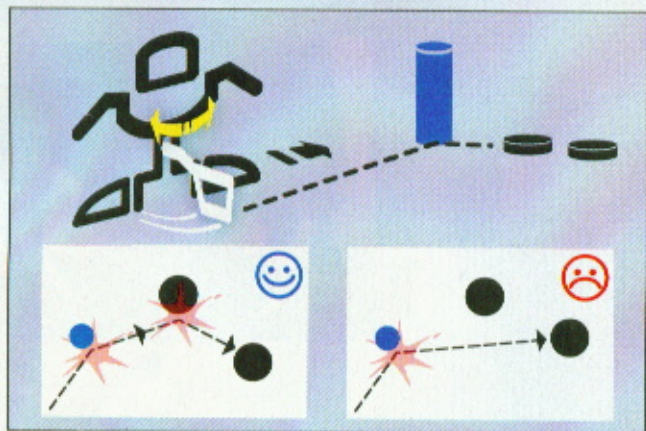

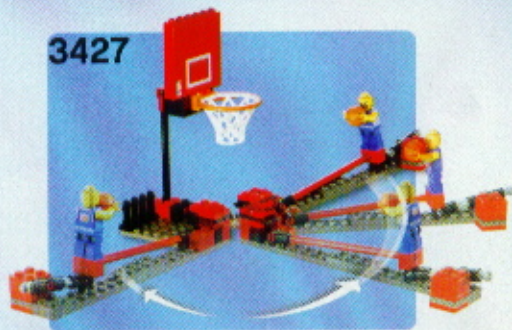



3428



3429



3433

- | | | | |
|------|--|--|--|
| 3560 | | | |
| 3561 | | | |
| 3562 | | | |
| 3563 | | | |
| 3564 | | | |
| 3565 | | | |
| 3566 | | | |
| 3567 | | | |



3420

3421





3422



3424



3423

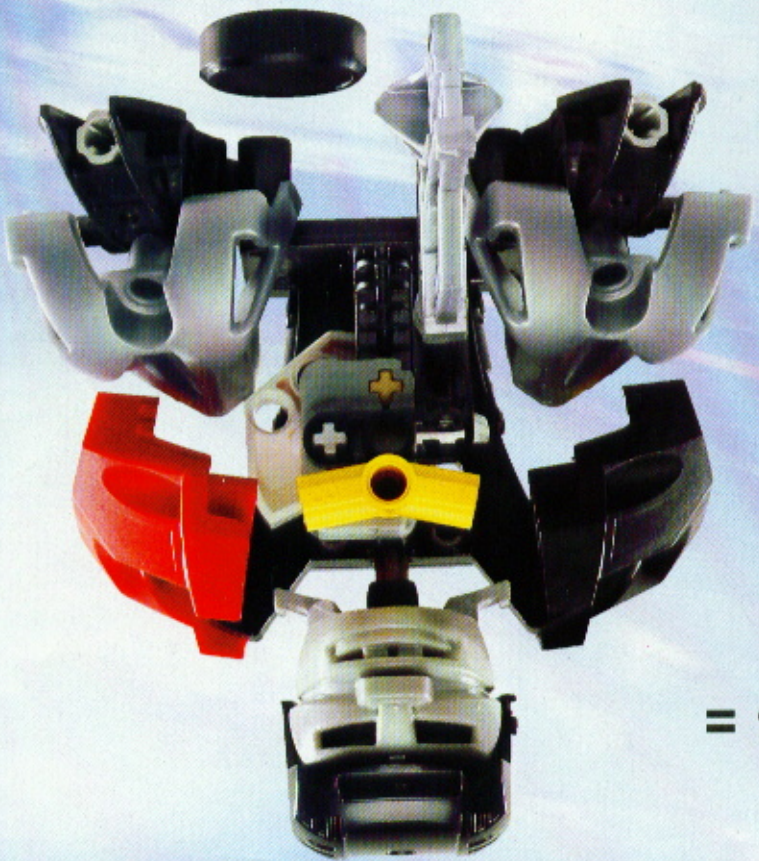

3540 + 3543 =

EN: Clean before use

DE: Bitte vor Gebrauch reinigen

FR: Nettoyer avant usage

IT: Pulire prima dell'uso

NL: Vóór gebruik reinigen

ES: Limpiar antes de usar

DA: Rengøres før brug

FI: Puhdistaa ennen käyttöä

SV: Rengör innan användning

PT: Limpar antes da utilização

EL: Καθαρίστε πριν τη χρήση

JP: 汚れを落とすしてから使用してください。

CN:

請於使用前清洗乾淨

KO:

사용전에 깨끗이 7 24 4000 404948

RU:

Перед использованием очистите

PL:

Wyczyścić przed użyciem

CS:

Před použitím omýjte vodou.

SK:

Pred použitím umyte vodou.

HU:

Használat előtt tisztítsd meg!

UA:

Перед використанням очистити

HR:

Čistite prije uporabe

SR:

Очистити пре употребе

SL:

Pred uporabo očisti

RO:

A se curăța înainte de utilizare

BG: Почистете преди употреба

LT:

Prieš naudojimą nuvalyti

ET:

Enne tarvitamist puhastada

LV:

Pirms lietošanas jānotīra

TR:

Kullanmadan önce temizleyin

2

MAX
65°C
150°F



3



LEGO SPORTS



NBA identifications depicted are the exclusive property of NBA Properties, Inc. and/or the NBA Member Teams, and are used with permission. SPALDING is a trademark of Spalding Sports Worldwide, Inc. or Lice Sports, Inc. Spalding affiliate. Spalding Sports Worldwide, Inc. 2003.

 www.LEGO.com/sports

LEGO, the LEGO logo and the Minifigure are trademarks of the LEGO Group. ©2003 The LEGO Group.

adidas, the adidas logo and the three stripe trademark are registered trademarks of the adidas-Salomon group, used with permission. Reebok and the Reebok logo are trademarks of the adidas-Salomon group, used with permission.

NHL and the NHL Shield are registered trademarks of the National Hockey League. All NHL logos and marks and team logos and marks depicted herein are the property of the NHL and the respective teams and may not be reproduced without the prior written consent of NHL Enterprises, L.P. © NHL 2003. All Rights Reserved.



46206/4194689 © 2003 LEGO GROUP