

**LEGO**

**6+**

**4883**

**Designer Set**



Ideas



Instructions





Quick Build  
Schnellbaumodelle  
Construction rapide  
Costruzione rapida  
Snel bouwen  
Construcción rápida  
Byg hurtigt  
Nopeaan rakentamiseen  
Bygg snabbt  
Construção Rápida  
Γρήγορες Κατασκευές  
Kísérletezőknek



Experienced Build  
Könnernmodelle  
Construction normale  
Costruzione esperta  
Bouwen voor gevorderden  
Construcción experta  
Byg videre  
Kokeneelle rakentajalle  
Bygg mer  
Construção para Experimentados  
Επιδέξιες Κατασκευές  
Haladóknak



Advanced Build  
Profimodelle  
Construction avancée  
Costruzione avanzata  
Geavanceerd bouwen  
Construcción avanzada  
Byg avanceret  
Taitavalle rakentajalle  
Bygg avancerat  
Construção Avançada  
Εξελιγμένες Κατασκευές  
Profiknak





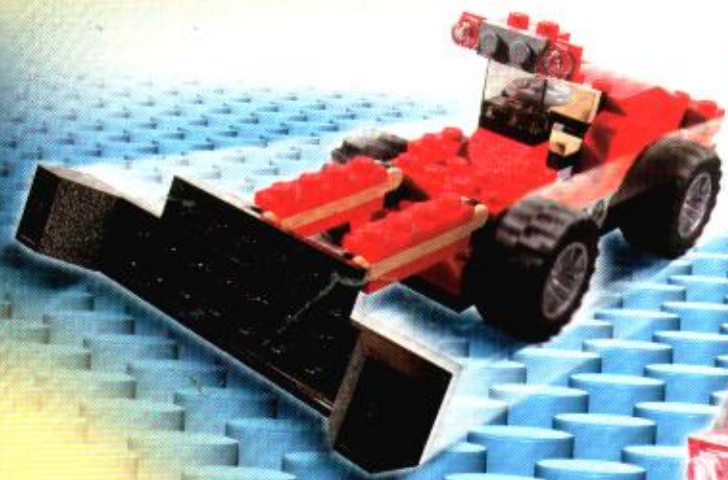





1

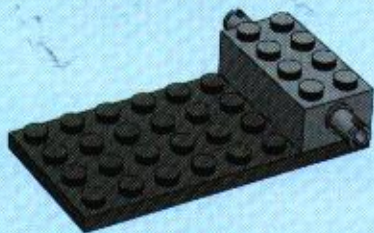

2

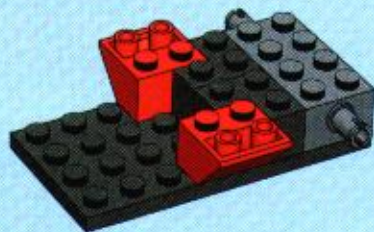

3

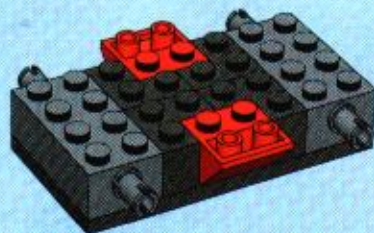

4

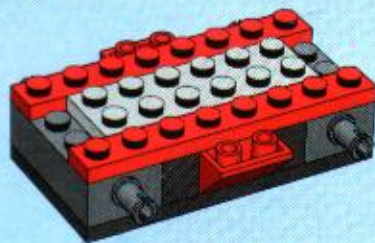

1



2

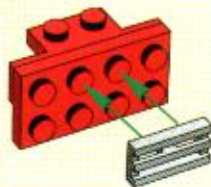

5

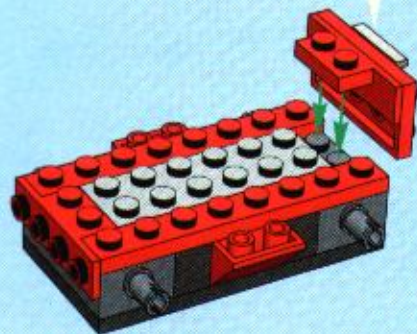



1



2

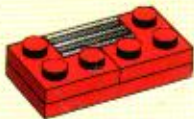

3



6

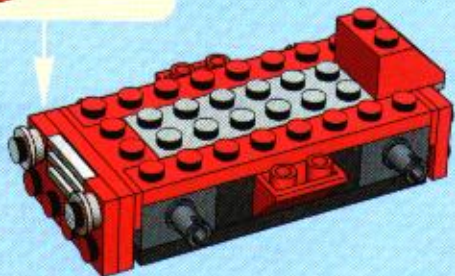

7

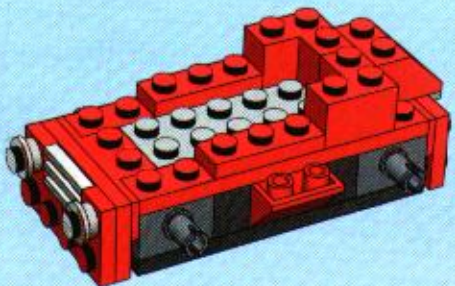

2x

8

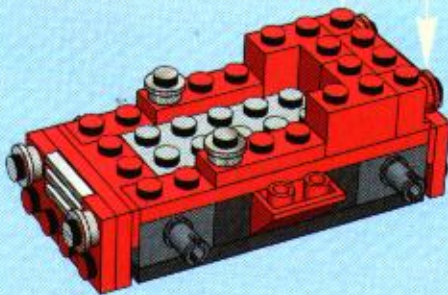

9

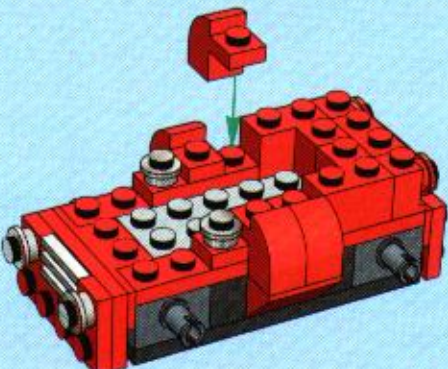



10

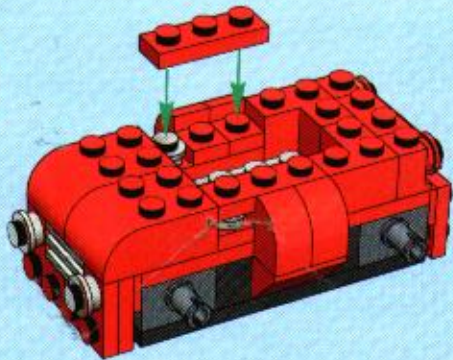

11

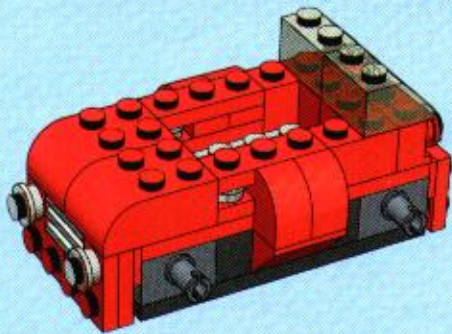

12

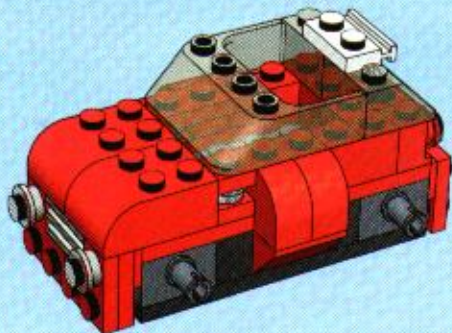

13

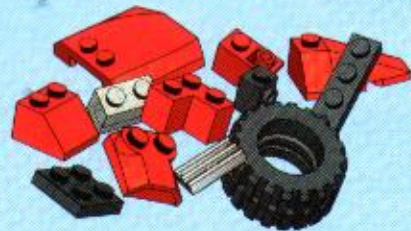
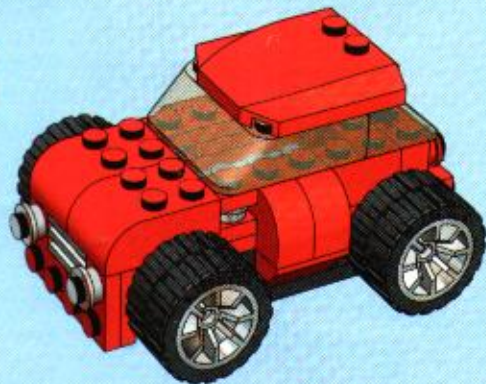

=



22



54





1

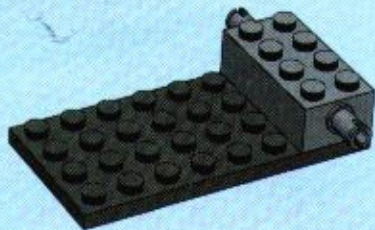

2

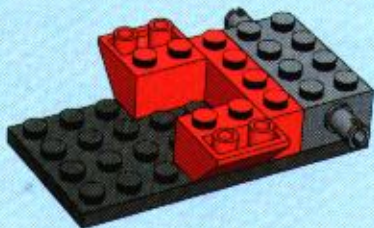

3

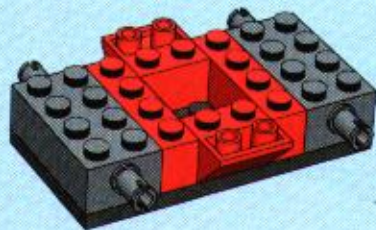

4

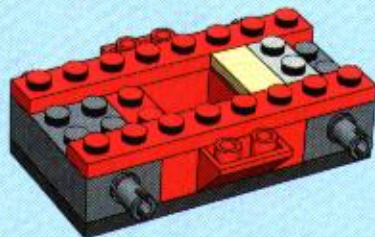





5

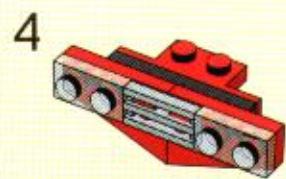
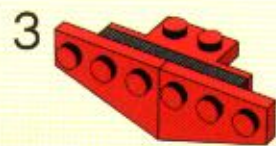
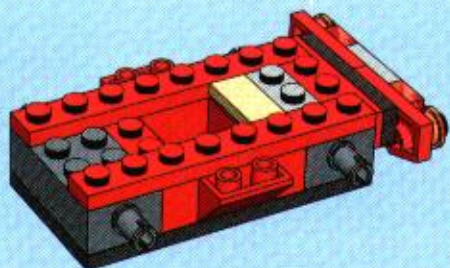

6

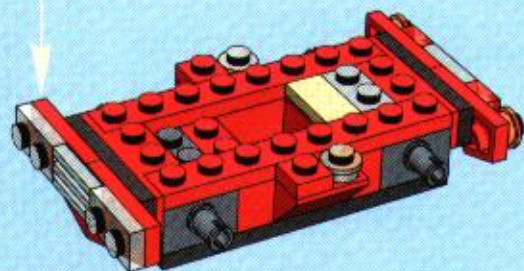



7

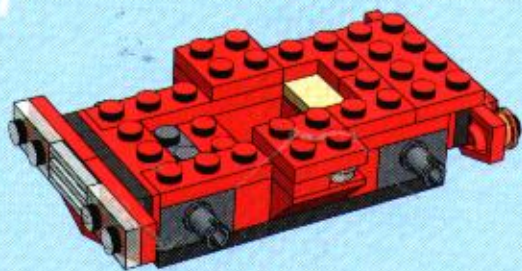

8

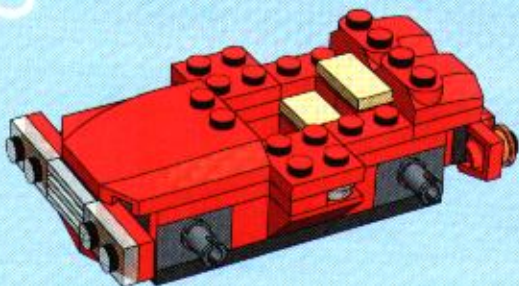

9

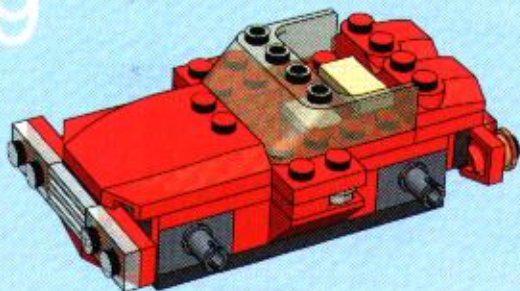

10

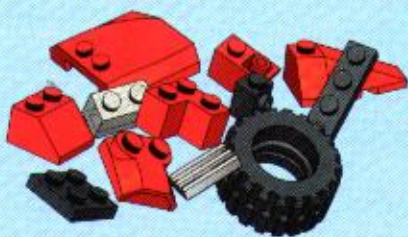
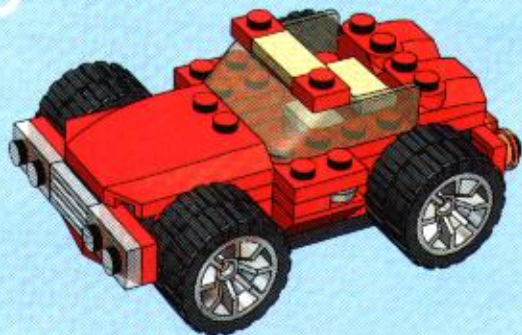

=







1

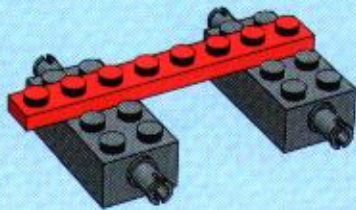

2

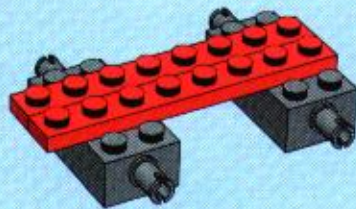

3

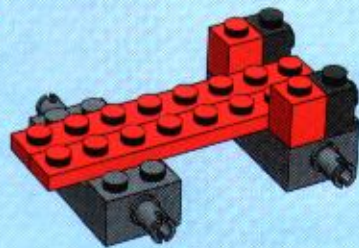

4

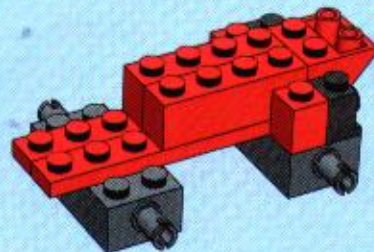

5

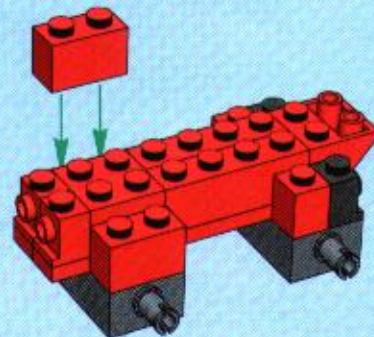



6

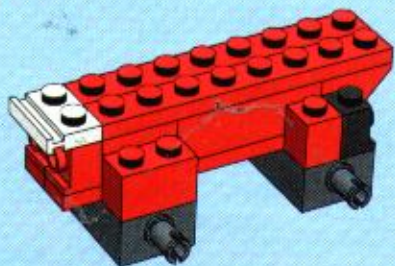

1



2



7

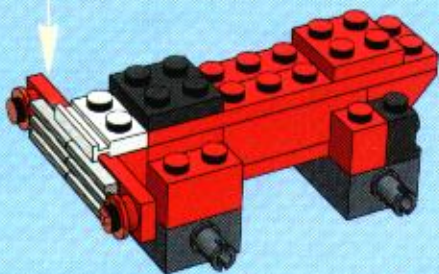

8

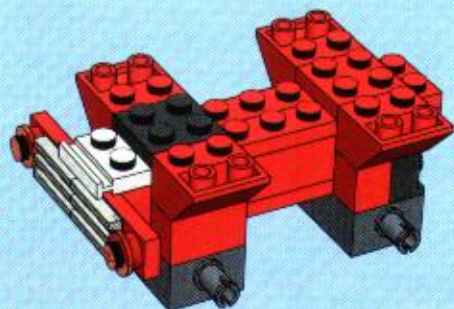

9

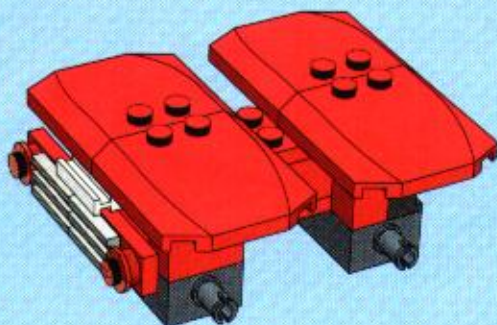



10

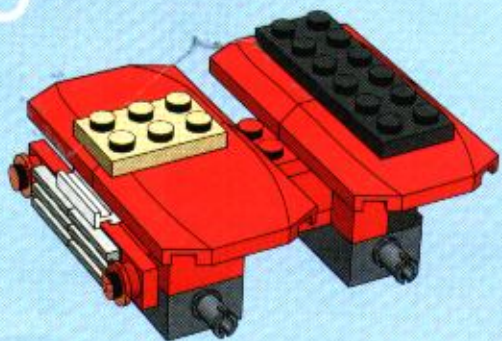

12

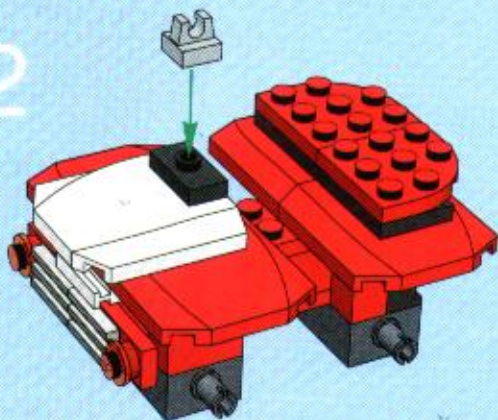

11

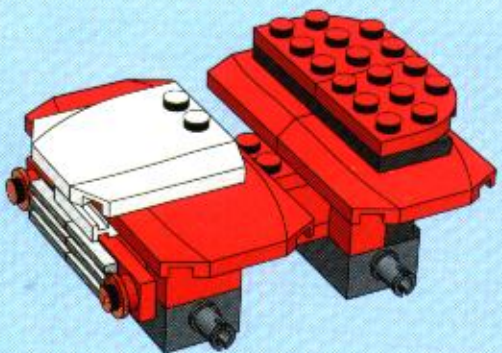

13

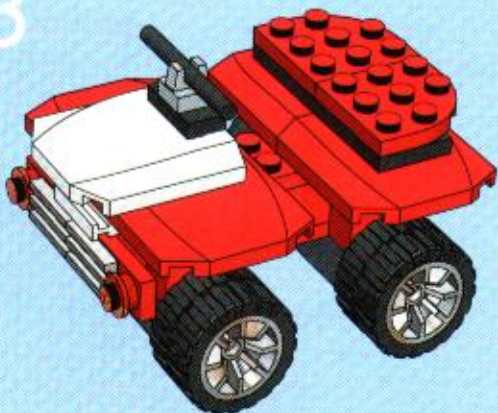





1

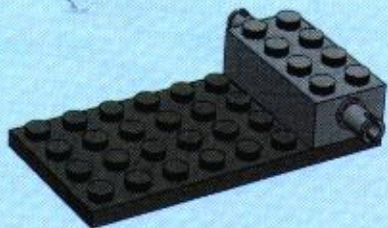

2

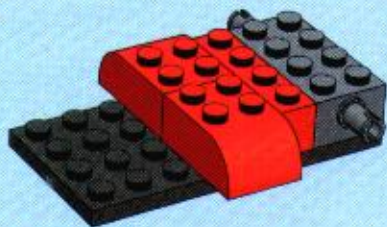

3

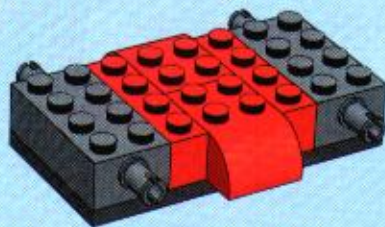

1



2



4

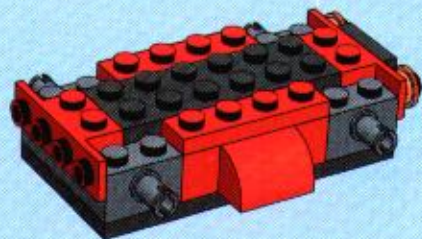



5

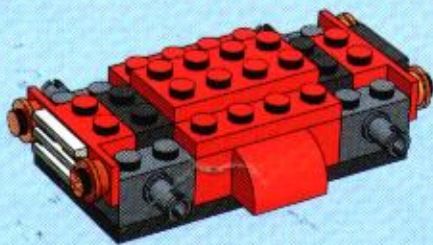

6

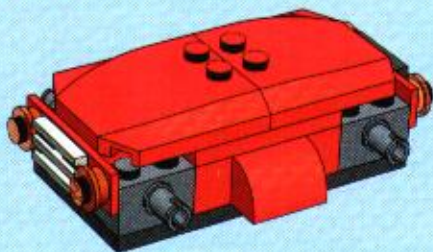

7

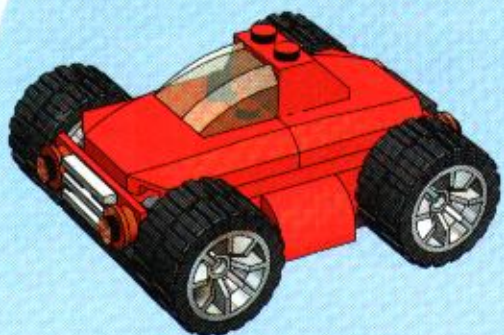

1



2

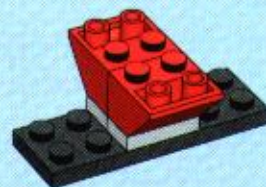

3

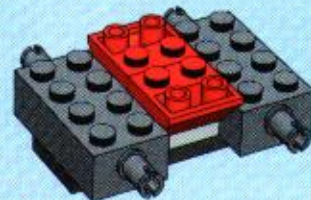



1



2



4

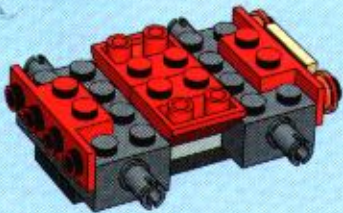

5

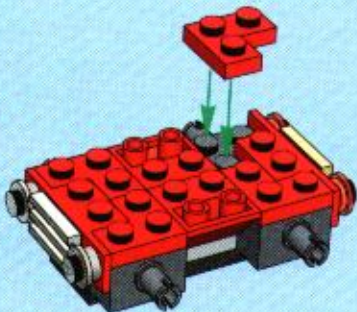

6

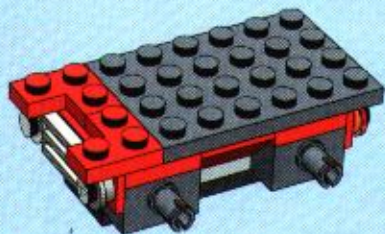

7

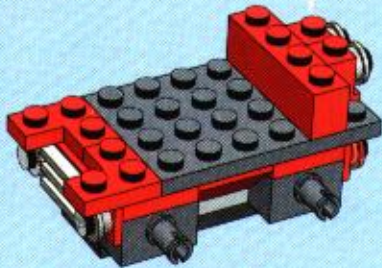



8



9

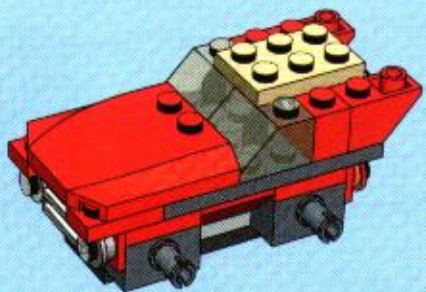

10

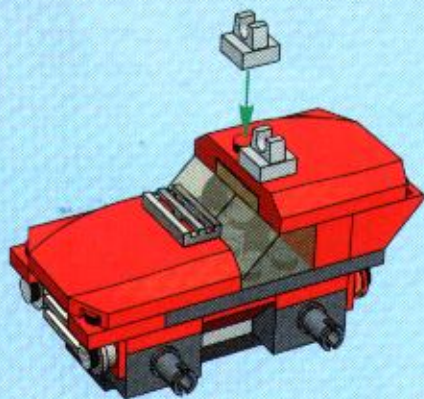

11







1

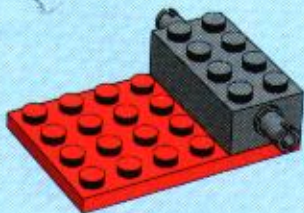

2

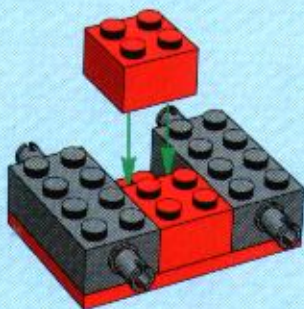

3

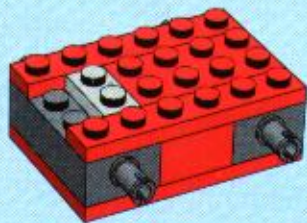

1



2

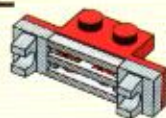

3



4

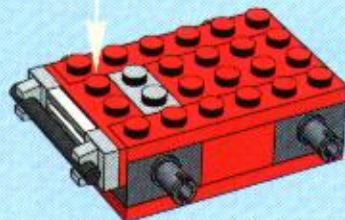



5

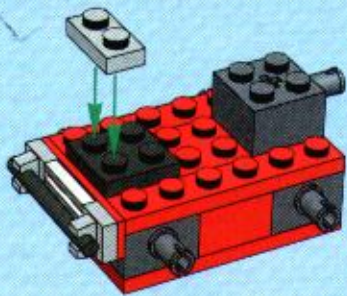

6

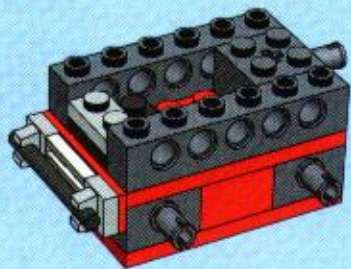

1



2



7

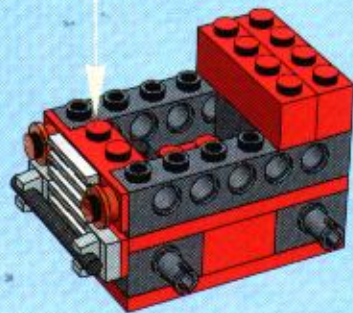

8

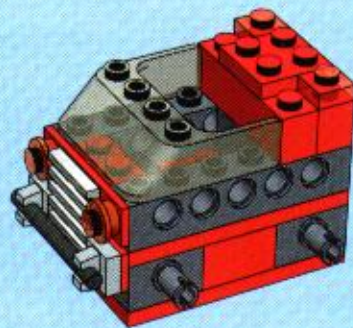



9

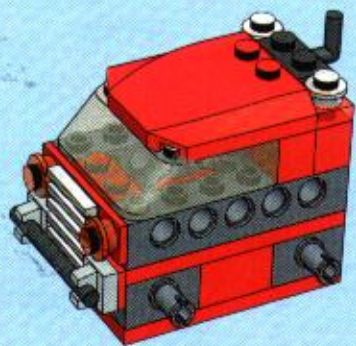

1



2



10

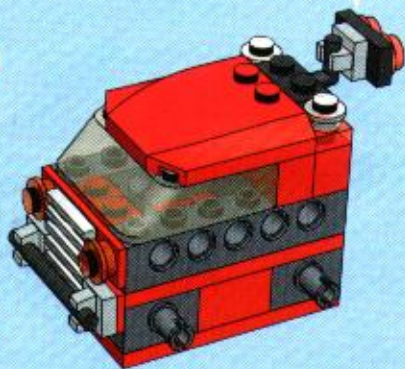

11

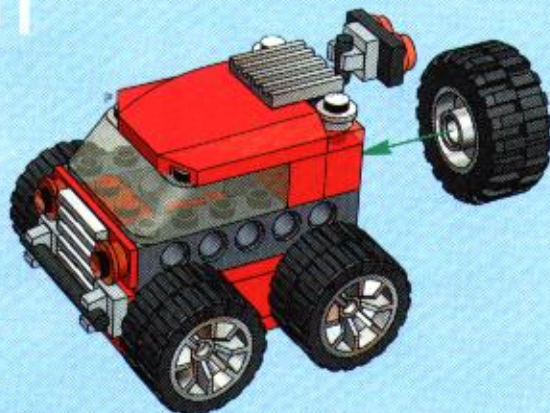













1

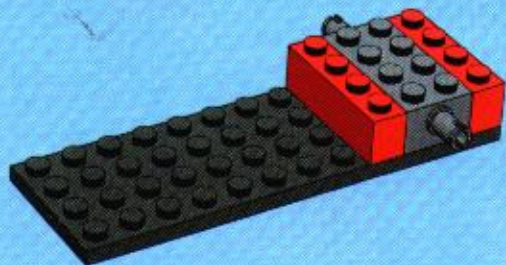

2

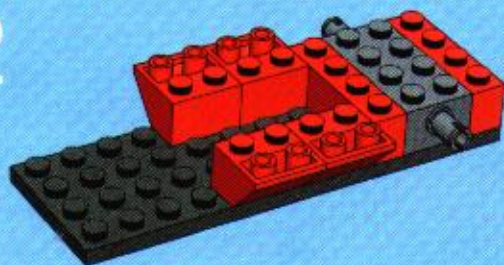

1



2



3



4



5



3

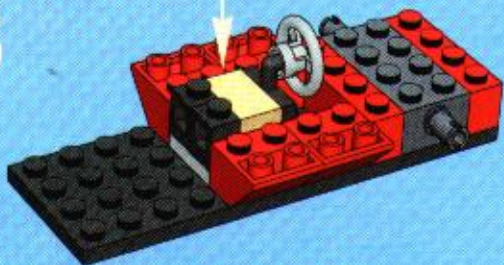

4





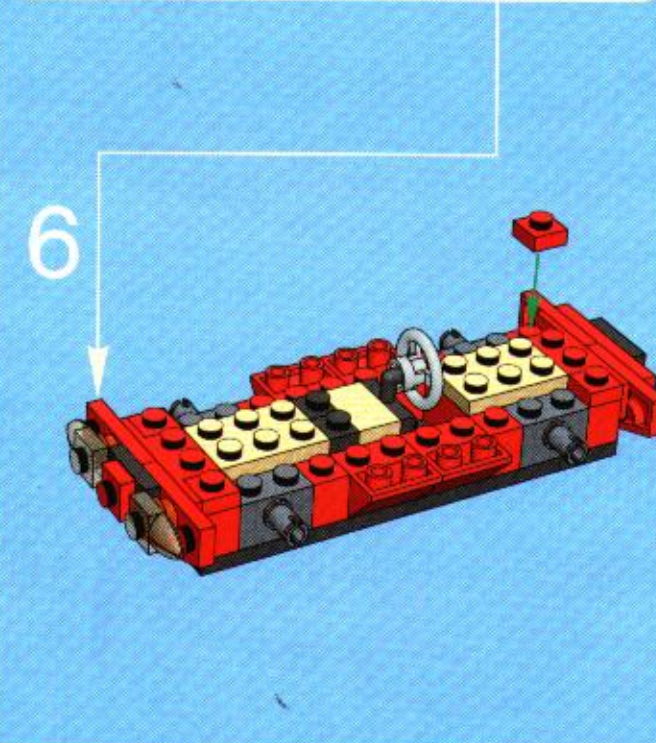
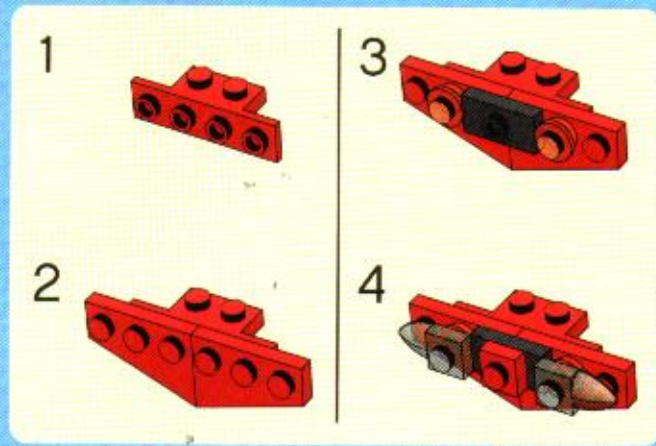
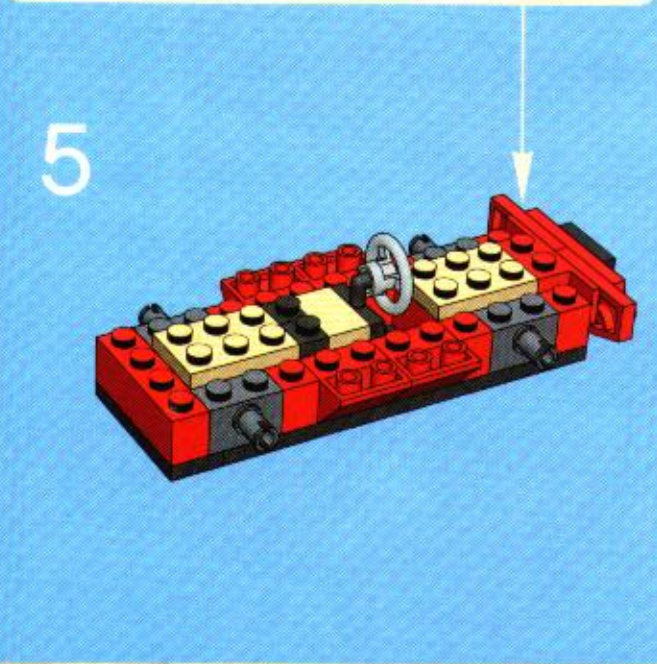
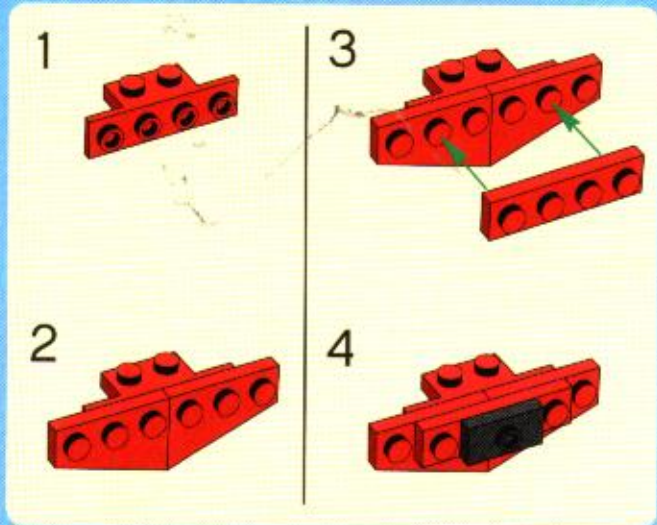



7

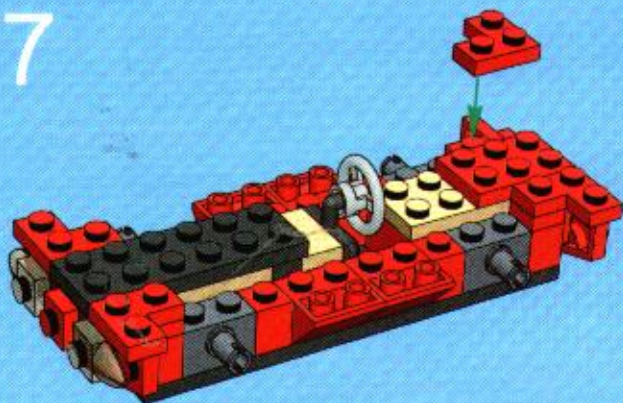

8

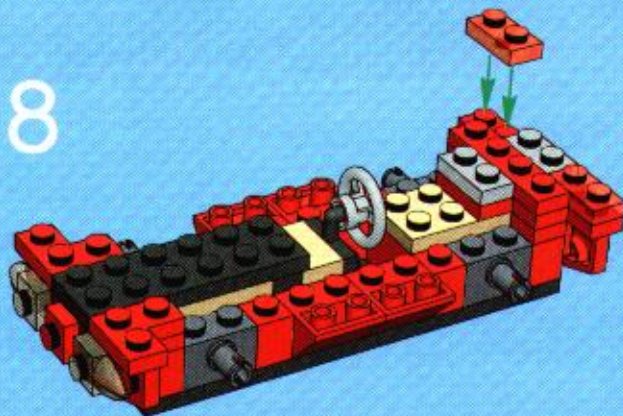

9

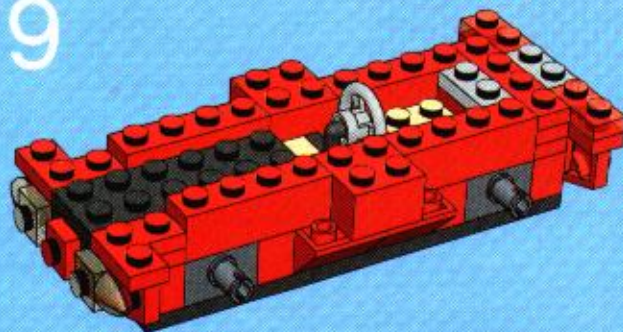

10

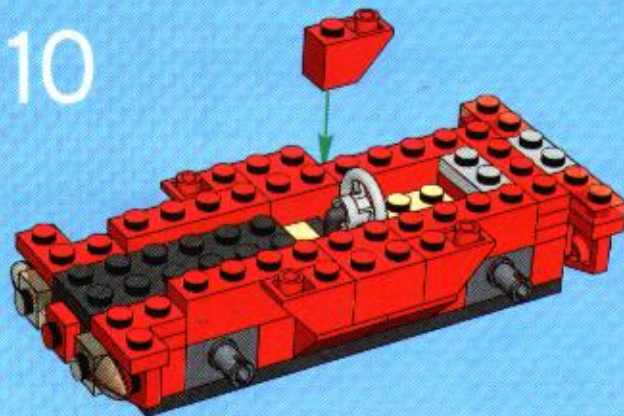

11

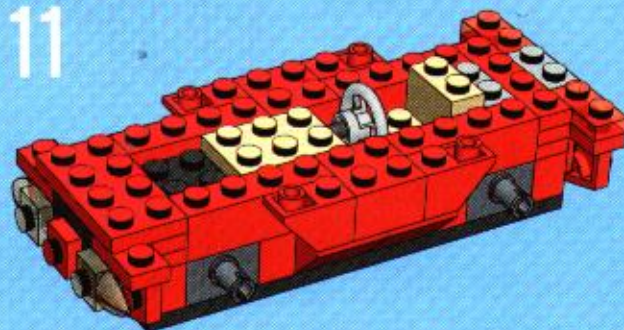

12

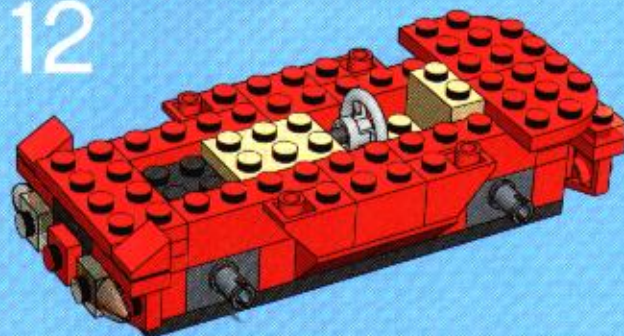



13

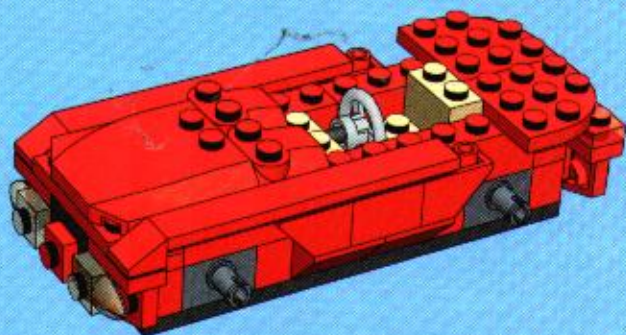

15

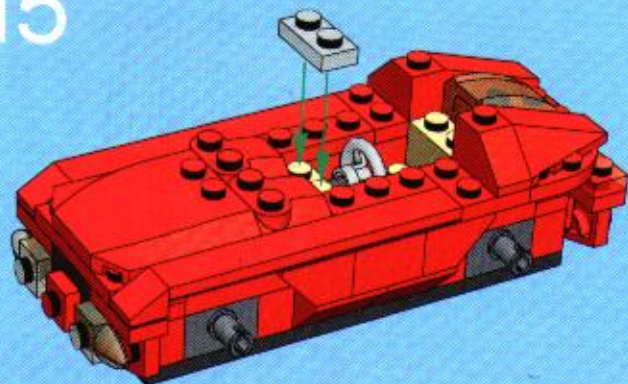

14

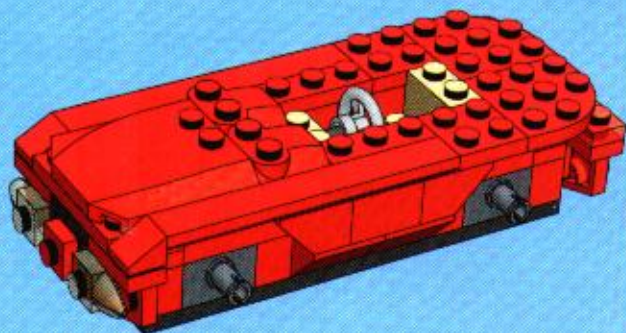

16

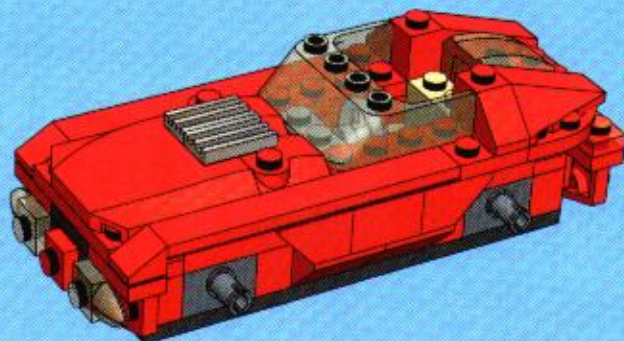



17

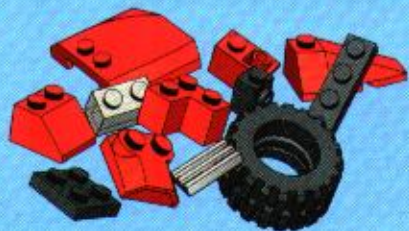
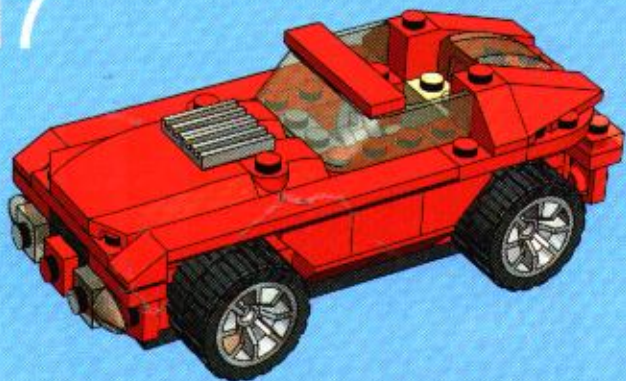

=



4



54



1

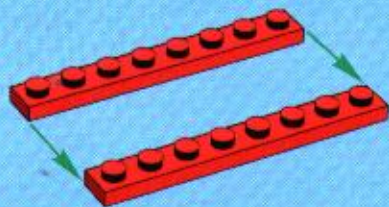

2

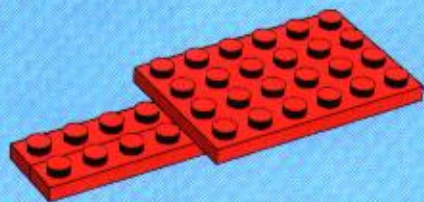



3

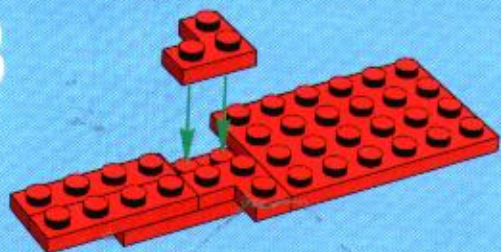

4

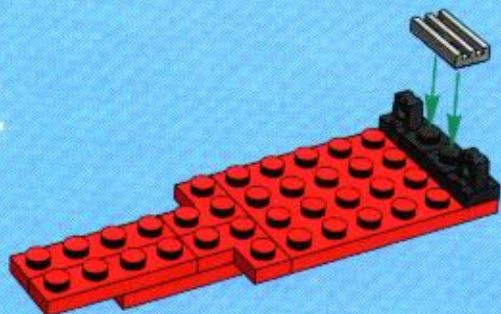

5

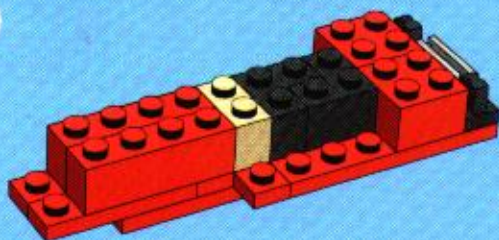

6

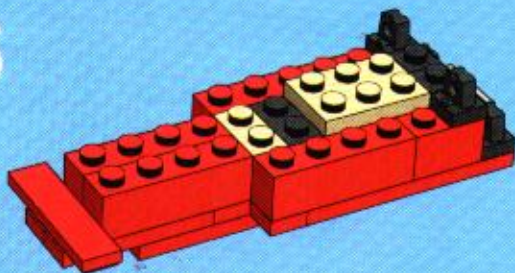

7

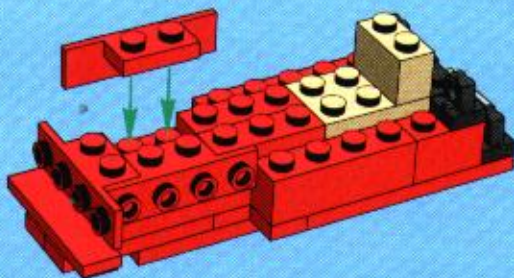

8

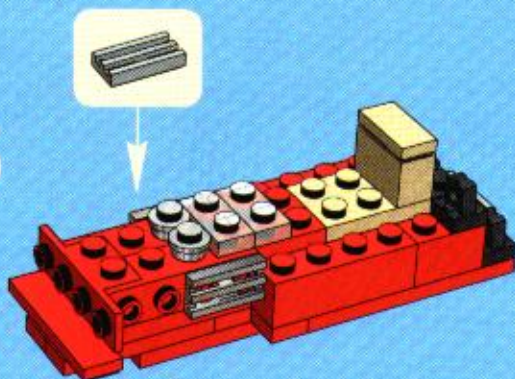



9

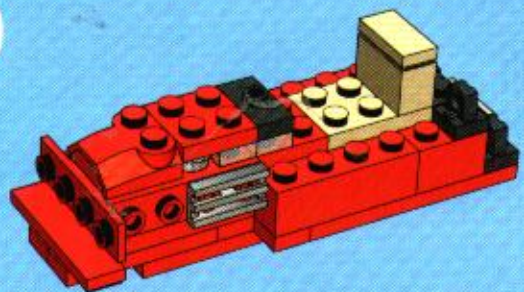

11

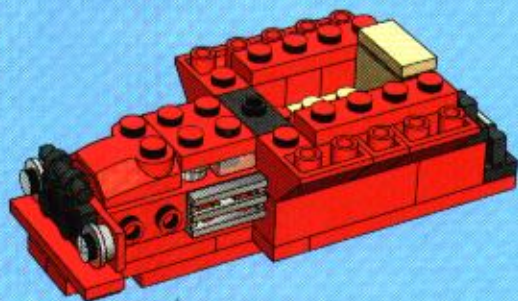

10

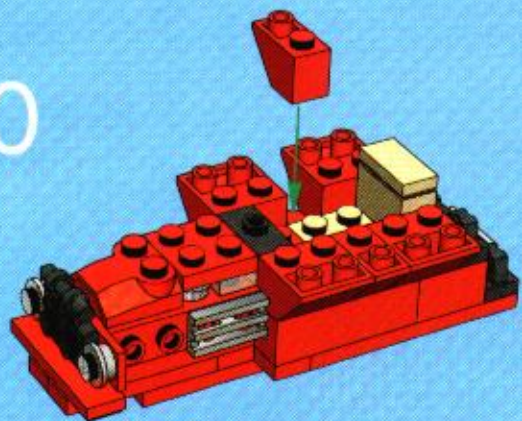

12

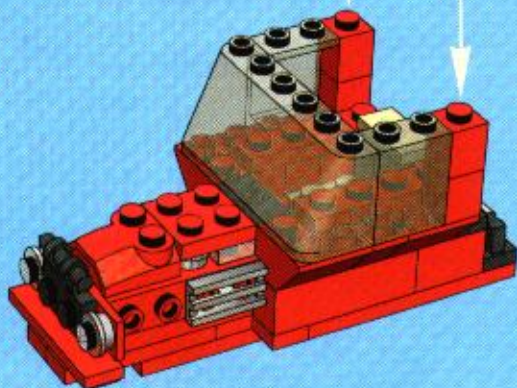
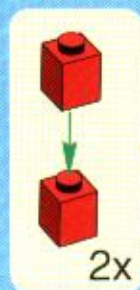



13

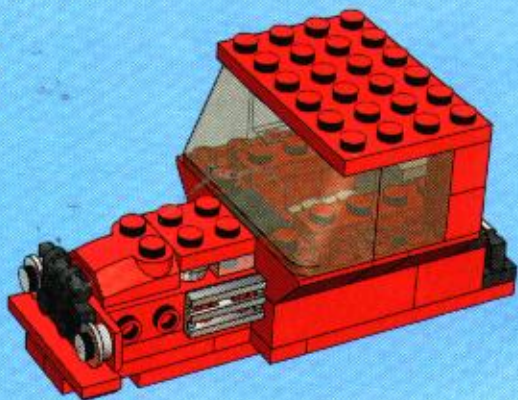

15

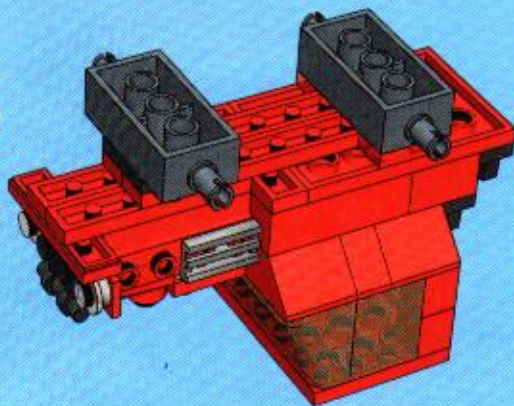

14

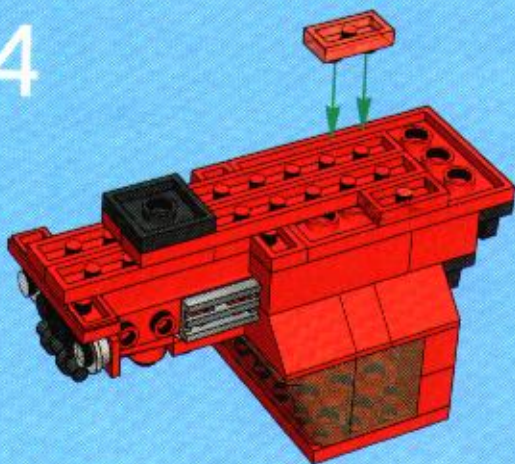

16

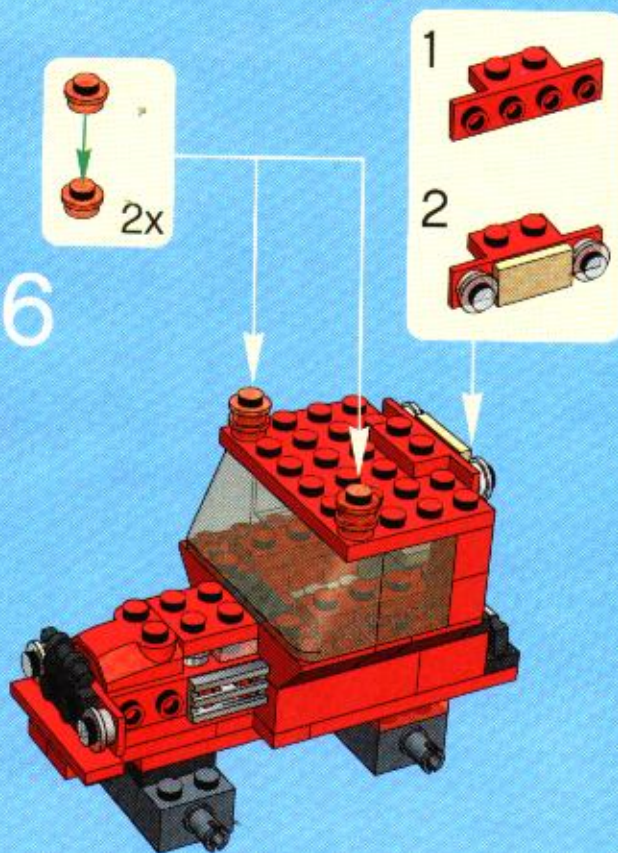



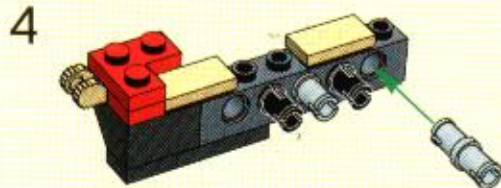
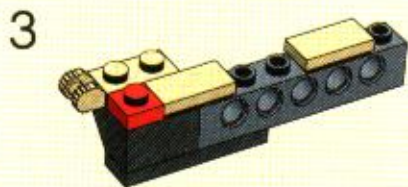

17

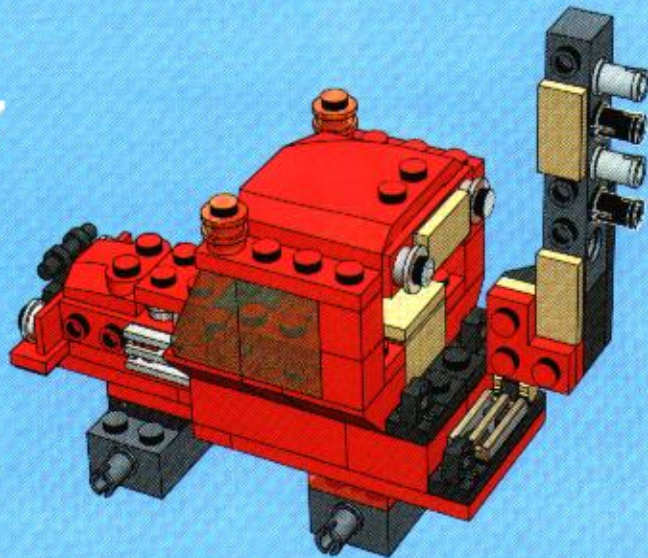



1



2



3

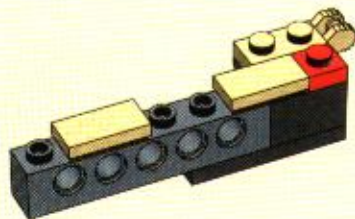

4

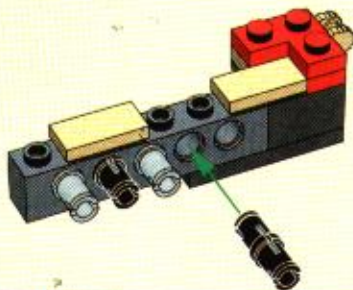

18

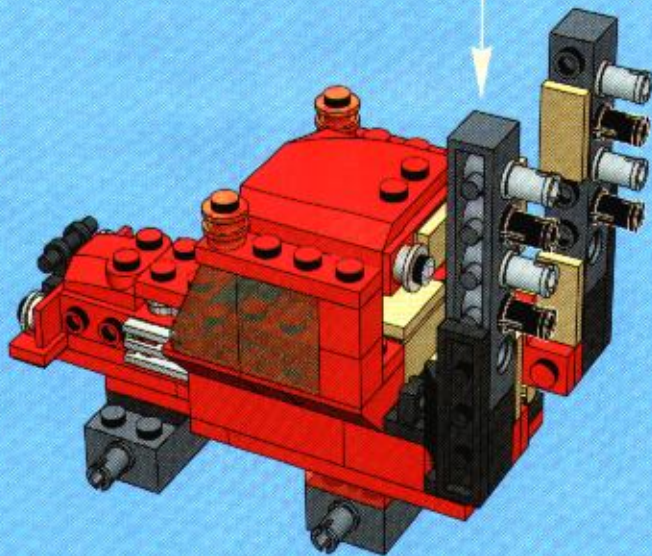



19

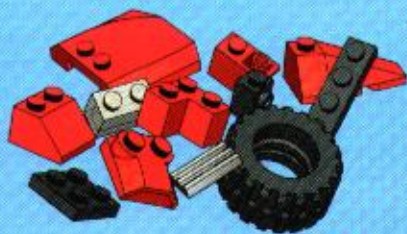
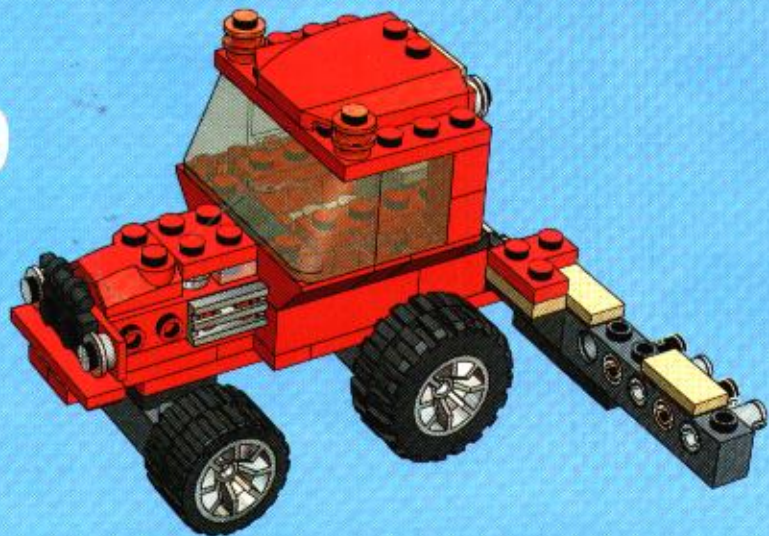

=



62





1

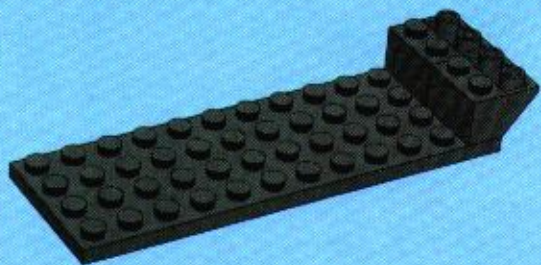

2

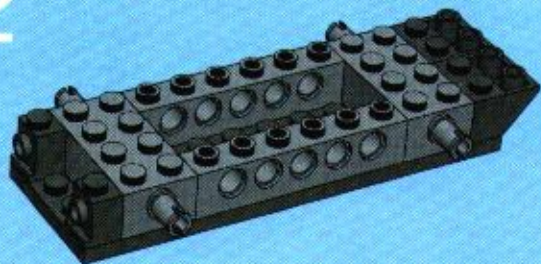

3

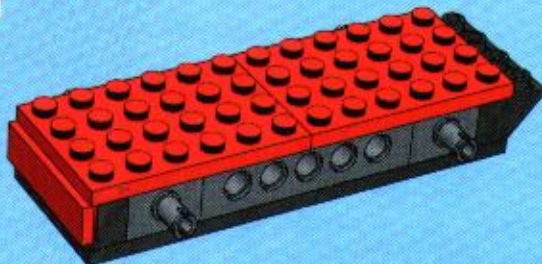

1



2



3

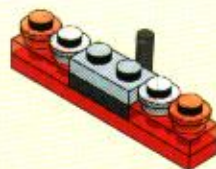

4



4

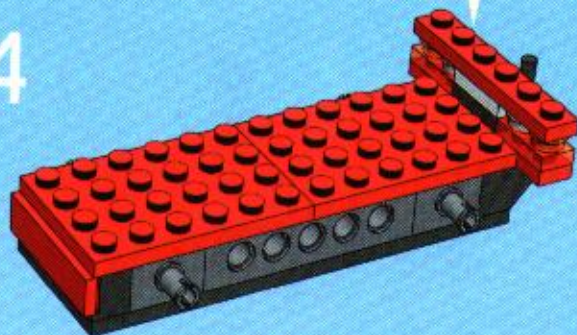



5

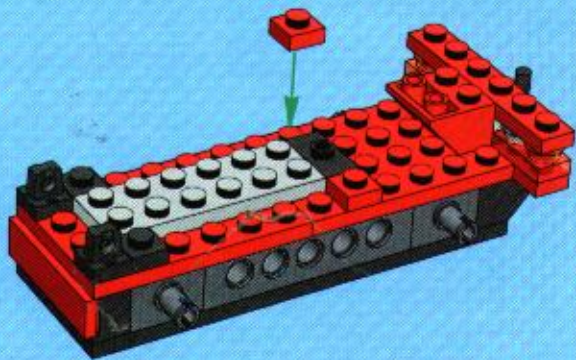

6

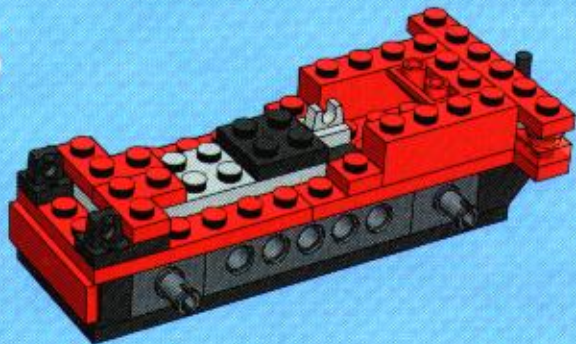

7

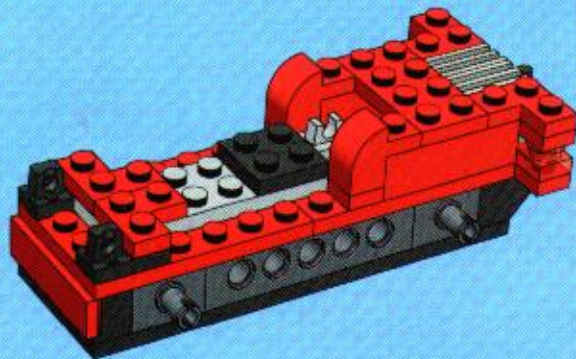

8

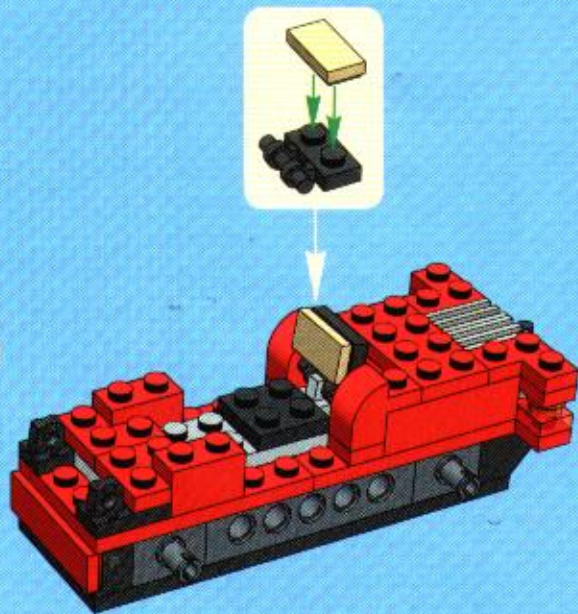

9

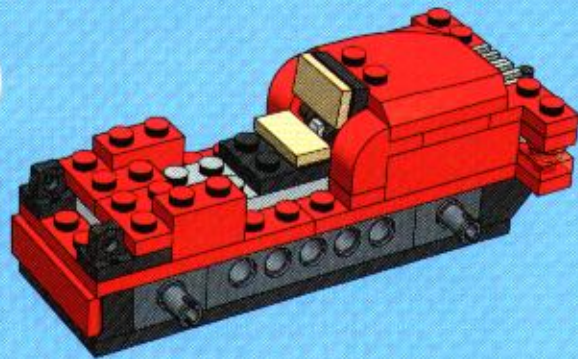



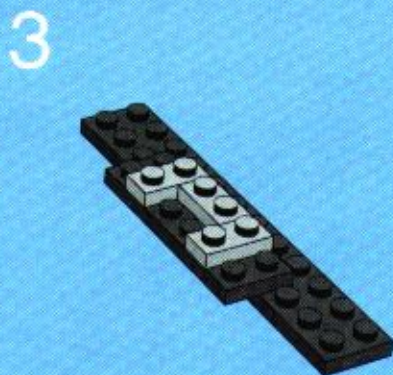
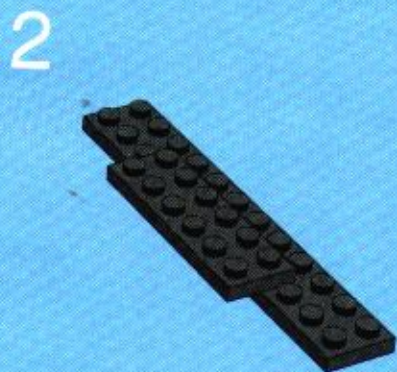
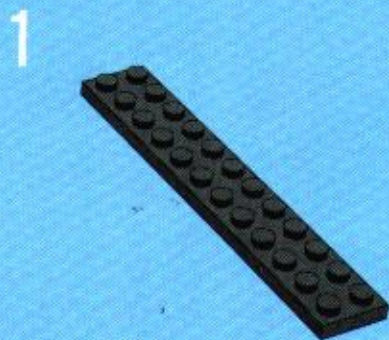
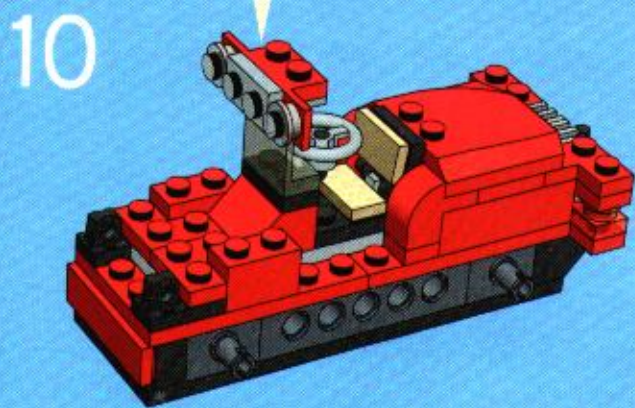
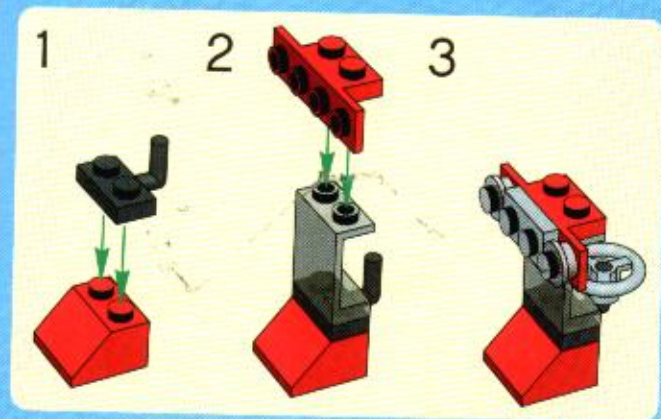



4

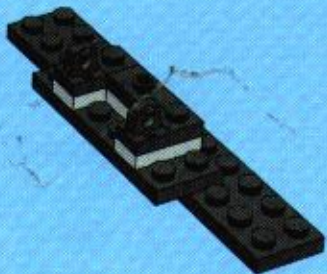

5

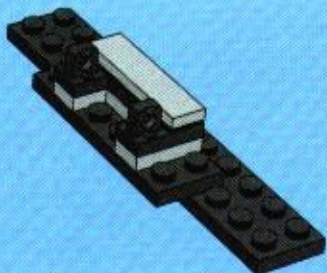

6

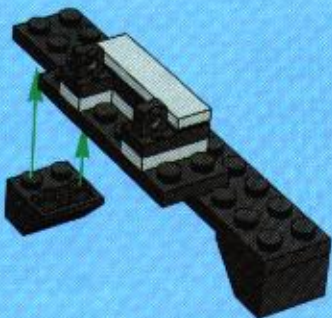

1



2

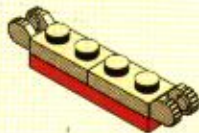

3



2x

7

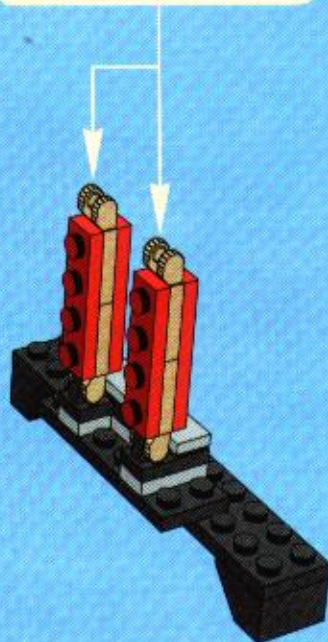



11

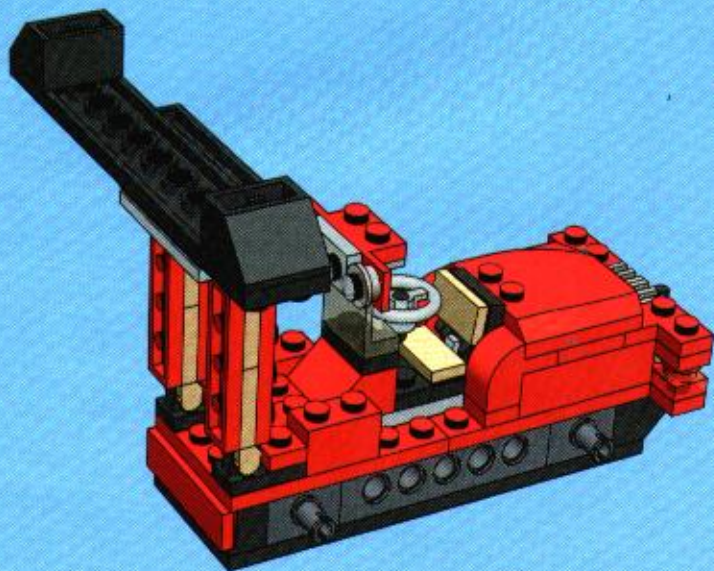



12

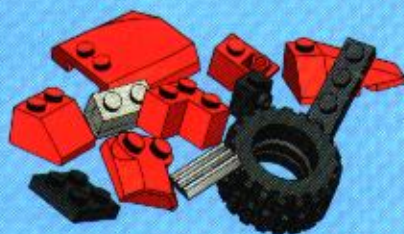

=







1

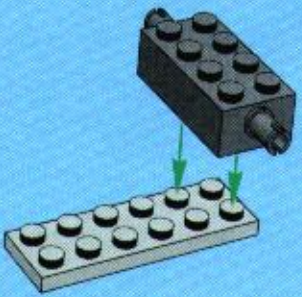

2

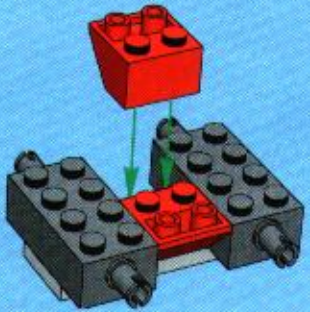

3

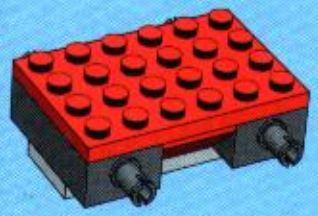

4

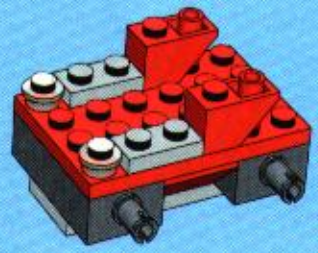

5

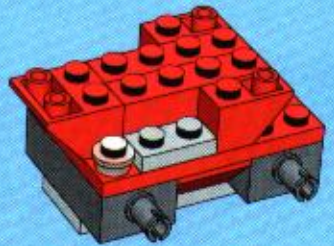



1

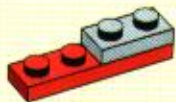

2

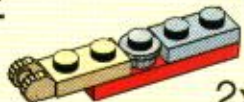

2x

6



1



2



7

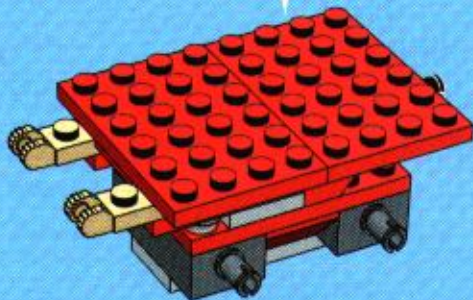

8

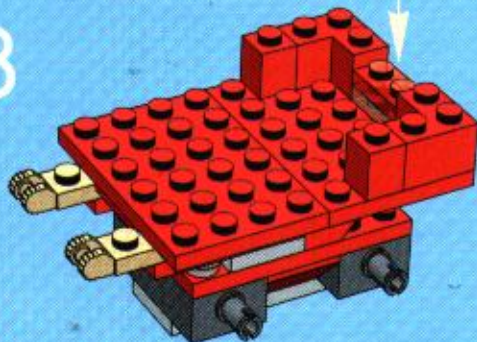

9

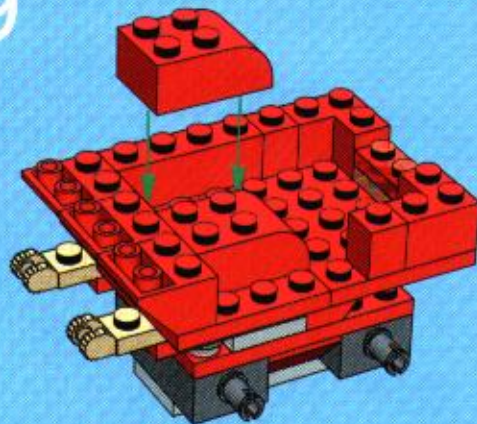



10

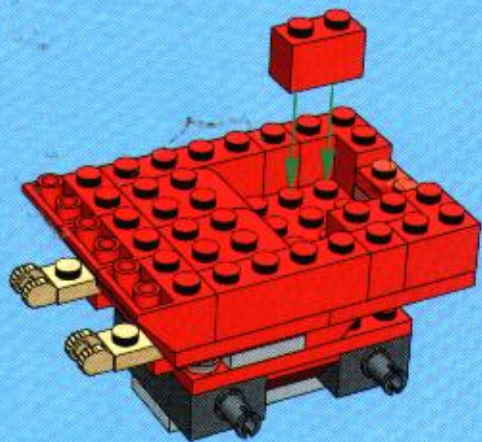

11

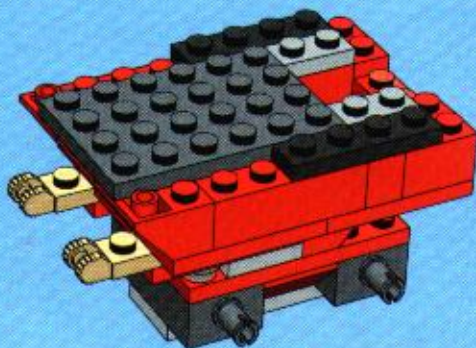

12

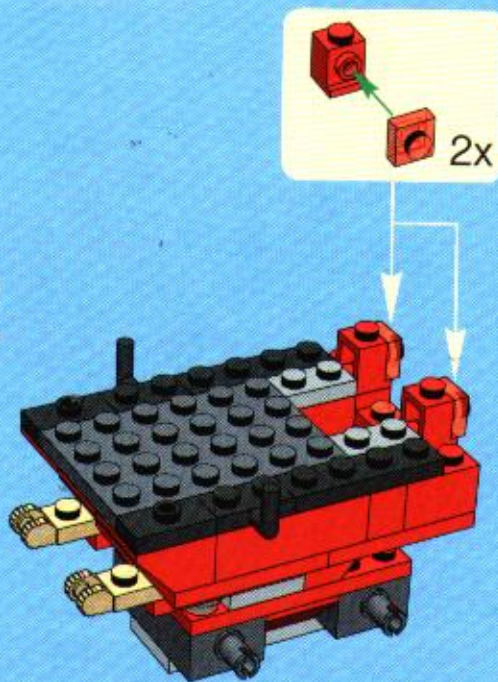



13

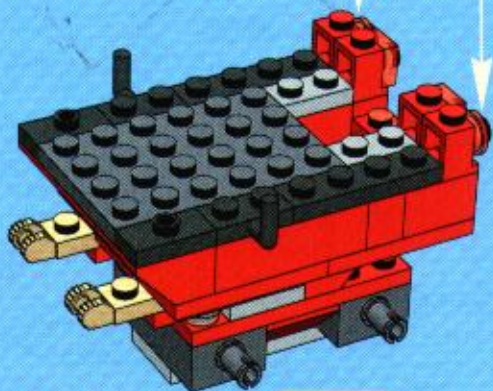

14

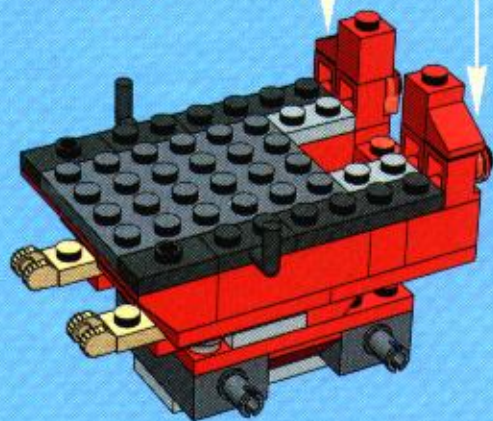

15

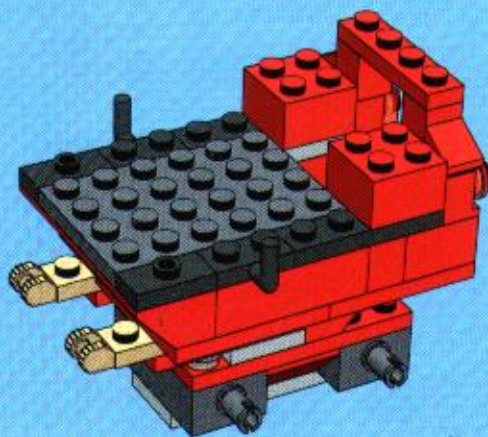

16

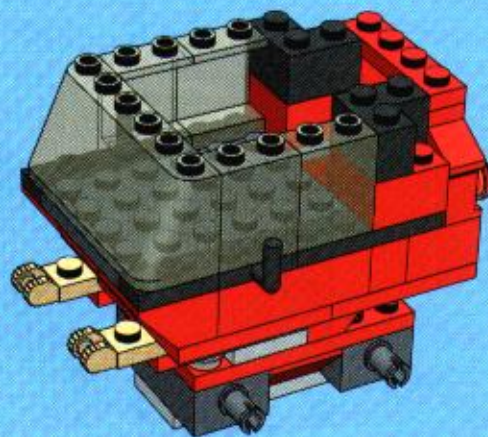



17

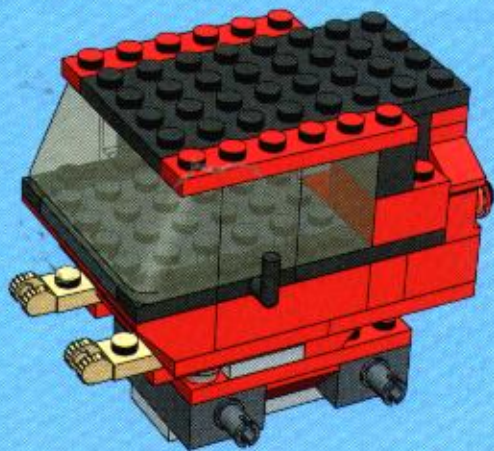

18

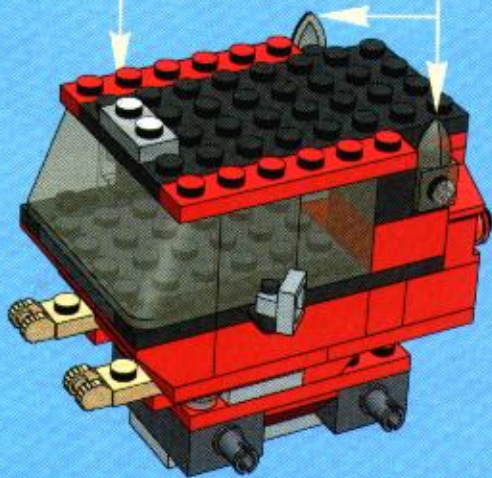

1



3

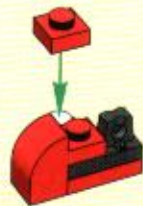

2



4



19

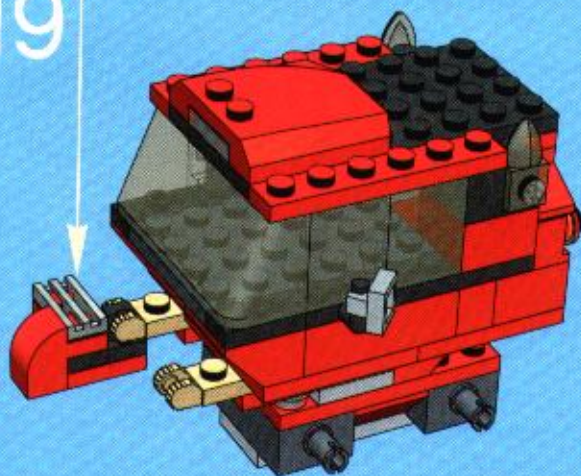



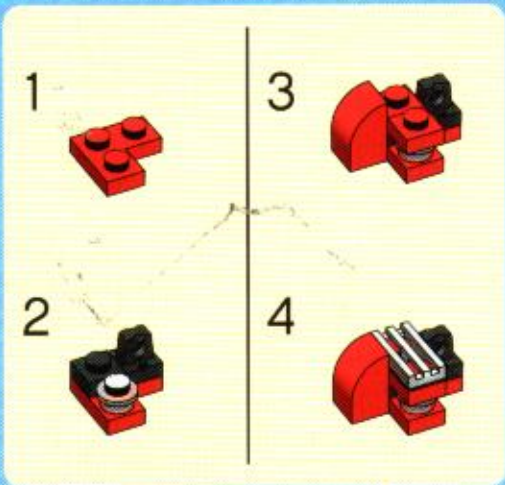

20

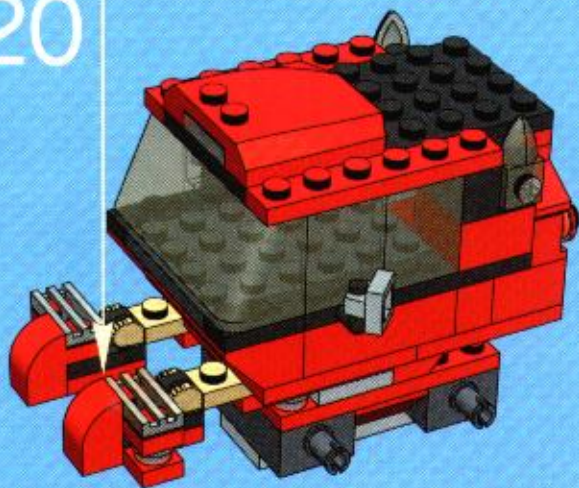

21







1

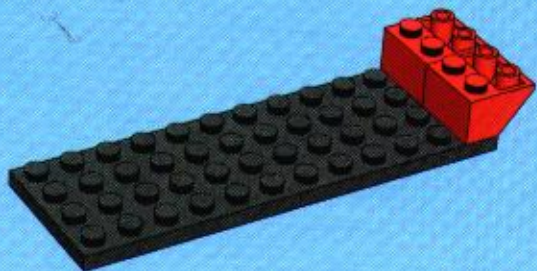

2

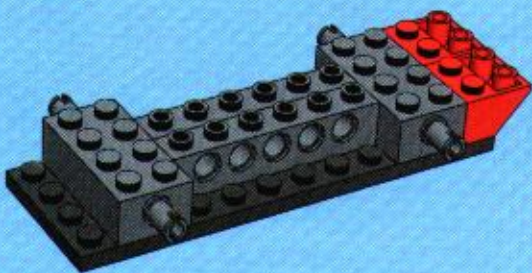

3

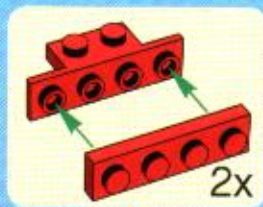

2x

4

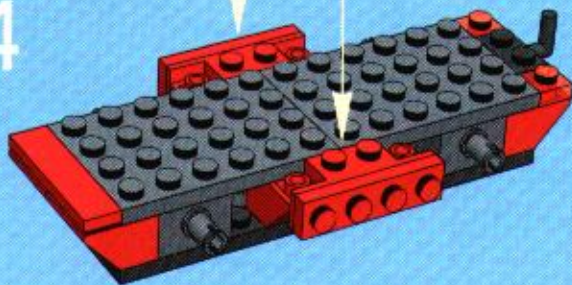



5

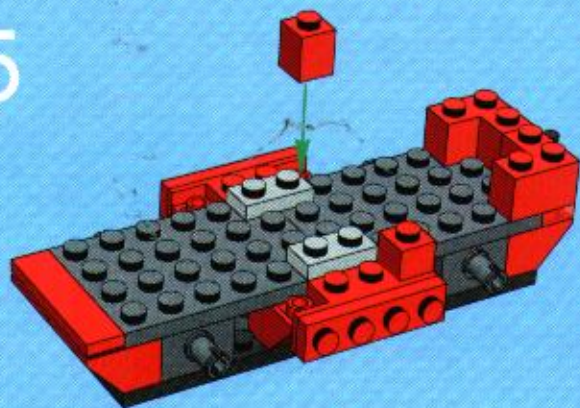

7

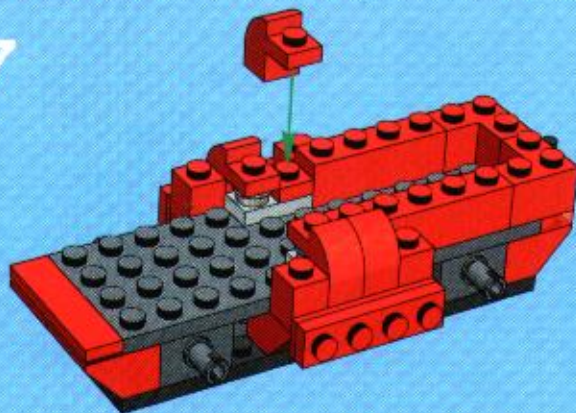

6

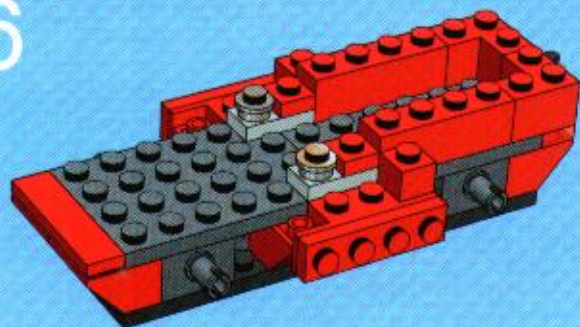

8

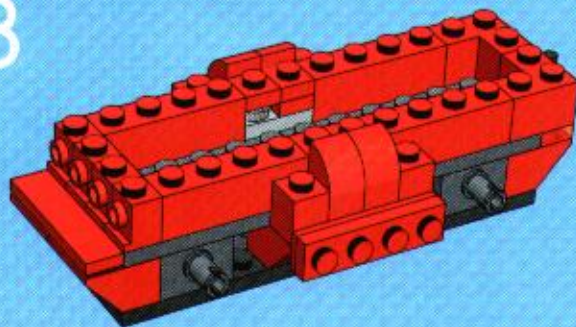



9

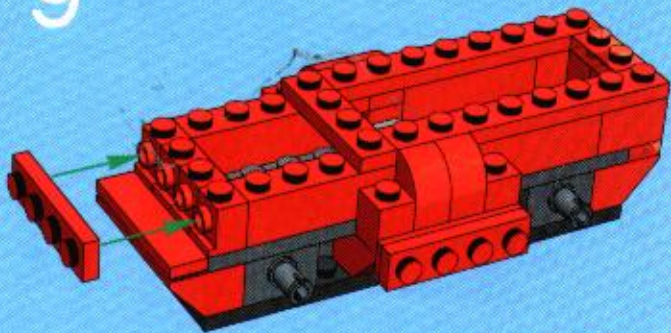

10

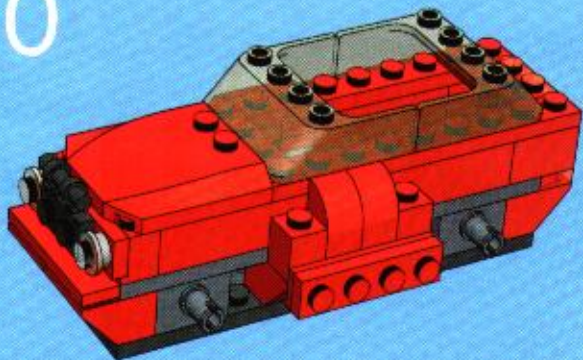

11







1



2

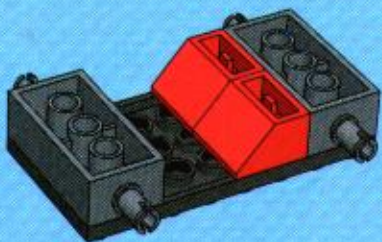

3

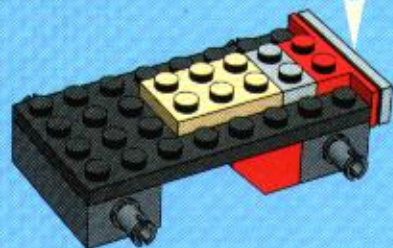

4

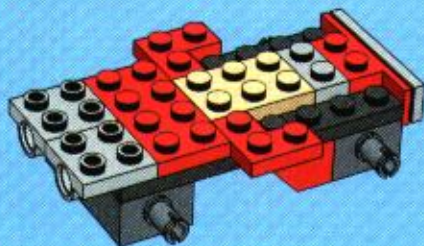



5

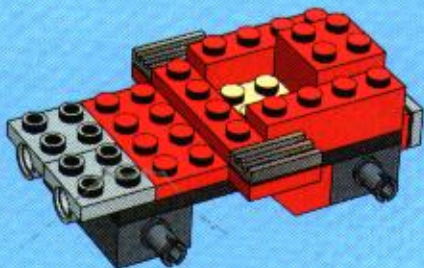

6

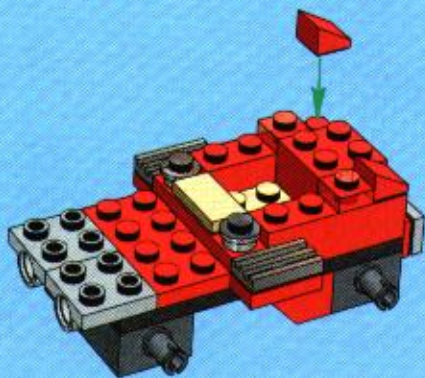

7

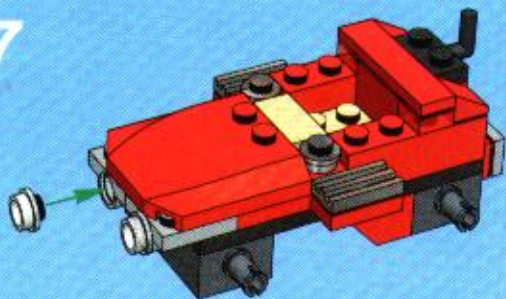

8

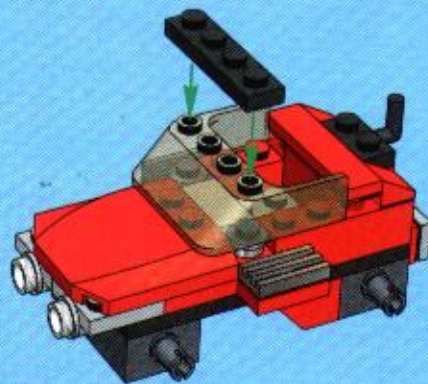

9







1



2



3

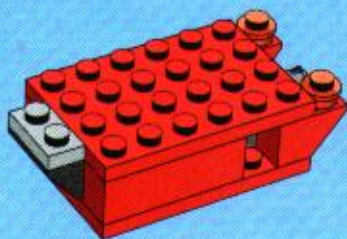

4

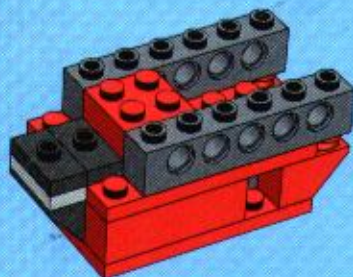

5

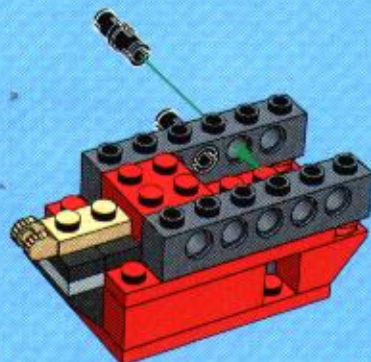

6

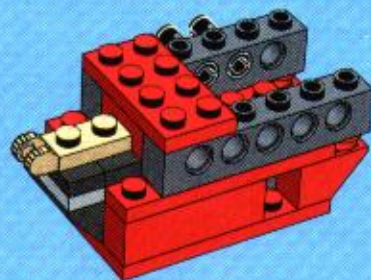



7

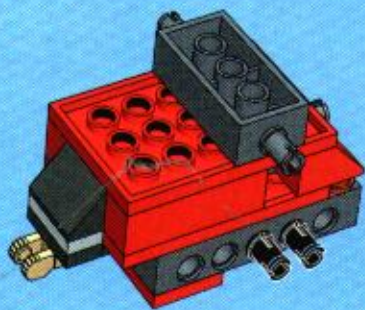

8

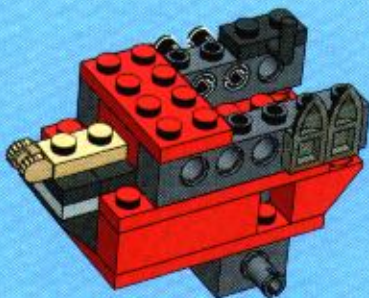

9

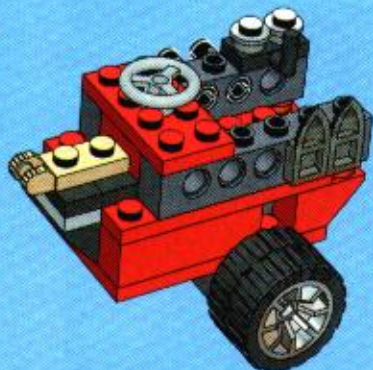

10











22



45





1

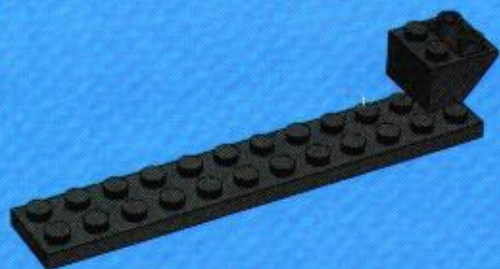

2

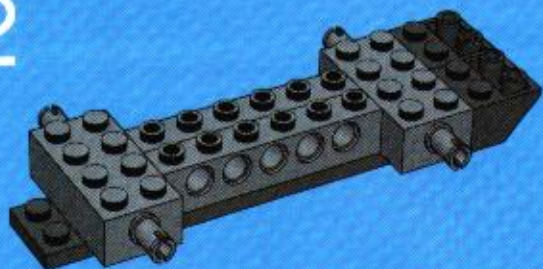

3

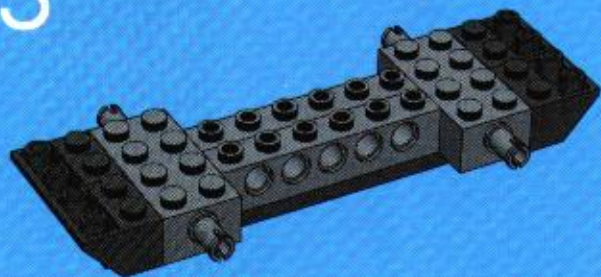

1



2



3



4





5

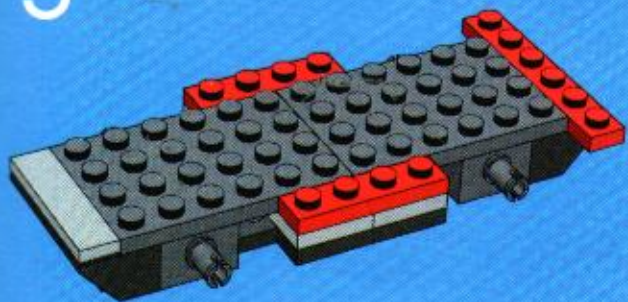

7

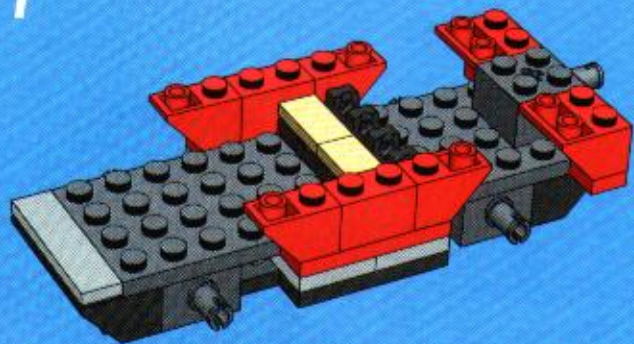

6

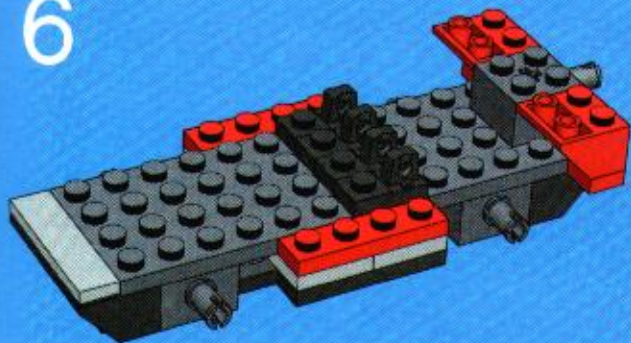

8

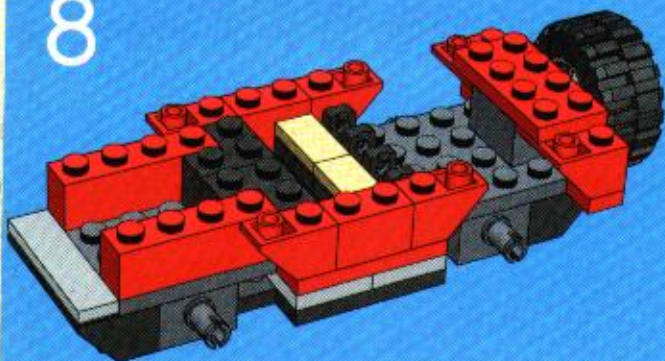



1

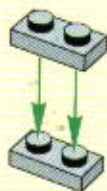

3

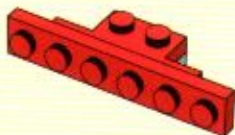

2

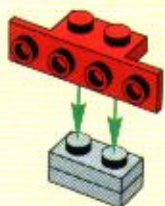

4



5



9

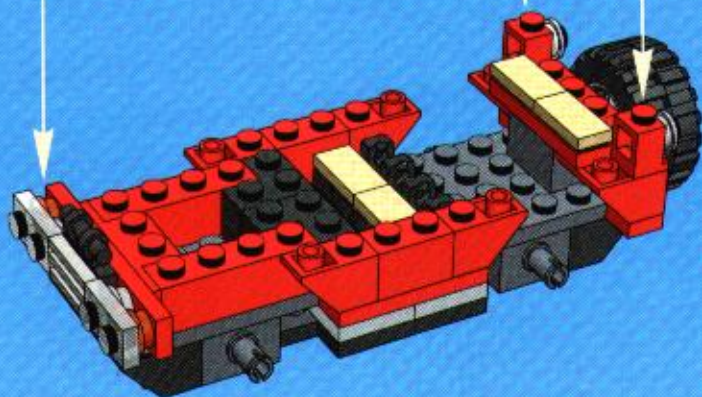



10

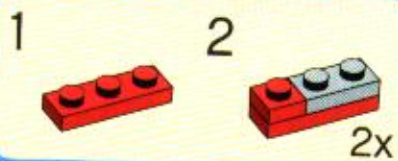
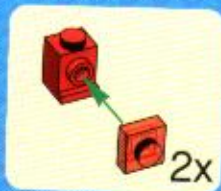

11

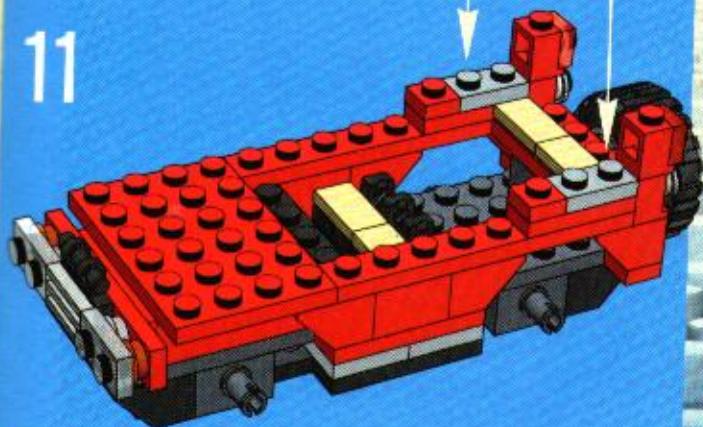

1

2

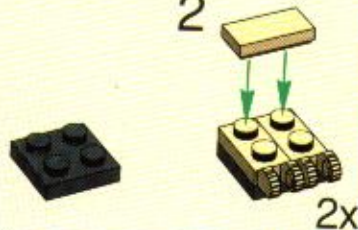

12

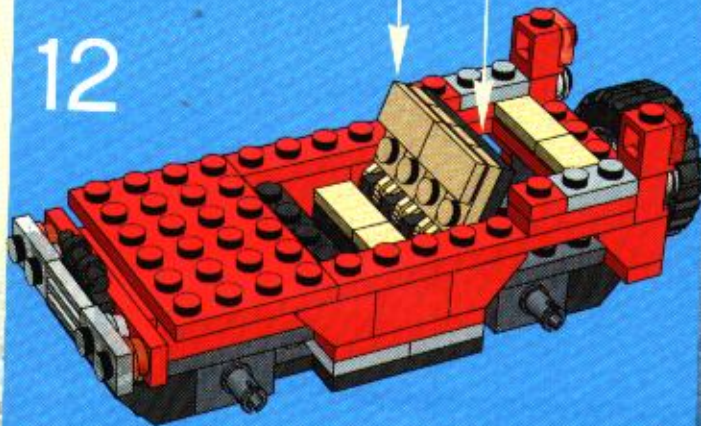



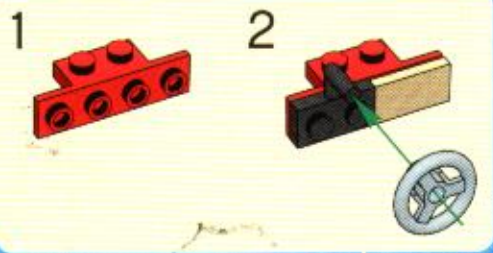

13

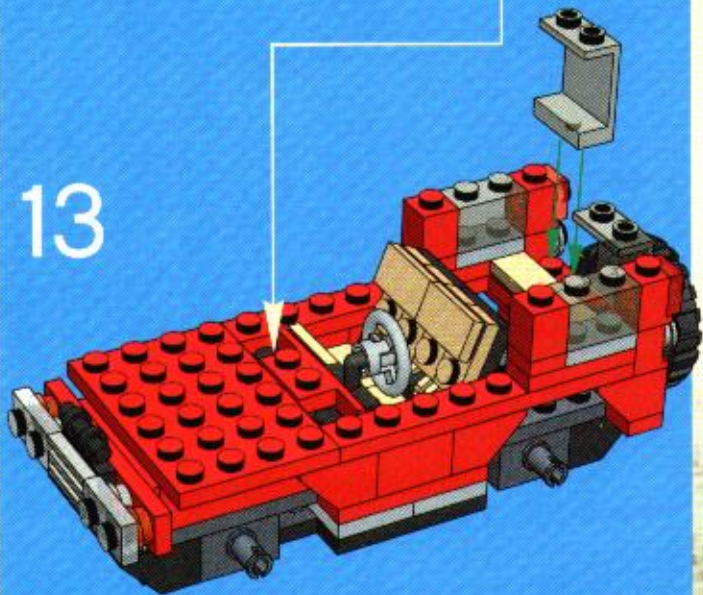

14

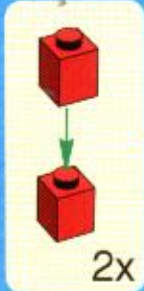
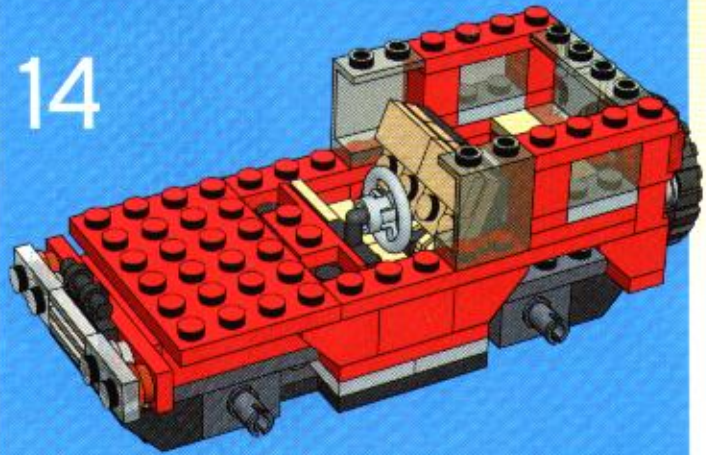

15





16



17

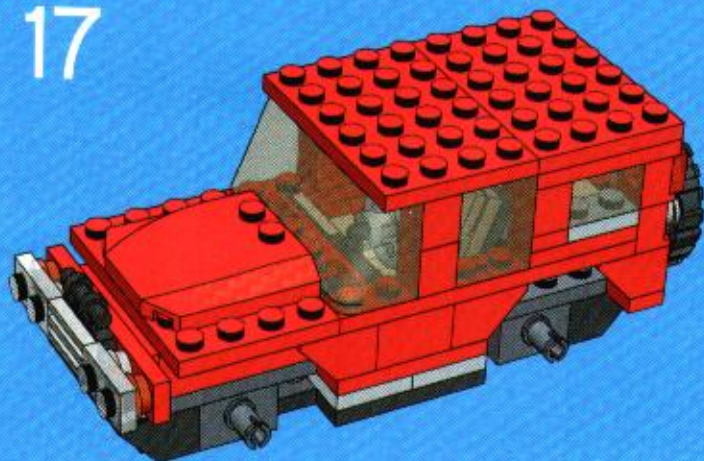



18





19

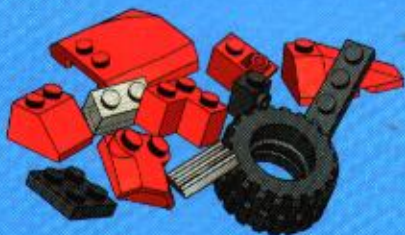

=



4



22





1

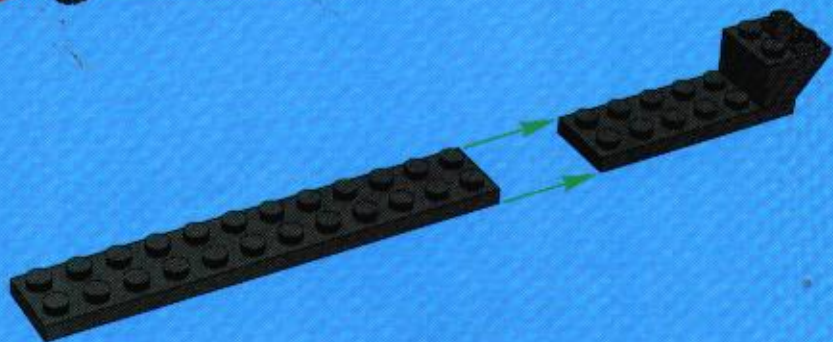

2

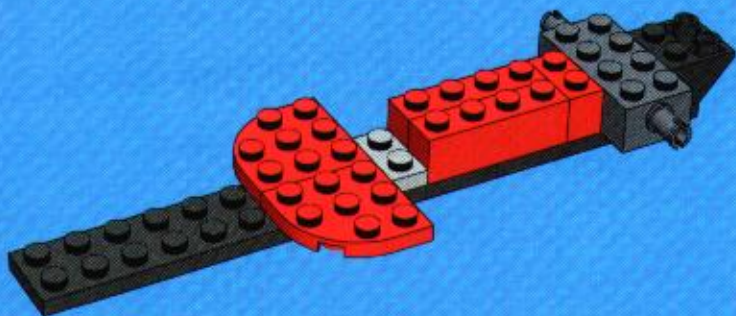



3

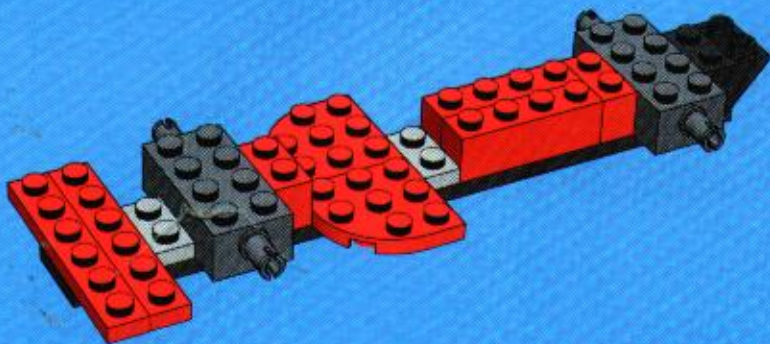

4

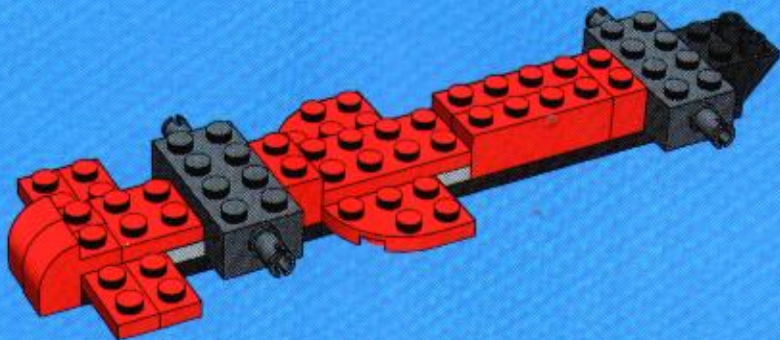

5

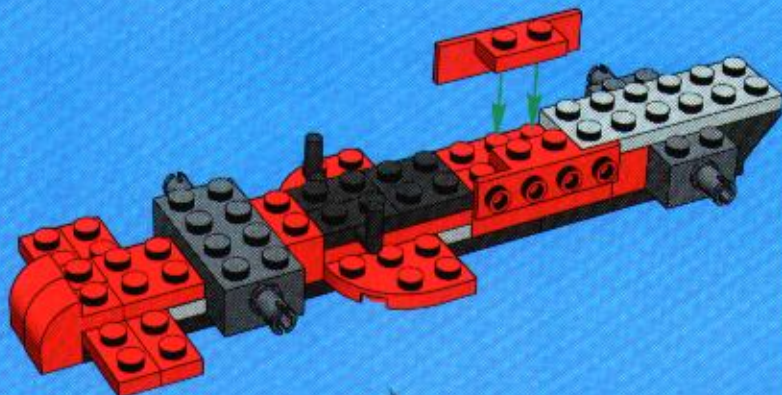



6

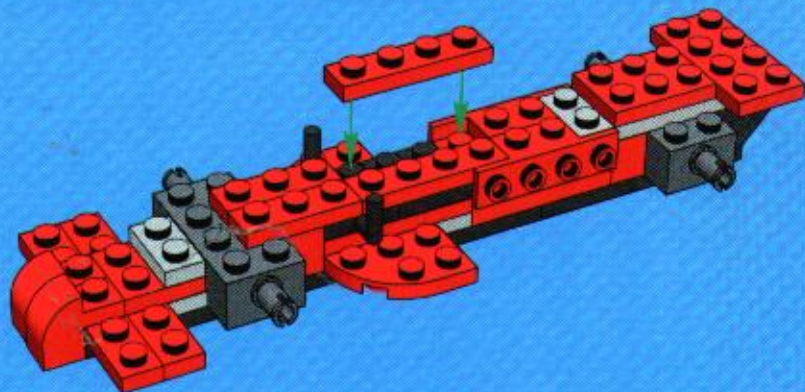

7

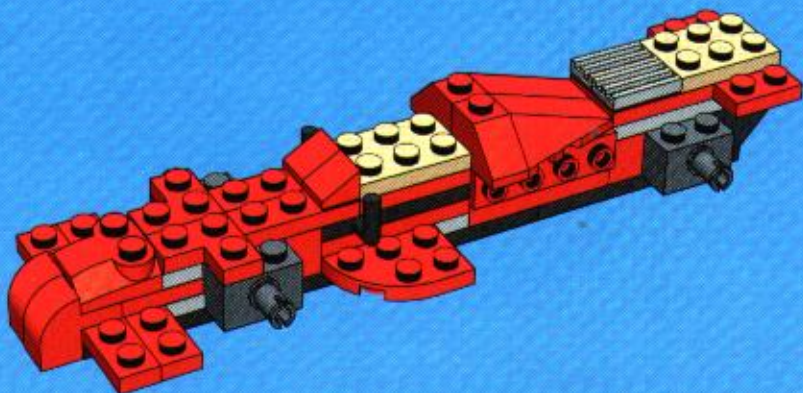

8

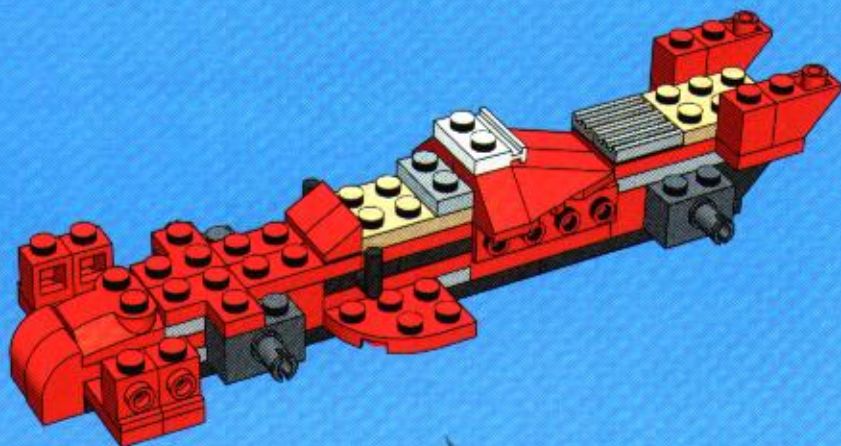









11

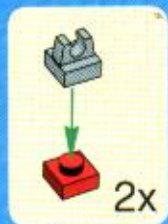
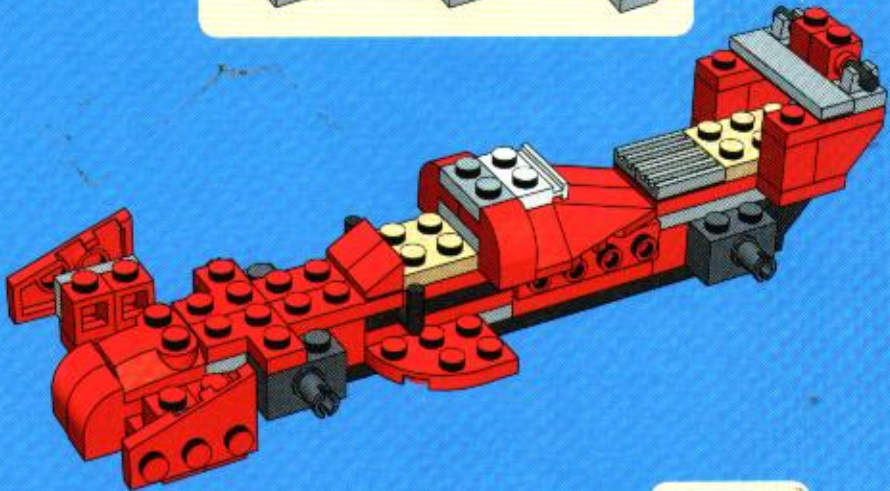

12

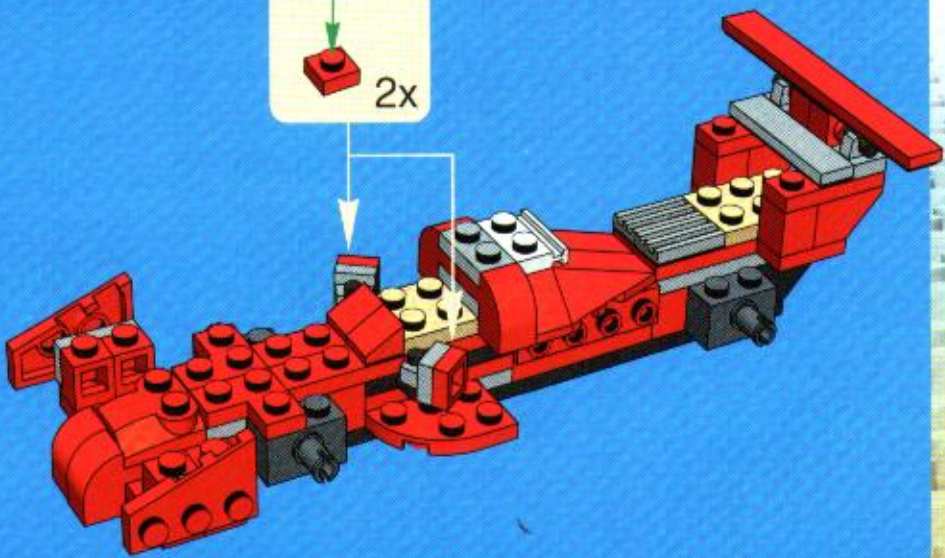



1



2



3

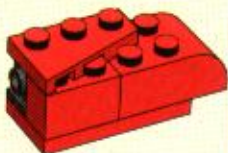

13

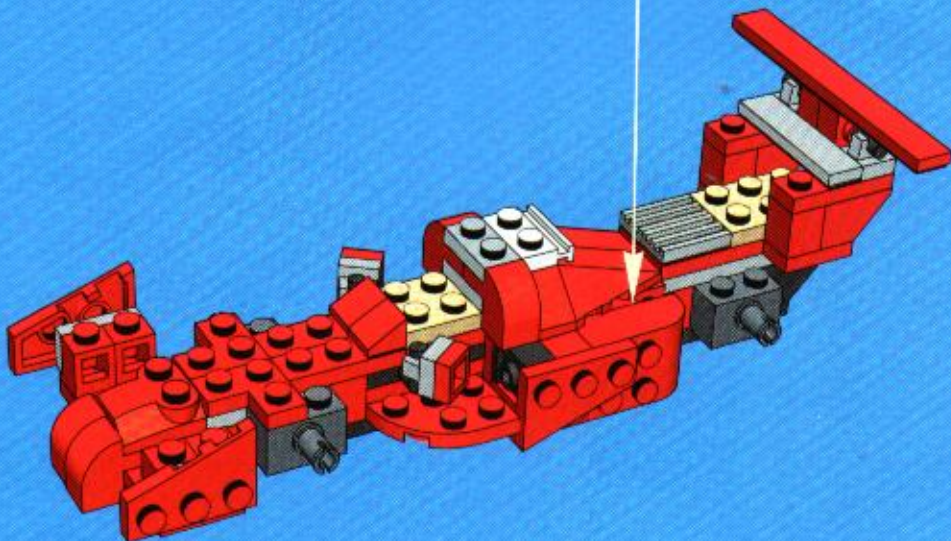



1

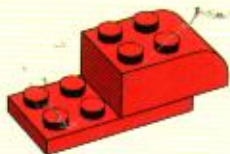

2



3



14

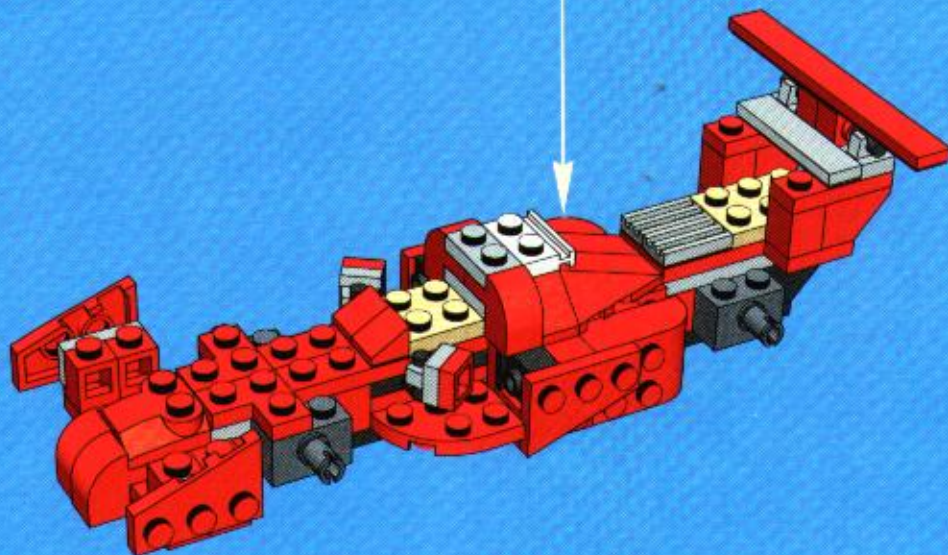



15

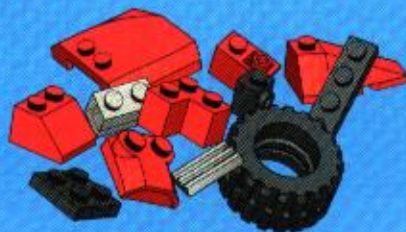
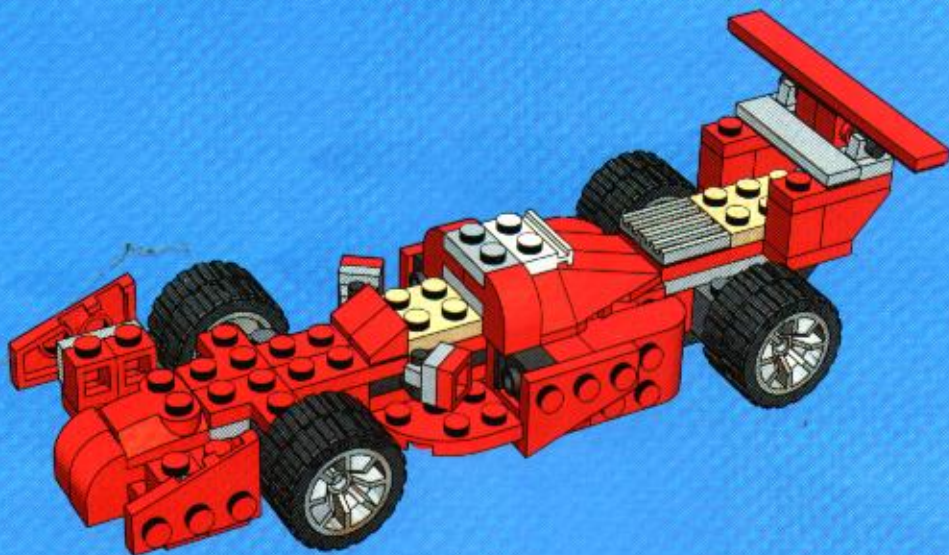

=



26





1

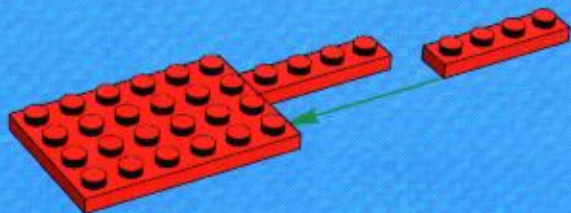

2

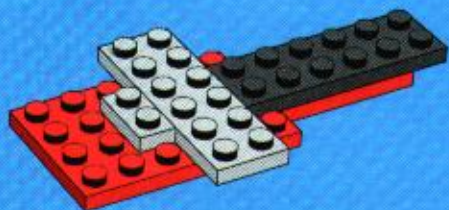

3

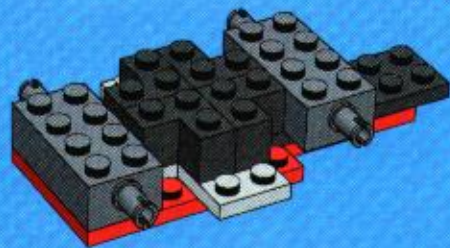



4

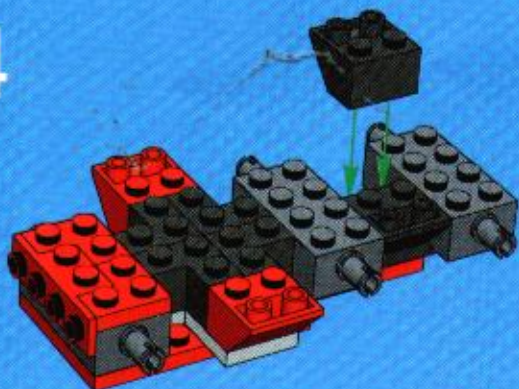

6

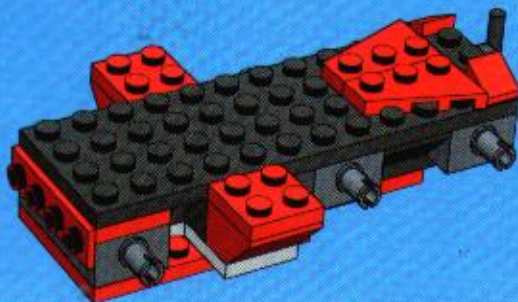

5

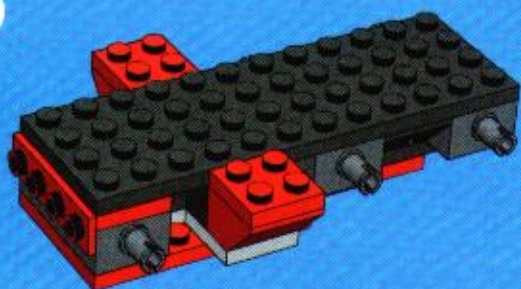

7

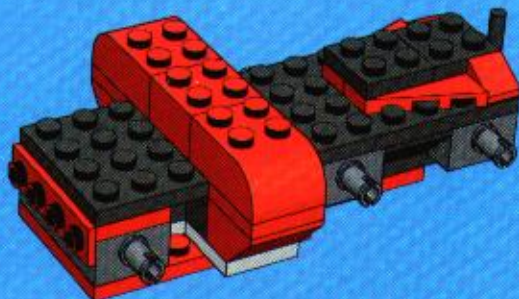



8

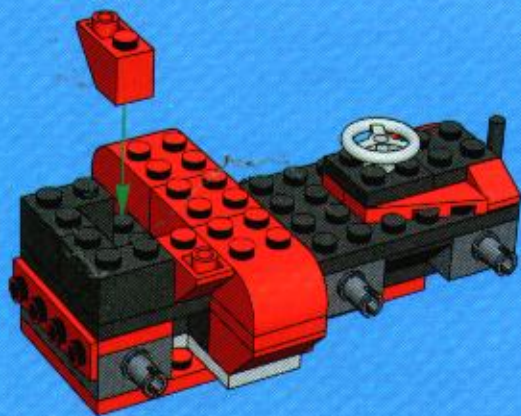

10

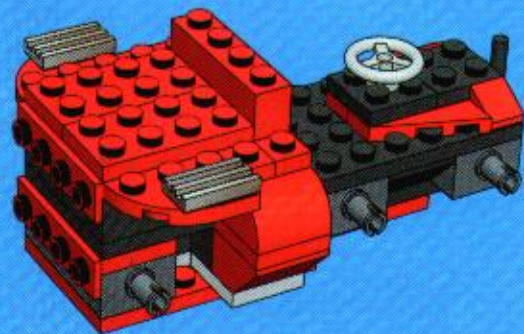

9

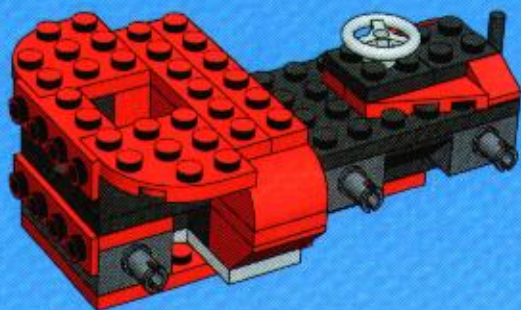

11

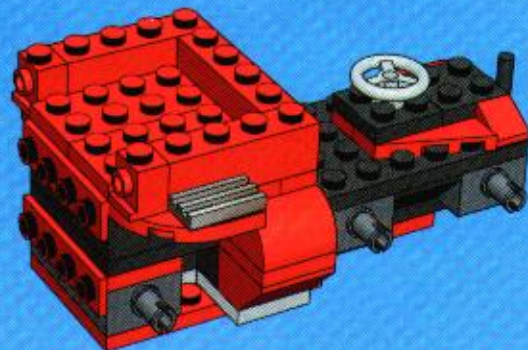



12

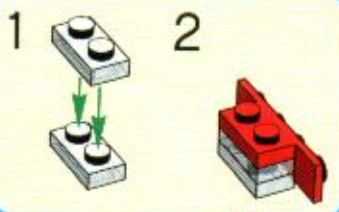
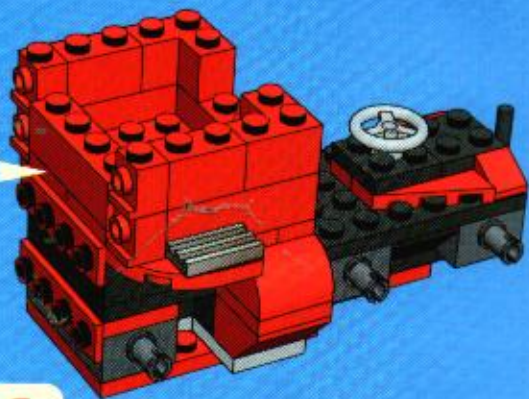

13

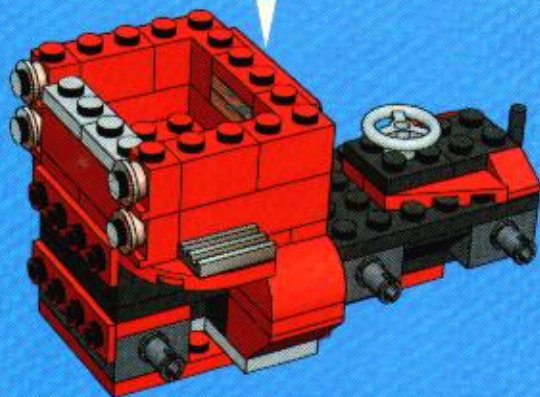

14

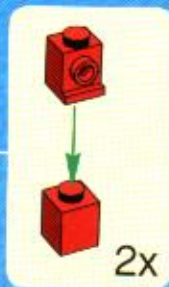
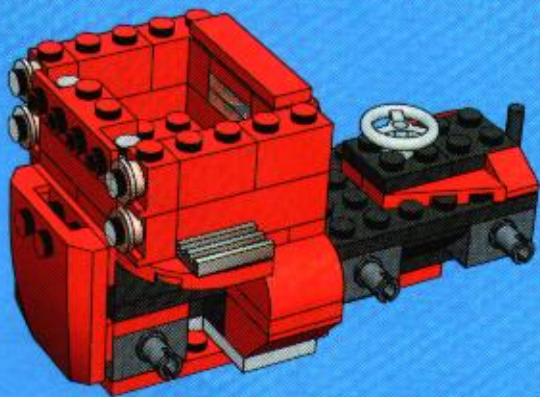

15

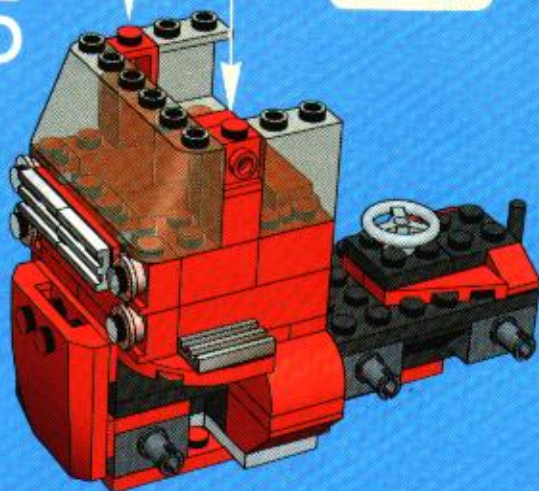



16

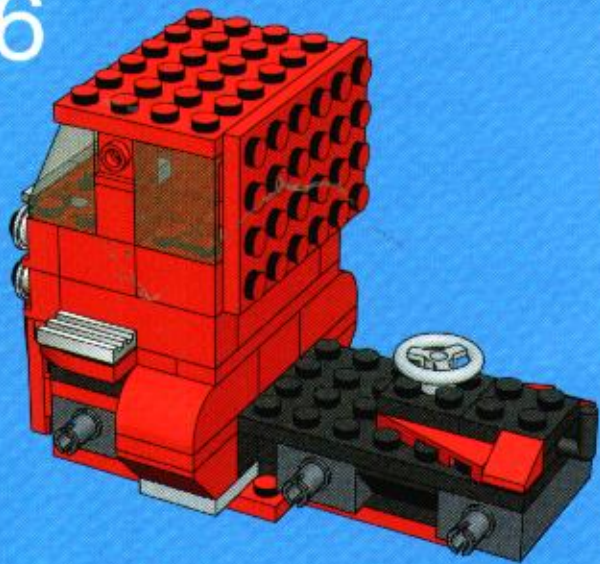

17

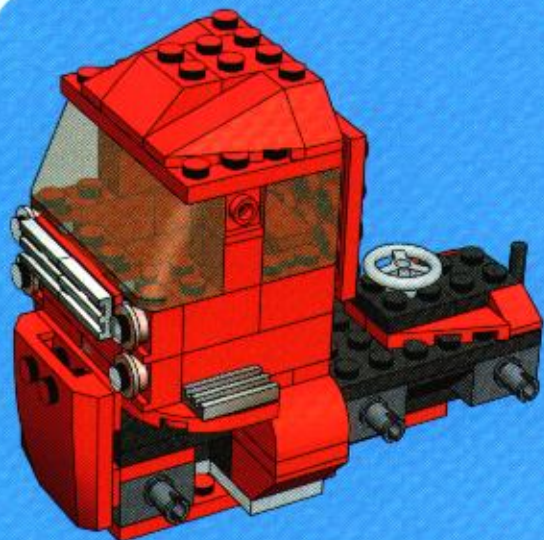

18

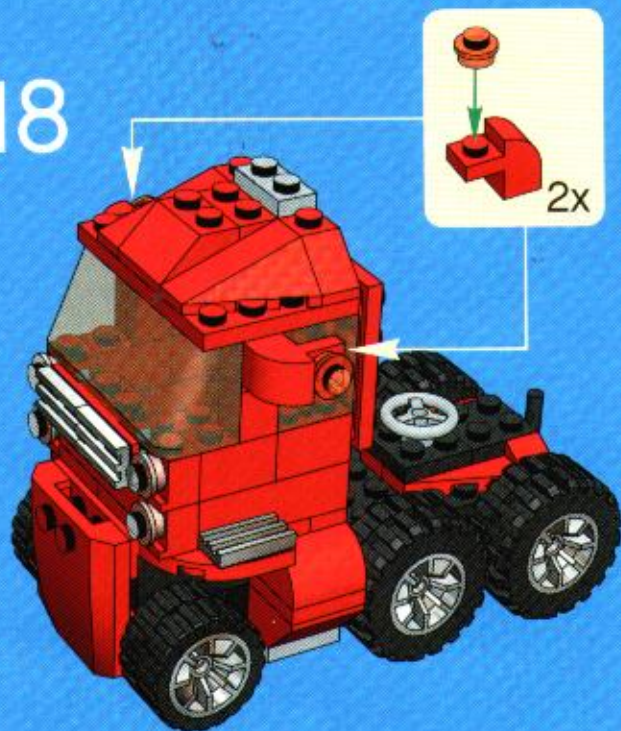





1

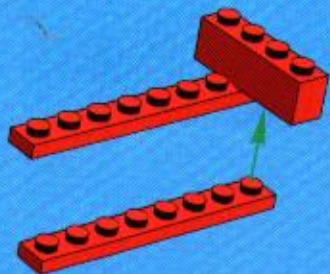

2

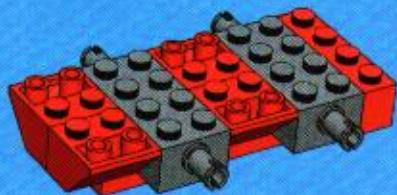

3

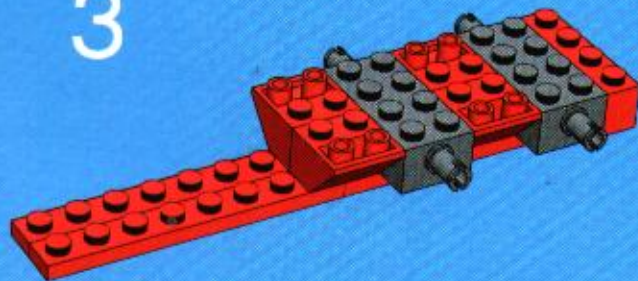

4

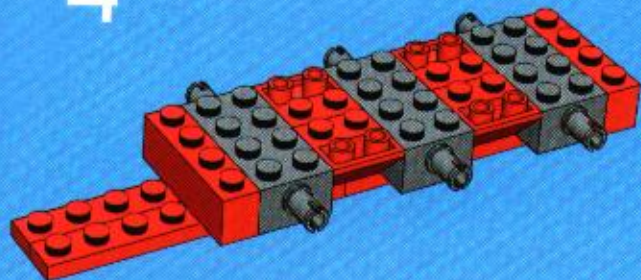



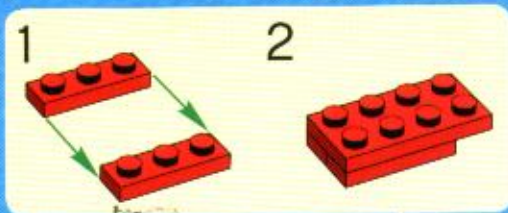

5

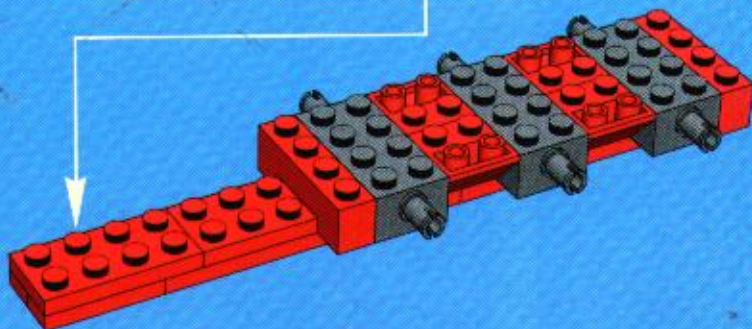

6

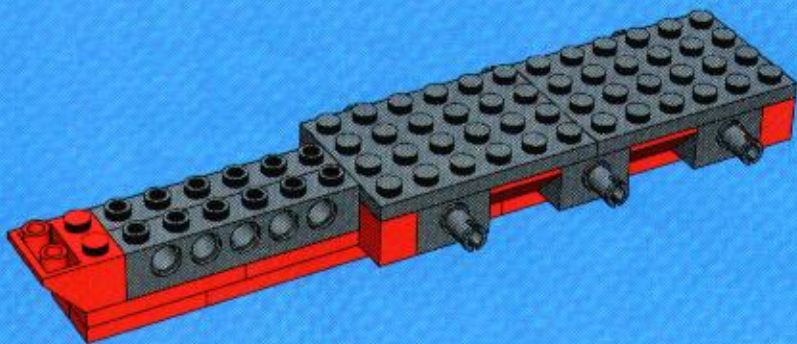



7

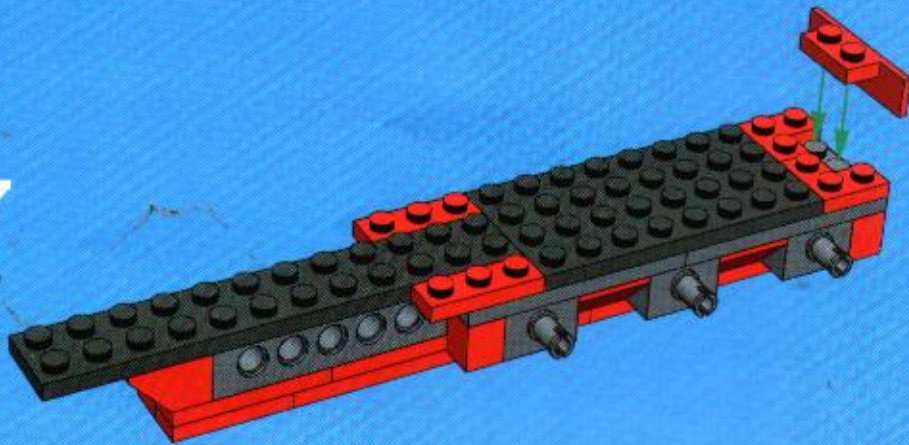

1

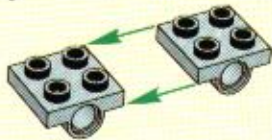

2



3



2x

8

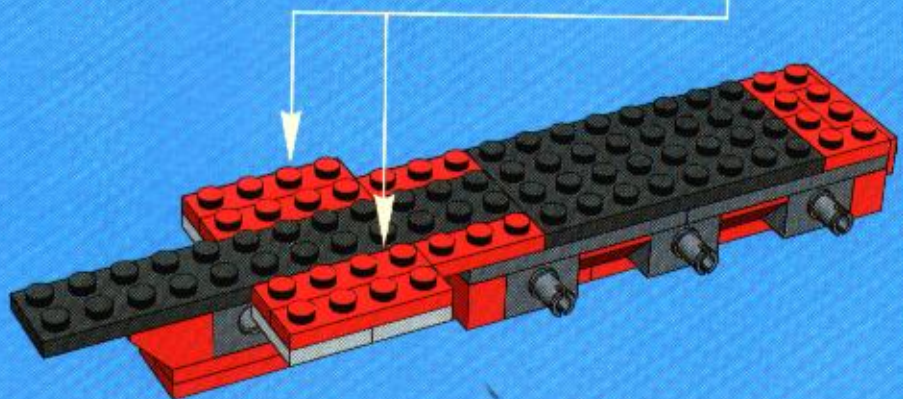



9

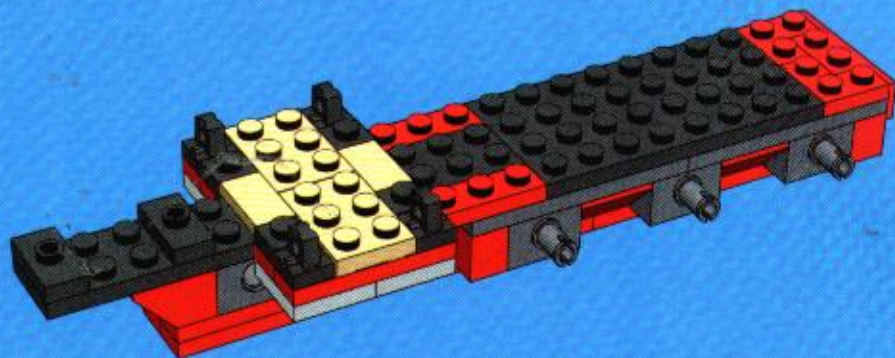

1



2



3

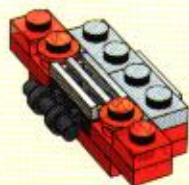

10

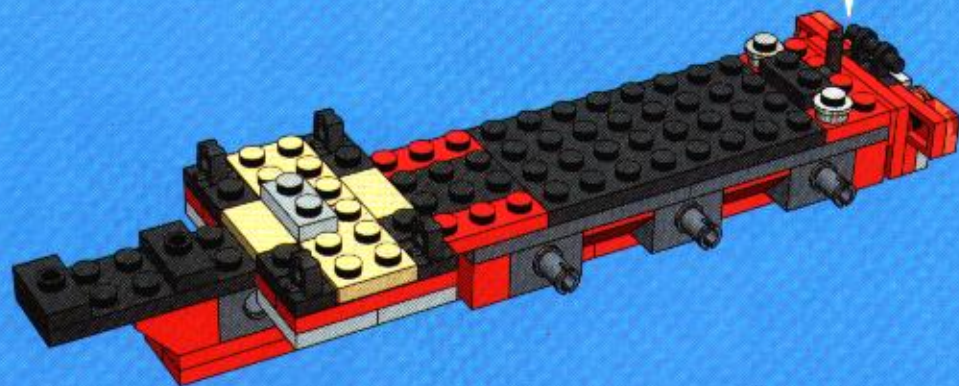



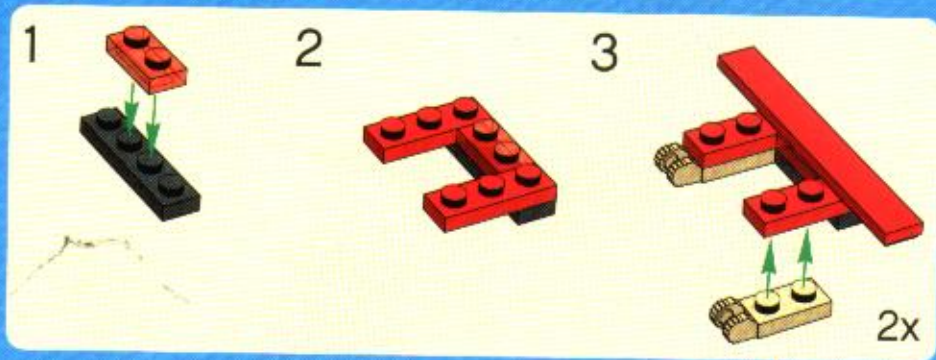

11

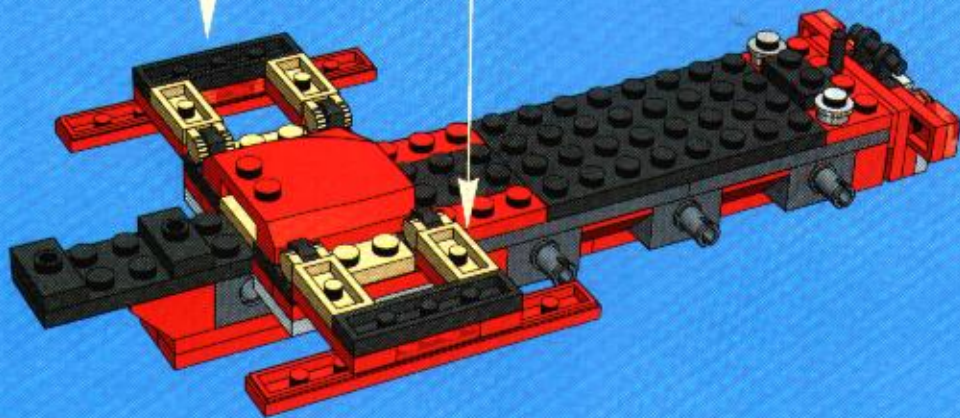



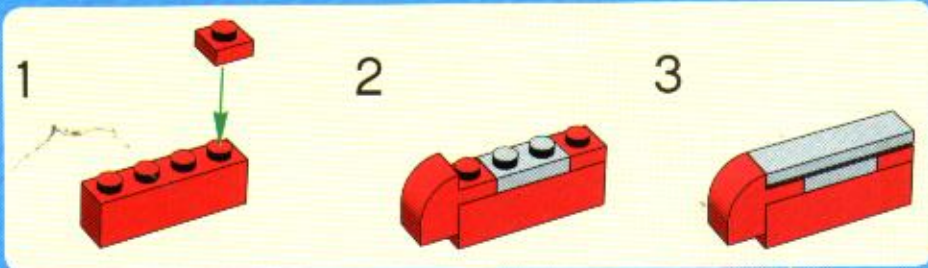

12

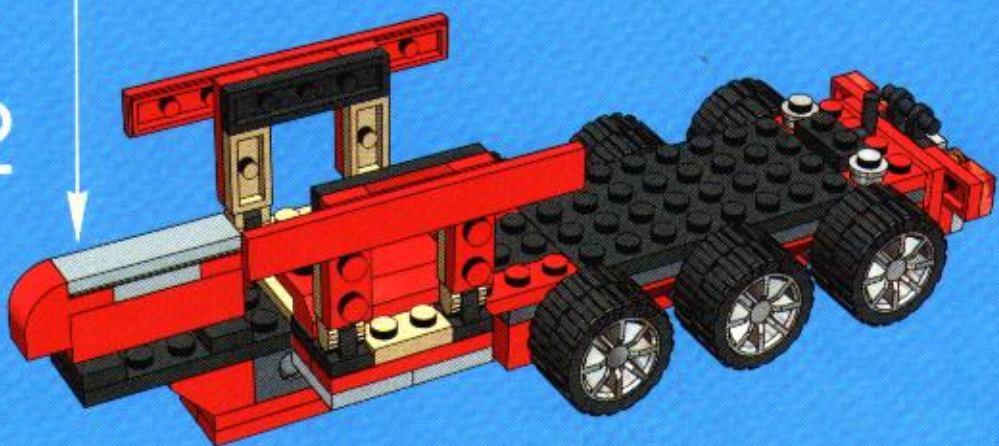



13









6

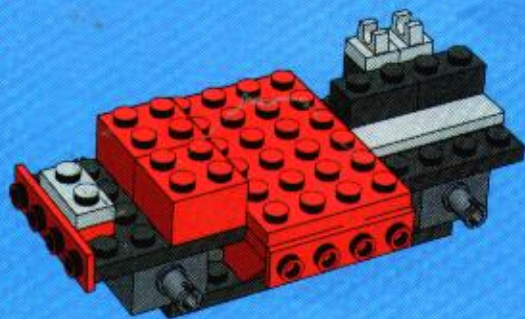

8

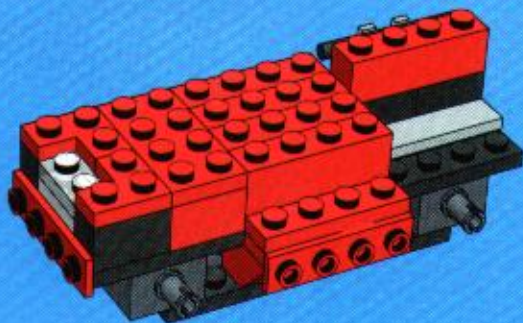

7

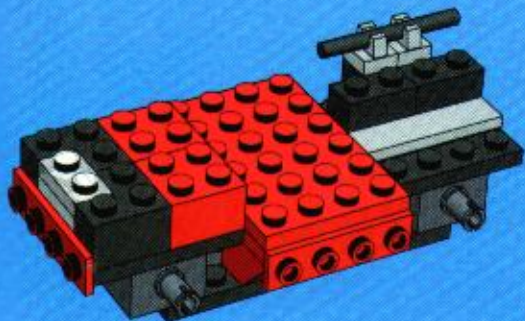

9

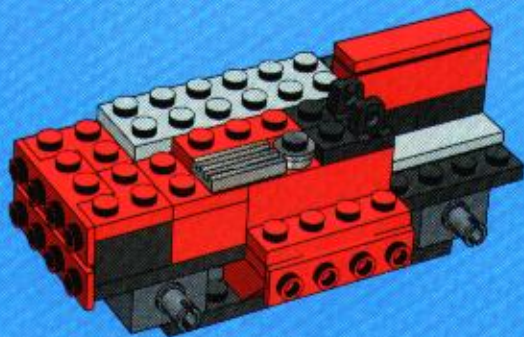



10

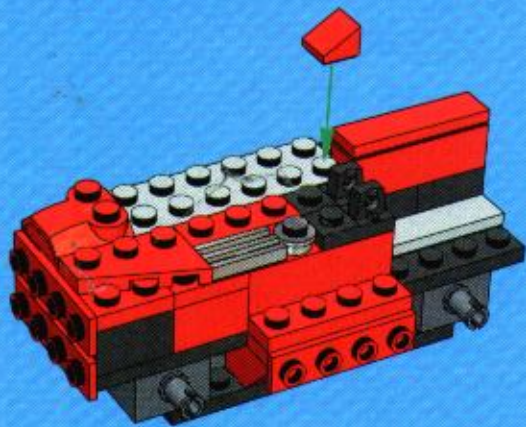

12

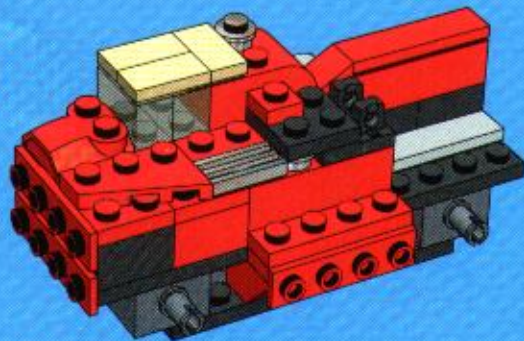

11

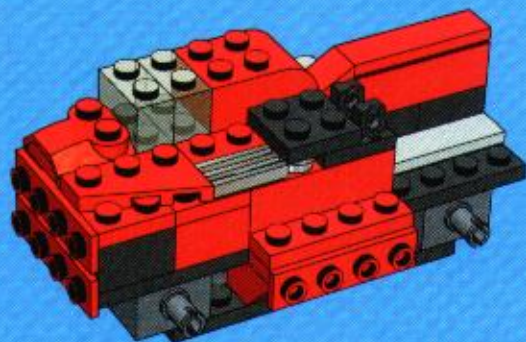

13

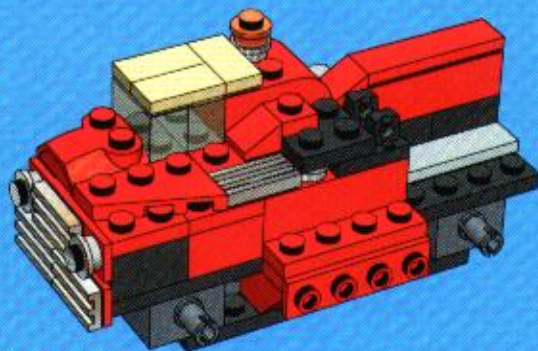



1

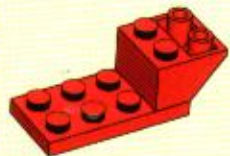

2

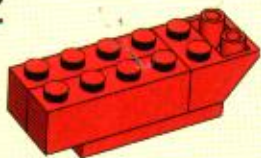

3



4



5

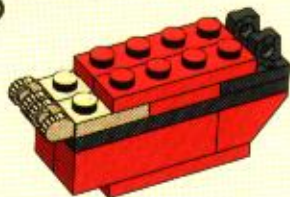

14

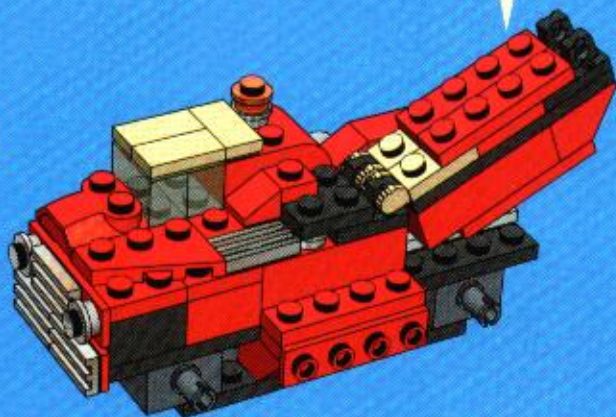



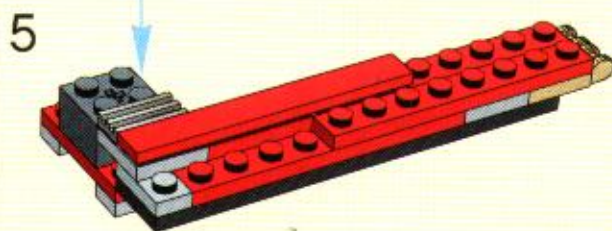
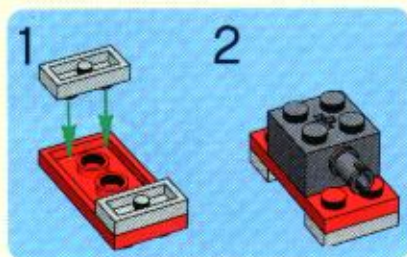
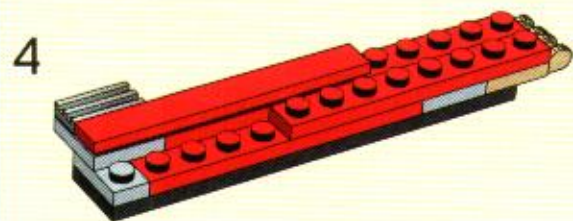
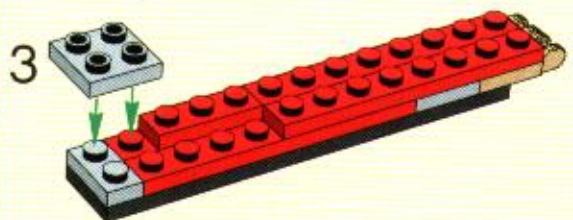
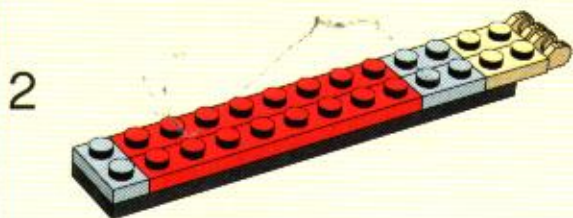





1

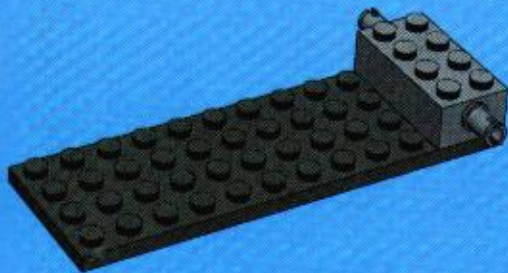

2

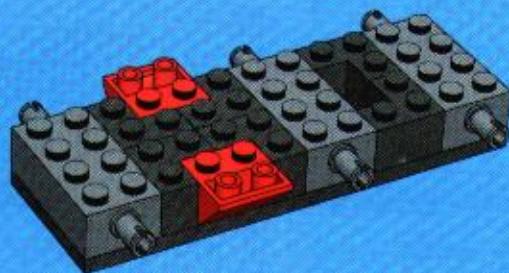

3

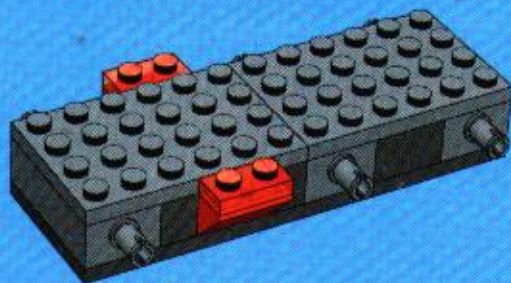

4

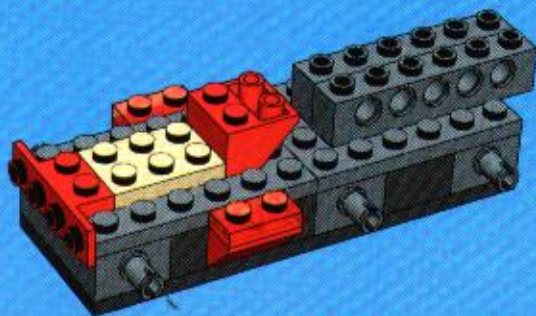



5

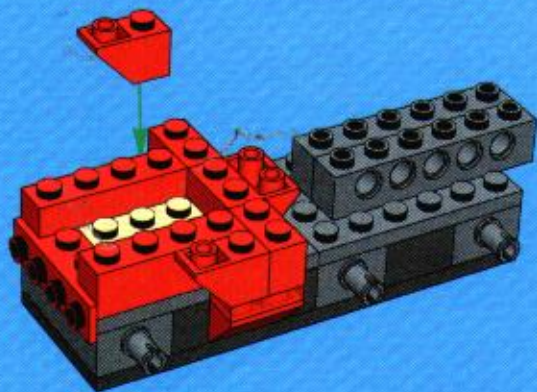

7

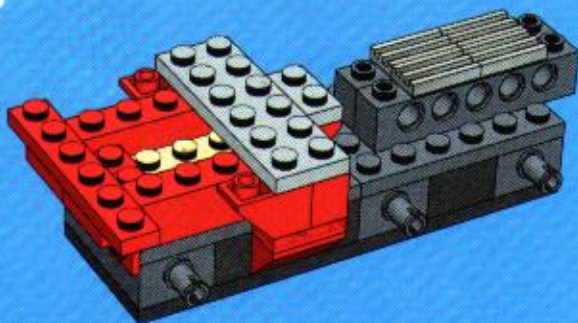

6

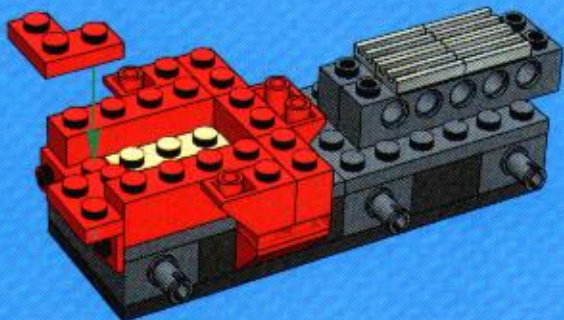

8

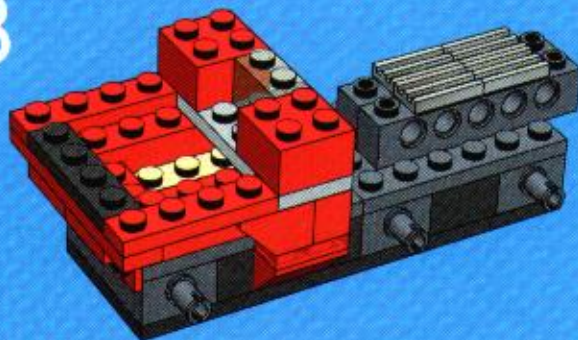







12

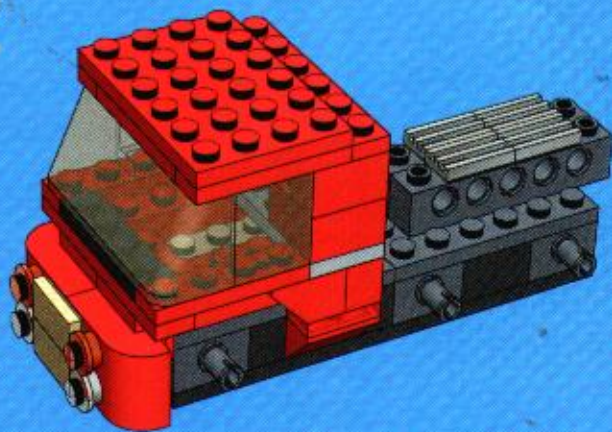

1

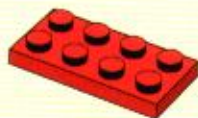

2

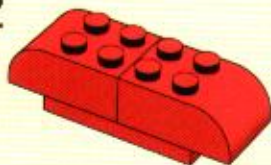

3

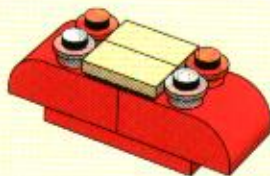



13

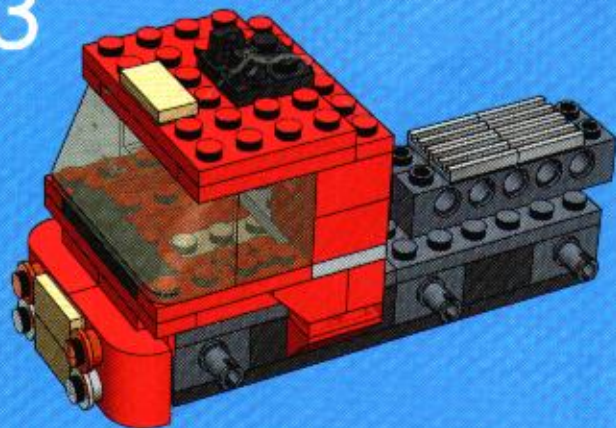

14

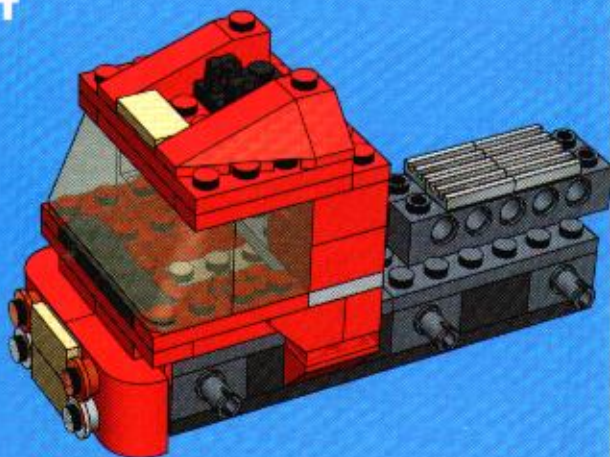

1

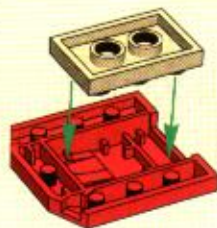

3



2



4



15







1

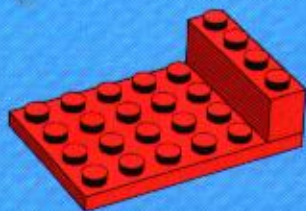

2

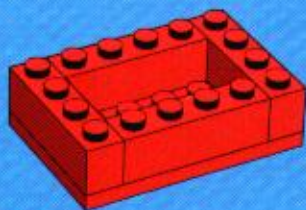

3

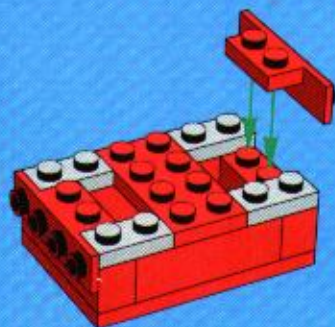

4

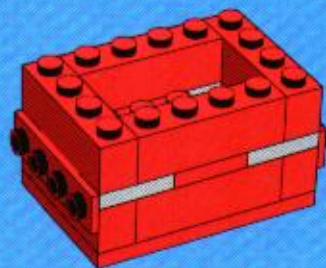

5

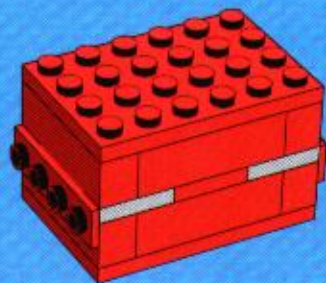



6

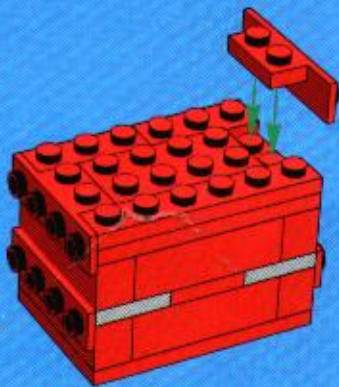

7

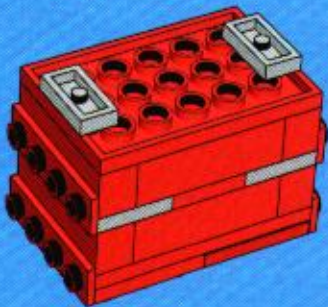

8

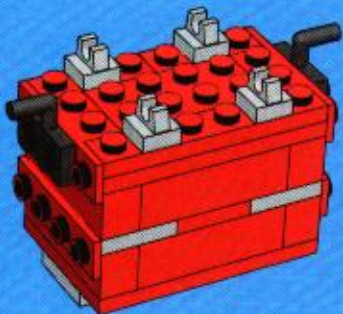

9

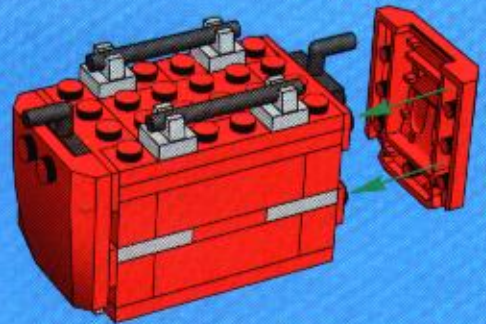

10

















# Win! Gagne! Gewinne! 当たります



## WIN LEGO® PRODUCTS

We would like to know what you think about our new LEGO® product. If you could help us by answering a few questions you are in with a chance of winning an exciting LEGO prize. It will only take you about 3 minutes! Log on to the web address below for further instructions.

We would really like to hear what you think about your new LEGO product. If you'd like to help us, go to the web address below for further instructions.



## Estimado usuario LEGO®

Al contestar algunas preguntas en inglés, francés, alemán o japonés, en el sitio [www.acnielsen.aim.dk/lego](http://www.acnielsen.aim.dk/lego), podrás participar en el sorteo de algunos valiosos premios LEGO®.



## 抽選でレゴ®製品が当たります

私たちは、皆さんが買い求めのレゴ®製品についてどんな感想をお持ちか、知りたいと思っています。質問に答えて、楽しいレゴ®製品の抽選に応募します。アンケートの回答には、ほんの1分ほどのかかります。詳しくは、以下のウェブアドレスまでアクセスしてください。



## GAGNE DES PRODUITS LEGO®

Nous aimerions savoir ce que tu penses de ton nouveau produit LEGO®. Si tu veux bien nous aider en répondant à quelques questions, tu recevras peut-être bientôt un fantastique prix LEGO. Et cela ne te prendra que 3 minutes environ ! Tu obtiendras davantage d'informations en visitant le site Internet indiqué ci-dessous.

Nous aimerions savoir ce que tu penses de ton nouveau produit LEGO. Si tu souhaites nous aider, rends-toi à l'adresse Internet ci-dessous où tu trouveras des instructions supplémentaires.



## Caro Consumidor da LEGO®

Ao responder a algumas perguntas em Inglês, Francês, Alemão ou Japonês no endereço [www.acnielsen.aim.dk/lego](http://www.acnielsen.aim.dk/lego) irá participar num concurso para ganhar valiosos prémios da LEGO®.



## GEWINNE LEGO® PRODUKTE

Wir sind sehr an deiner Meinung über dein neues LEGO® Produkt interessiert. Wenn du uns den Gefallen tust und ein paar Fragen beantwortest, kannst du einen tollen LEGO Preis gewinnen. Das Ganze dauert nur etwa 3 Minuten! Gehe einfach zu der unten angegebenen Webadresse - dort findest du weitere Informationen.

Wir möchten gerne wissen, was Sie von Ihrem neuen LEGO Produkt halten. Wenn Sie uns helfen möchten, besuchen Sie bitte die u.a. Website, auf der Sie alles Weitere erfahren.



## Kedves Ifjú LEGO® Vásárló

Ha ellátogatsz a [www.acnielsen.aim.dk/lego](http://www.acnielsen.aim.dk/lego) honlapra és ott angol, francia, német vagy japán nyelven megválaszolsz néhány kérdést, akkor részt veszel egy versenyben, amelyben értékes LEGO® díjakat nyerhetsz.

# [www.acnielsen.aim.dk/LEGO](http://www.acnielsen.aim.dk/LEGO)



Ferrari, all associated logos and the distinctive design are trademarks of Ferrari S.p.A. The body of the Ferrari car is protected as Ferrari property under design and/or design registrations.





2x  
50746.21



7x  
3004.21



6x  
4070.21



6x  
5005.01



6x  
3420.21



2x  
5002.21



4x  
6099.21



8x  
3666.21



8x  
3593.21



2x  
3004.21



2x  
4053.21



2x  
2367.21



2x  
3003.21



1x  
3078.21



2x  
43743.21



2x  
43722.21



1x  
3021.21



2x  
6275.21



2x  
31037.21



6x  
3436.21



4x  
45677.21



1x  
43710.21



1x  
43711.21



10x  
3470.21



8x  
3503.21



6x  
3710.21



1x  
2431.21



4x  
3030.21



2x  
3880.21



4x  
3460.21



2x  
462.21



3x  
3032.21



7x  
3049.01



4x  
44300.5



2x  
3004.2



3x  
950.1



4x  
3550.04



8x  
3003.04



2x  
30663.04



4x  
3020.04



4x  
2444.04



1x  
2431.04



1x  
3795.04





1x  
6230.199



6x  
6248.199



2x  
3054.199



2x  
6232.199



2x  
30251.40



2x  
30251.40



2x  
30251.40



2x  
30251.201



6x  
30251.201



2x  
30251.201



6x  
30251.40



2x  
6226.40



4x  
30251.40



2x  
42573.01



2x  
3549.01



2x  
6227.01



1x  
47504.01



4x  
6258.01



2x  
6238.01



1x  
4178.01



2x  
4270.30



4x  
2780.30



2x  
4623.20



4x  
30385.20



2x  
3794.20



1x  
1540.20



2x  
3022.20



4x  
1695.30



6x  
2357.20



2x  
30374.20



5x  
30391.20



6x  
30641.20



2x  
9710.20



1x  
3795.20



1x  
9095.20



1x  
3029.20



1x  
2445.20



1x  
32028.1



1x  
45677.1



# LEGO

## Designer Set



4882



4886



4881



©2005 The LEGO Group.



[www.LEGO.com/create](http://www.LEGO.com/create)