



BIONICLE

NUI-RAMA

8+



8537

LEGO

TECHNIC

1



1

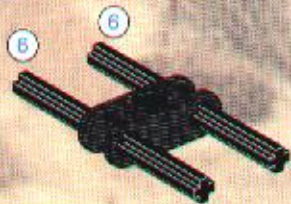

2



2

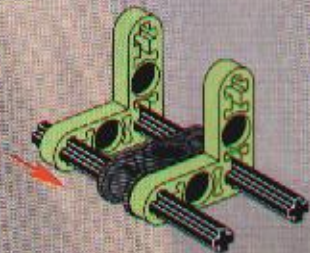

3





4

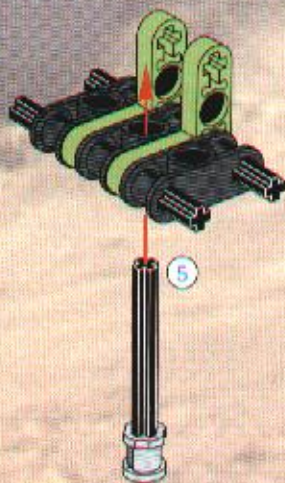

5

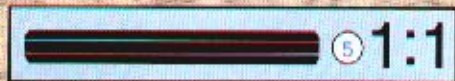
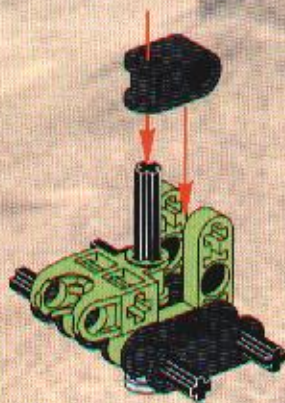



6

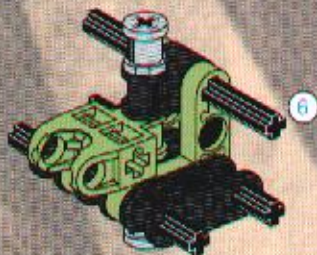

7

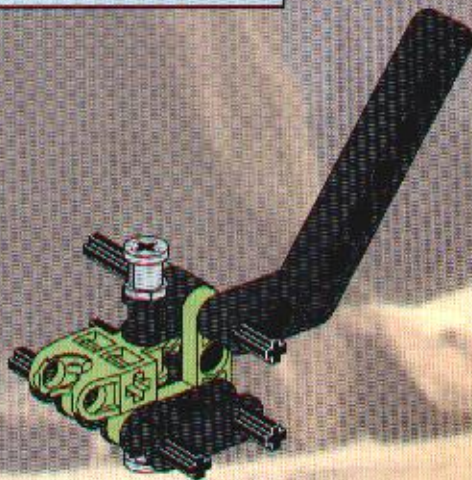

4



8

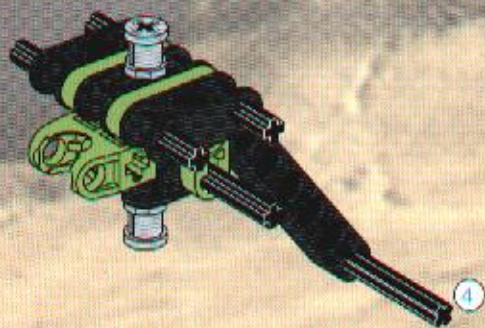

9

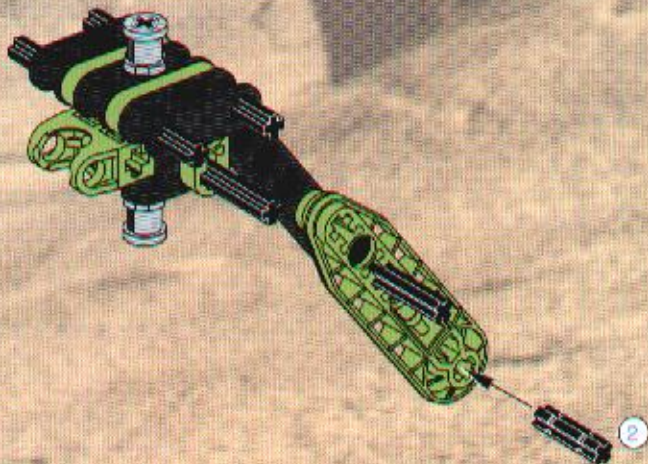

1:1

5



10

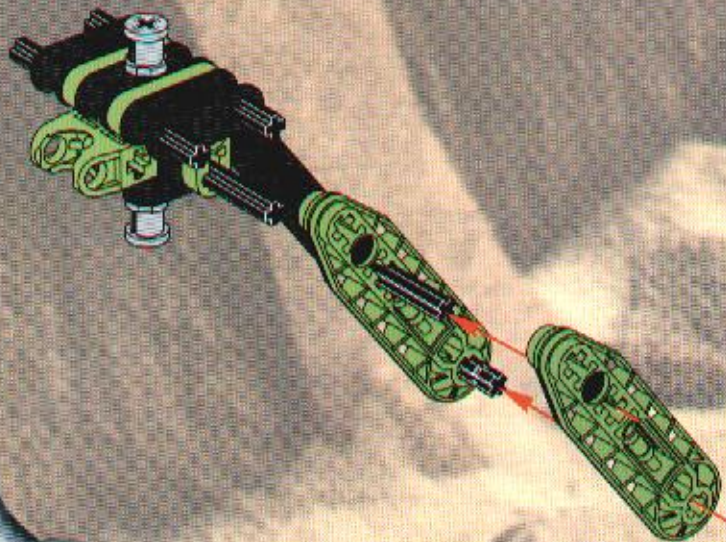

11

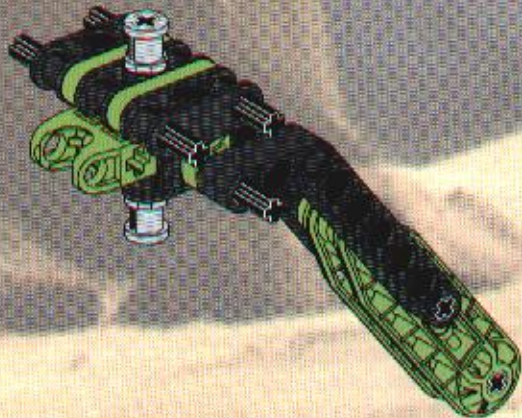



1



2

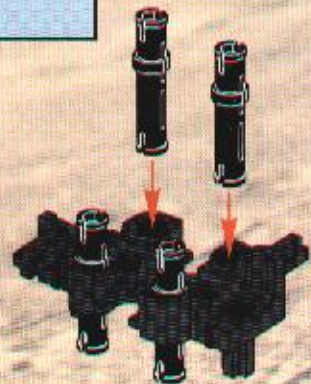

3

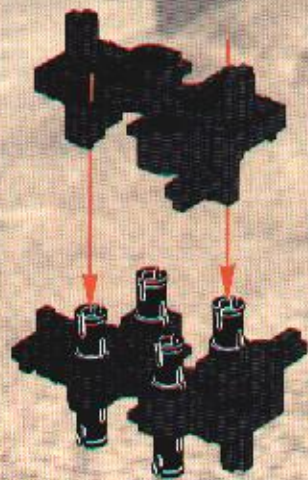



4



1x

5

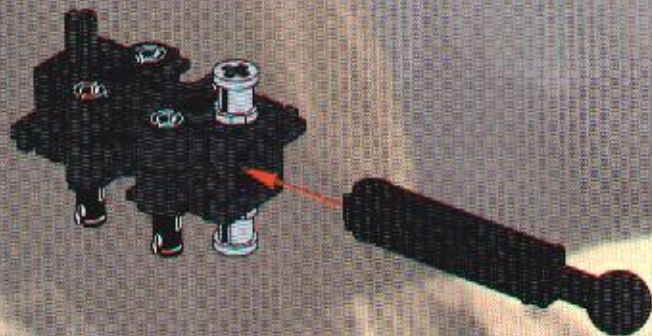

6

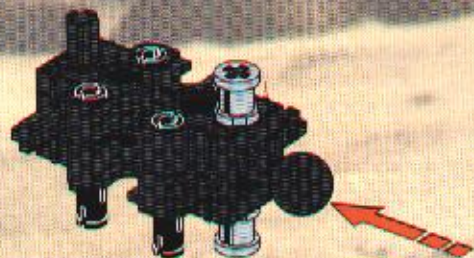



7

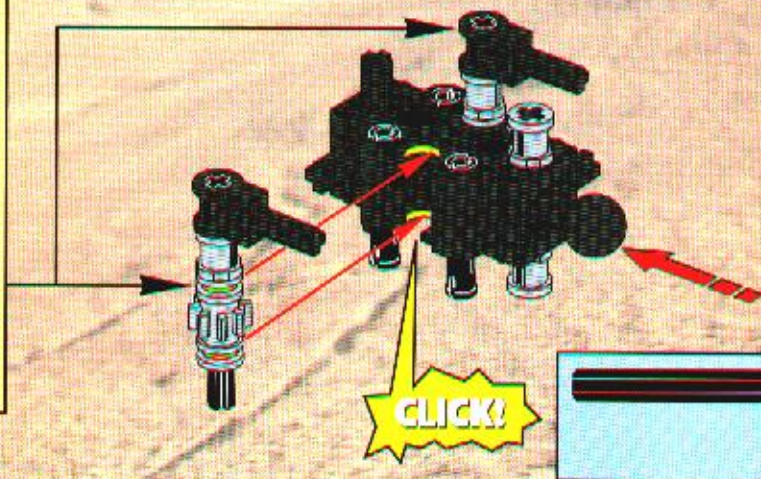
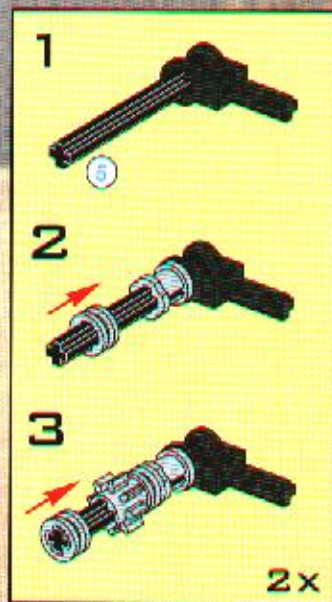



8

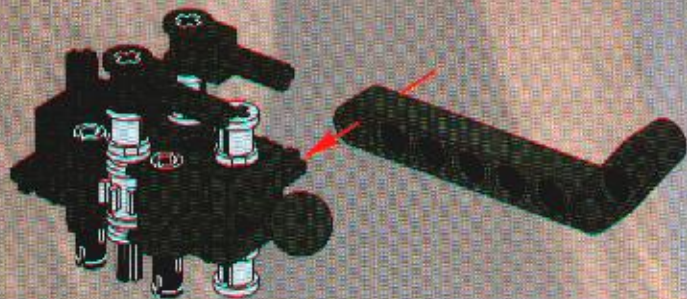

12

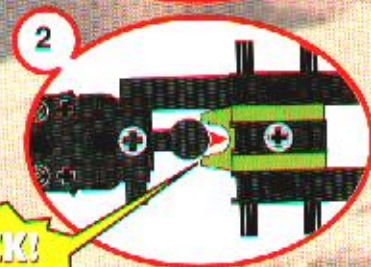
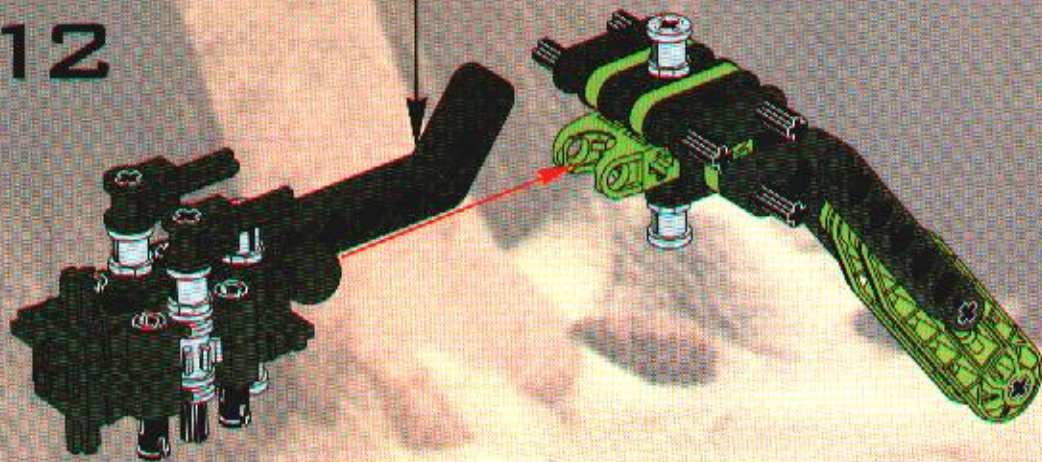

CLICK!



13

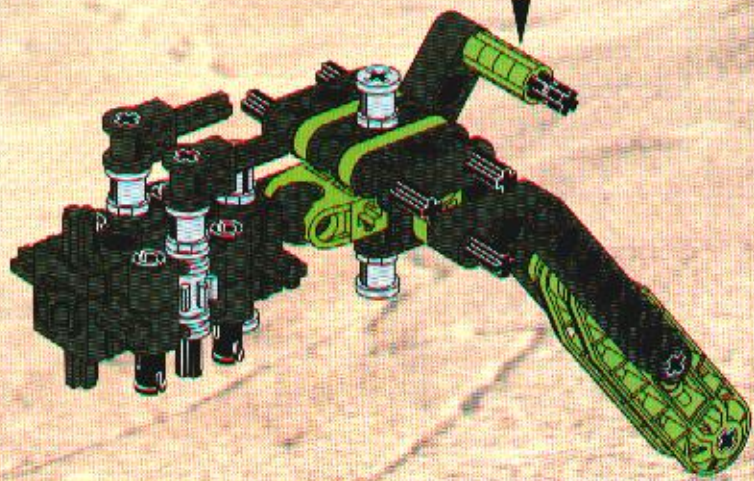
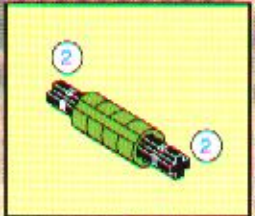



14

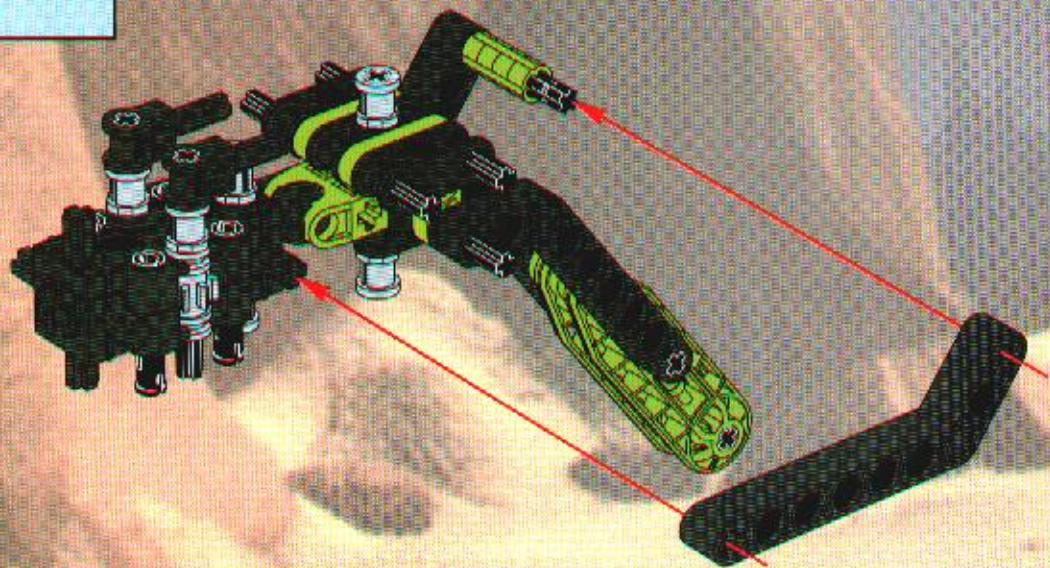



2x

15

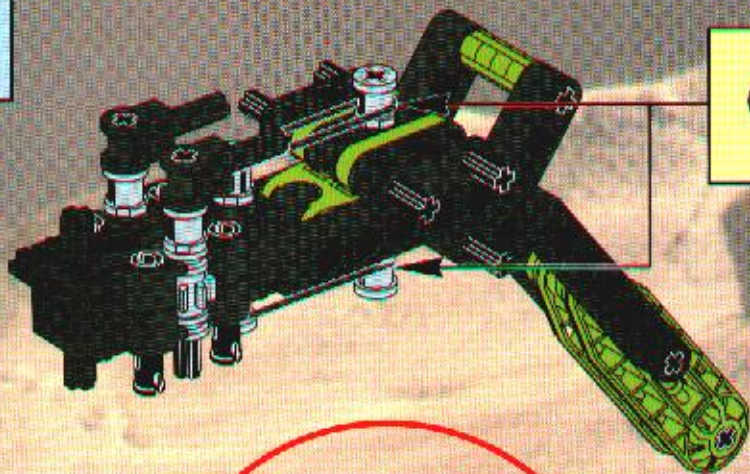

2x

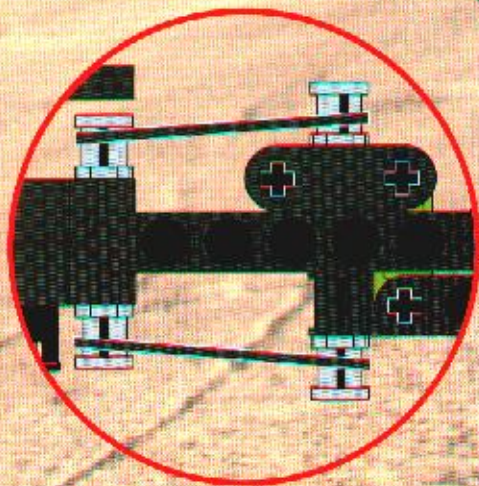

2x



16

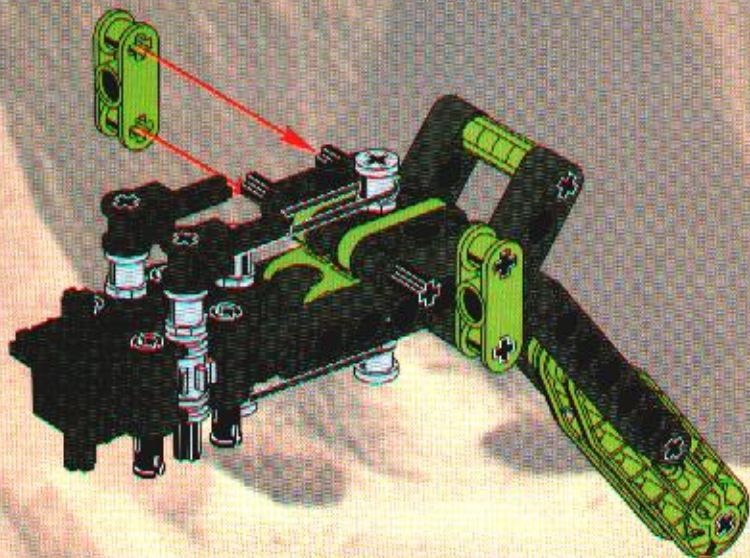

2x



17

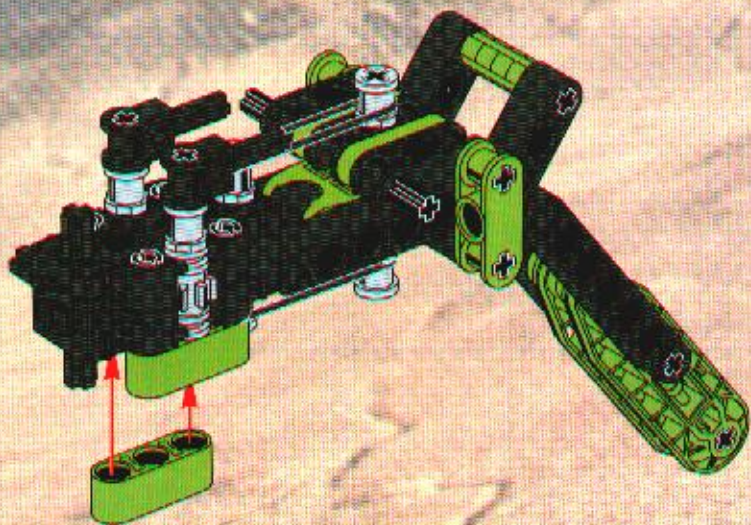



18

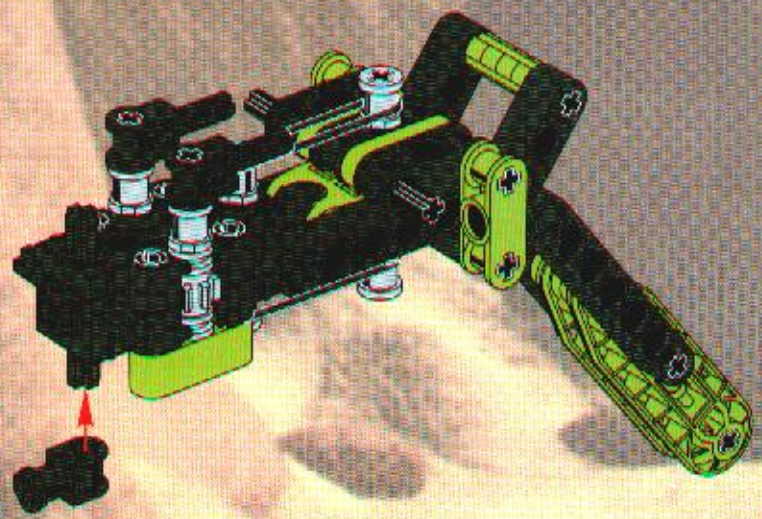

2x

19

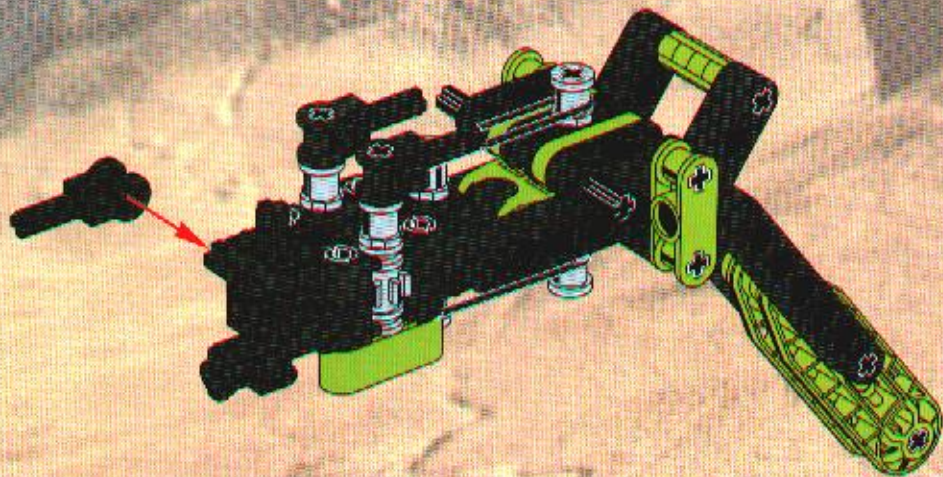



20

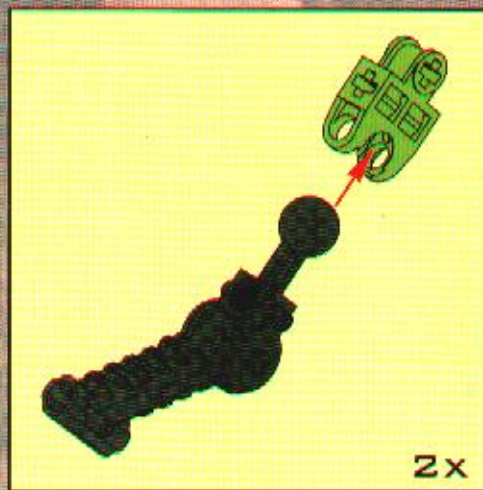



21

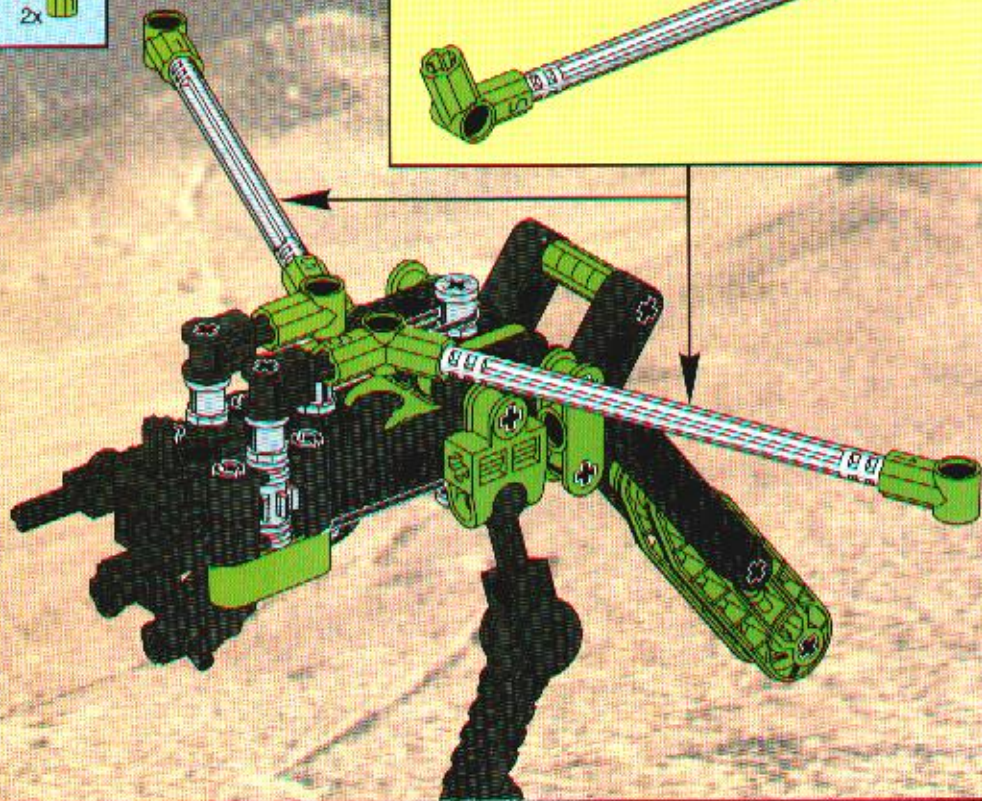
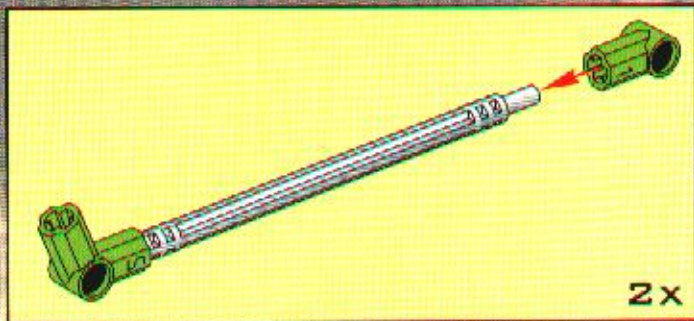

2x

22



2x



23

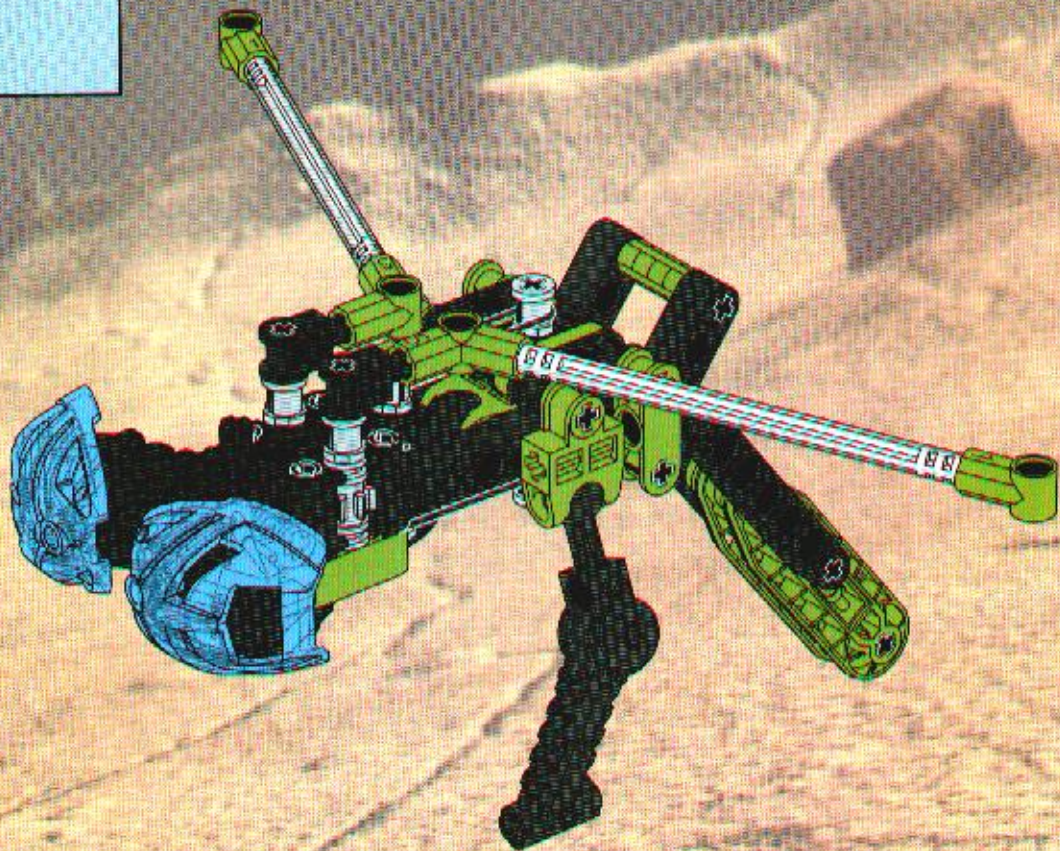

3x



24

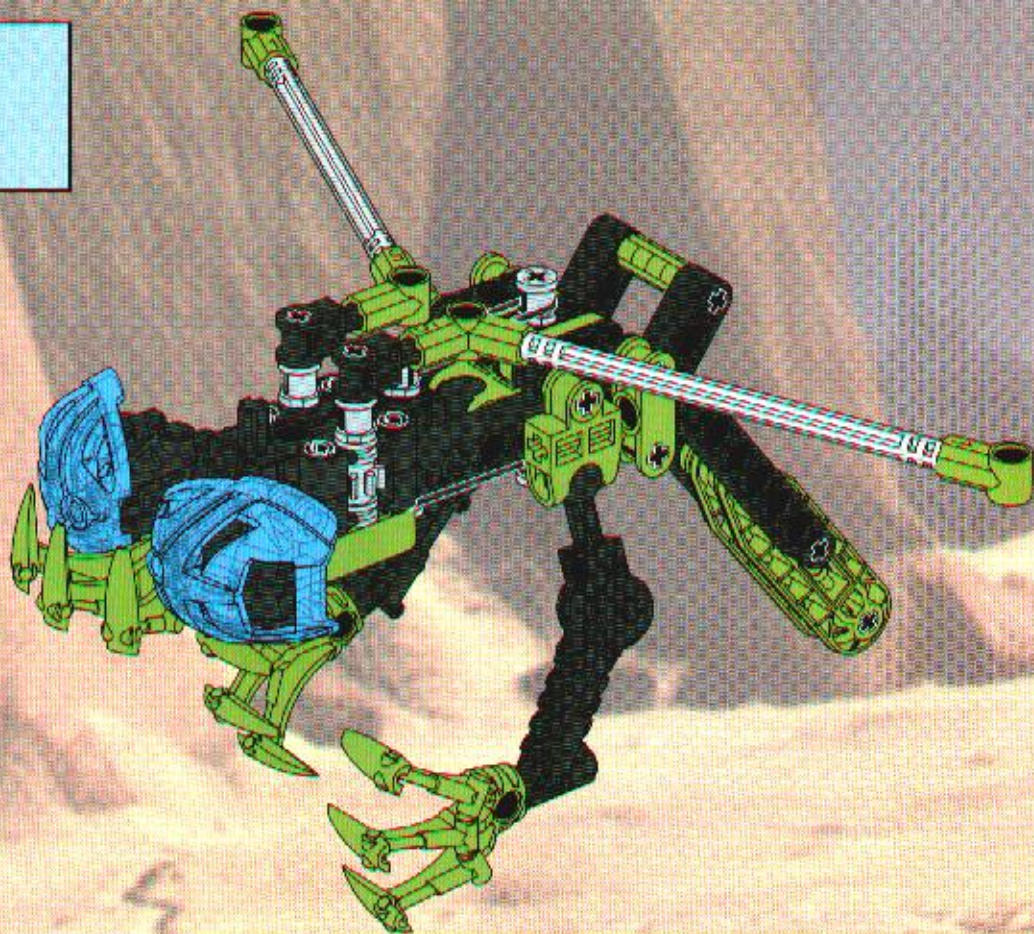

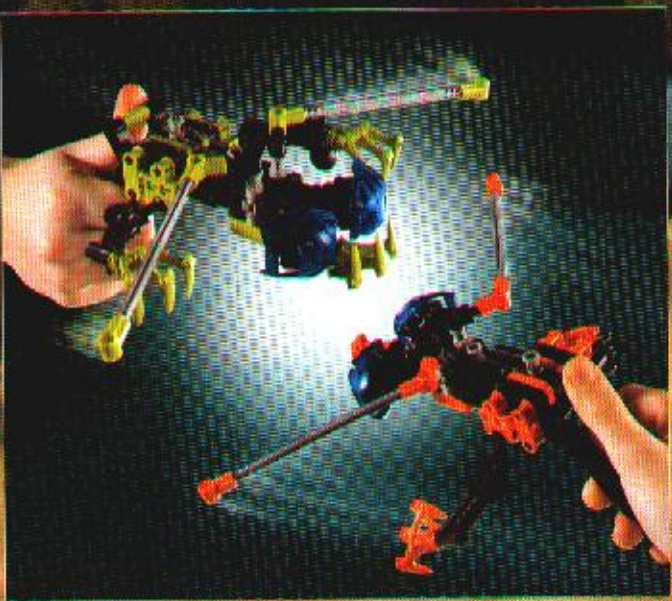

BIONNICIE

www.bionnicie.com

KAPOHI



72+



LEGO

TECHNIC

FIND THE POWER

TIRARA



BIONICLE

8+

NUI-RAMA



8537

LEGO

TECHNIC

2

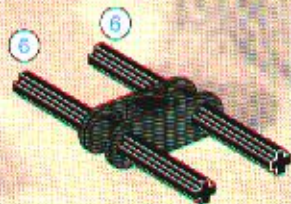

1

2



2x

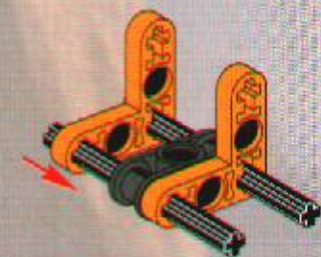

2

2x



3



4

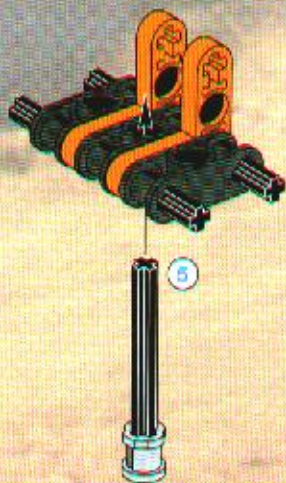

5

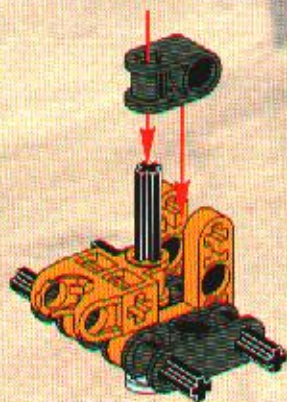



6

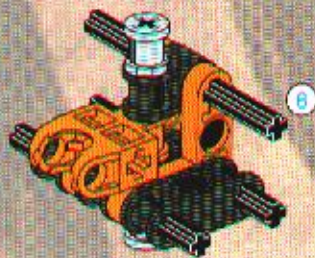

7

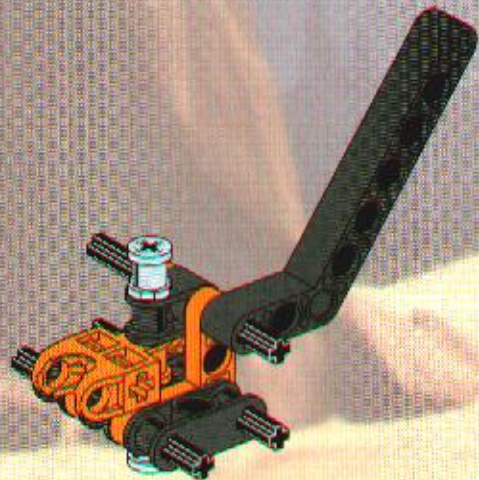

4



8

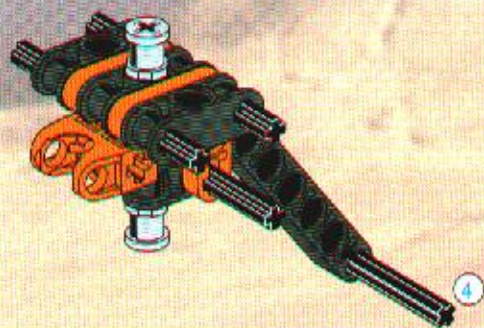

9

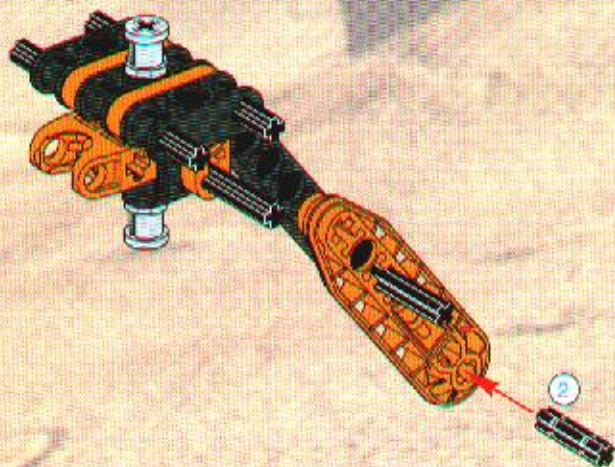



10

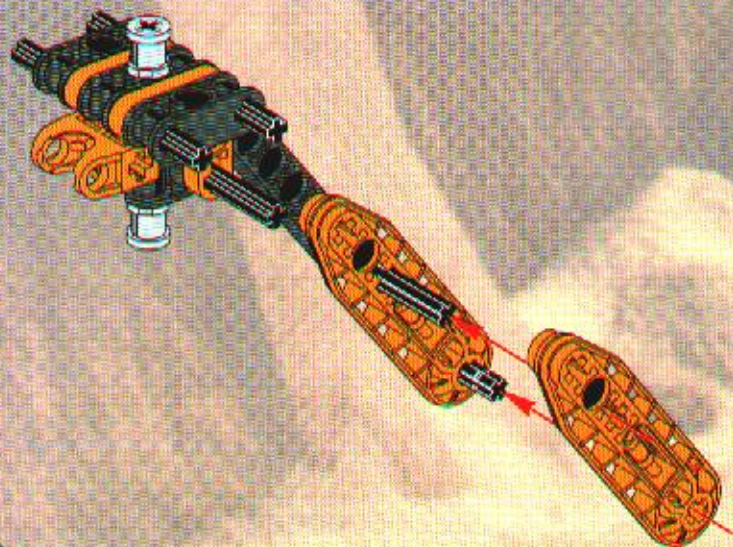

11

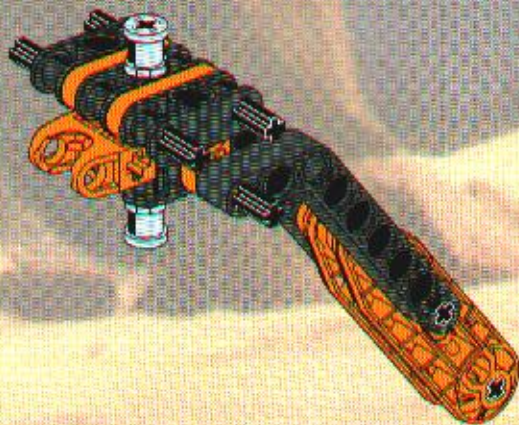



1



2

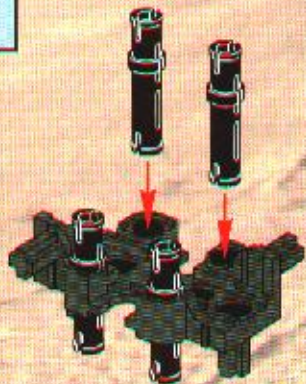

3

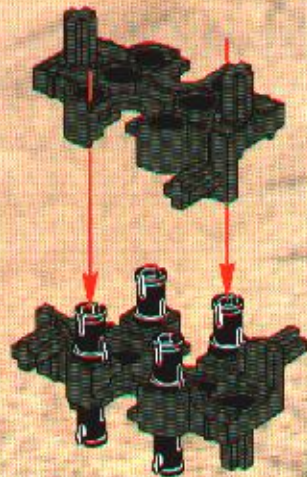



2x

4



1x

5

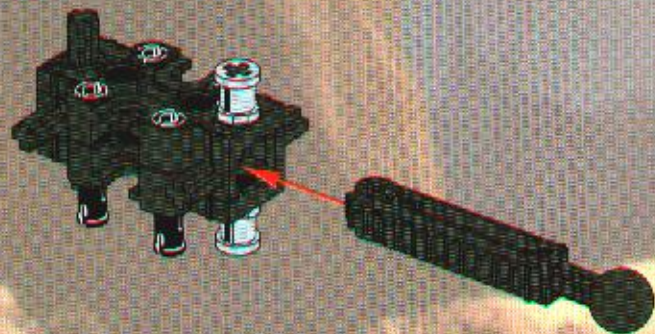

6



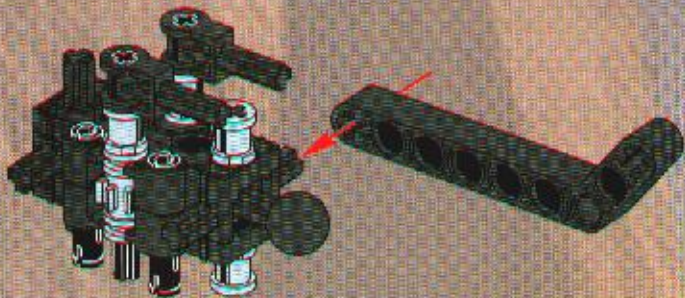

8

12

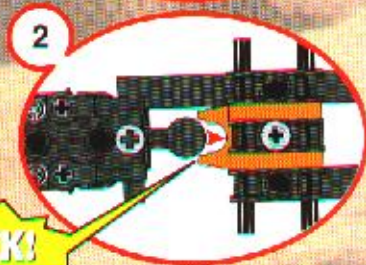
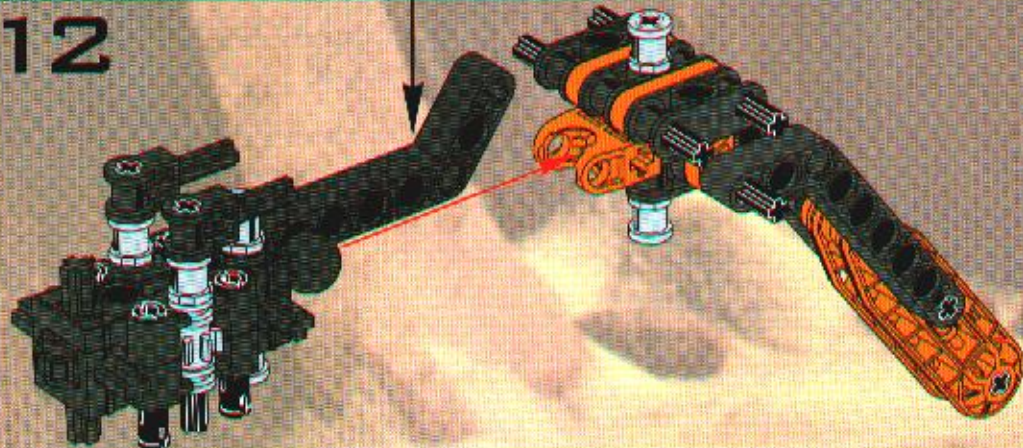

CLICK!



13

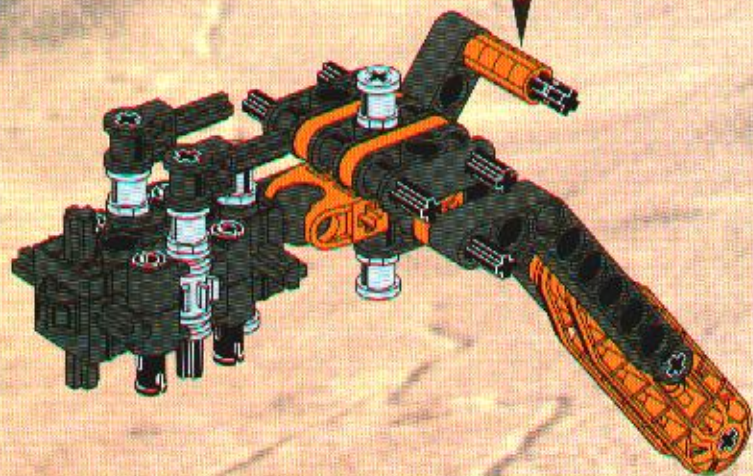
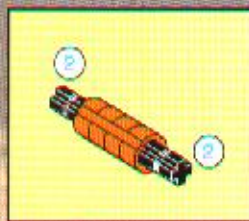



14

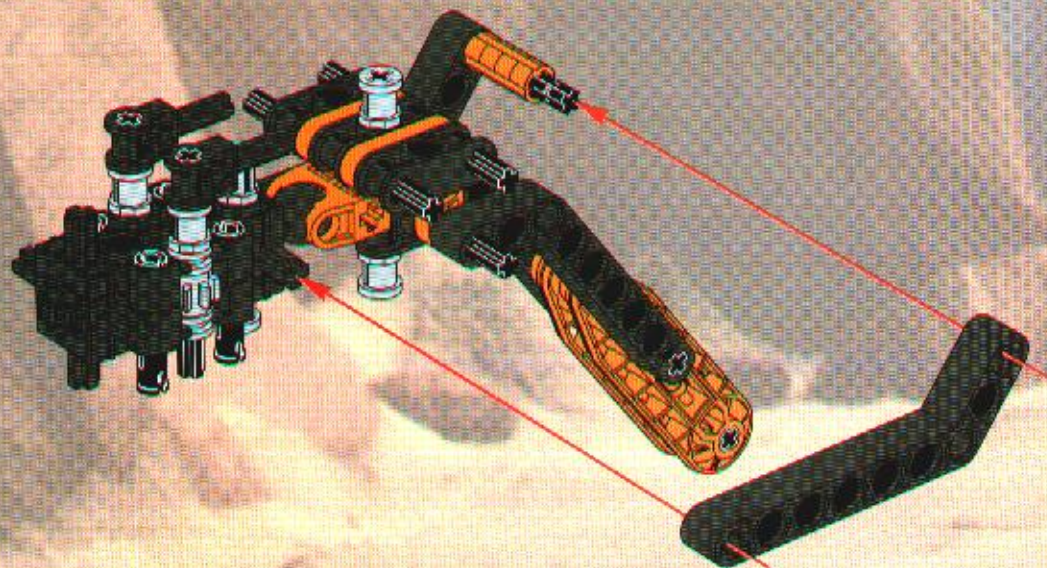



15

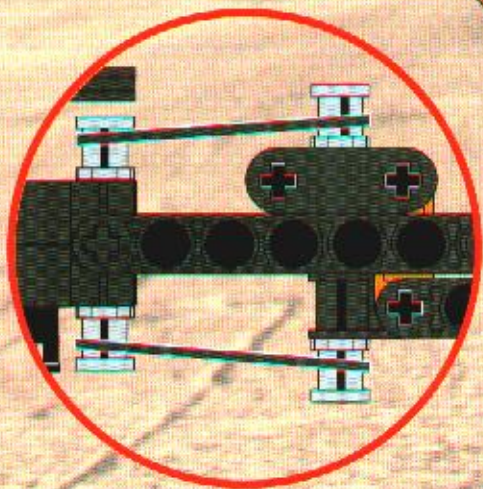
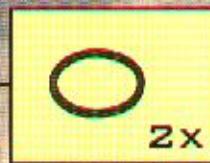
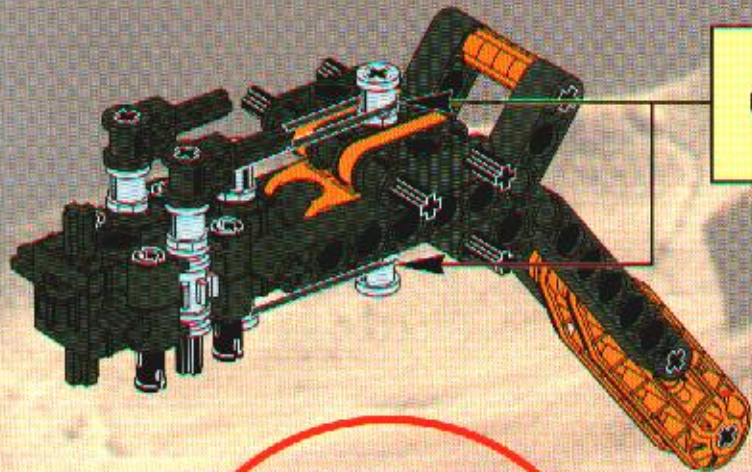

2x



16

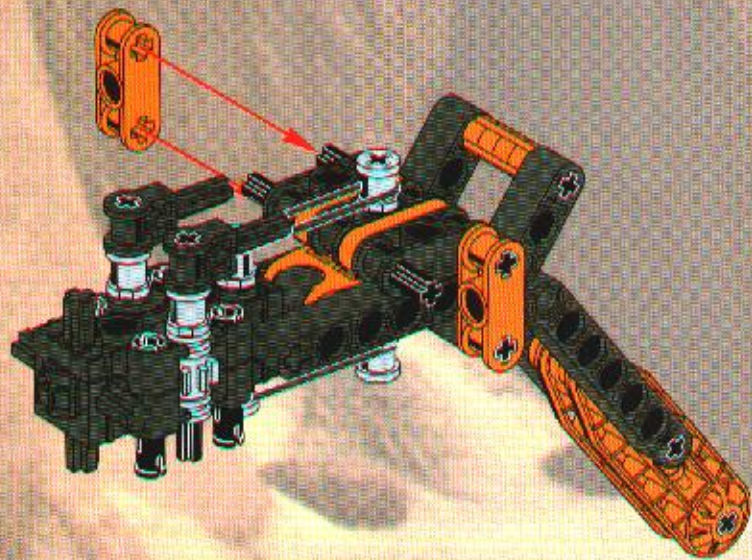

2x



17

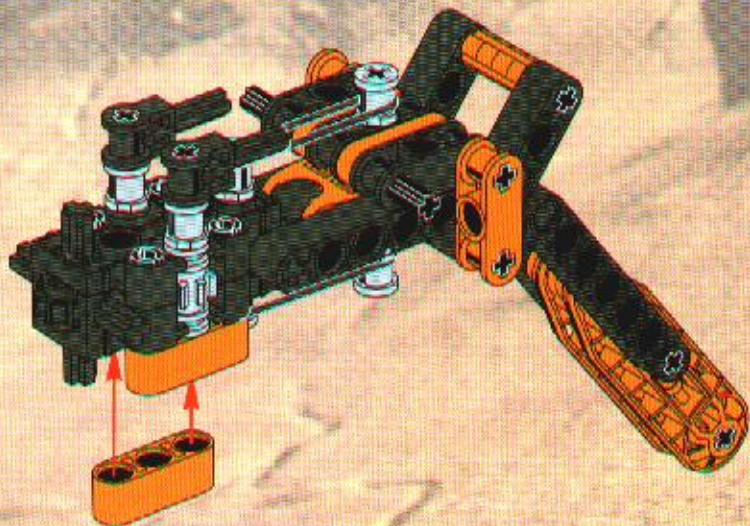

1x

18





19

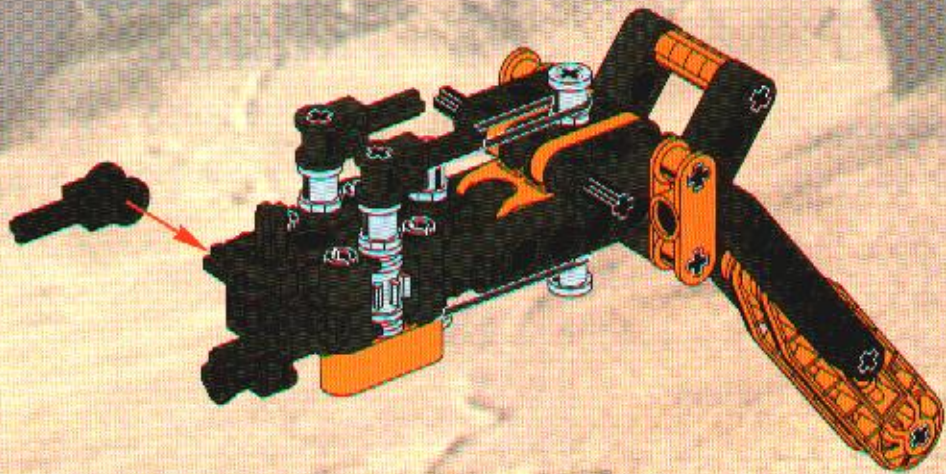



20

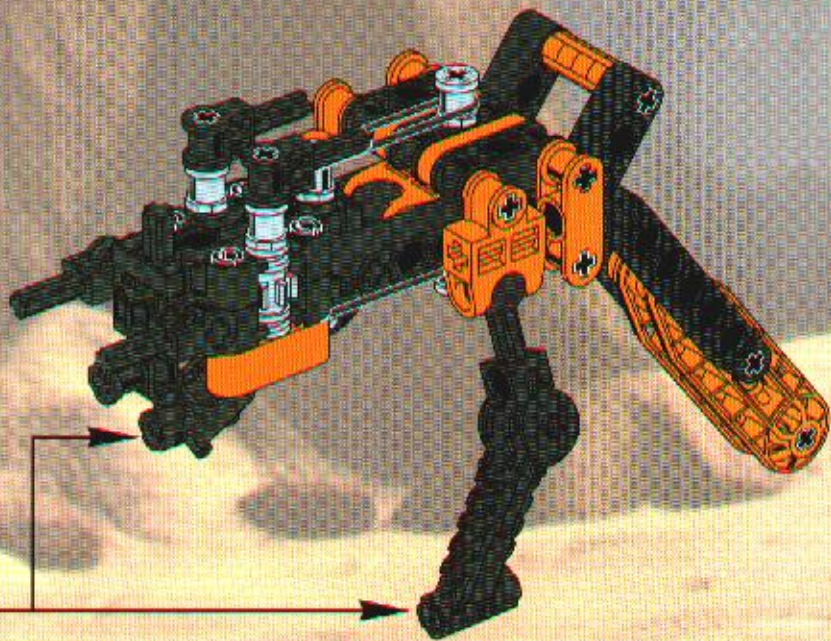
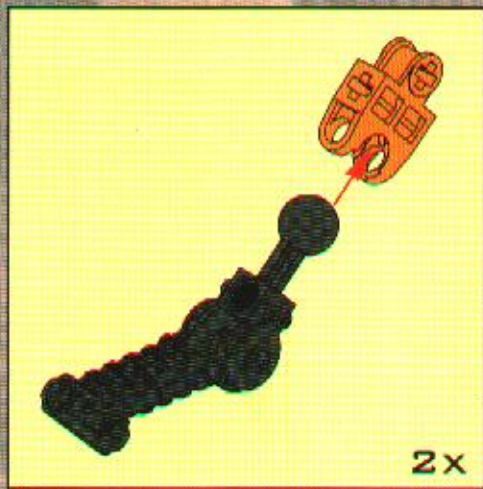



21

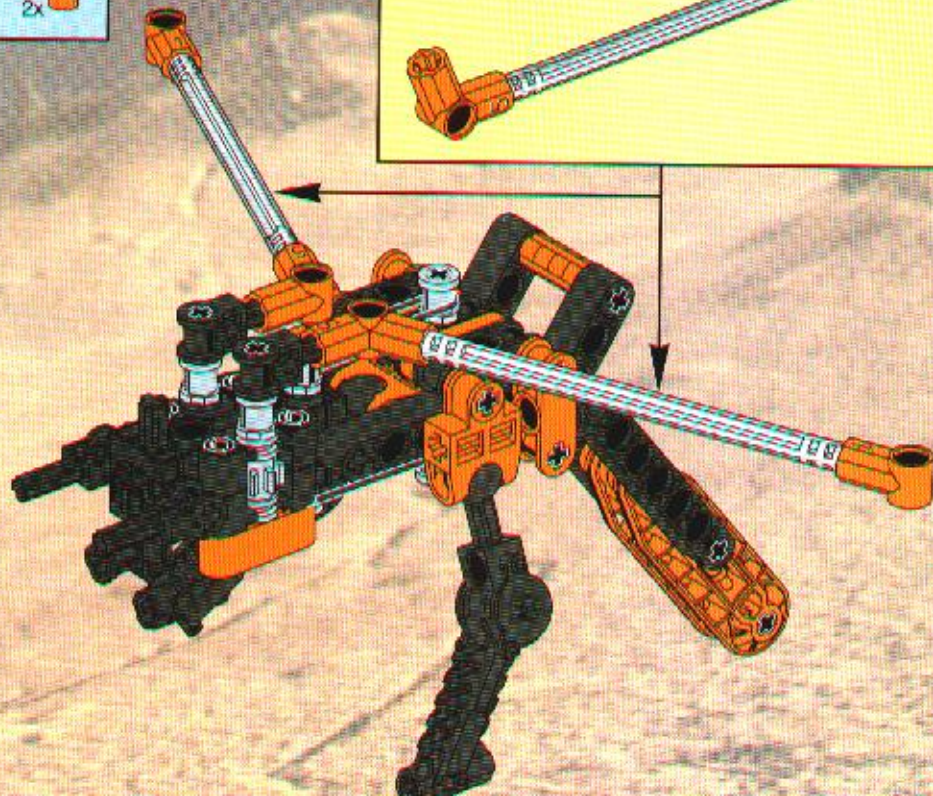
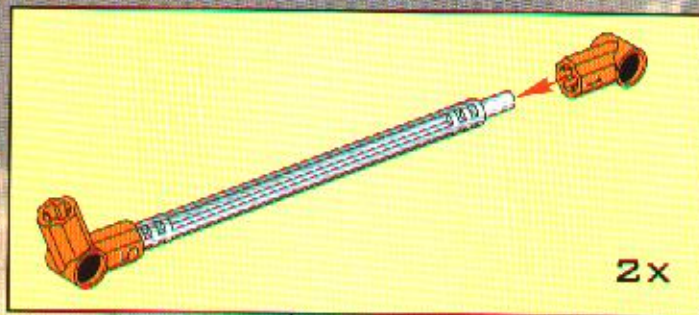

2x

22





23

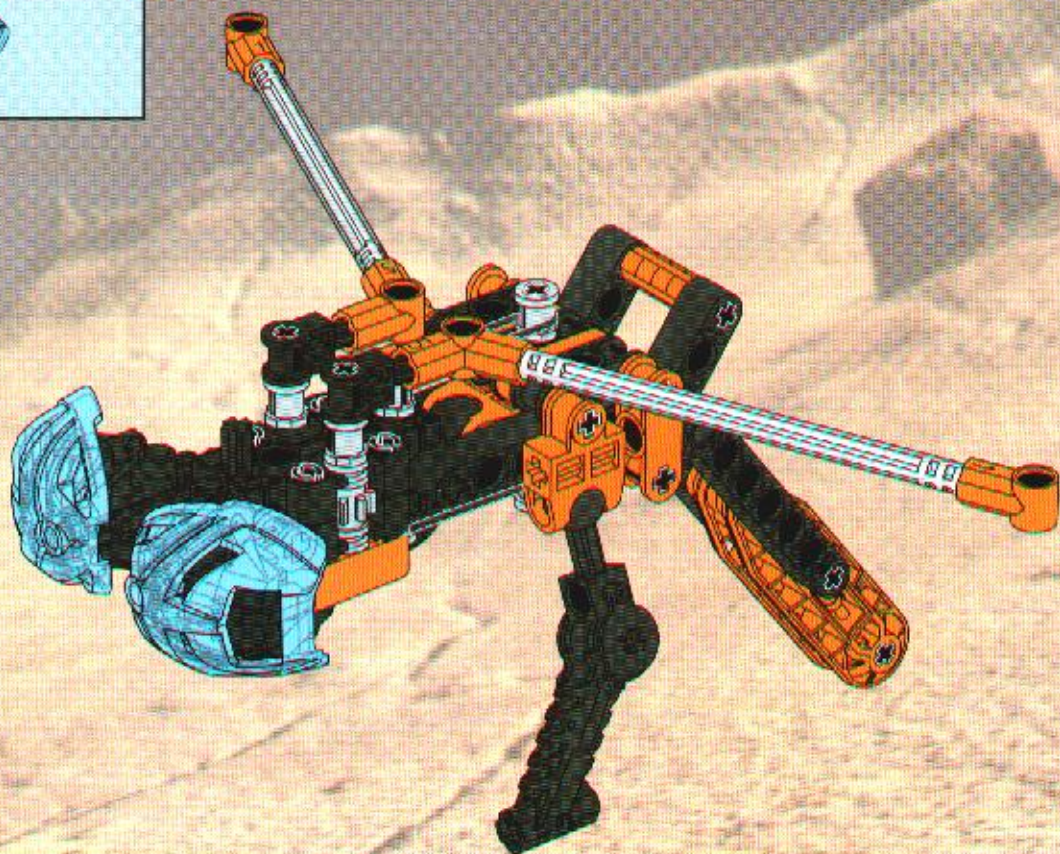



24

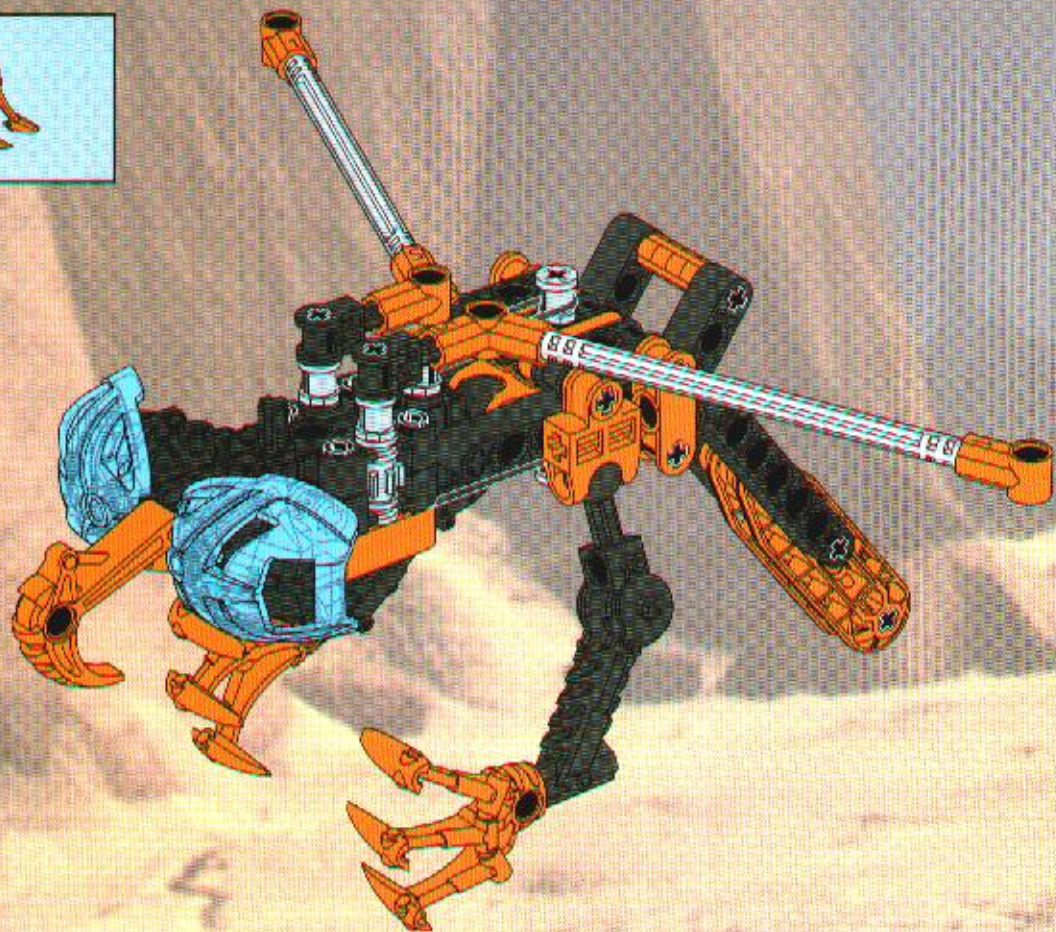



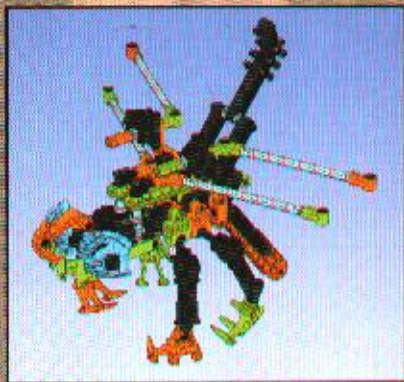

1

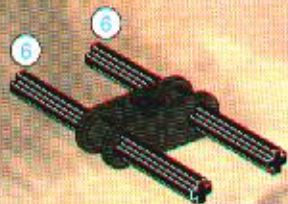

2

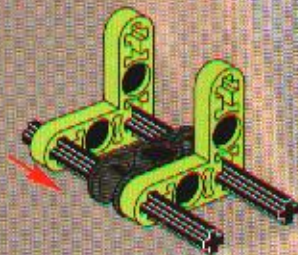



3

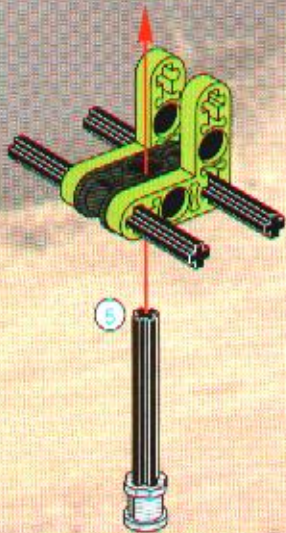

4

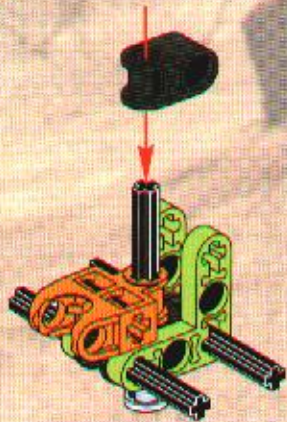



5

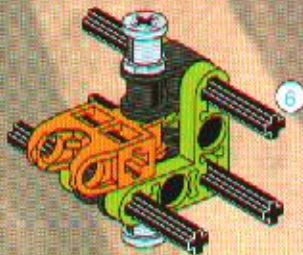

1x

6

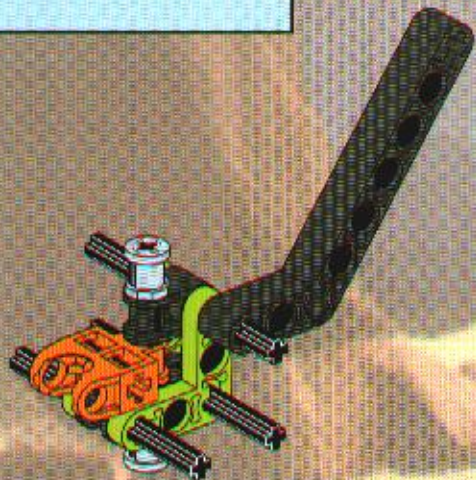

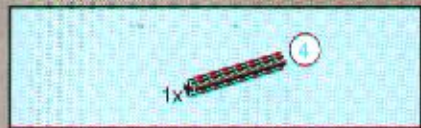

7

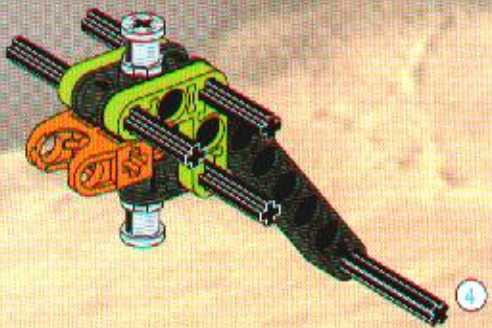

8

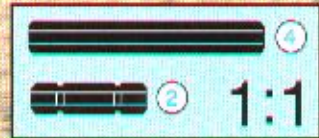
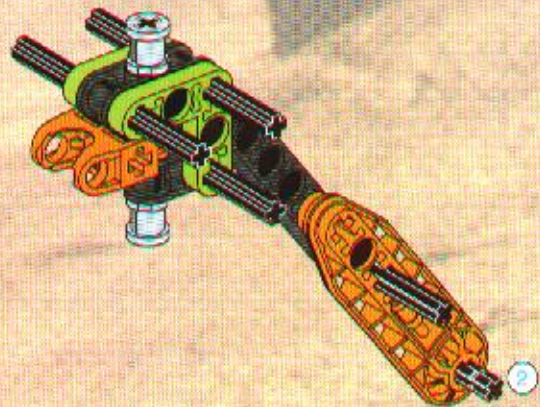



9

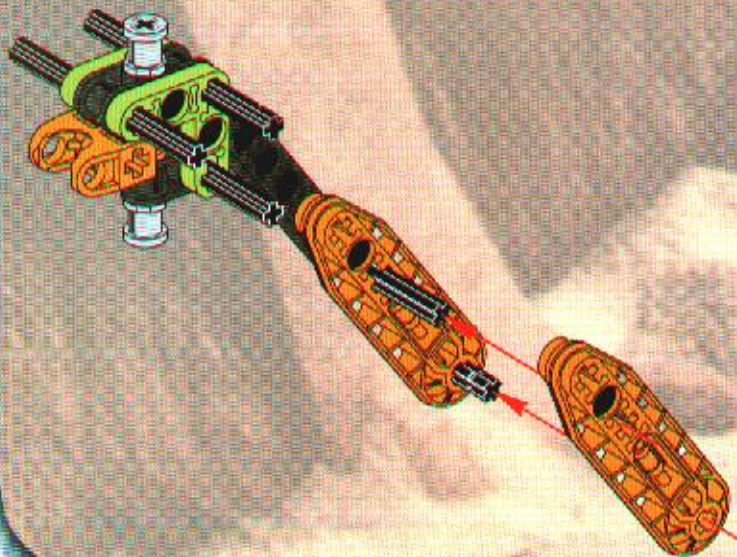

10

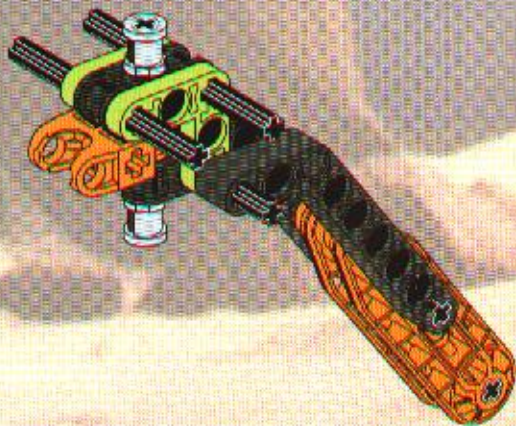



1



2

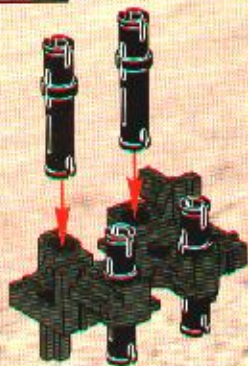

3





2x

4



1x

5

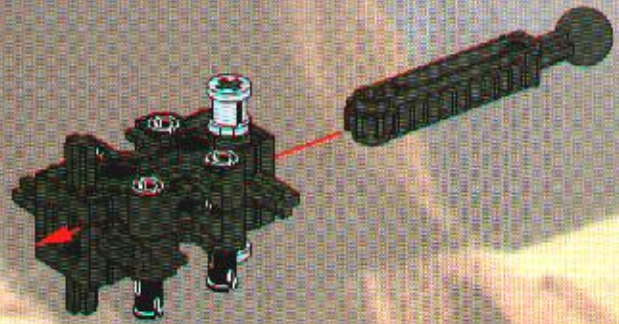



6

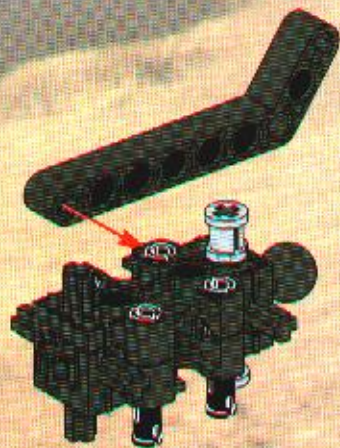

11

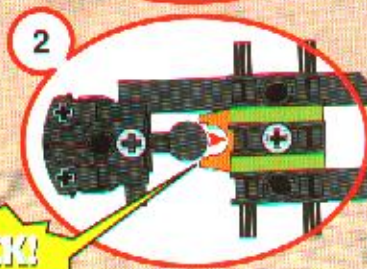
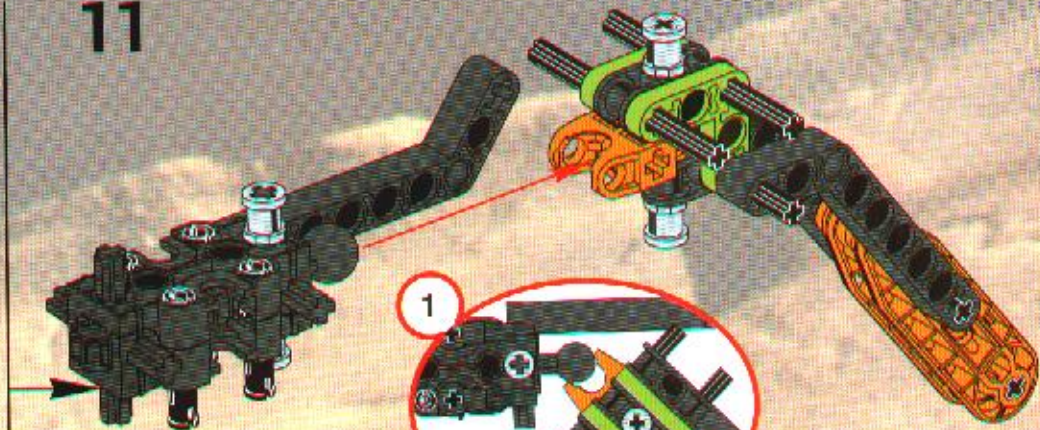

CLICK!

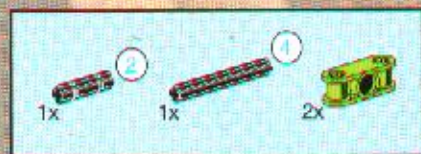

12

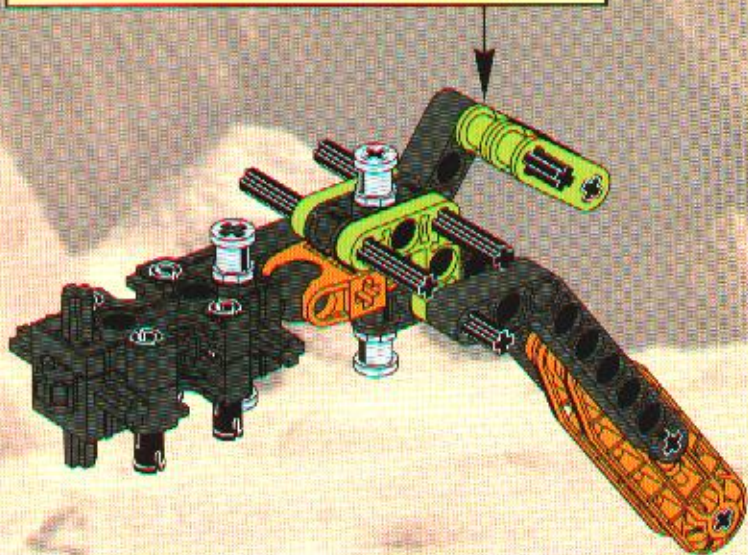
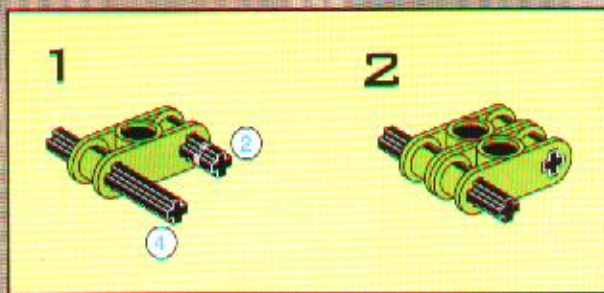



13

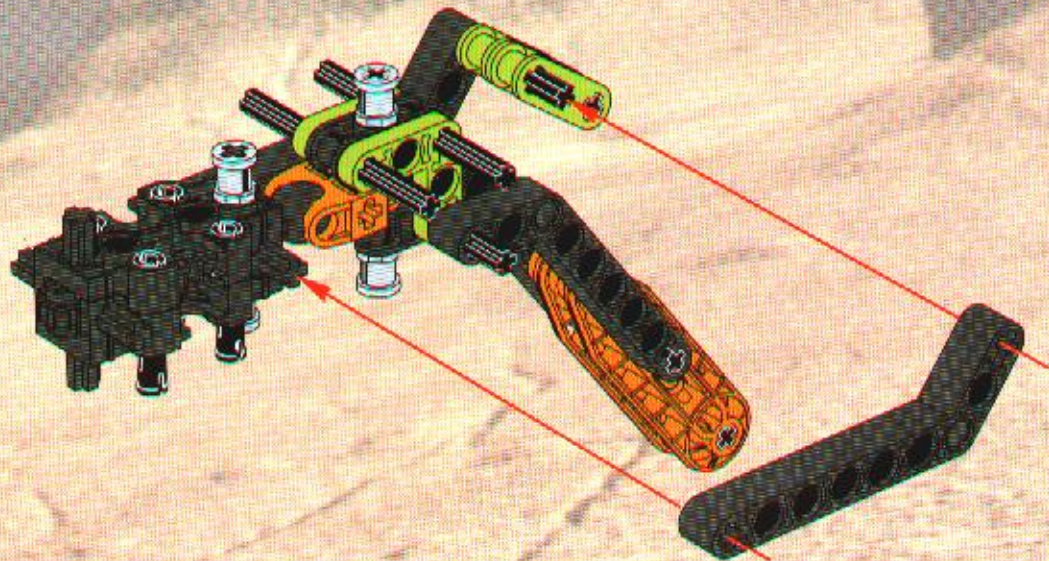

1x

14

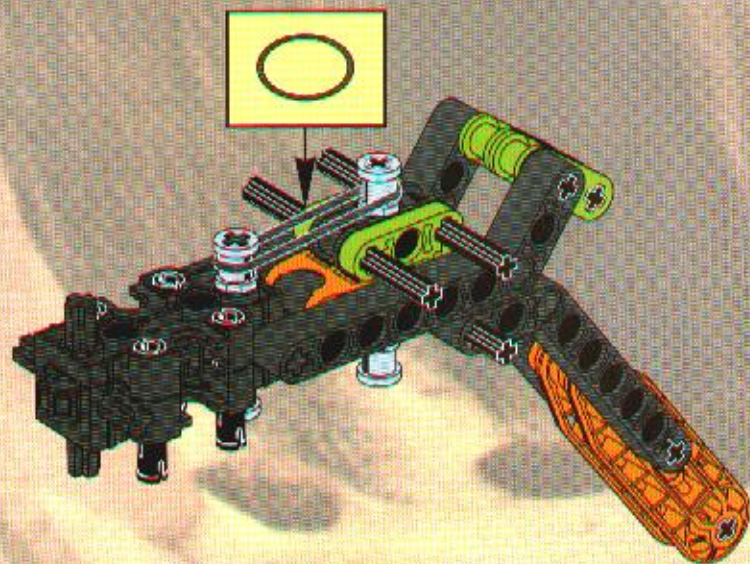



1x

15

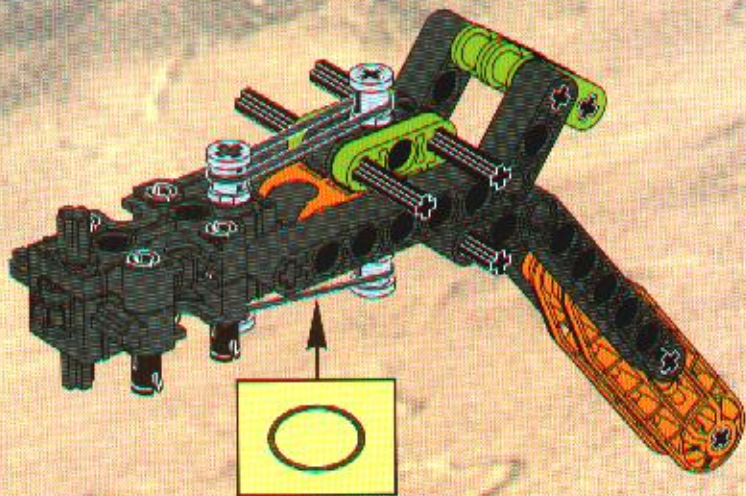



16



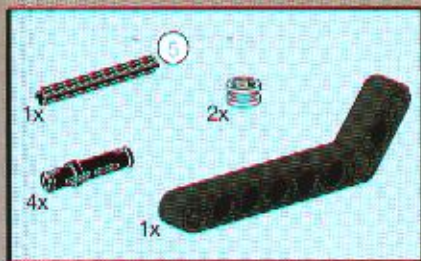

17

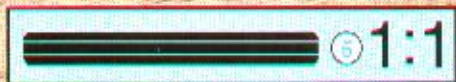
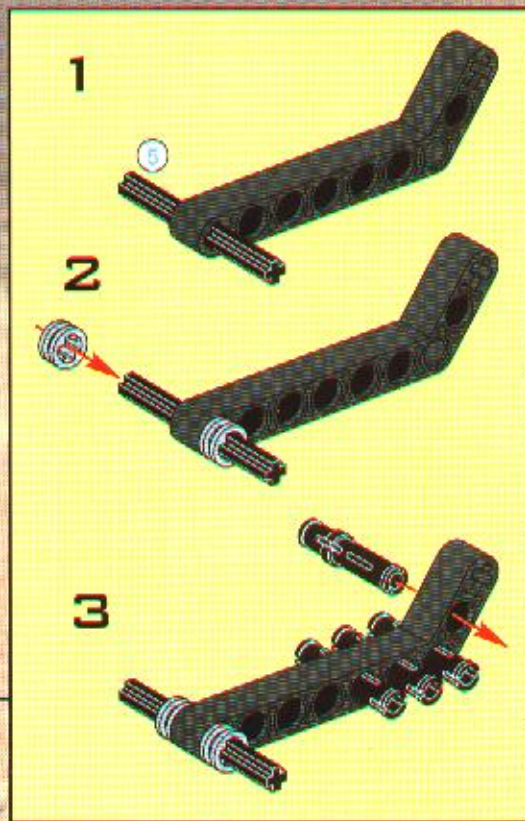
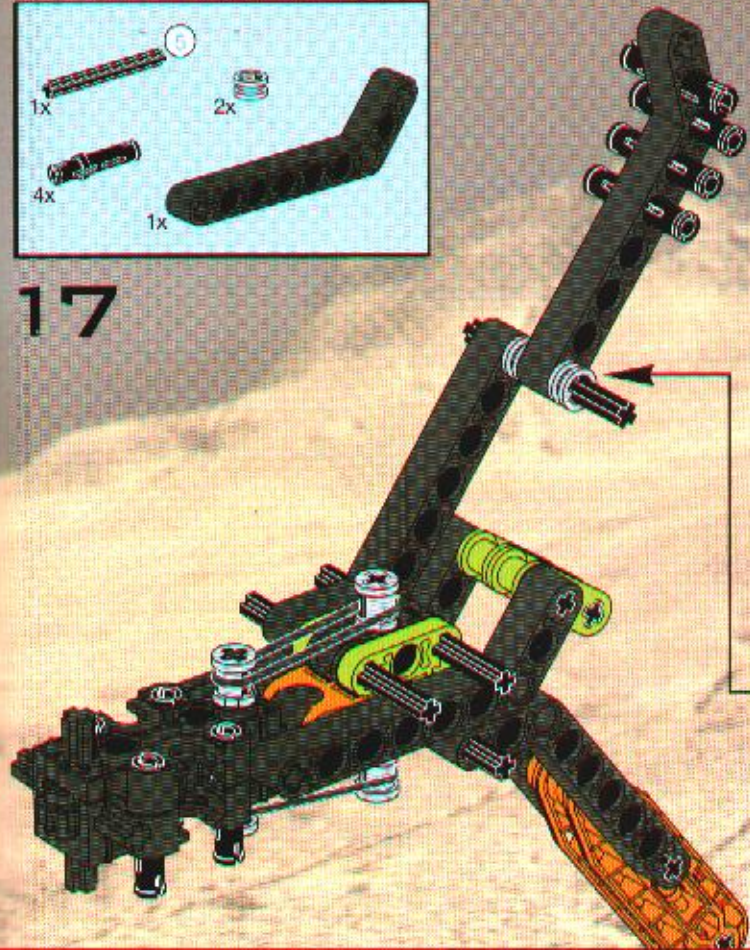



18

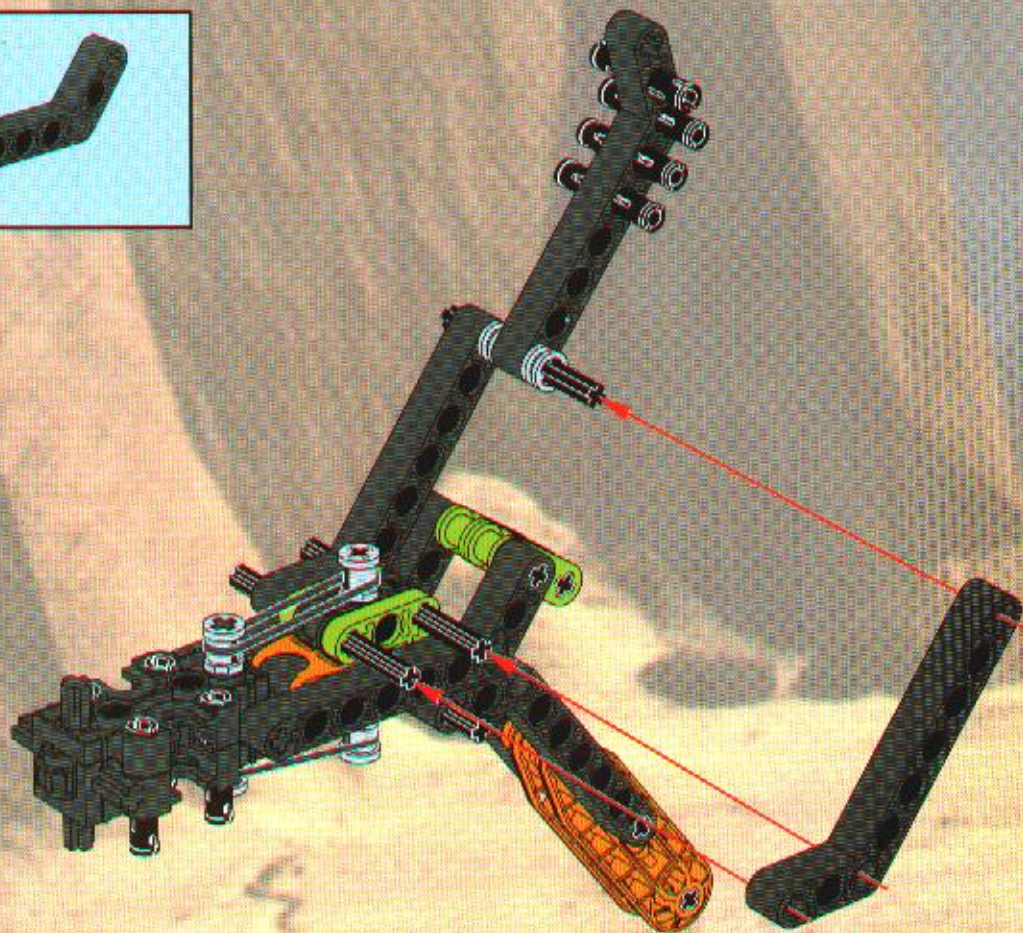



2x

19

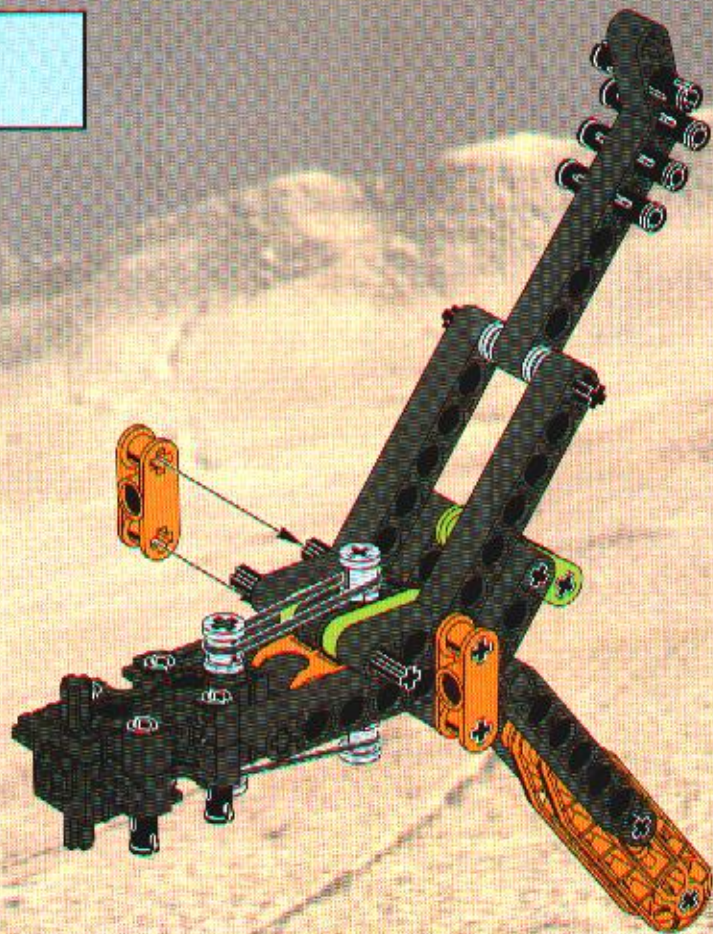

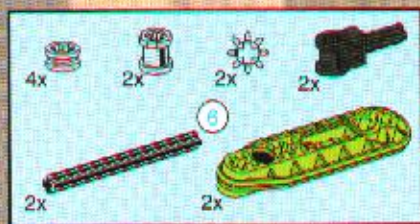

20

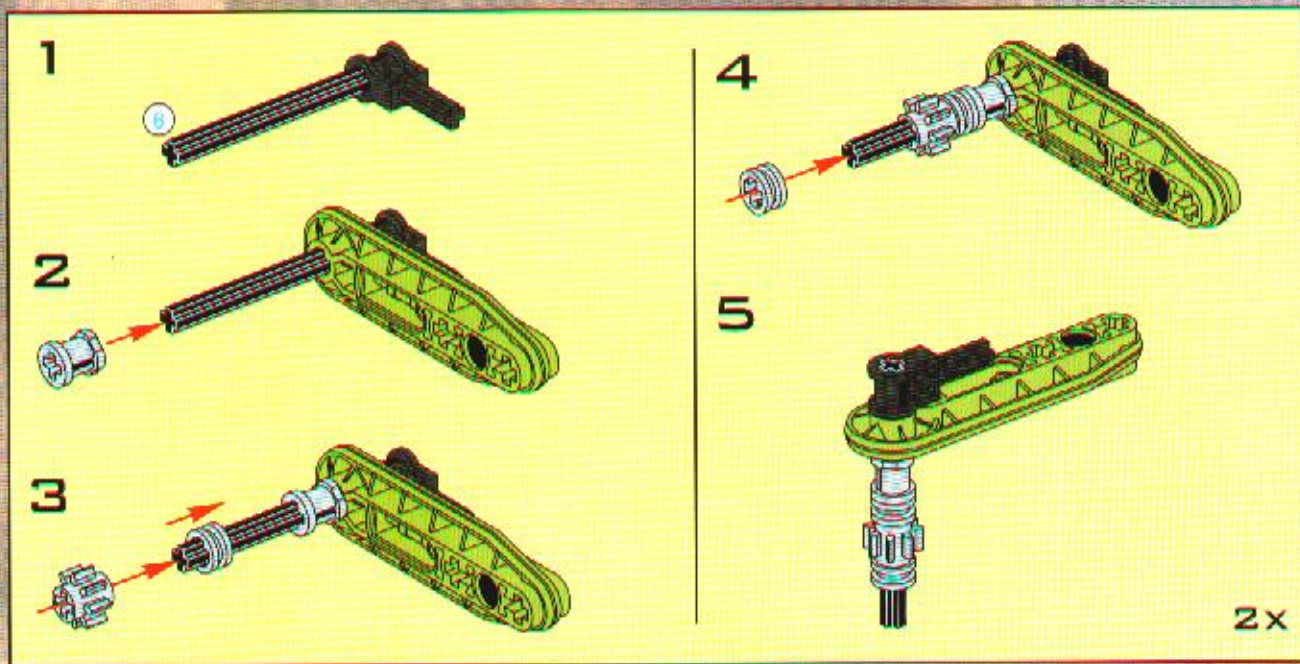

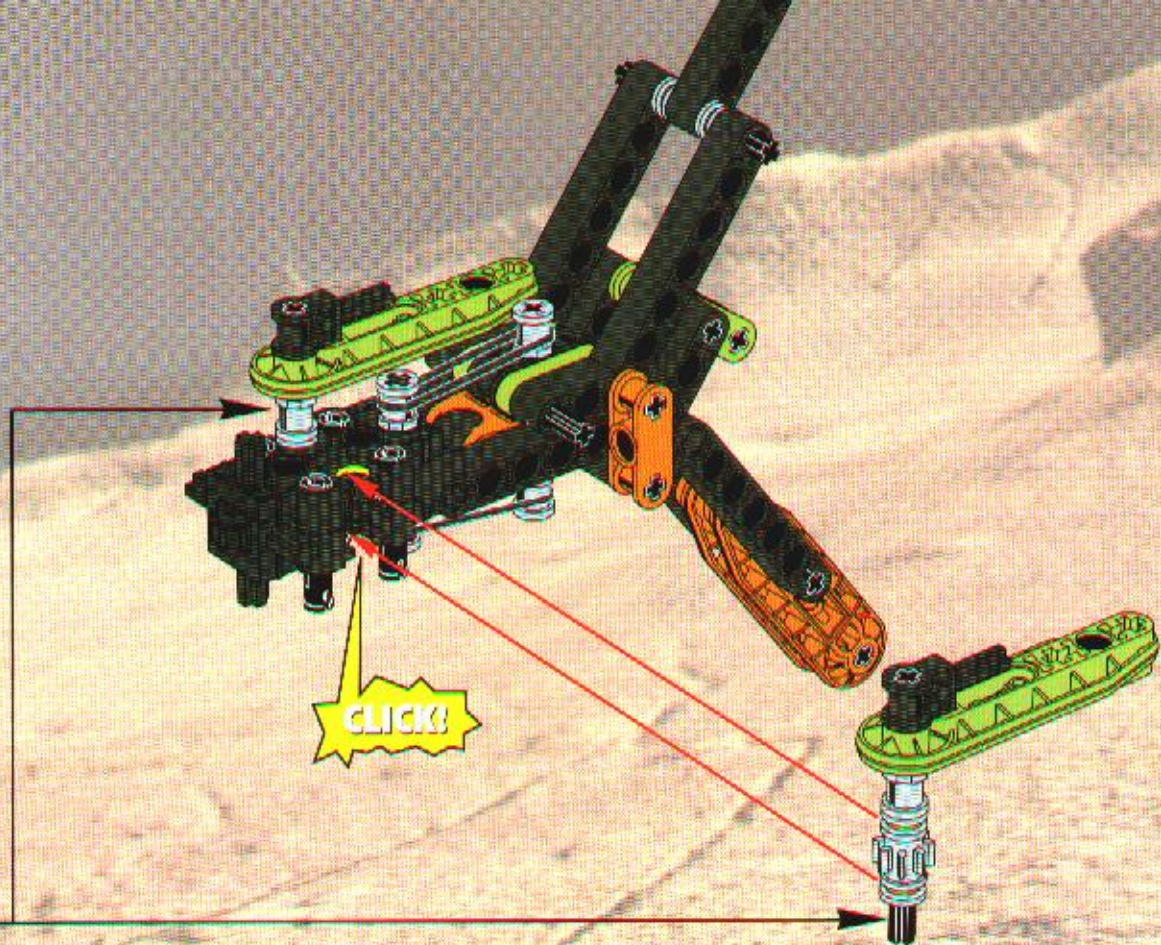



2x

21

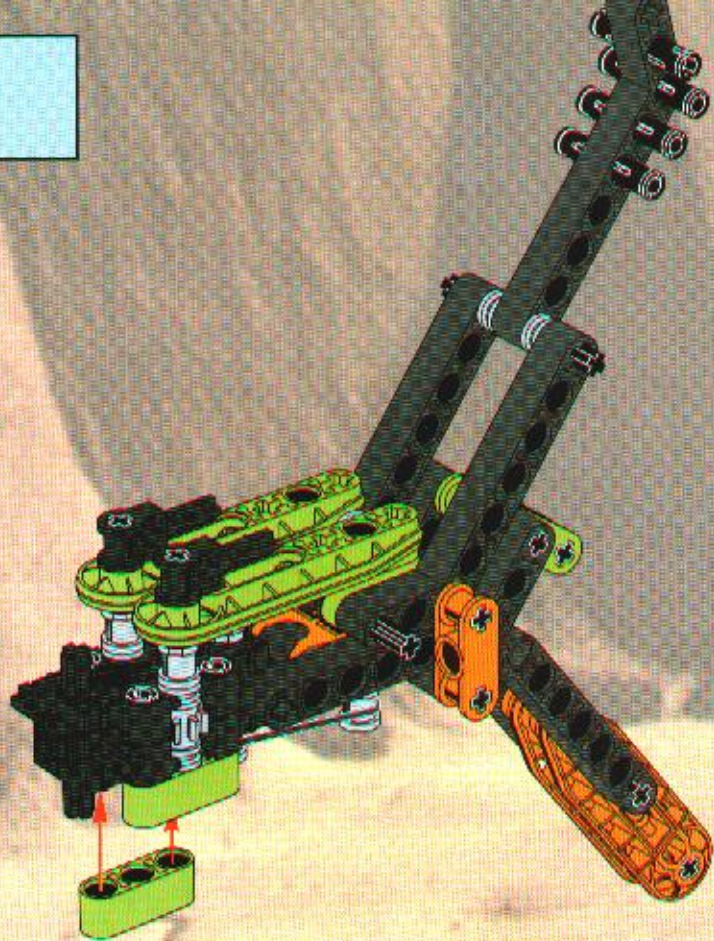

2x

22

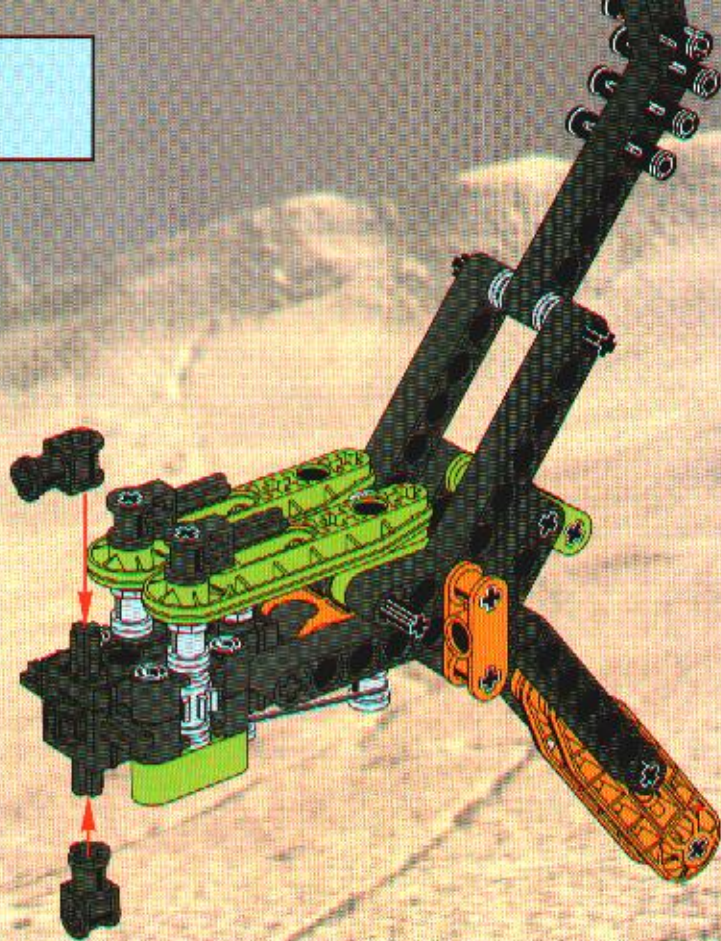

2x



23



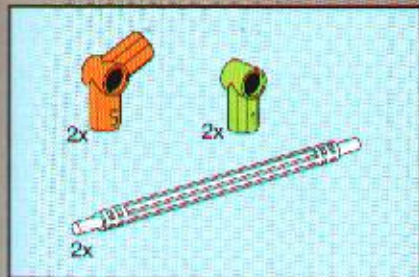

24

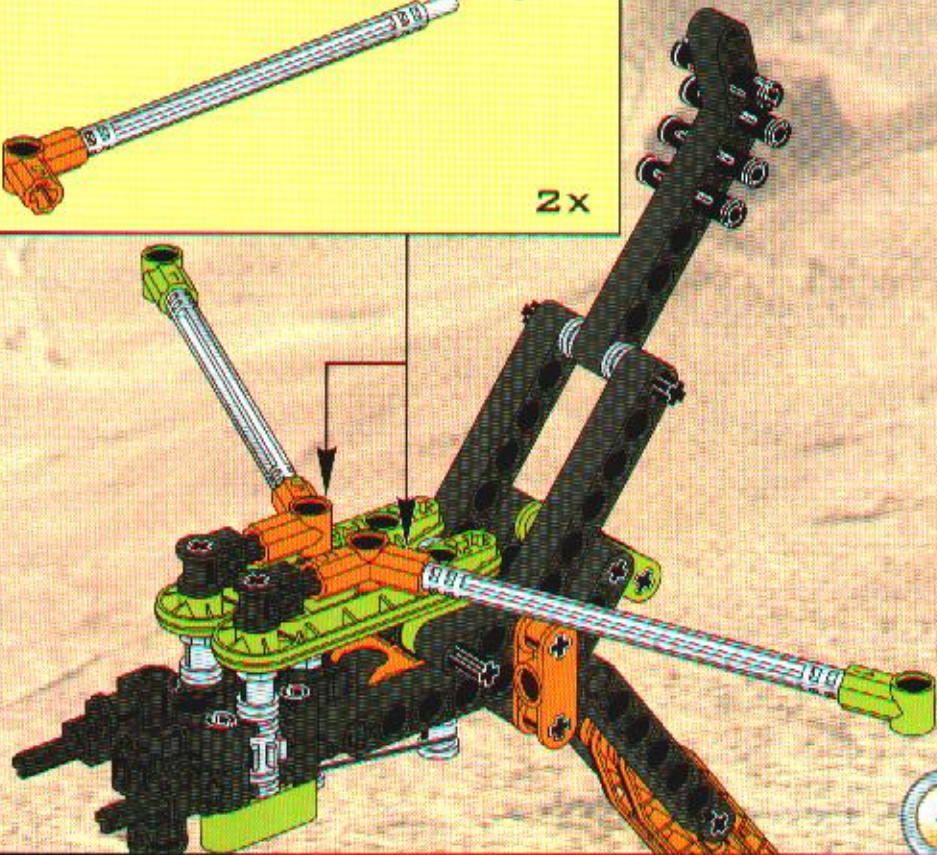
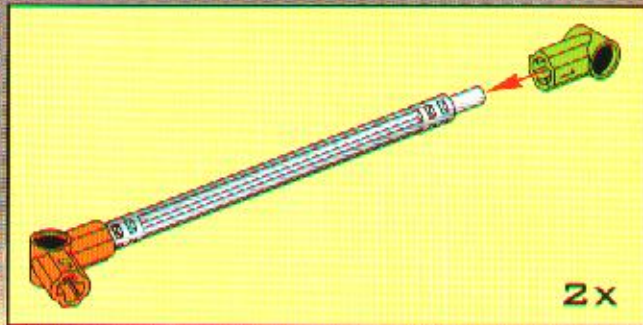



1

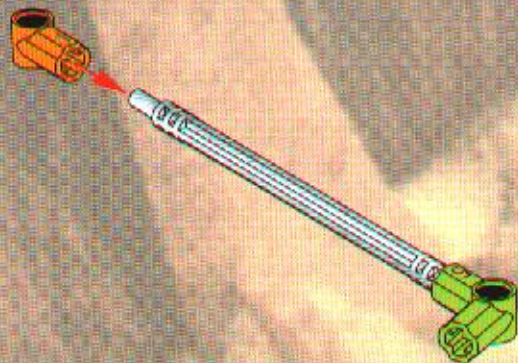

2

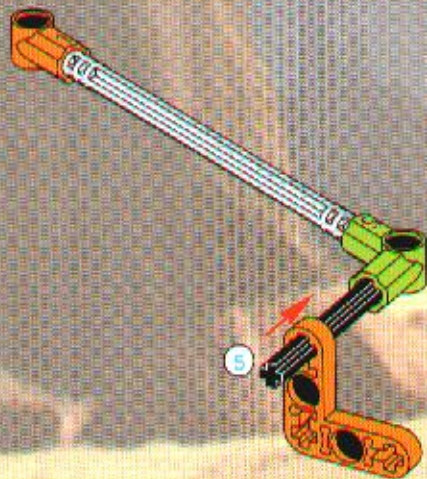

3

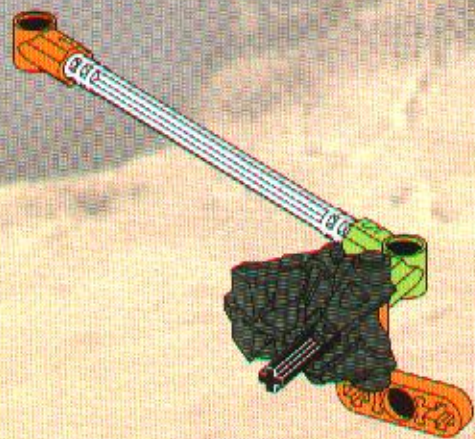

4

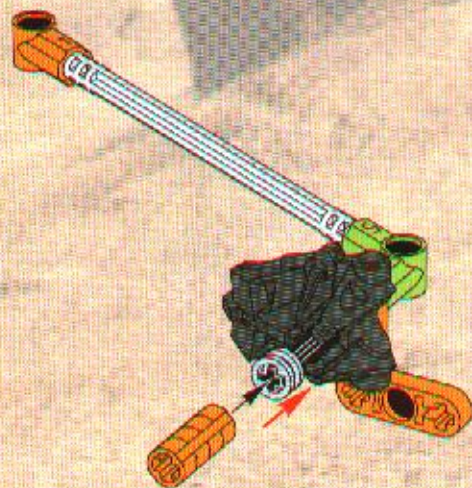

5



25

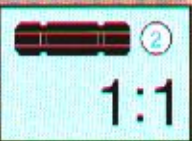
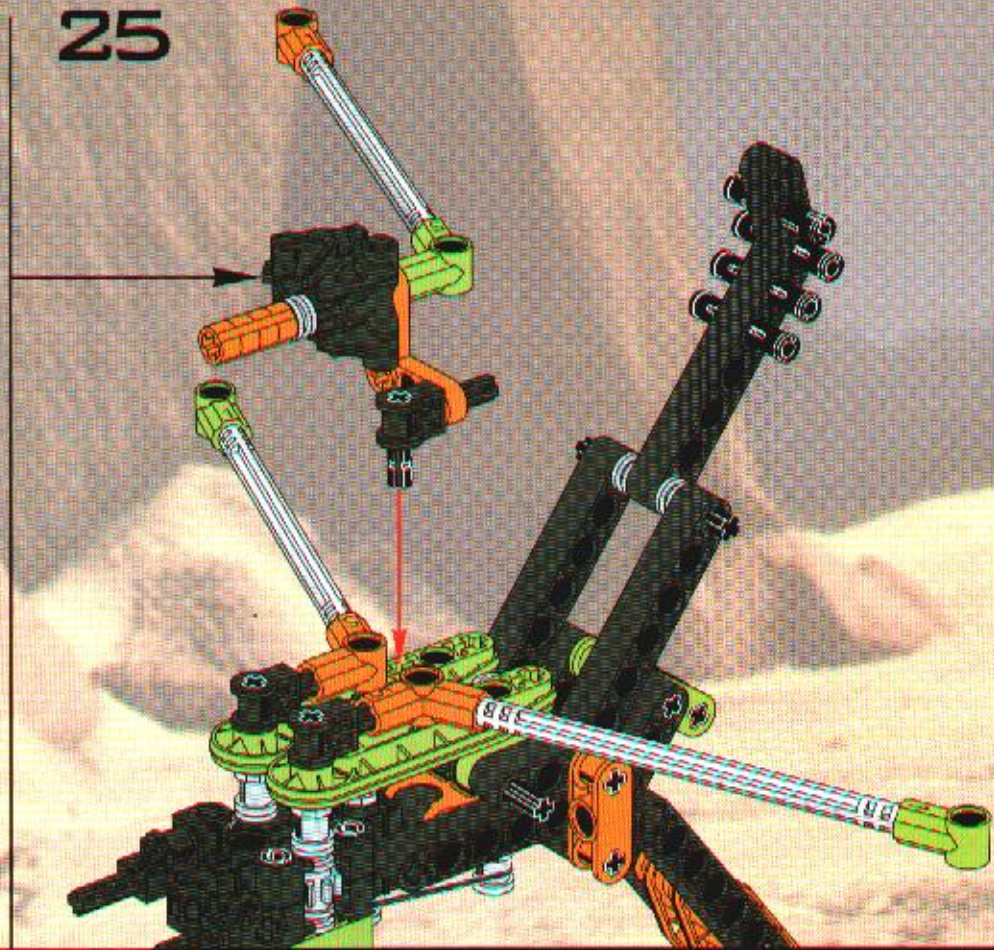

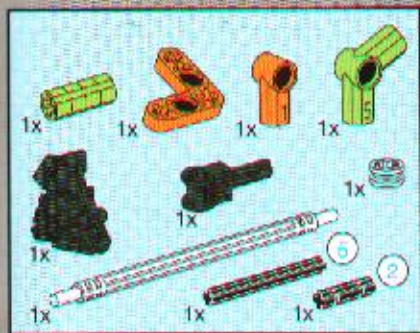

1



2

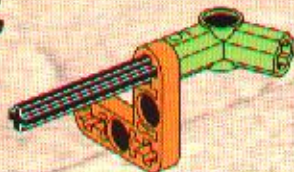

3

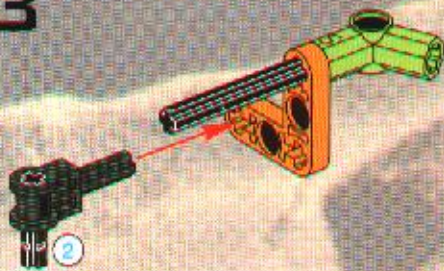

4

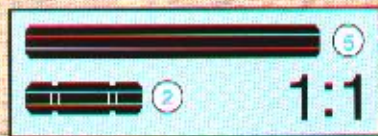

5



6

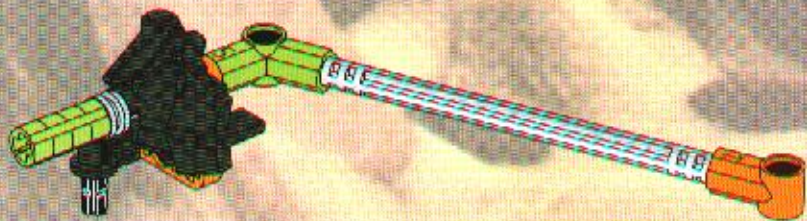

26

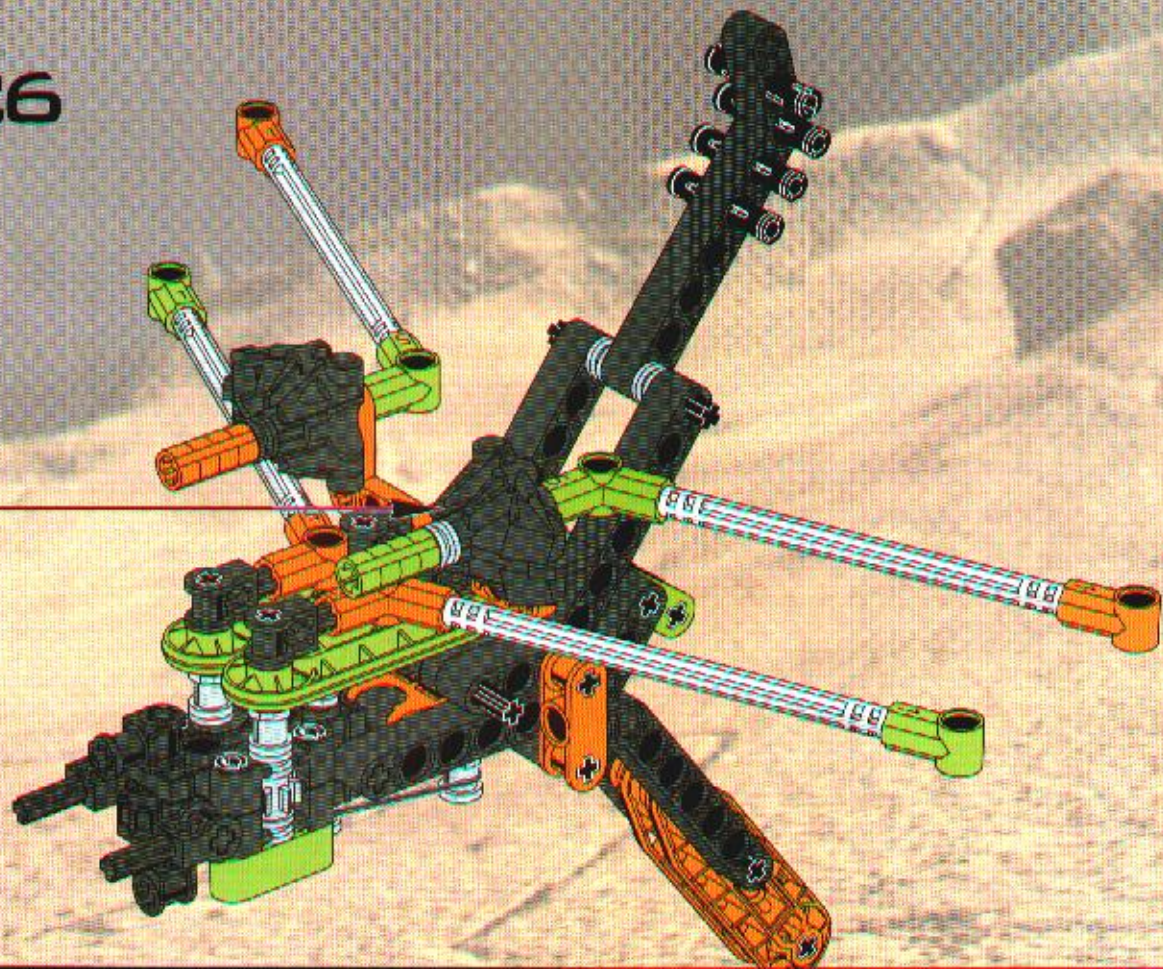

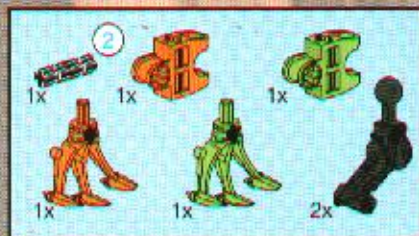

27

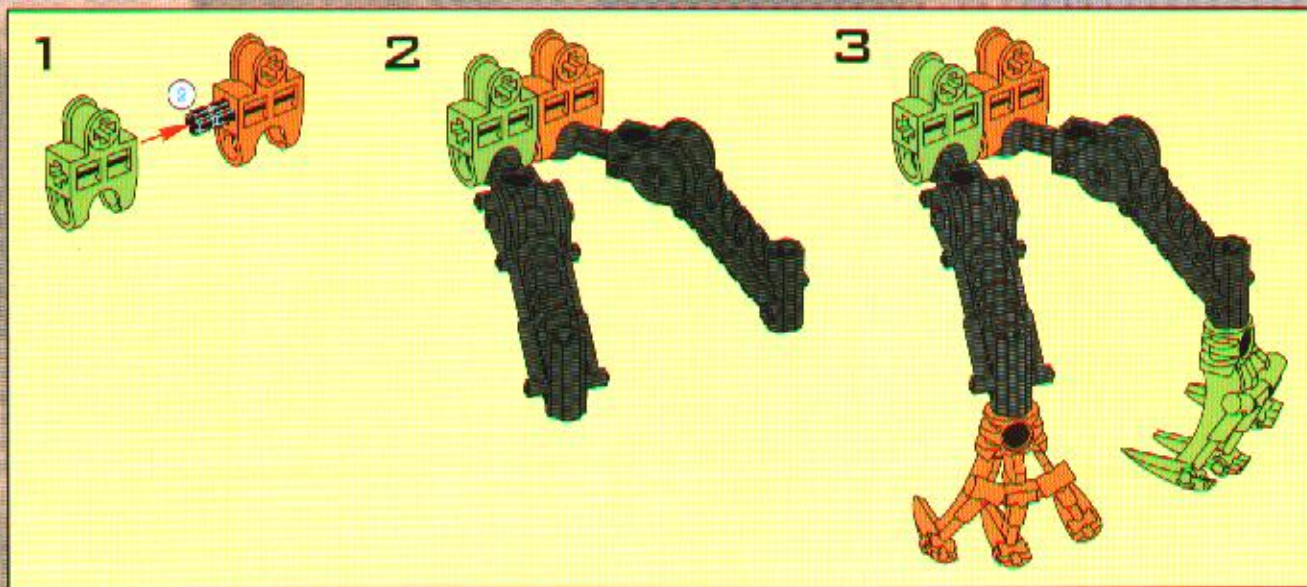

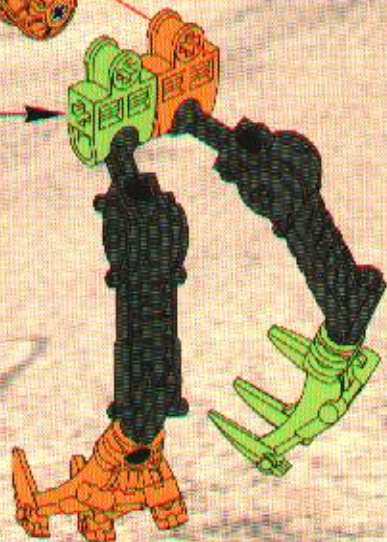
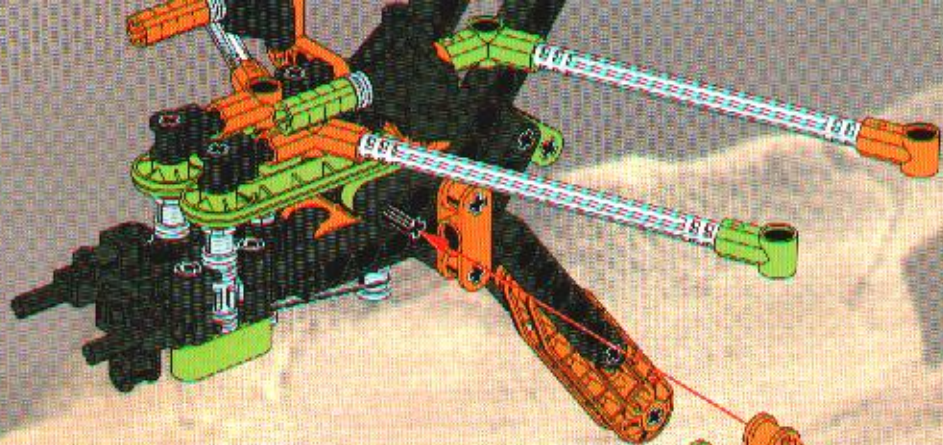

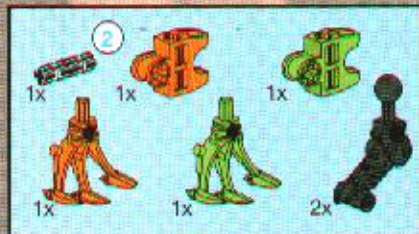

28

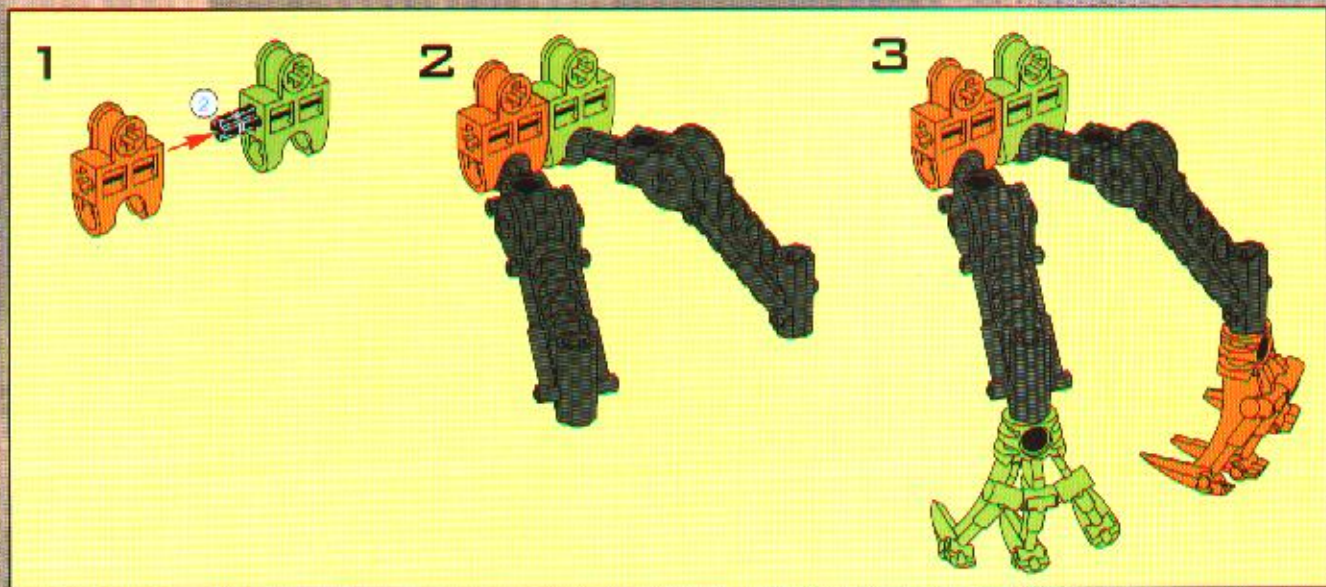

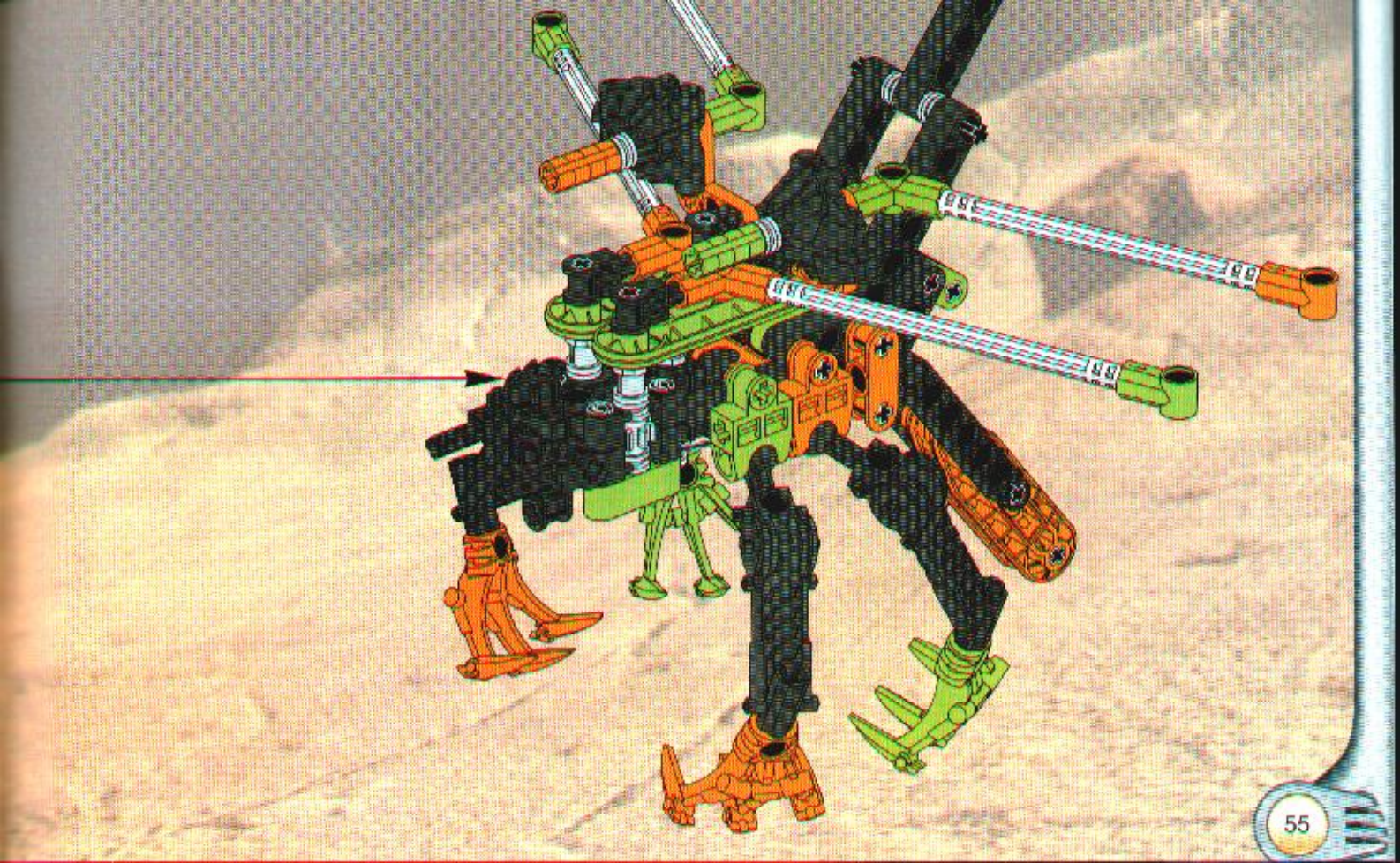

2x

29

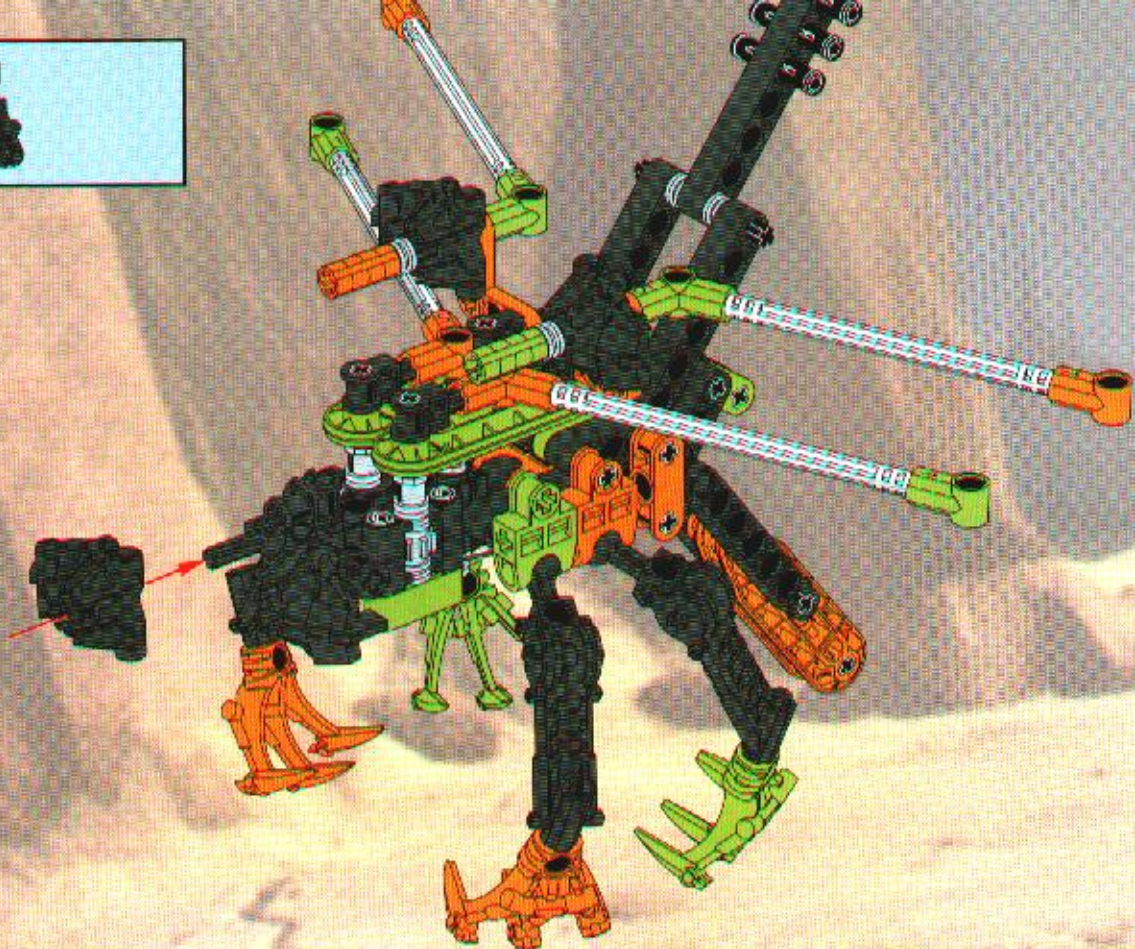



30

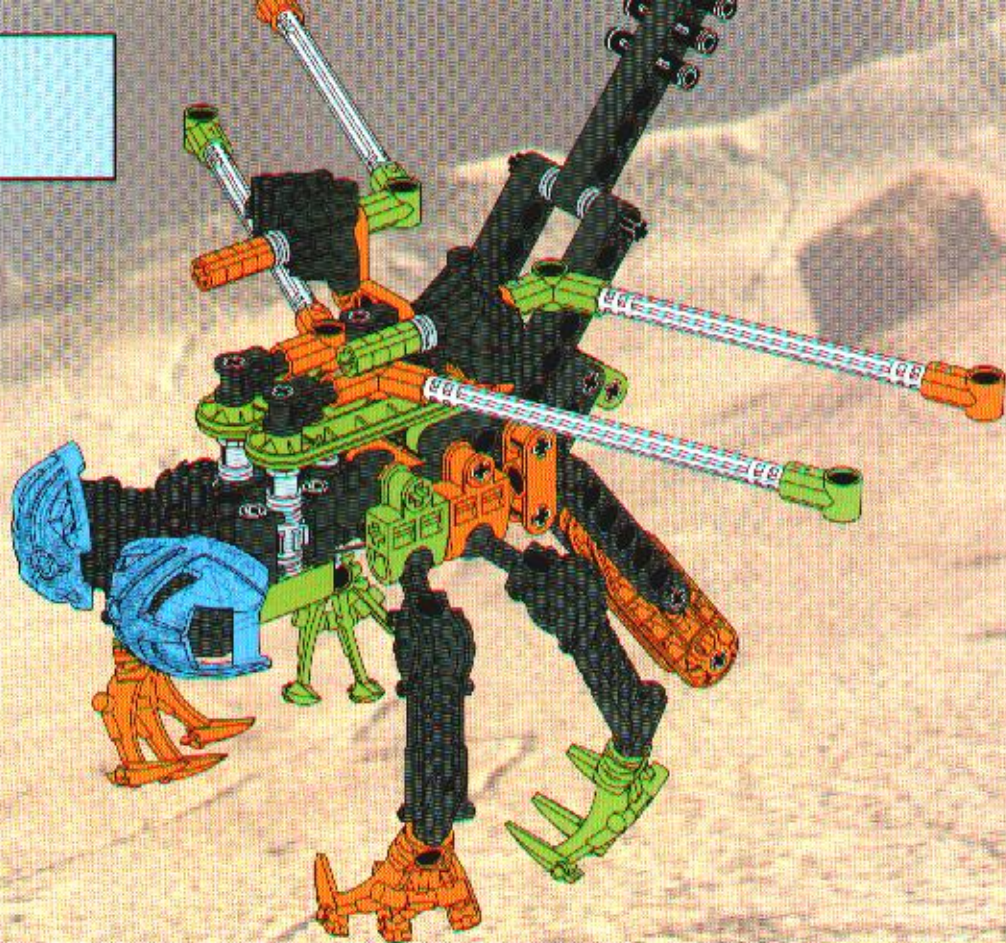



31





MURAKA & KATE RI
8338



NU-JASA
8348



TAJANAS
8337



TANAWAN
8337



NU-PATITU
8317

BIONICLE



LEWANA
8347

NOKAMA
8340

TATU
8341

MILU
8344

YAKAMA
8345

WENUA
8346



LEWA DESS
8343

NOALU DESS
8342

SU DESS
8344

NOYAWA DESS
8341

PAKARI
8340



OTUA DESS
8343

WAKA DESS
8343



LEGO
SOFT
WORLD



PC CD/DVD



UNIVERSAL



SUMMER
FUN BIKE

SUMMER
FUN BIKE

BE42
8342

BE40
8340



SUMMER
FUN

BE41
8341

LEGO

TECHNIC

www.lego.com
JOIN THE FUN!
www.lego.com/creative