



# Technic

8818



### Wichtige Tips:

Achte stets darauf, daß sich alle Achsen leicht drehen.

– Überzeuge Dich, daß Zahnräder und Buchsen ausreichend Spiel zum benachbarten Lagerelement (z. B. Lochbalken) haben (siehe Abbildungen A + B).  
– Vergewissere Dich während des Bauens, daß alle Bewegungen leichtgängig funktionieren (z. B. Kurbelwellen). Die Abbildungen C-I zeigen einige nützliche Tips zum Trennen der TECHNIC Elemente (die Abbildungen zeigen auch Elemente, die nicht unbedingt Bestandteil dieses Kastens sind).

### Consigli utili:

Sistema tutti gli assali in modo che possano muoversi liberamente.

– Fai attenzione che gli ingranaggi e le boccole non siano troppo vicini agli altri elementi. (Vedi figure A e B).  
– Controlla le funzioni regolarmente durante l'assemblaggio per verificare che funzionino.  
Osserva le illustrazioni C-I. Offrono utili informazioni su come separare gli elementi. (Alcuni elementi illustrati possono non essere inclusi nella tua confezione).

Avant de commencer, lis ces quelques conseils :  
Ajuste bien les axes pour qu'ils tournent en douceur.

– Attention que les engrenages et les bagues ne soient pas trop serrés contre les briques (Regarde les illustrations A et B).  
– Fais des essais régulièrement pendant le montage pour t'assurer que les mouvements fonctionnent normalement. Examine attentivement les illustrations C à I. Elles te donnent des informations utiles sur la manière de séparer les éléments. (Attention : certaines pièces illustrées ici peuvent ne pas faire partie de ta boîte).

### Belangrijke tips:

Verzeker je ervan dat alle assen soepel draaien.  
– Schuif tandwielen en klembuies niet te dicht tegen de techniekbalken aan (zie afbeelding A en B).  
– Test tijdens het bouwen regelmatig alle functies om je ervan te verzekeren dat alles goed werkt.  
Bekijk alle afbeeldingen C t/m I. Hierop staat afgebeeld hoe je bepaalde elementen uit elkaar kunt halen. (Het is moge-

lijk, dat niet alle afgebeelde elementjes in jouw doos voorkomen).

### Algunos buenos consejos:

Ajusta bien todos los ejes para que funcionen de una manera suave.  
– Asegúrate de que los ladrillos no estén demasiado cerca de las vigas (véanse las instrucciones A y B).  
– Prueba las funciones regularmente durante el montaje para asegurar que funcionen.  
Estudia las instrucciones de montaje C-I. Estas instrucciones incluyen información que le ayudará a la hora de separar los elementos. (Algunos de los elementos mostrados aquí no estarán incluidos en tu caja TECHNIC).

### Gode tips:

Justér alle aksler, så de går let.  
– Pas på, at tandhjul og bøsninger ikke sidder for tæt på bjælkerne (se tegning A & B).  
– Afprov funktionerne regelmæssigt under bygningen for at sikre, at de fungerer.  
Se tegning C-I, som viser, hvordan man skiller elementerne ad. (Det er ikke sikkert, at alle de viste elementer er i din model.)

### Building Hints:

Adjust all axles so they run smoothly.  
– Ensure that gear wheels and bushes are not too close to the beams (see illustrations A and B).  
– Check technical functions regularly during assembly of the model.  
Illustrations C-I give useful information on how to separate elements. (Some elements shown may not be included in your set.)

Kiinnitä akselit niin, että ne pyörivät hyvin ja esteettä.

– Huolehdi siitä, etteivät hammaspyörät ja halkit ole liian lähellä paikkaa (katso kuvia A ja B).  
– Kokeile toimintoja aina välillä kokoonpanon aikana varmistaaksesi, että kaikki toimii niin kuin pitää.  
Tutki kuvia C-I. Saat niistä hyödyllistä tietoa elementtien irrottamisesta toistaan. (Kaikki kuvissa näkyvät elementit eivät välttämättä sisälly tähän rasiaan.)



### Några goda råd om din TECHNIC modell:

Justera alla axlar så att de fungerar utan att ta emot någonstans.  
– Se till att kugghjul och bussningar inte sitter för nära klossarna (se bilderna A och B).  
– Prova funktionerna då och då under monteringen för att vara säker på att de fungerar.  
Studera bilderna C-I. Där hittar du viktig information om hur du skall ta isär de olika delarna. (Det kan hända att din ask inte innehåller alla de delar som visas på bilderna.)



Alguns bons conselhos: Ajuste bem todos os eixos para que se movam facilmente.

– Tenha cuidado para que as rodas dentadas e chumaceiras não fiquem demasiado perto das pedras (veja ilustrações A e B).  
– Ensaie regularmente as funções durante a montagem para se certificar que funcionam.  
Estude as ilustrações C-I. Elas incluem informações úteis sobre a maneira de separar os elementos. (Alguns dos elementos que se mostram podem não fazer parte do seu conjunto).



Προσαρμόστε όλους τους άξονες των τροχών έτσι ώστε να κινούνται ομαλά.

– Προσέχετε οι τροχοί και οι σύνδεσμοι να μη βρῆσκόνται πολύ κοντά στα τουβλάκια (βλέπε εικονογράφηση Α και Β).  
– Ελέγχετε τακτικά τις λειτουργίες κατά τη διάρκεια της κατασκευής ώστε να είστε σίγουροι ότι δουλεύουν. Μελετήστε τις εικονογραφήσεις C-I. Περιέχουν μερικές χρήσιμες πληροφορίες για το πώς χωρίζονται τα στοιχεία. (Μερικά στοιχεία που φαίνονται, εδώ μπορεί να μην περιλαμβάνονται στο δικό σας κιτ.)



レゴ® テクニクをお買上げいただきありがとうございます。組み立てる前に次の注意事項をお読みください。

モデルの機械的な機能を正常に達成してください。  
– 軸がすべてスムーズに動くように取り付けてください。  
– ギアとストッパーはあまりグロックにくっつけて取り付けないようにしてください(図のAとBを参照)。  
– 組み立てた部分が正しく動くかチェックしながら、モデルを組み立ててください。パーツのはずし方のヒントとして、図のC-Iを参考にしてください。(この説明書には、このセットに含まれない部品も参考として使われています。)

Before you begin building your model, please read these instructions carefully.  
– Make sure that the gears and bushes are not too close to the beams (see illustrations A and B).  
– Test the functions regularly during assembly to make sure they work properly.  
Study illustrations C-I. They contain useful information on how to separate the parts. (Some parts shown may not be included in your set.)

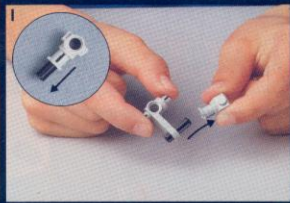
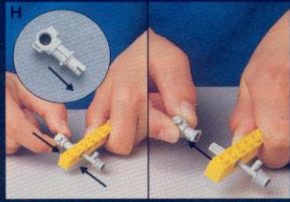
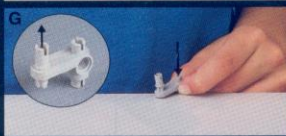
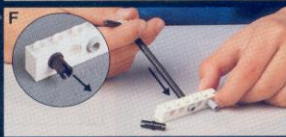
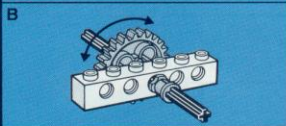
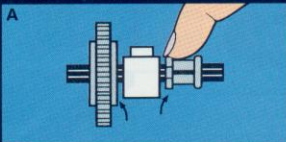

**LEGO** Technic

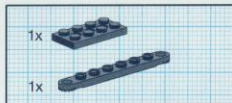
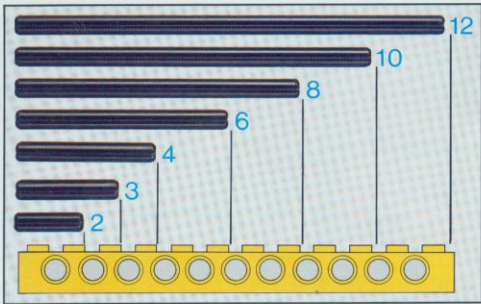

**1**



**2**

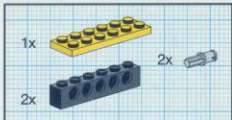

**3**

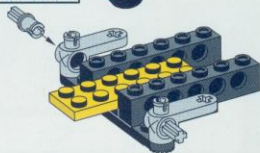



**4**

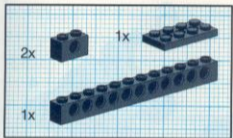

**5**

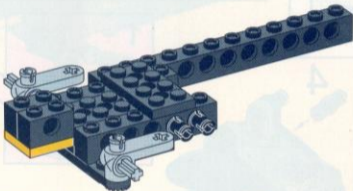

**6**

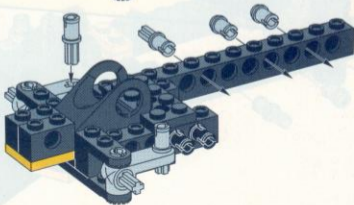

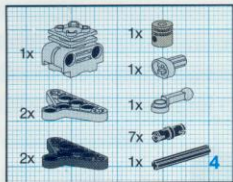

7

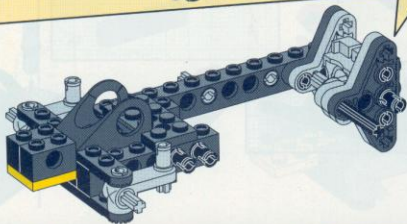
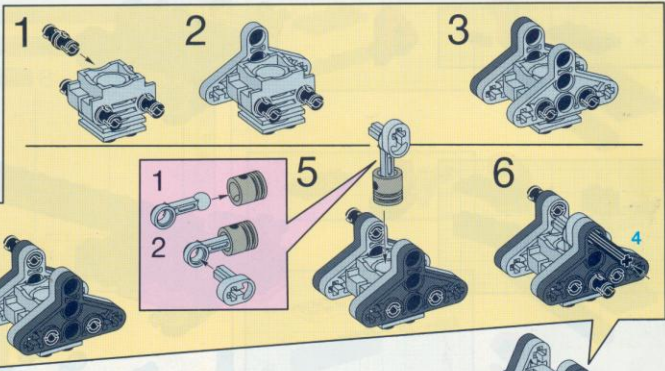

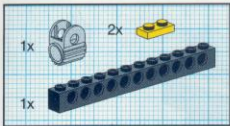

8

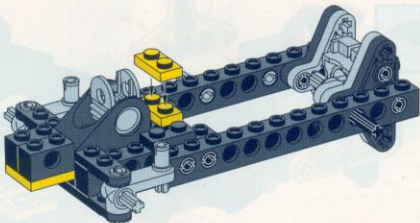

9

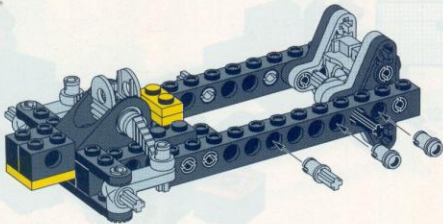

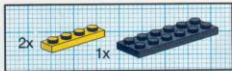

10

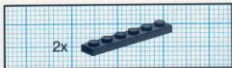
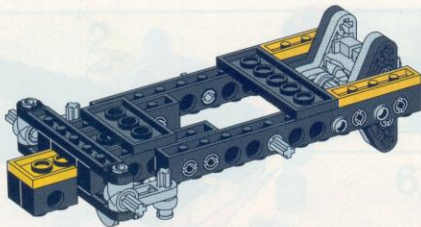

11

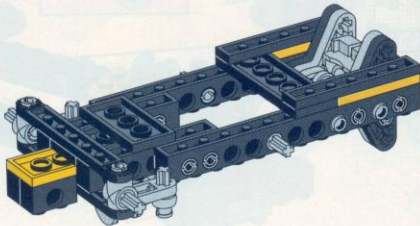



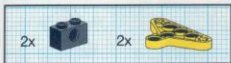

**12**

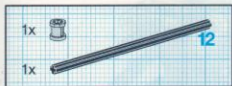
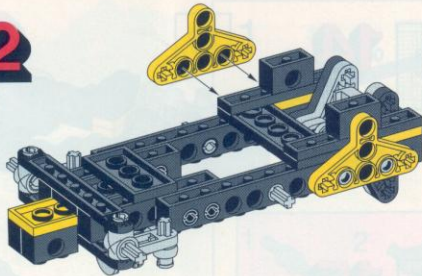

**13**

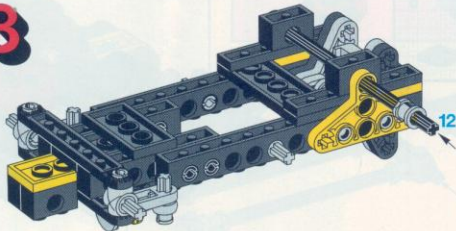

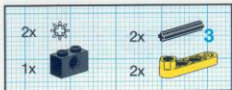

# 14

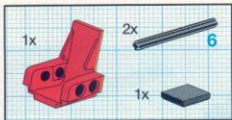
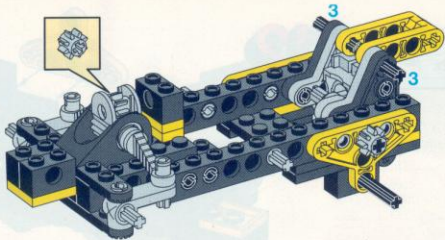

# 15

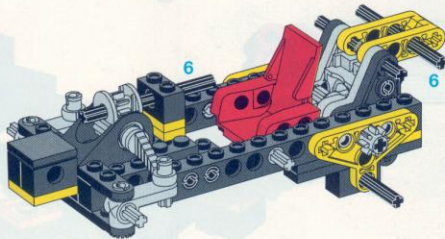

# 16

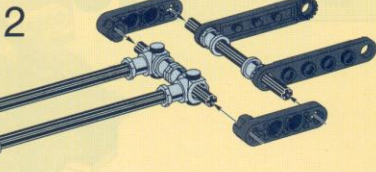
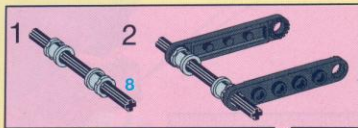
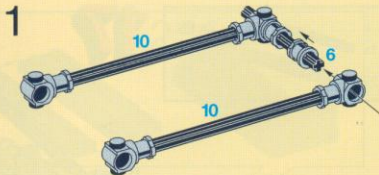
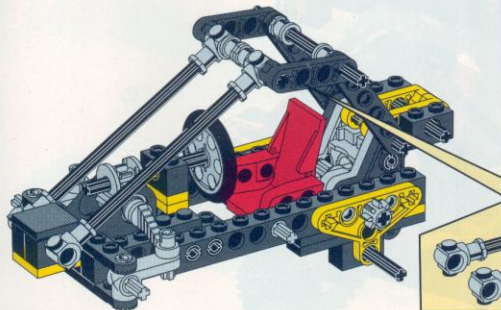



# 17

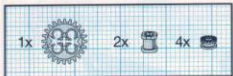
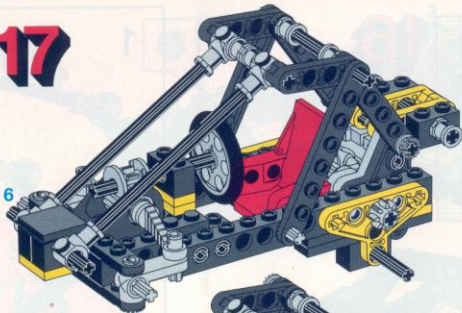

# 18

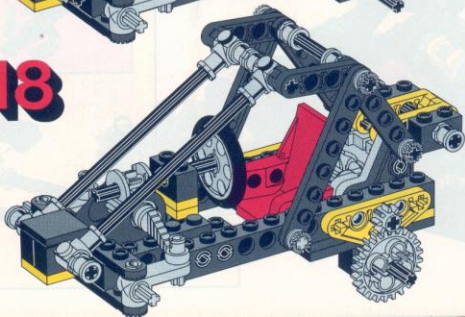

# 19

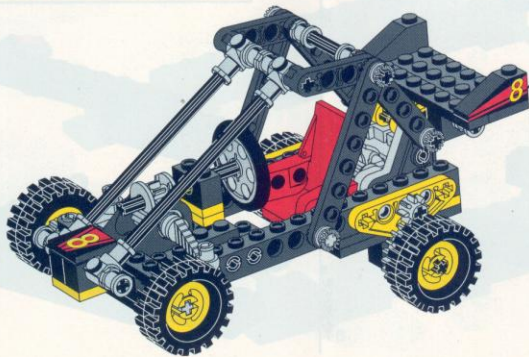
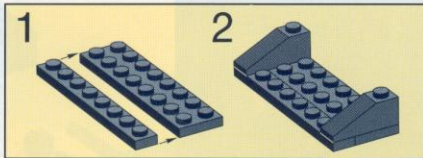
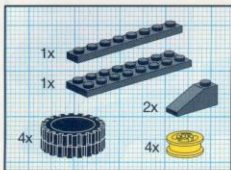

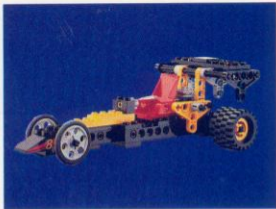

1

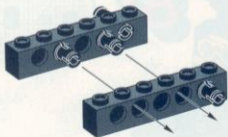

2

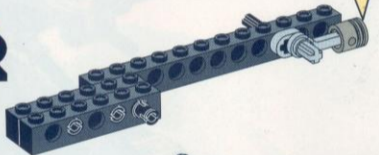

3



4

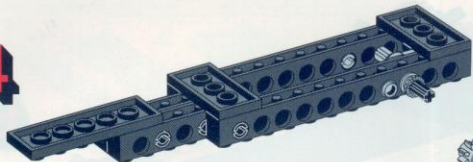

5



6



7



8

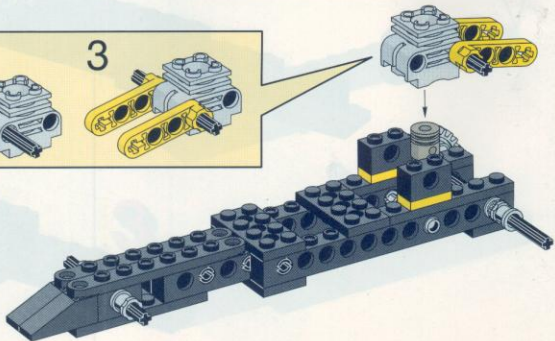



9

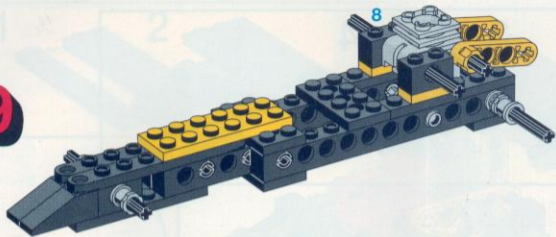

10

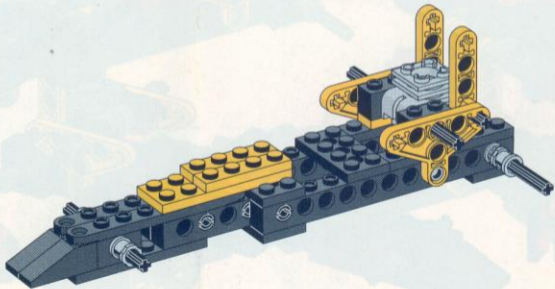

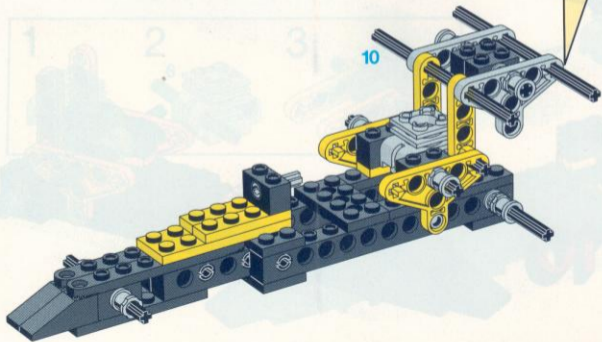
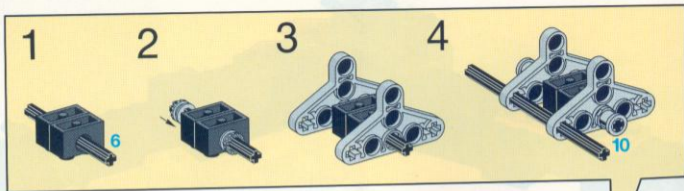

11

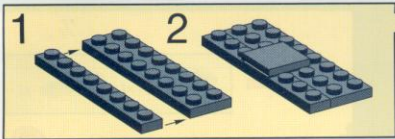

12

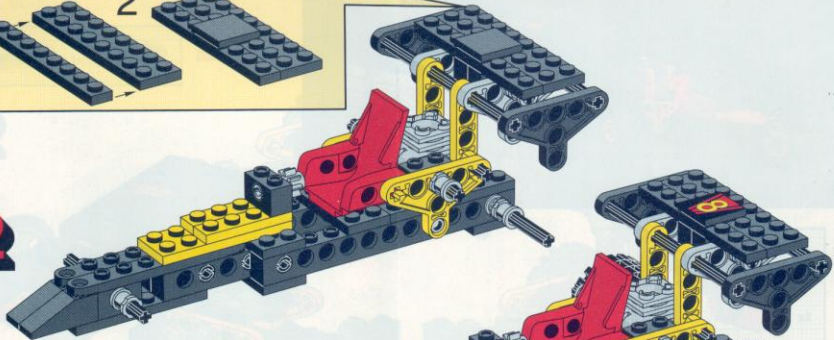

13

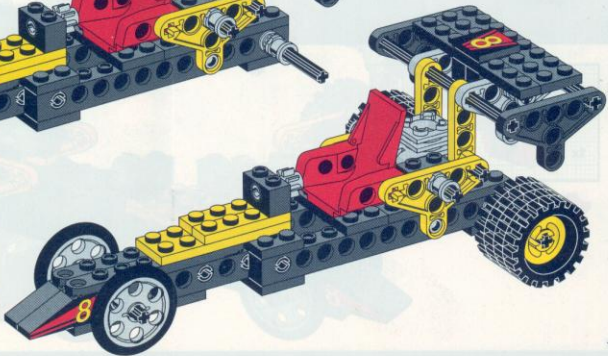

8818+8720

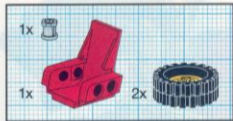

1

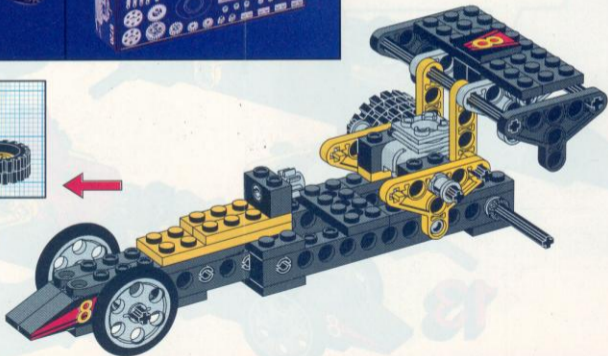

8818+8720

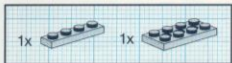

2

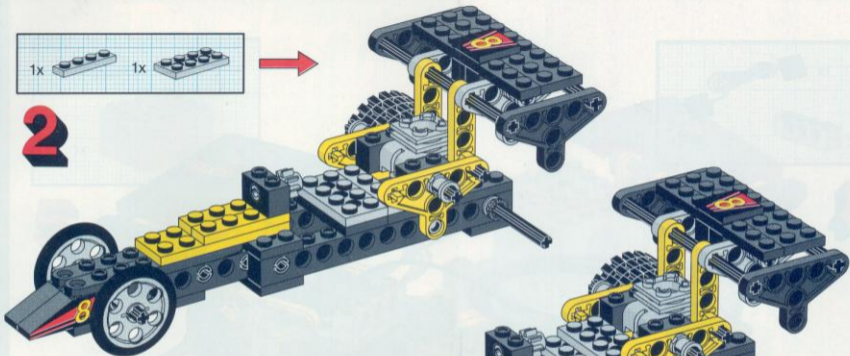

3

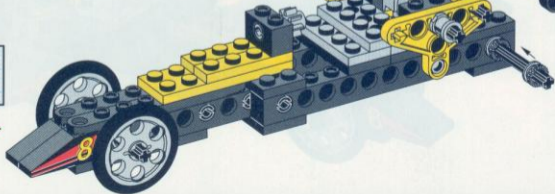

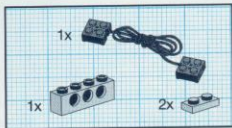
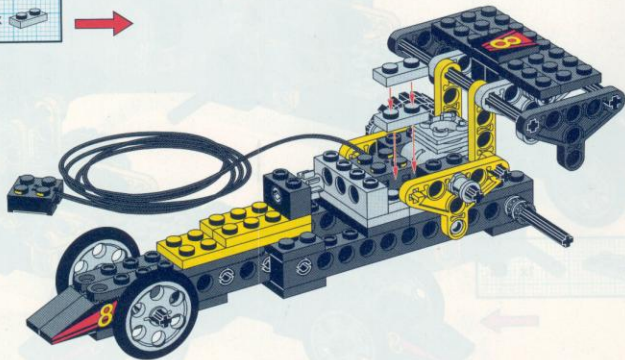
**4**

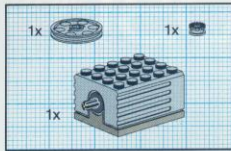
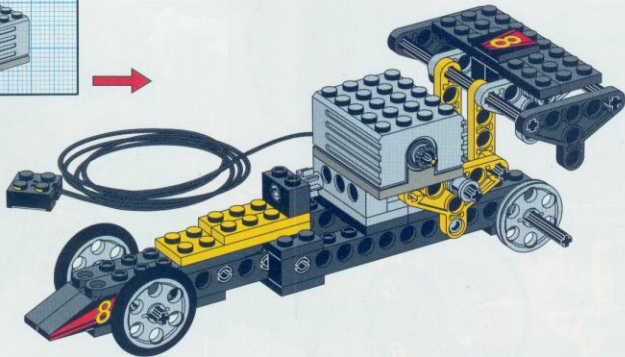
**5**

8818+8720



6

