

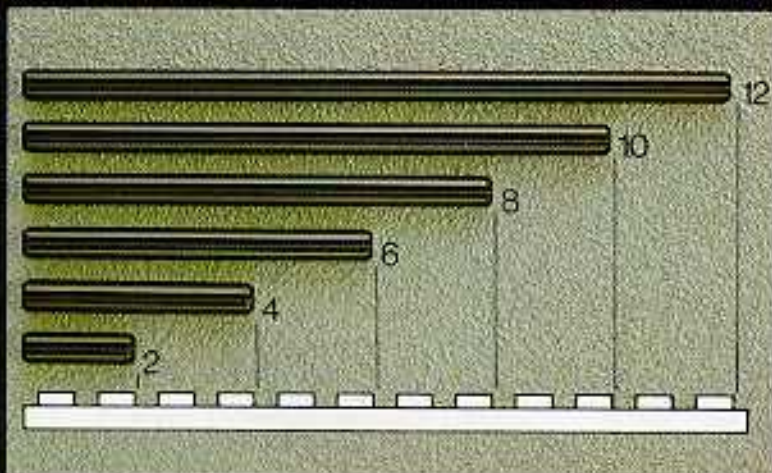

120057



In der Bauanleitung steht vor den Achsen eine Zahl, die die benötigte Länge der Achsen anzeigt.

Numbers in the building instructions near axles show the length of axle to be used.

Dans les conseils de construction, il y a un chiffre à côté de chaque axe. Ce chiffre indique la longueur des axes à utiliser.

Ut for akslerne i byggeanvisningen er anført et tal som viser hvilken aksellengde som skal brukes.

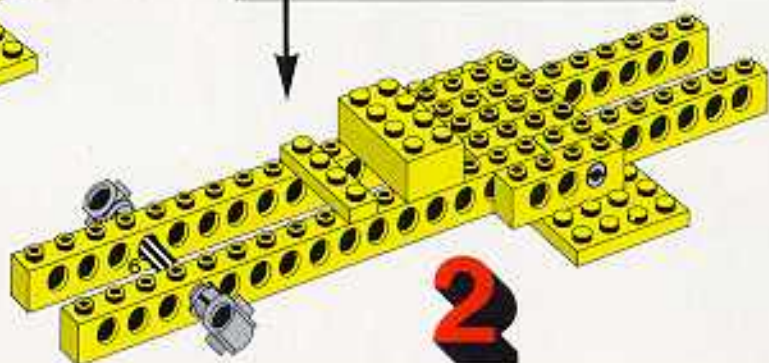
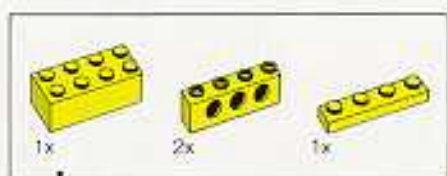
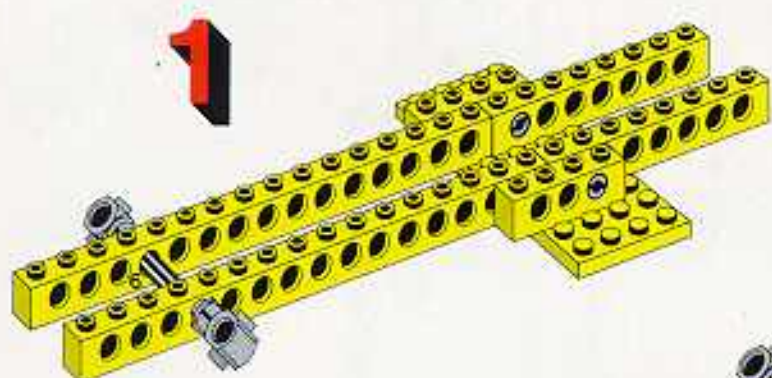



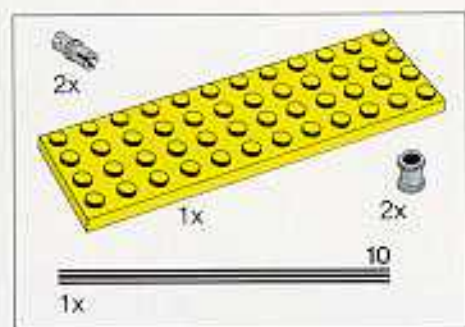
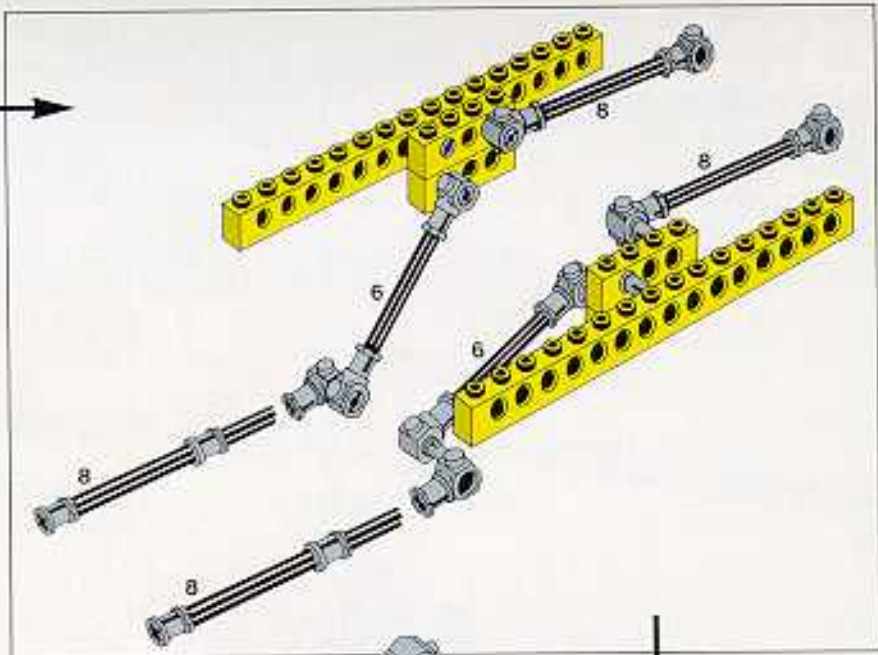
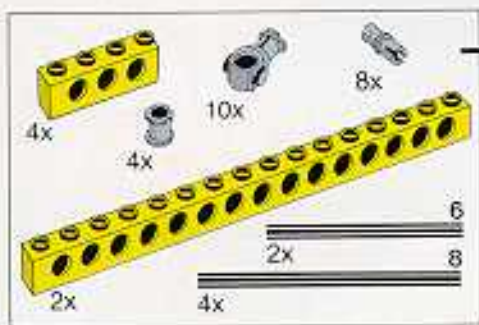

**3**

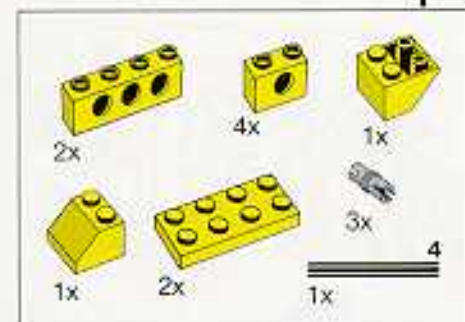
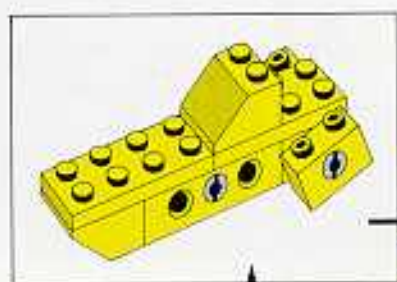
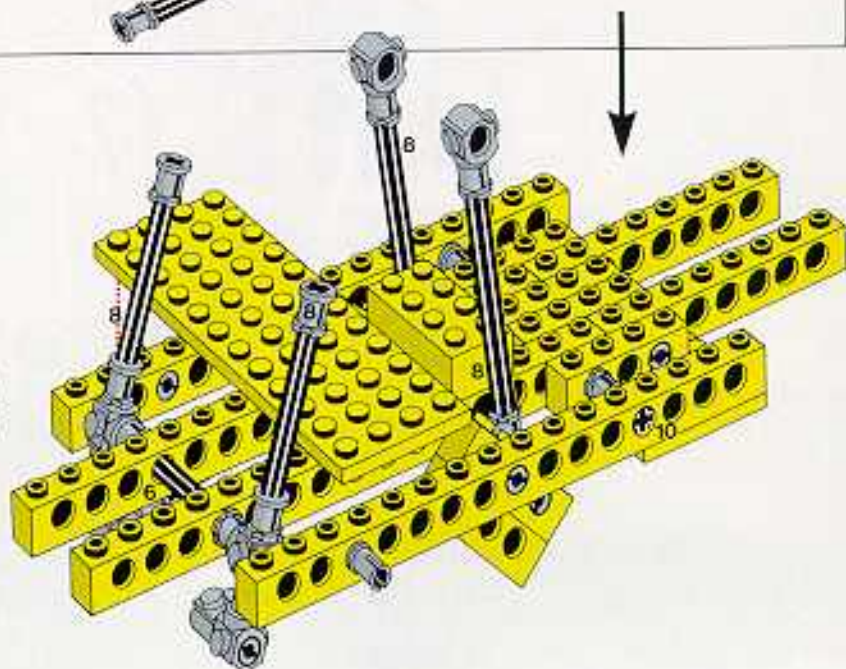

**4**

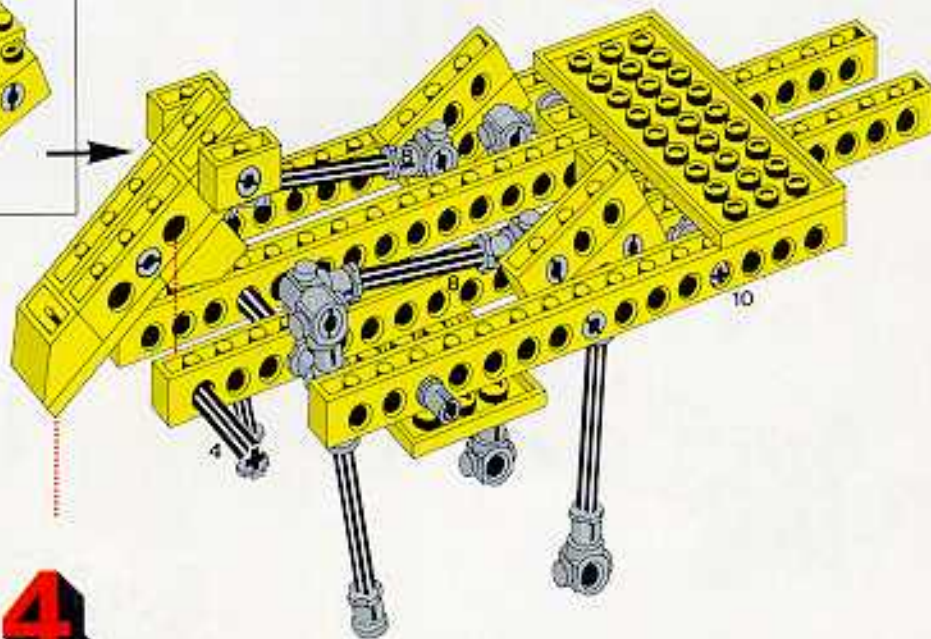



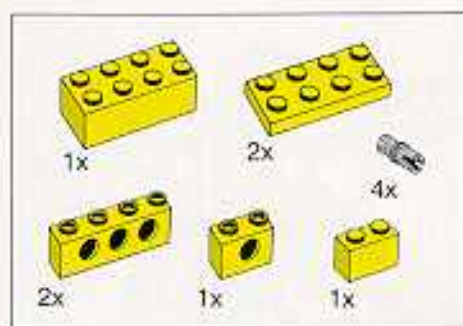

5

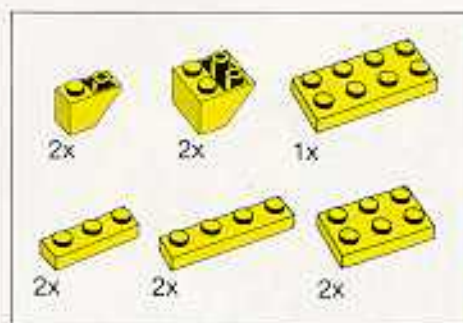
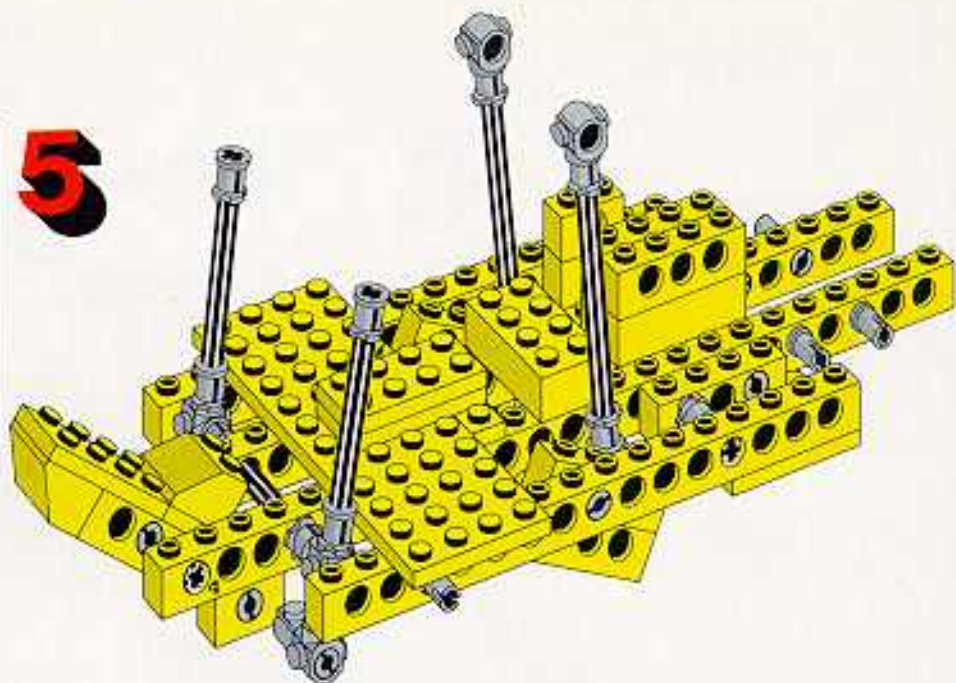

6

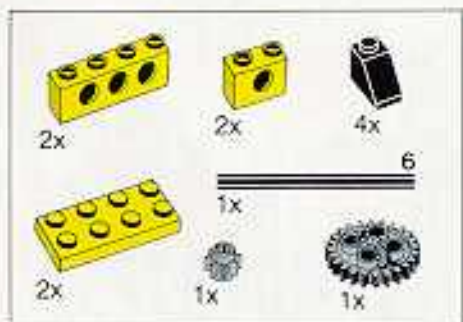
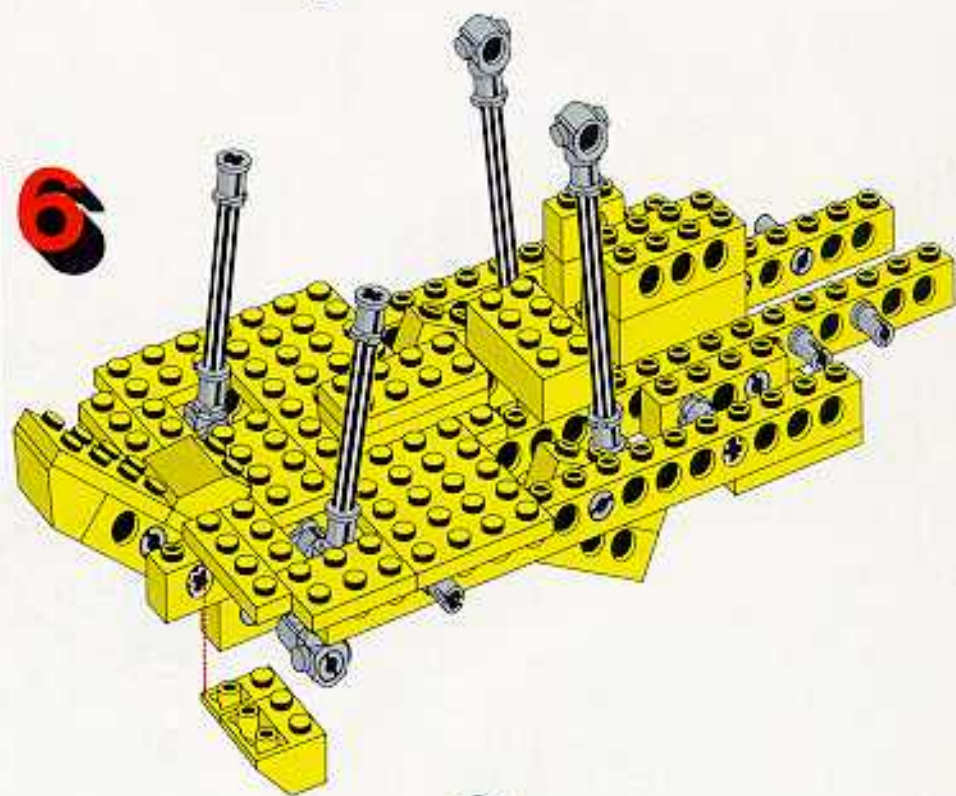

7

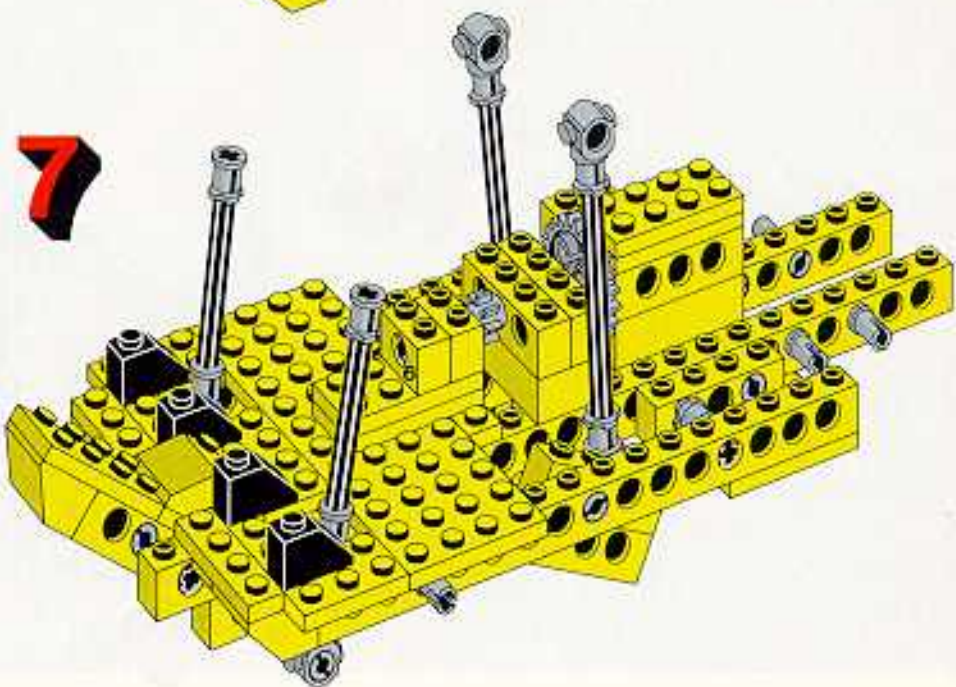



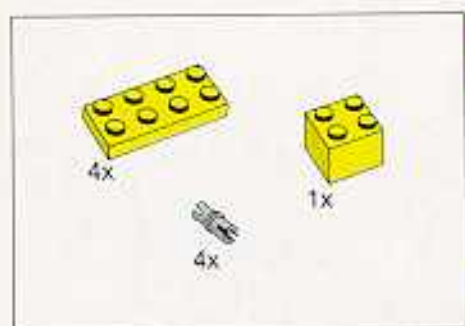

**8**

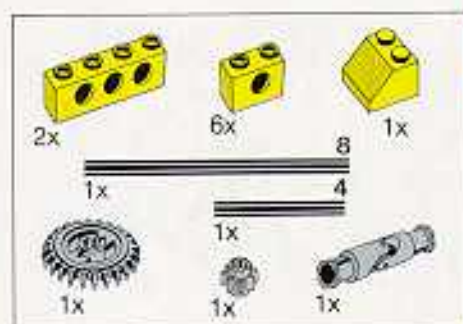
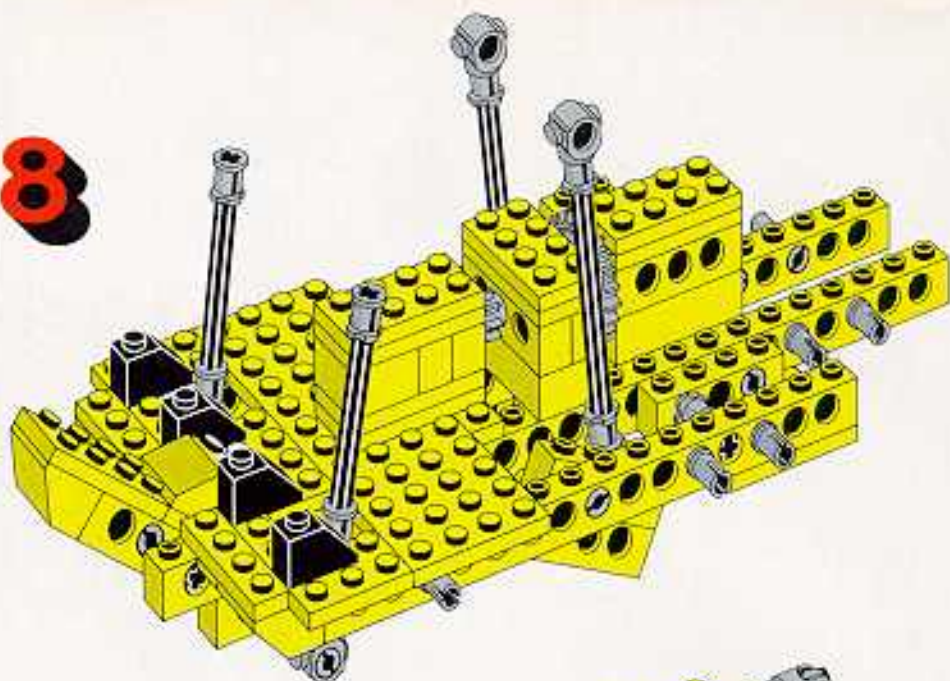

**9**

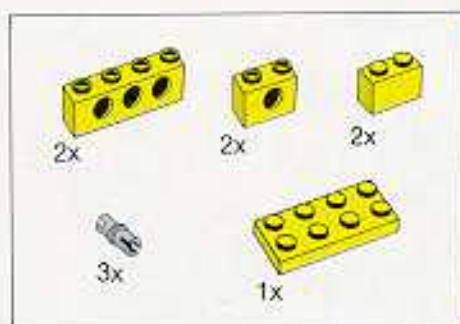
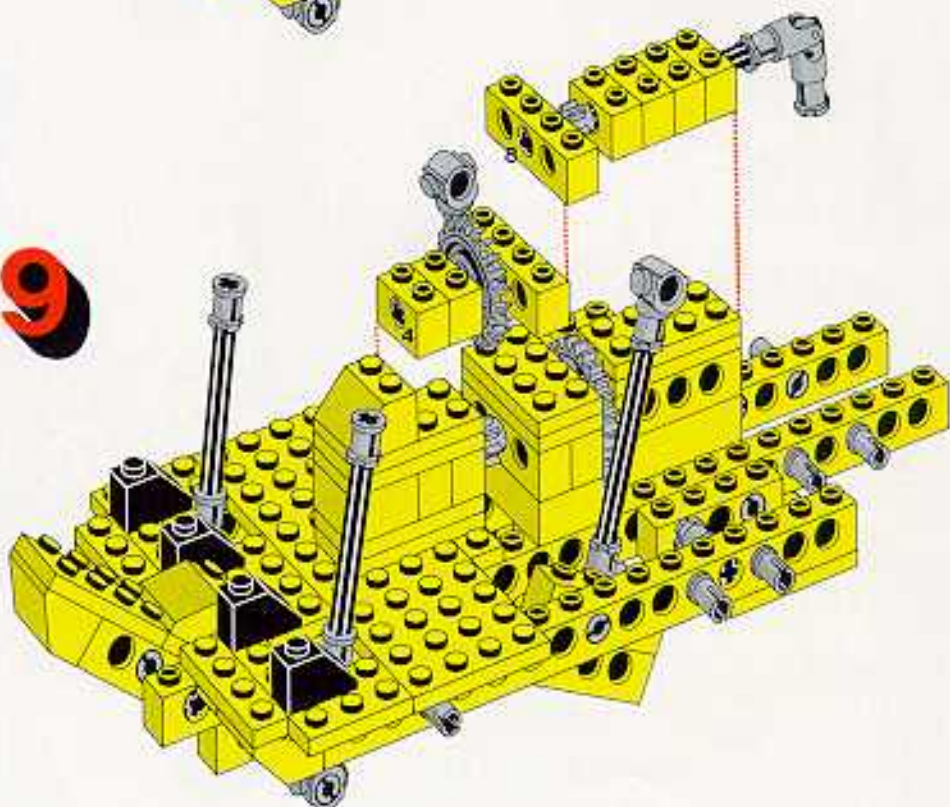

**10**

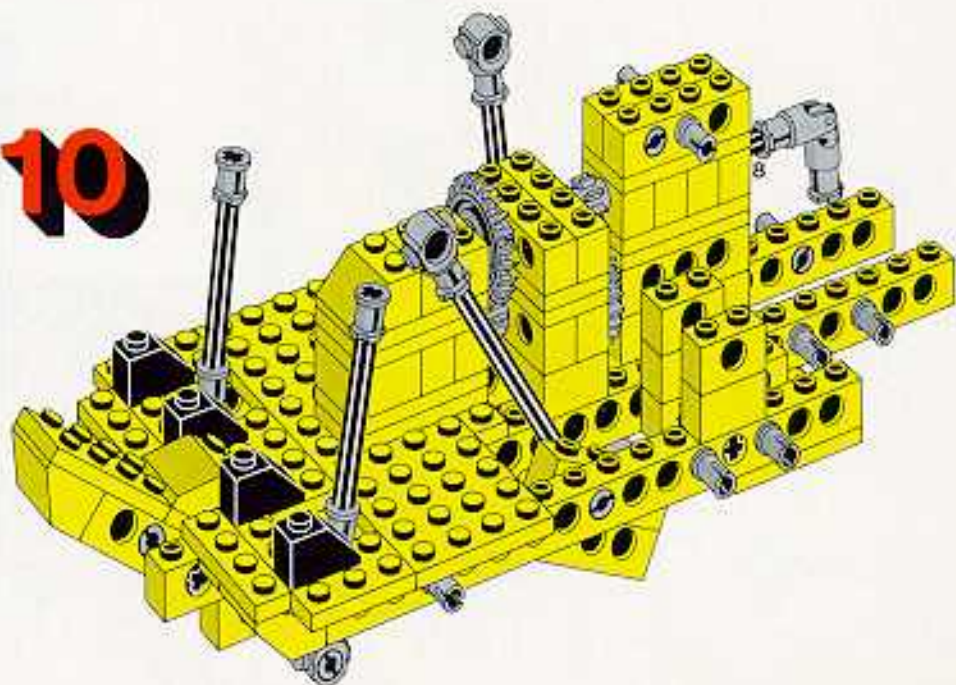



11

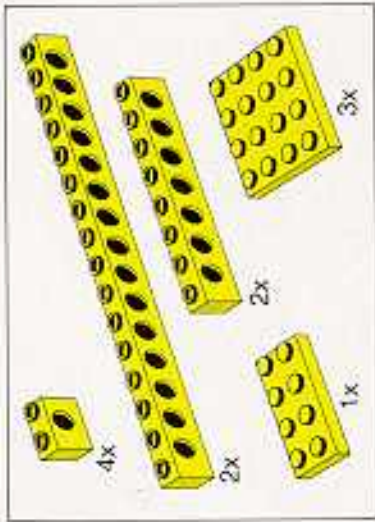
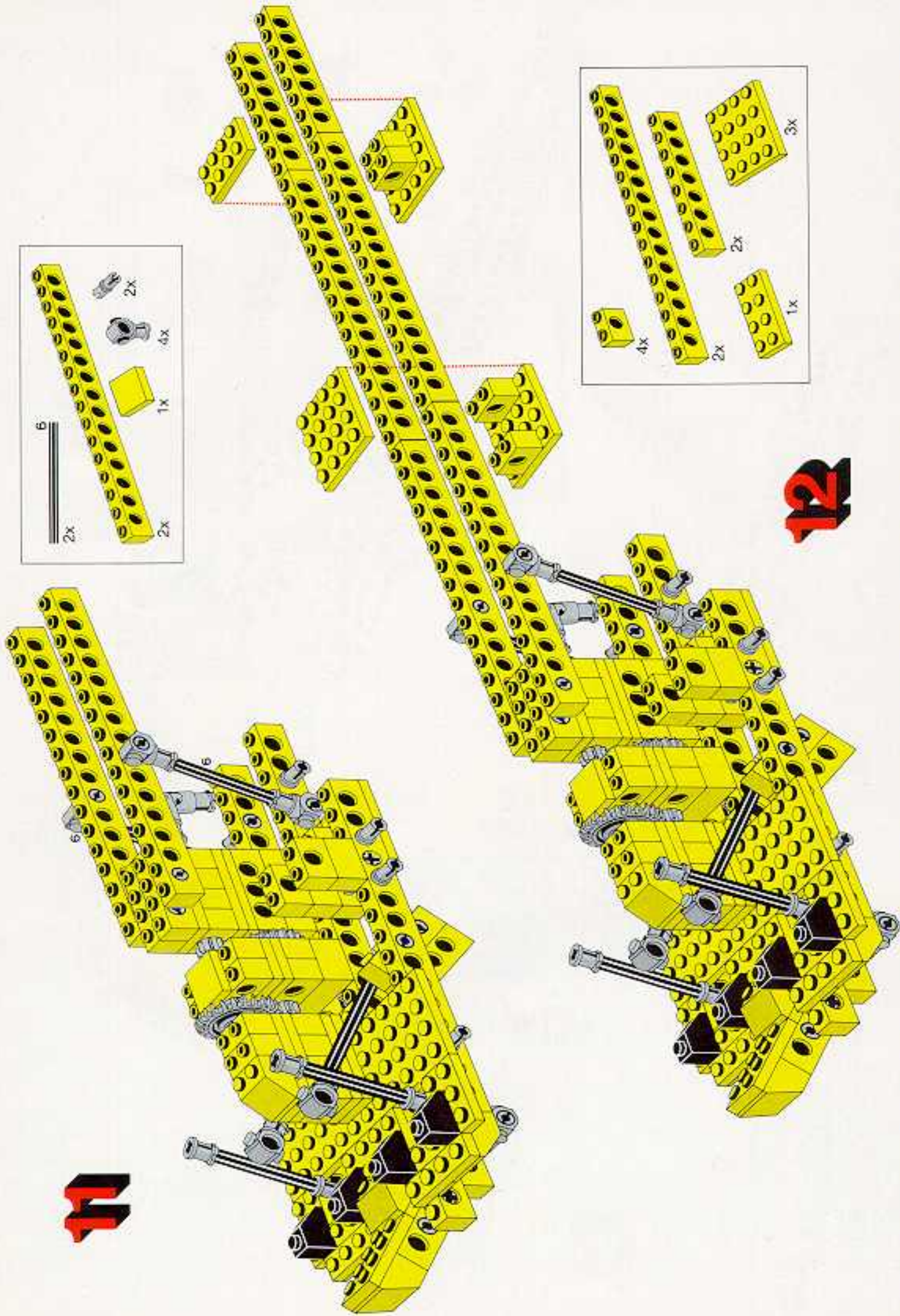

12



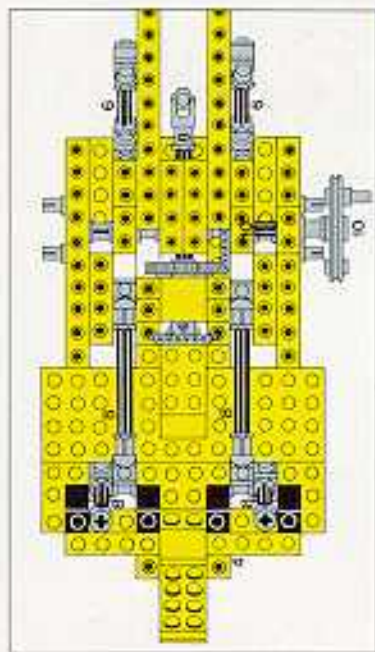

13

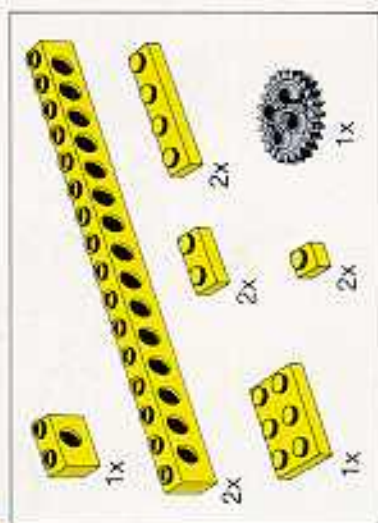
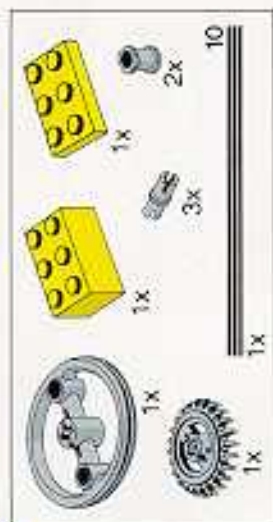
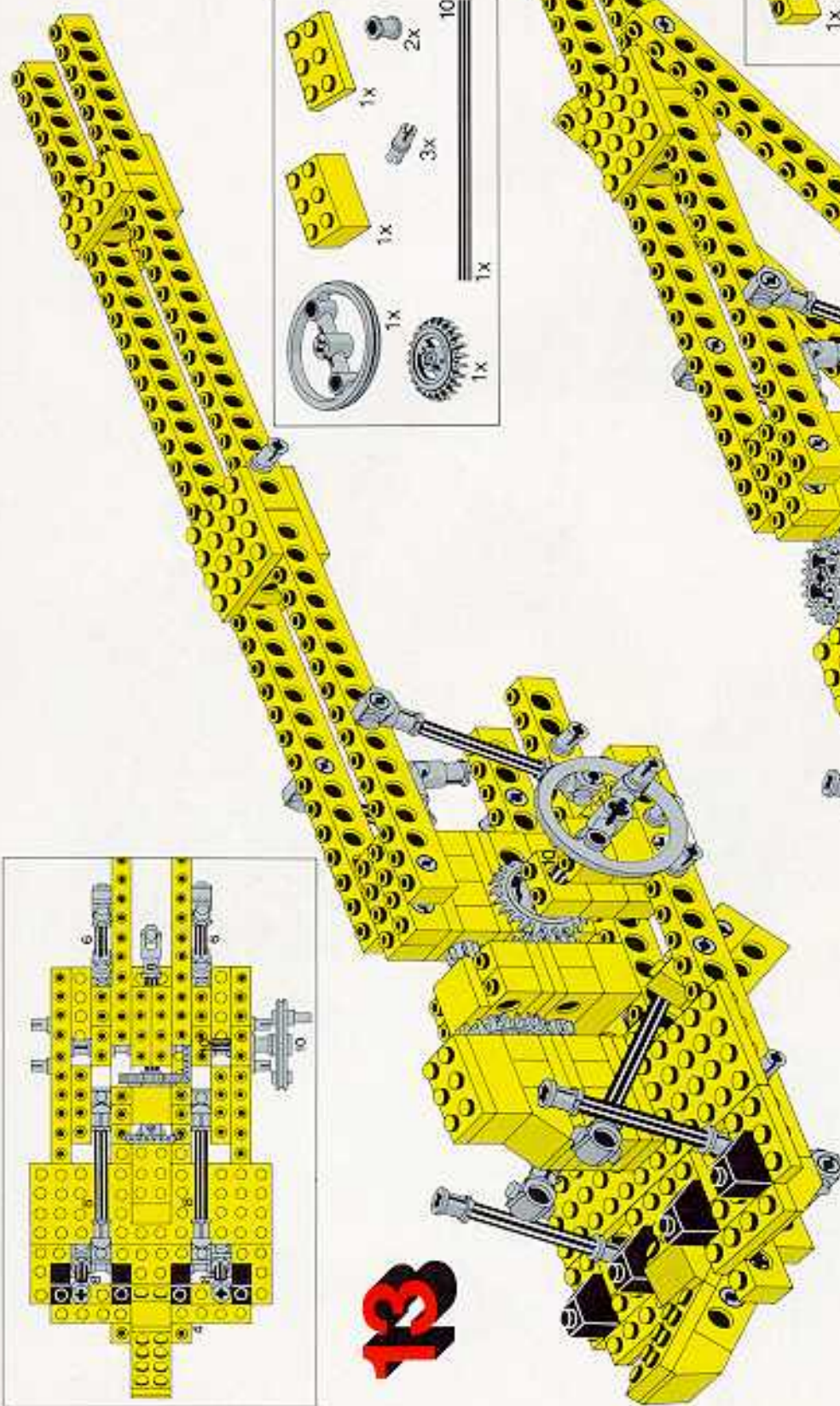

14

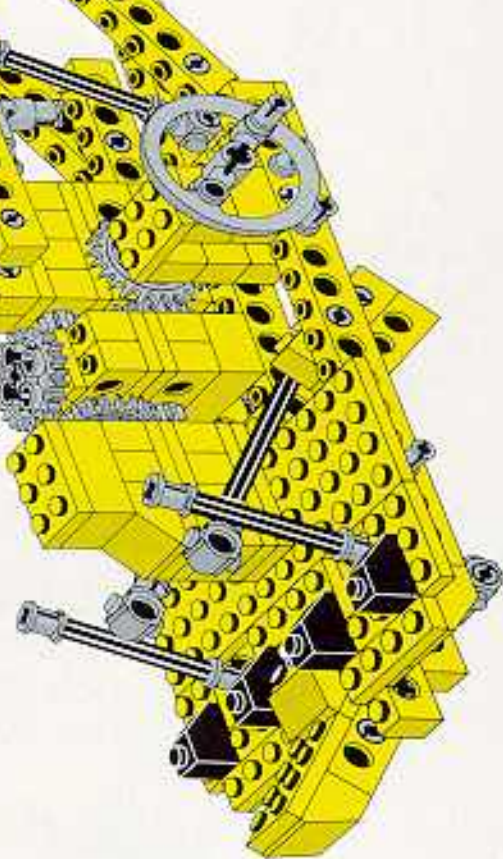



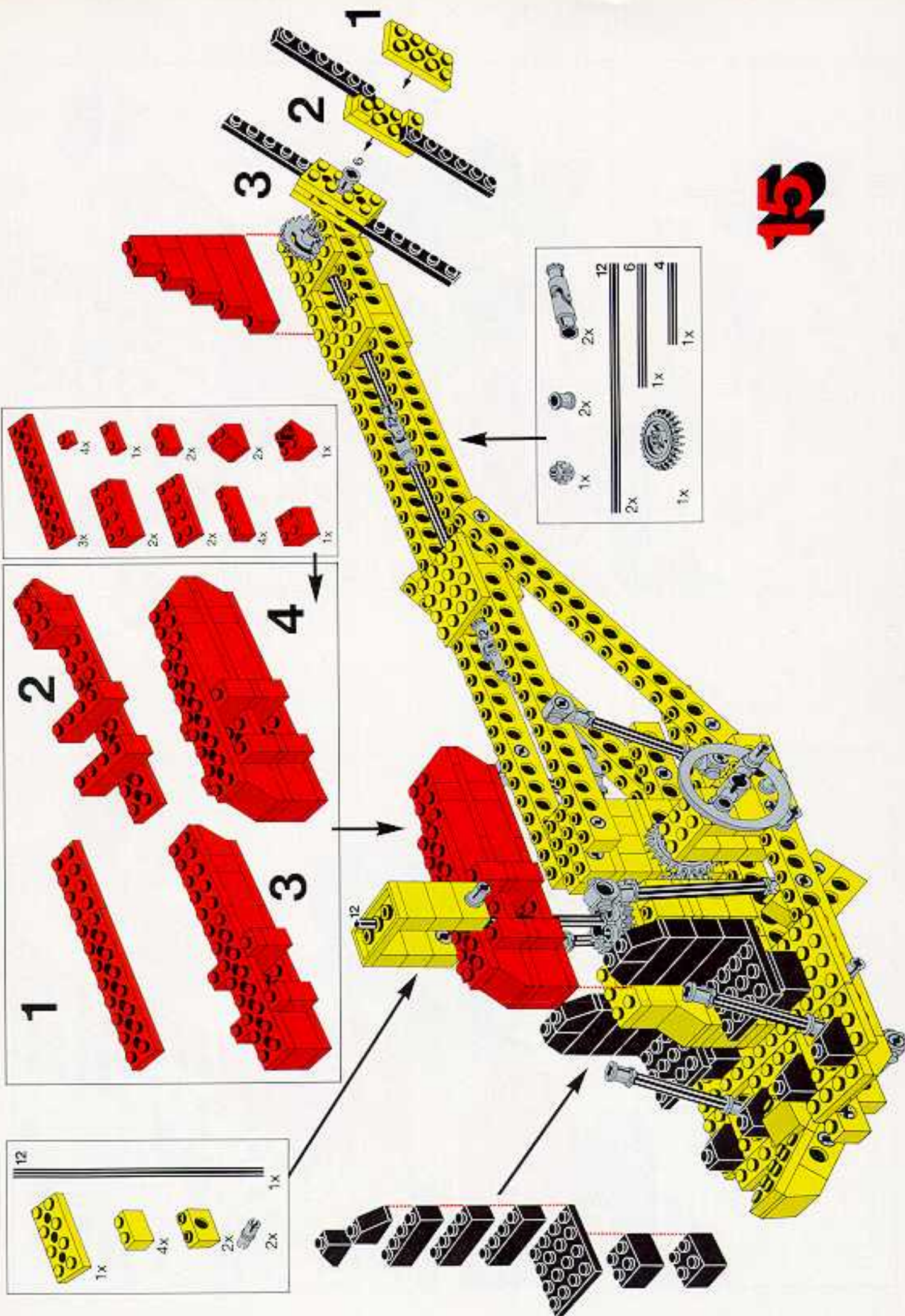



16

- 3x
- 2x
- 2x
- 2x
- 4x
- 6x
- 2x

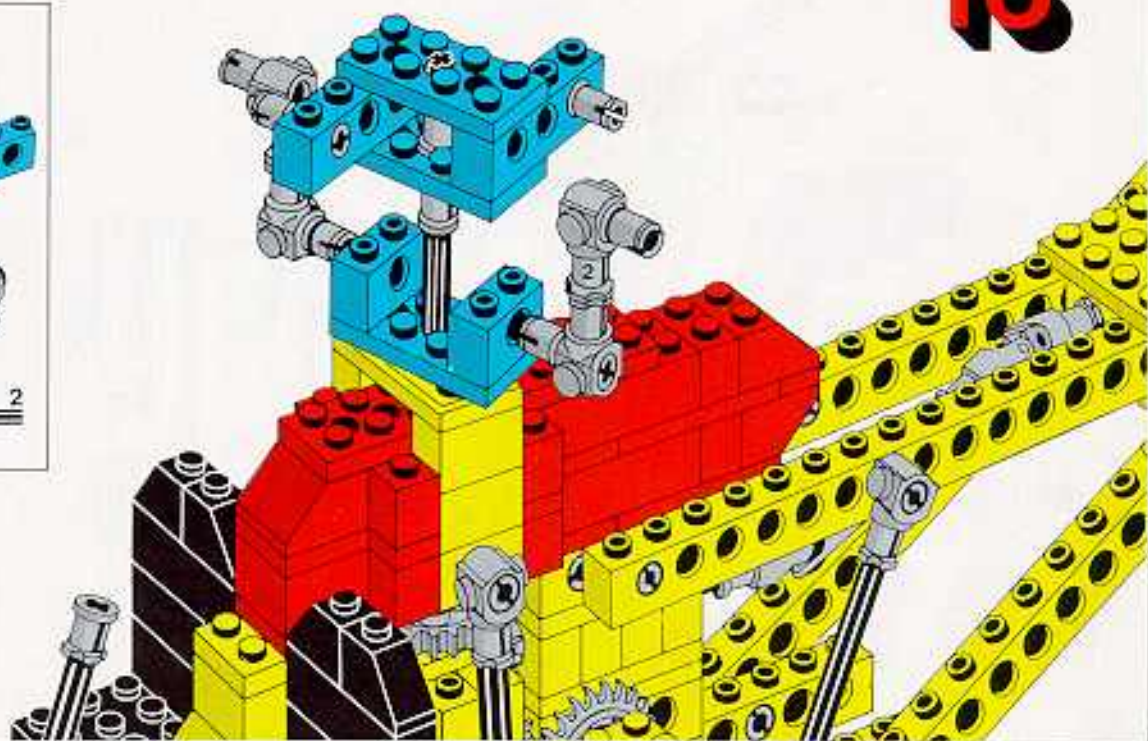

17

- 2x
- 2x
- 6x

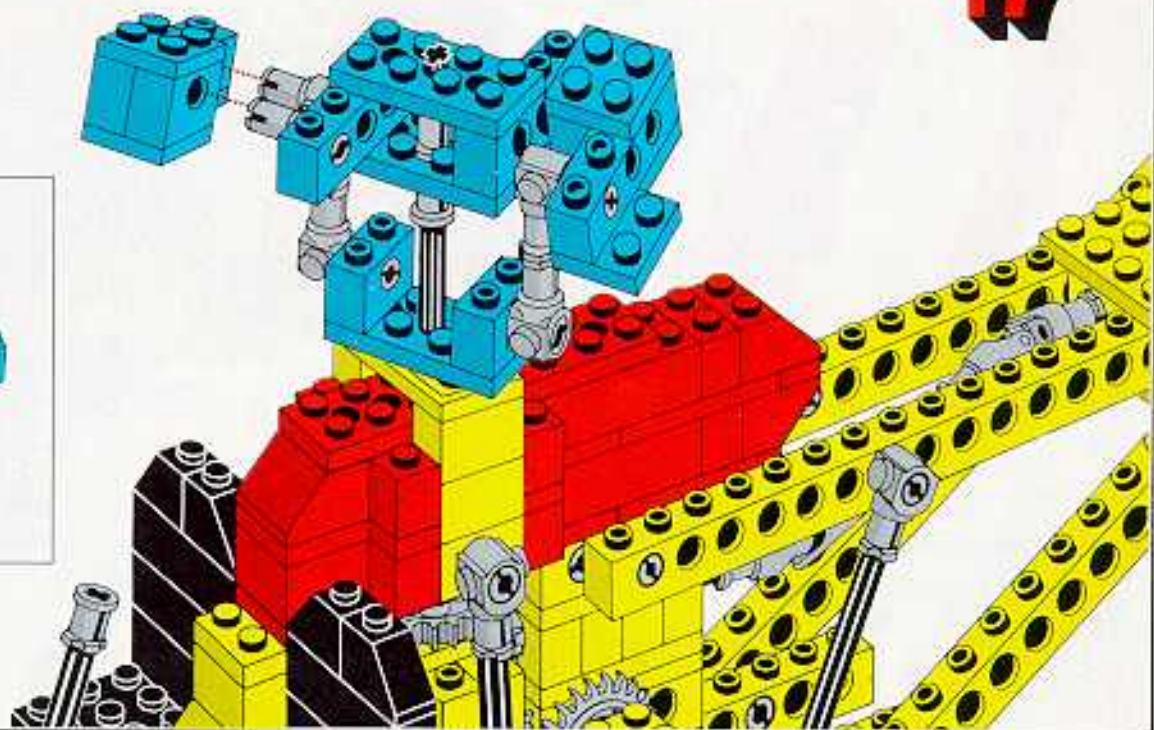



18

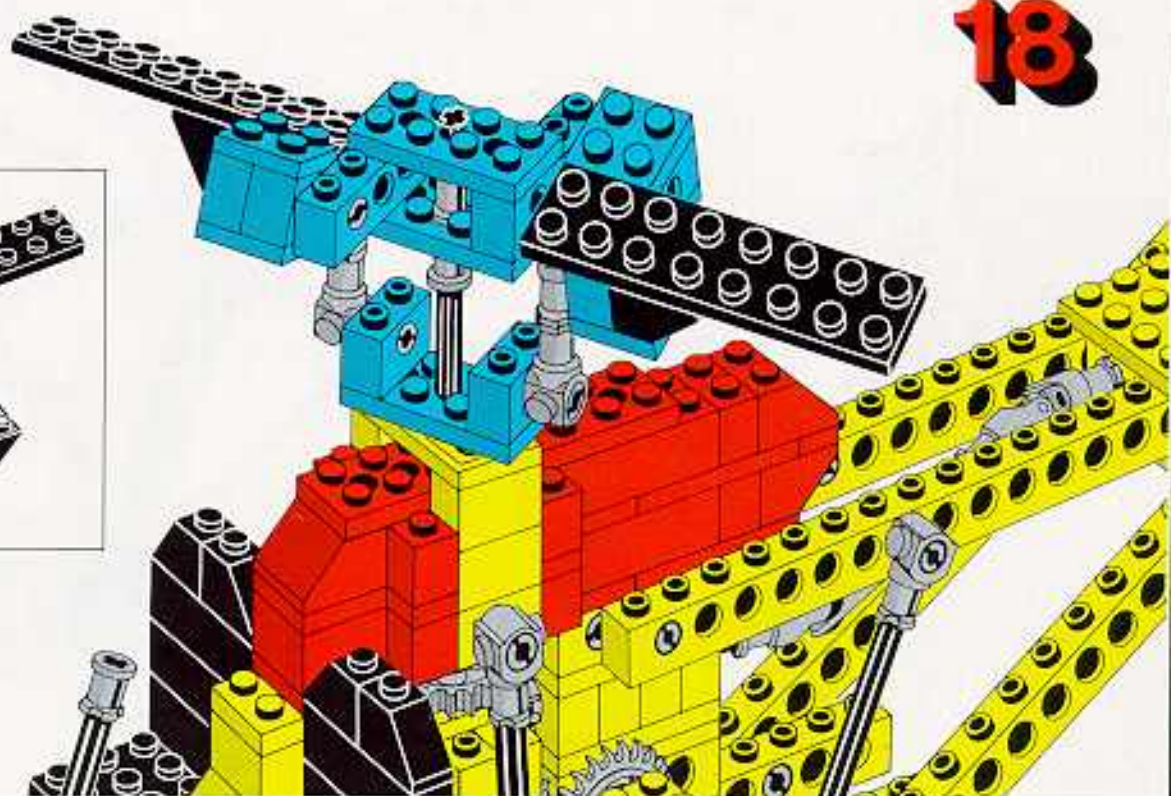
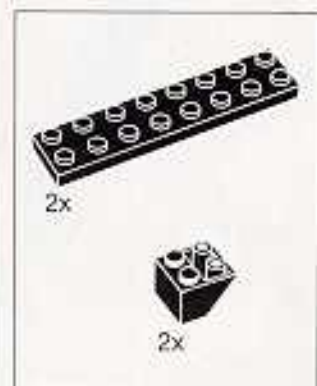

19

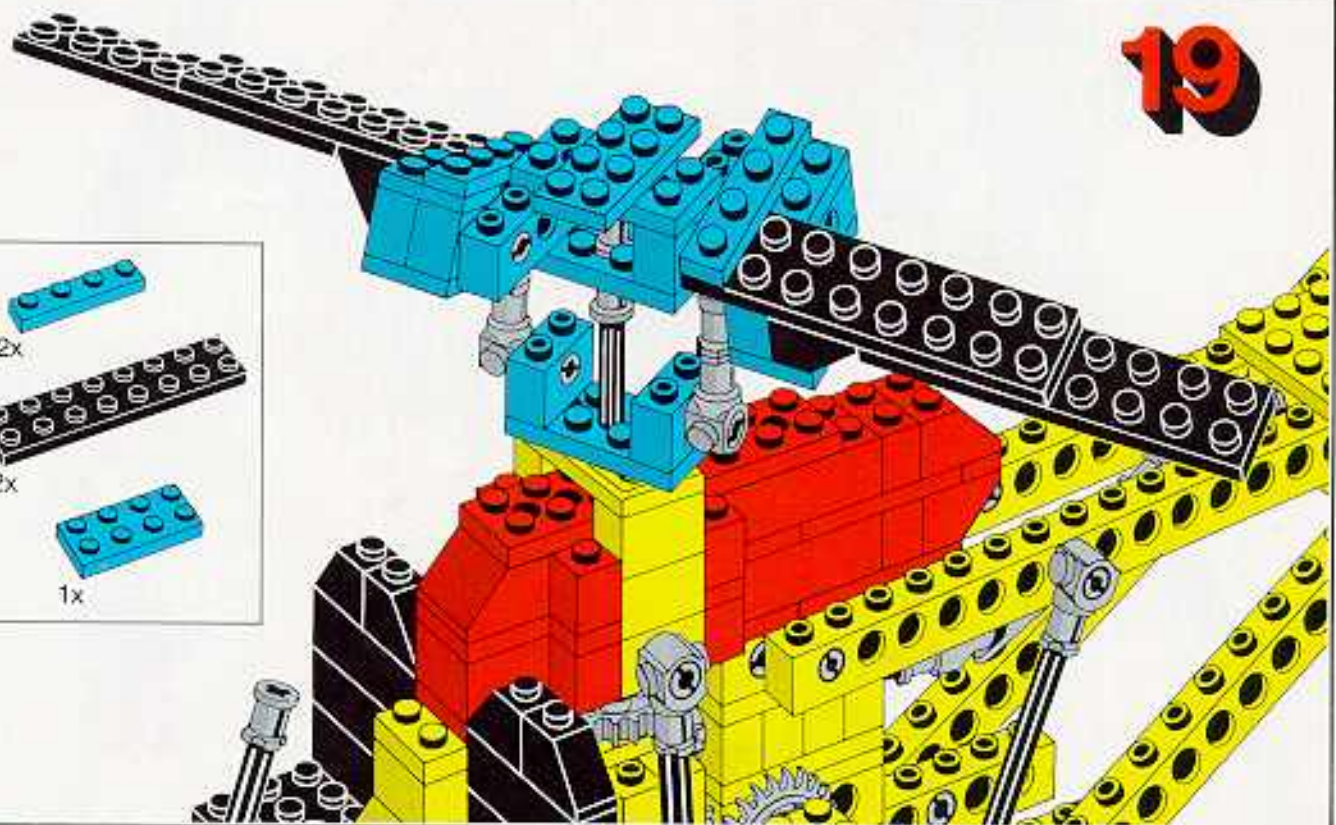
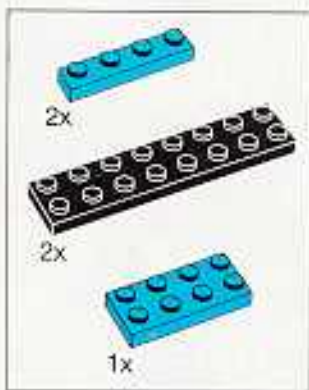



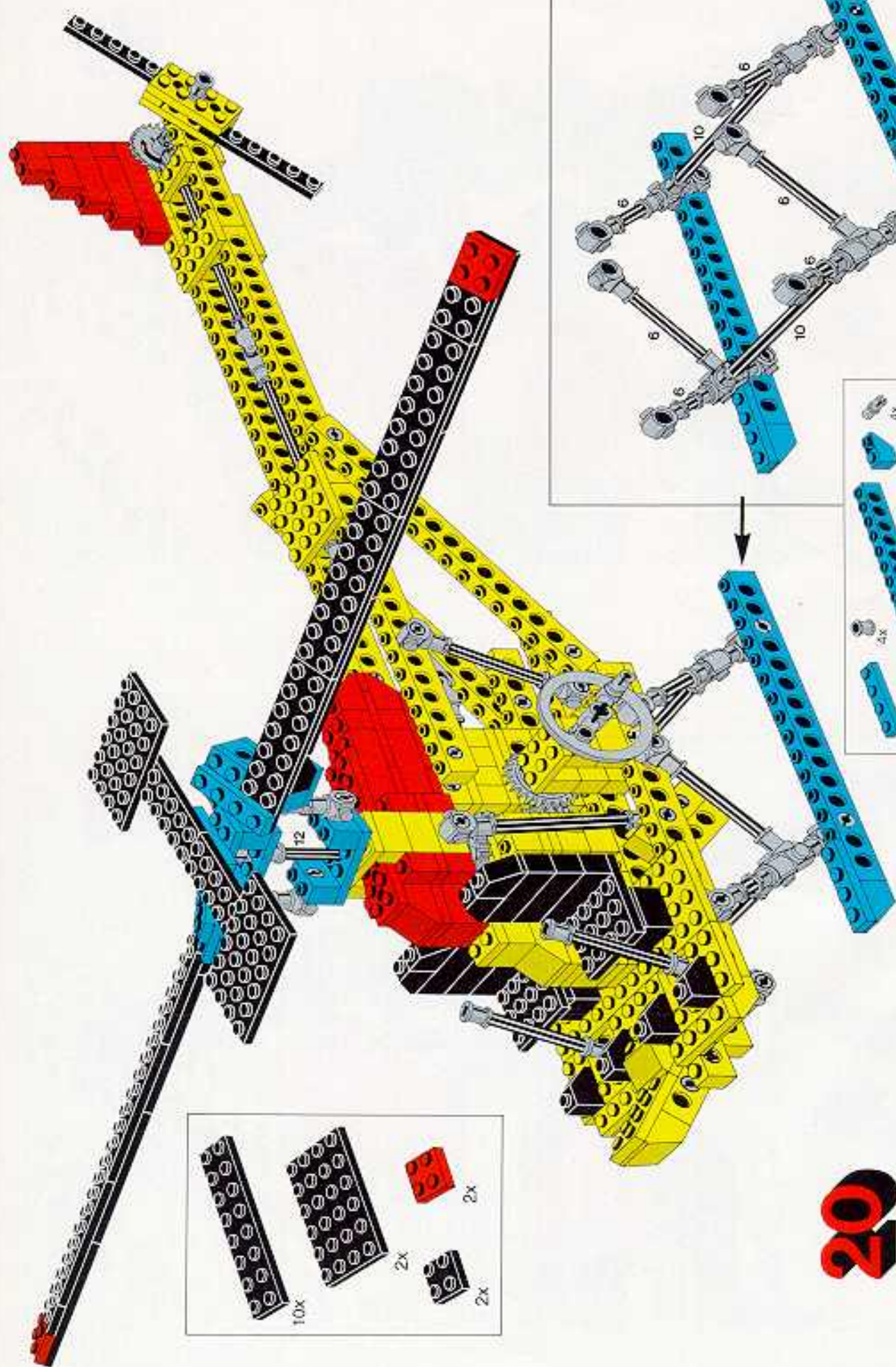



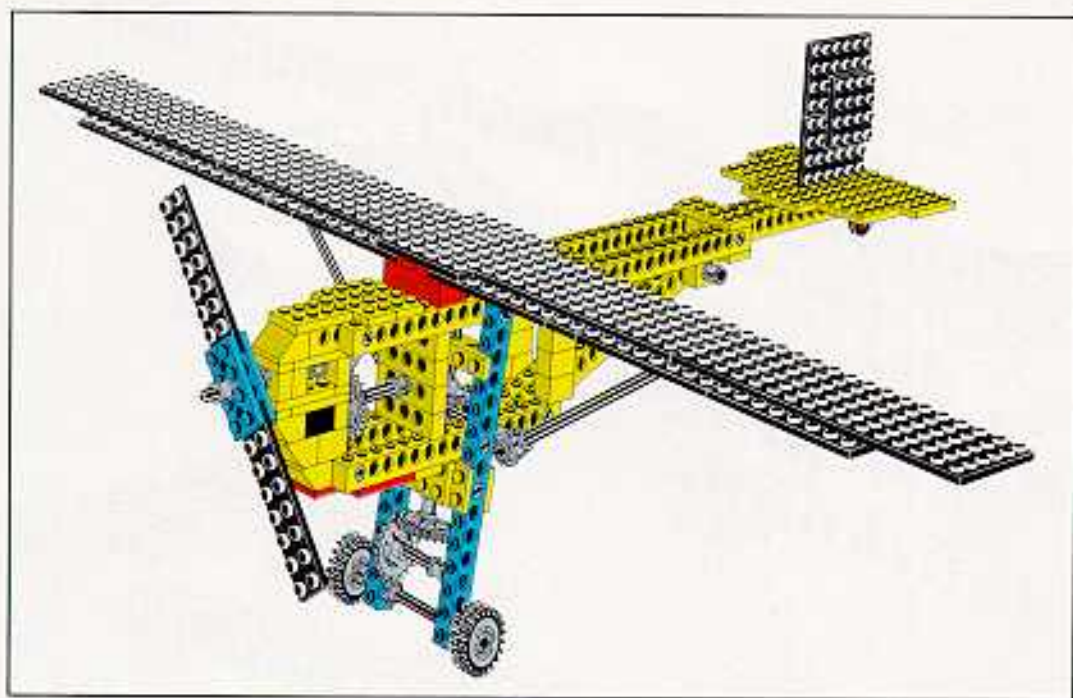

**1**

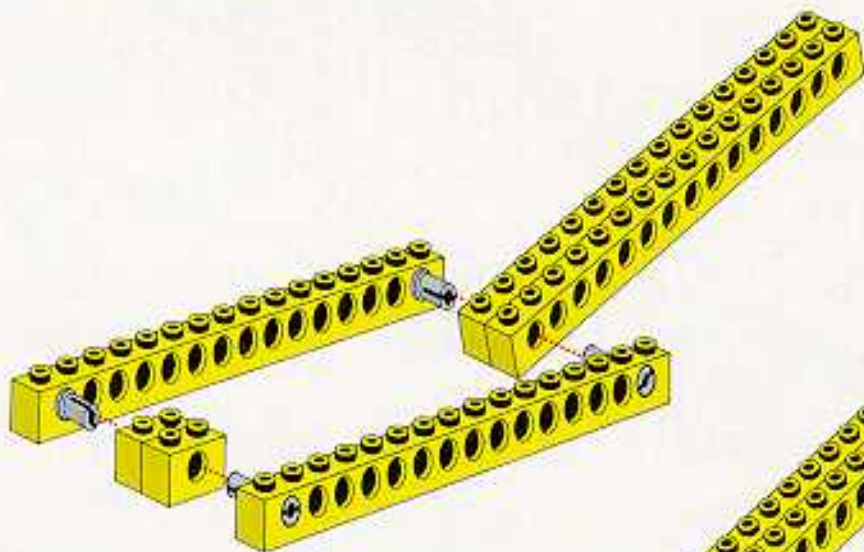

**2**

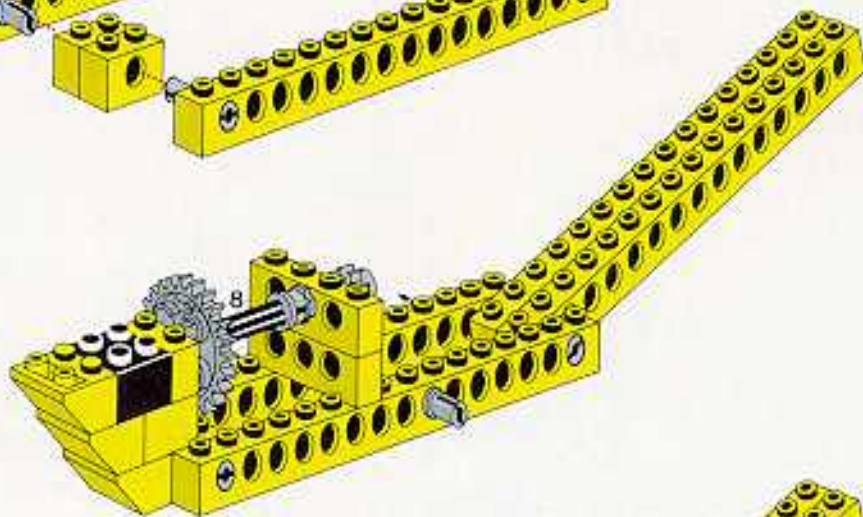

**3**

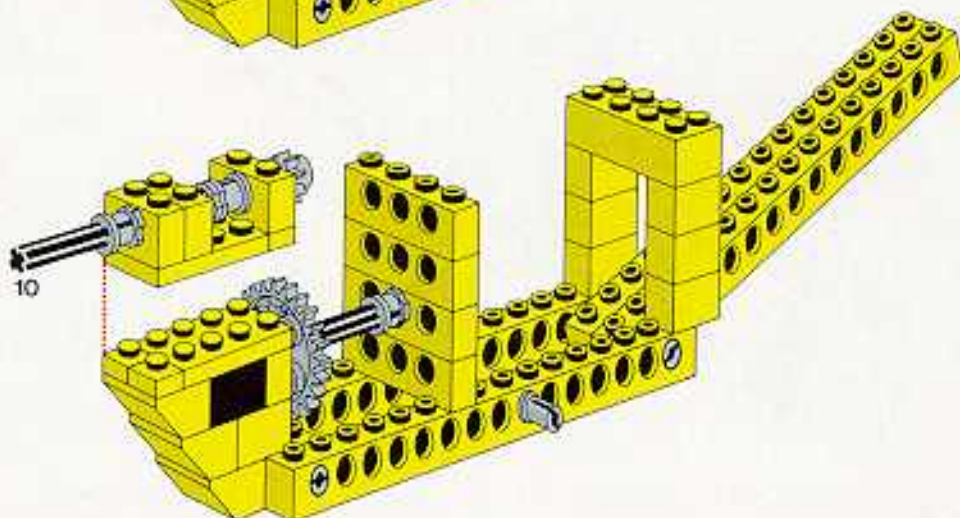



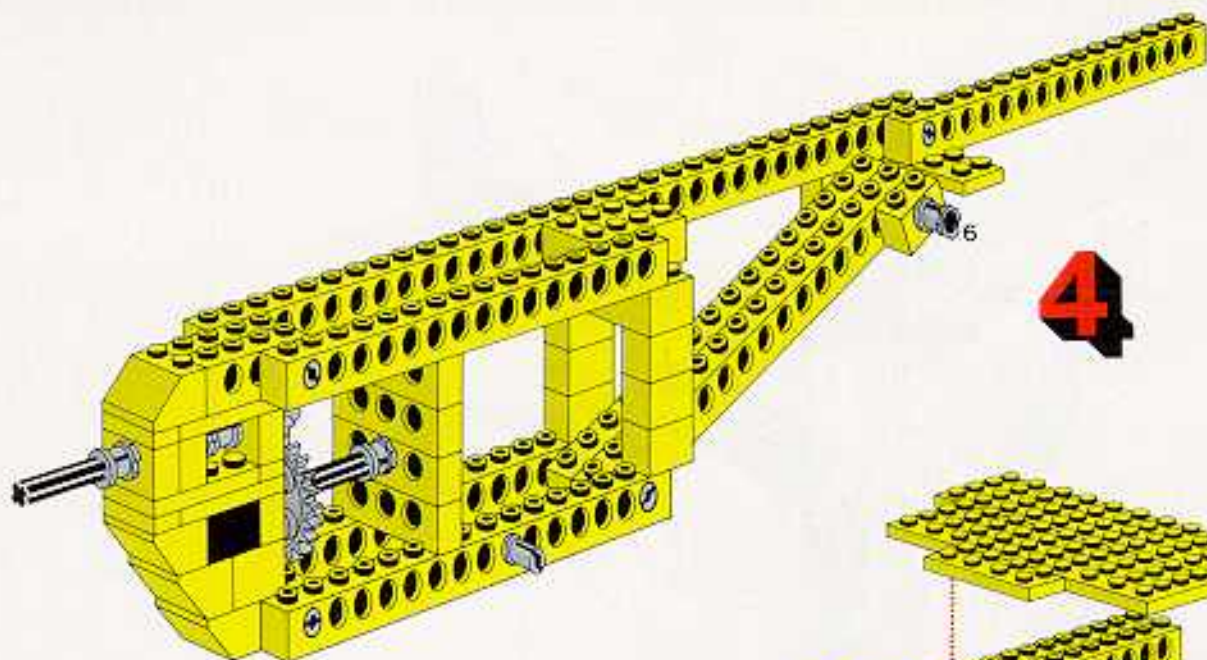

4

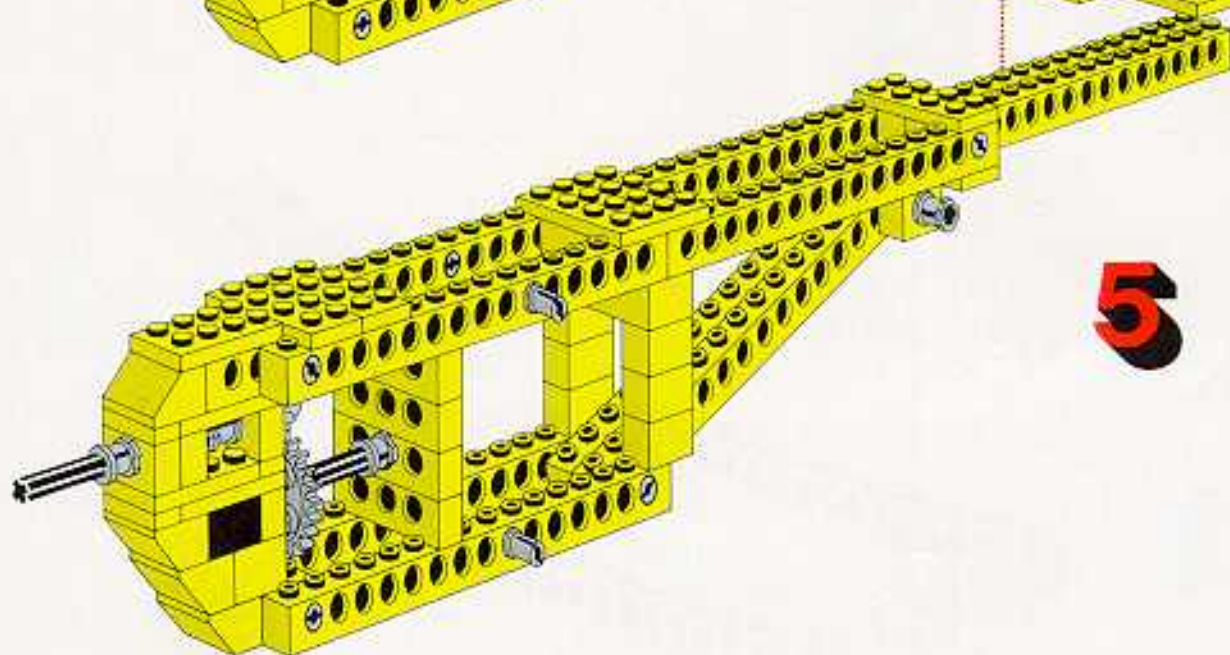

5

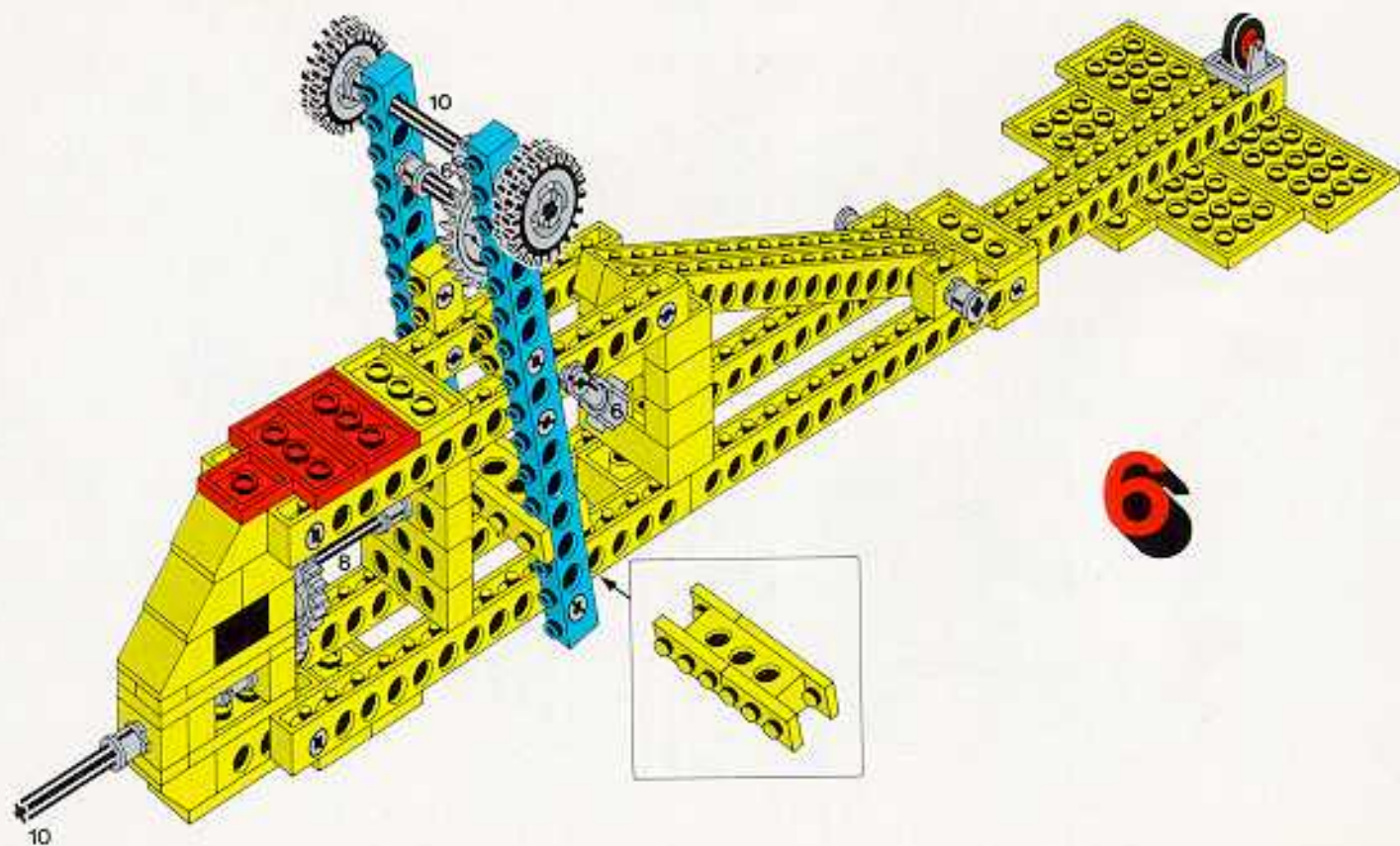

6



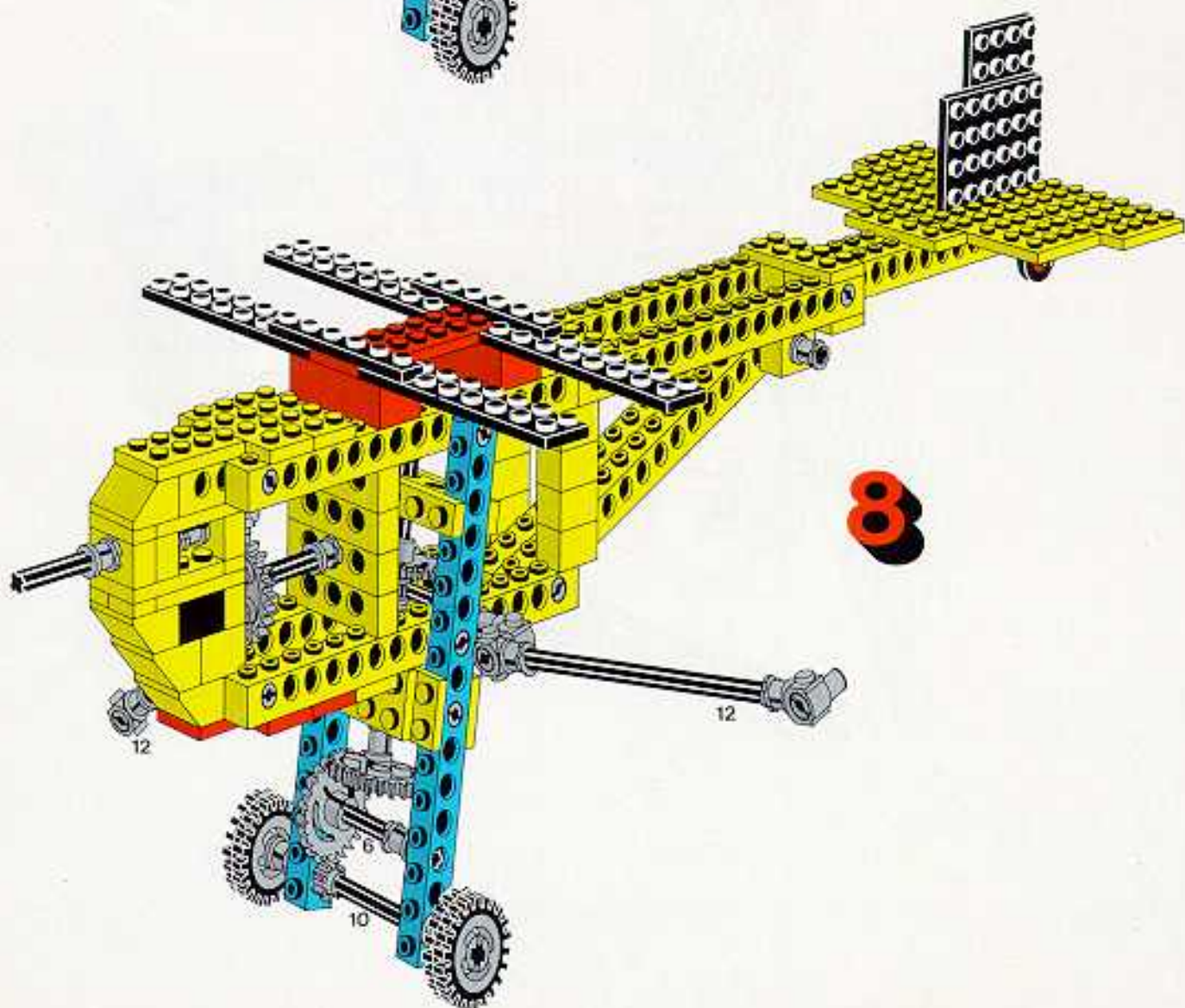
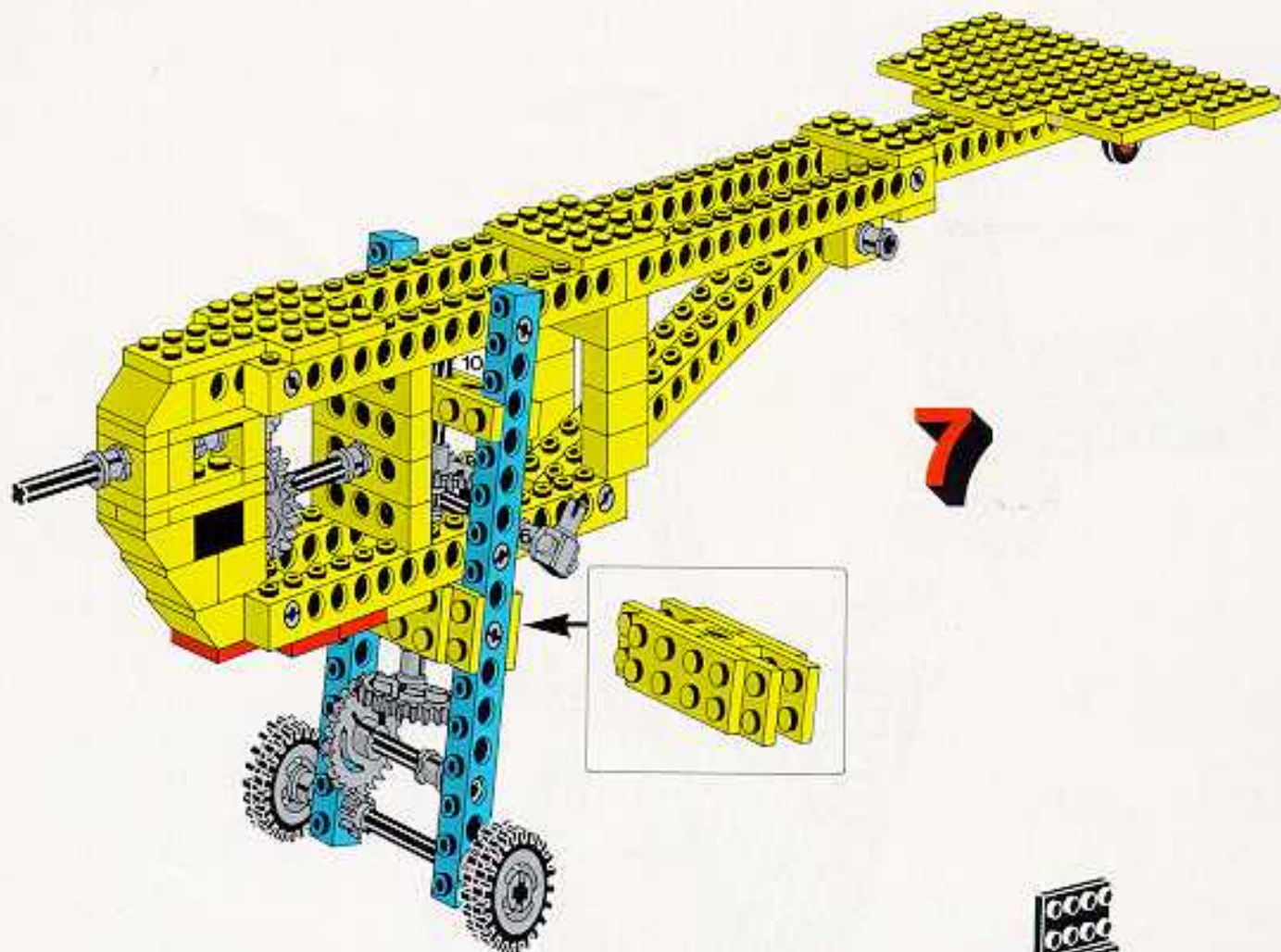



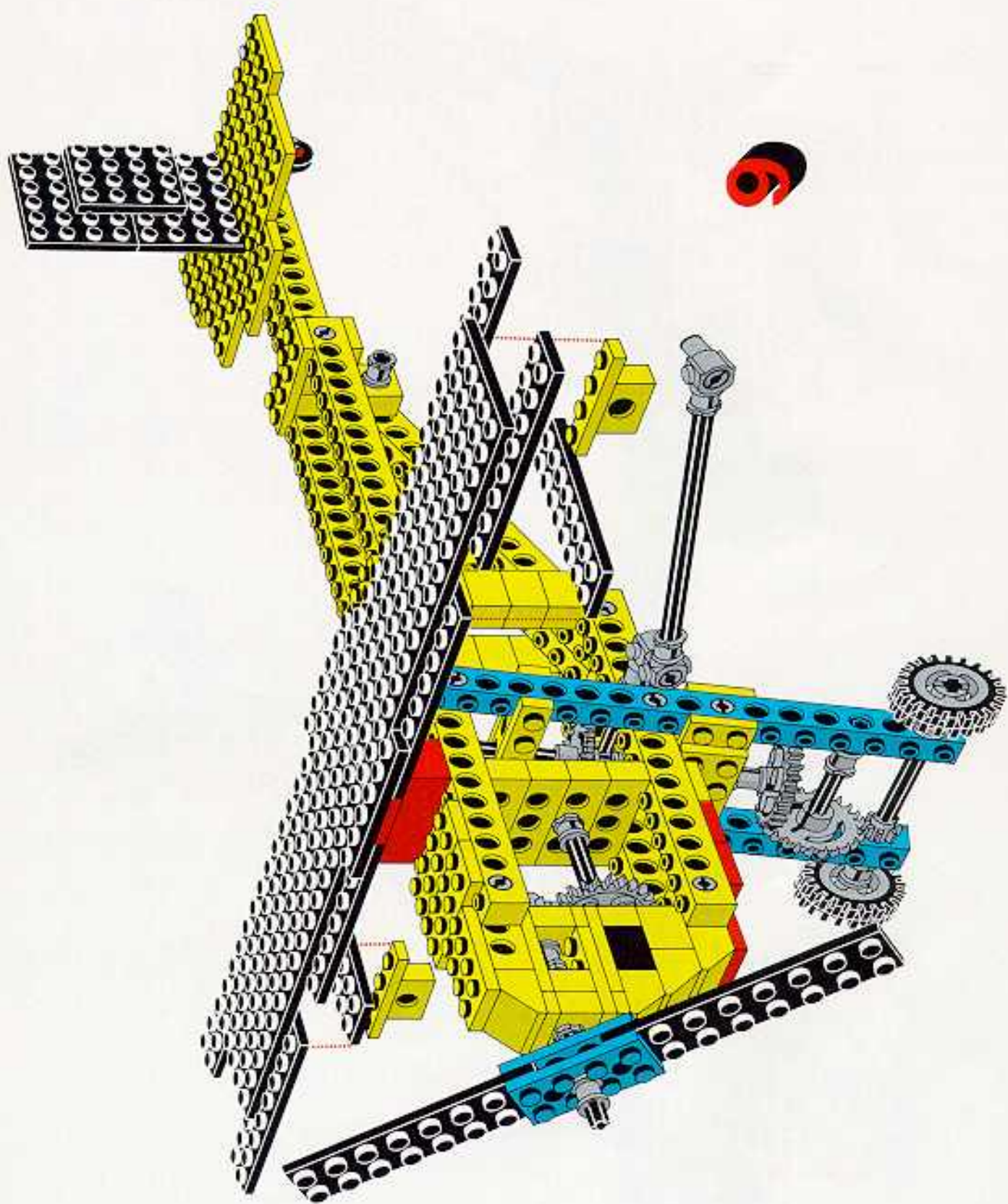



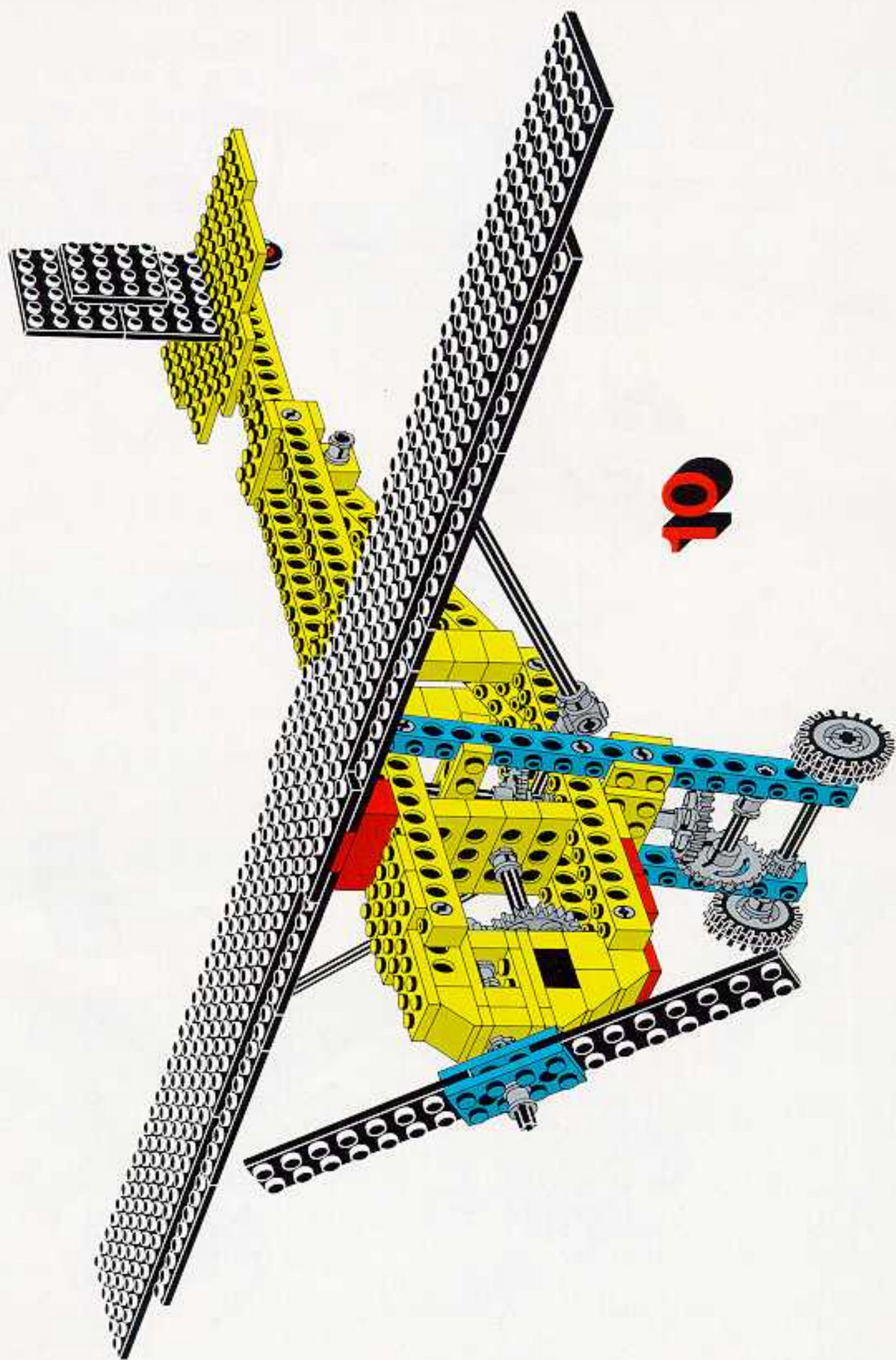

01



