

# BIONICLE®

GORAST

# MISTIKA



8695

[www.BIONICLE.com](http://www.BIONICLE.com)

LEGO

1

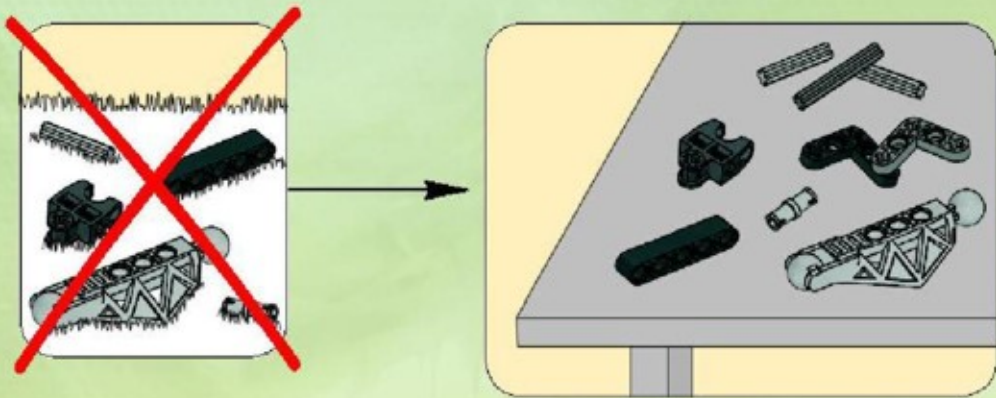

2

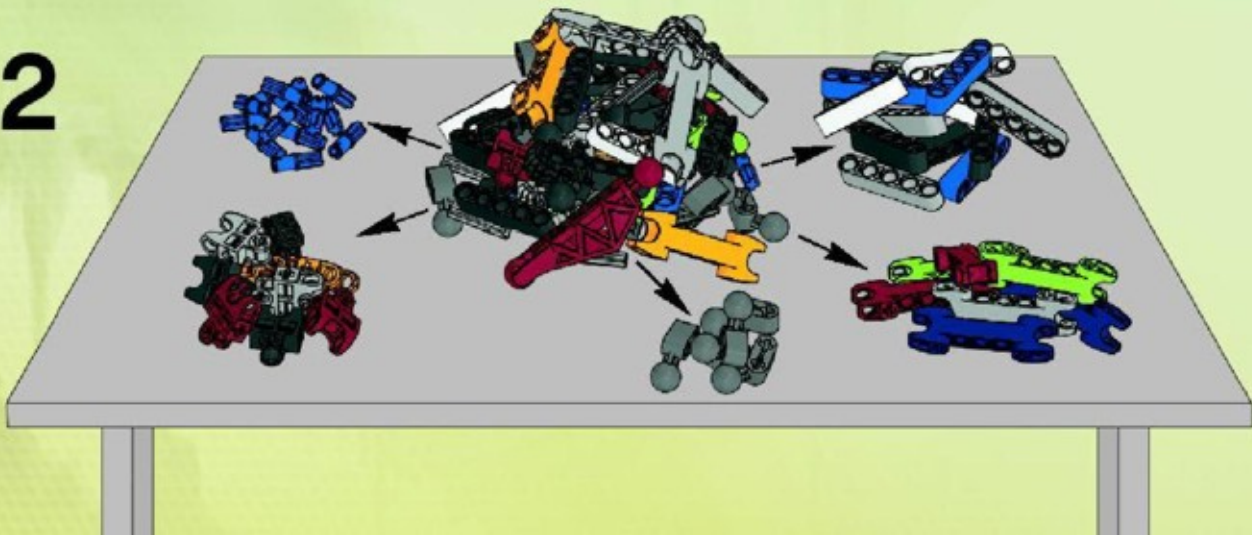

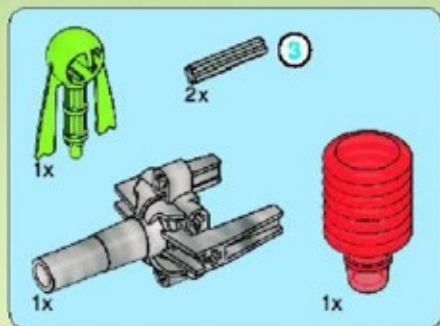

1

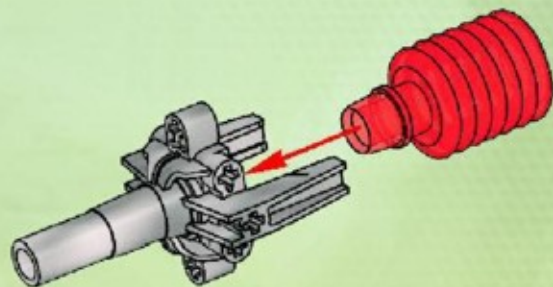

2

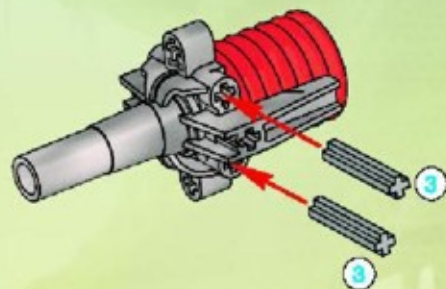

3

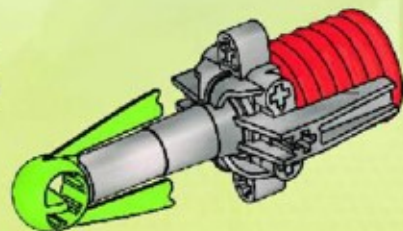





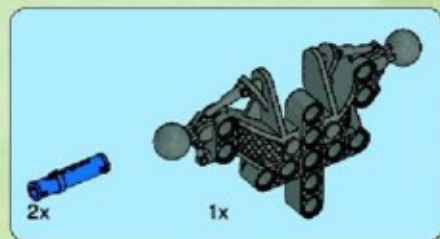

1

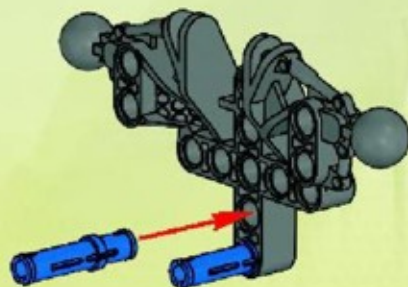



2



3

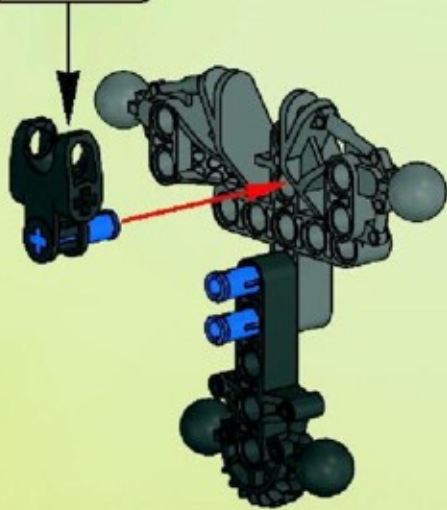



1

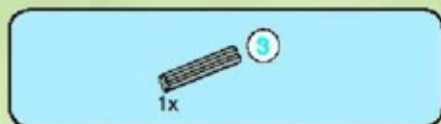

2





3



2x



4







1



2





1x

3



5



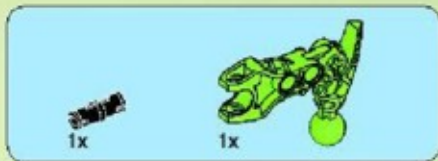

1



2





1x

3



6

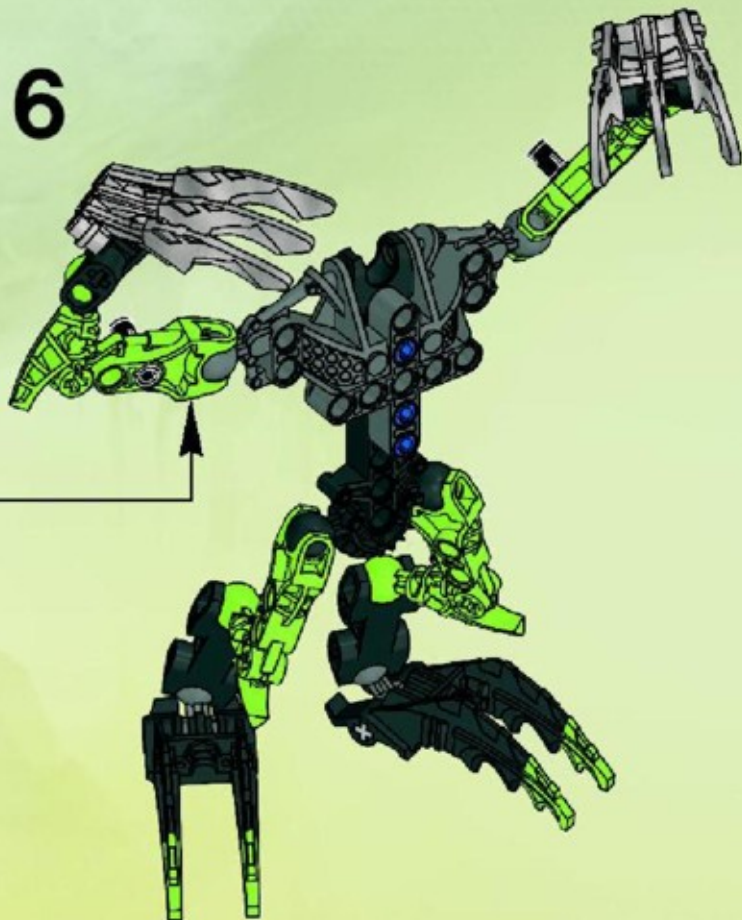





1



2



3





4

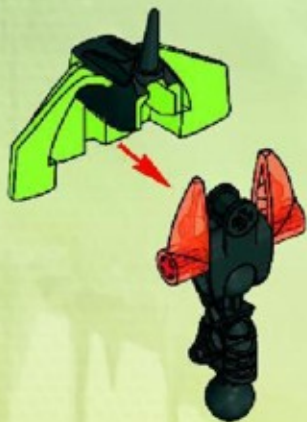

7



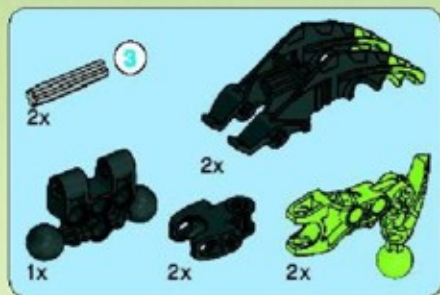

8

1

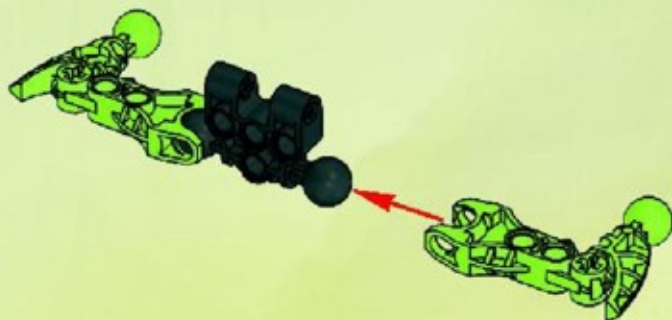

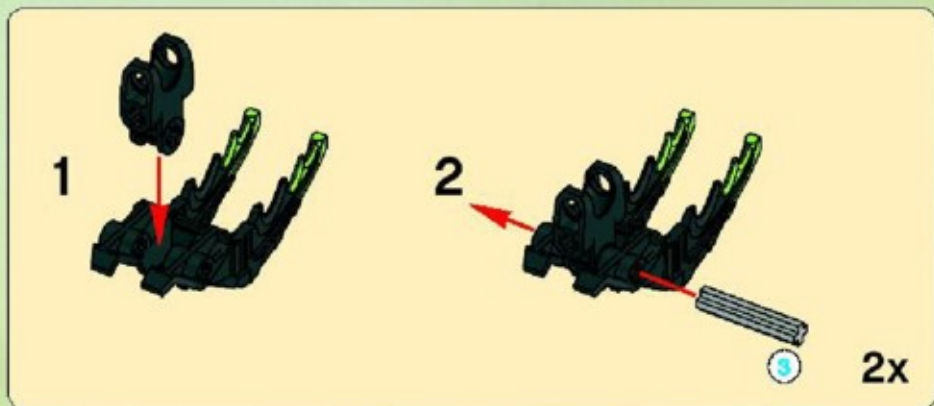

2

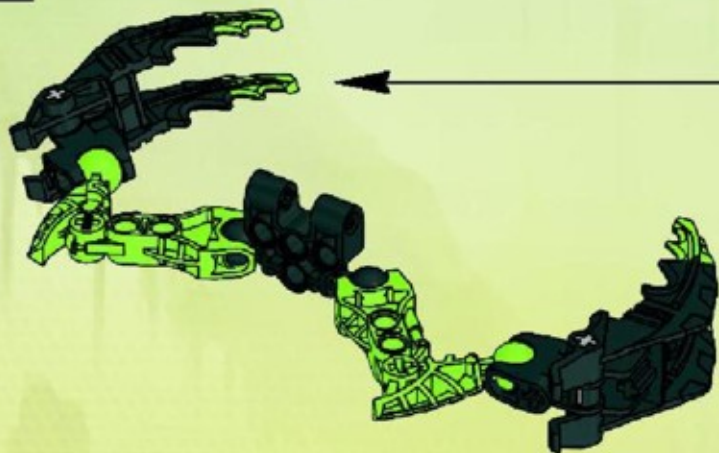







9



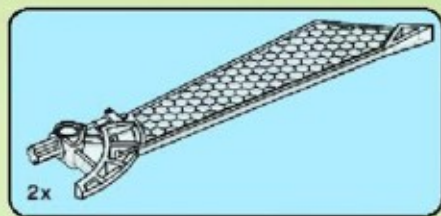

10



11

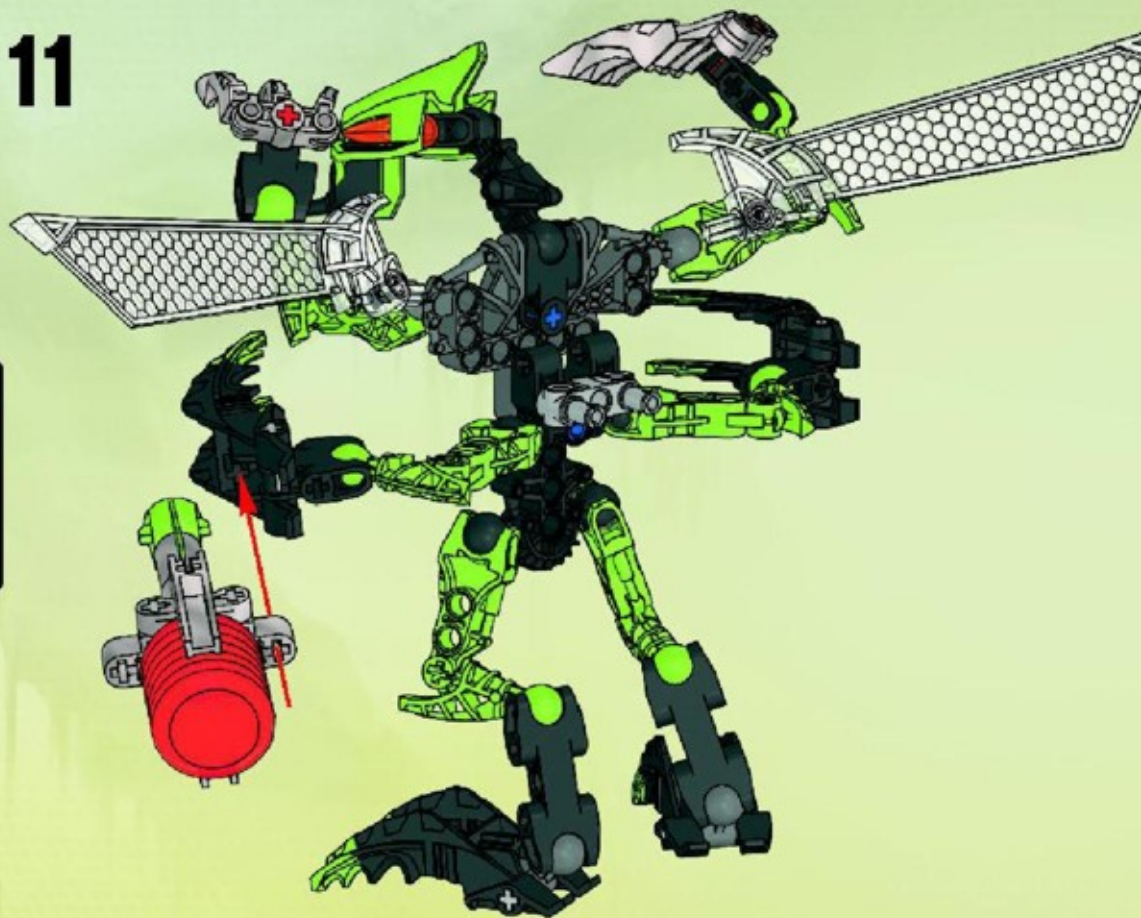



4x  
4142865

2x  
4519243

6x  
4516402

1x  
4292589

2x  
4532168

2x  
4163574

6x  
4519244

2x  
4525722

2x  
4289258

2x  
4525717

1x  
4206482

1x  
4289927

1x  
4525701

1x  
4535379

1x  
4525719

2x  
4514553

1x  
4278747

1x  
4225033

2x  
4121715

1x  
4278585

4x  
4525715

6x  
4211815



Customer Service

Kundenservice

Service Consommateurs

Servicio Al Consumidor

[www.lego.com/service](http://www.lego.com/service) or dial

 : 00800 5346 5555  
: 1-800-422-5346

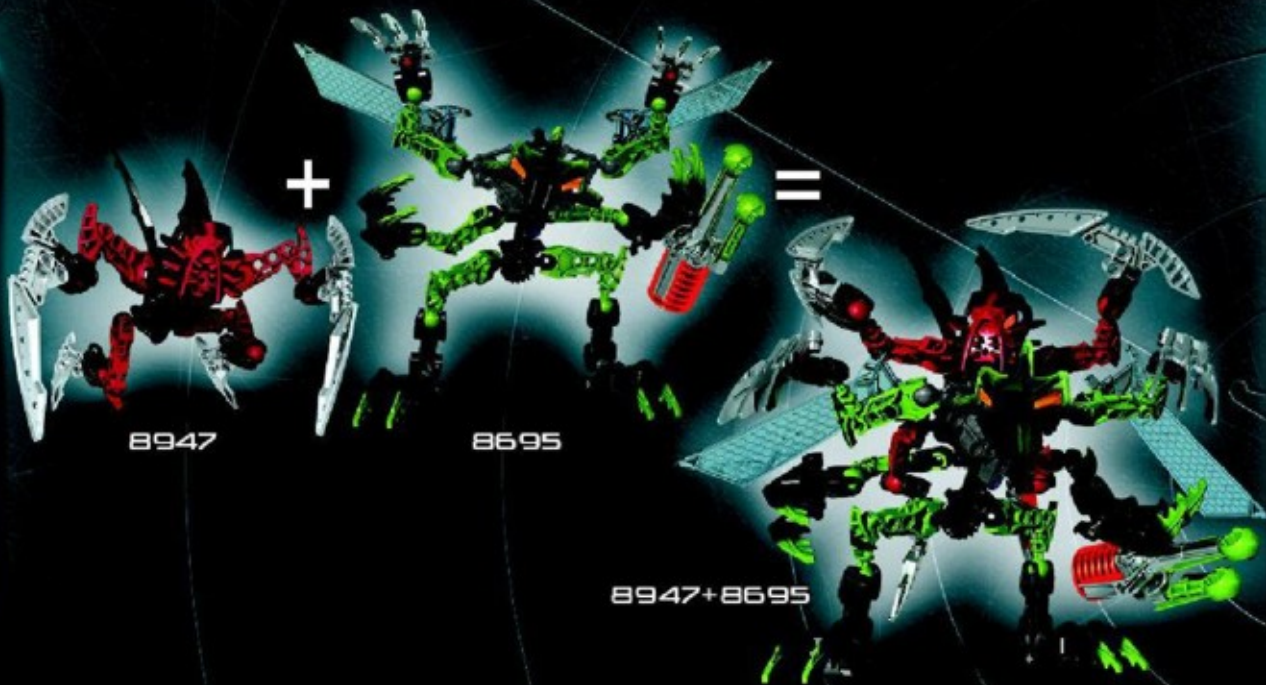

8947

8695

8947+8695



22 8688



8689



8690



8694



8695



8696



# club™



FREE LEGO Magazine • GRATUIT • GRATIS LEGO Magazin



**Join Today!**

**Abonne-toi  
dès aujourd'hui!**

**Meld je nu aan!**

**Jetzt anmelden!**



US & Canada only

1-866-534-6258 / 1-877-518-5346

en français



00800 5346 5555

[www.LEGOclub.com](http://www.LEGOclub.com)

**VISIT THE WORLD'S  
BIGGEST LEGO® SHOP!**

[www.LEGOshop.com](http://www.LEGOshop.com)





## WIN LEGO® PRODUCTS

No purchase necessary.  
Open to residents of all countries where  
not prohibited.  
Go to [www.aim.dk](http://www.aim.dk) for official rules and details.

## WIN LEGO® PRODUCTEN

Kopen niet nodig.  
Open voor alle leeftijden, en in alle landen  
waar geen verbod geldt.  
Ga naar [www.aim.dk](http://www.aim.dk) voor officiële regels en details.

## GEWINNE LEGO® PRODUKTE

Die Teilnahme am Gewinnspiel führt zu  
keinerlei Kaufverpflichtungen.  
Sie können in allen nicht ausgeschlossenen  
Ländern teilnehmen.  
Die offiziellen Regeln und nähere Informationen  
finden Sie unter [www.aim.dk](http://www.aim.dk).

## GAGNE DES PRODUITS LEGO®

Aucun achat n'est nécessaire.  
Ouvert à tous les âges et aux résidents de  
tous les pays, sauf en cas d'interdiction.  
Rendez-vous sur [www.aim.dk](http://www.aim.dk) pour obtenir plus  
de détails et le règlement officiel.

## レゴ®製品を「当てよう」

購入は不要です  
禁止されていない限り、あらゆる  
年代およびあらゆる国の居住者の  
方々にご利用いただけます。  
公認規則および詳細につきましては、  
[www.aim.dk](http://www.aim.dk)をご覧ください

