

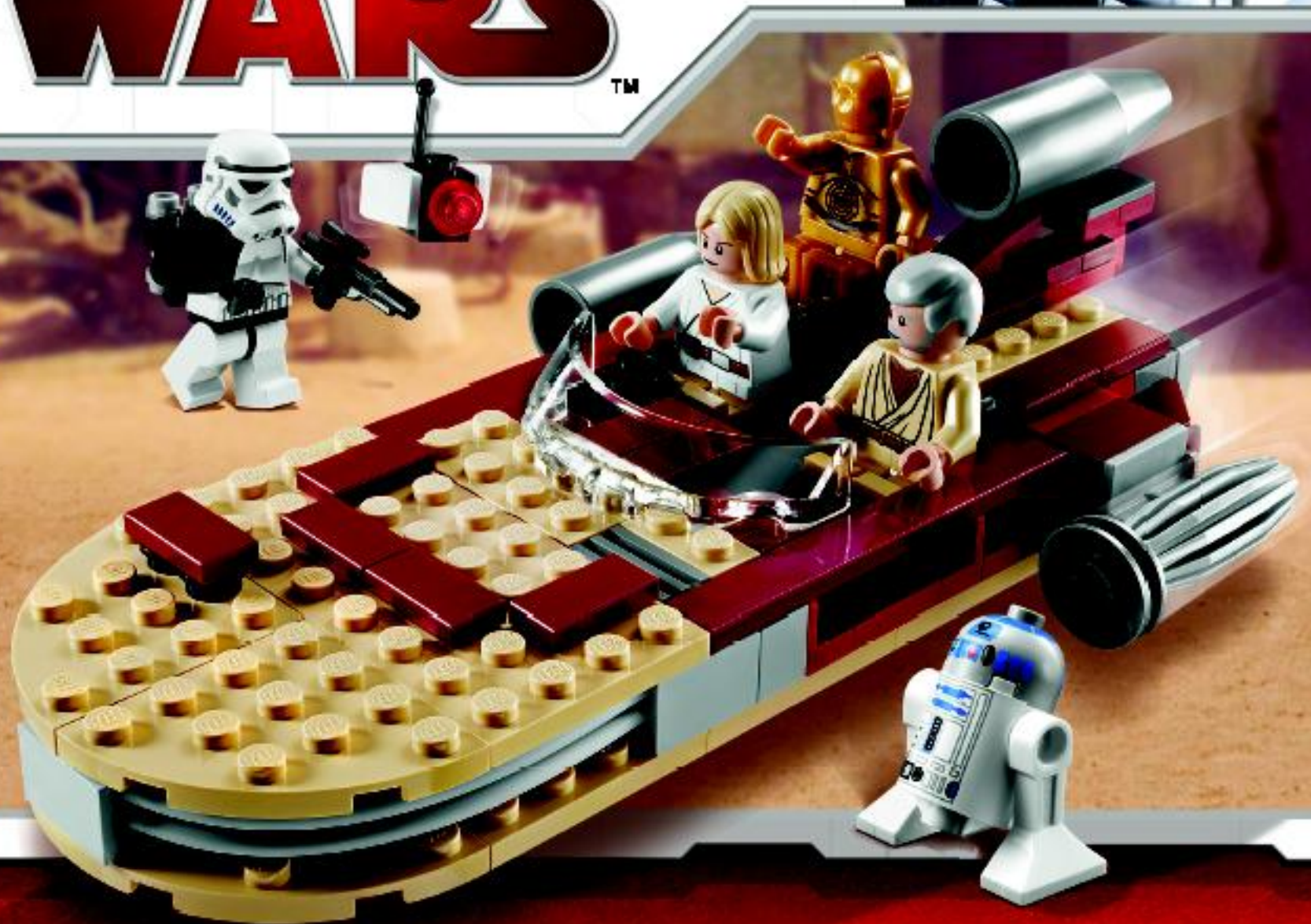

STAR WARSM



8092



1

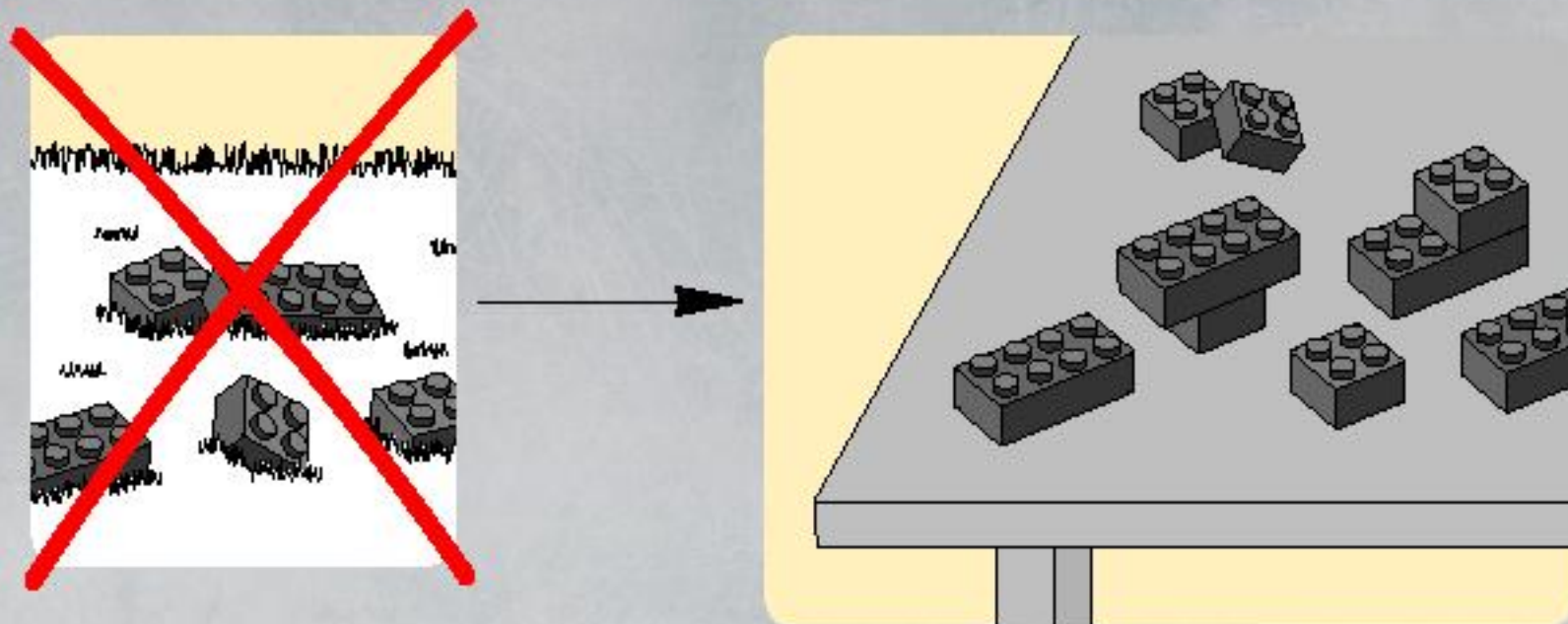

2

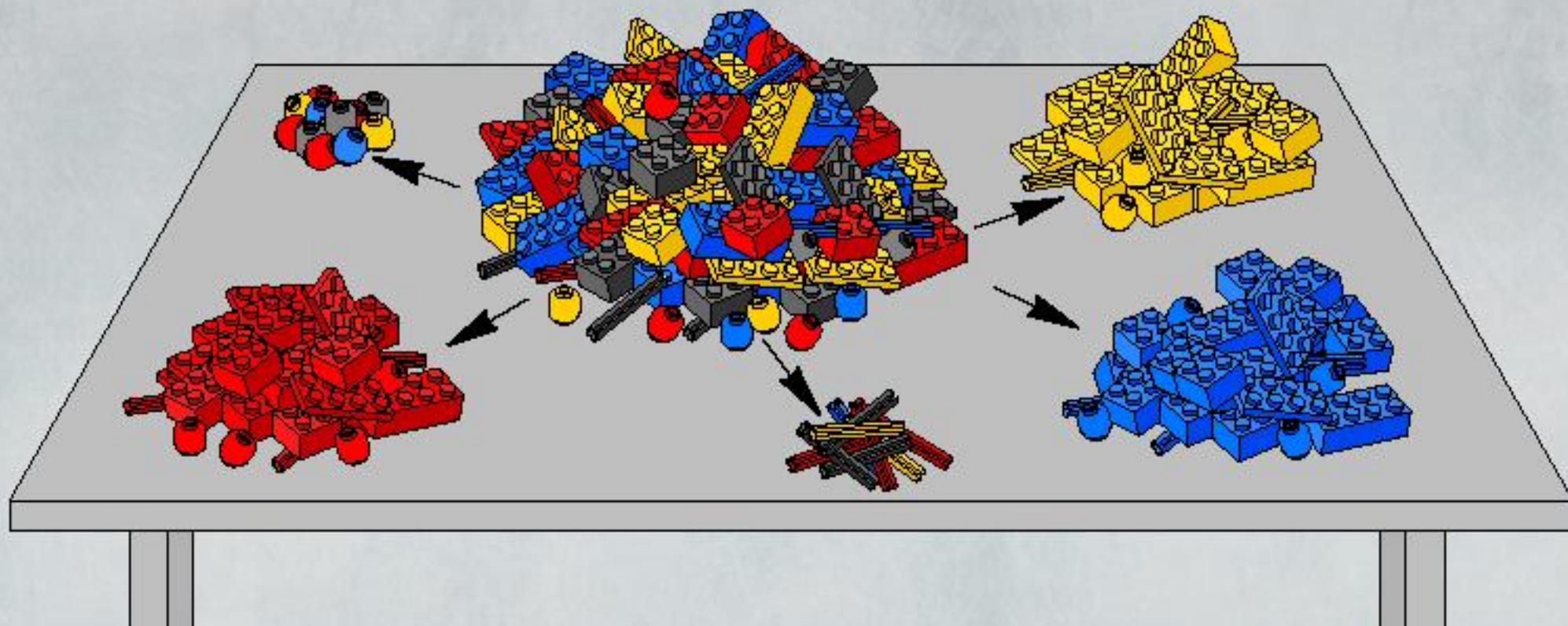

3

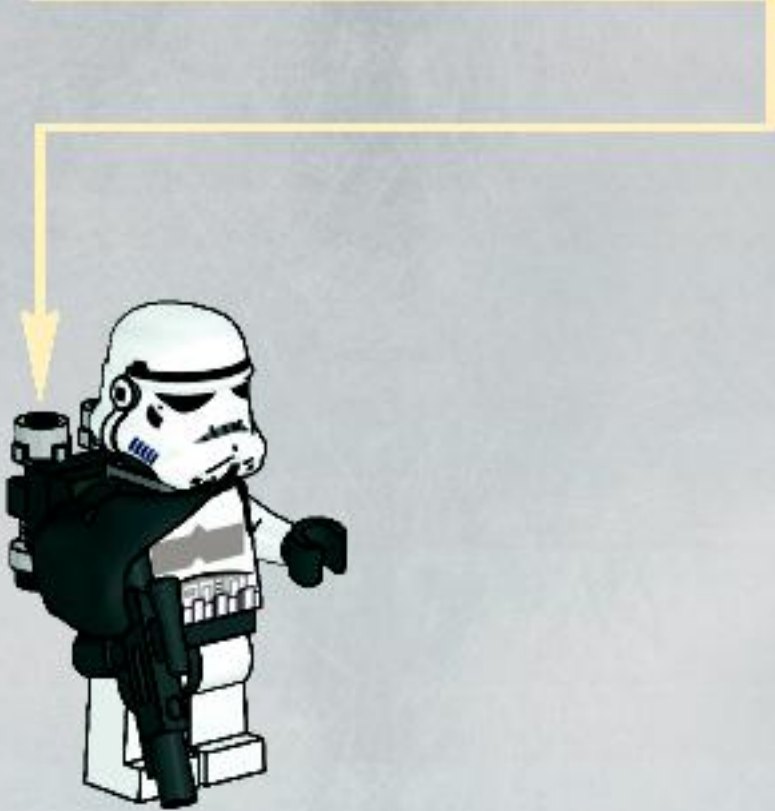
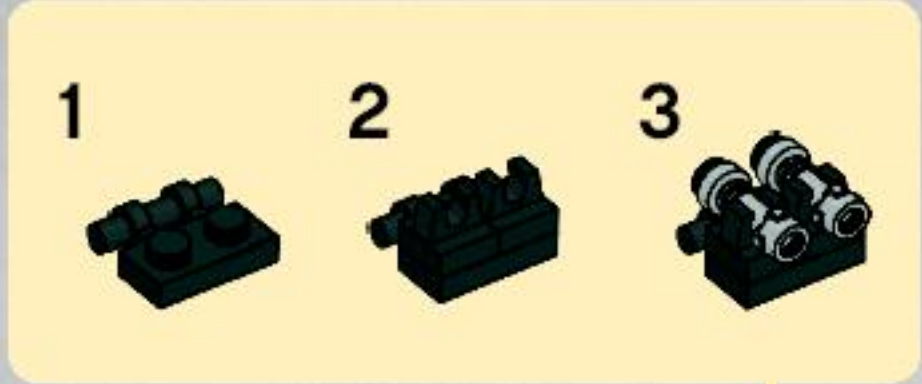
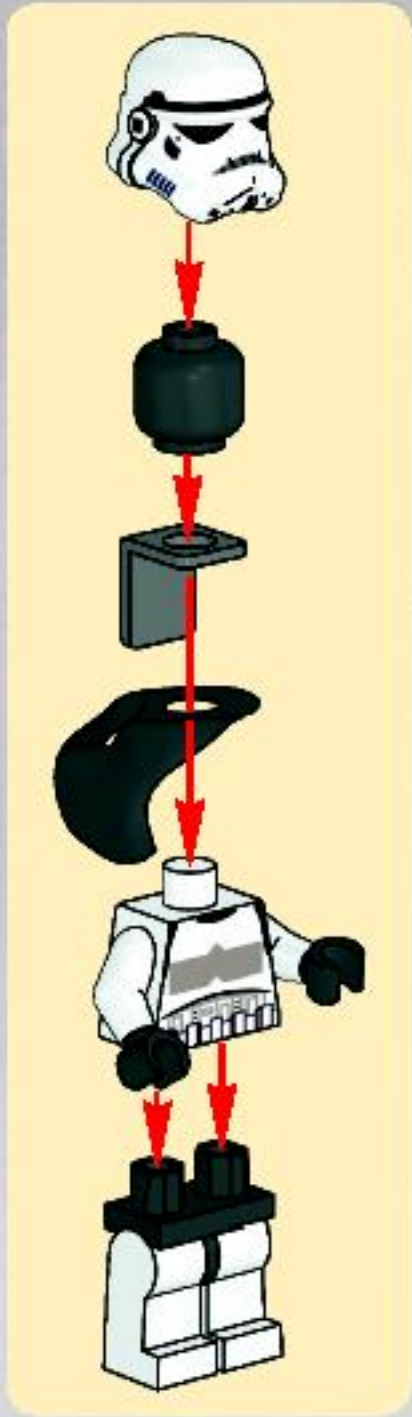

4

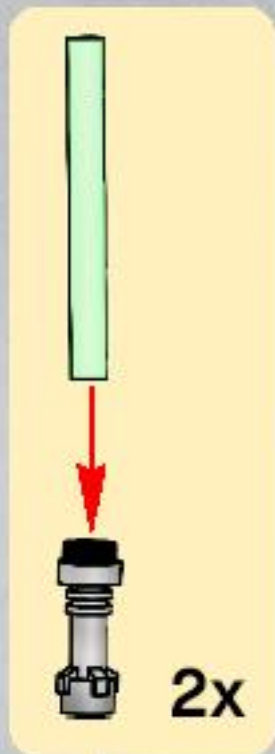
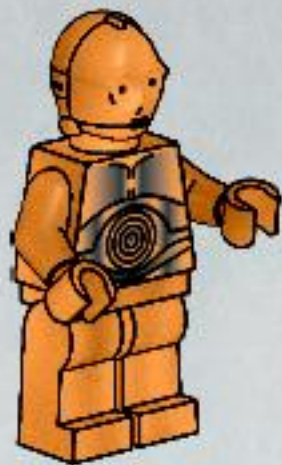

4

5

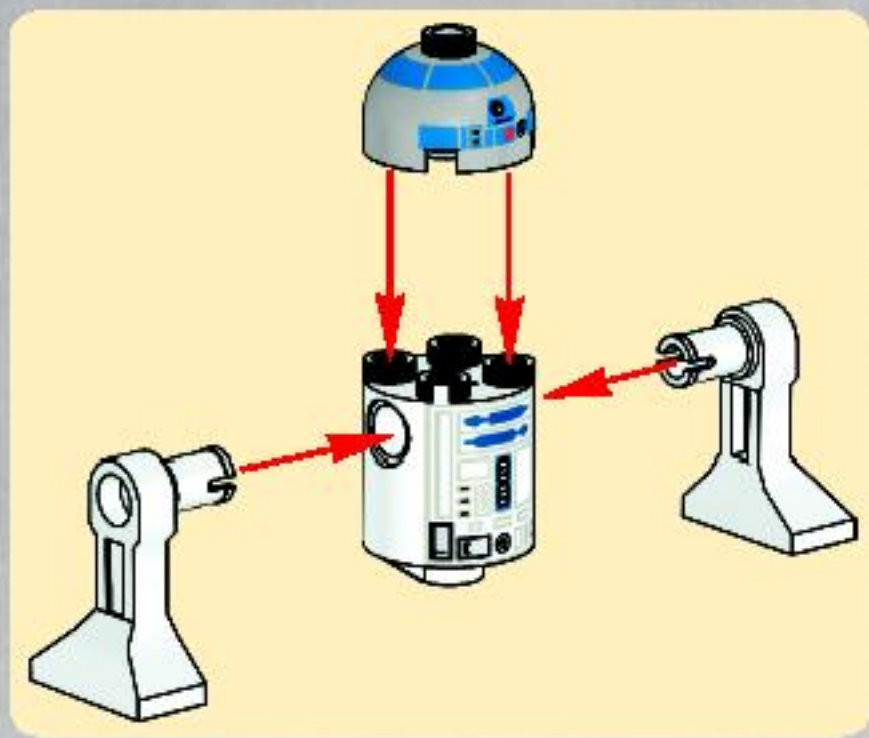



1x



2x



2x



1x



1x



1x

6

1



2



3



4

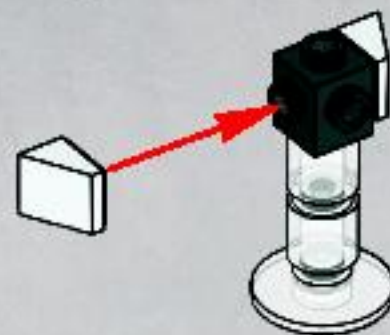

5





1

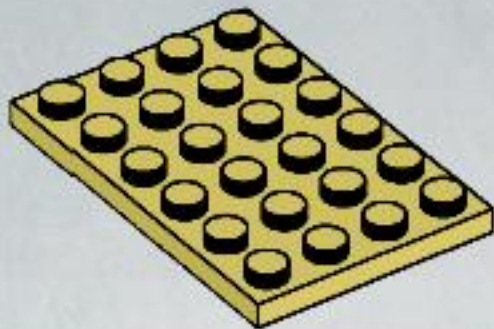

2

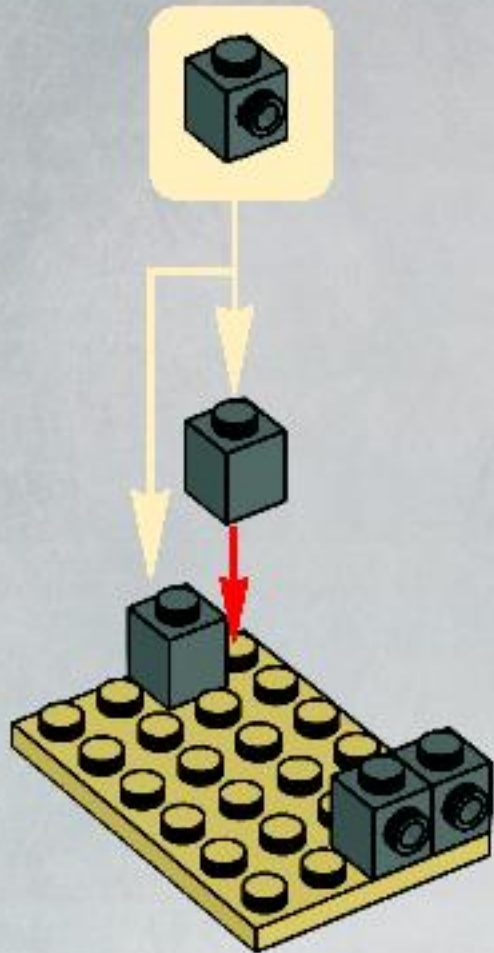



3

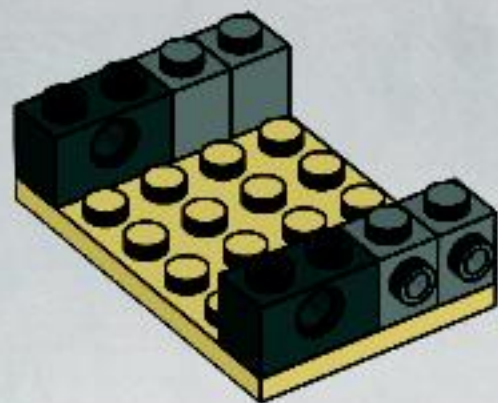

4

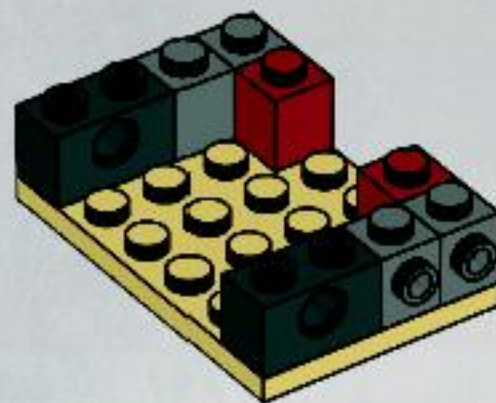

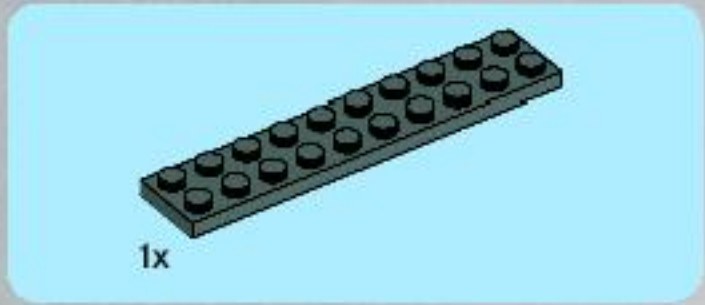

5

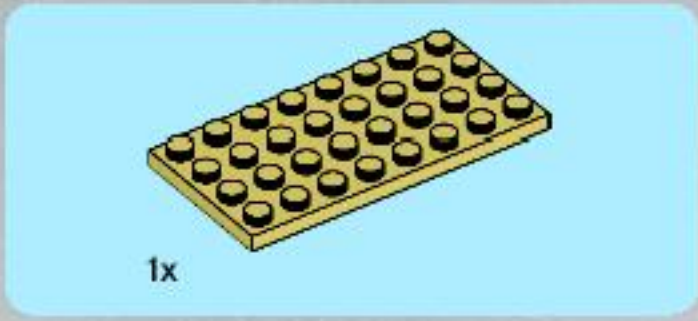
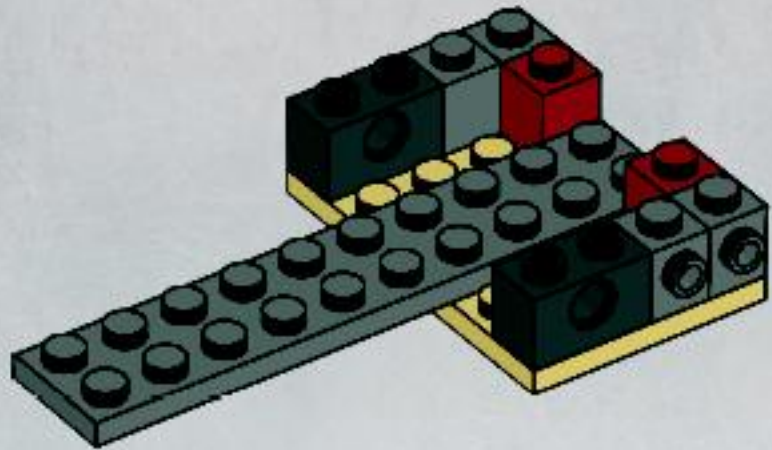

6

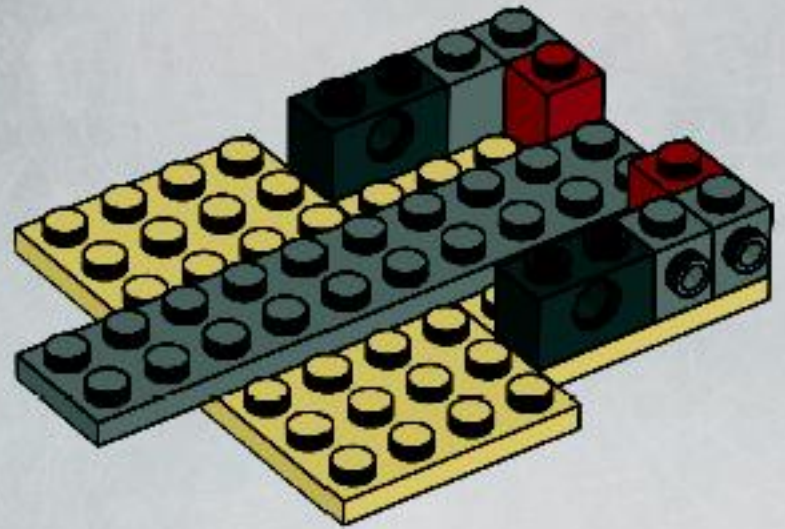



1x

7

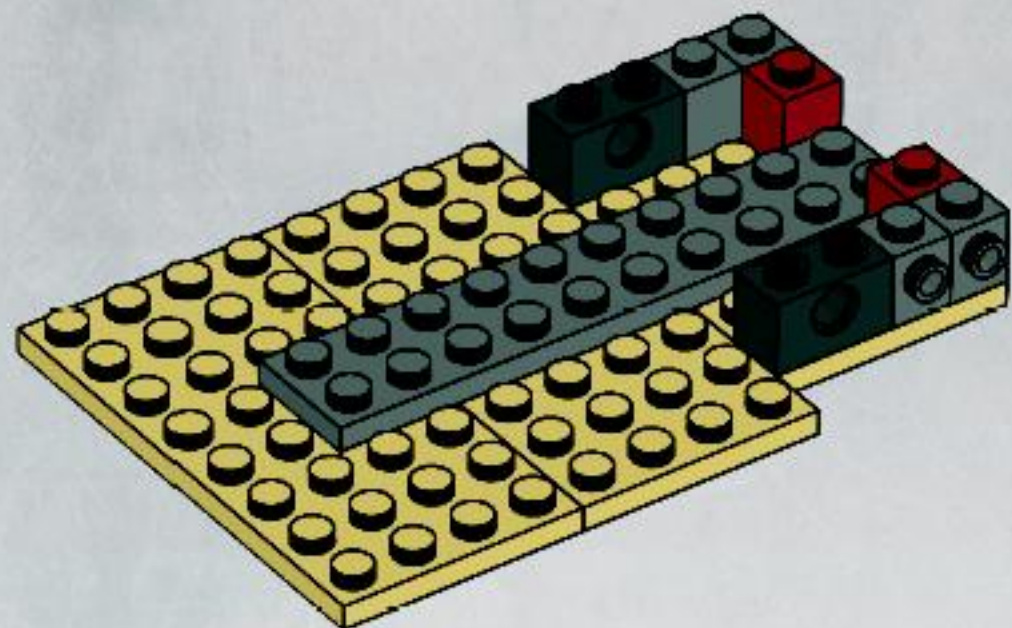

2x

8

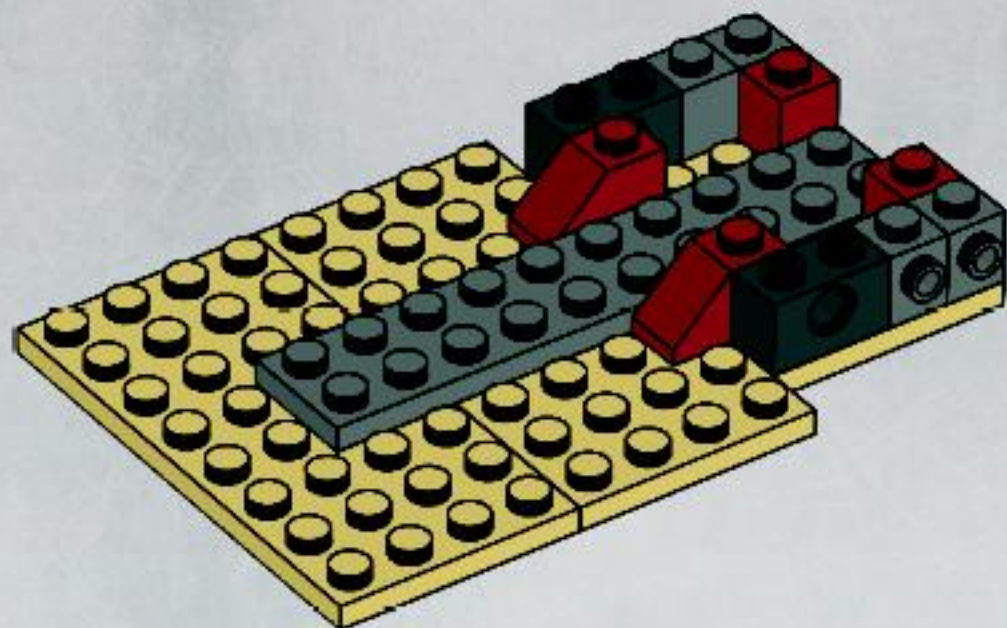



2x



2x

9

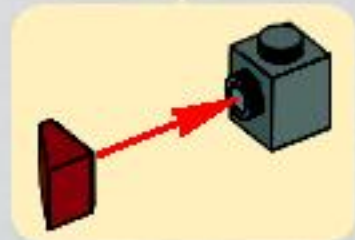
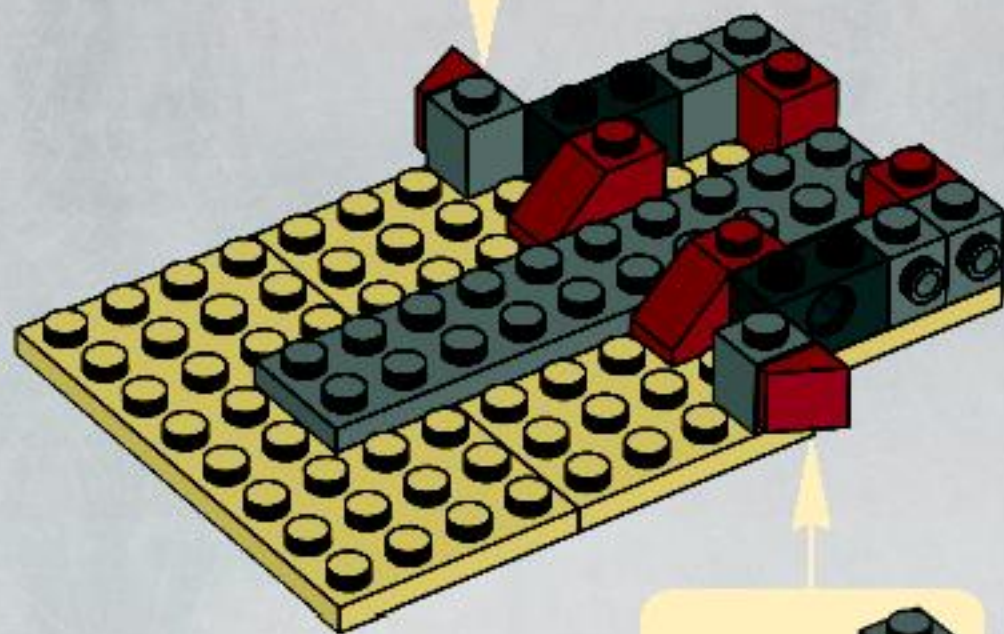
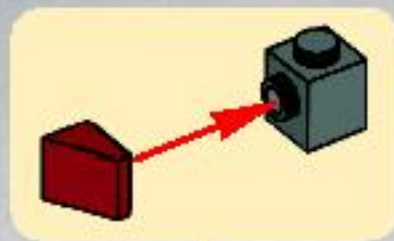

3x



2x

10

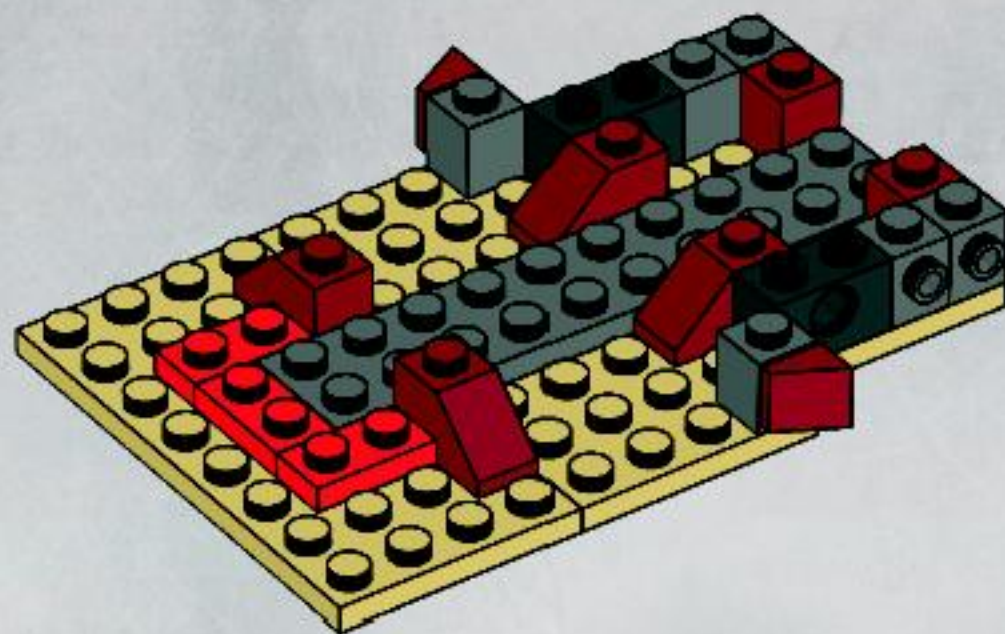



2x

11

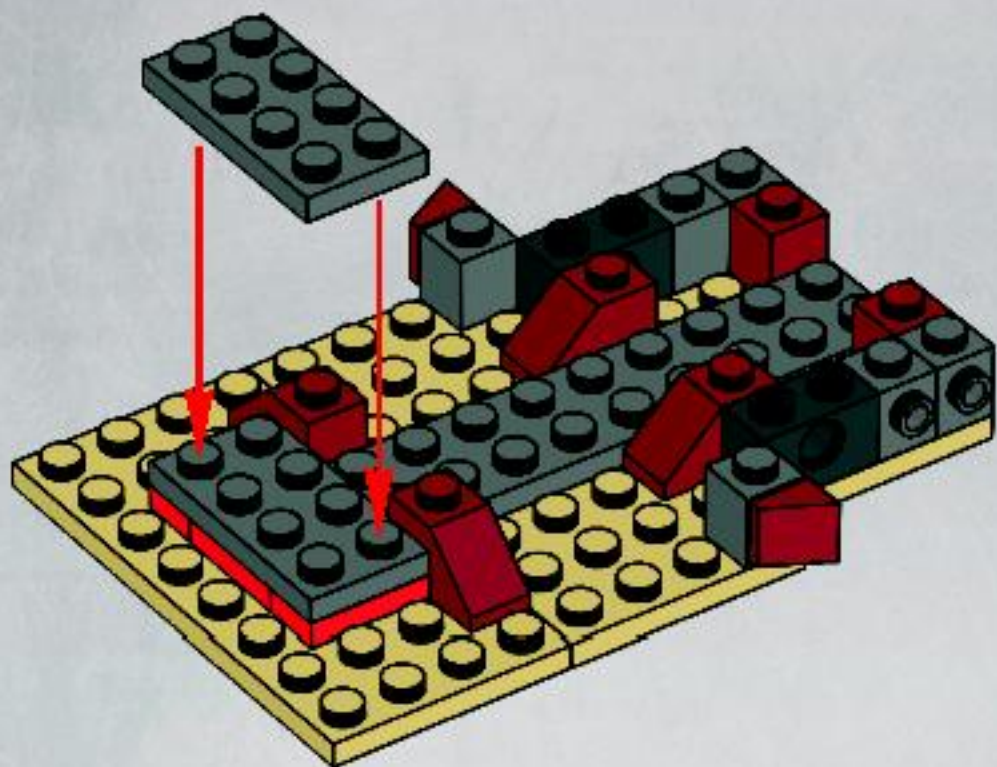

2x

12

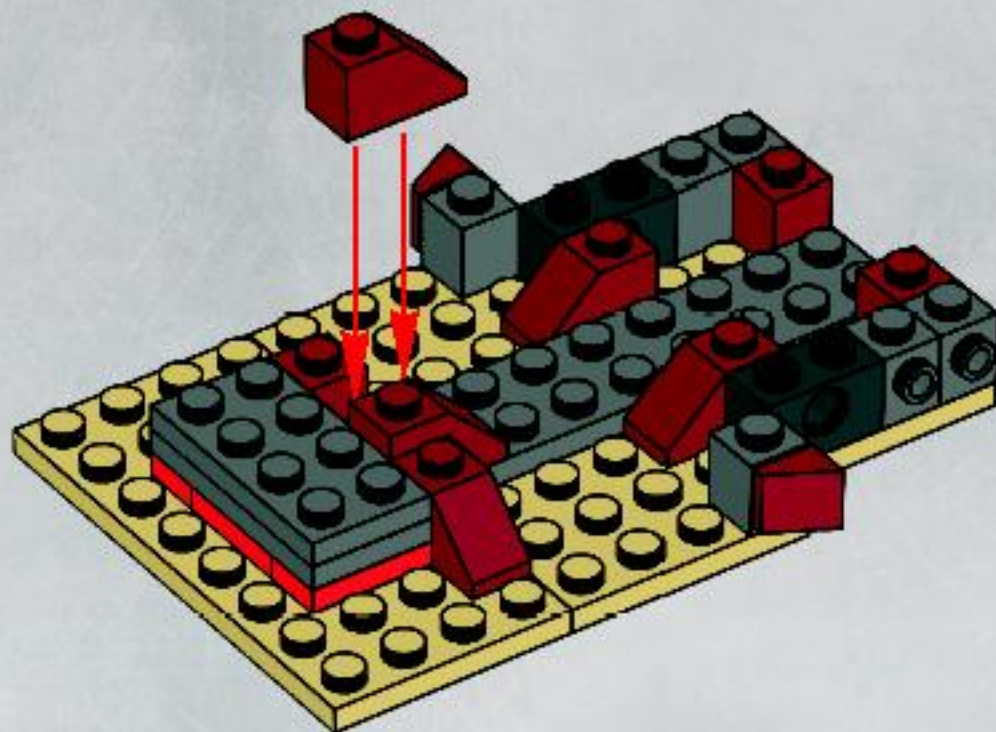



2x



6x

13

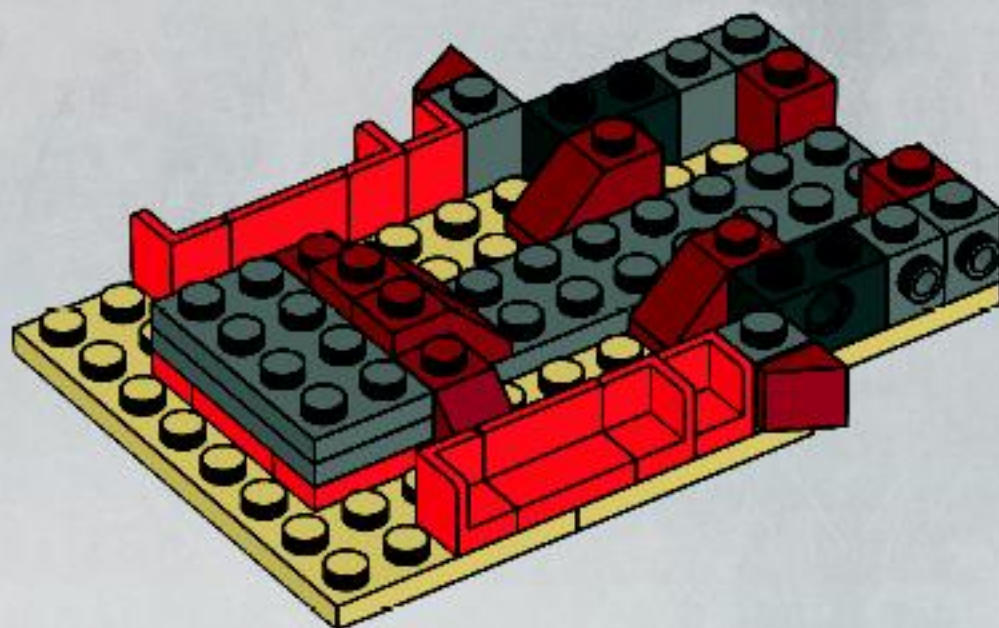

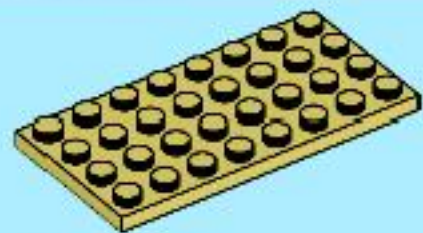

1x

14

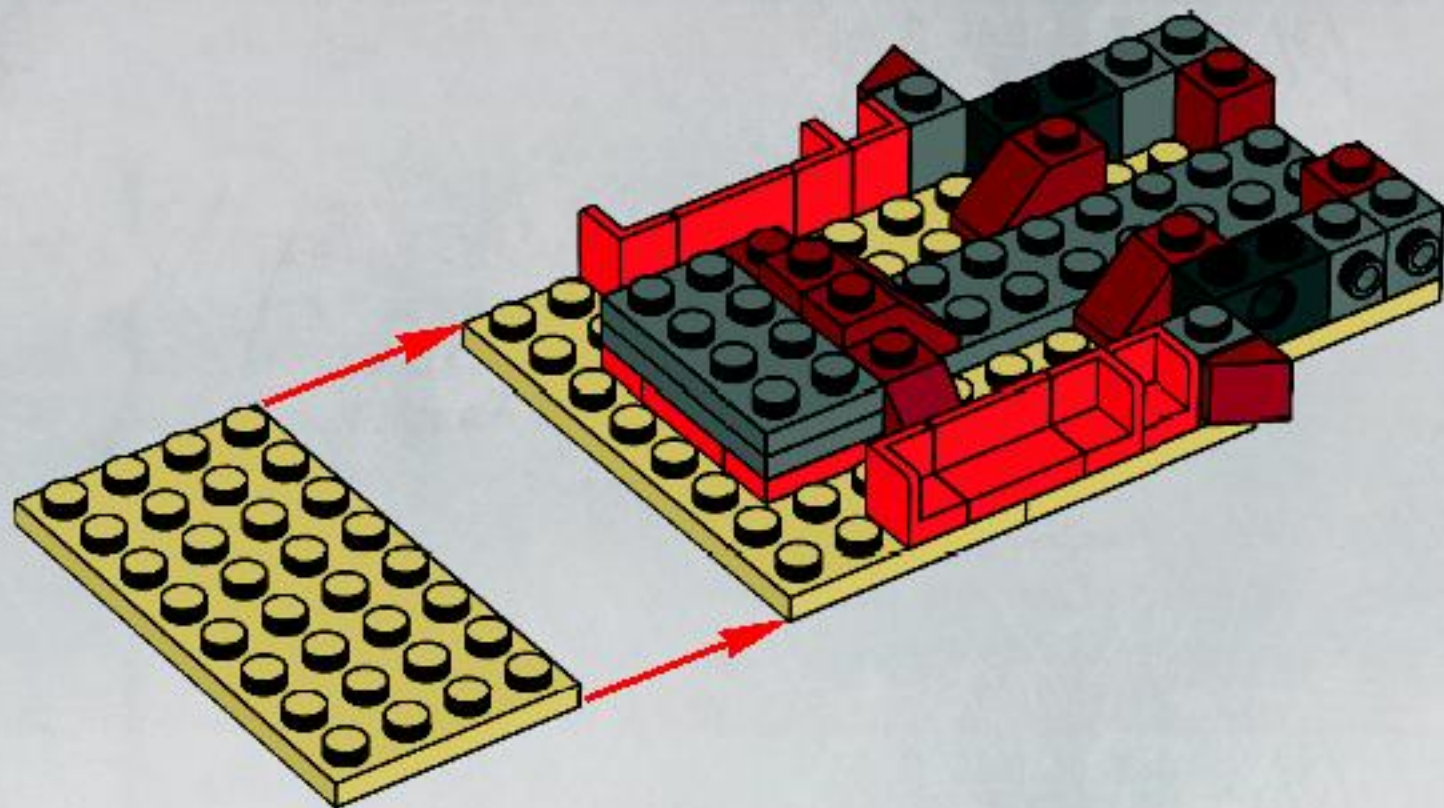



1x



2x

15

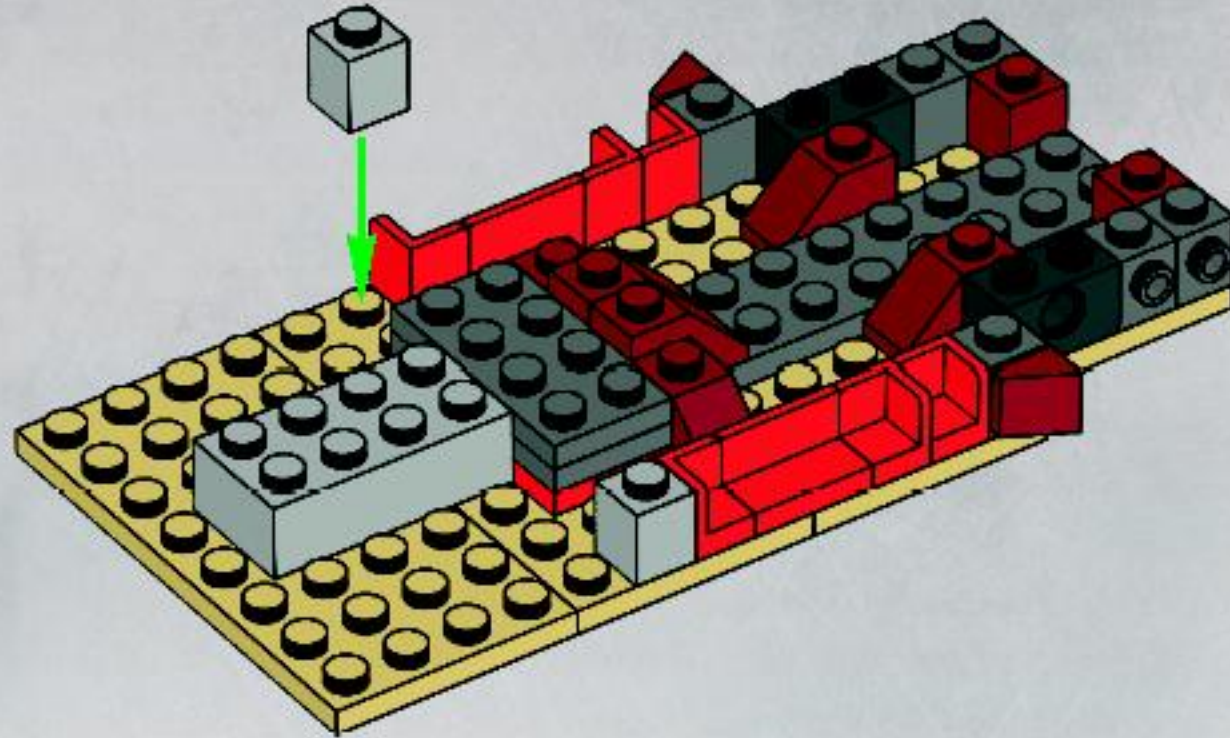



2x

16

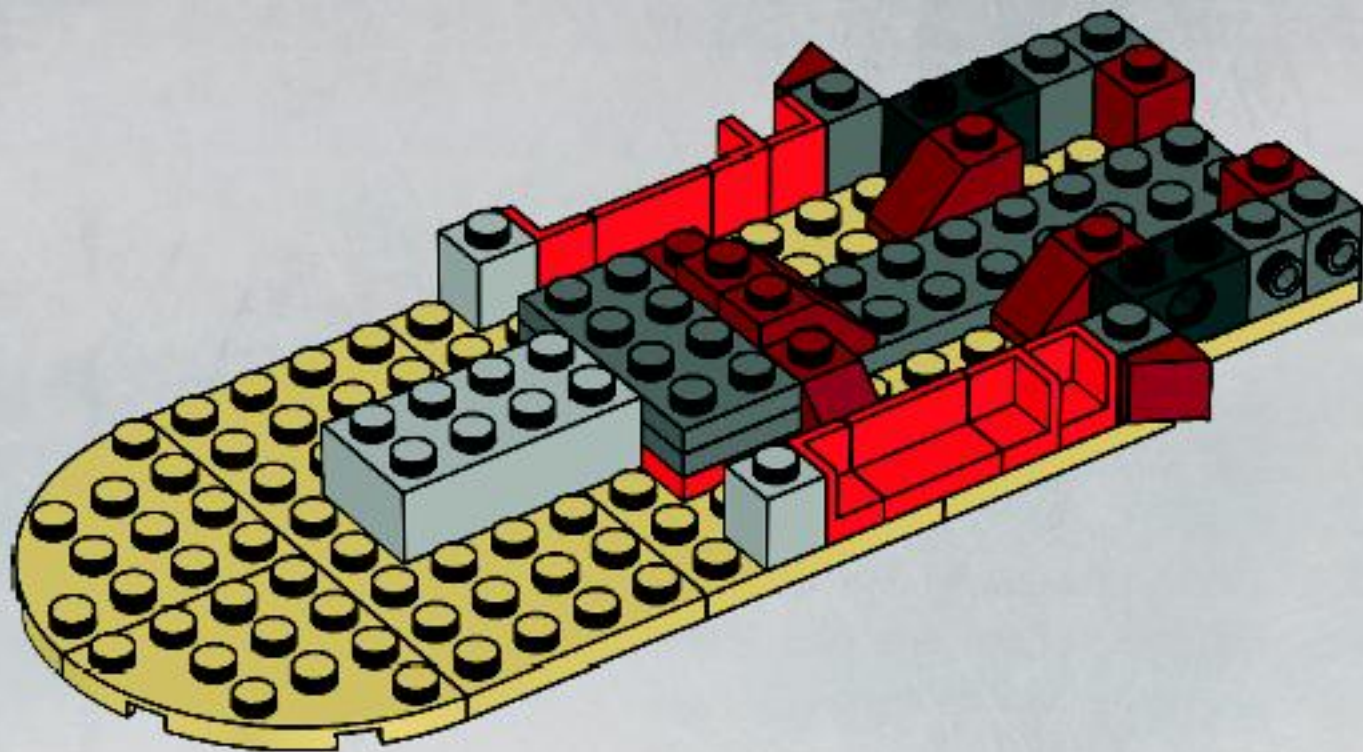

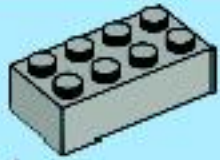

1x

17

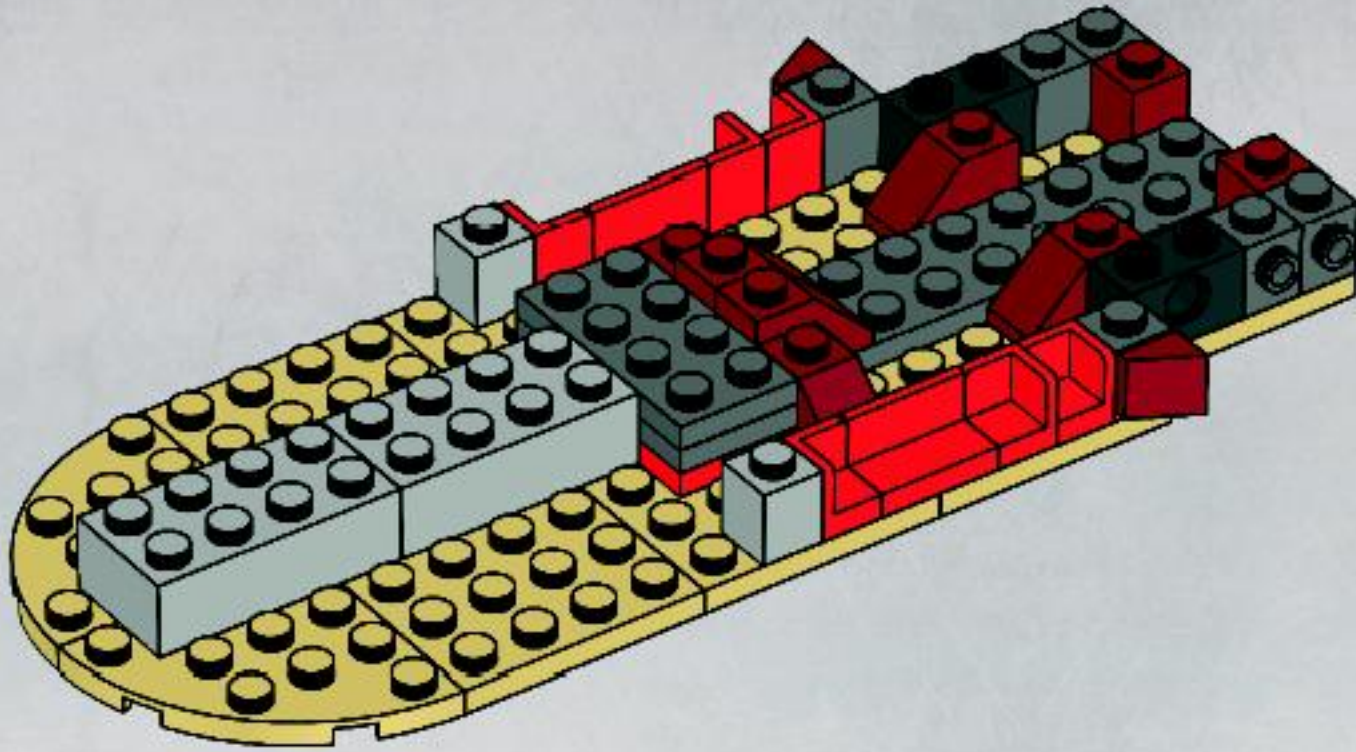

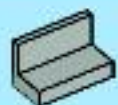

3x

18

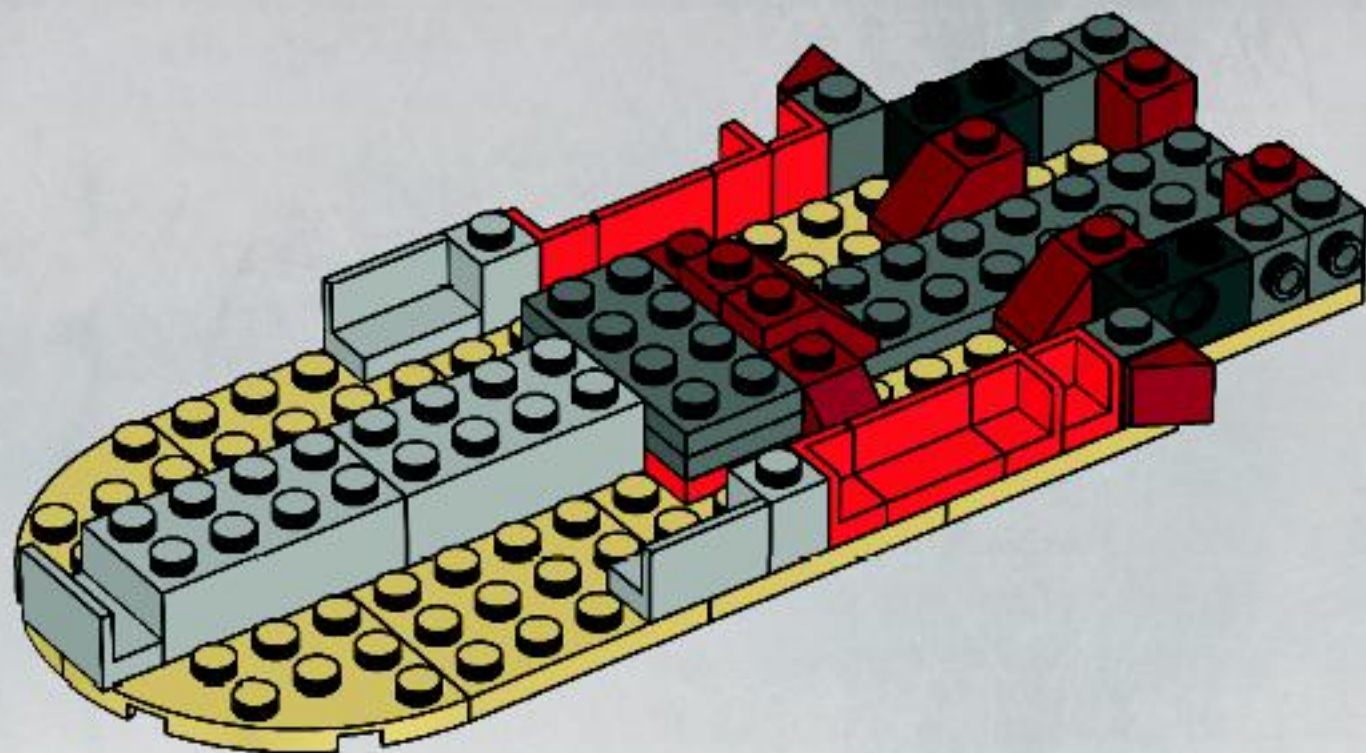

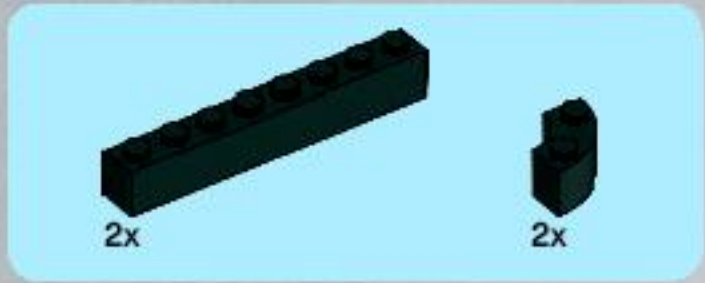

19

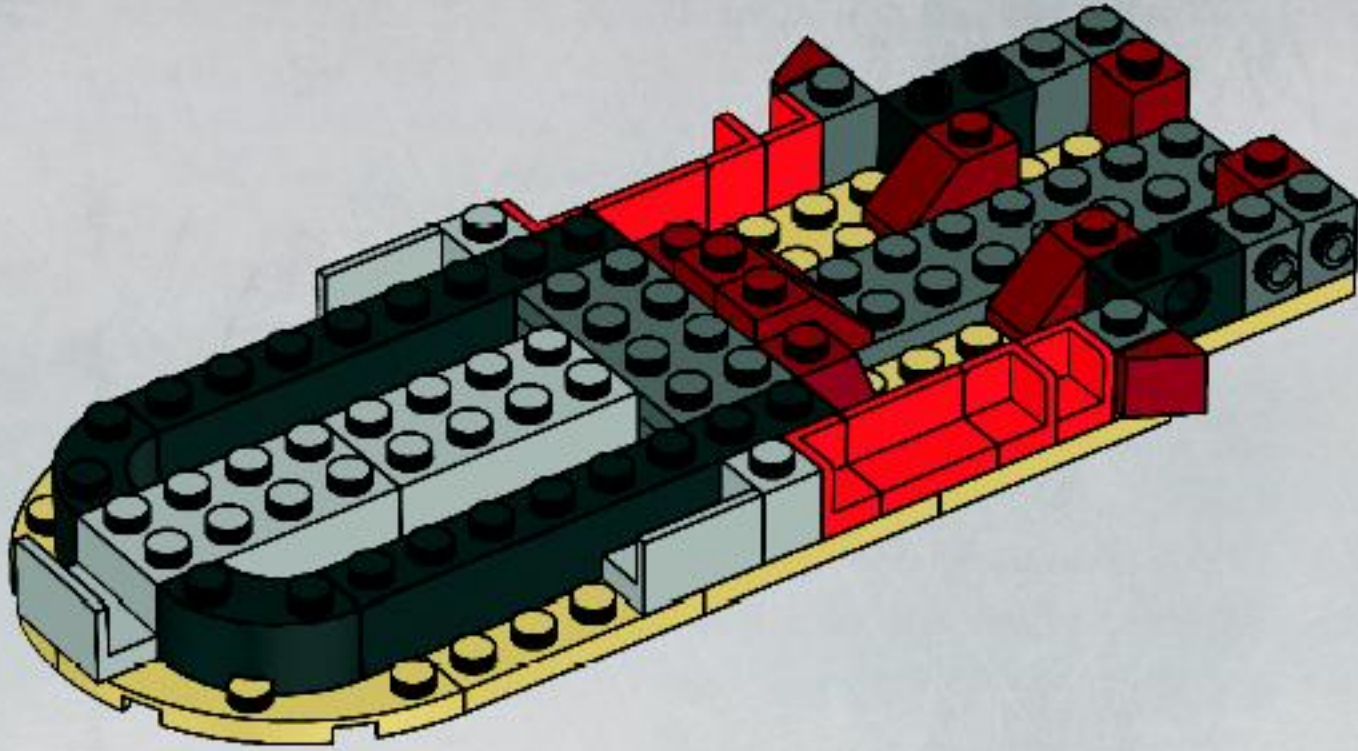



2x



2x

20

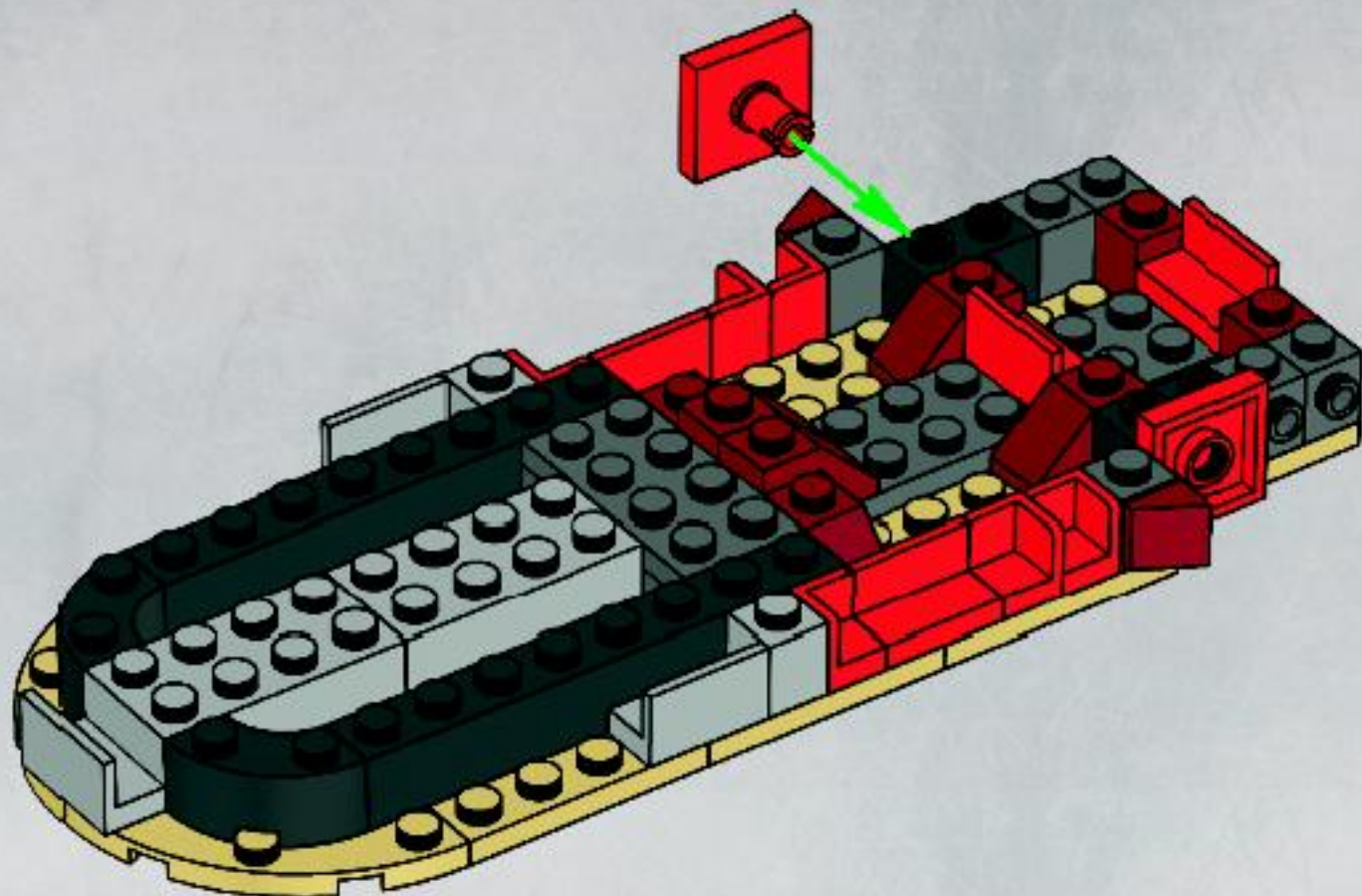



2x



2x

21

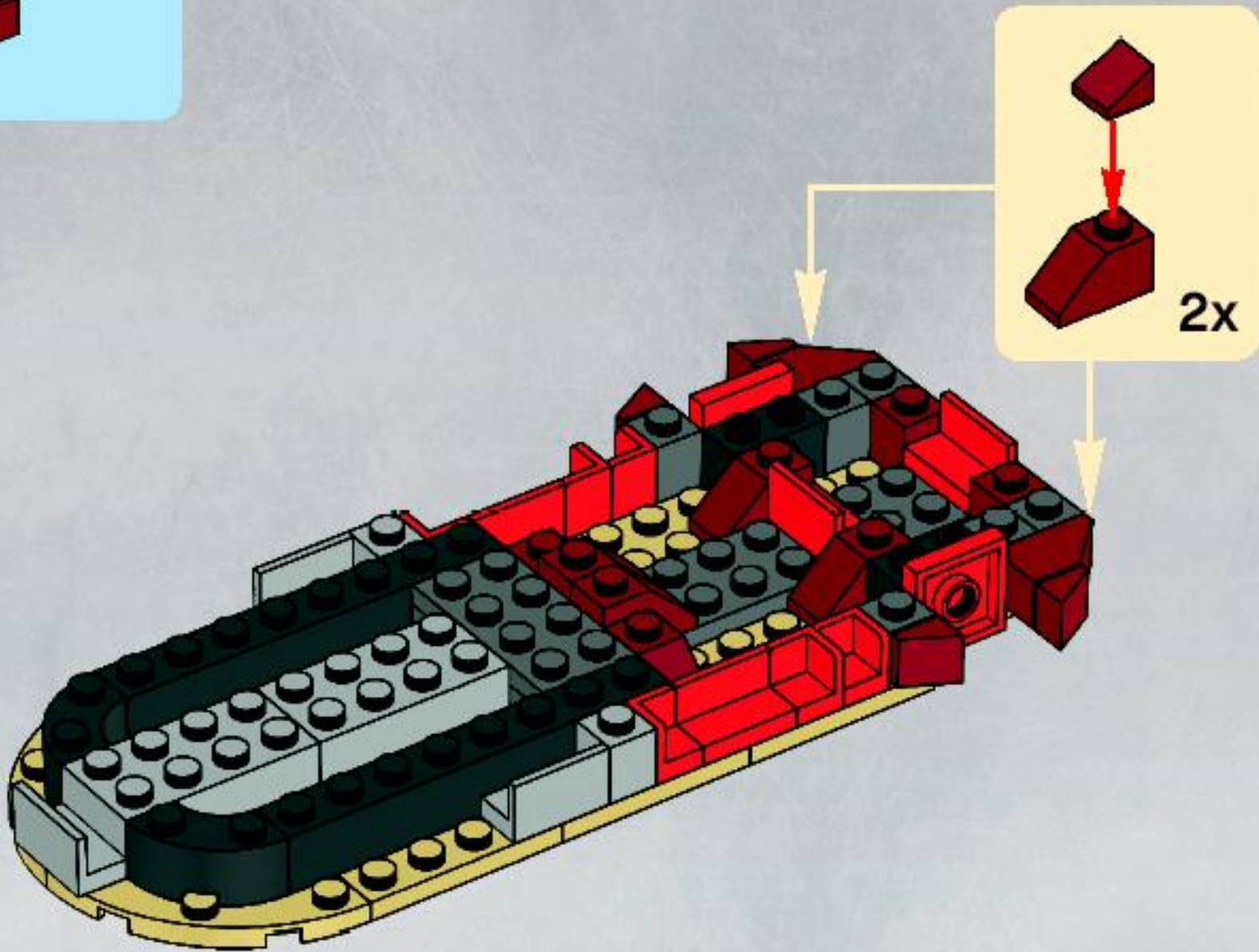



2x



2x

22

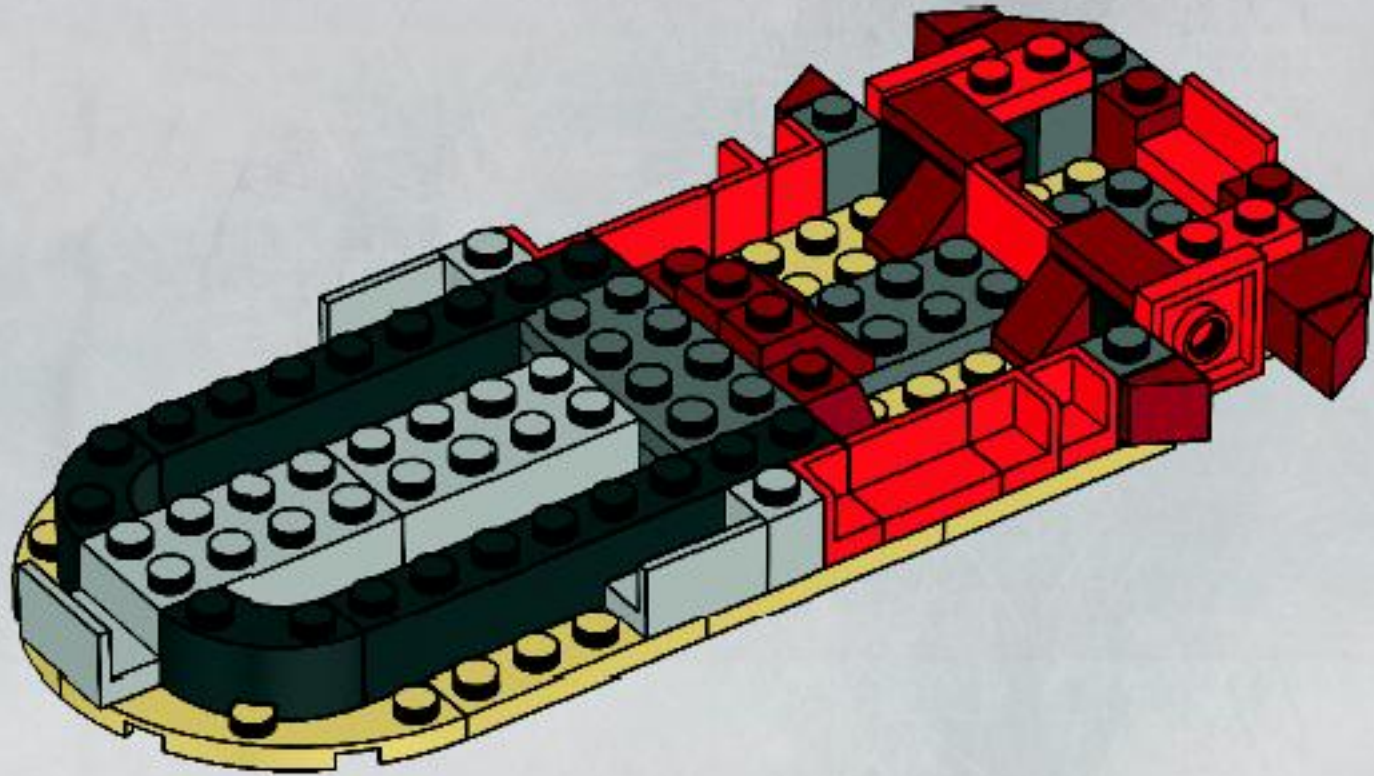



2x

23

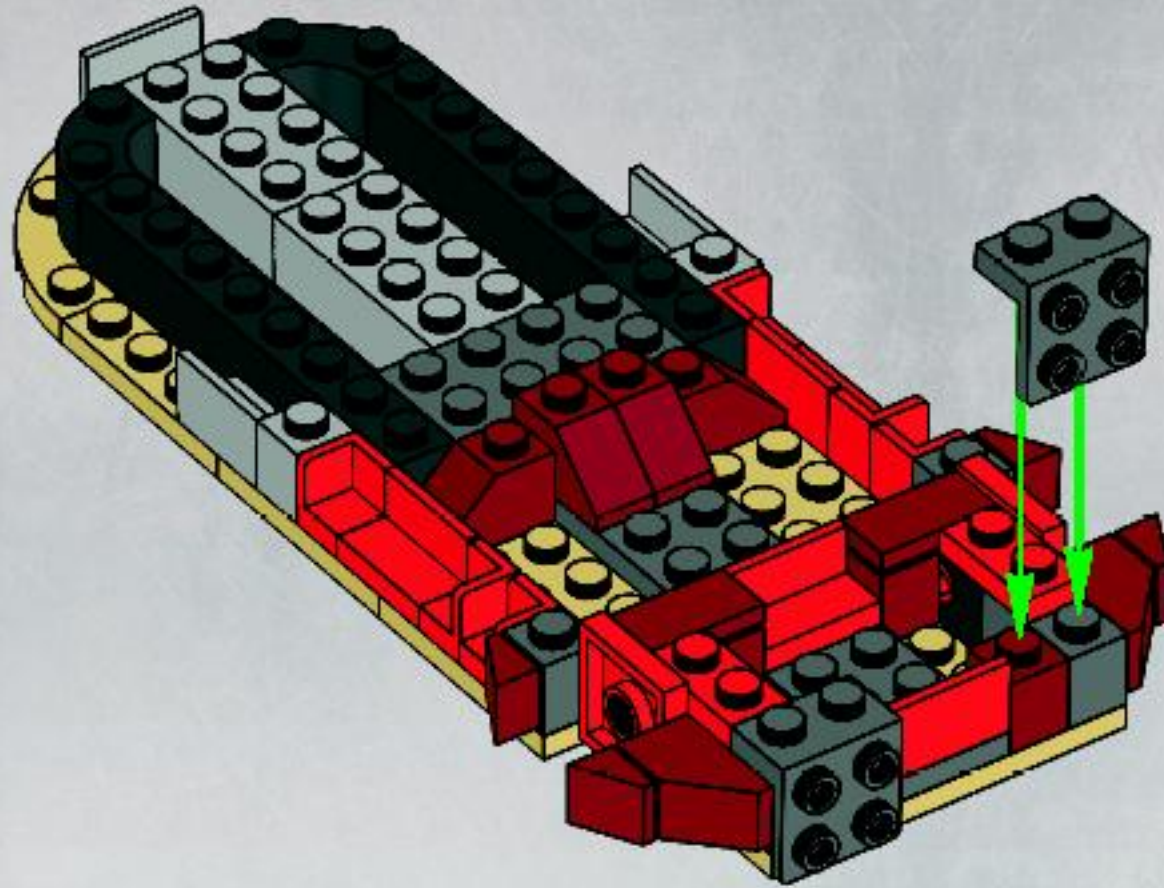



4x

24

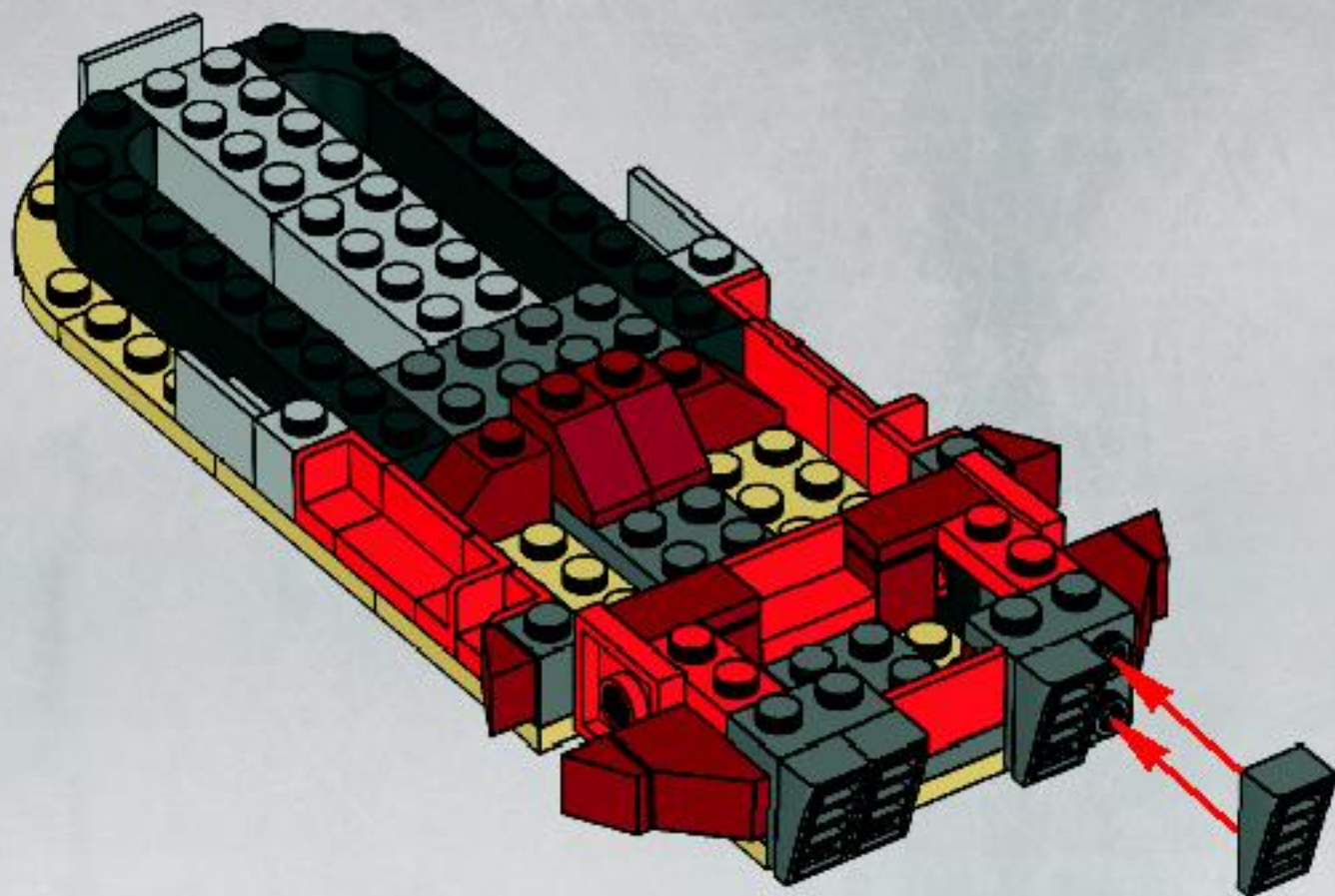

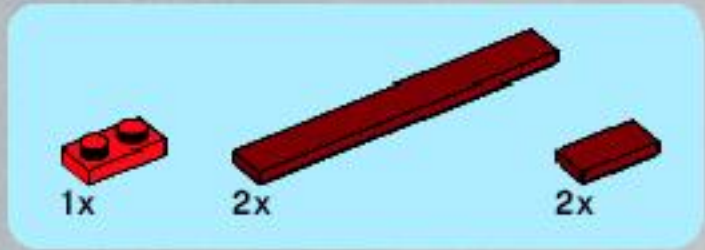

25

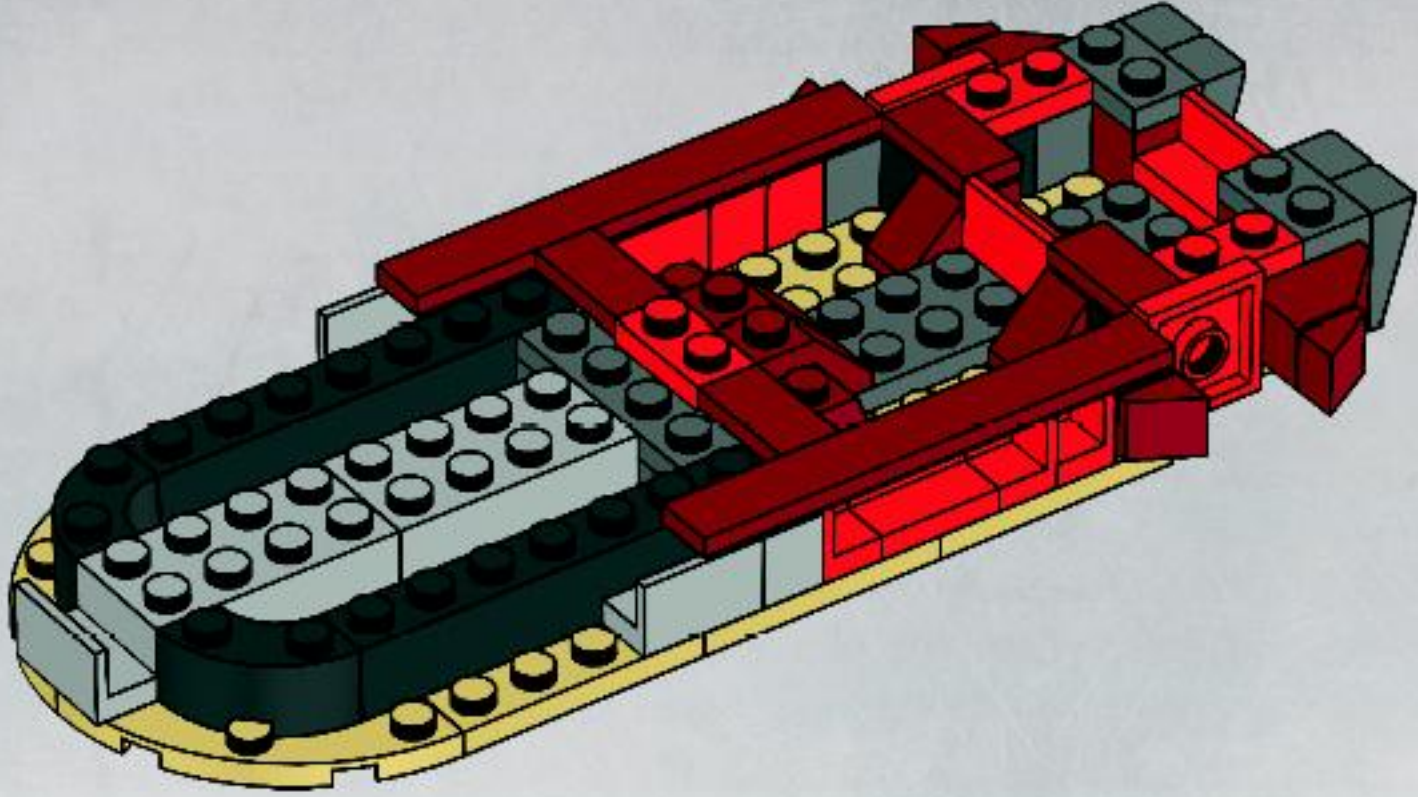



1x



1x



1x

26

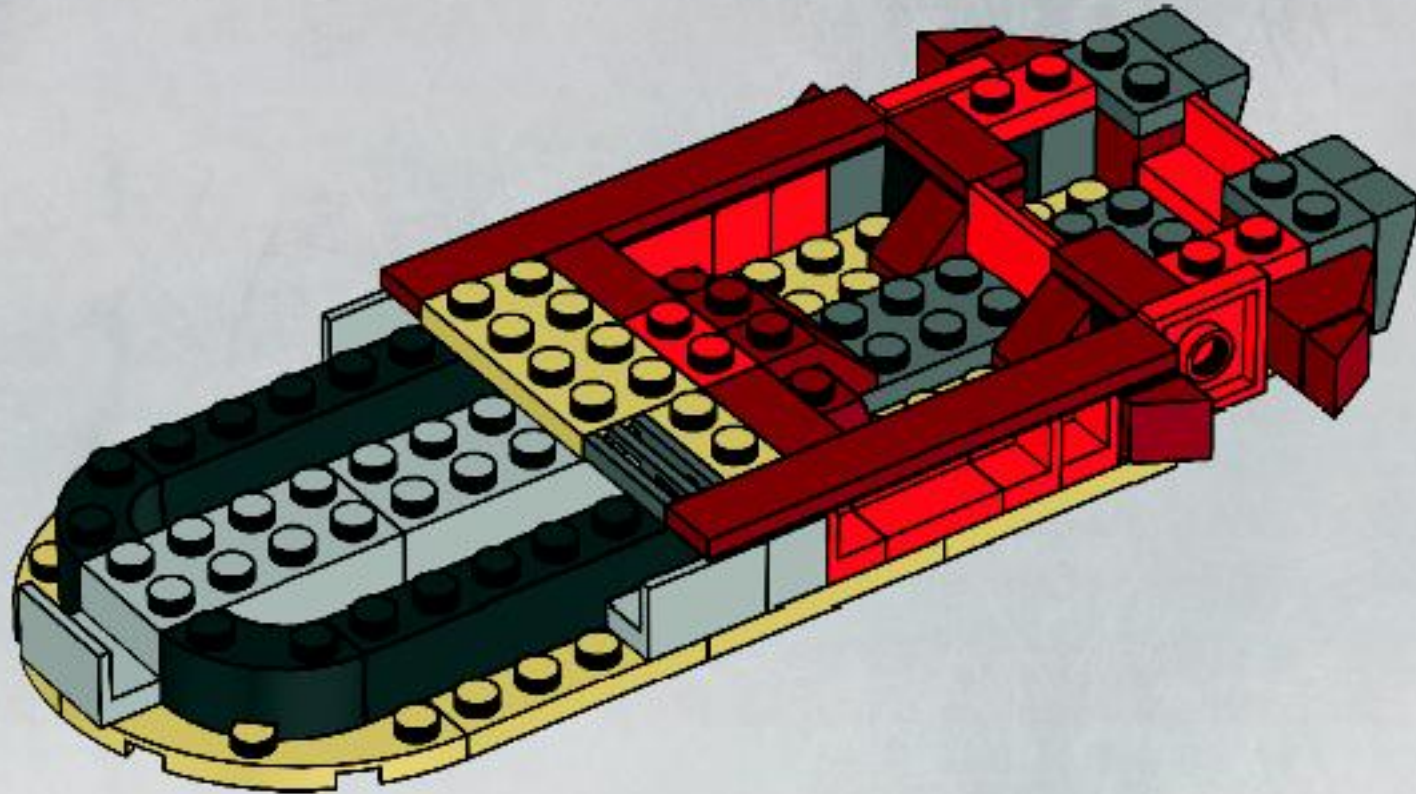



27

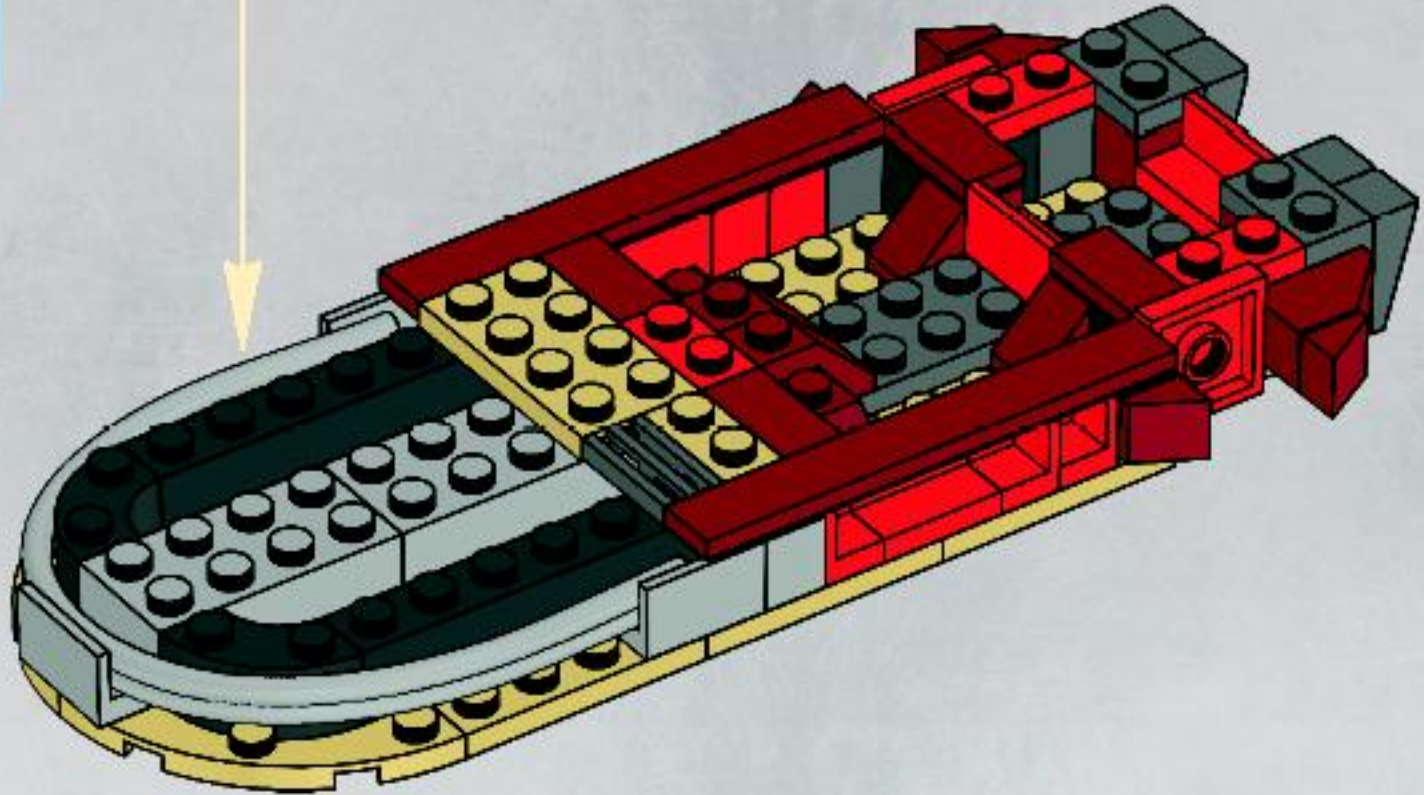



1x

28

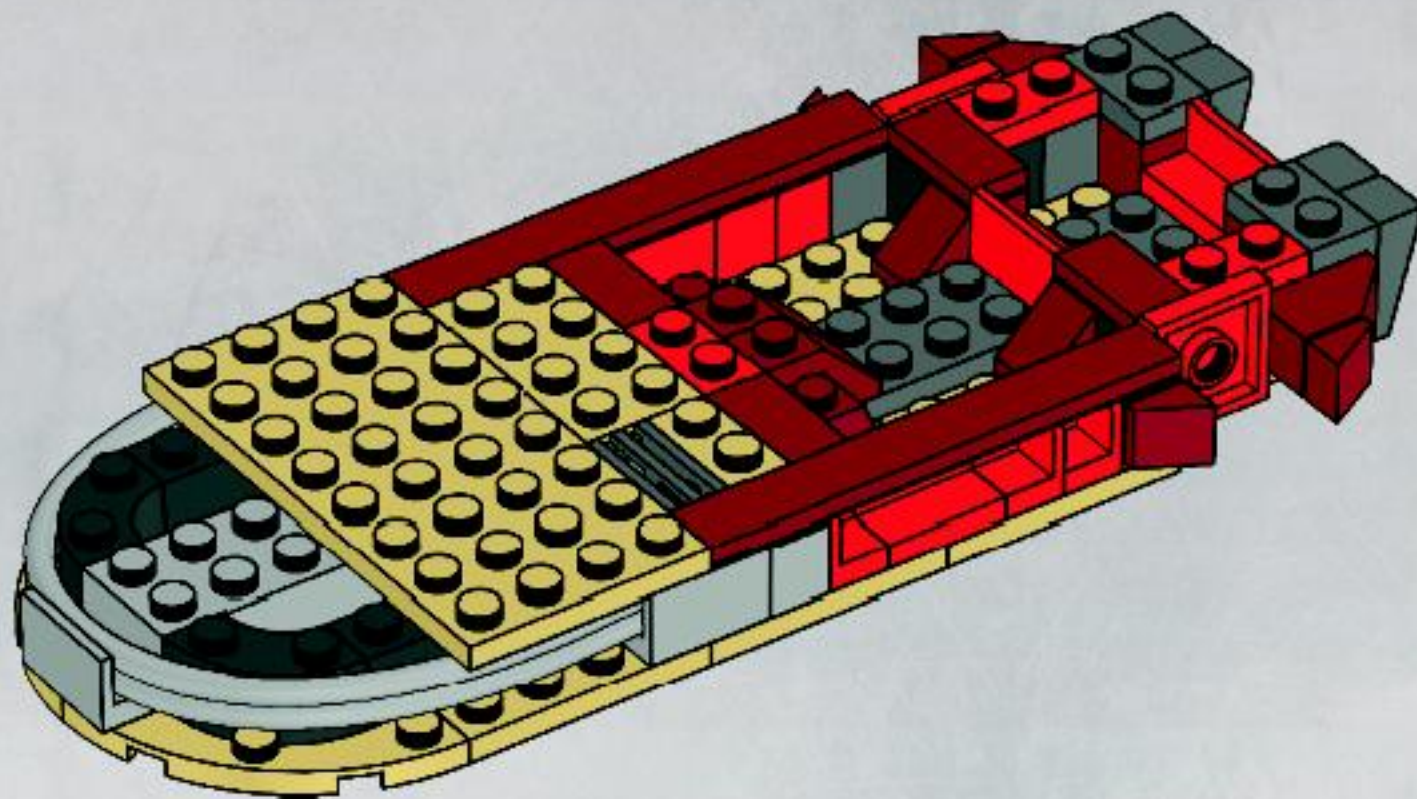



2x

29

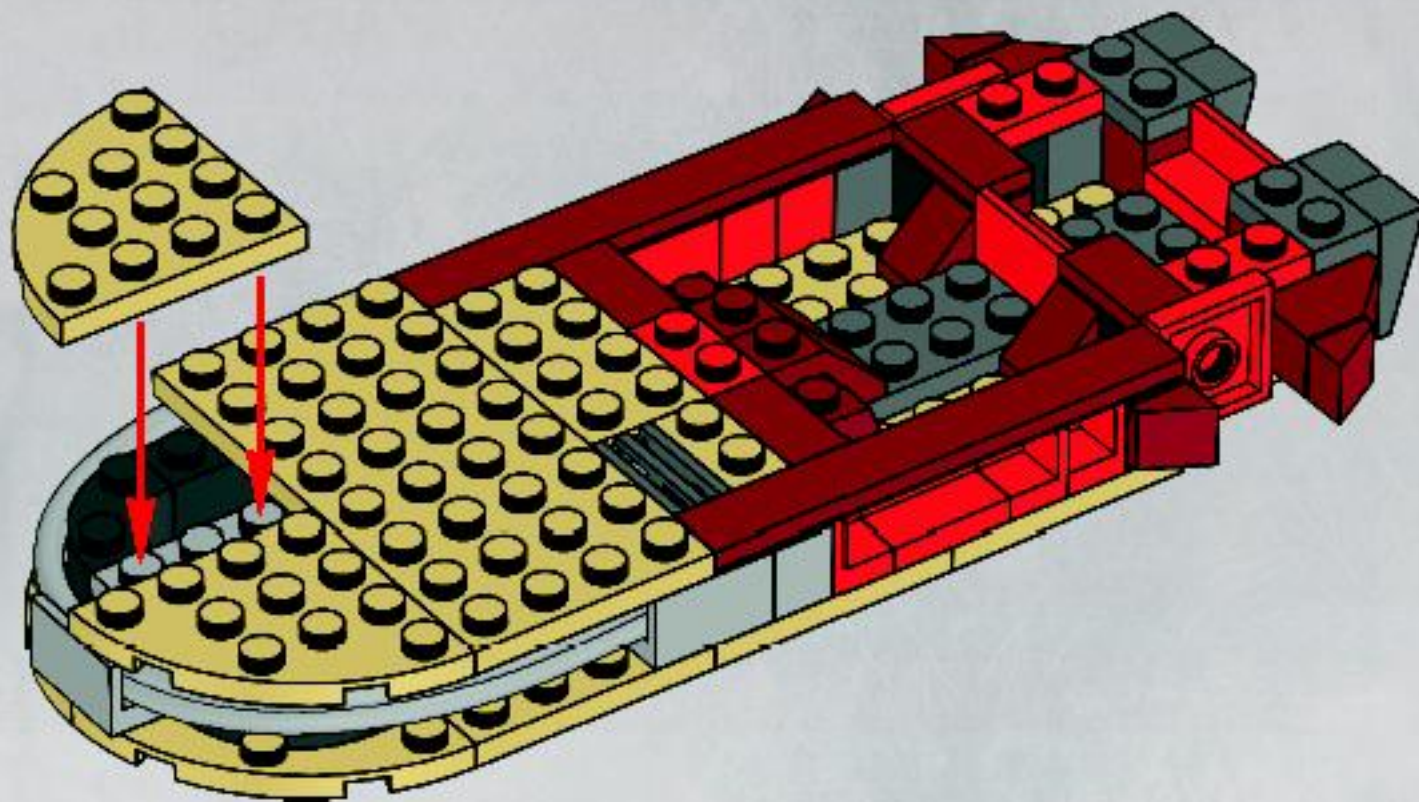



7x

30

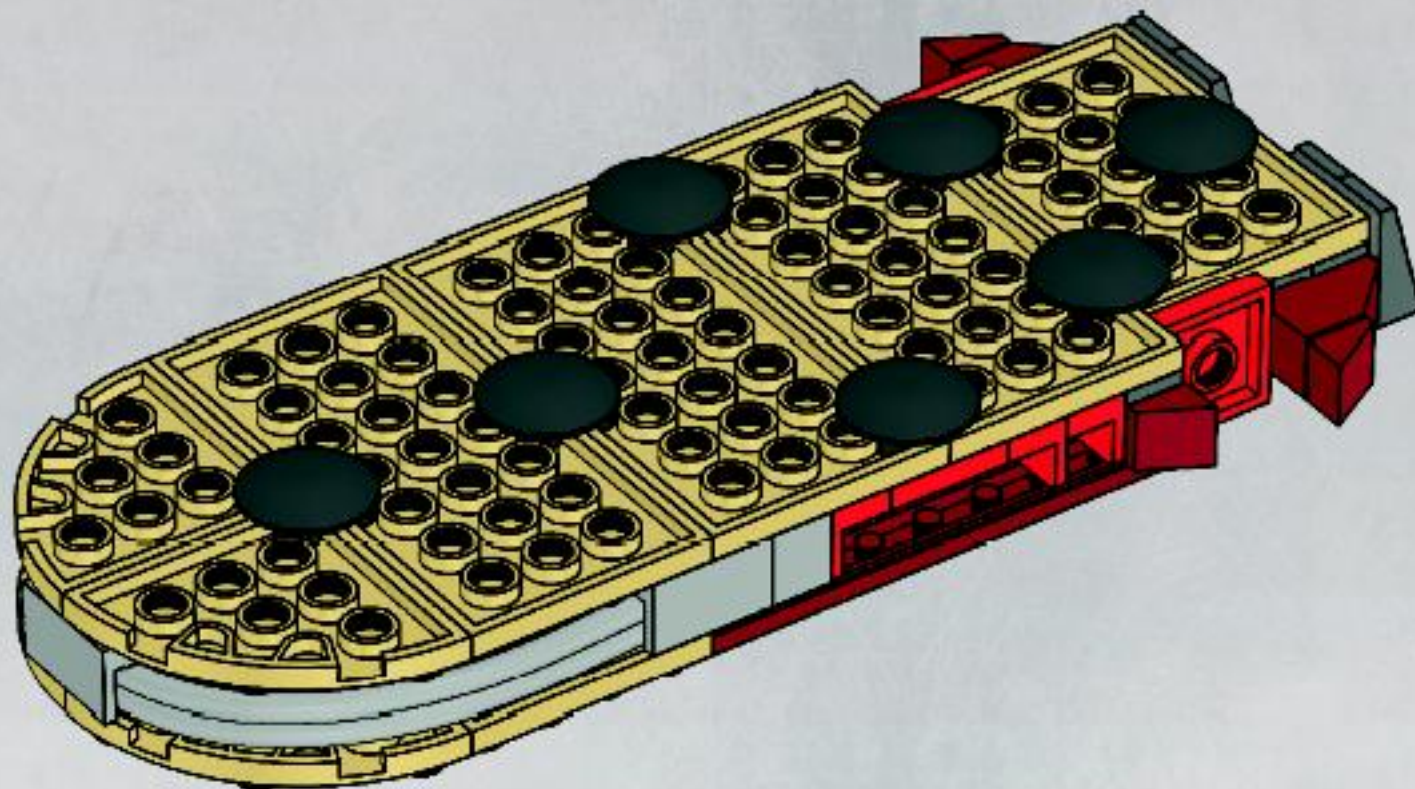



1x



5x

31

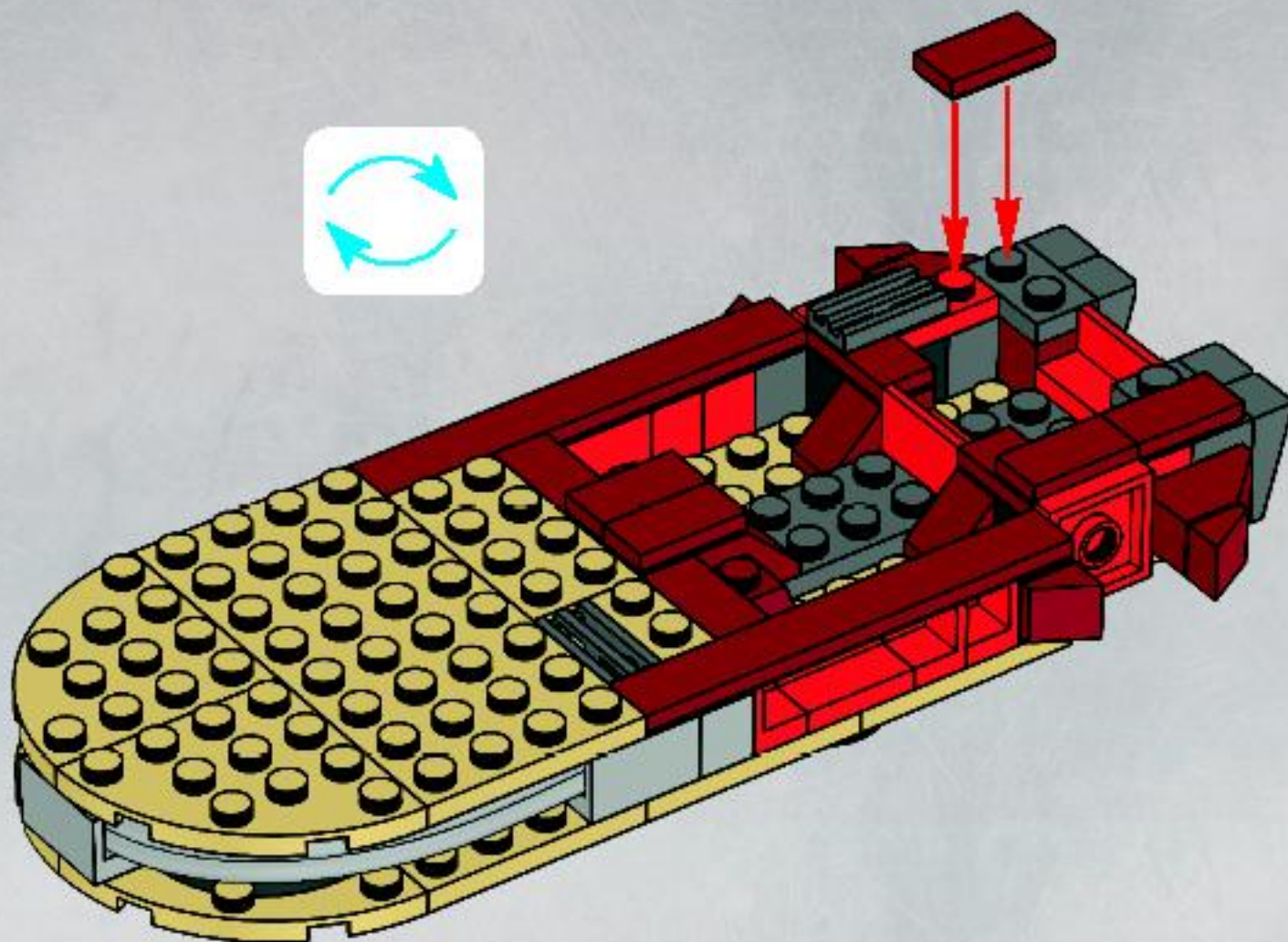



32

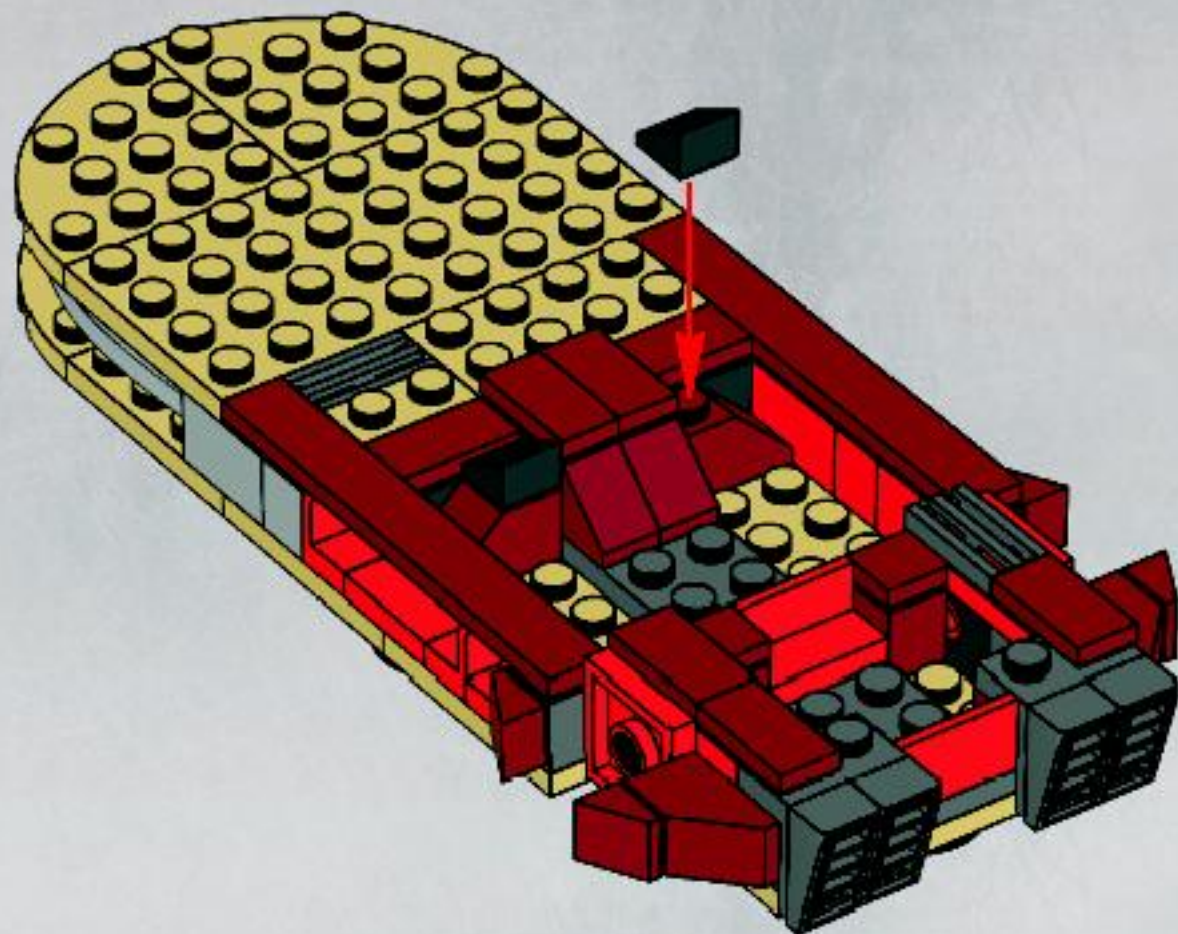



1x

33

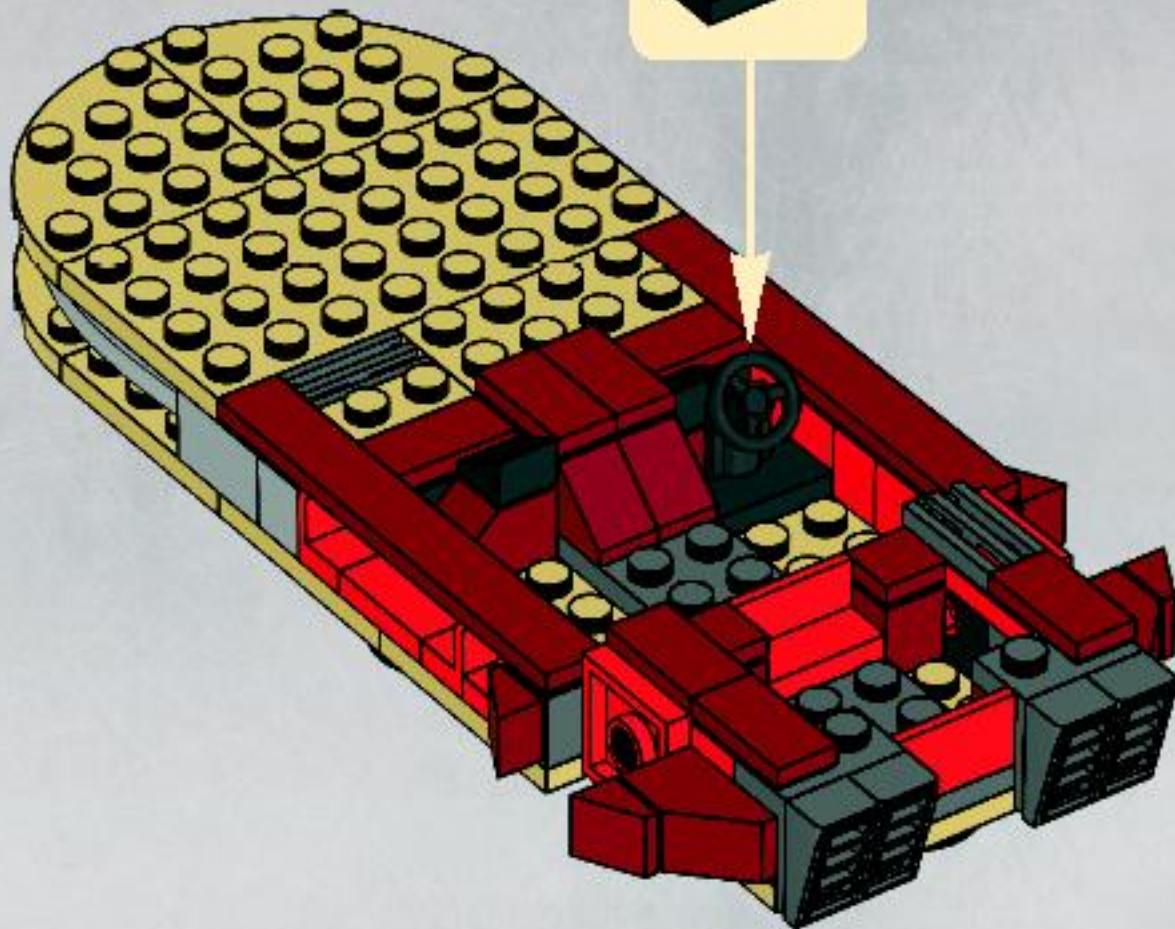



2x

34

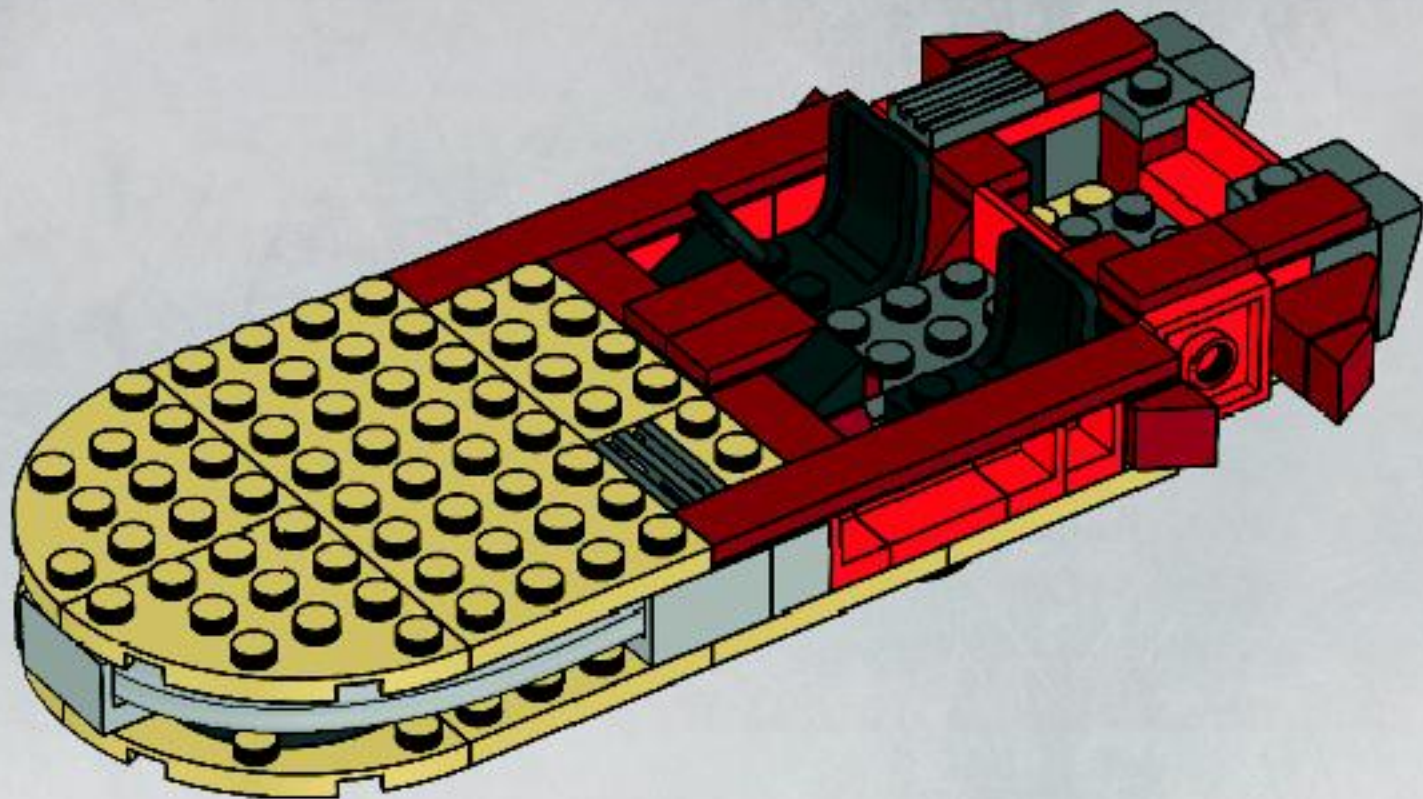



2x



1x

35

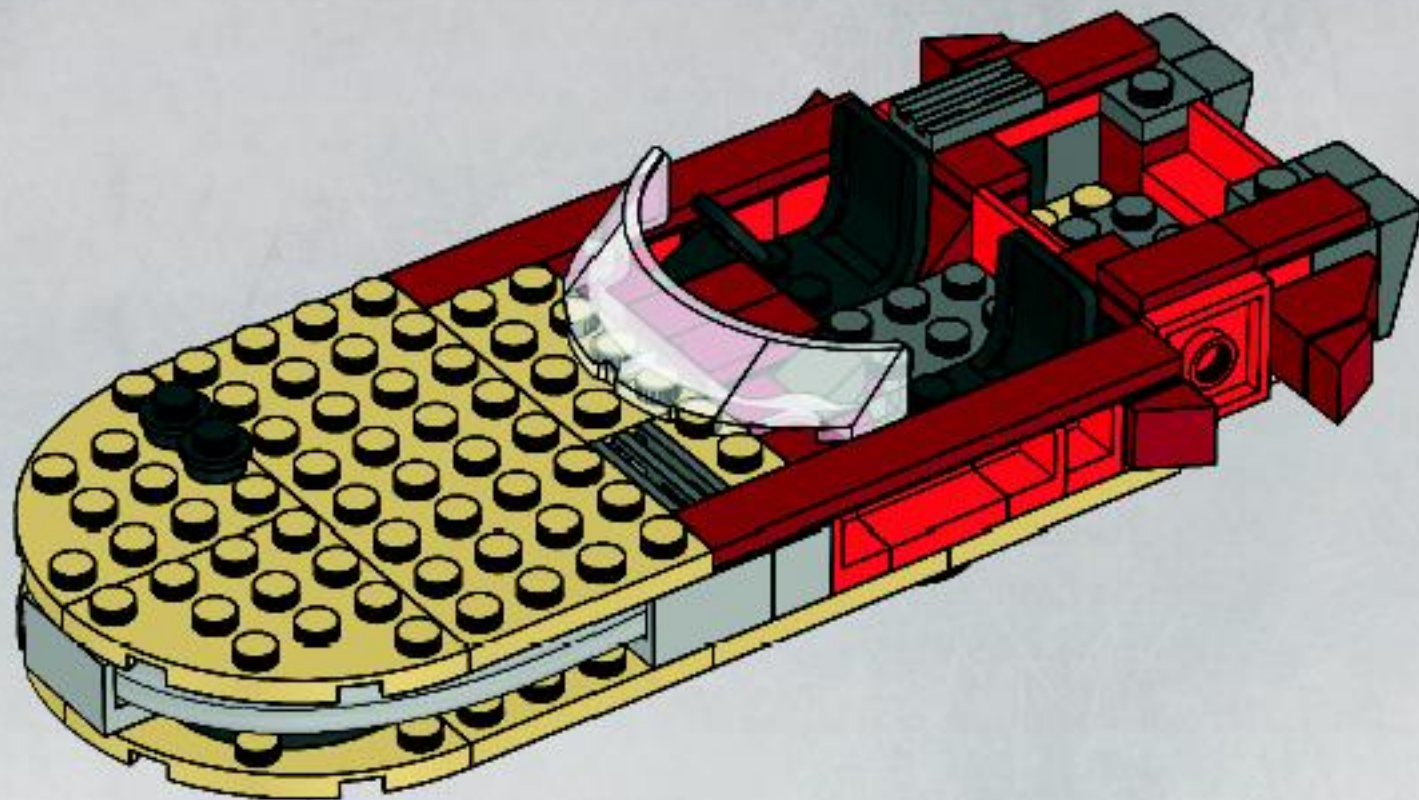



5x

36

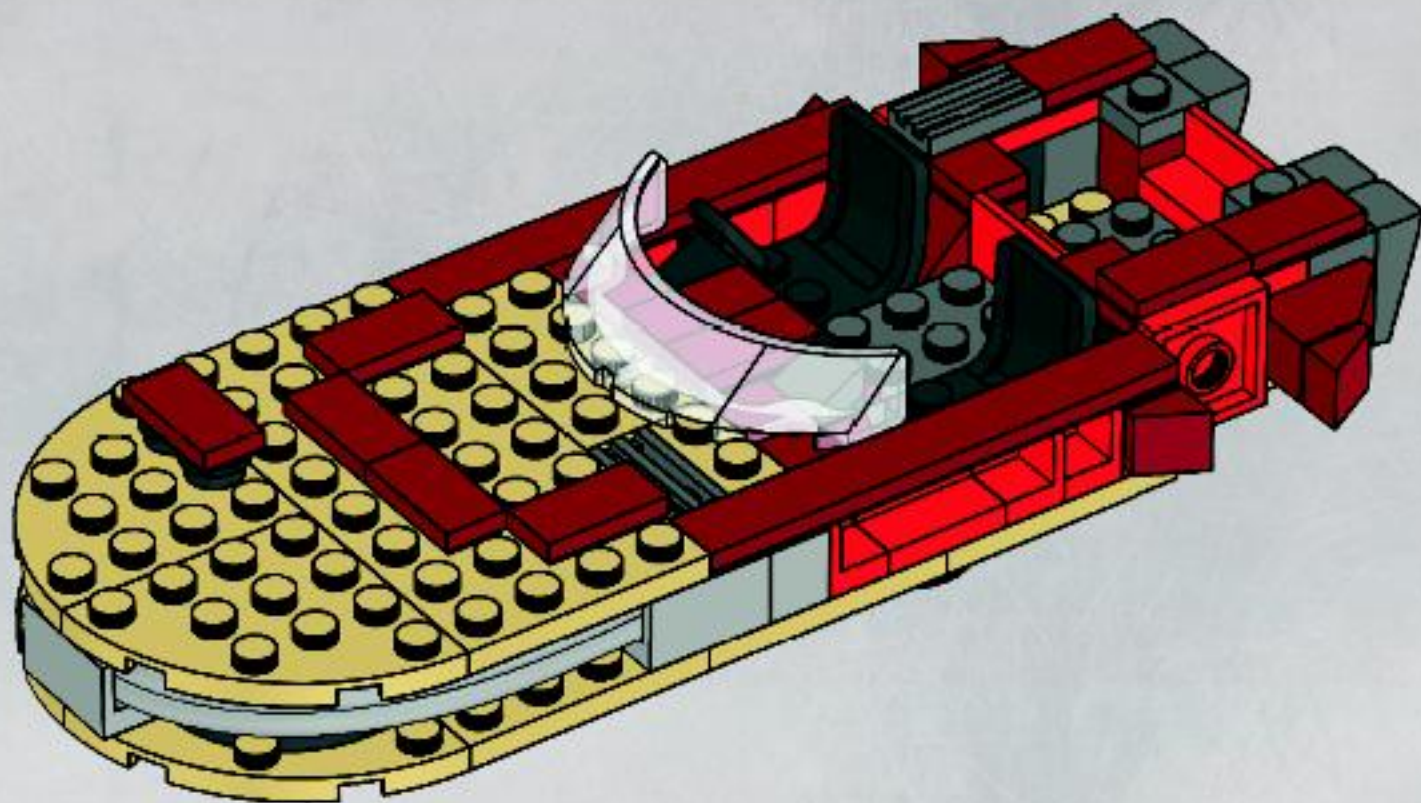



1x



1x

37

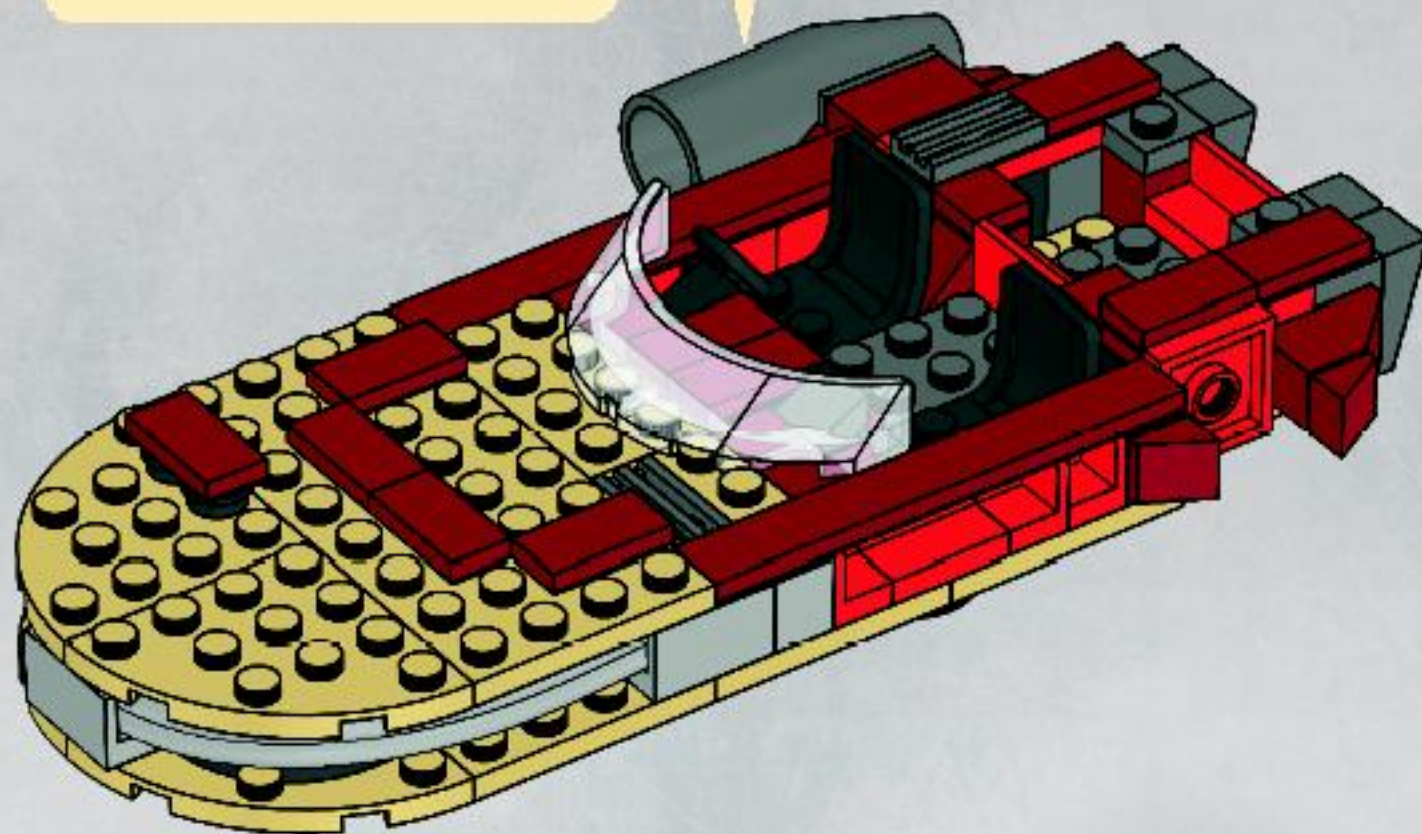
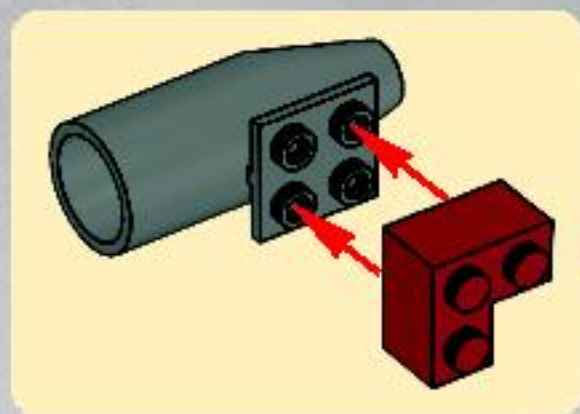



2x



1x



1x

38

1

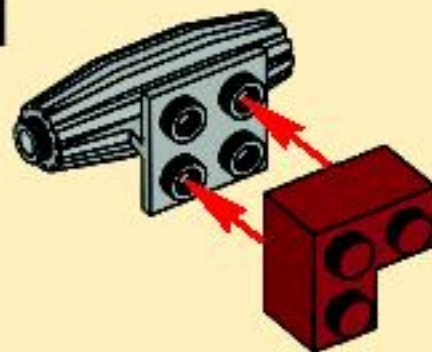

2

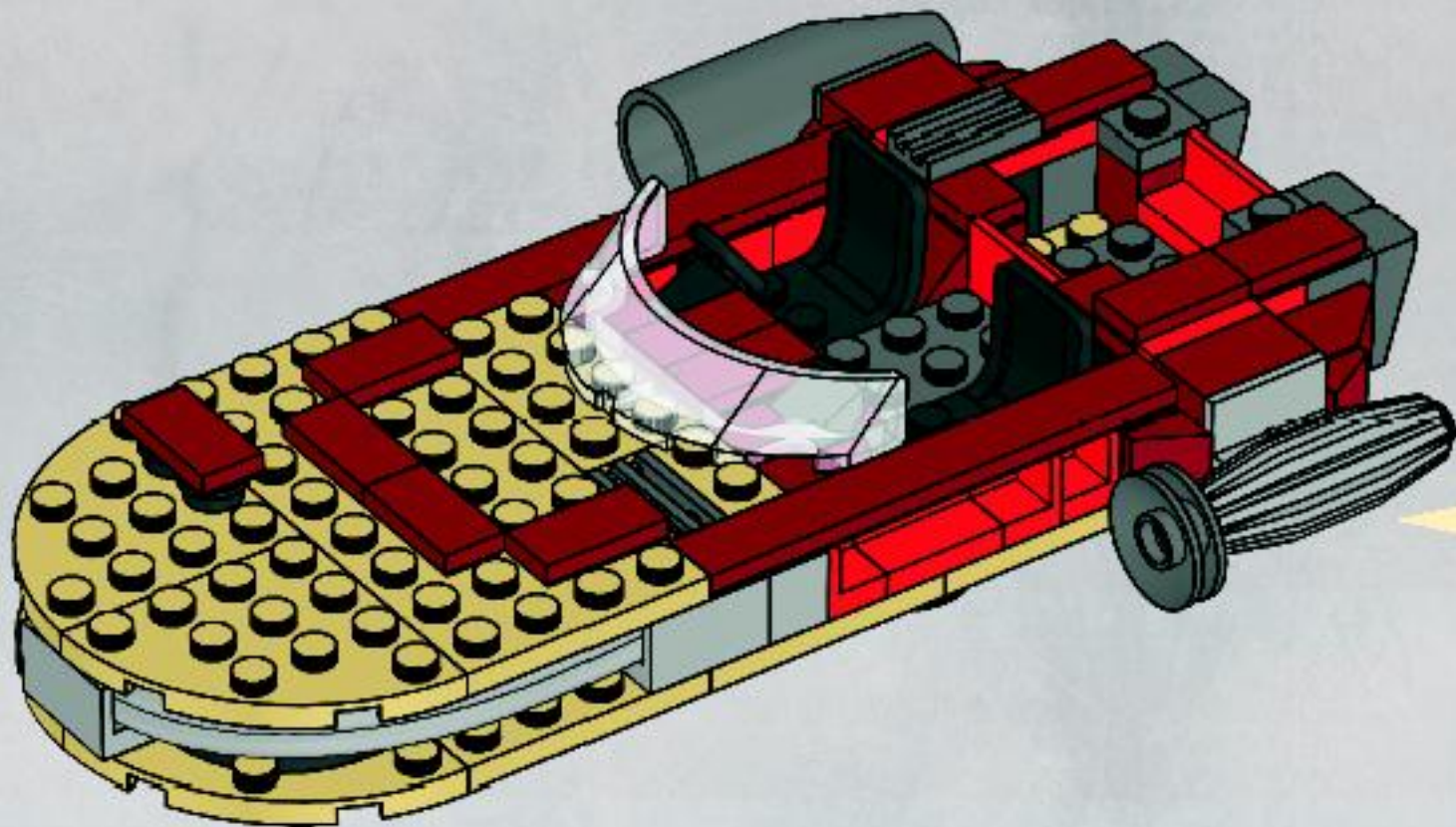
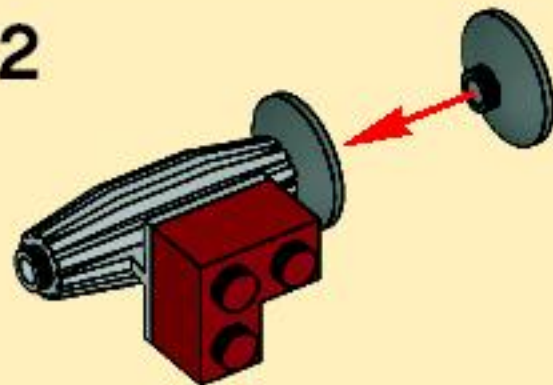



1

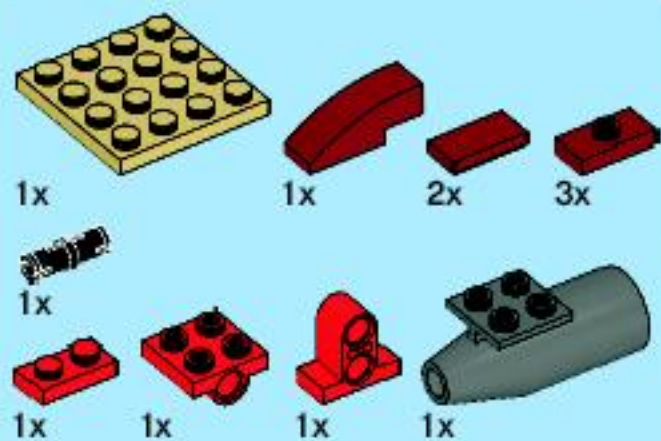
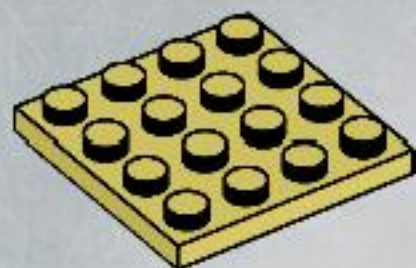

2

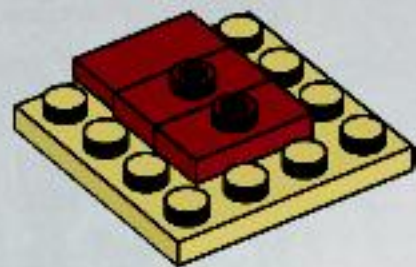

3

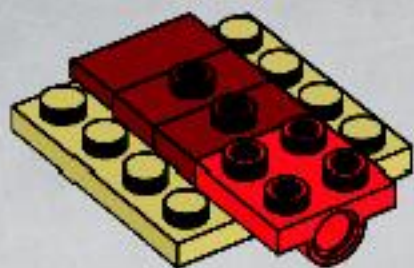

4

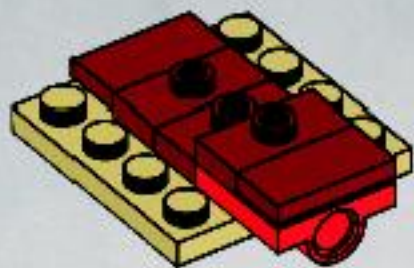

5

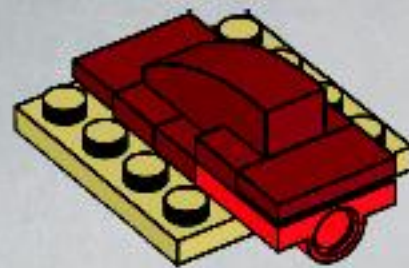

6

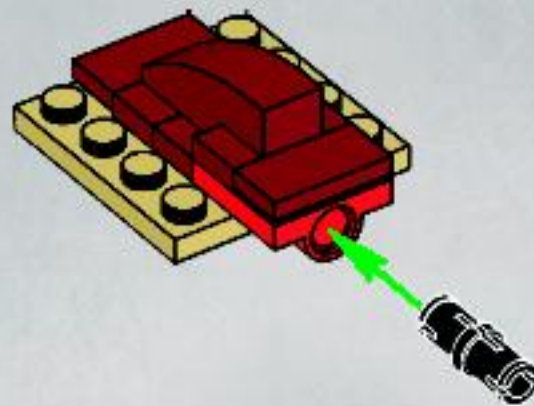

1

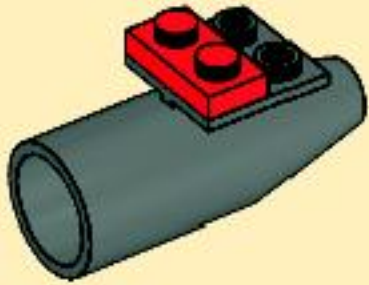

2

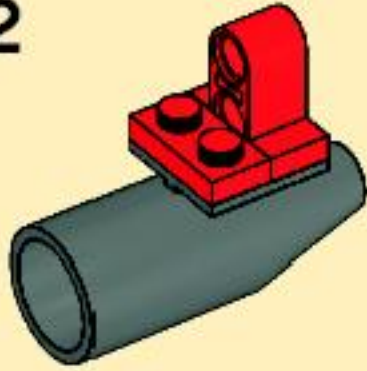

7

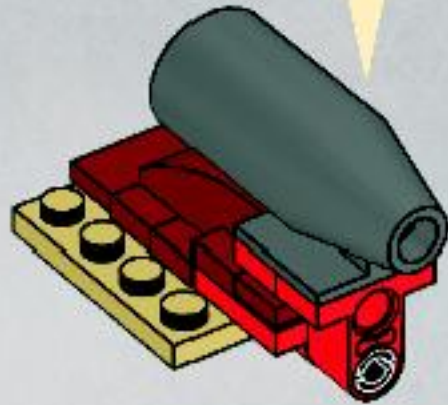

39

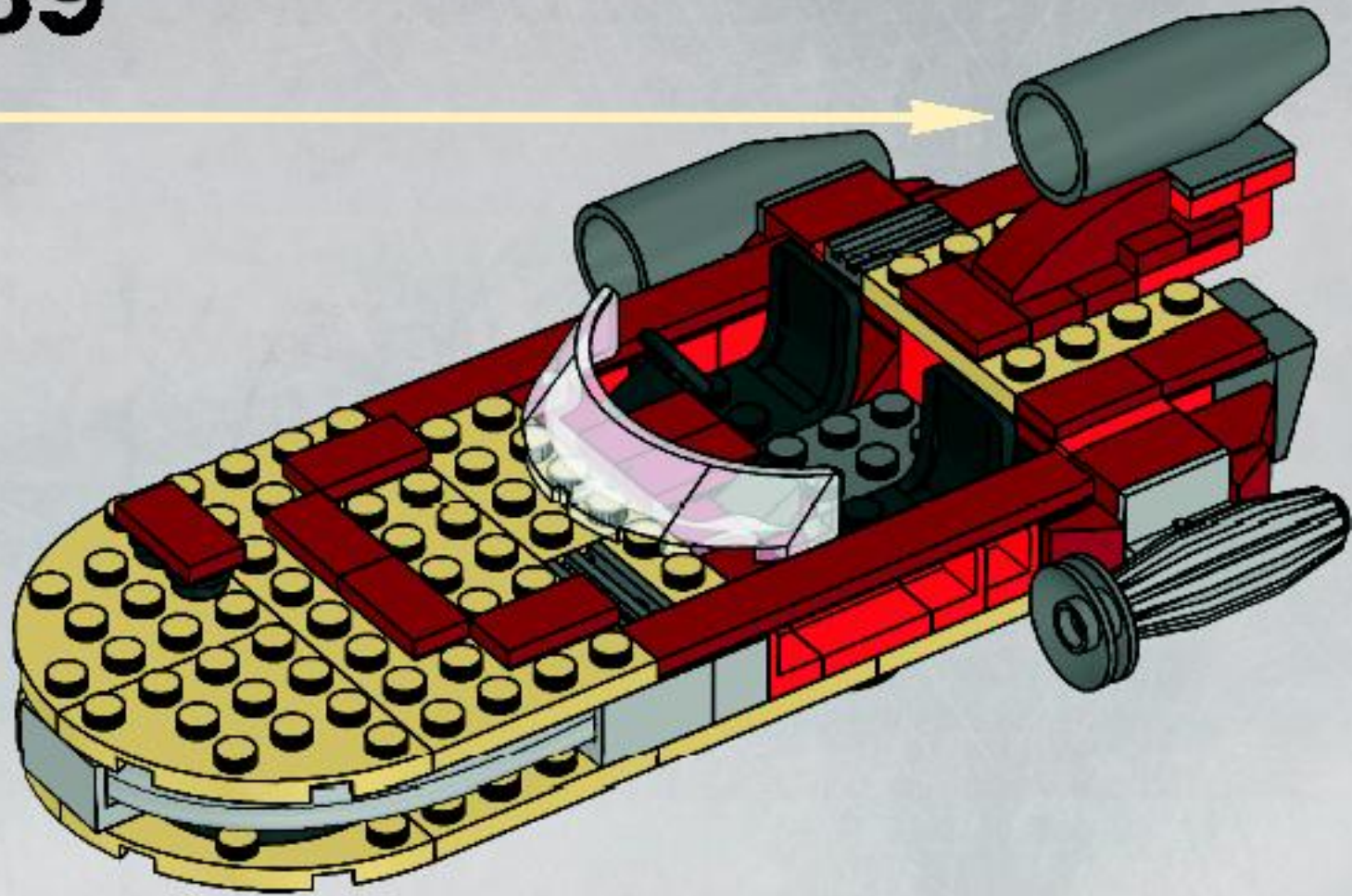

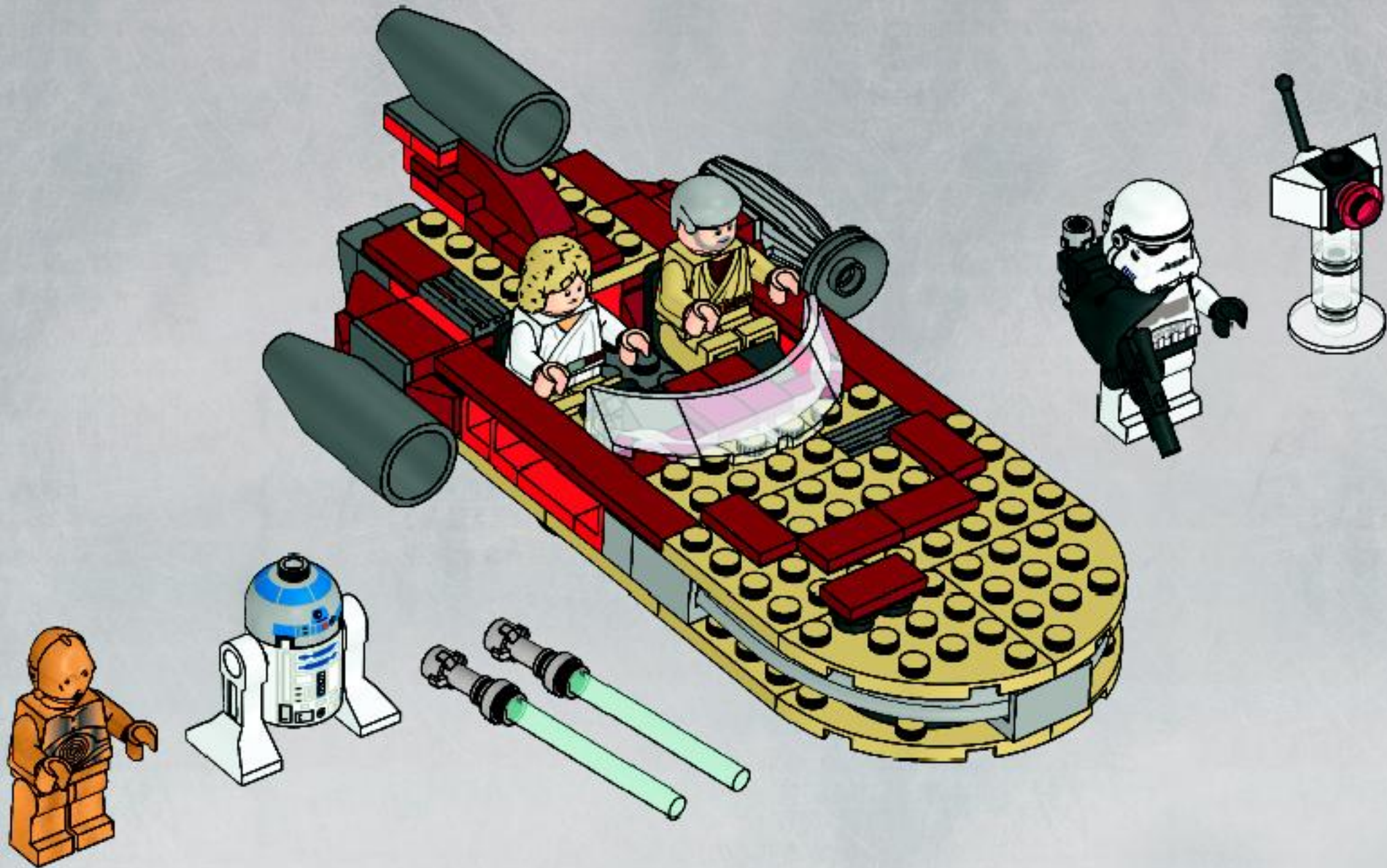



1x
4510082



1x
4275255



2x
4124113



1x
4194011



2x
4504369



1x
73737



1x
74326



1x
4142954



2x
4548731



1x
4513706



1x
4243824



1x
4114001



4x
4509897



4x
4570516



1x
4113917



1x
4114309



1x
4510084



1x
4107623



1x
4510090



2x
246021



1x
244421



7x
302321



6x
4190219



4x
486521



1x
4207715



2x
614126



2x
300826



2x
4567436



2x
370026



2x
4504382



2x
255526



1x
4140588



7x
4278359



2x
407926



1x
473326



1x
4570544



1x
362626



1x
4498713



1x
73081



1x
4121715



1x
3005741



2x
4124073



2x
3006840

1x
4187750

4x
4531415

3x
4539063



4x
4540386

1x
4523573

8x
4541526

2x
4211389

2x
4210631

2x
4541376

1x
4541546

2x
4211385

1x
4569754

2x
4277928

2x
4541379

16x
4539090

1x
4533122

1x
4569715

2x
4211010

2x
4539083

1x
4211740

1x
4512015

1x
4210469

3x
4211515

1x
4512021

2x
4579639

2x
4539481

1x
4512225

2x
4211065

1x
4579635

6x
4558955

1x
4210678



Customer Service

Kundenservice

Service Consommateurs

Servicio Al Consumidor

www.lego.com/service or dial



00800 5346 5555 :



1-800-422-5346 :



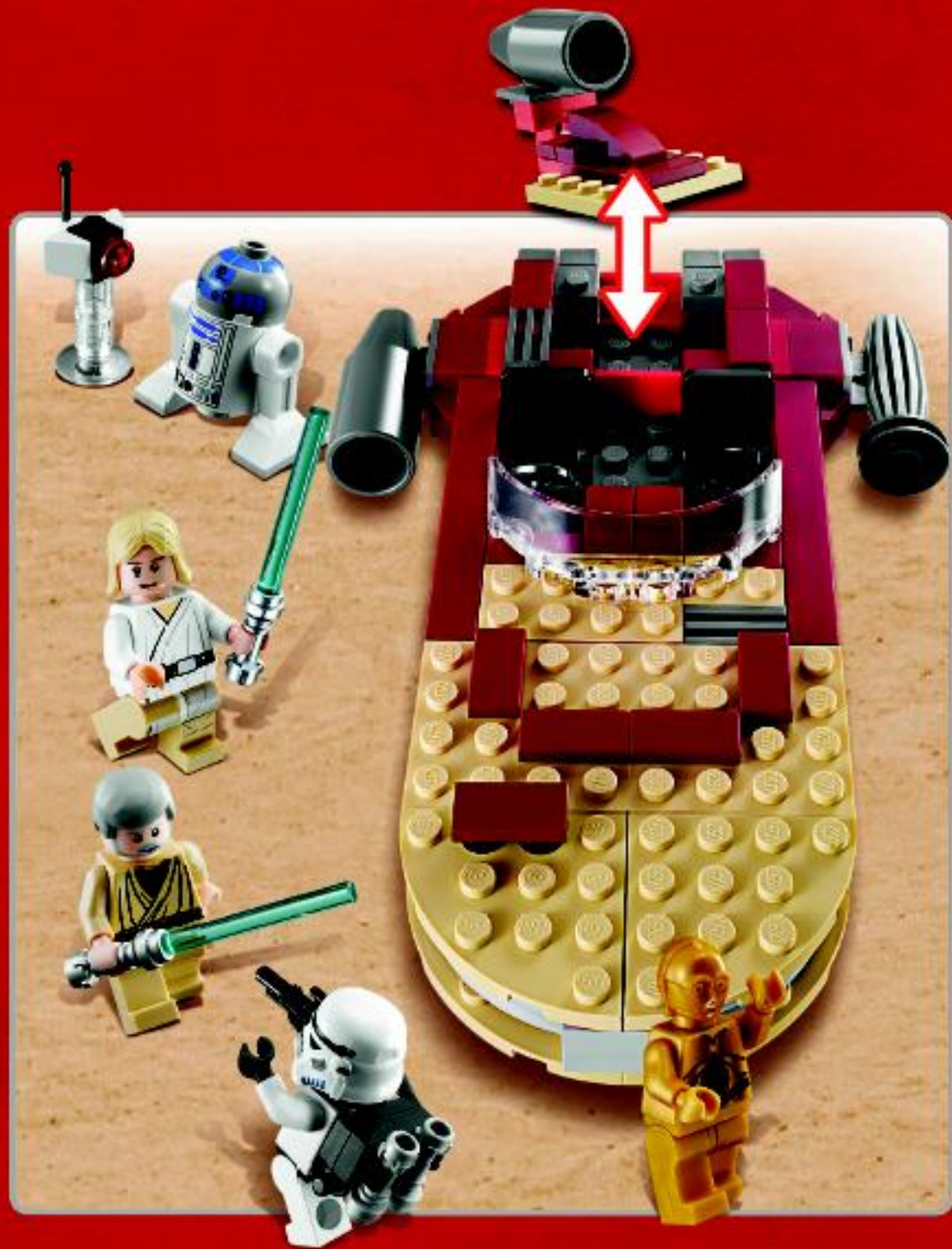



8083



8084



8085



8086



8087



8088

FREE! GRATIS! GRATUIT!



club
MAGAZINE™

www.LEGOclub.com



00800 5346 5555*        

  **1-866-534-6258 • 1-877-518-5346**

US & Canada only

Canada seulement

* Free phone. Mobile charges may apply. * Numéro sans frais. Les frais peuvent s'appliquer avec les téléphones cellulaires. * Geldfrei. Kosten für Anrufe aus Mobilfunknetzen können anfallen.
* Gratis telefonnummer vând vase la ră. * Deber este gratis, dar durtiger Pro Anrufe aus. * Det är gratis, ut du ringer från en mobiltelefon.



VISIT THE WORLD'S
BIGGEST LEGO® SHOP!

www.LEGOshop.com



WIN!

Go to www.nielsen.com/LEGO
to fill out a survey for a chance
to win a cool LEGO® Product.
No purchase necessary.
Open to all residents where not prohibited.



www.nielsen.com/LEGO

GEWINNE!

Nimm an der Umfrage auf
www.nielsen.com/
LEGO teil und hab die Chance ein cooles
LEGO® Produkt zu gewinnen!

Die Teilnahme am Gewinnspiel führt zu keinerlei
Kaufverpflichtungen. Teilnahme in allen nicht
ausgeschlossenen Ländern möglich.

WIN!

Ga naar www.nielsen.com/LEGO,
vul een enquêteformulier in en
maak kans op een
cool LEGO® product.

Geen aankoopverplichting.
Iedereen mag deelnemen, uitgezonderd
ingezetenden
van landen waar een enquêteverbod geldt.

GAGNE!

Visite www.nielsen.com/LEGO
pour répondre à un questionnaire
et avoir une chance de gagner
un produit LEGO® très cool!

Aucune obligation d'achat.
Ouvert à tous les résidents des pays
autorisés.

当てよう!

www.nielsen.com/LEGO
にアクセスして、
アンケートにご記入ください。
当選者にはレゴ製品を
差し上げます。

お買い上げの金額はありませぬ。
購止されていない限り、すべての年齢にご利用いただけます。