



HERO FACTORY



HeroFactory.LEGO.com

2235

FIRE LORD

2067



2063





1

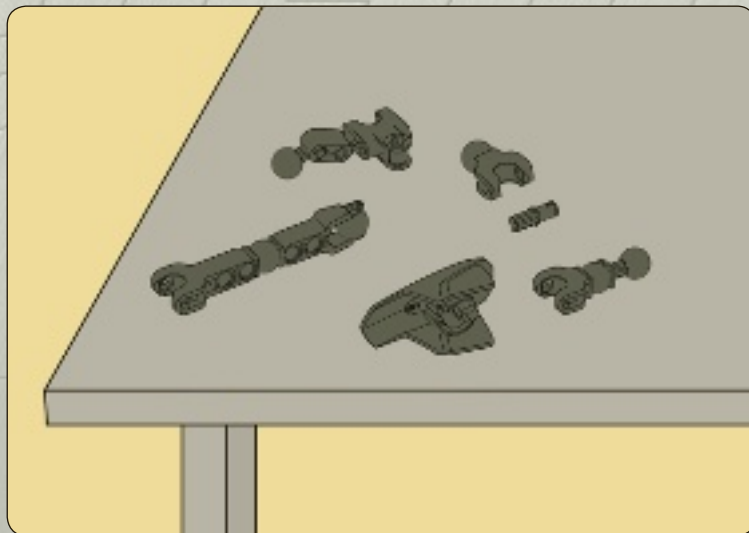
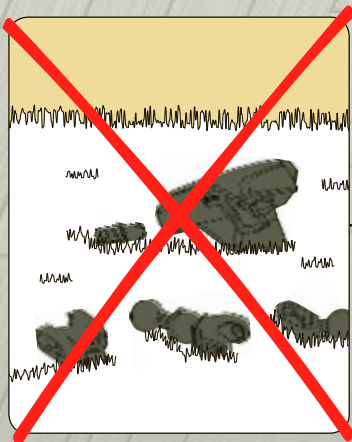

2



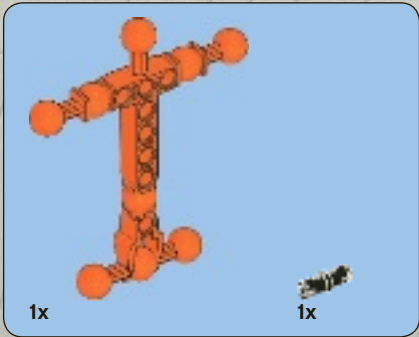
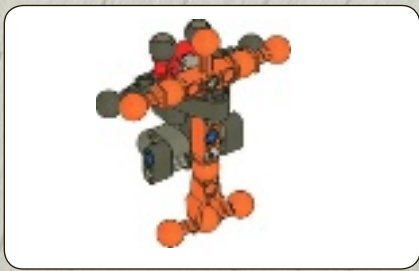

1

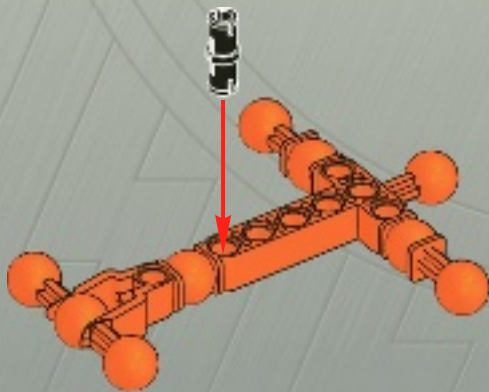

2

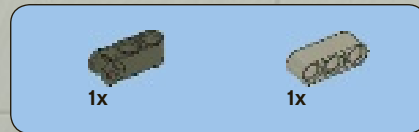
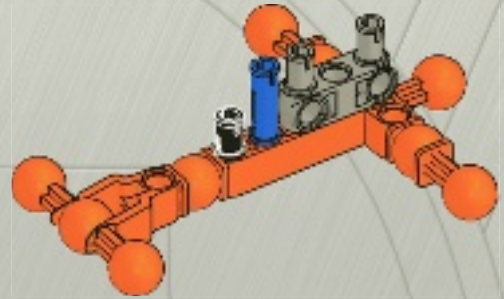

3

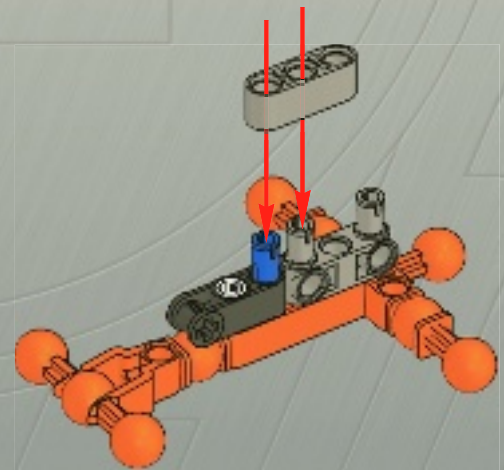

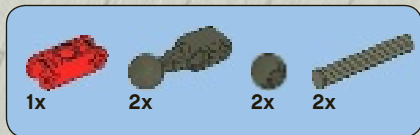

4

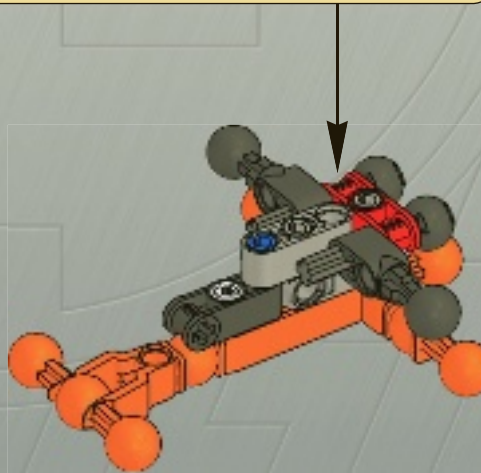
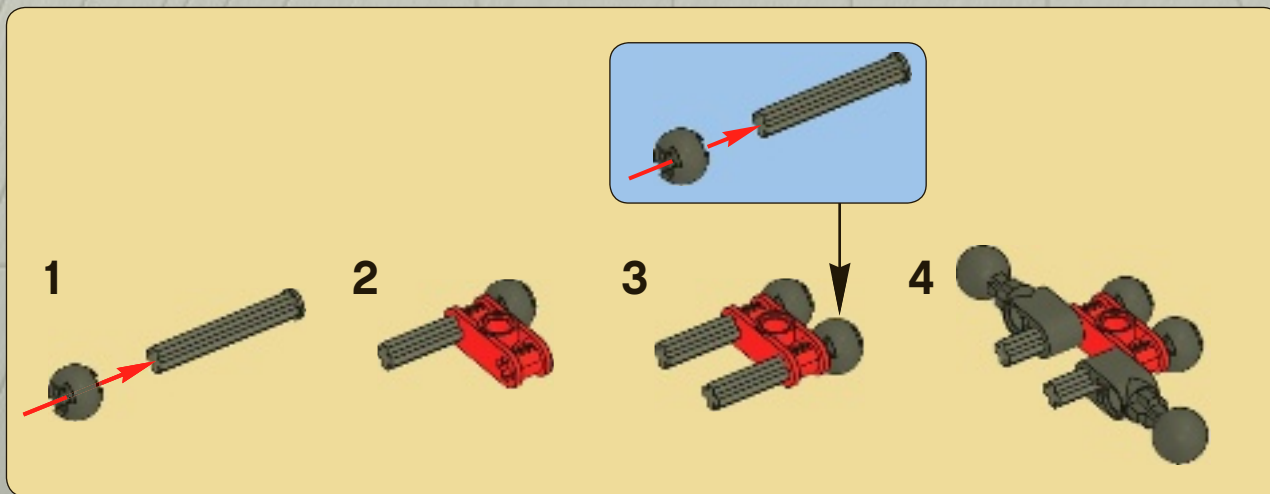



5

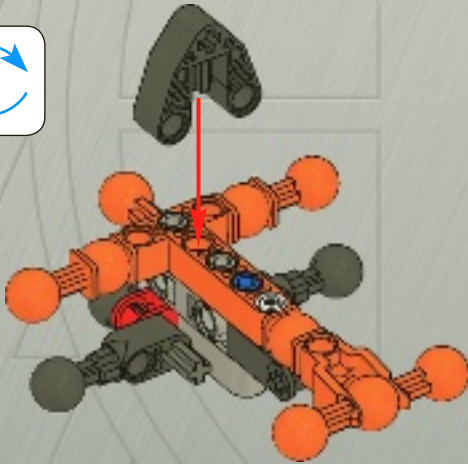

6

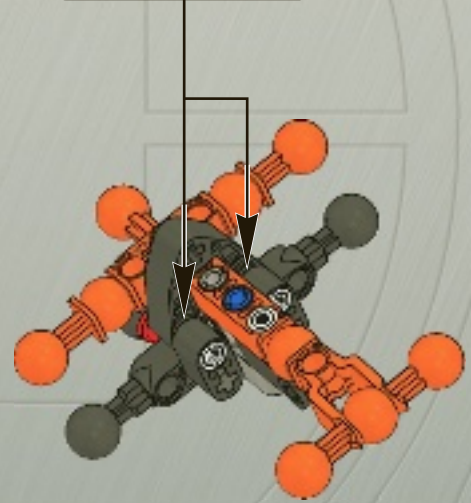
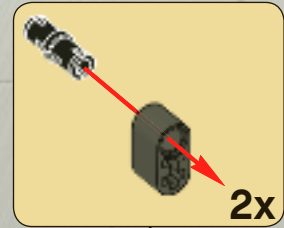

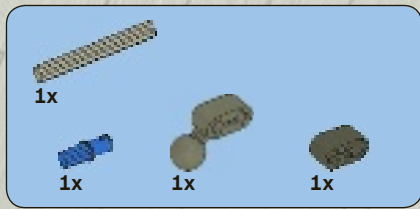

7

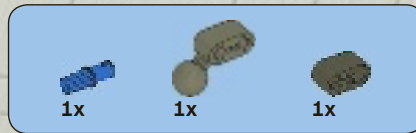
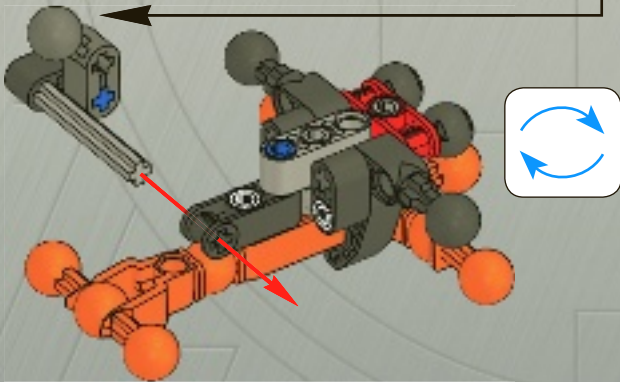
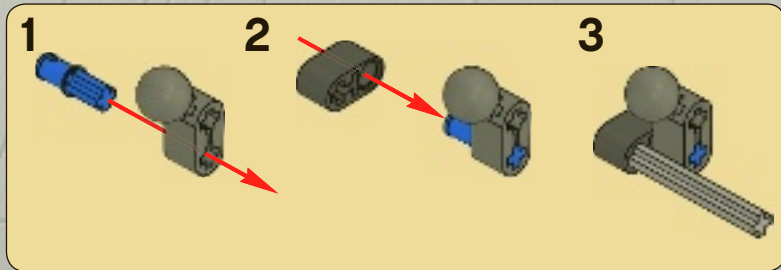

8

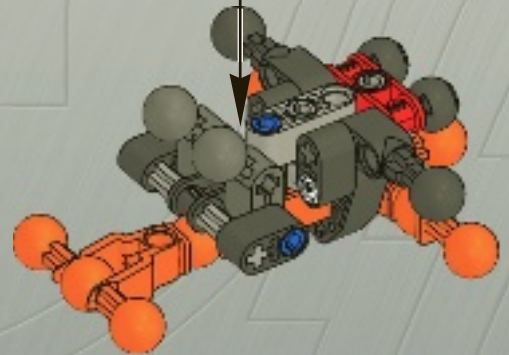

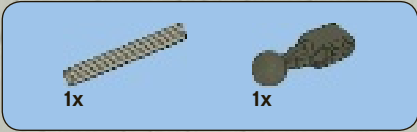

1

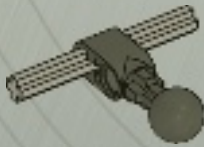

2

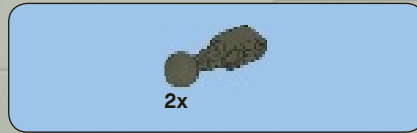
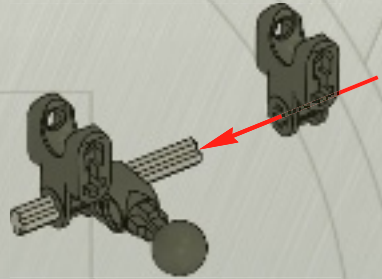

3

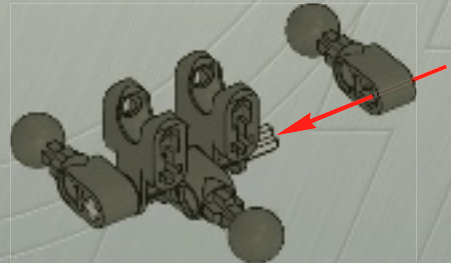



4

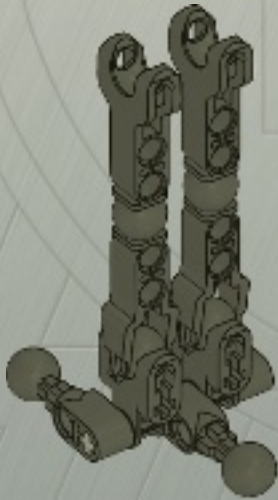

5

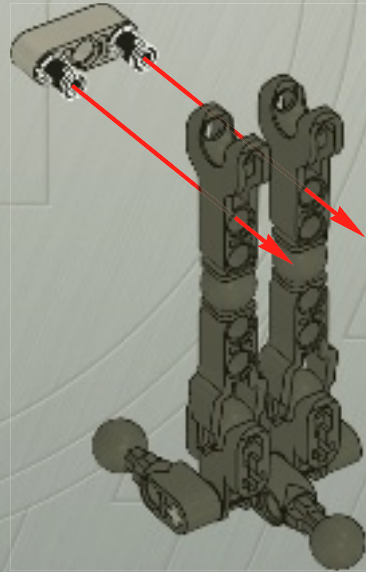
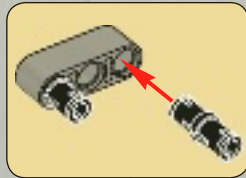

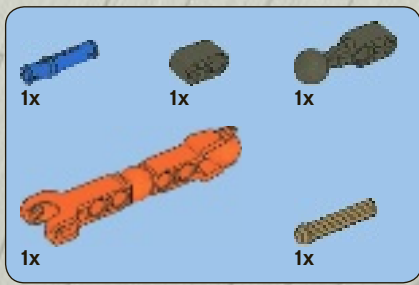

6

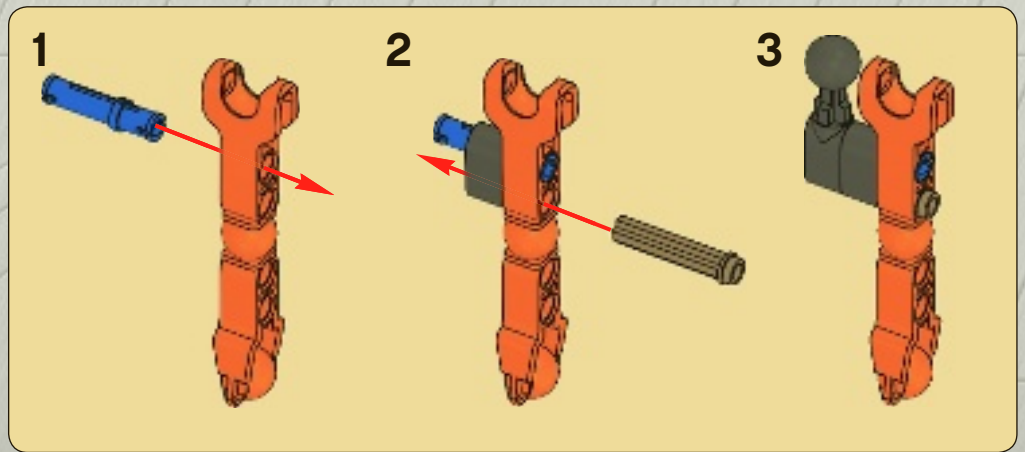



7

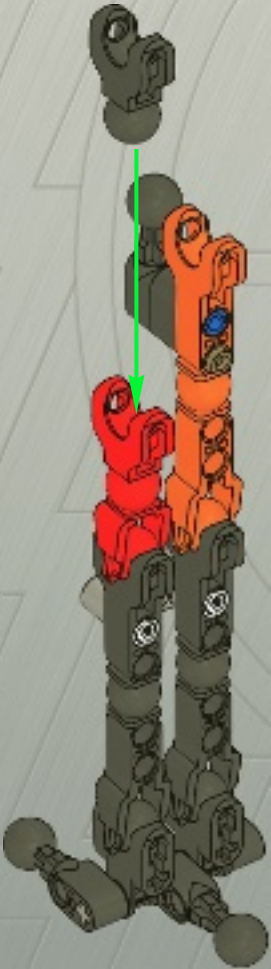

8

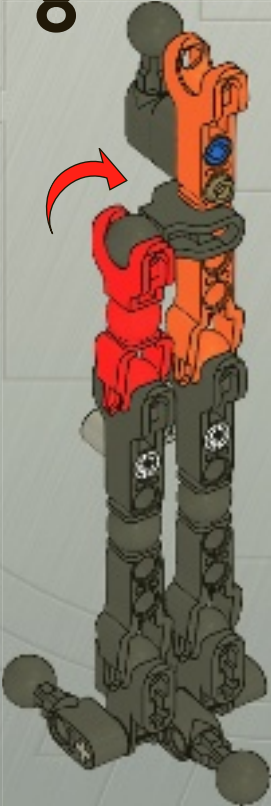

9

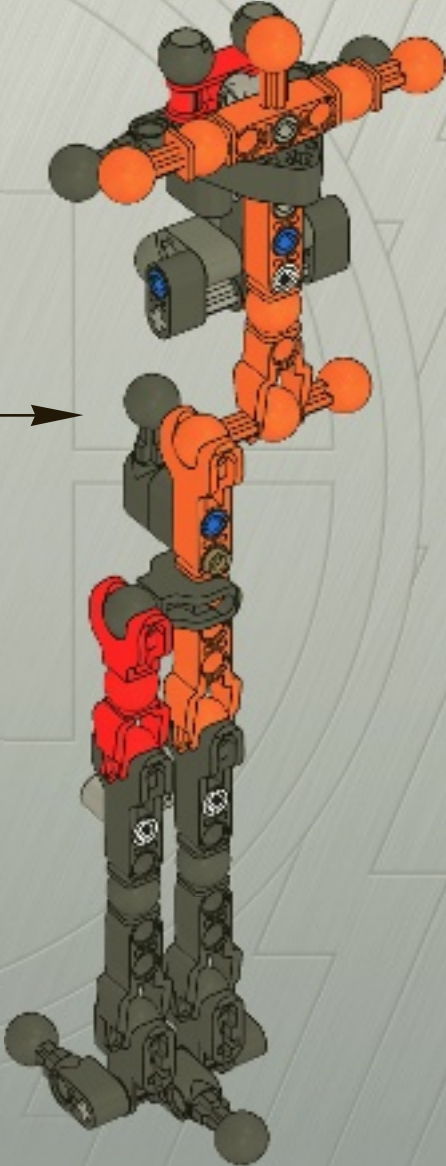

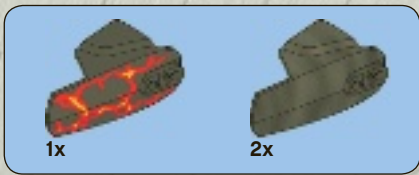

10

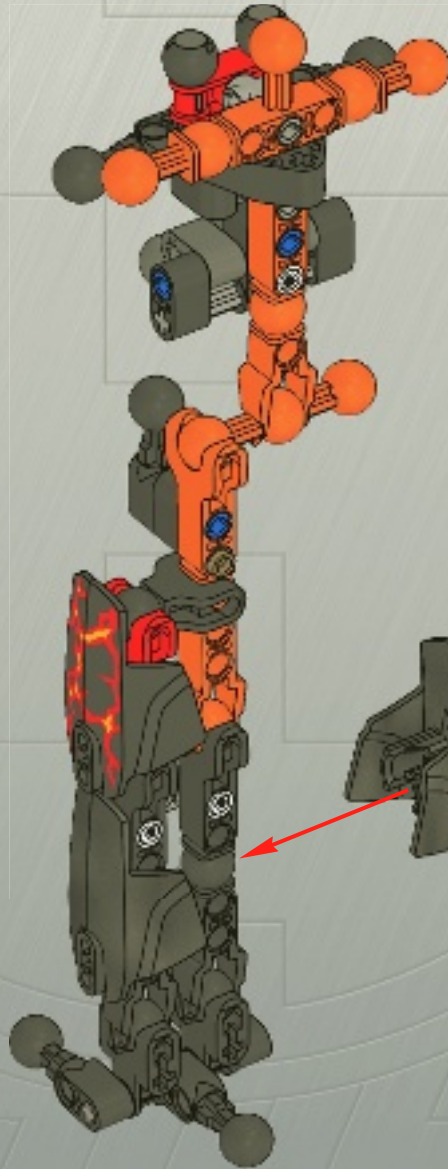

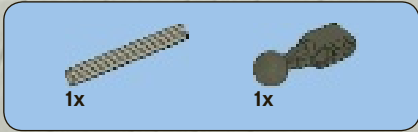

1

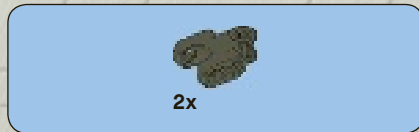
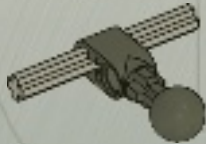

2

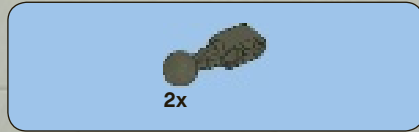
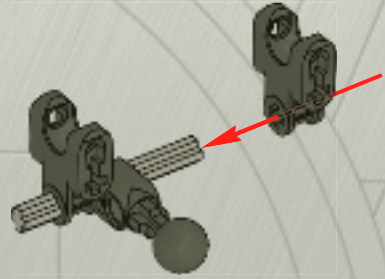

3

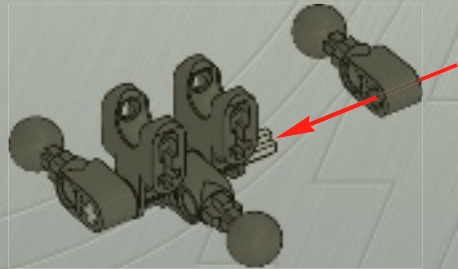

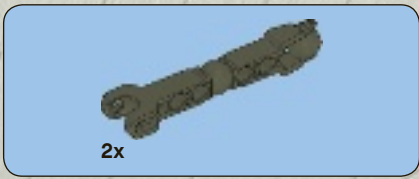

4

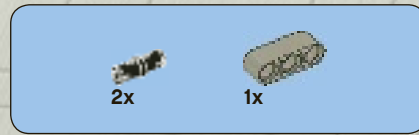
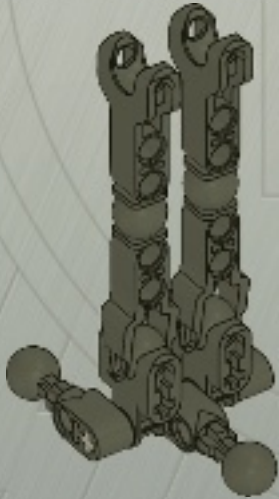

5

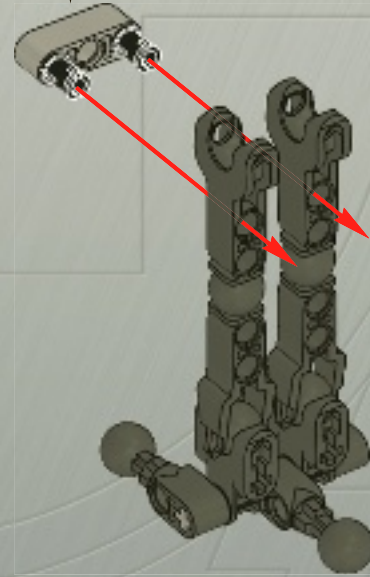
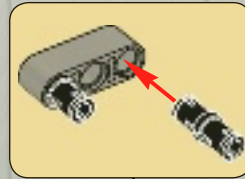



1x



1x

6



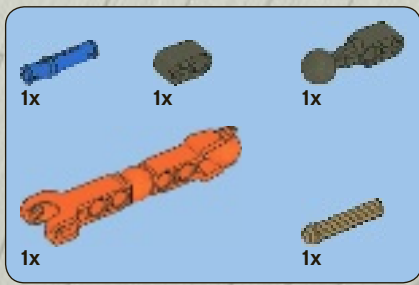

7

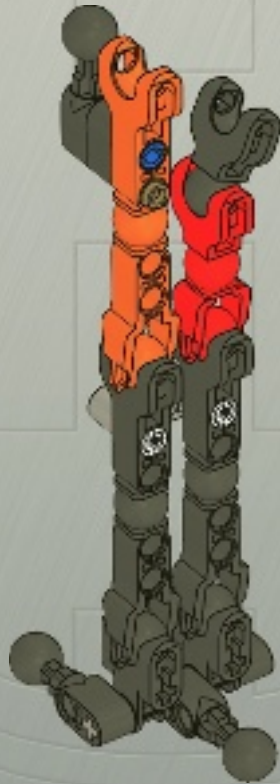
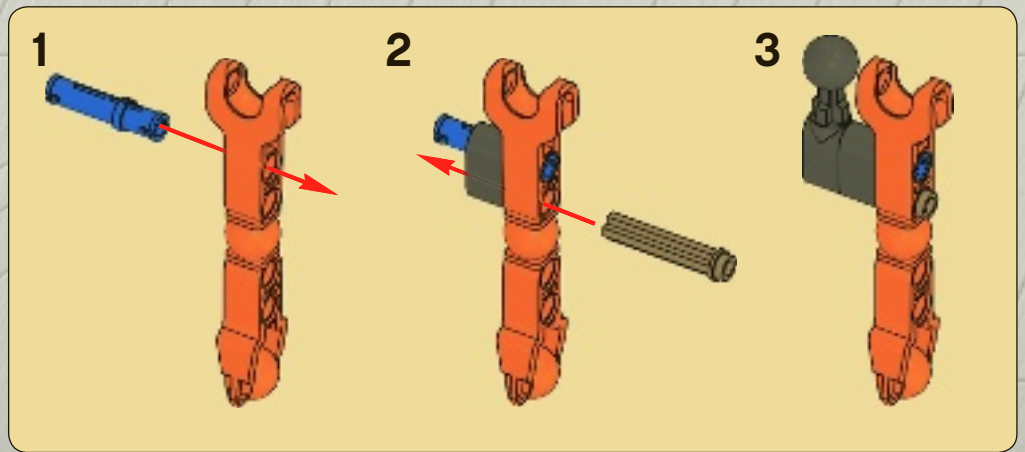



12

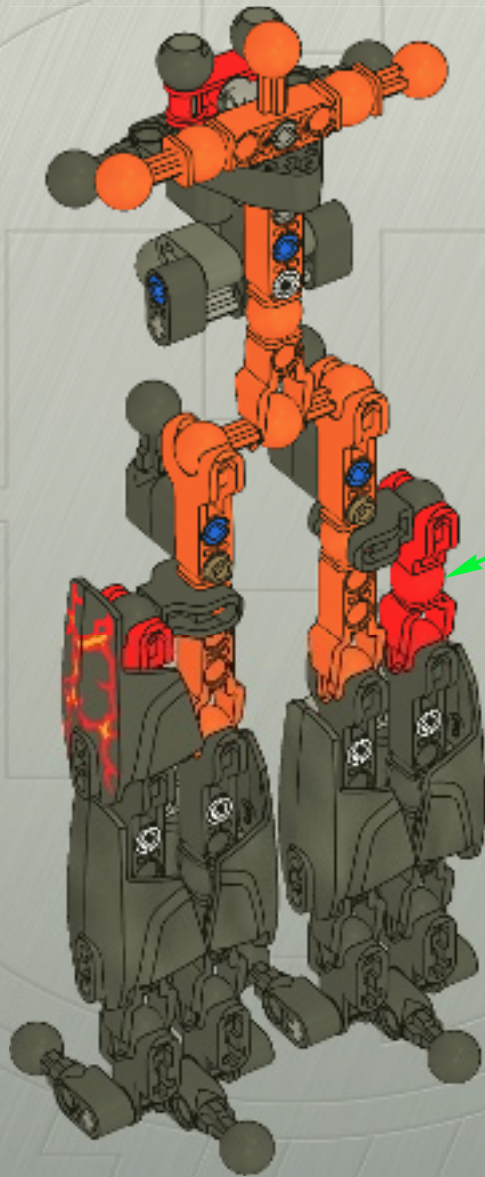

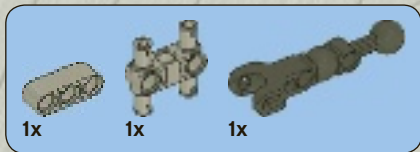

1

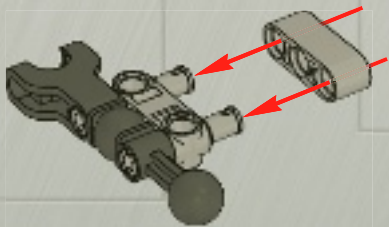

2

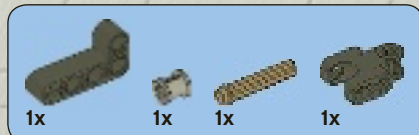
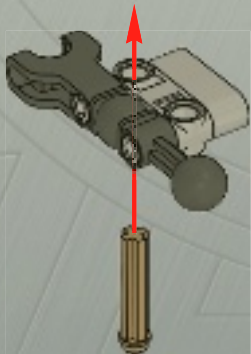

3

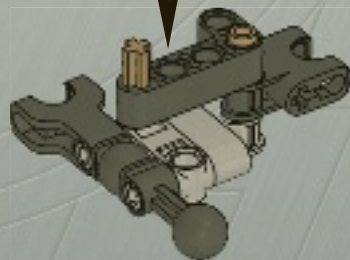
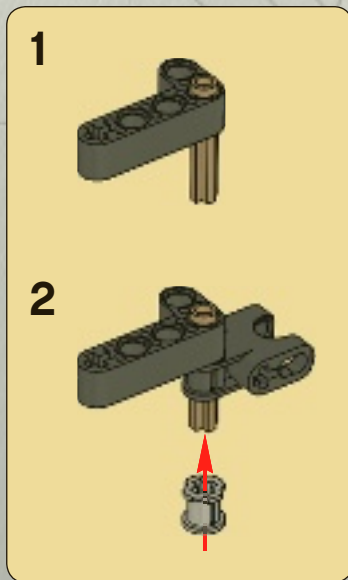



4



13

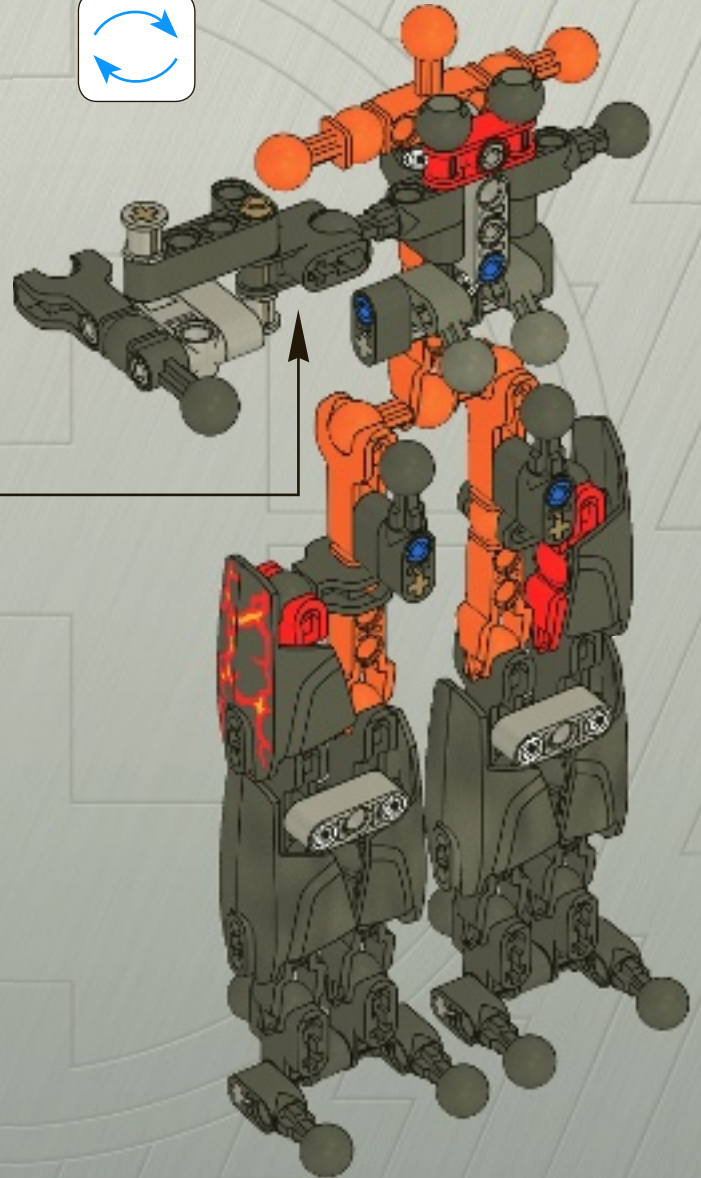

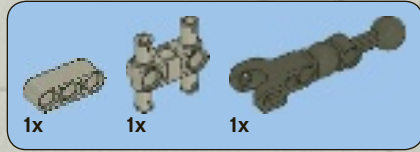
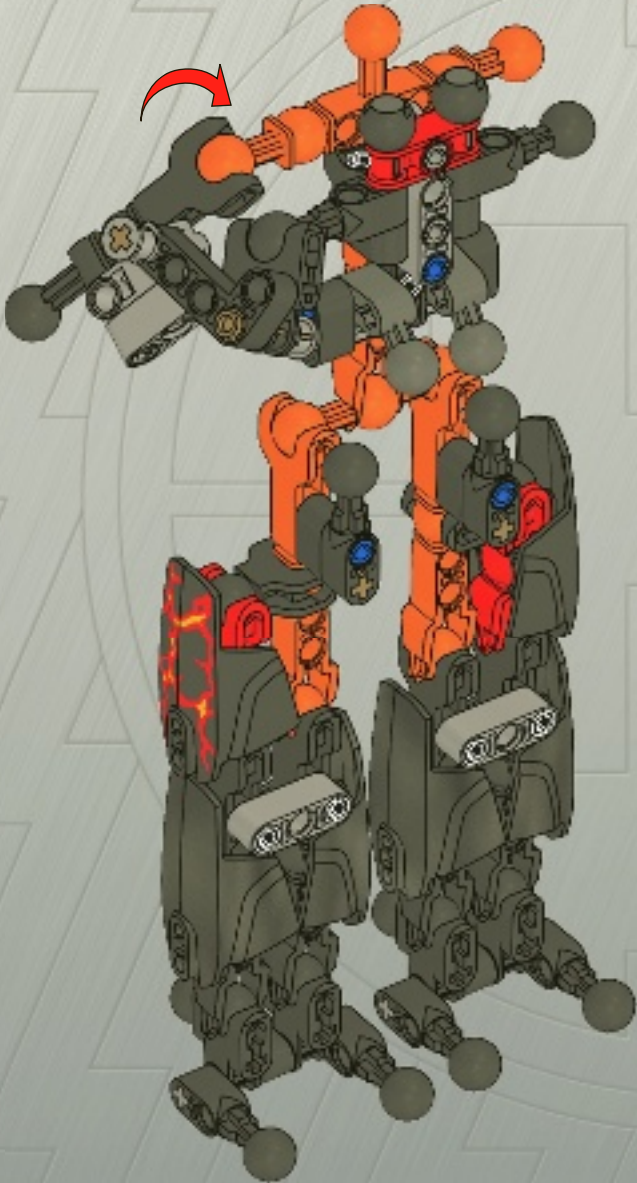

1

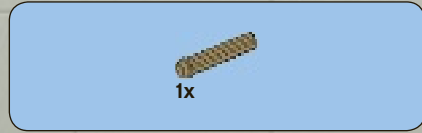
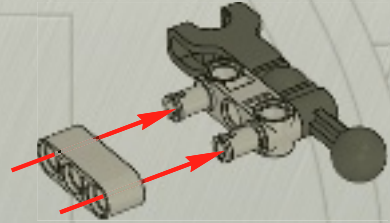

2

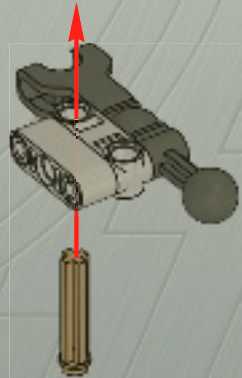

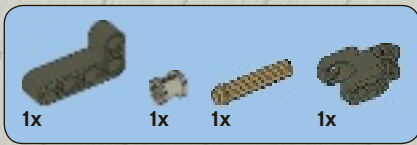

3

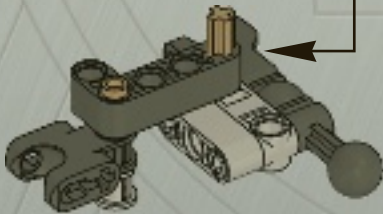
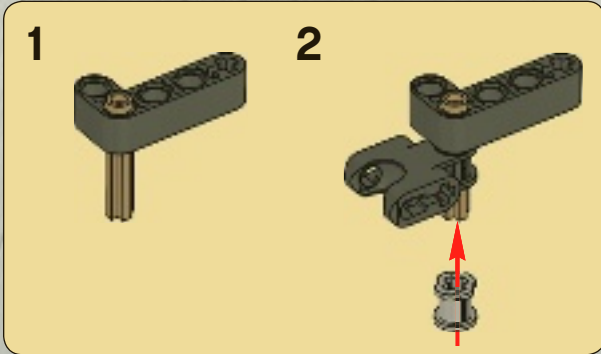

4



15

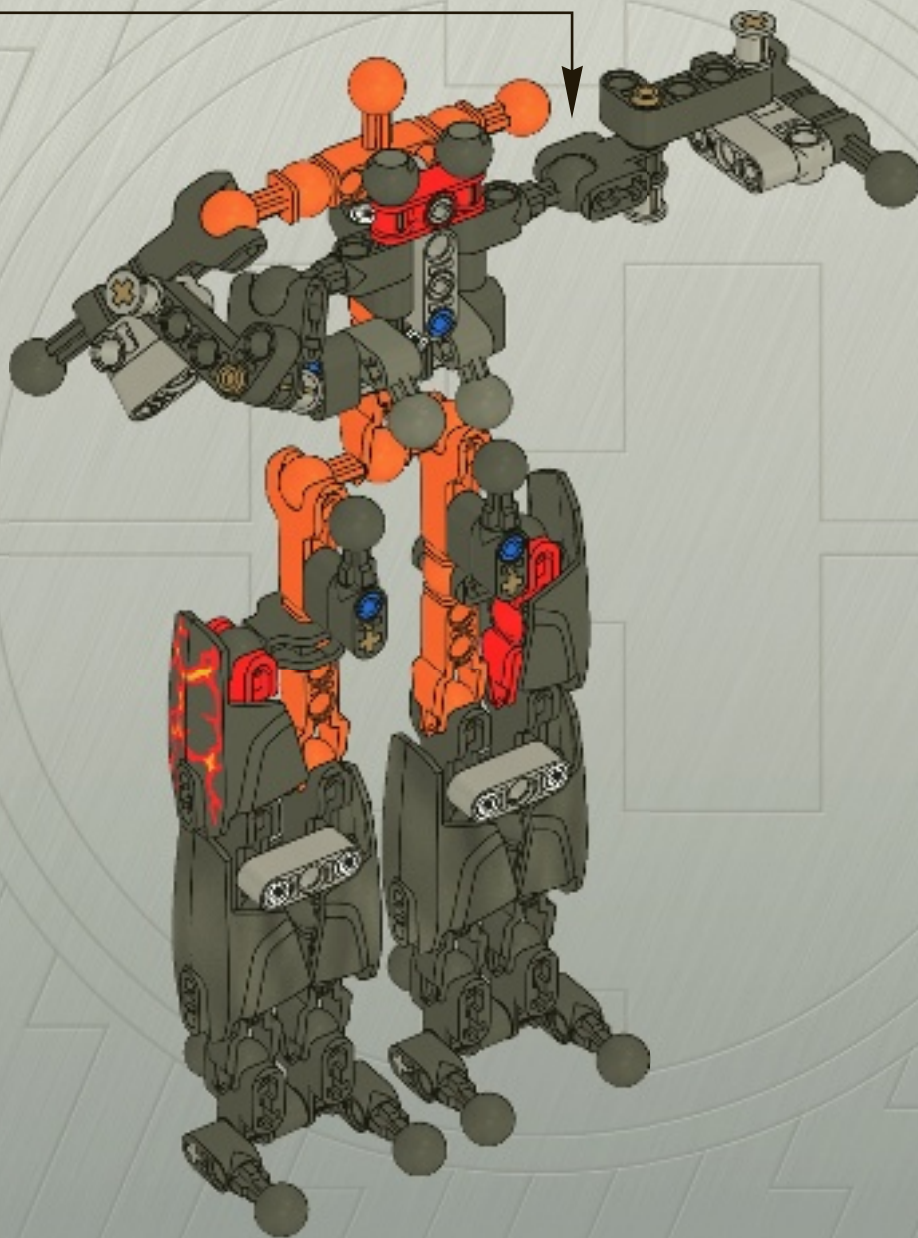

16

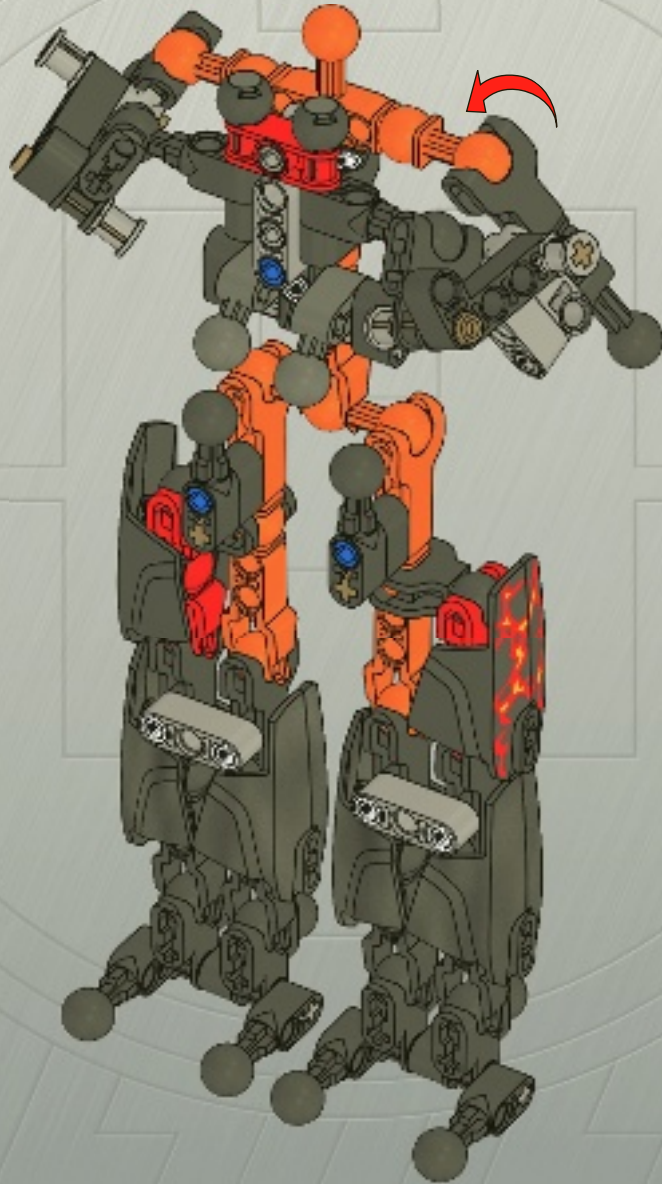



2x

17

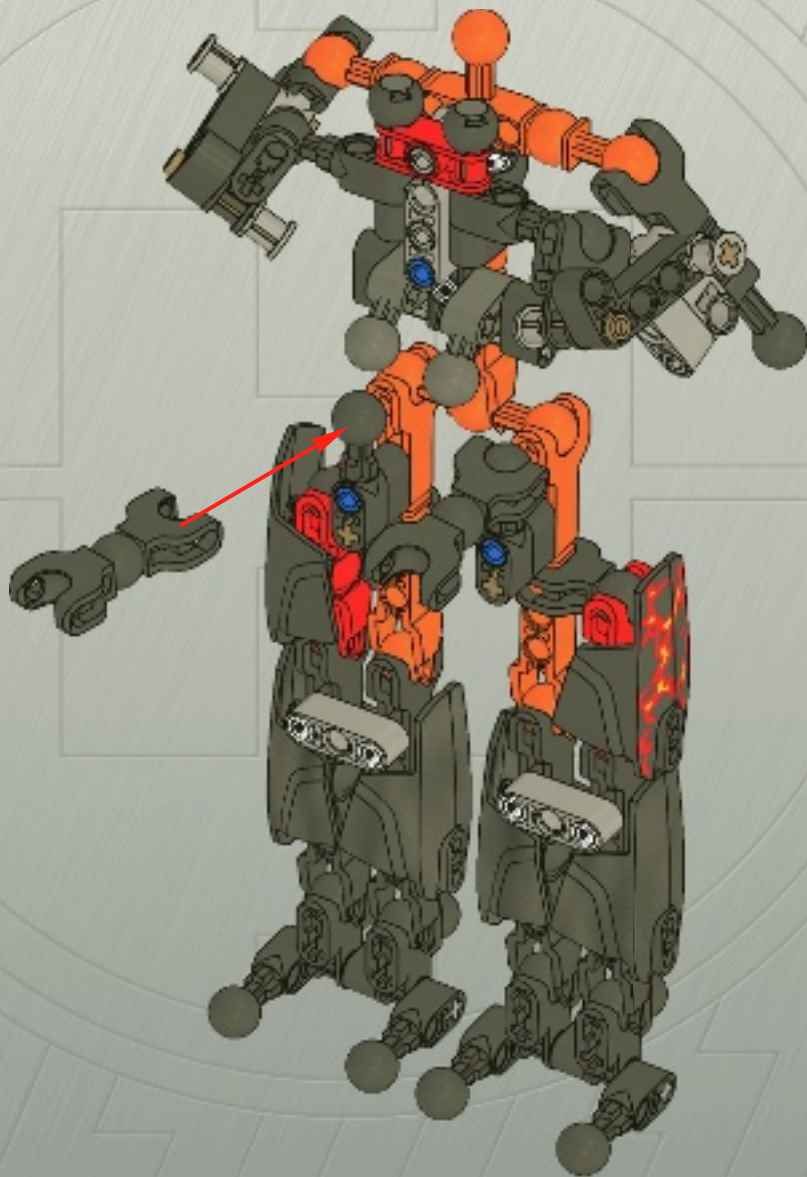

18

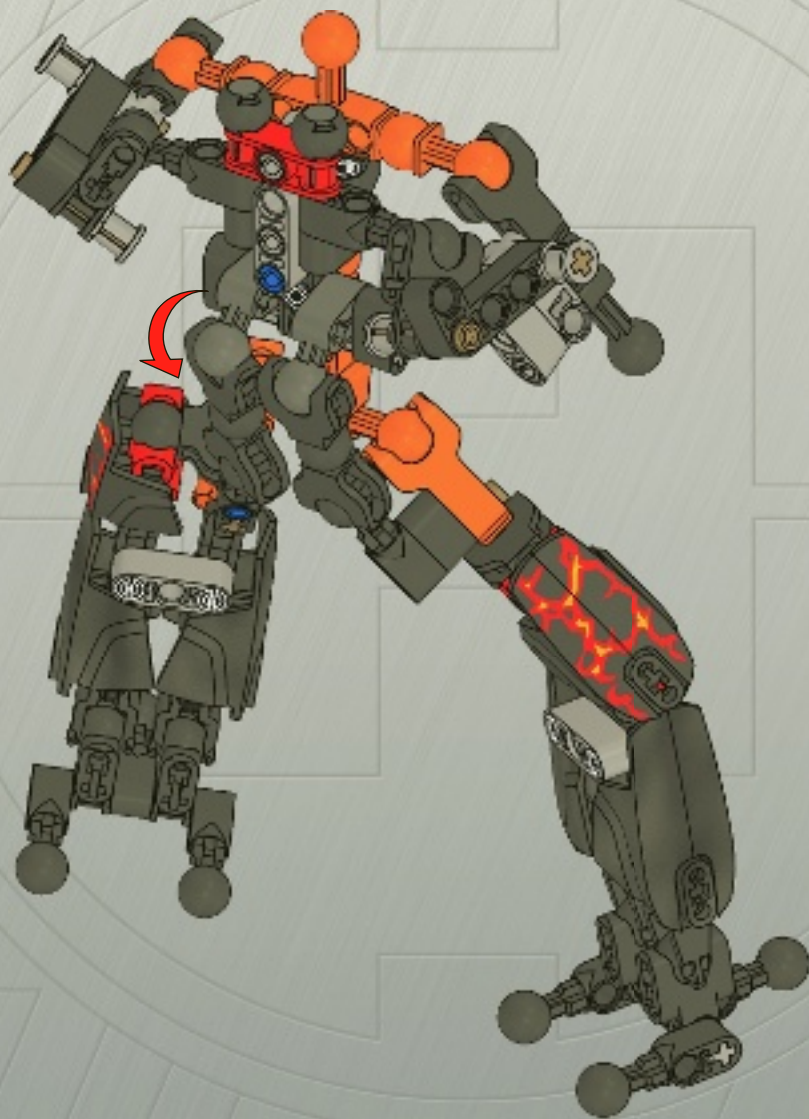



1

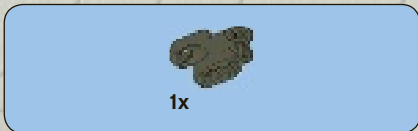
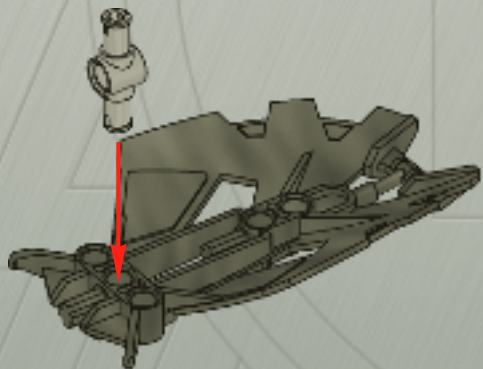

2

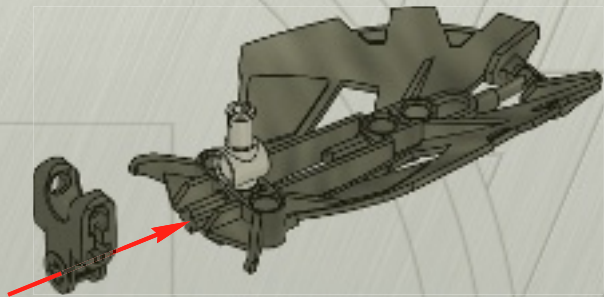

3

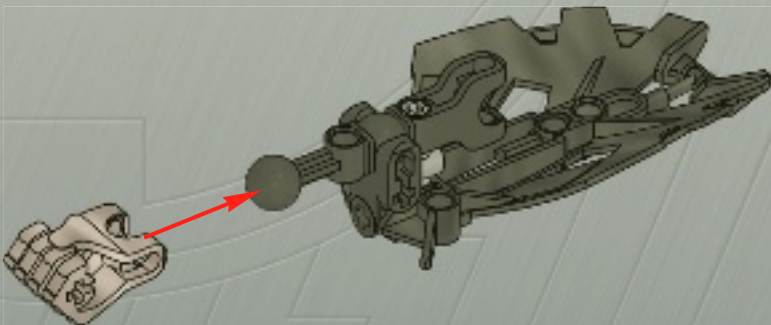

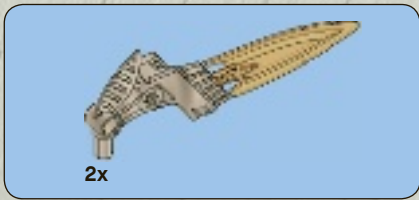

4

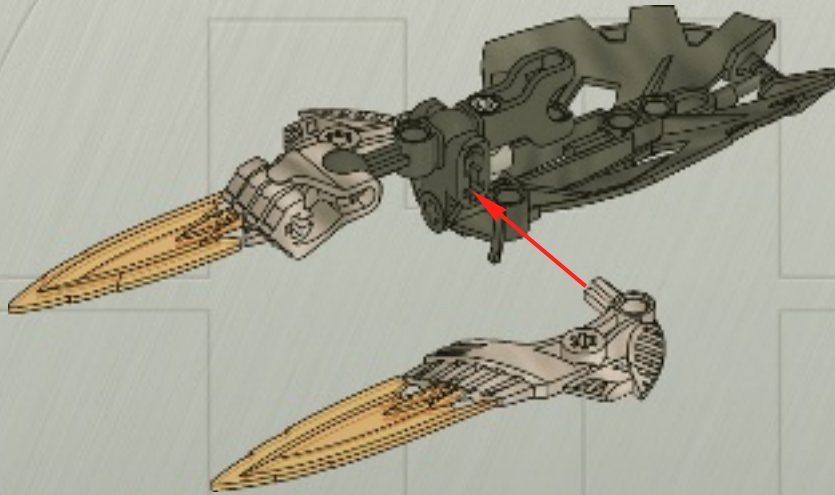

19

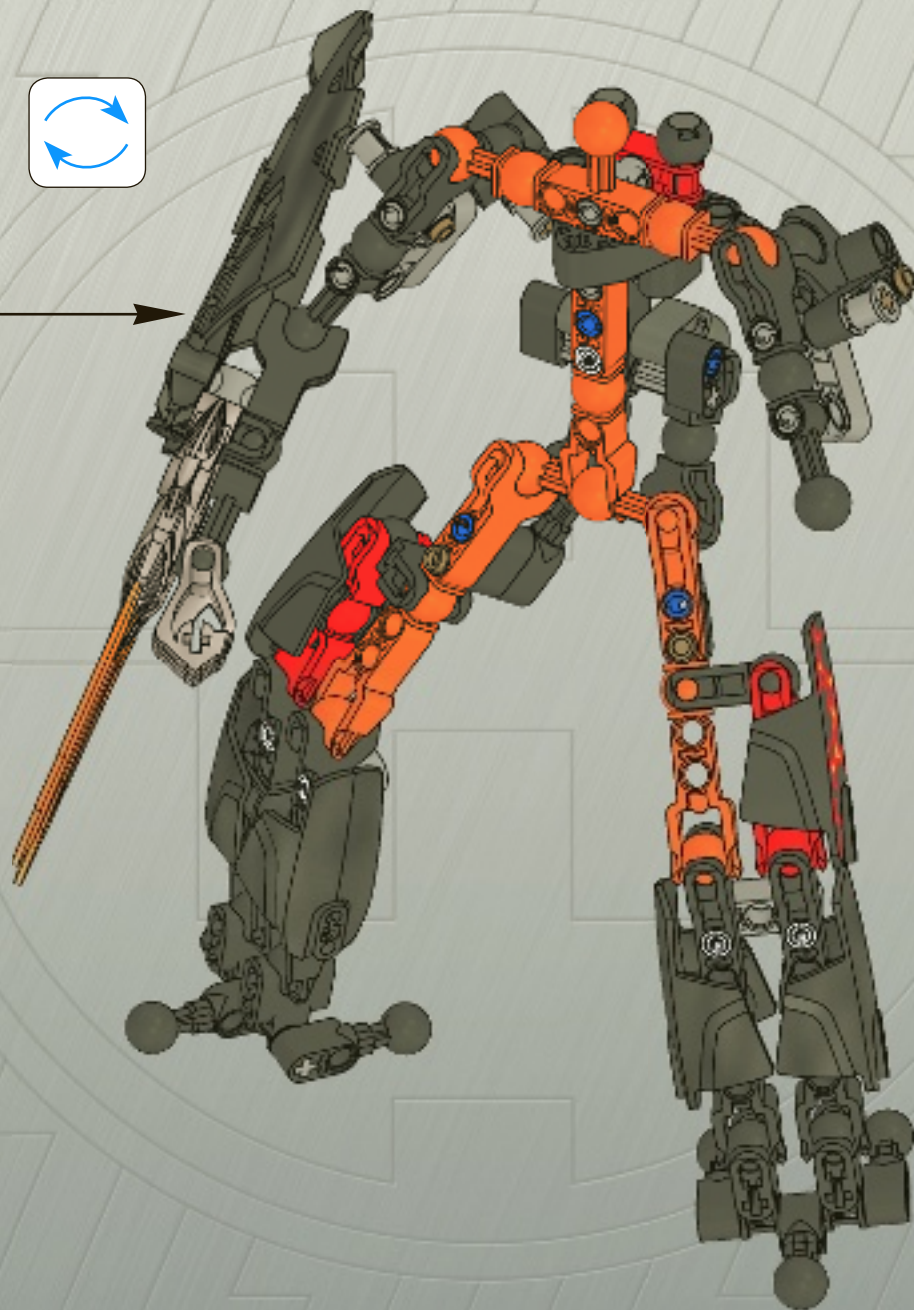



1

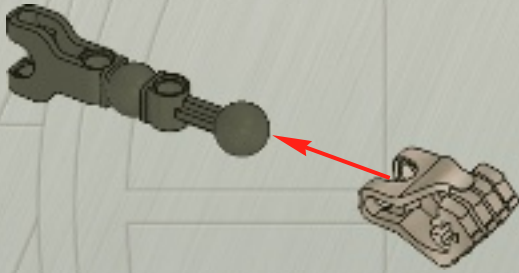

2

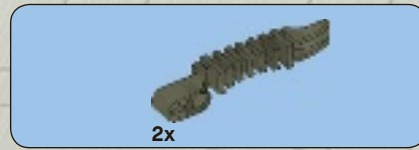

3

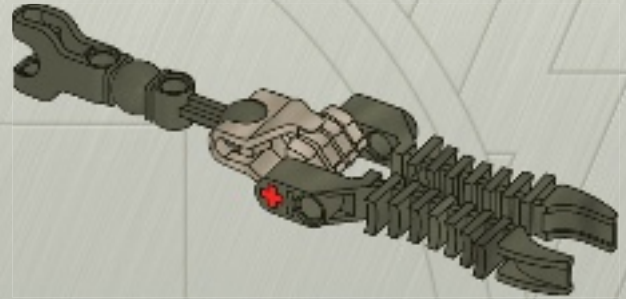

4

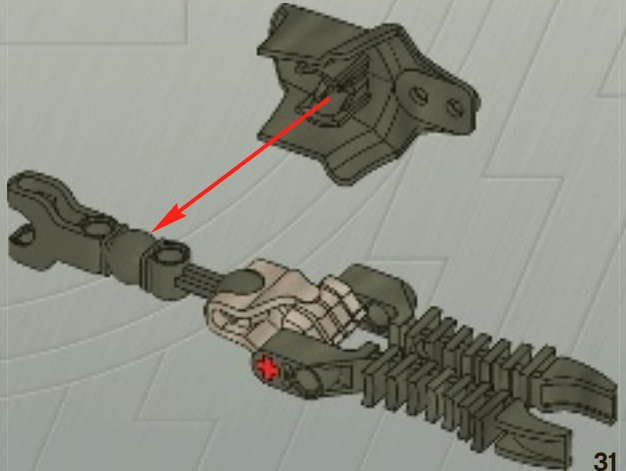

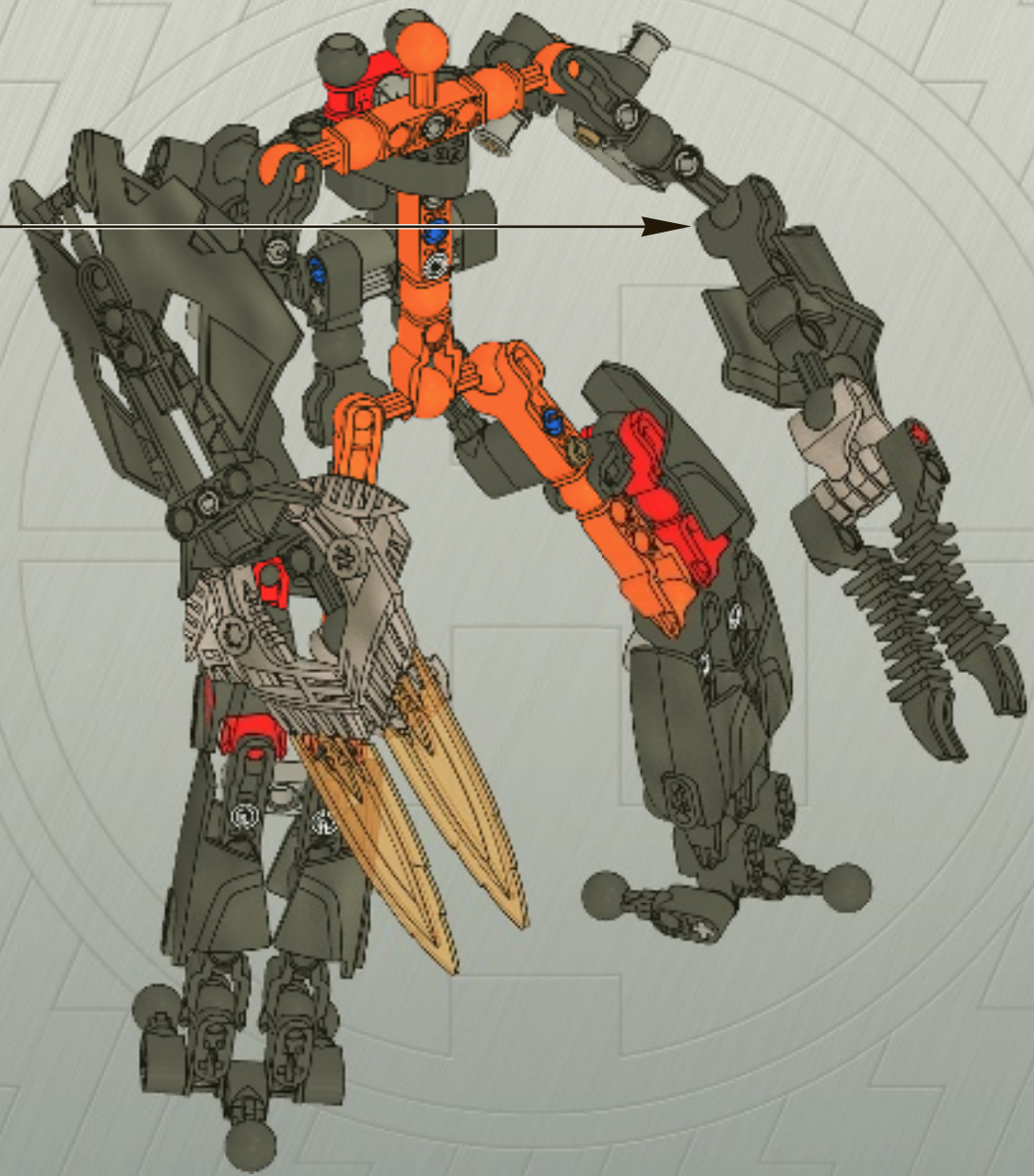

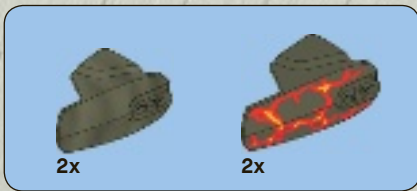

21

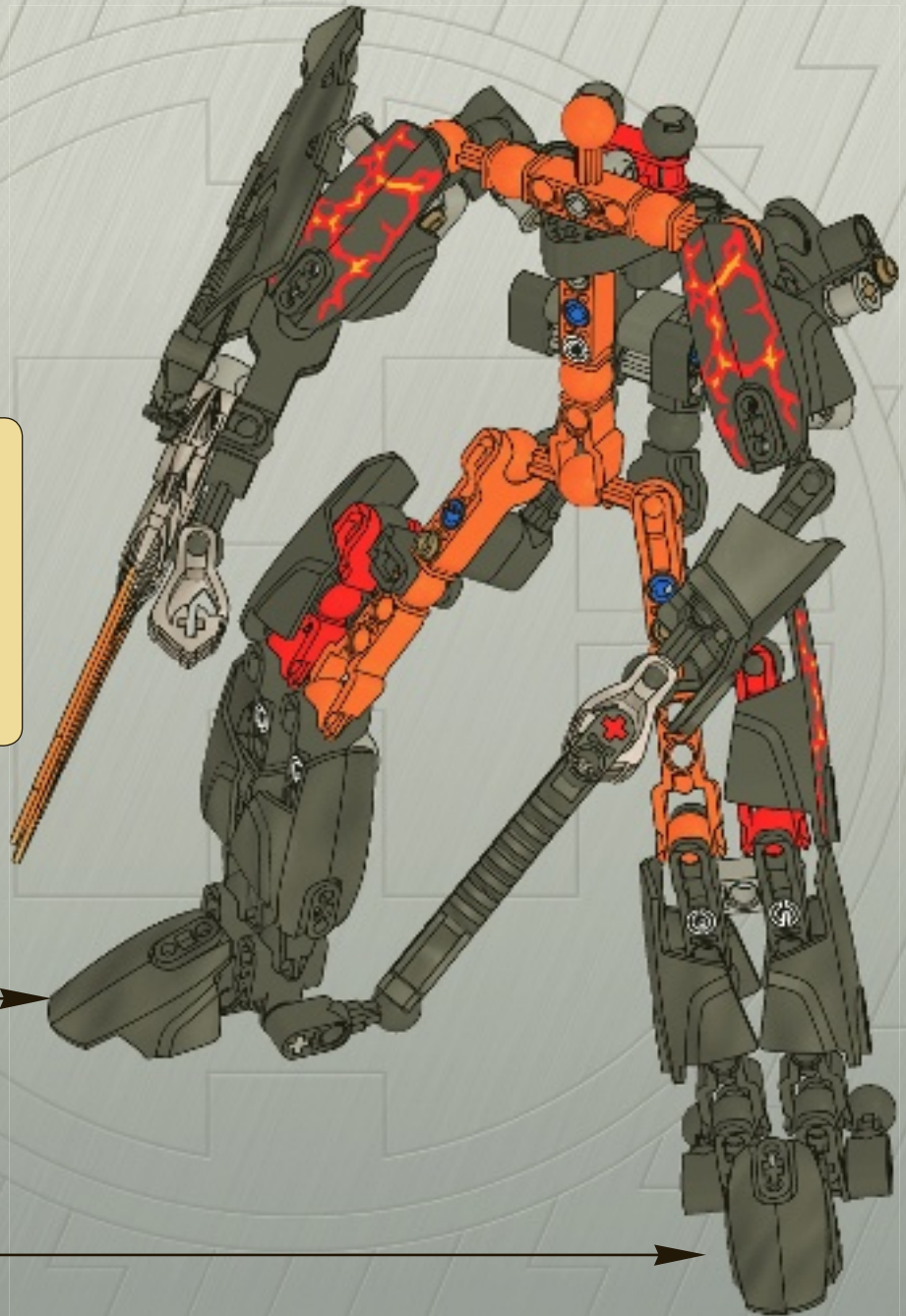



22

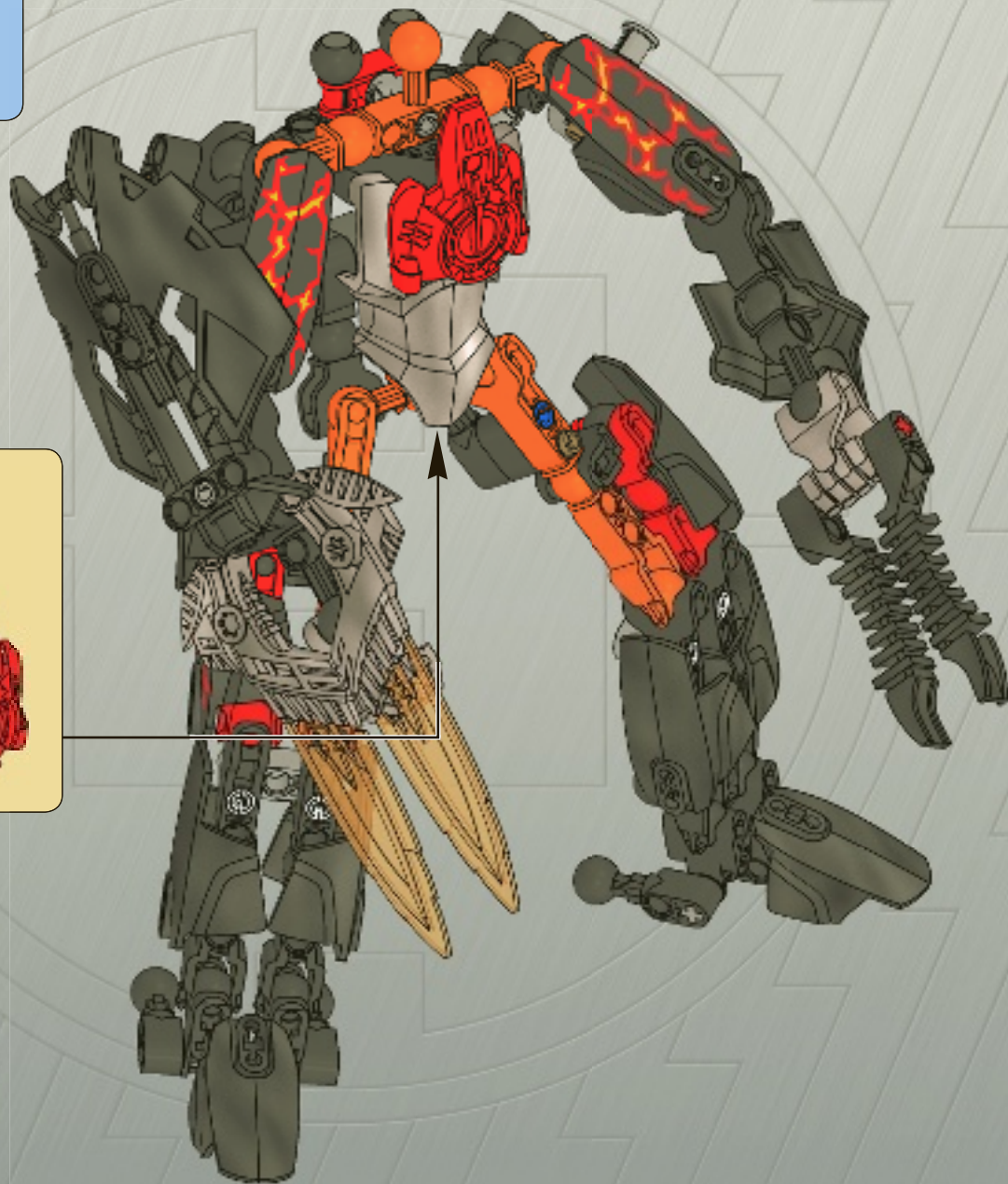
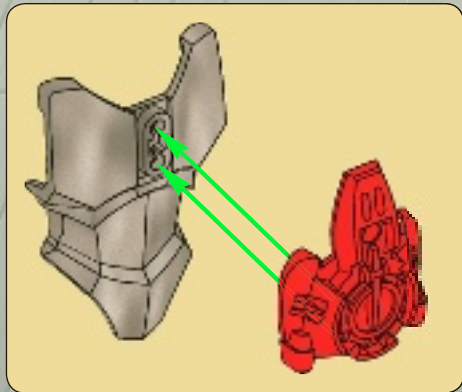



2x

23

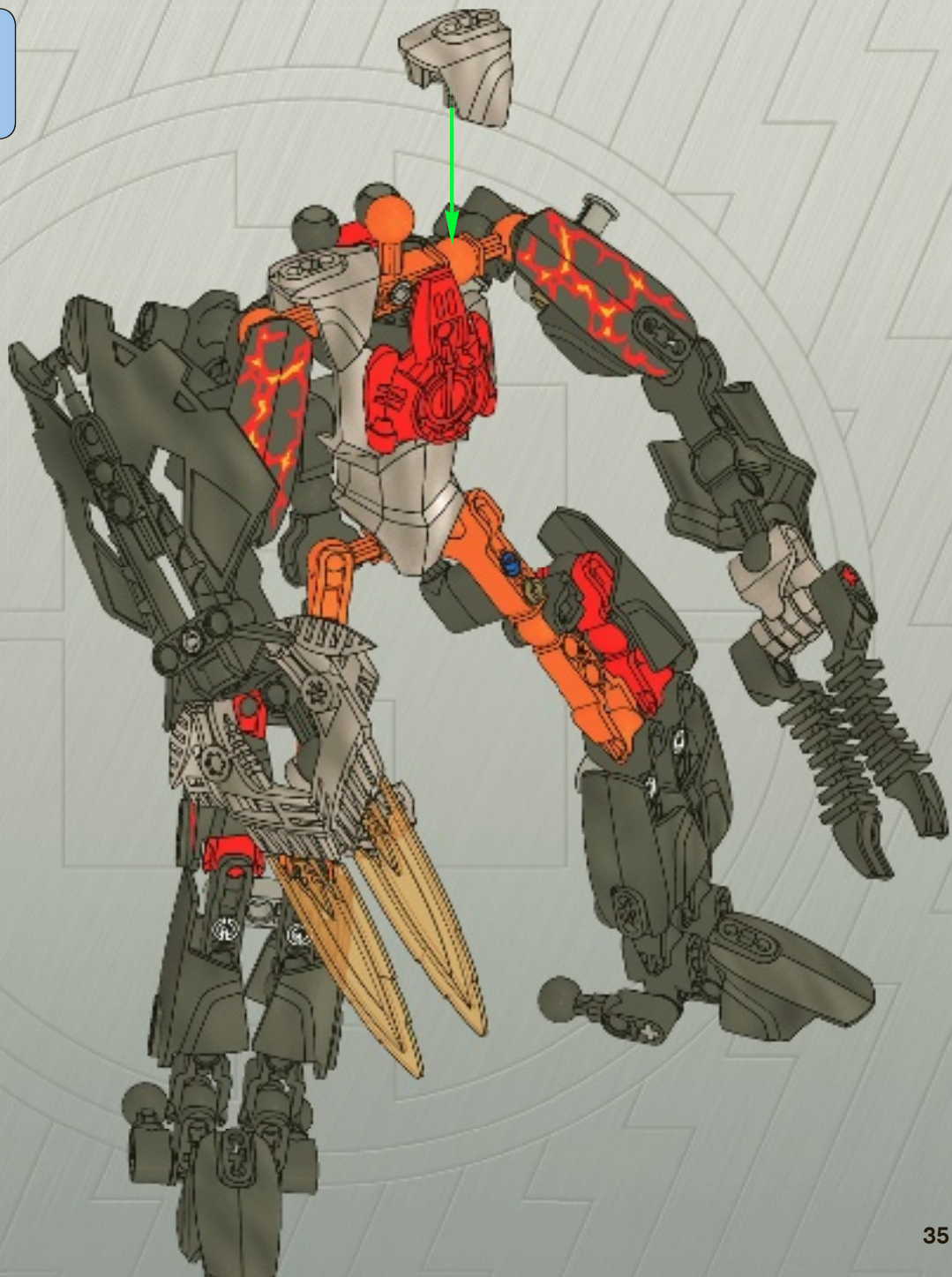

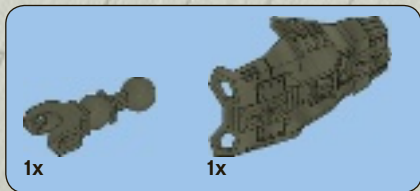

1

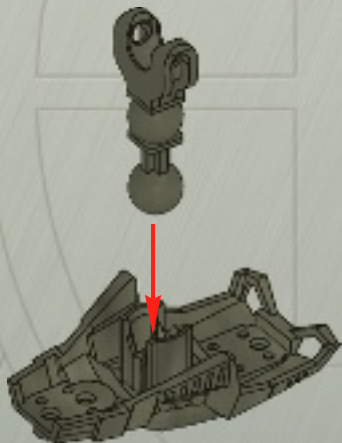

2

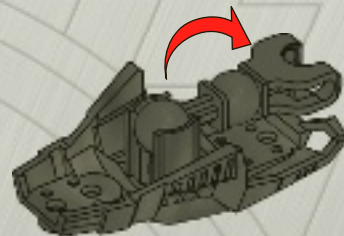

3

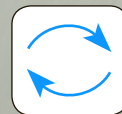

2x

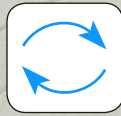

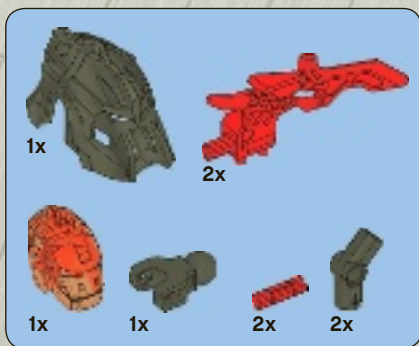

24

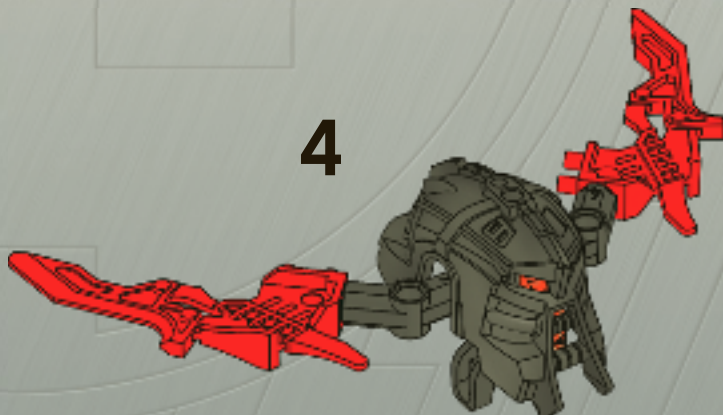

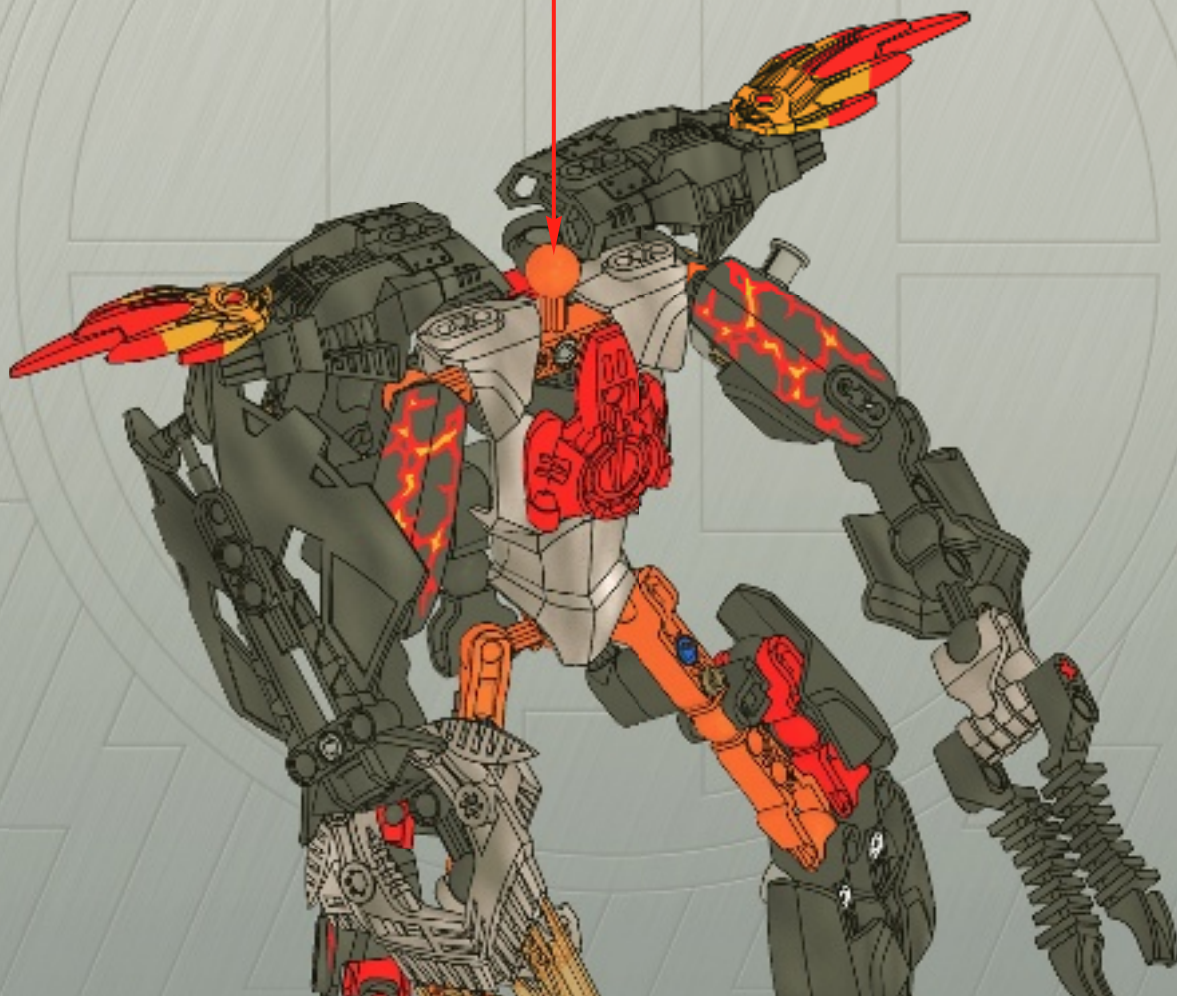
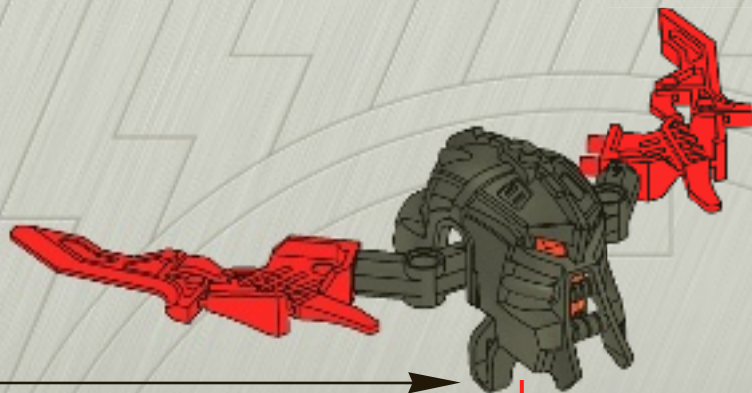

1x



25

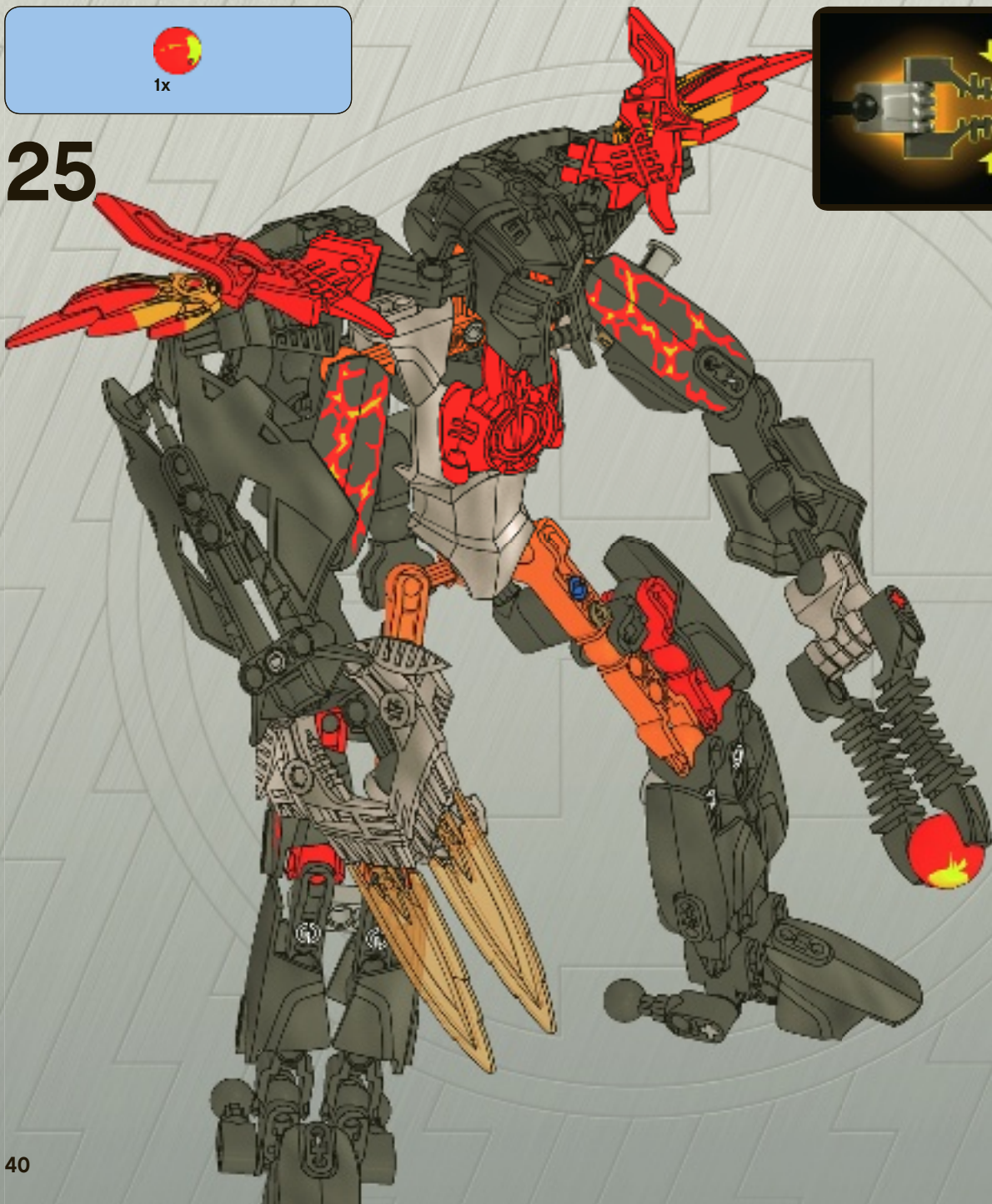

1x
4128598

2x
4603782

2x
4611806

1x
4622390

2x
4591604

1x
4591614

4x
4142865

2x
4206482

3x
4514553

6x
4515185

2x
4120017

1x
4173970

1x
4497946

2x
4286267

7x
4610948

10x
4560108

3x
4593557

2x
4593555

2x
4593567

4x
4593553

4x
4593558

4x
4632631

2x
4121610

7x
4121715

1x
4540702

1x
4609809

2x
4609819
6x
4566927

5x
4211655

1x
4560175

4x
4211622

3x
4225033

3x
4211639

2x
4289258

2x
4560177

2x
4632610

2x
4619077

2x
4617725

1x
4632589

1x
4611812

1x
4614168

2x
4609686

2x
4609731

1x
4615593

2x
4632641

4x
4632628

Customer Service
Kundenservice
Service Consommateurs
Servicio Al Consumidor

www.lego.com/service or dial

 : 00800 5346 5555
: 1-800-422-5346



LEGO HERO FACTORY

HOME PRODUCTS DOWNLOADS FUN ZONE STORY GALLERY

CALL CENTER

HERO FACTORY CALL CENTER

SUBMIT YOUR OWN MISSION

MEDIA CENTER

ABOUT HERO FACTORY

PRODUCTS

NEW AVAILABLE SOON!

LATEST NEWS

- Hero Factory is pulling the finishing touches on a new feature - creating your own...
- The current galactic threat level is PCARL. There is life or so villain and great...

REAL-TIME STATISTICS

Teams Currently On Mission	365
Villains & Minions Captured or Defeated This Week	2,543
Total Missions Completed	11,234,742
Mission Success Ratio	88%
New Heros Commissioned Today	3
Today's Weather in Makurovo City	Windy day

From the Call Center: "Help! The Robotic Kibax Army is attacking a cake shop! If no help comes, the cake..."

CREATE YOUR OWN VILLAIN GAME

HERO FACTORY FM RADIO

PROMOTIONAL VIDEO

Customer Service About Us Educators Parents LEGOLAND Site Index Legal Notice

LEGO, the LEGO logo, DUPLO, BIONICLE, MINDSTORMS, the BELVILLE, KNIGHTS' KINGDOM and EXO-FORCE logos, the Brick and Knob configurations and the Minifigure are trademarks of the LEGO Group.
© 2010 The LEGO Group. All rights reserved. Use of this site signifies your agreement to the terms of use.





LEGO

HERO FACTORY



HERO RECON TEAM



HeroFactory.LEGO.com

Coming spring 2011

DE: Ab Frühling 2011, FR/FRCA: Sortie au printemps 2011, ES/ESSA: Disponible en primavera de 2011, PT: Próxima primavera 2011, HU: 2011 tavaszán érkezik.



www.LEGOclub.com



LEGO® Club Email

LEGO club™

FREE! GRATIS! GRATUIT!



LEGO® Club Magazine

SIGN UP ONLINE!

www.LEGOclub.com



00800 5346 5555*



1-866-534-6258 • 1-877-518-5346

US & Canada only

Canada seulement

* Freephone. Mobile charges may apply.
* Numéro sans frais. Des frais peuvent s'appliquer avec les téléphones cellulaires.
* Gebührenfrei, Kosten für Anrufe aus Mobilfunknetzen können abweichen.
* Gratis telefonnummer vanaf vaste lijn.
* Det er et gratis nummer, når du ringer fra fasttelefon.
* Det är gratis, när du ringer från en fast telefon.
* Numéro sans frais. Des frais peuvent s'appliquer avec les téléphones portables.



WIN!

Go to www.LEGOsurvey.com/product
to fill out a survey for a chance
to win a cool LEGO® Product.
No purchase necessary.
Open to all residents where not prohibited.

 www.LEGO.com



www.LEGOsurvey.com/product

GEWINNE! WIN!

Nimm an der Umfrage auf
www.LEGOsurvey.com/product
teil und hab die Chance ein cooles
LEGO® Produkt zu gewinnen!

Die Teilnahme am Gewinnspiel führt zu keinerlei
Kaufverpflichtungen. Teilnahme in allen nicht
ausgeschlossenen Ländern möglich.

Ga naar www.LEGOsurvey.com/product,
vul een enquêteformulier
in en maak kans op een
cool LEGO® product.

Geen aankoopverplichting.
Iedereen mag deelnemen, uitgezonderd
ingezetenden van landen waar een
enquêteverbod geldt.

GAGNE! 当てよう!

Visite www.LEGOsurvey.com/product
pour répondre à un
questionnaire et avoir une chance de
gagner un produit LEGO® très cool!

Aucune obligation d'achat.
Ouvert à tous les résidents des pays
autorisés.

www.LEGOsurvey.com/product にアクセスして、
アンケートにご記入ください。当選者にはレゴ®
製品を差し上げます。

お買い上げの必要はありません。

禁止されていない限り、すべての皆様にご利用いただけます。