



THE HOBBIT™

AN UNEXPECTED JOURNEY

79003





LEGO.com/brickseparator

LEGO THE HOBBIT™
AN UNEXPECTED JOURNEY

LEGO LE HOBBIT™
UN VOYAGE INATTENDU

LEGO EL HOBBIT™
UN VIAJE INESPERADO



1

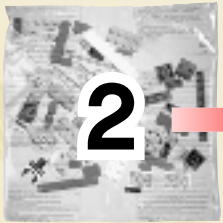
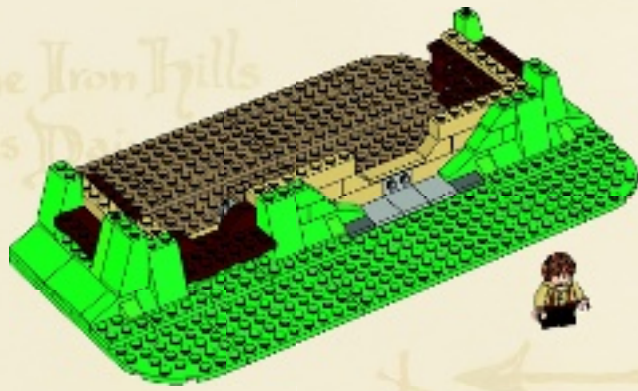

2

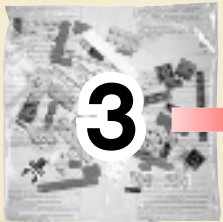
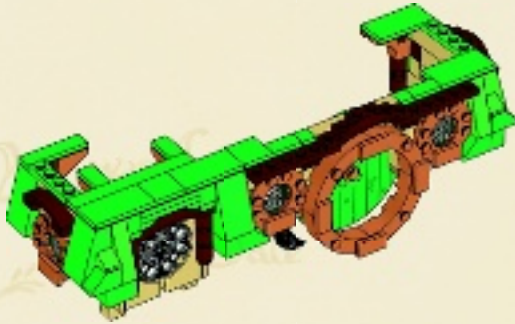

3

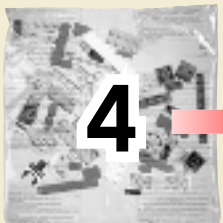

4



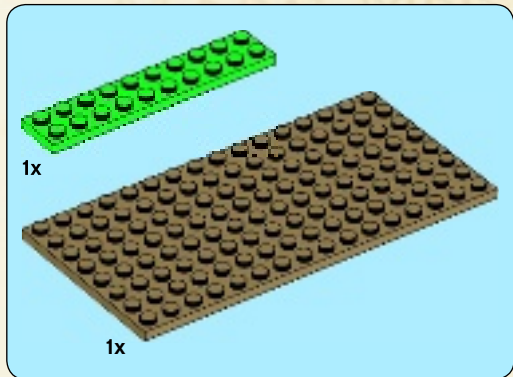
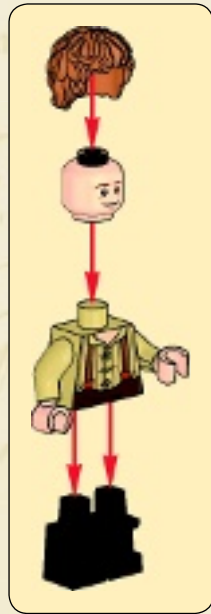
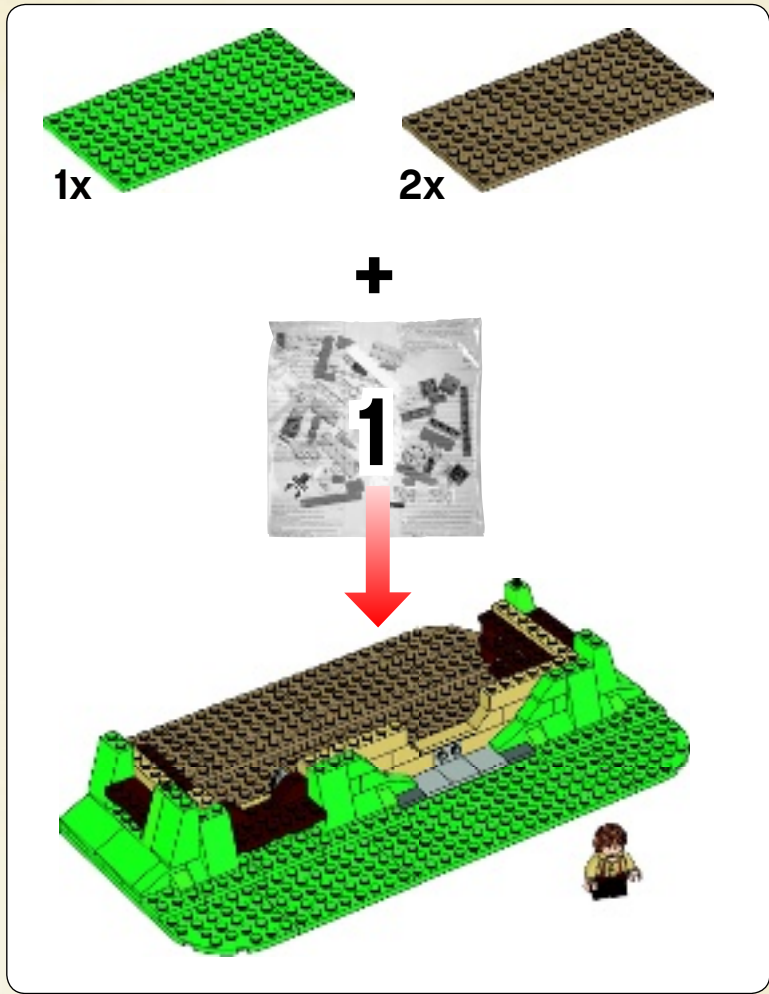

1

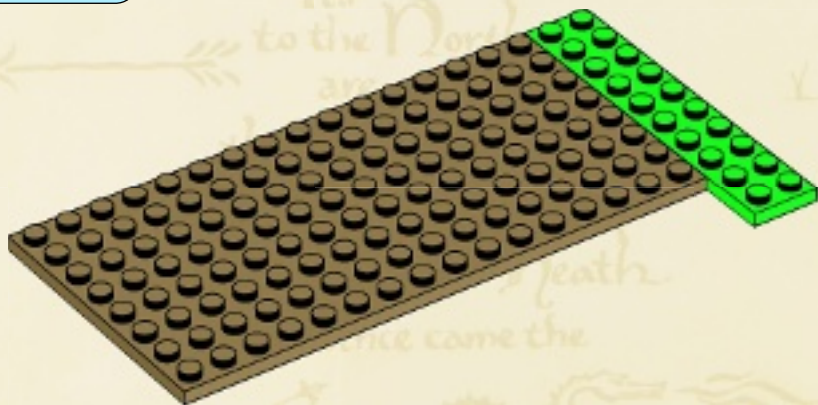

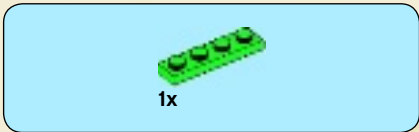

2

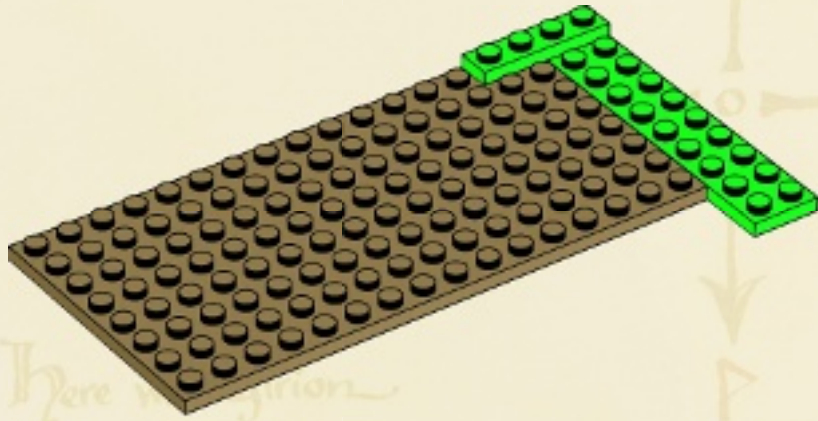

3

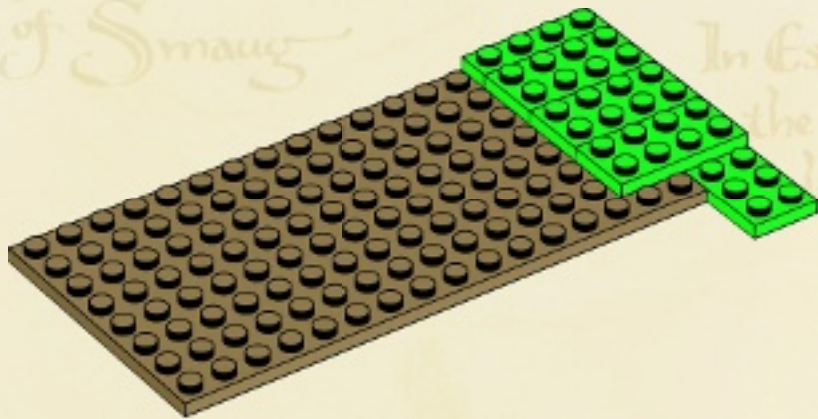



1x

4

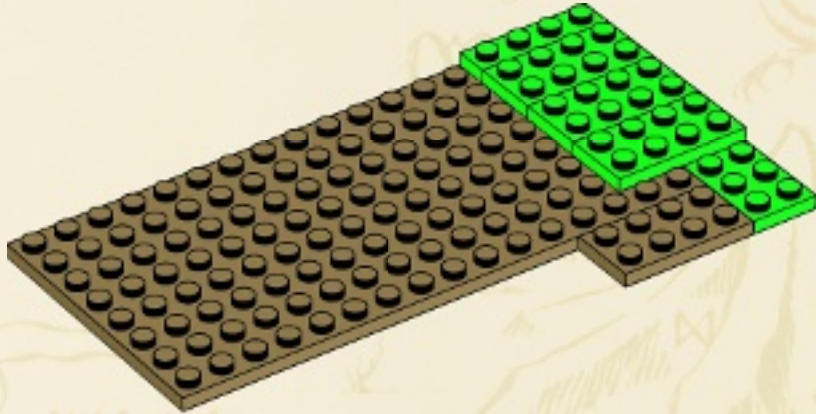

1x

5

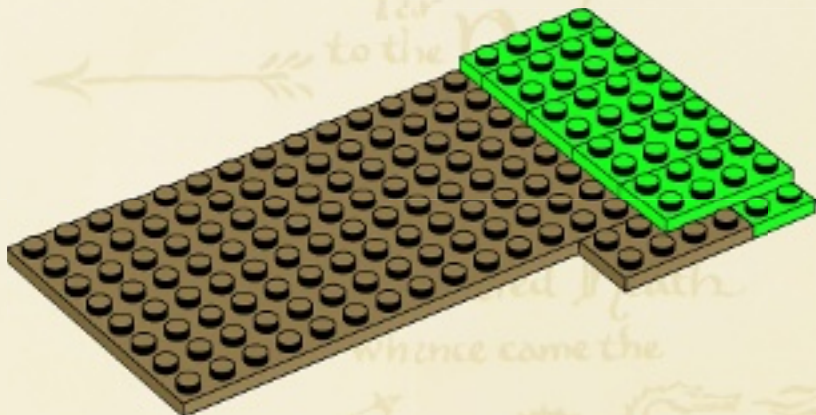

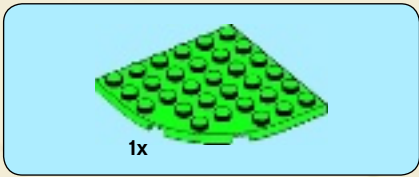

6

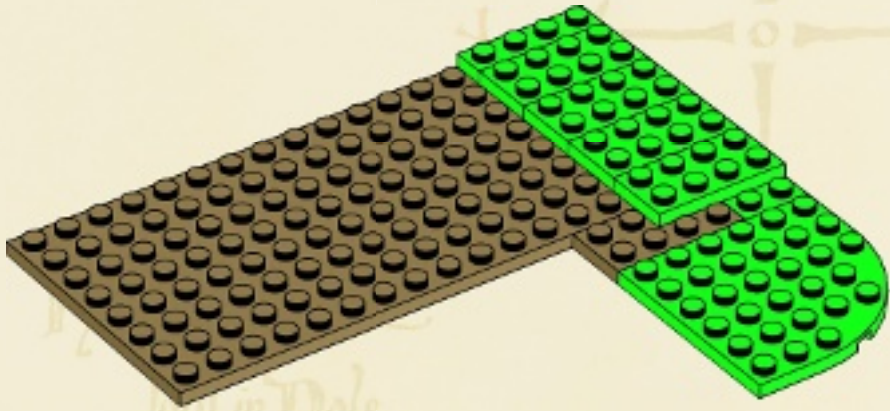

7

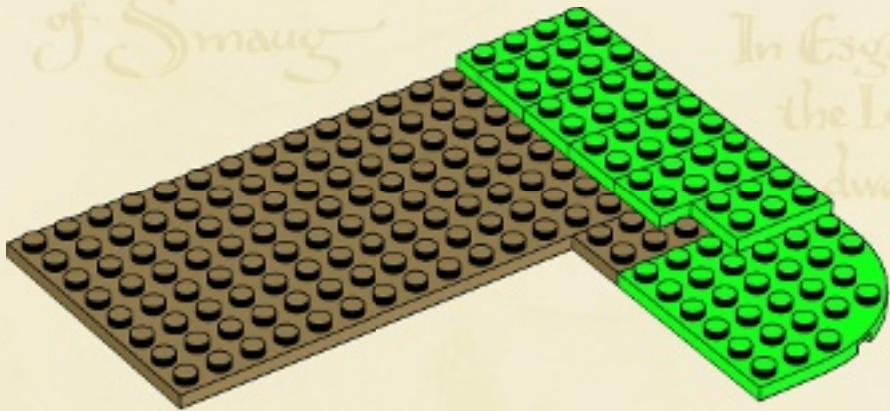

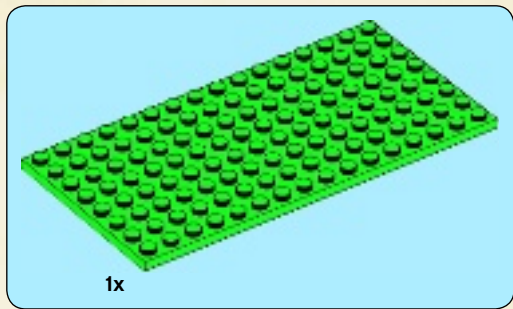

8

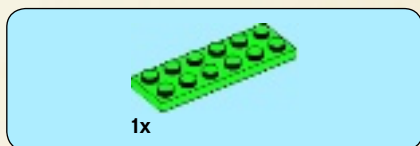
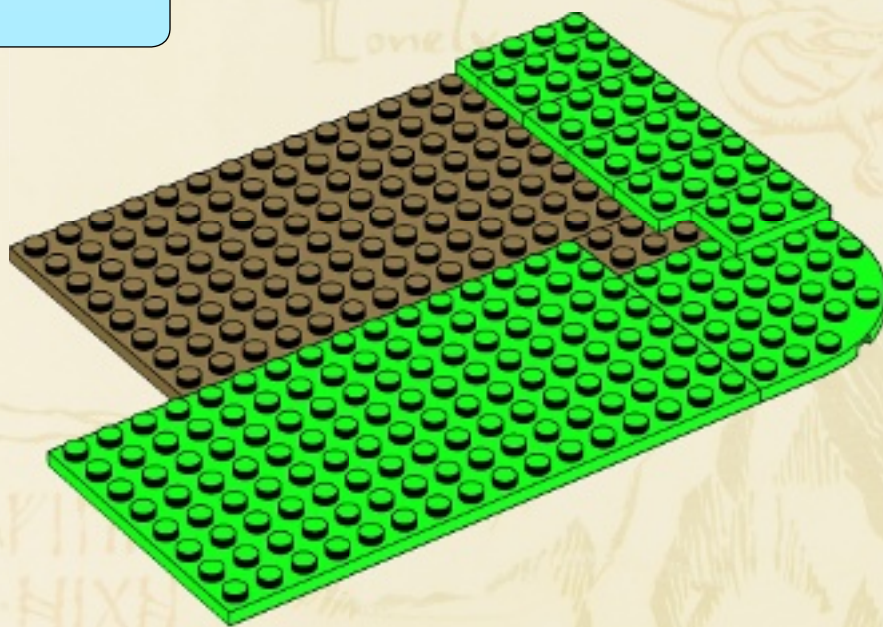

9

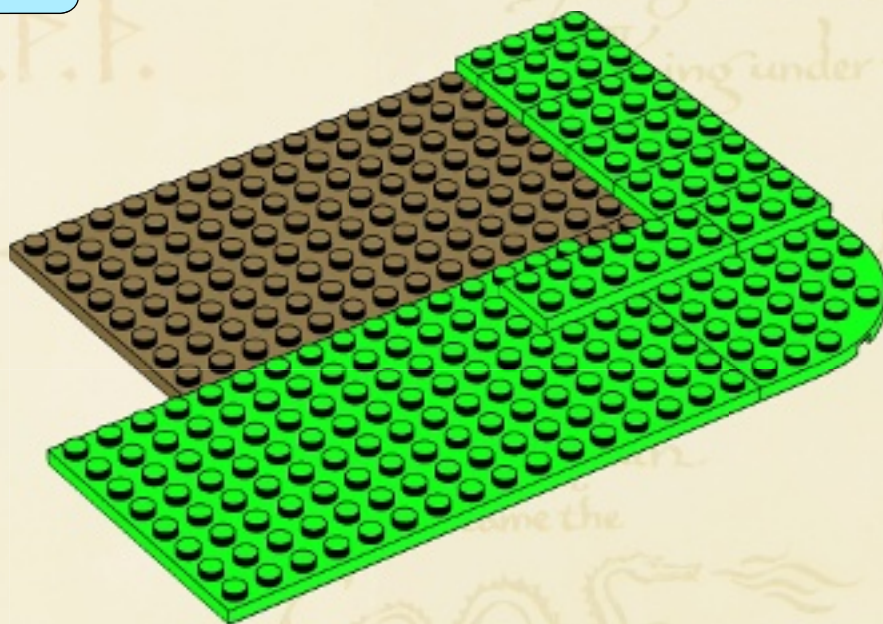

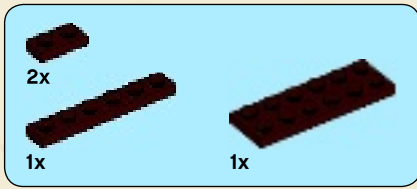

10

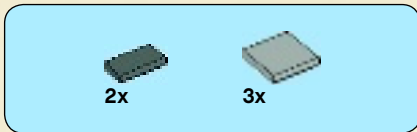
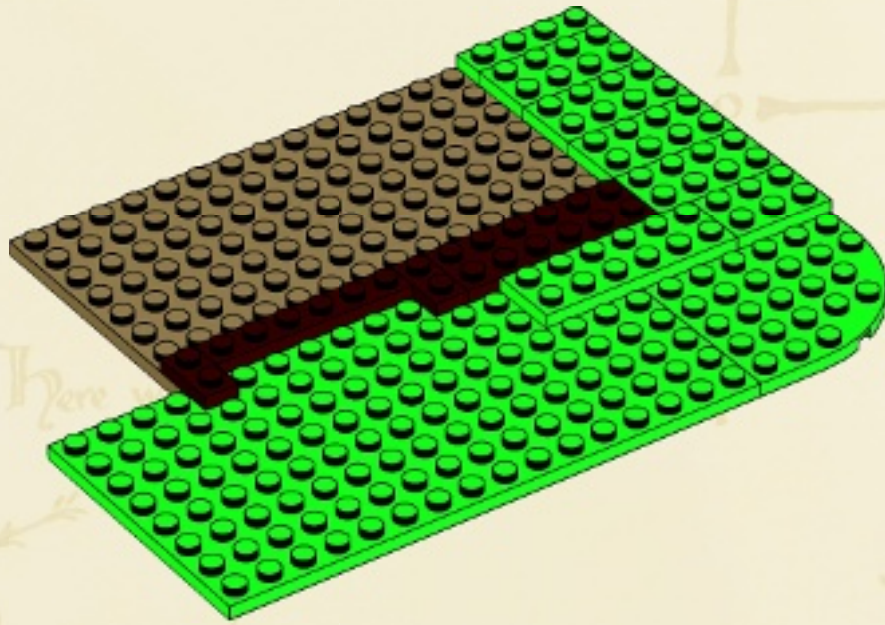

11

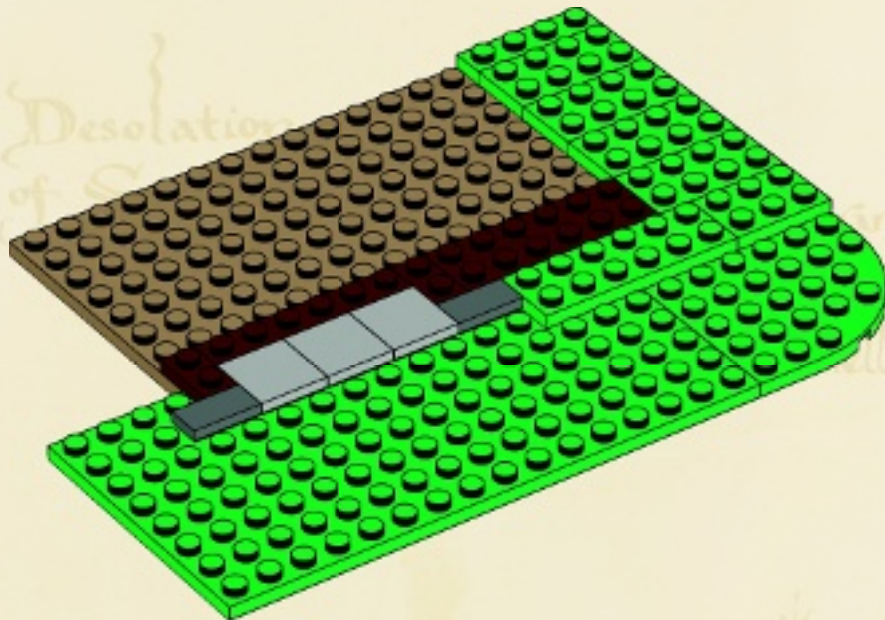

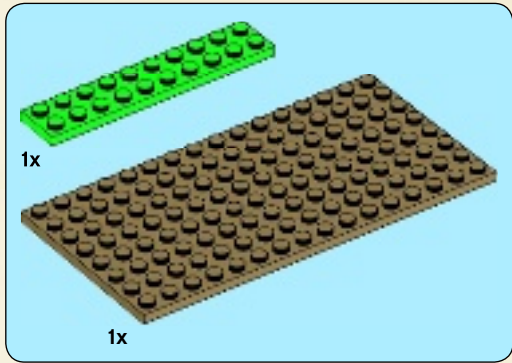
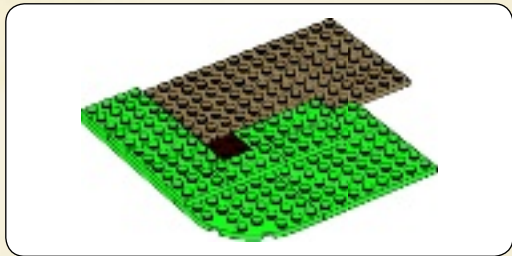

1

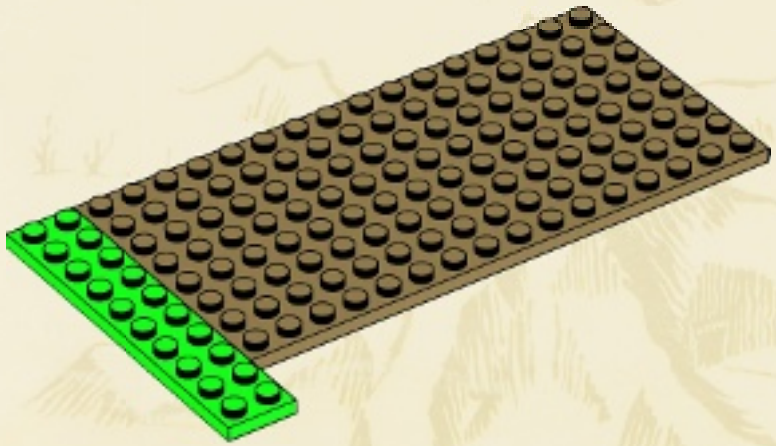

2

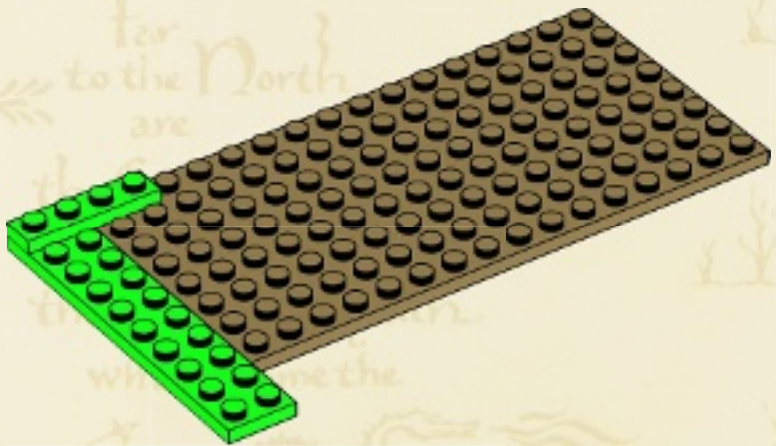



3

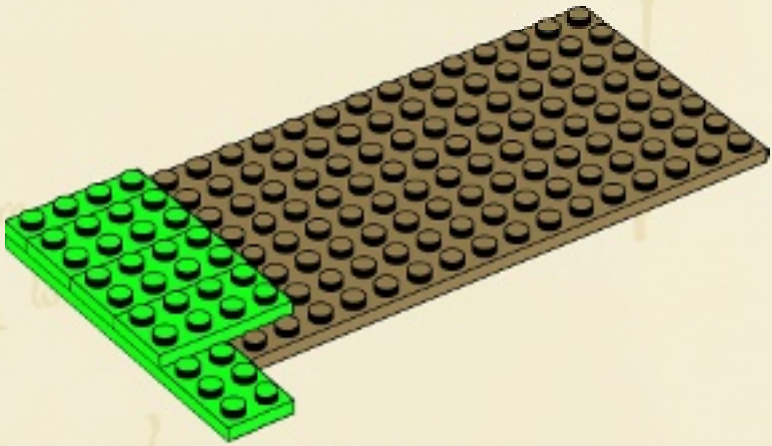

4

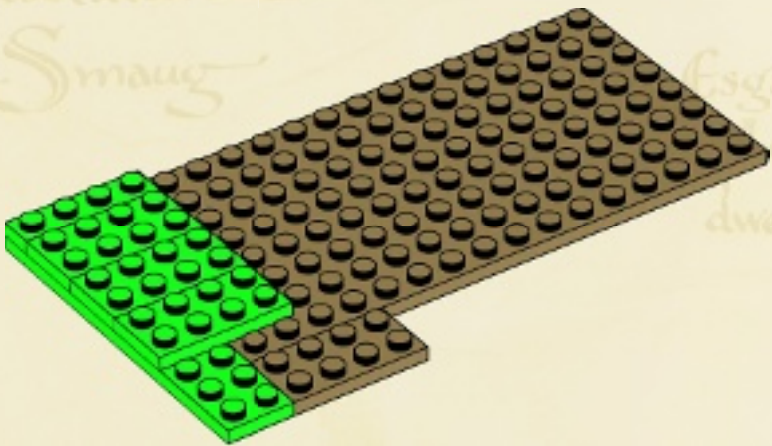



5

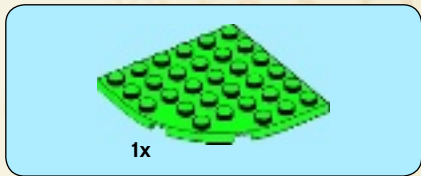
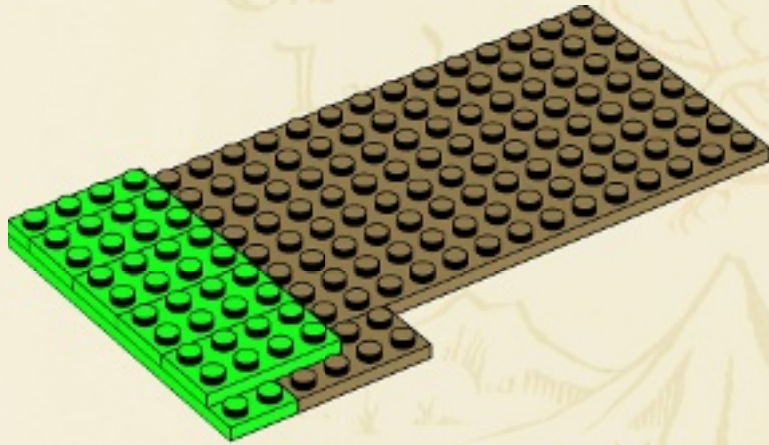

6

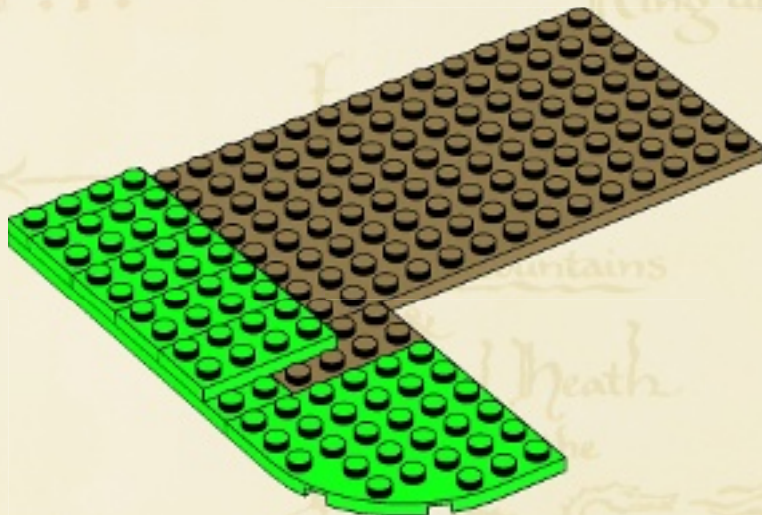



7

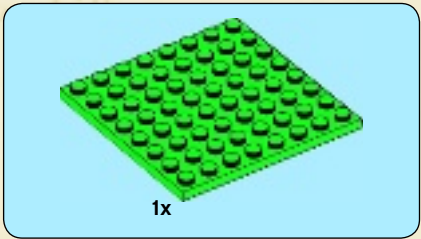
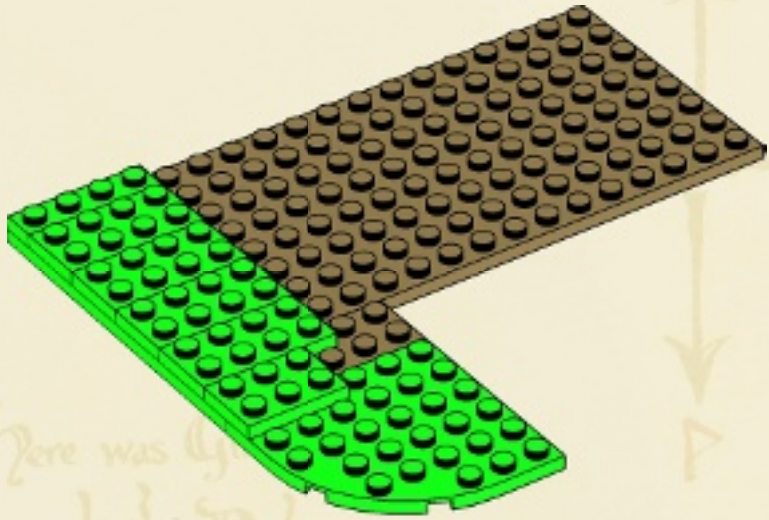

8

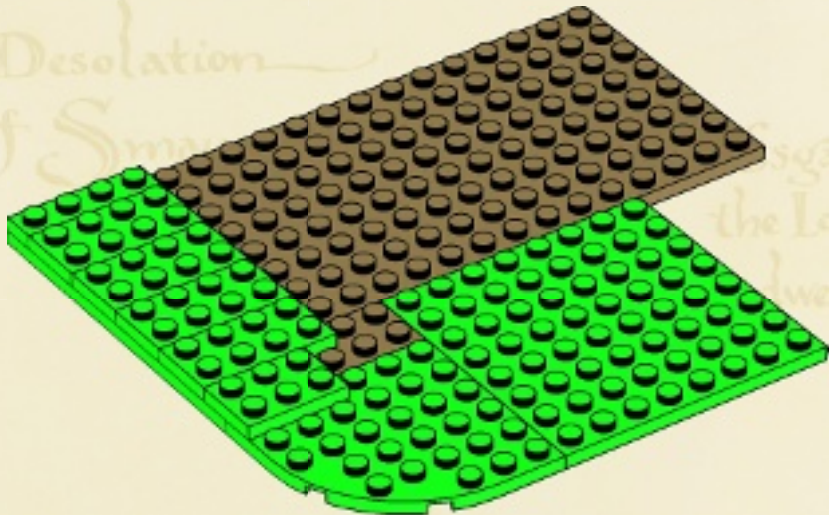



9

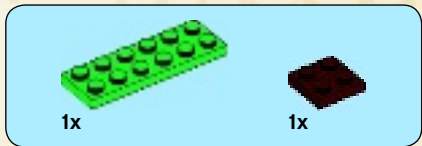
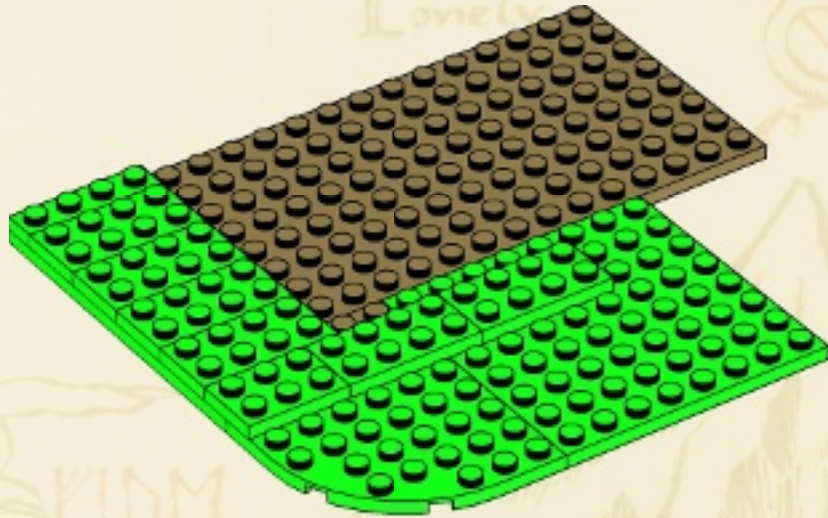

10

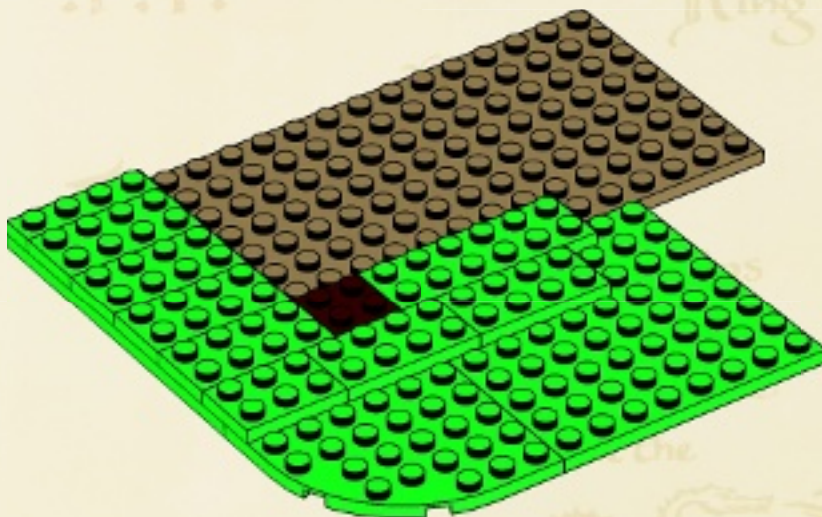

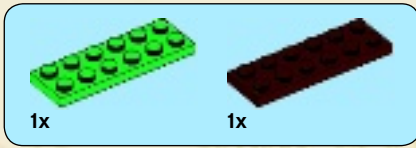

11

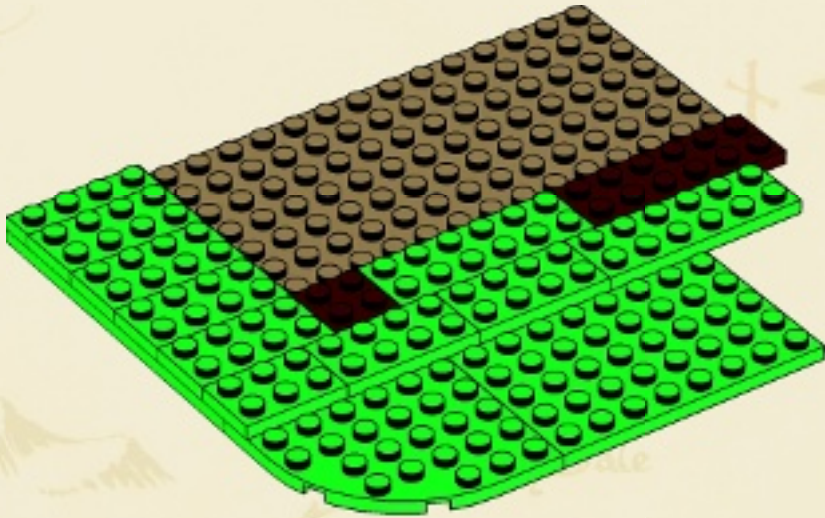

12

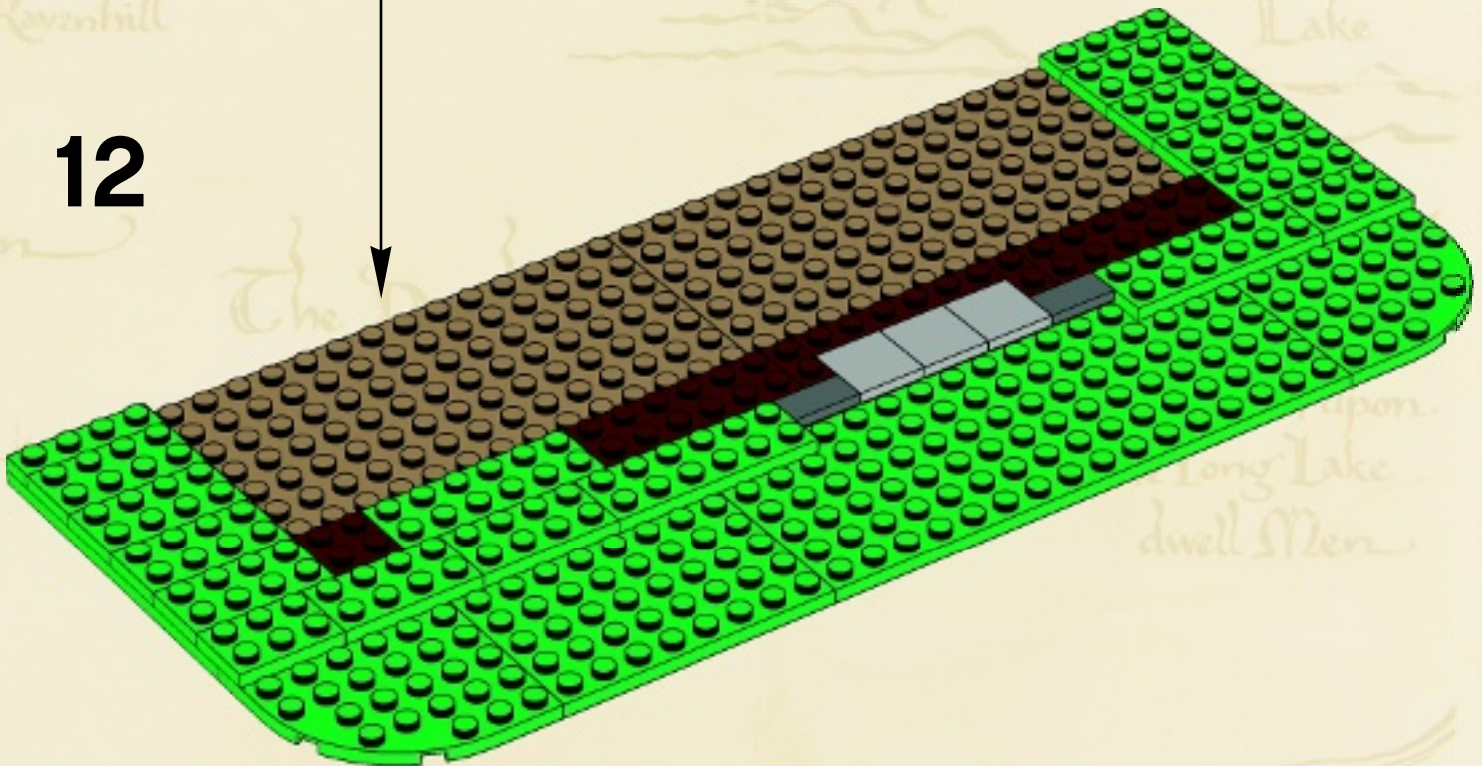

2x

13

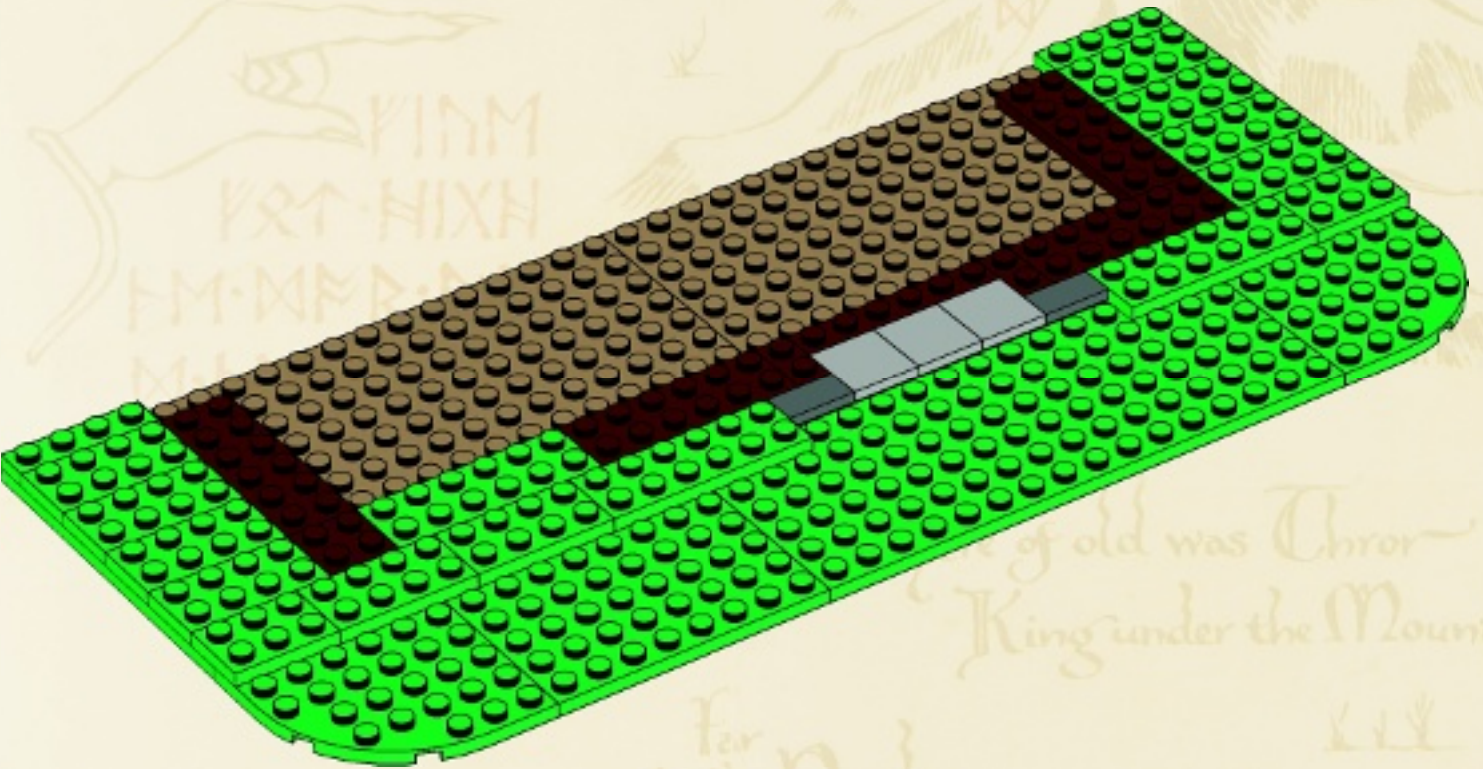

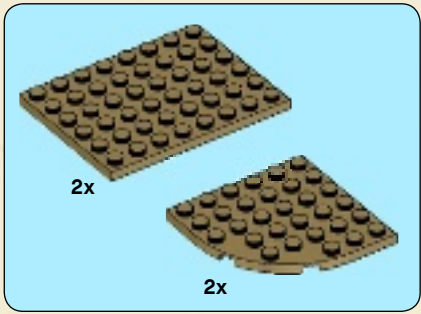

14

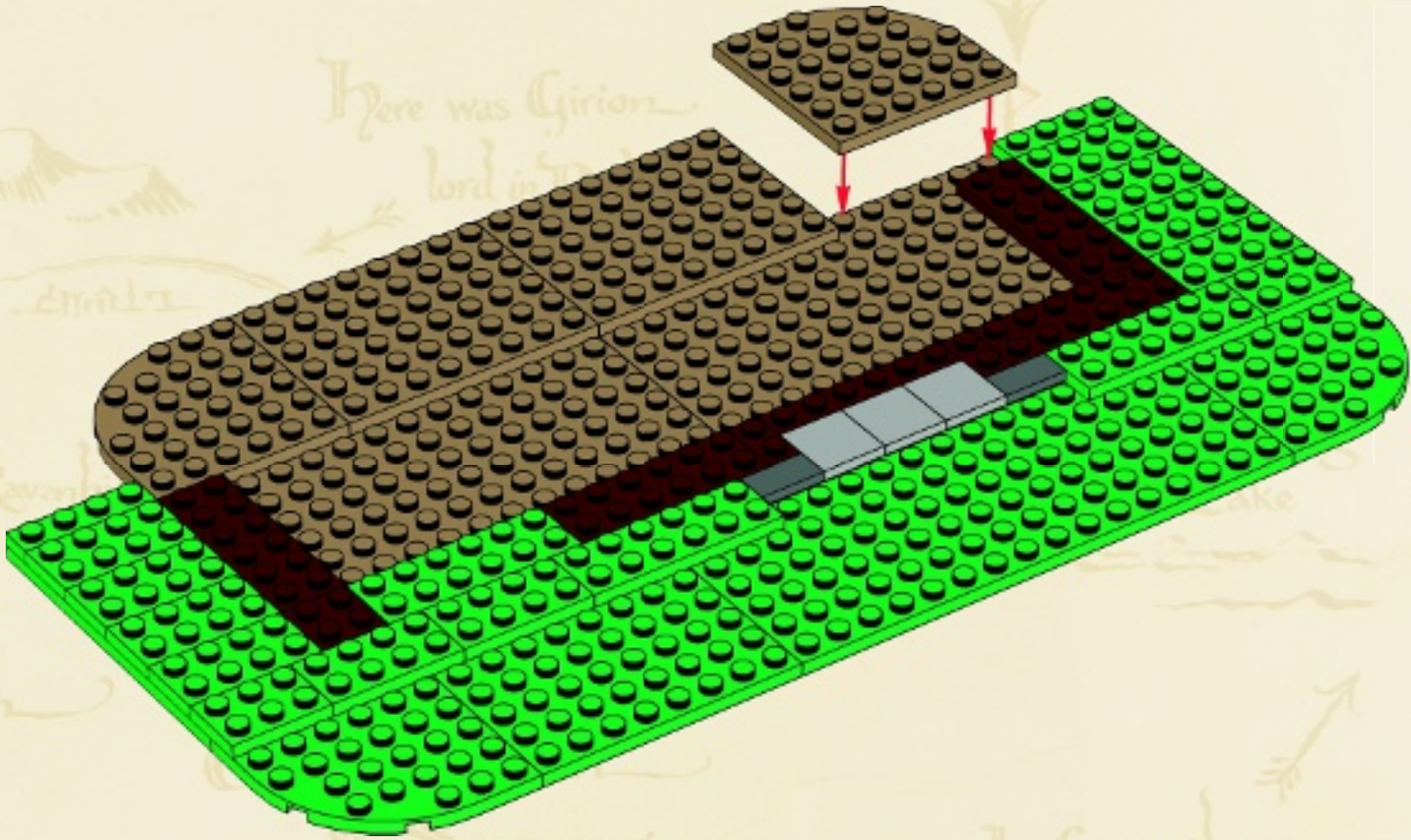



3x

15

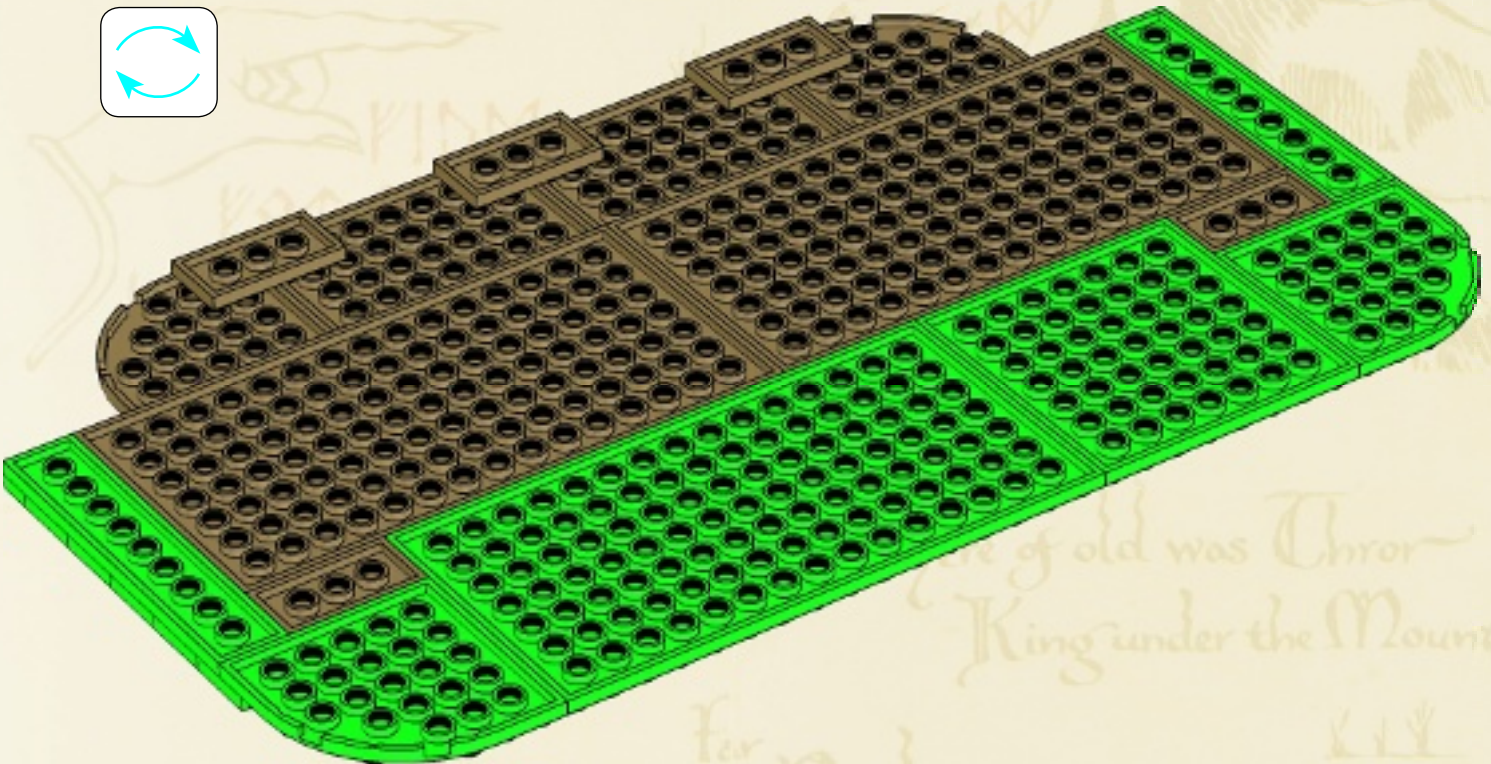

The
Lonely
Mountain

... of old was Thror
King under the Mountain

Far
to the North
are
the Grey Mountains
&
the Withered Heath
whence came the



16

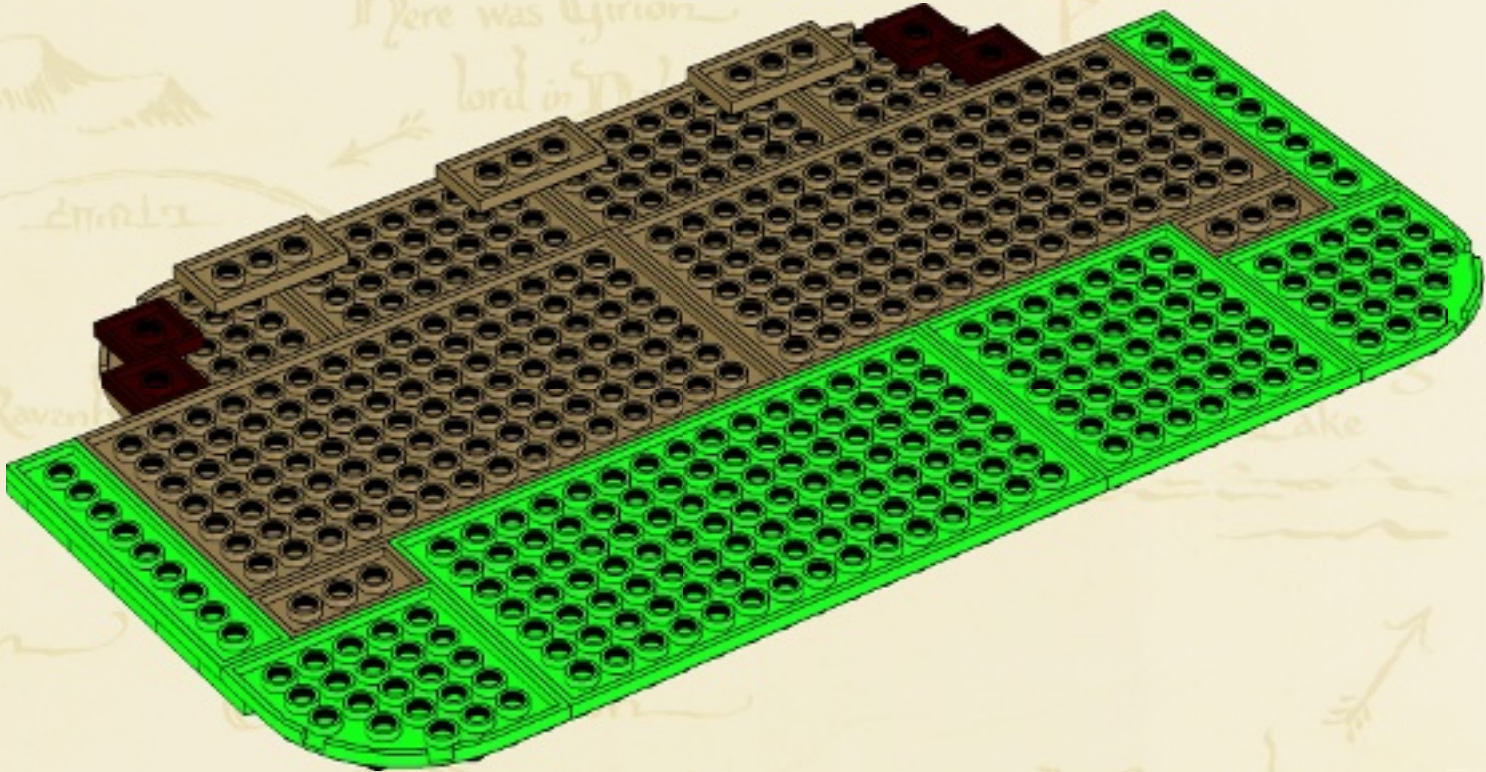

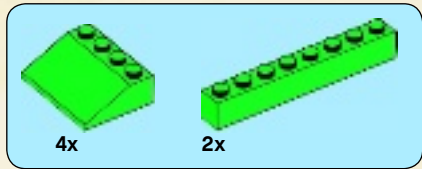

17

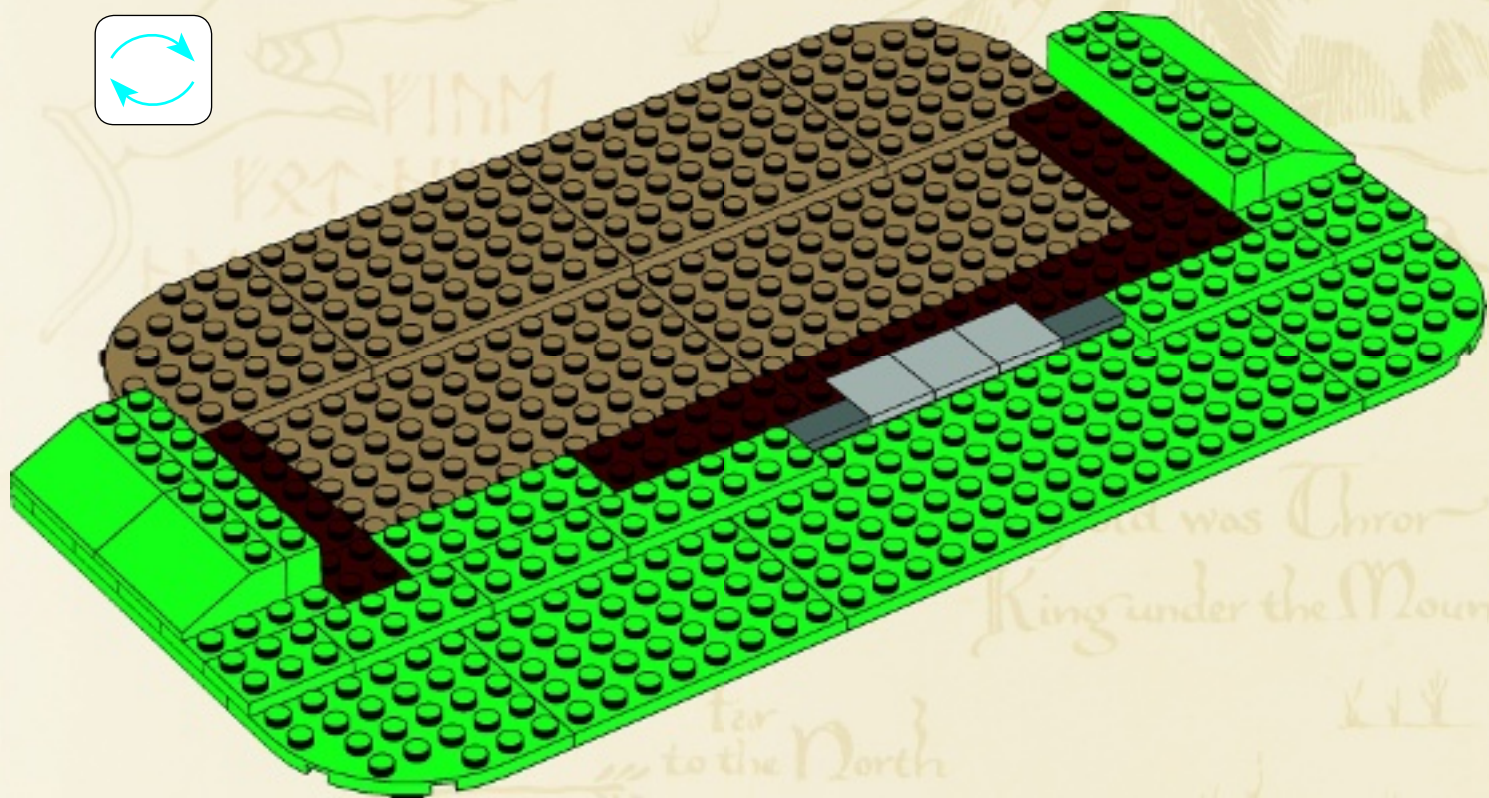
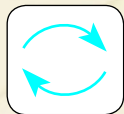

The
Lonely
Mountain

... was Thoror
King under the Mount

Far
to the North
are
the Grey Mountains
&
the Withered Heath
whence came the



18

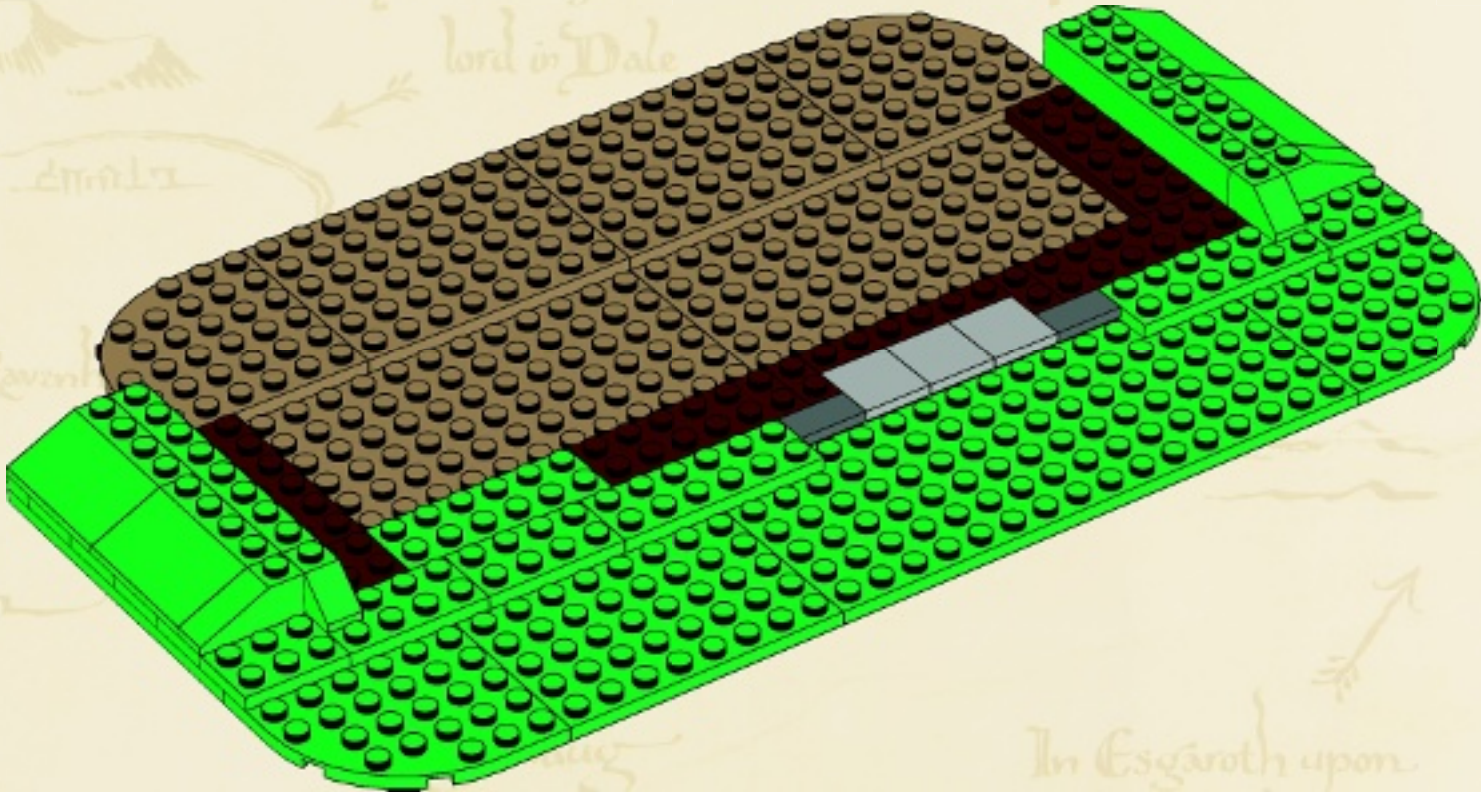

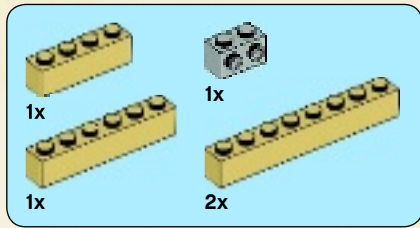

19

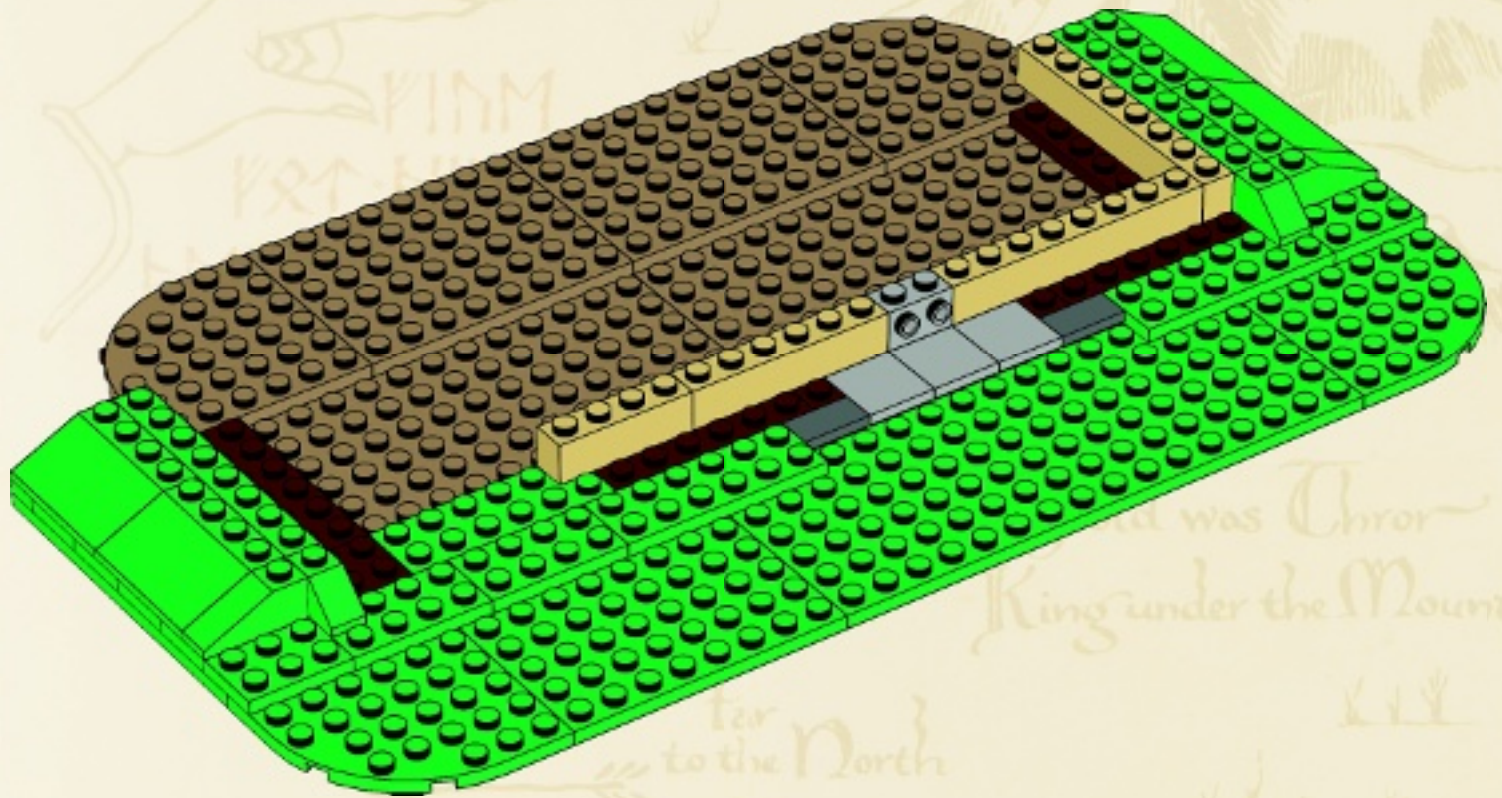

Far
to the North
are
the Grey Mountains
&
the Withered Heath
whence came the

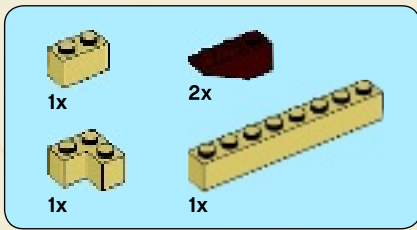

20

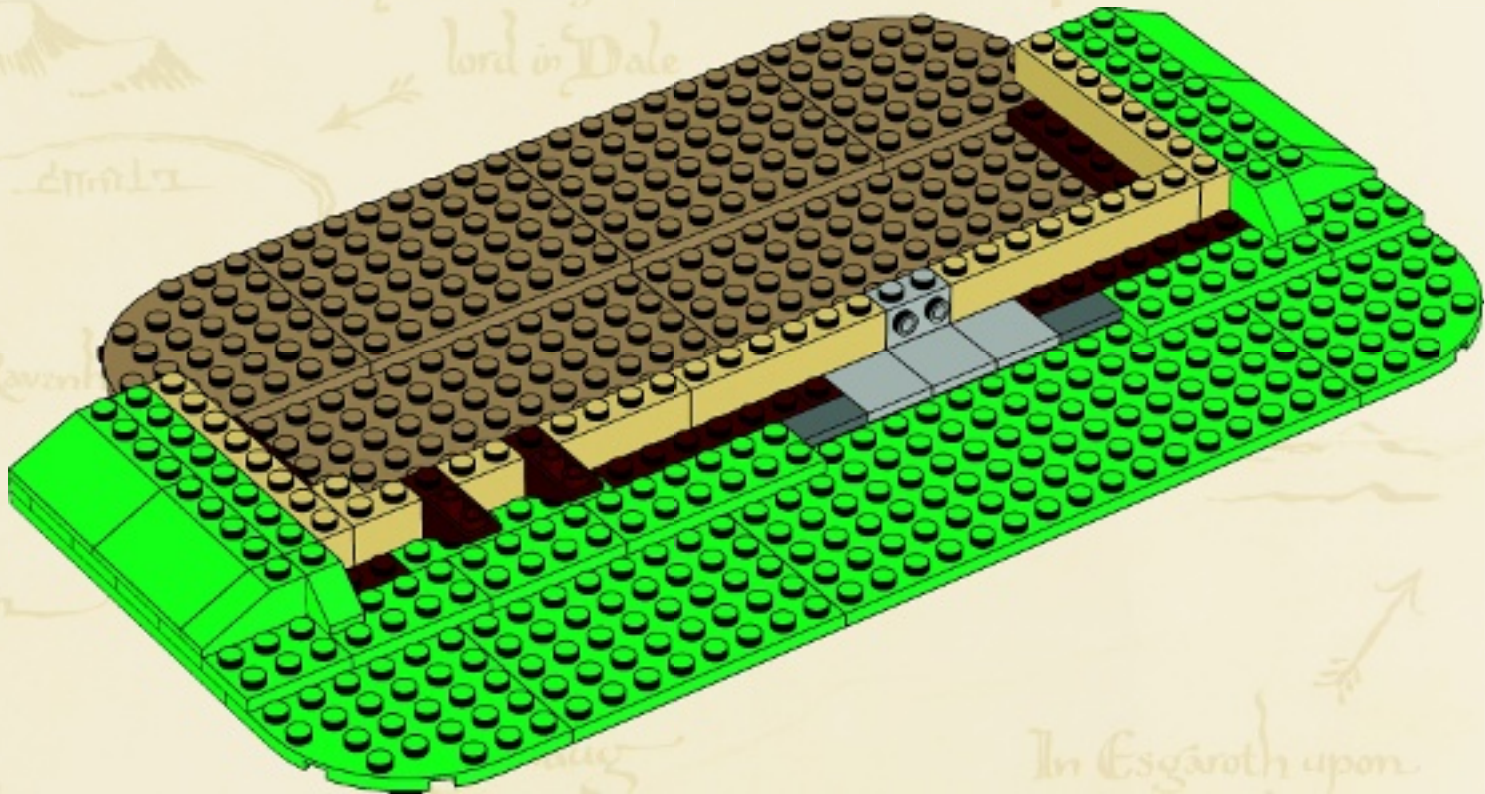

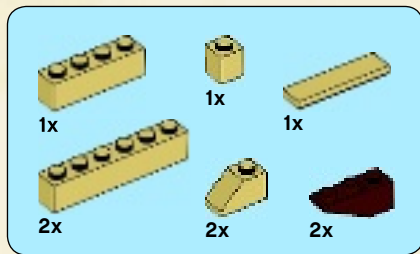

21

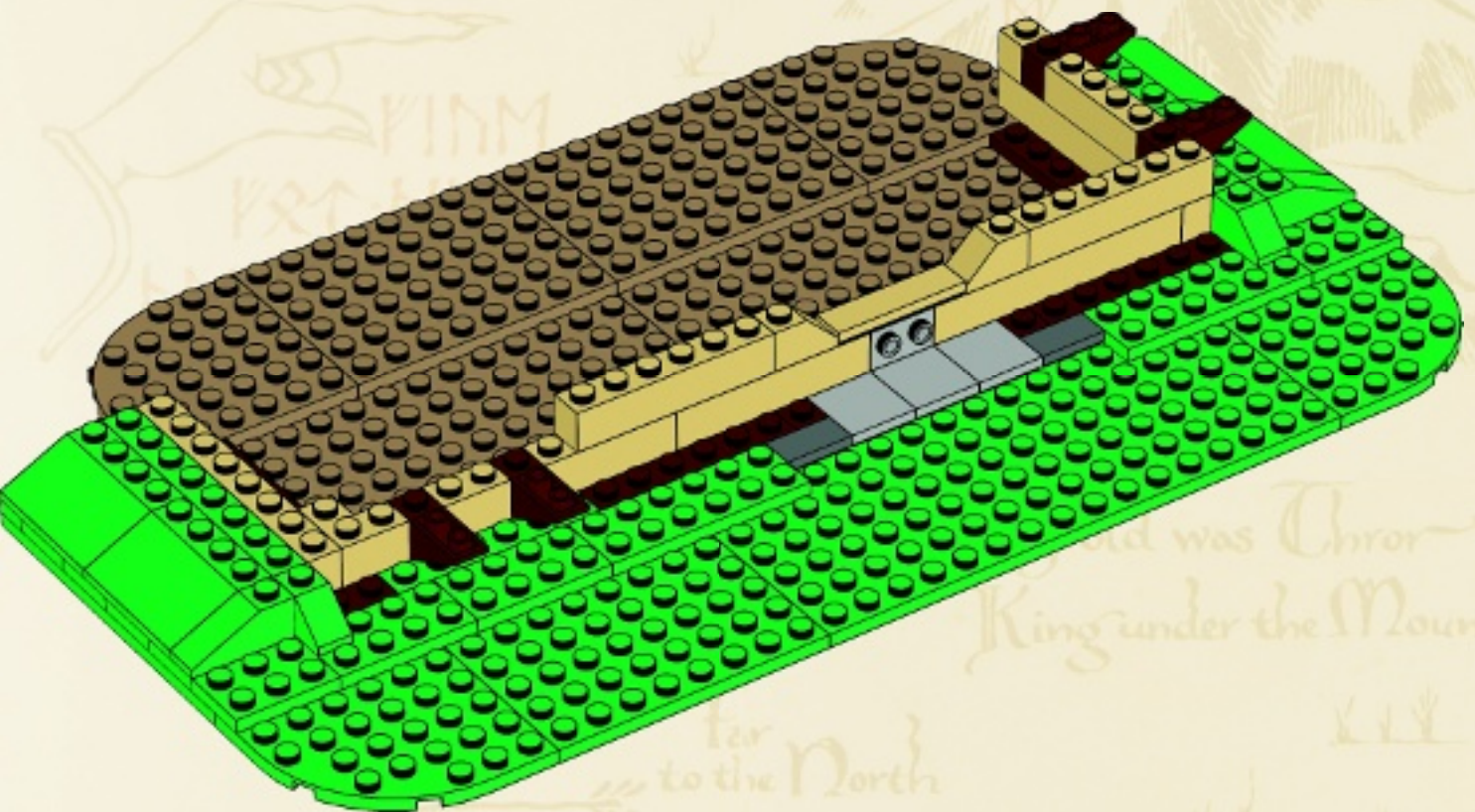

far
to the North
are
the Grey Mountains
&
the Withered Heath
whence came the

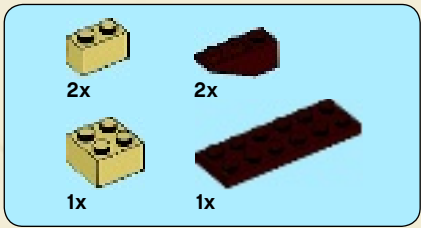

22

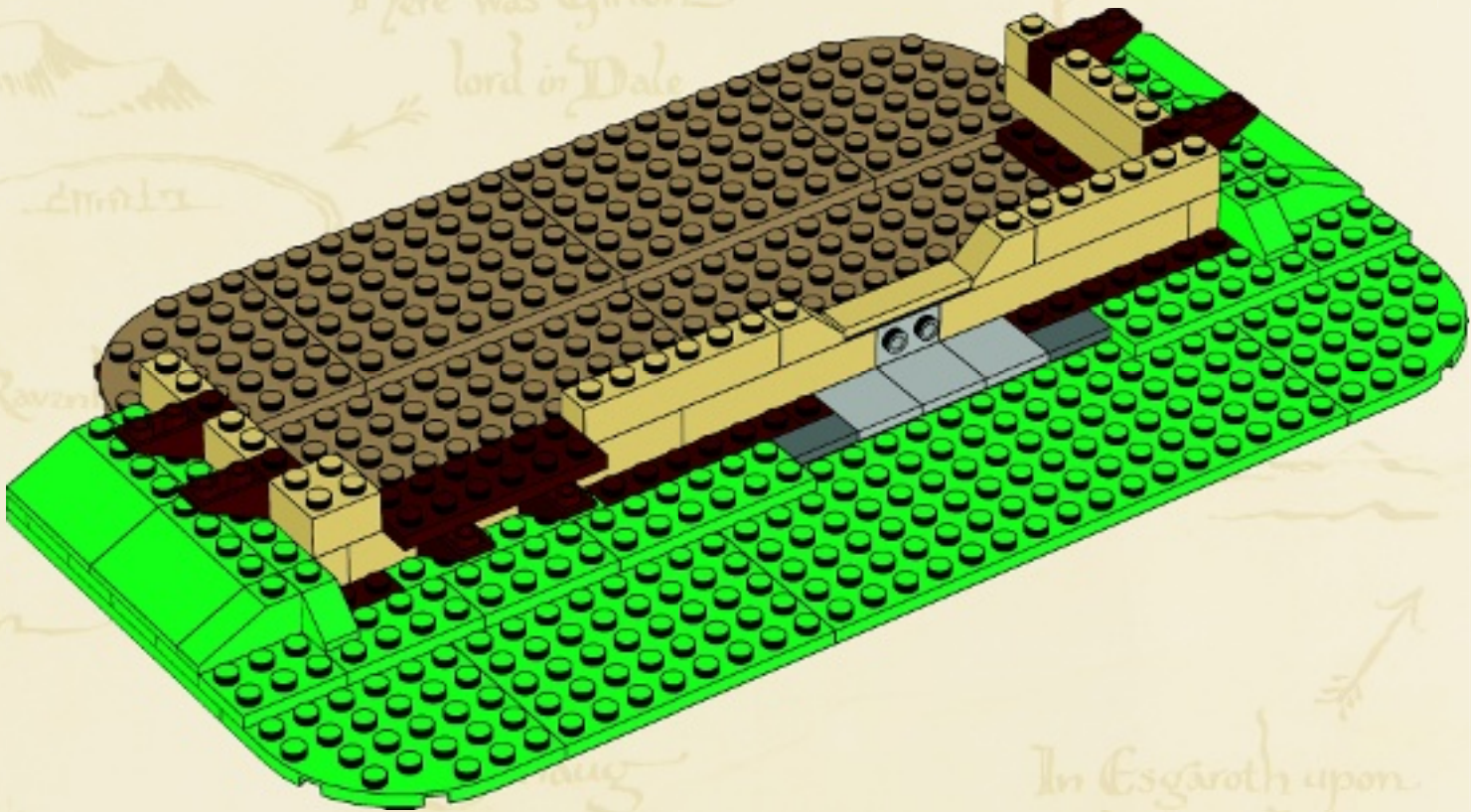

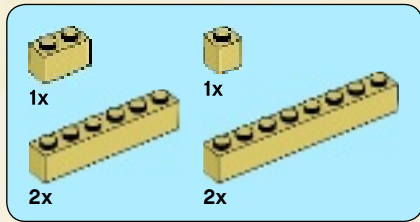

23

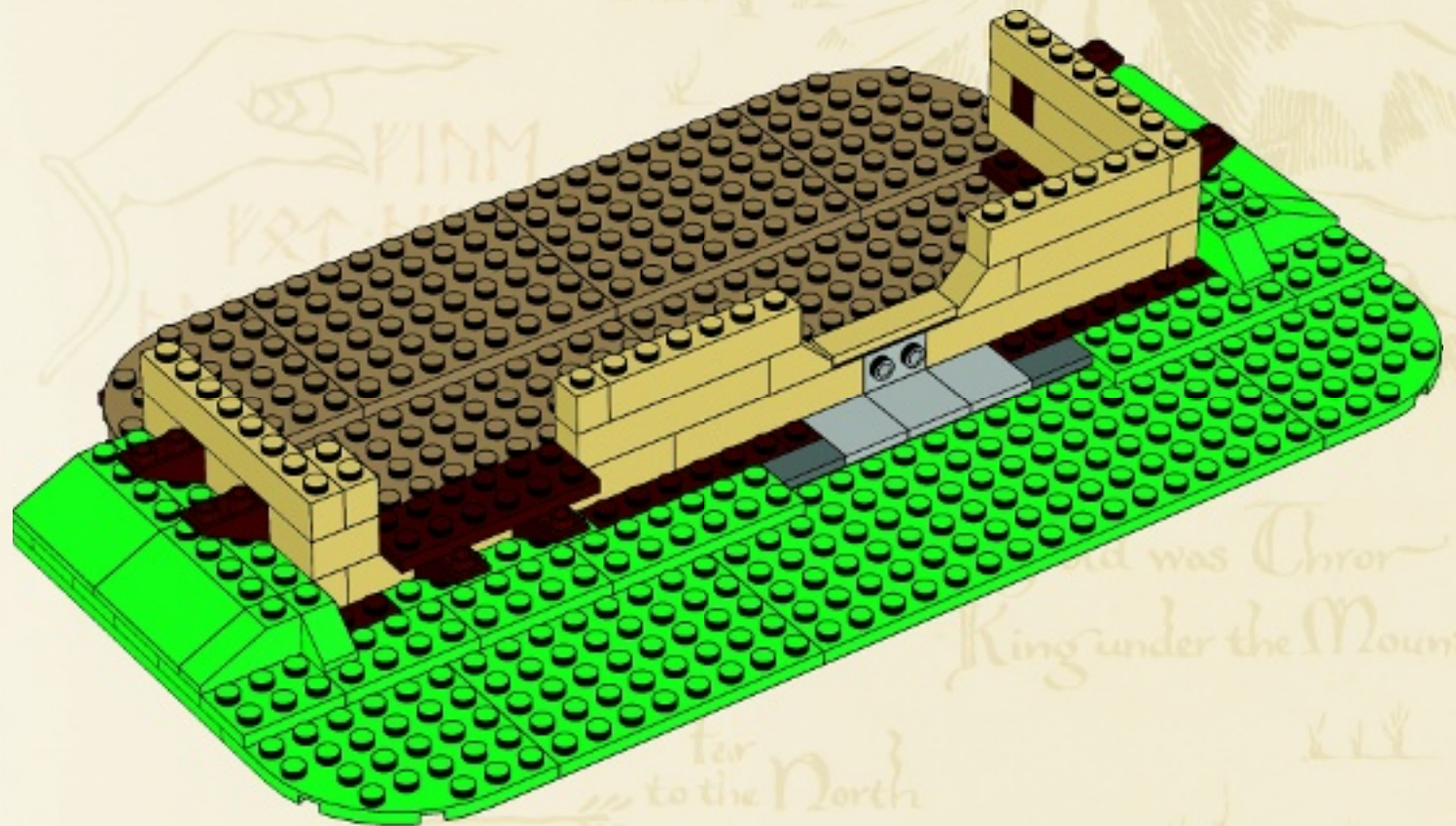

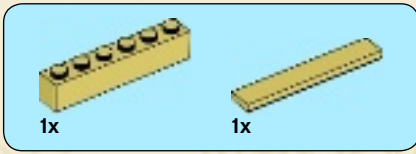

Far
to the North
are
the Grey Mountains
&
the Withered Heath
whence came the

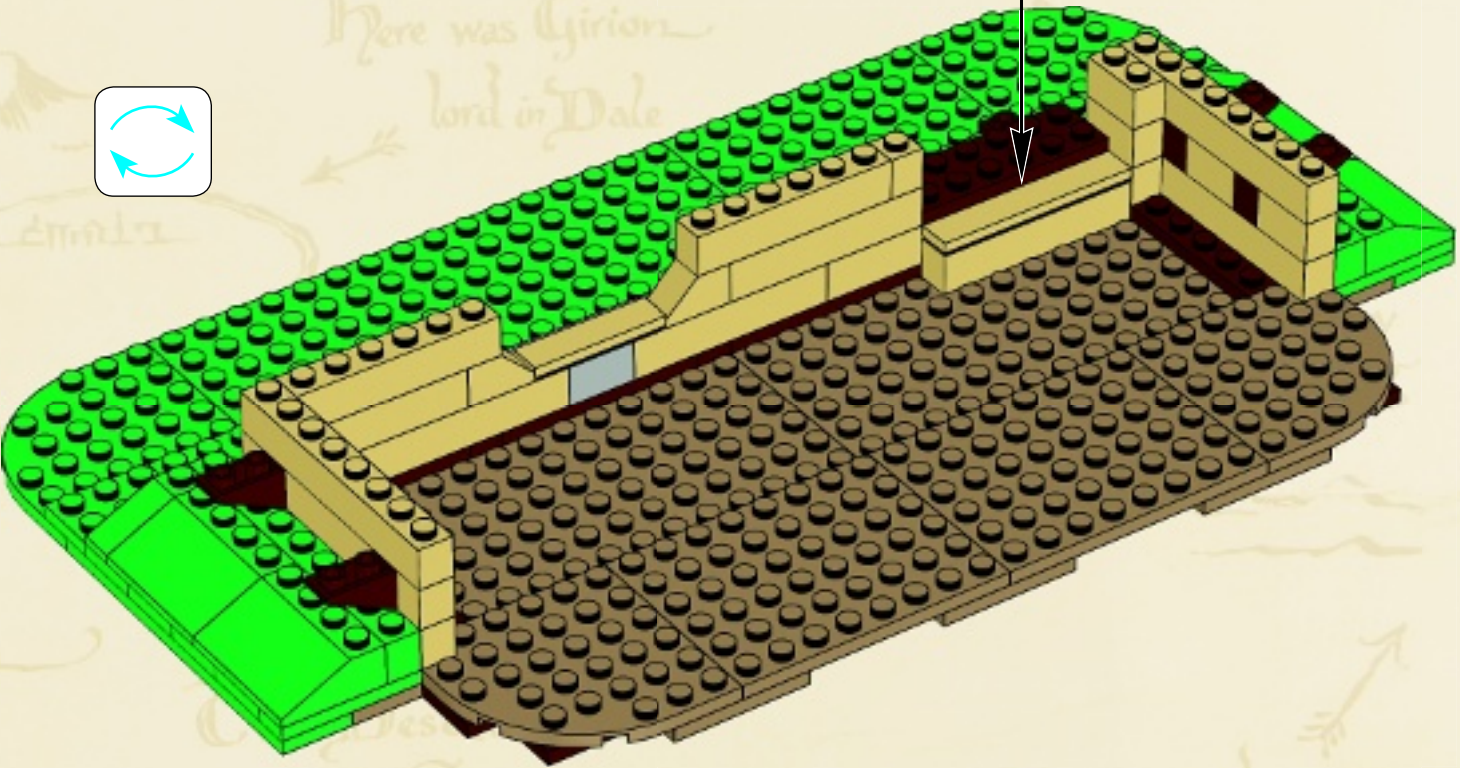
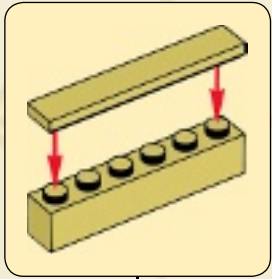

24



2x  1x 

25

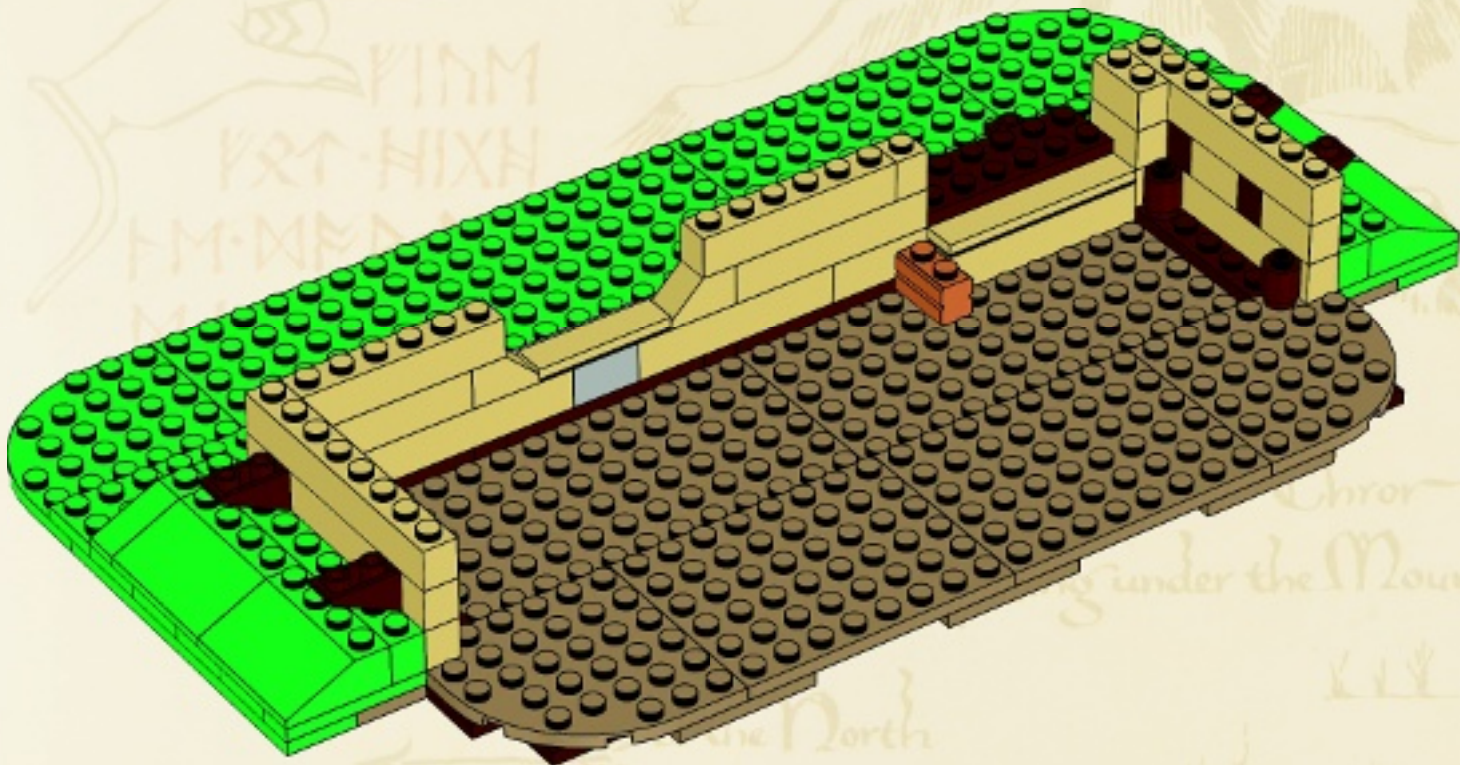

The
Lonely
Mountain

Horror
Under the Mountain

the North
are
the Grey Mountains
&
the Withered Heath
whence came the



26

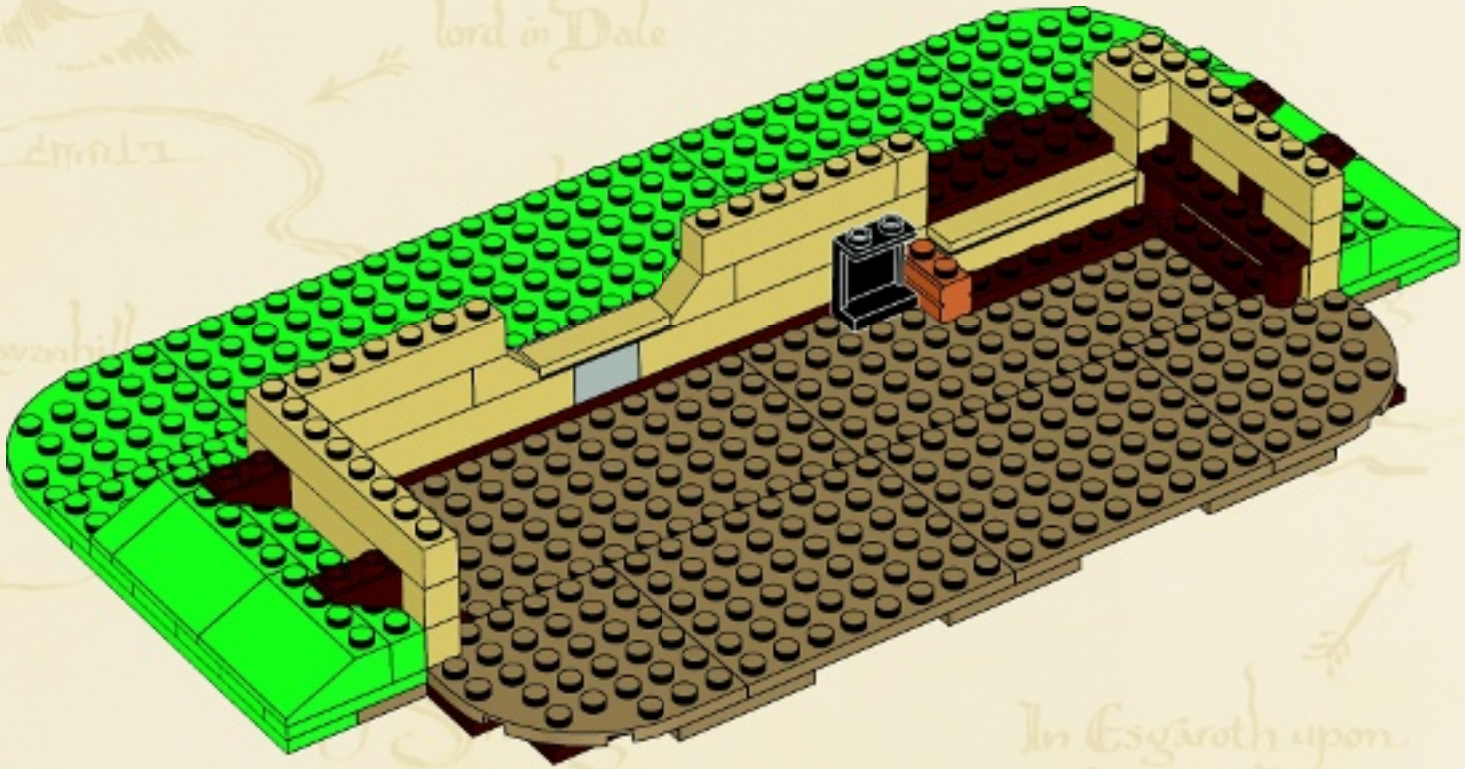

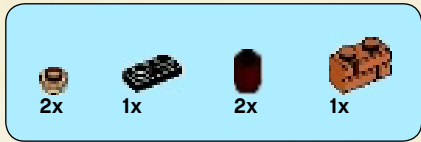

27

- 1 
- 2 

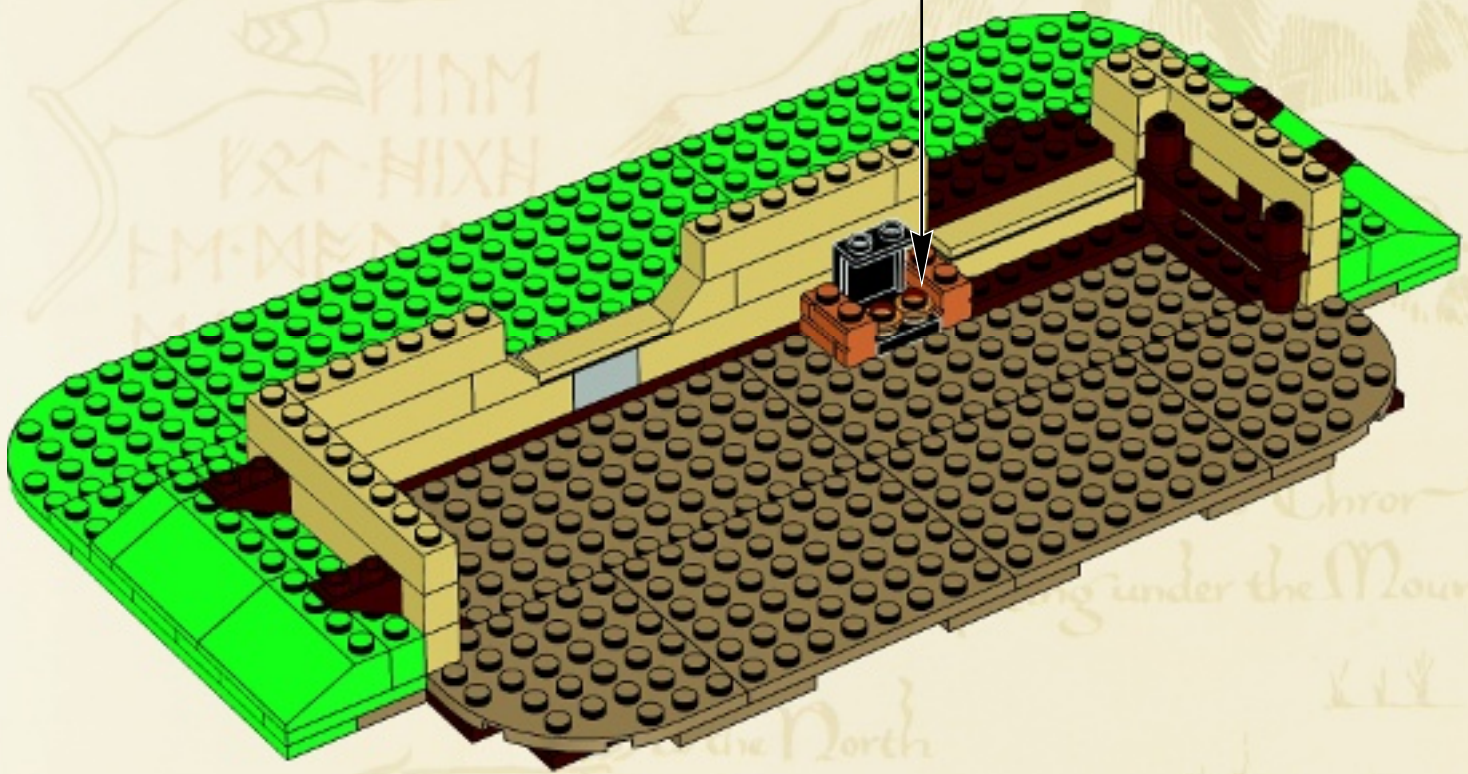



28

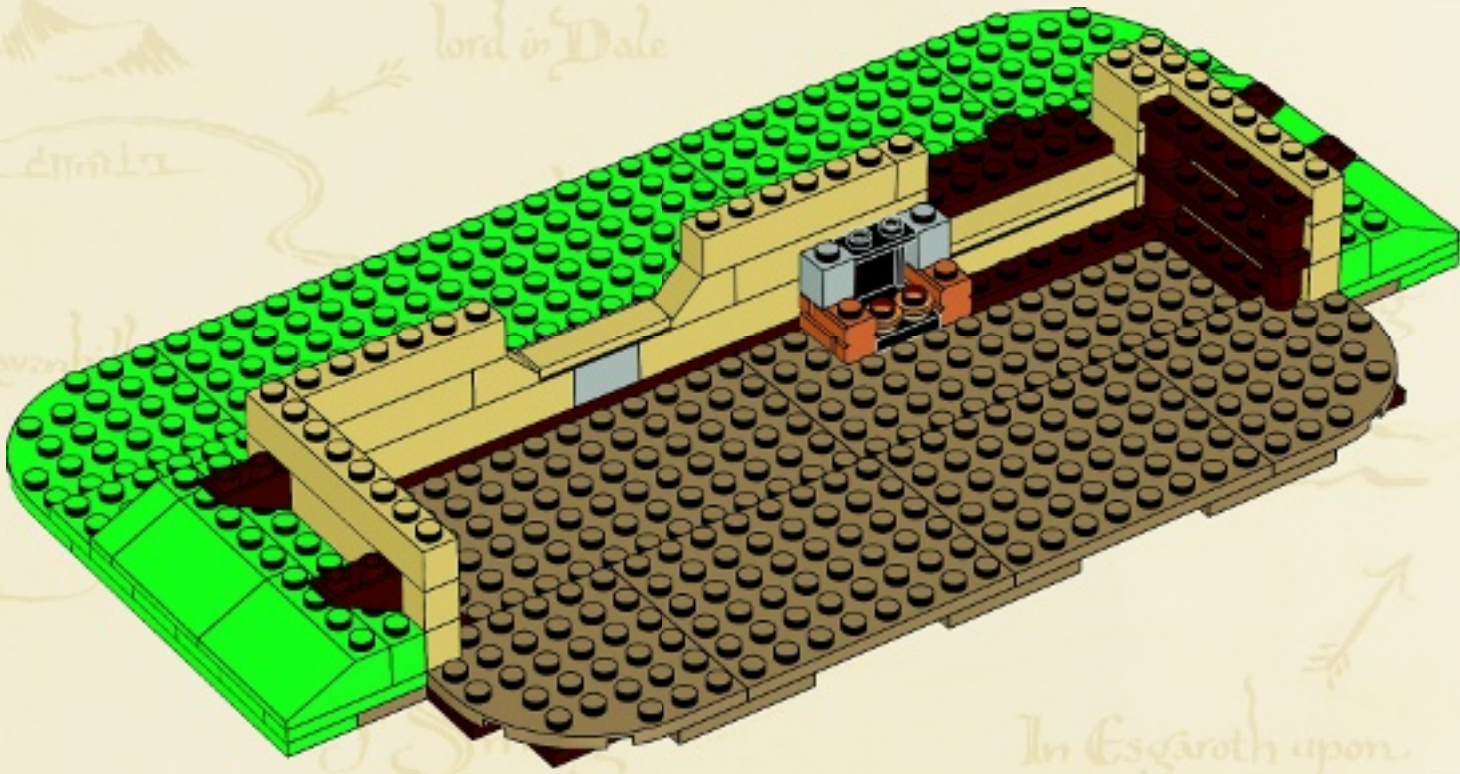



29

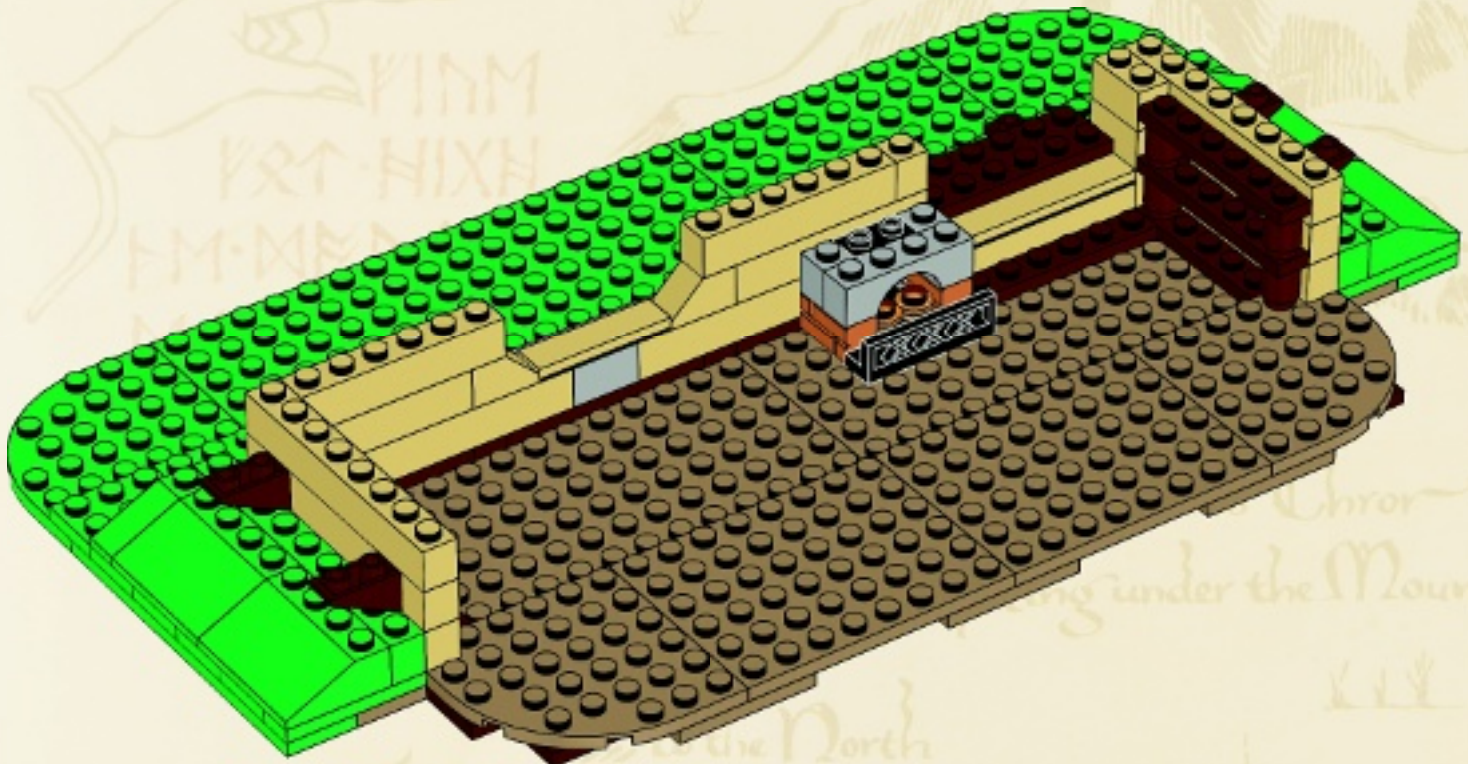

The
Lonely
Mountain

VINM
KST·HIXH
FM·MMA

Chror
ing under the Mount

the North
are
the Grey Mountains
&
the Withered Heath
whence came the

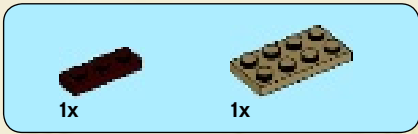

30

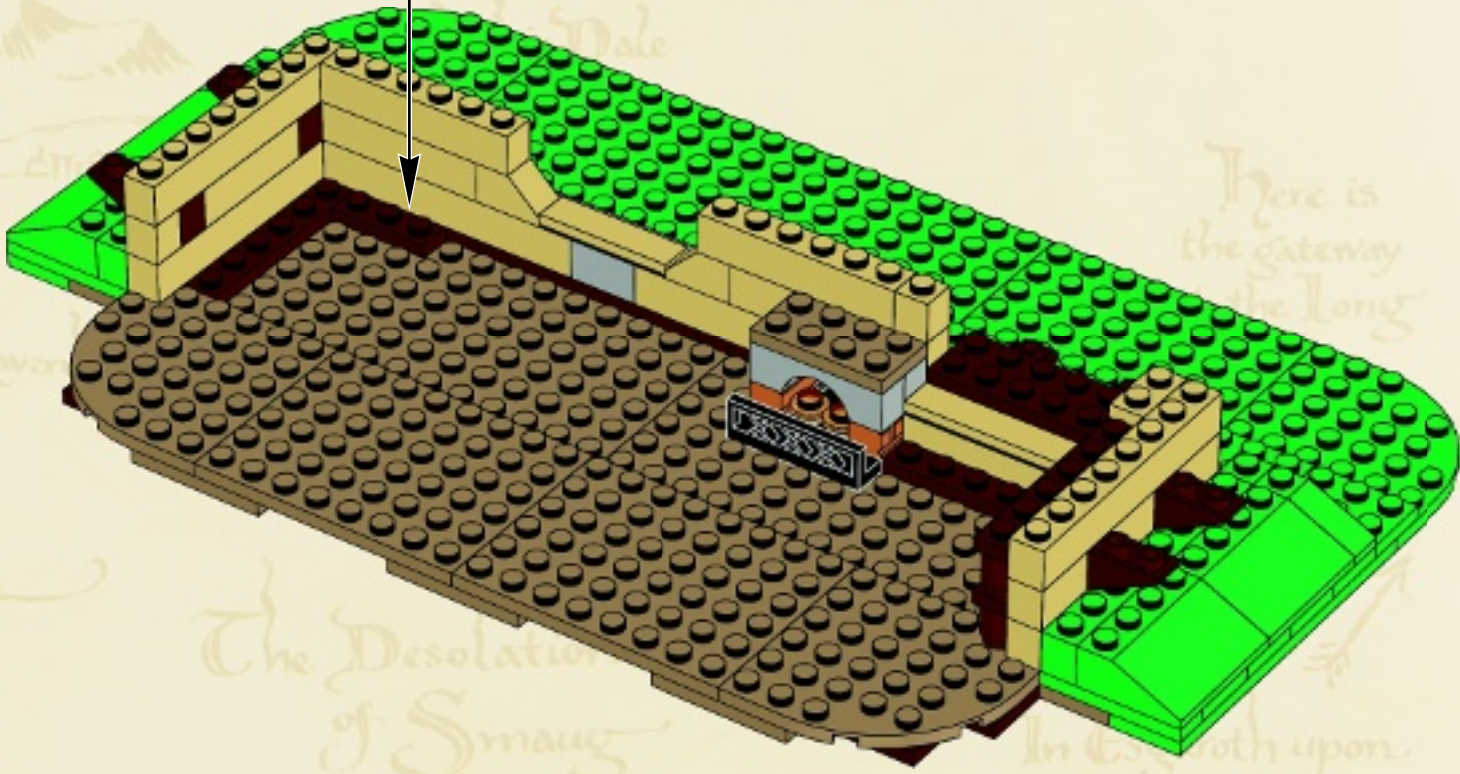
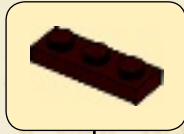
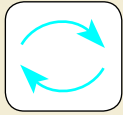



2x



1x

31

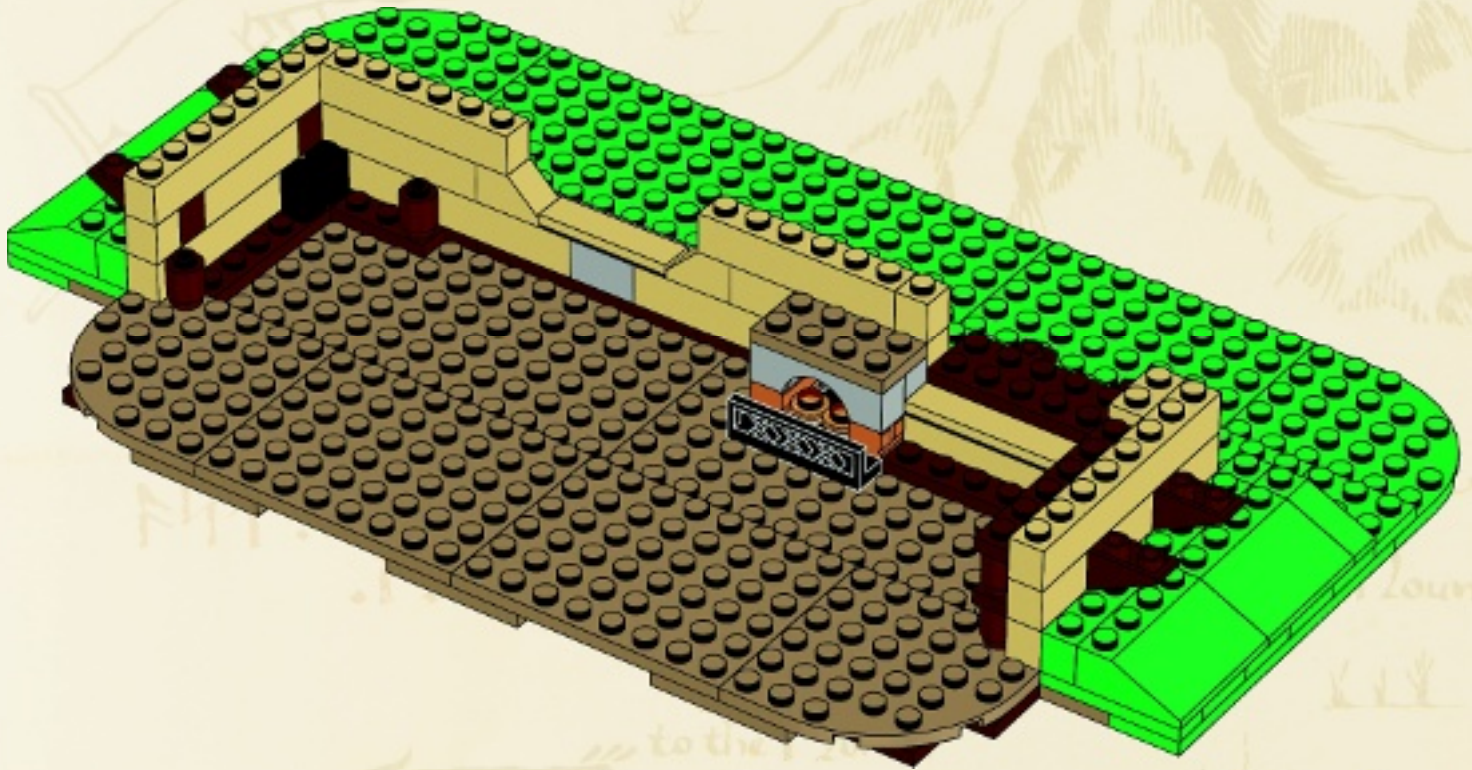

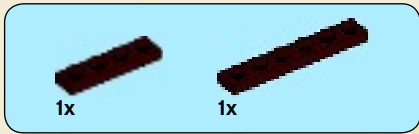

32

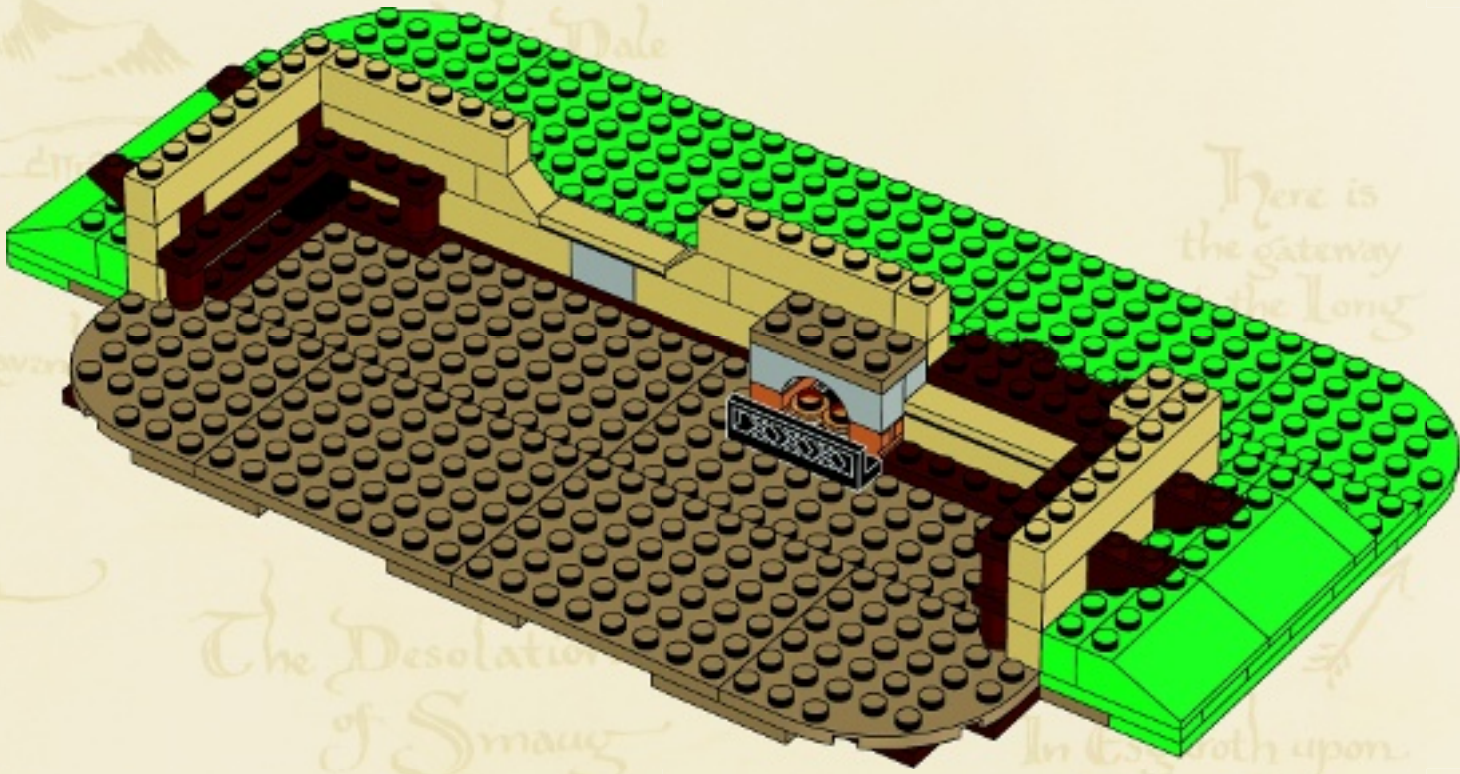



2x



1x

33

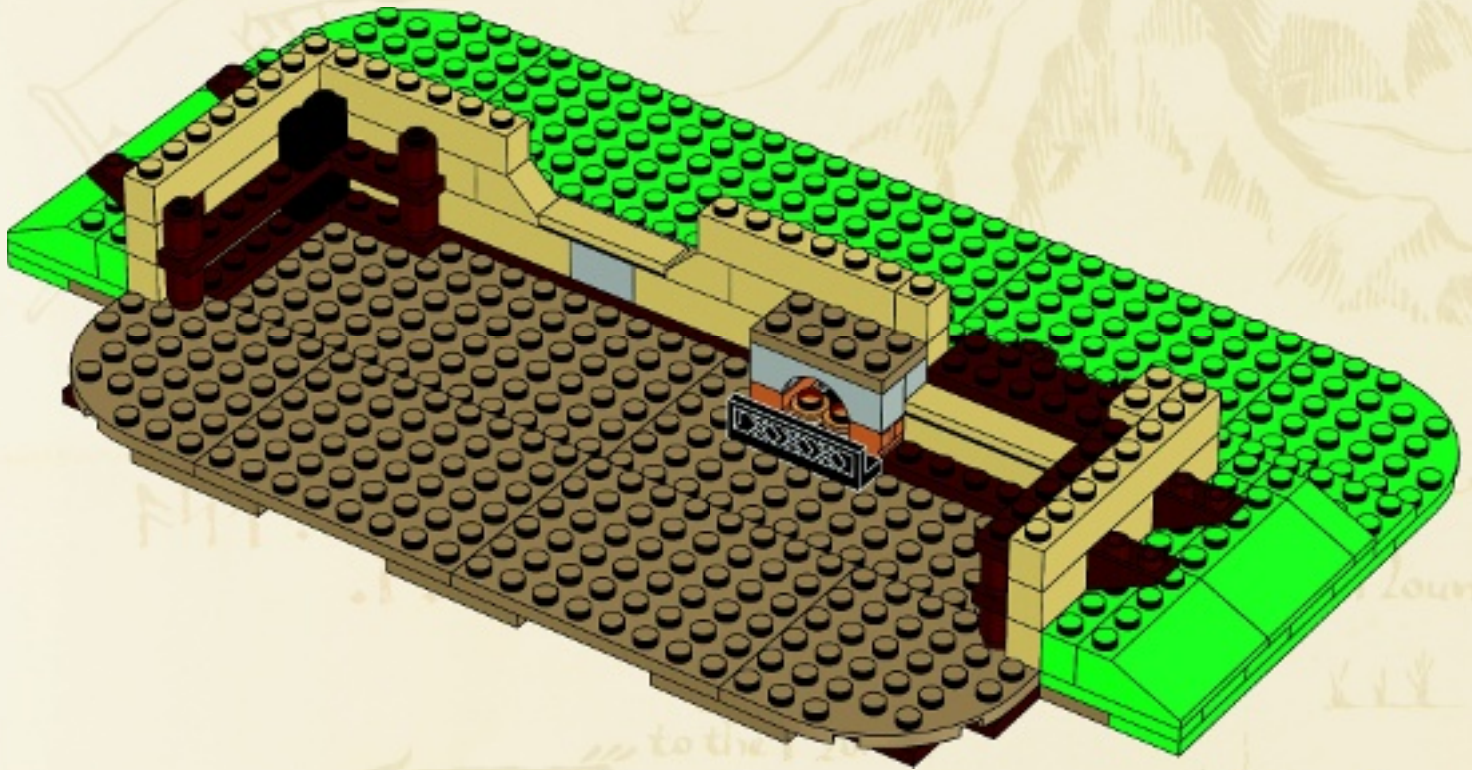

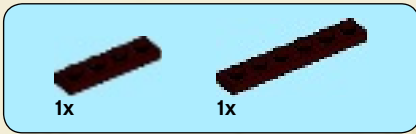

34

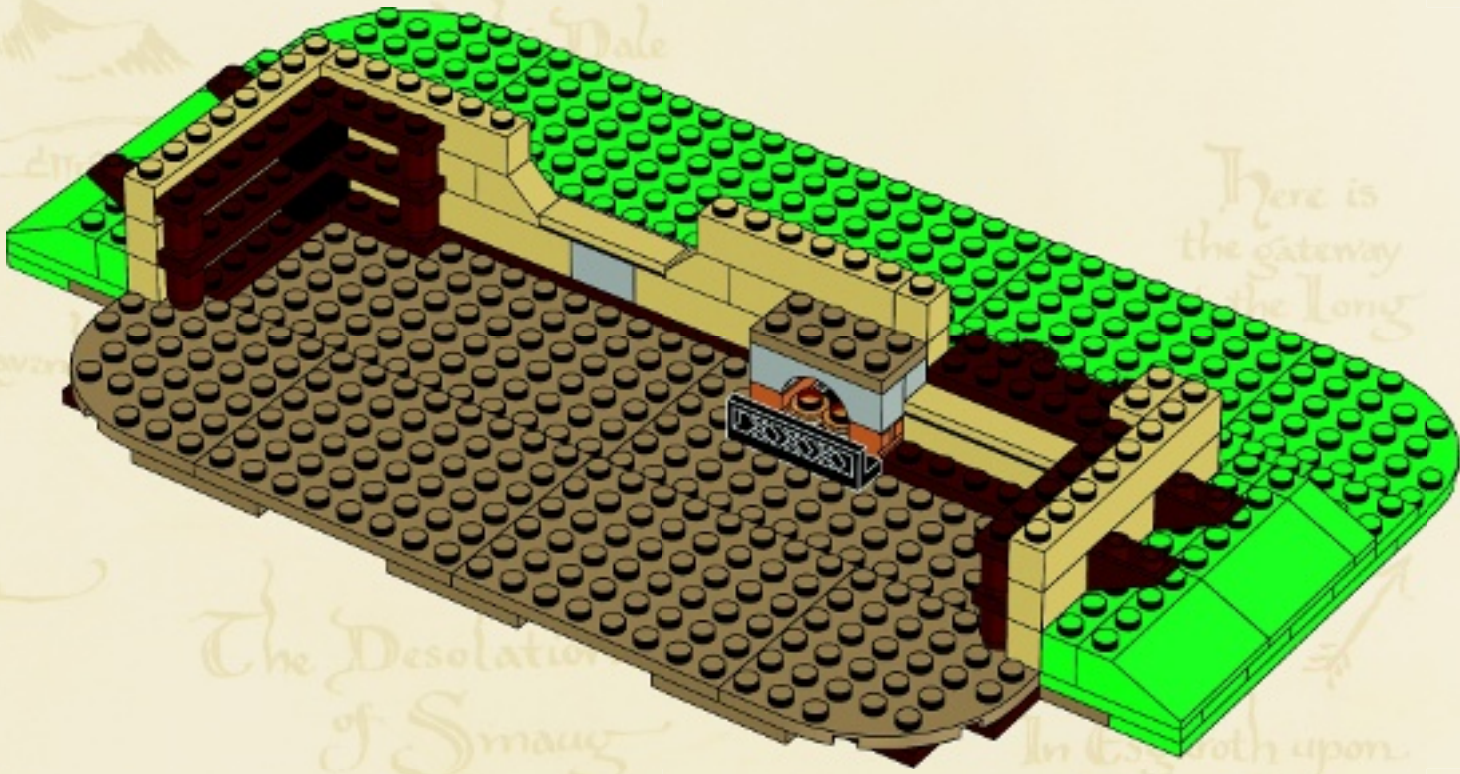

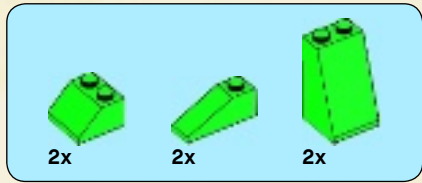

35

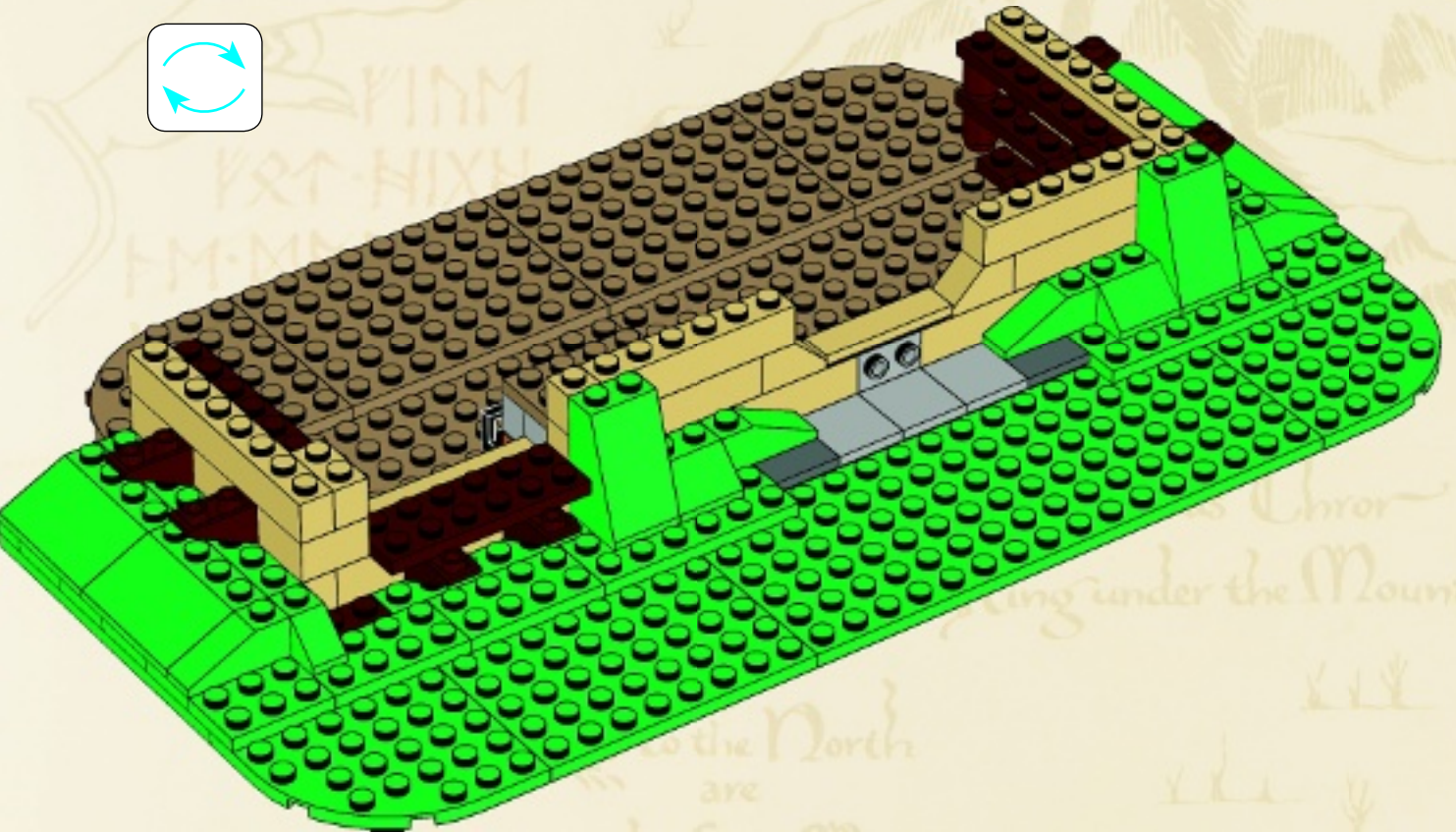

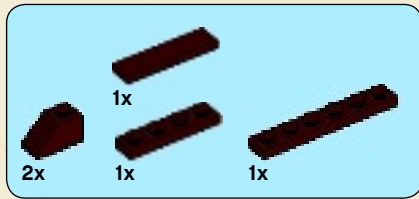

36

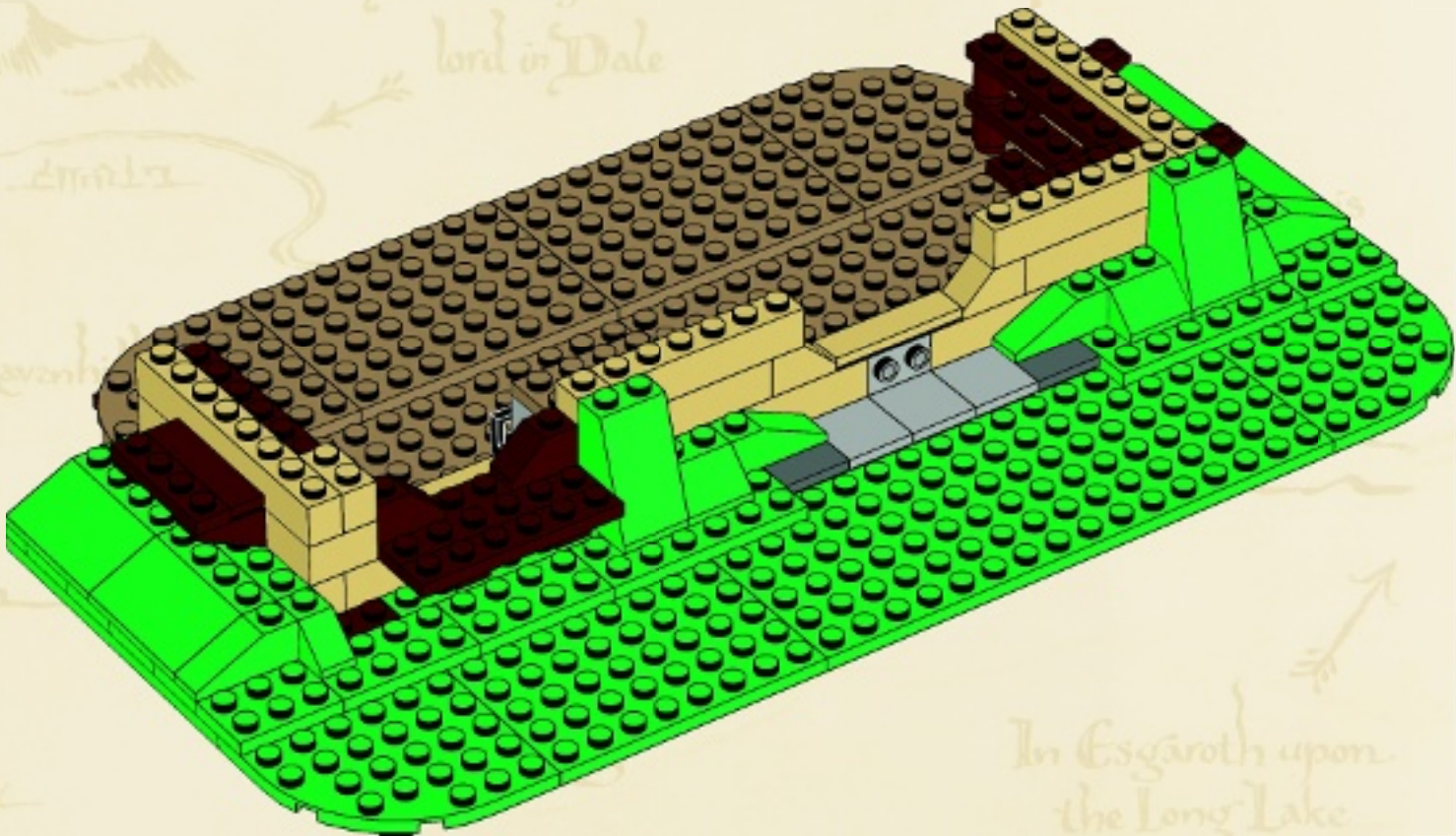



2x



2x

37

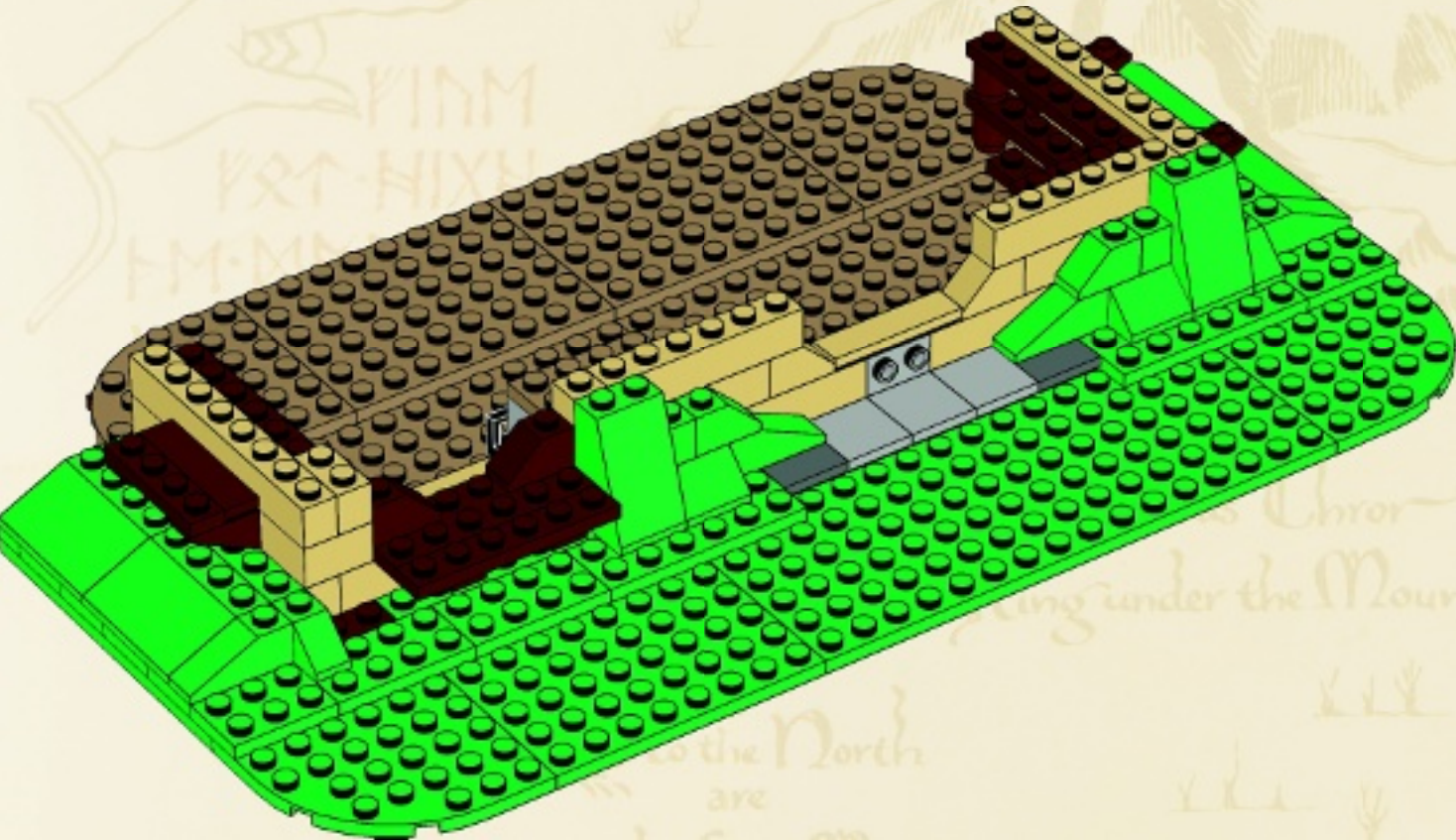

The
 Lonely
 Mountain

to the North
 are
 the Grey Mountains
 &
 the Withered Heath
 whence came the

Chror
 ing under the Mount

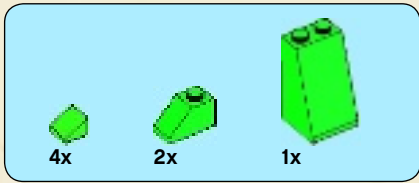

38

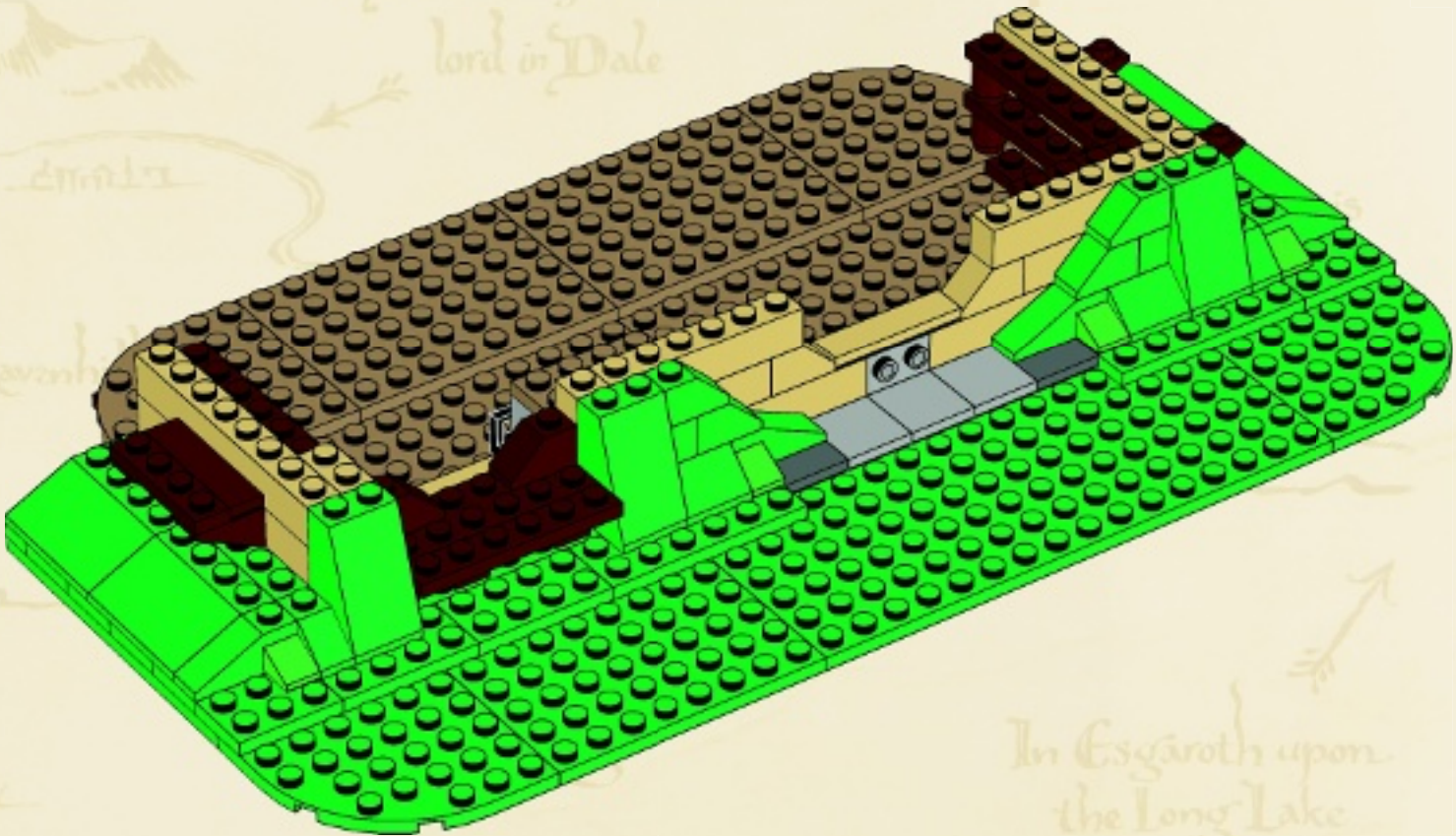

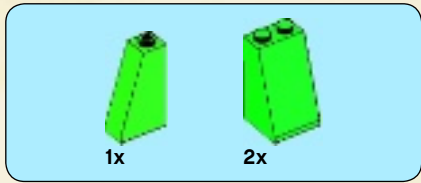

39

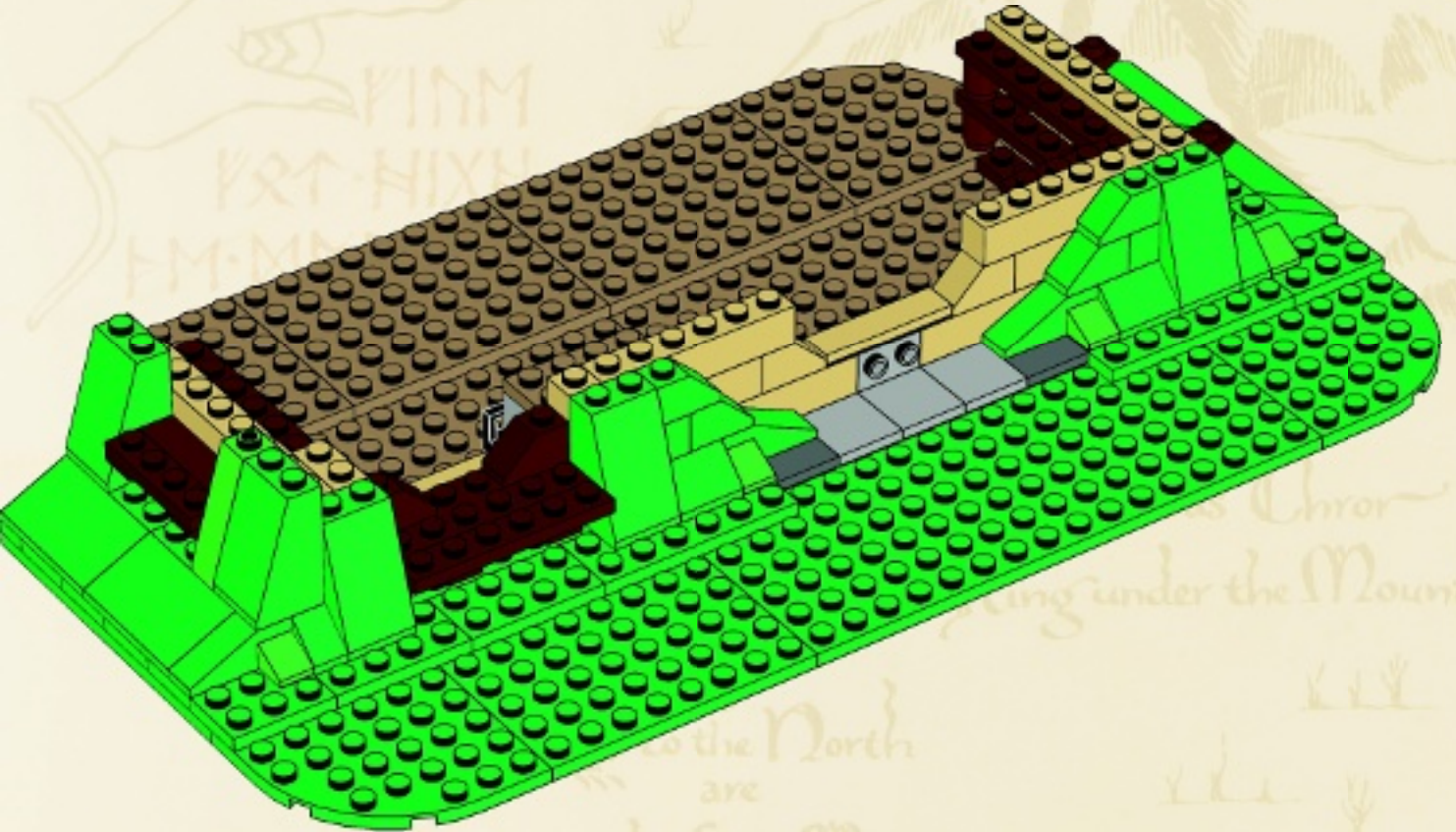

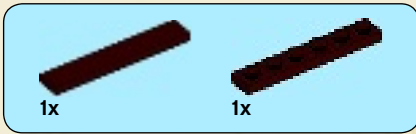

40

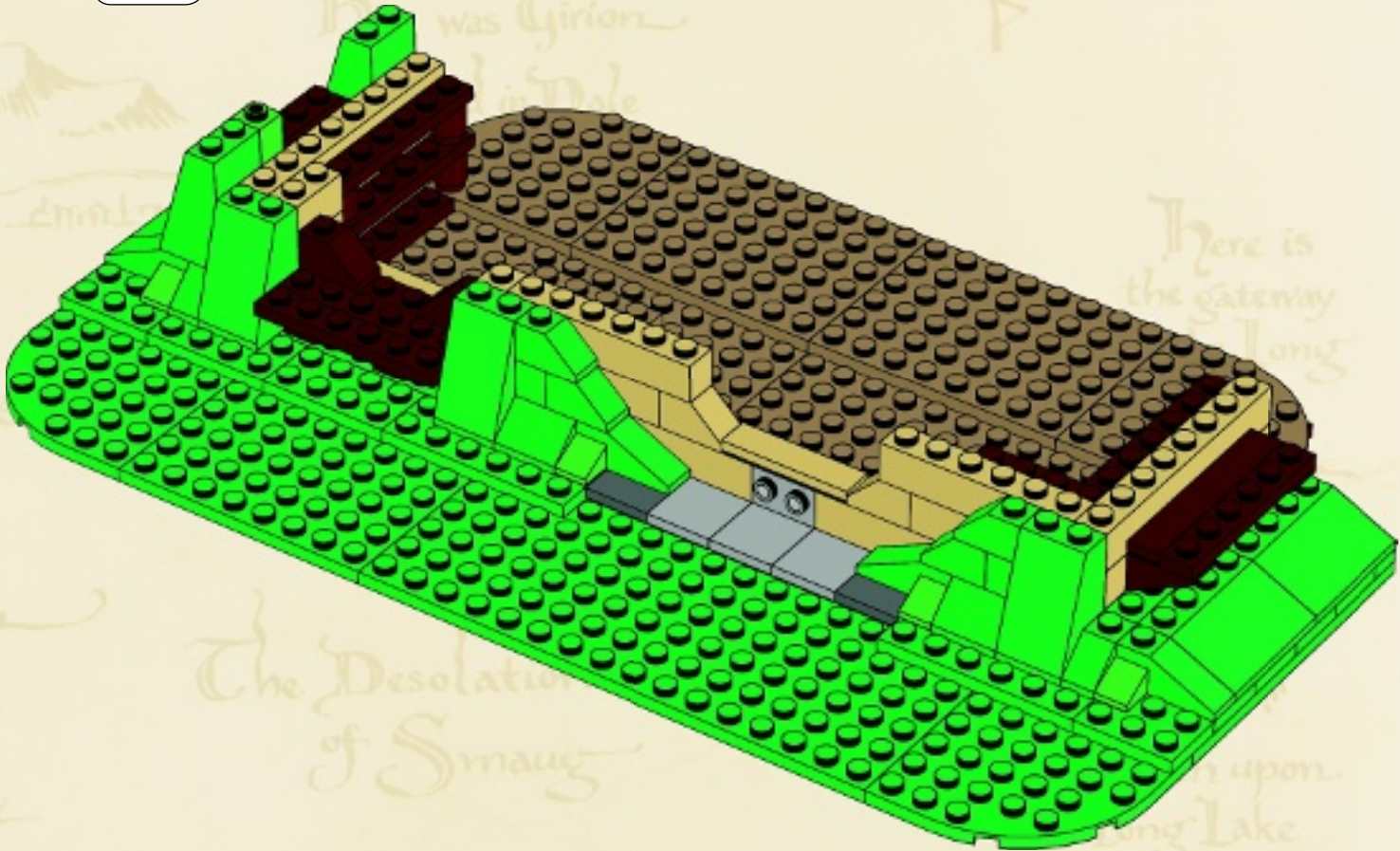

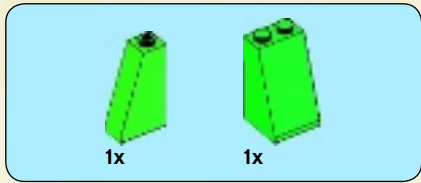

41

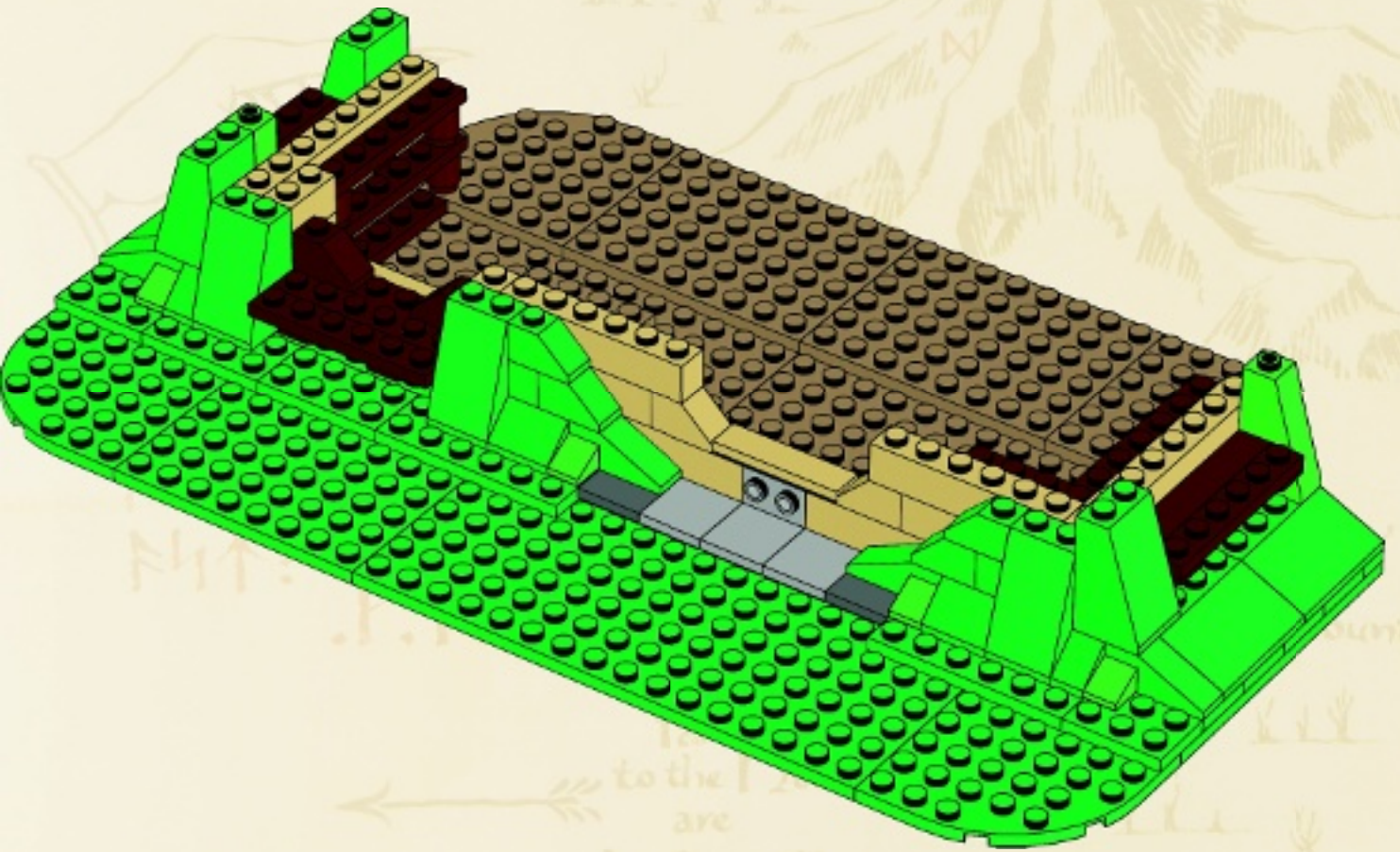

to the
are
the Grey Mountains
&
the Withered Heath
whence came the

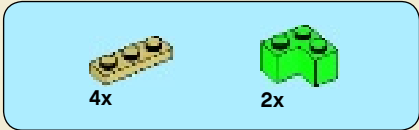
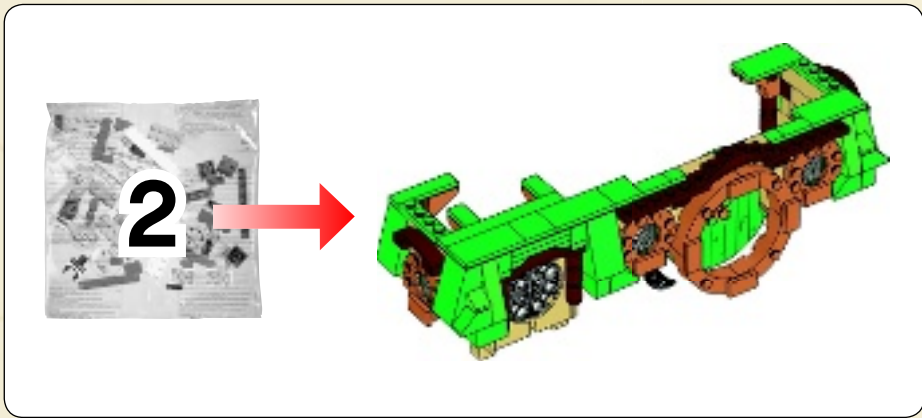

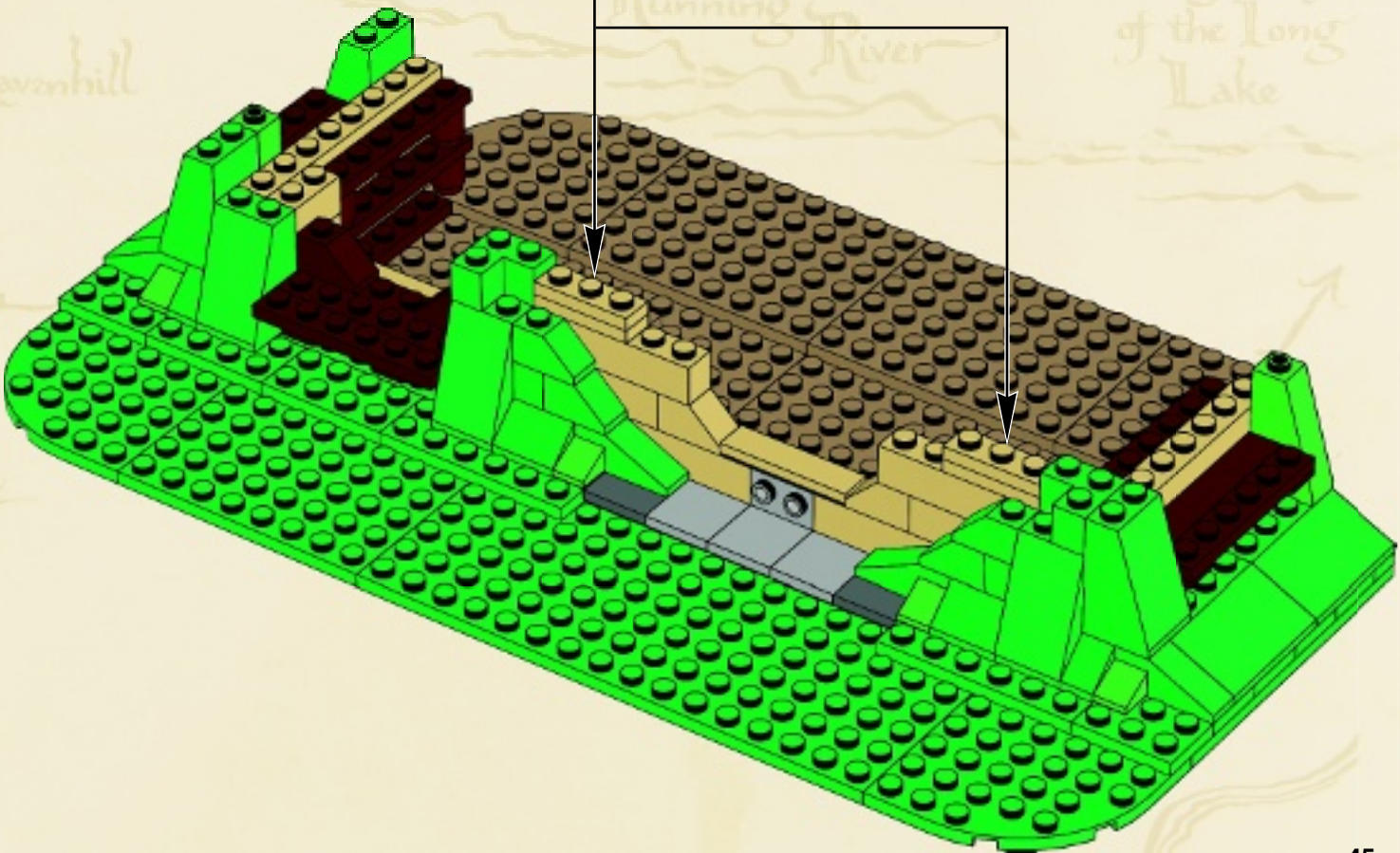
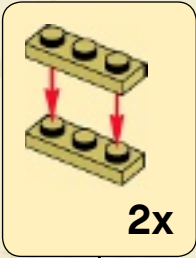

42



1x  1x  2x 

43

1   

2  

3  

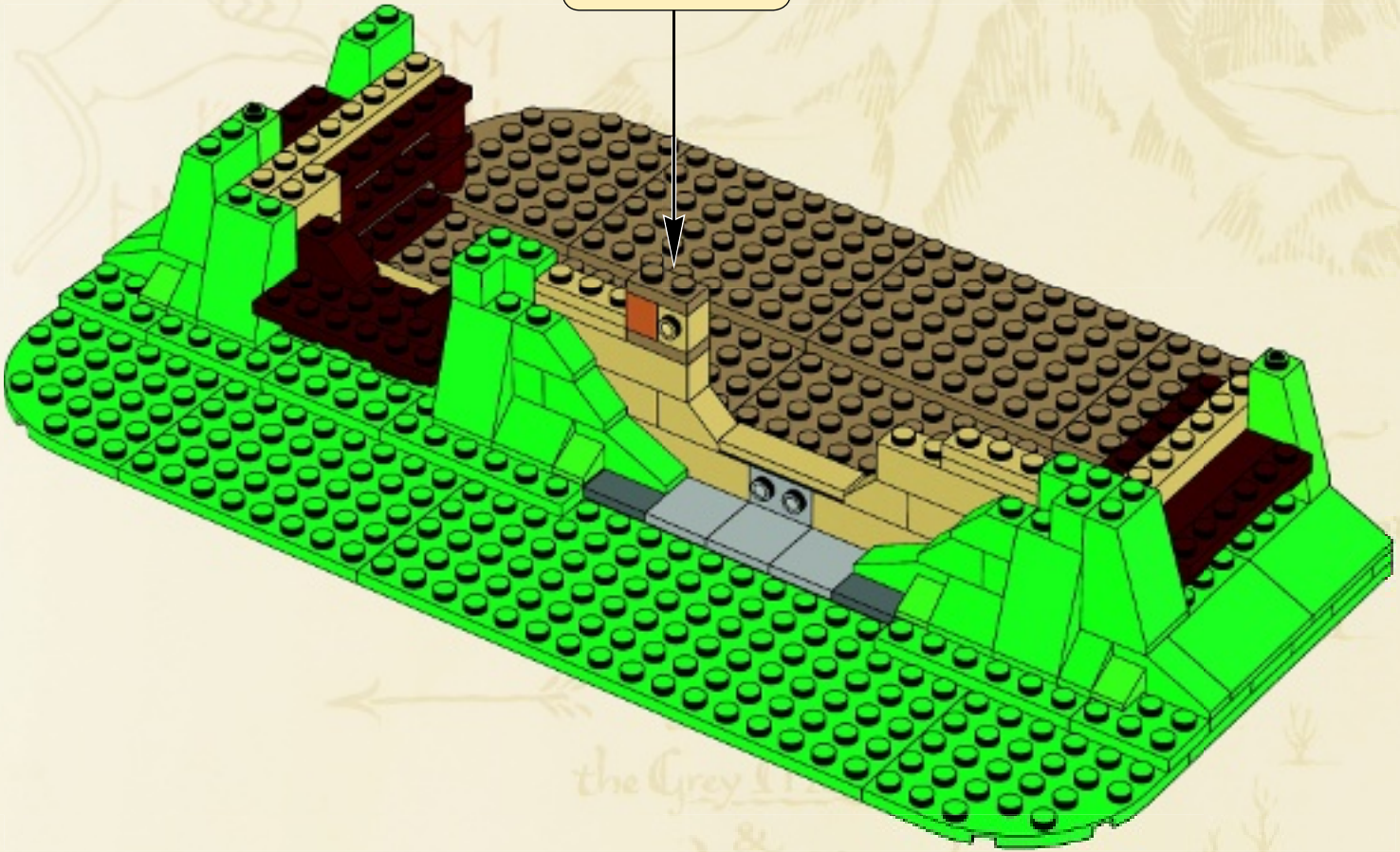

1x 1x 2x

44

- 1
- 2
- 3

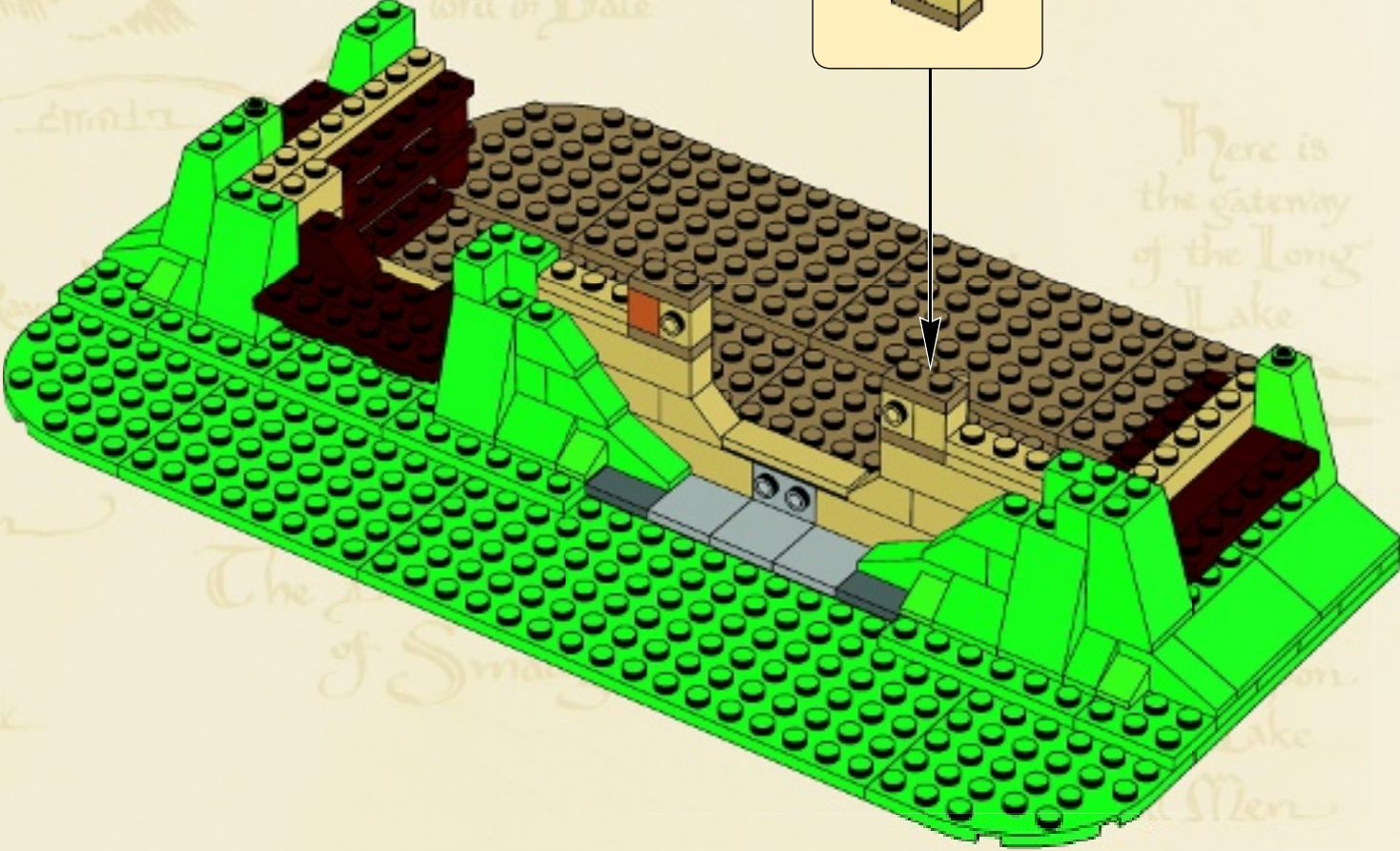

		
2x	2x	1x

45

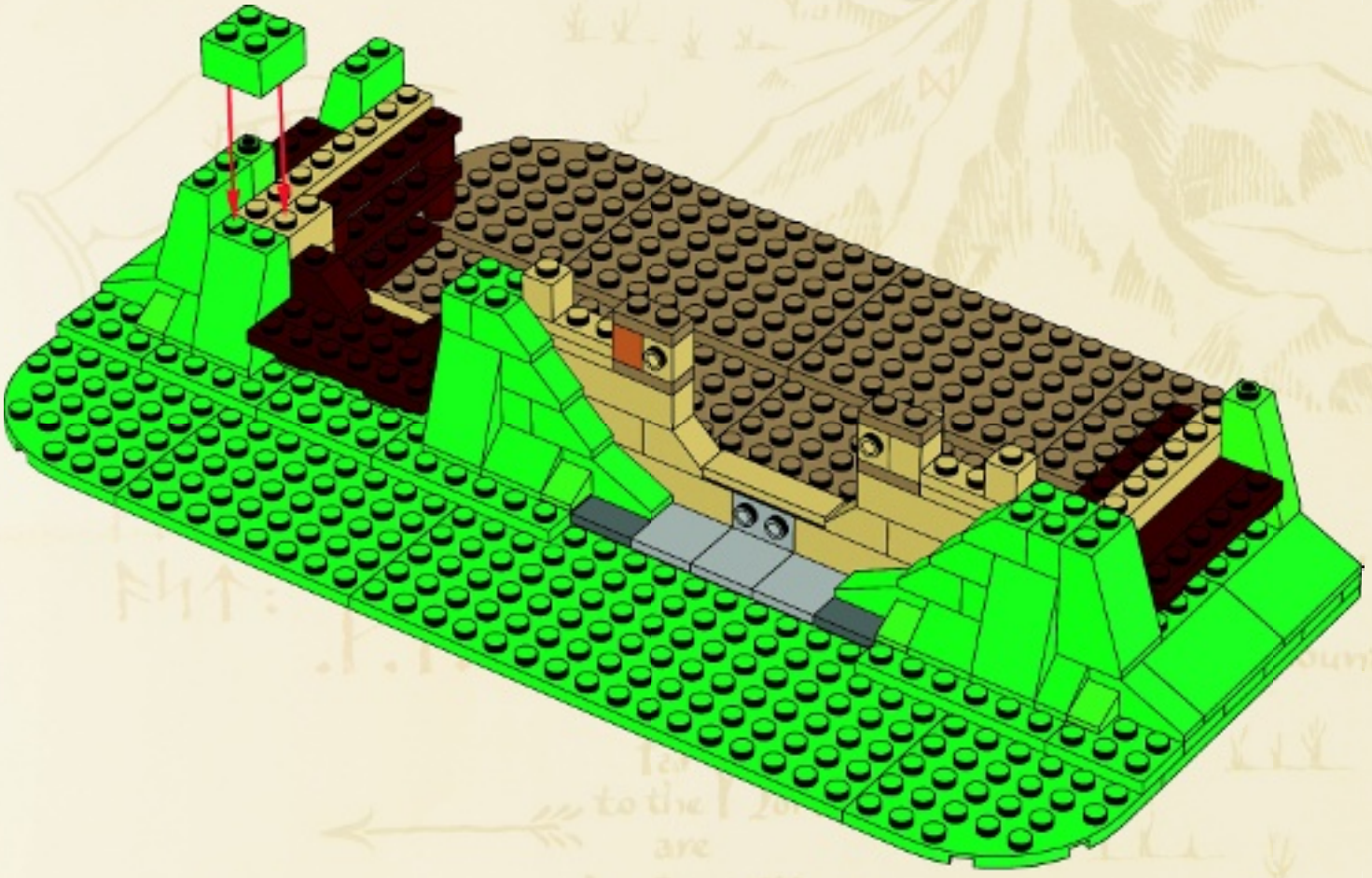



2x



2x

46

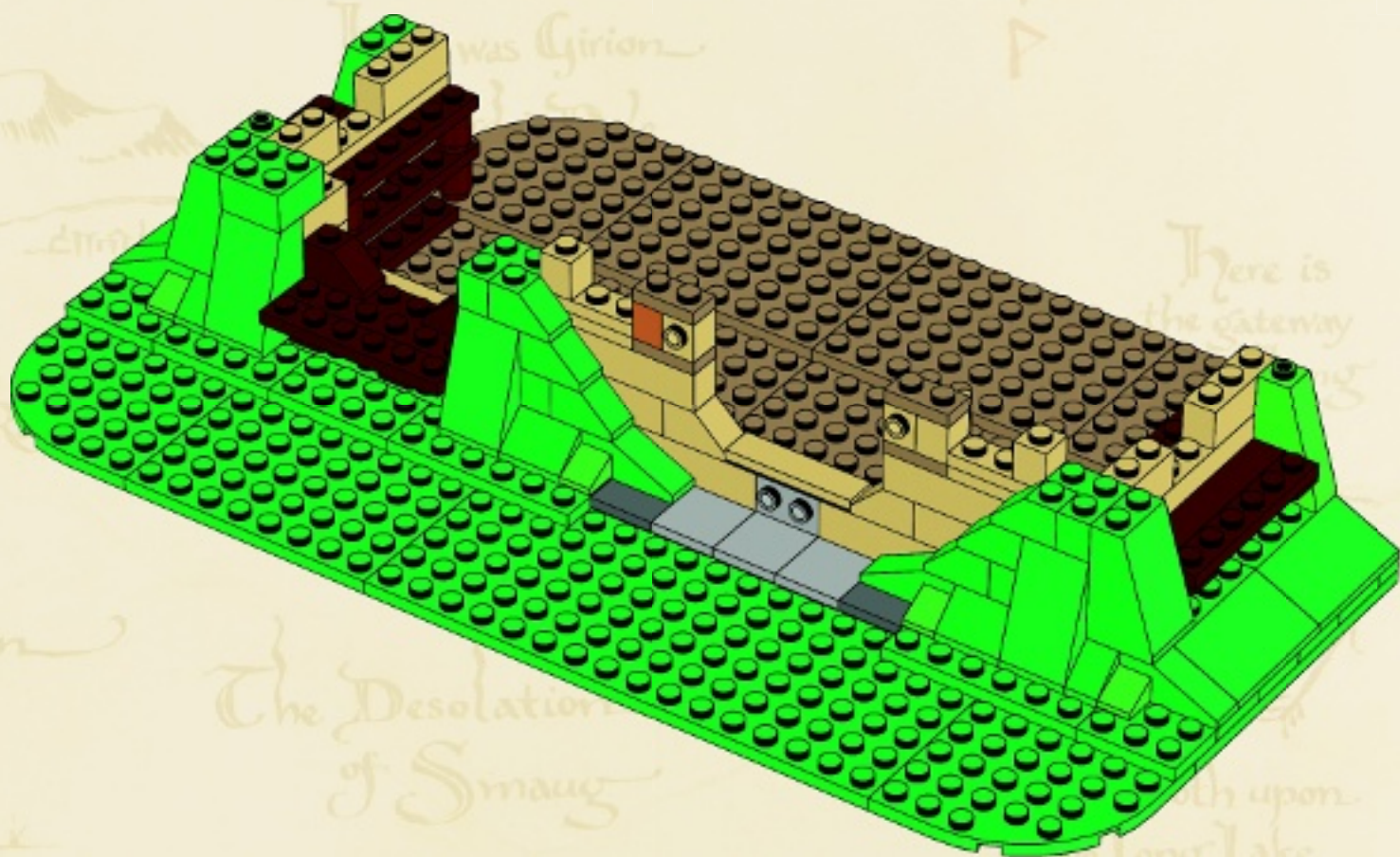

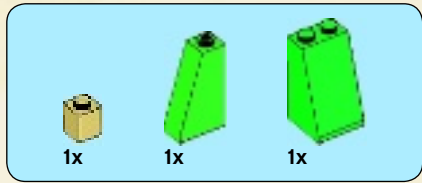

47

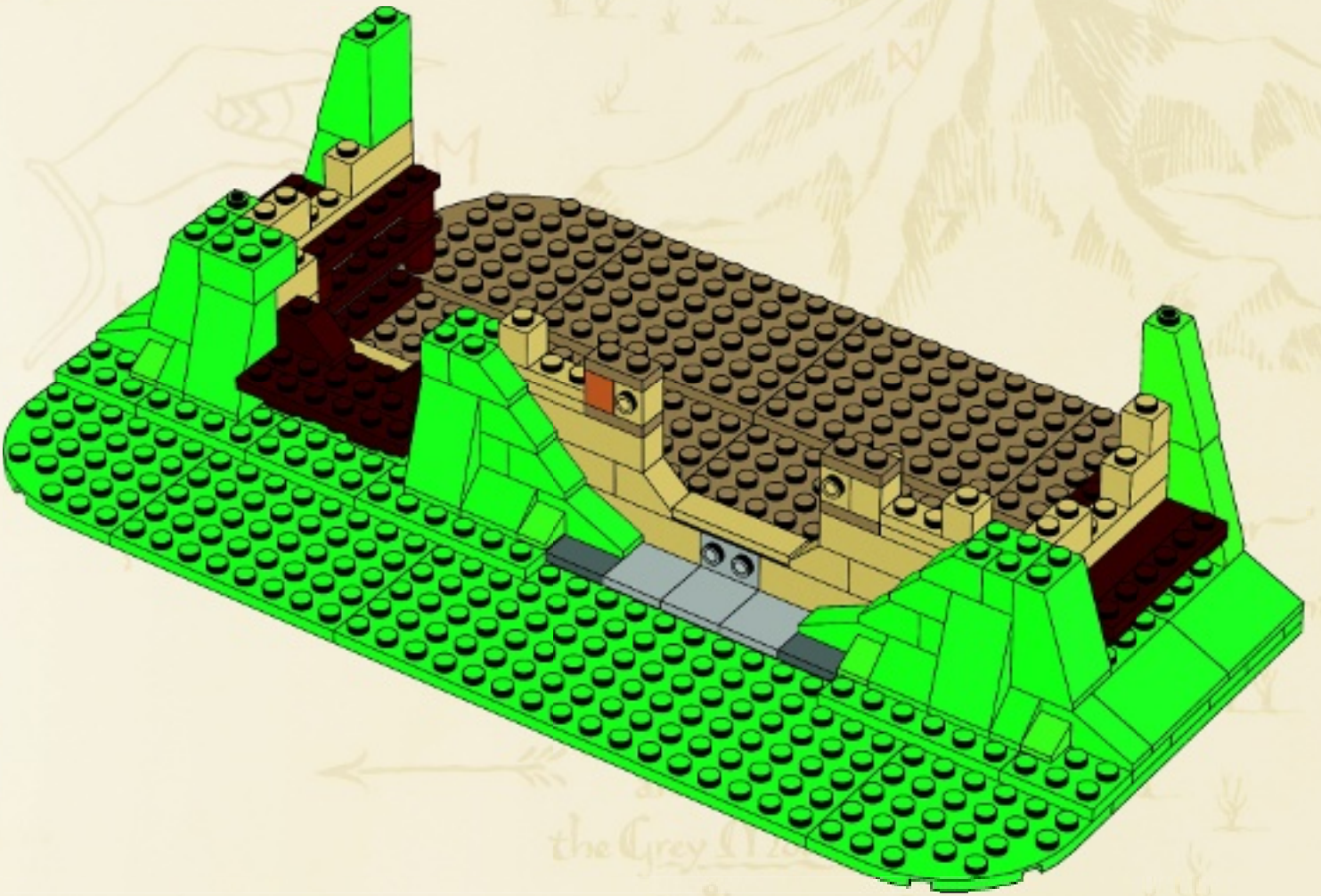



48

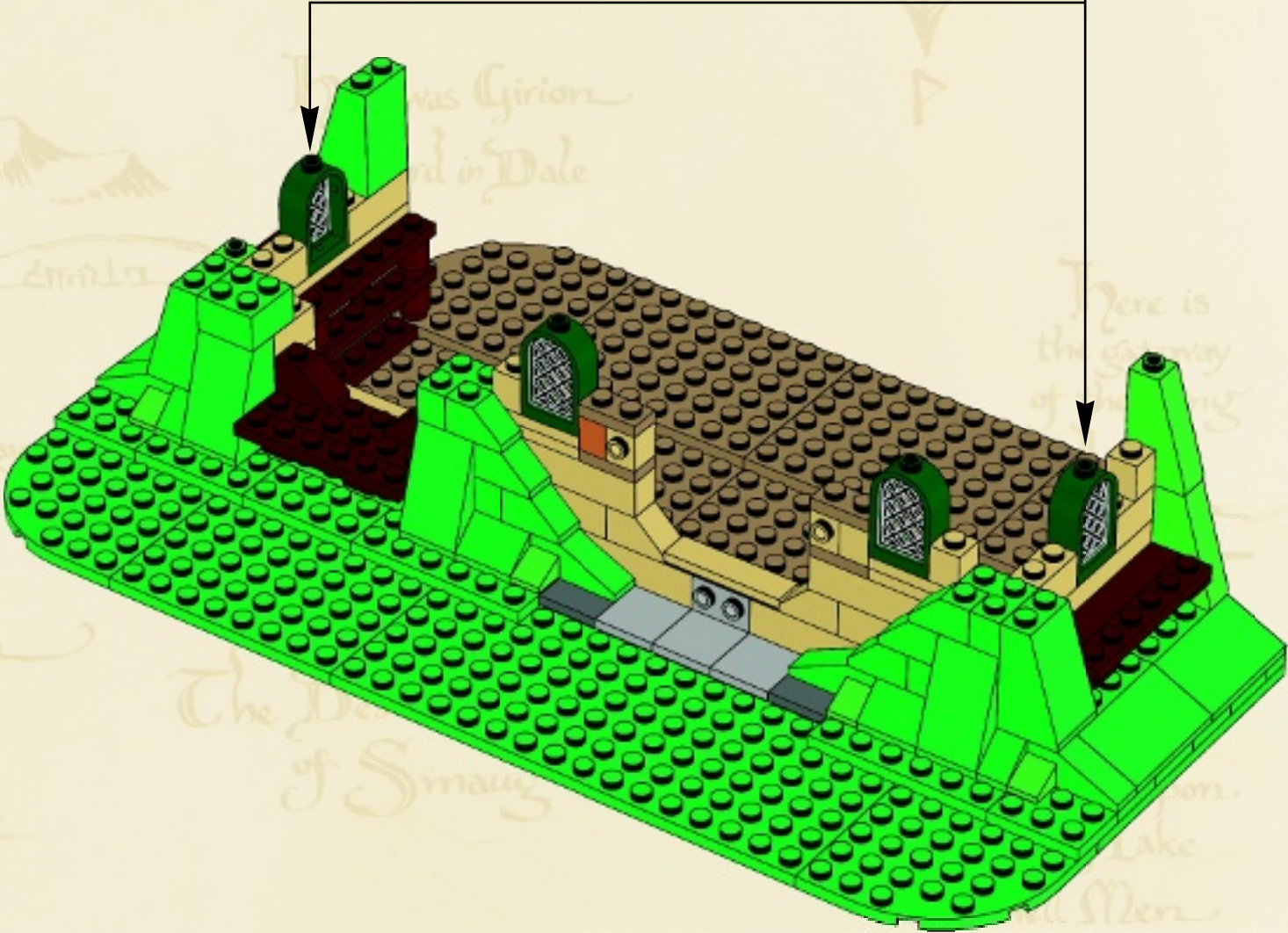



49

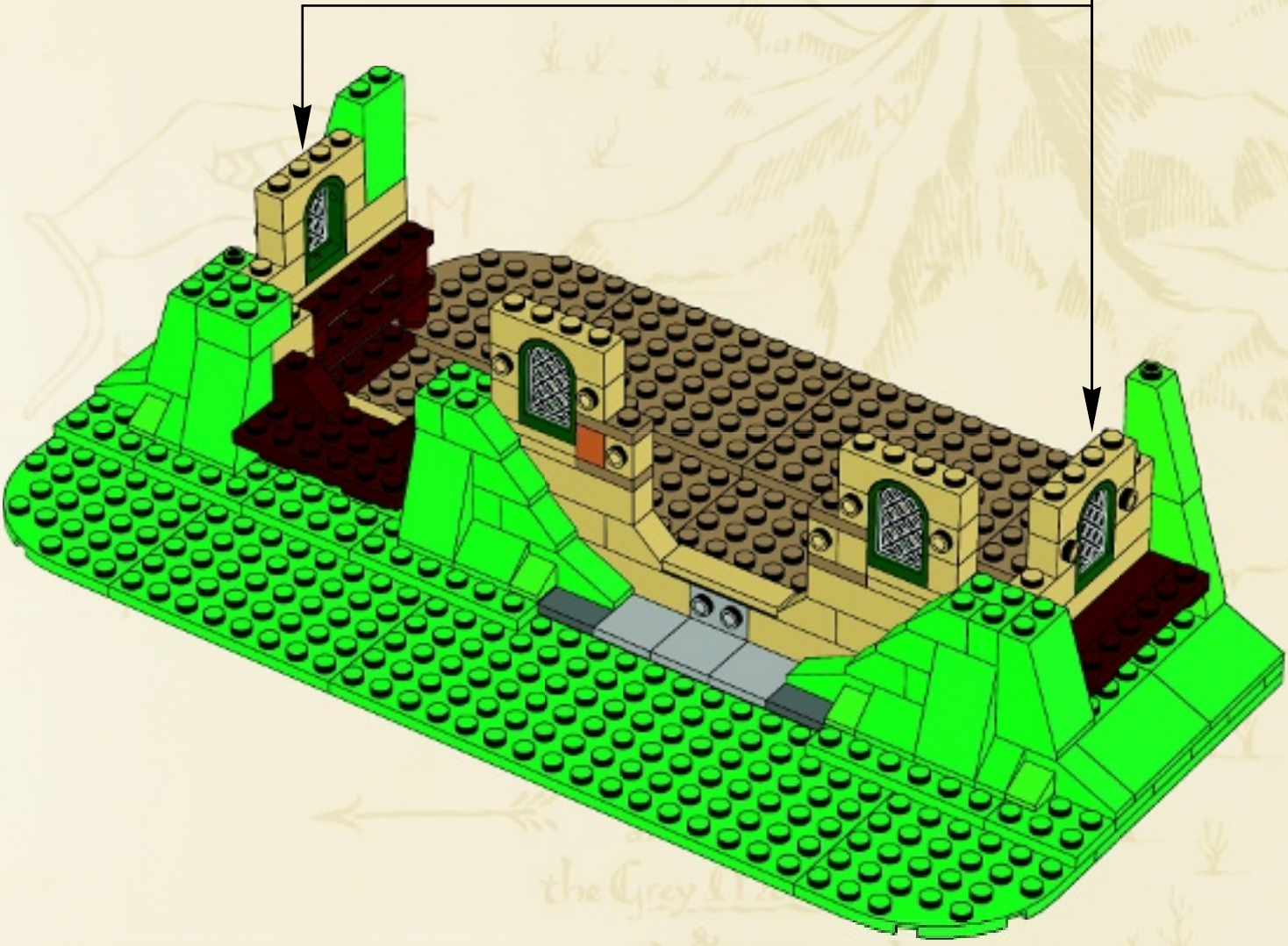
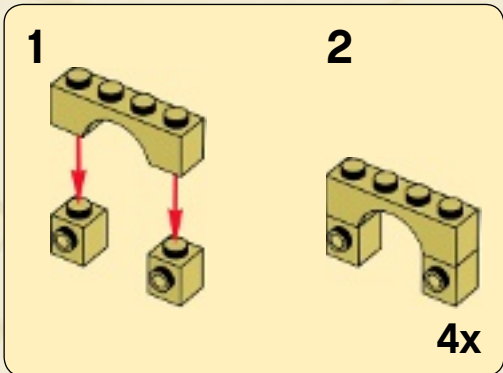



1x



2x

50

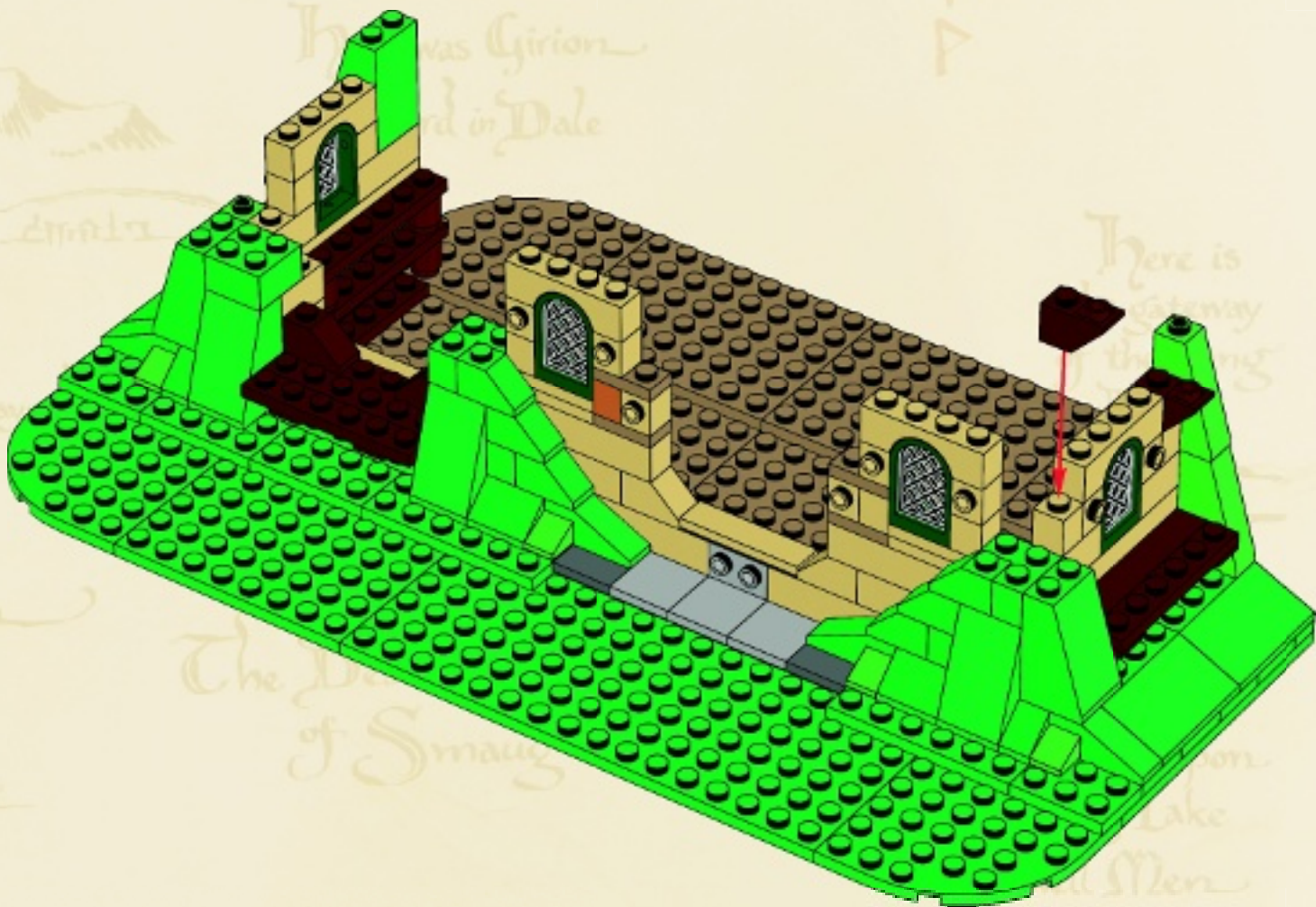

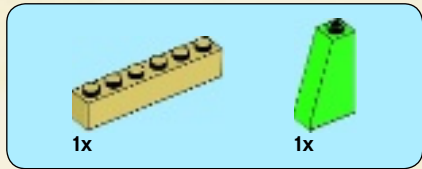

51

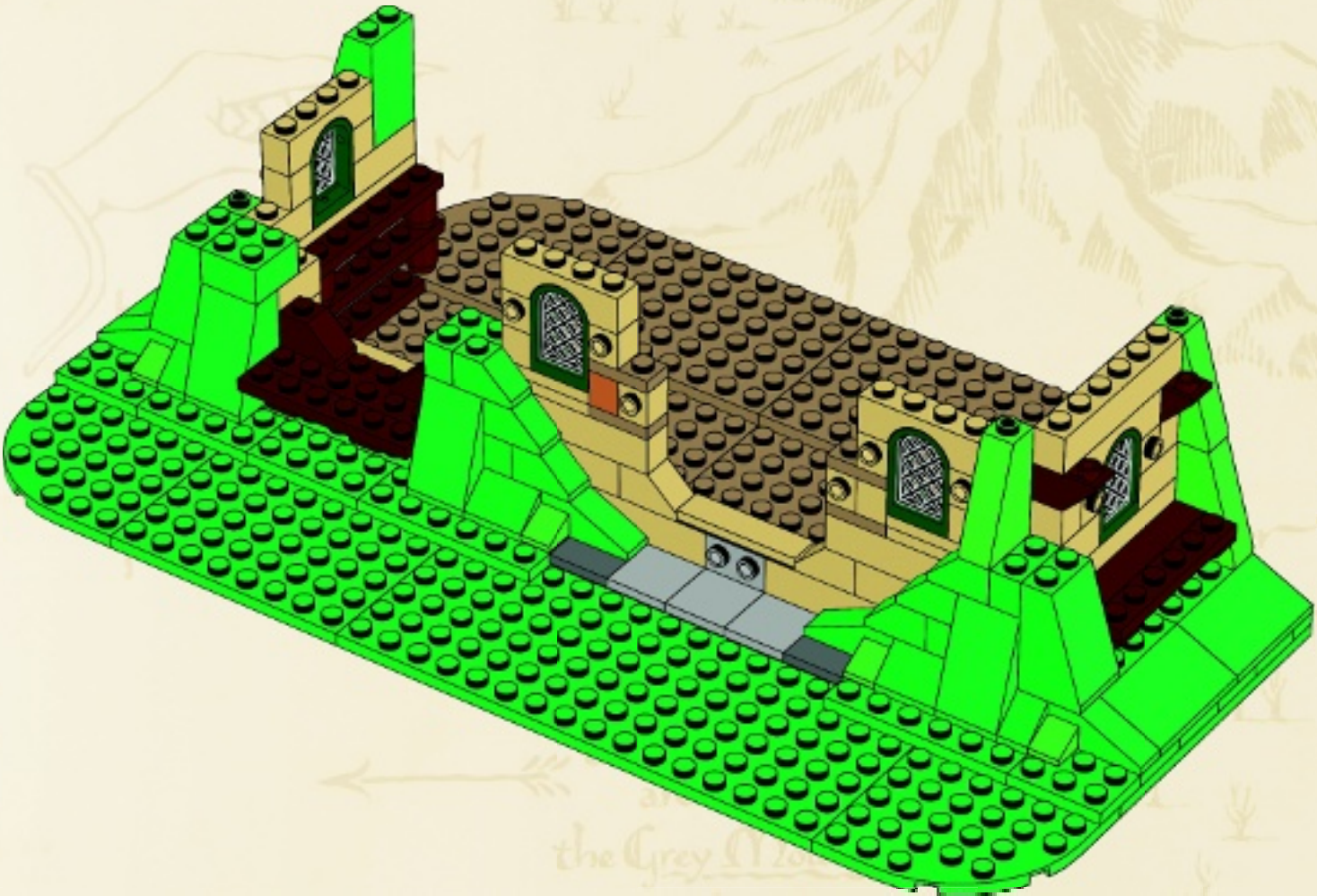

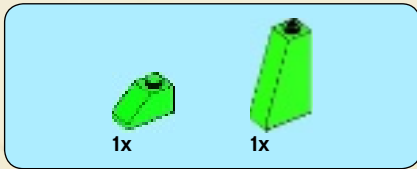

52

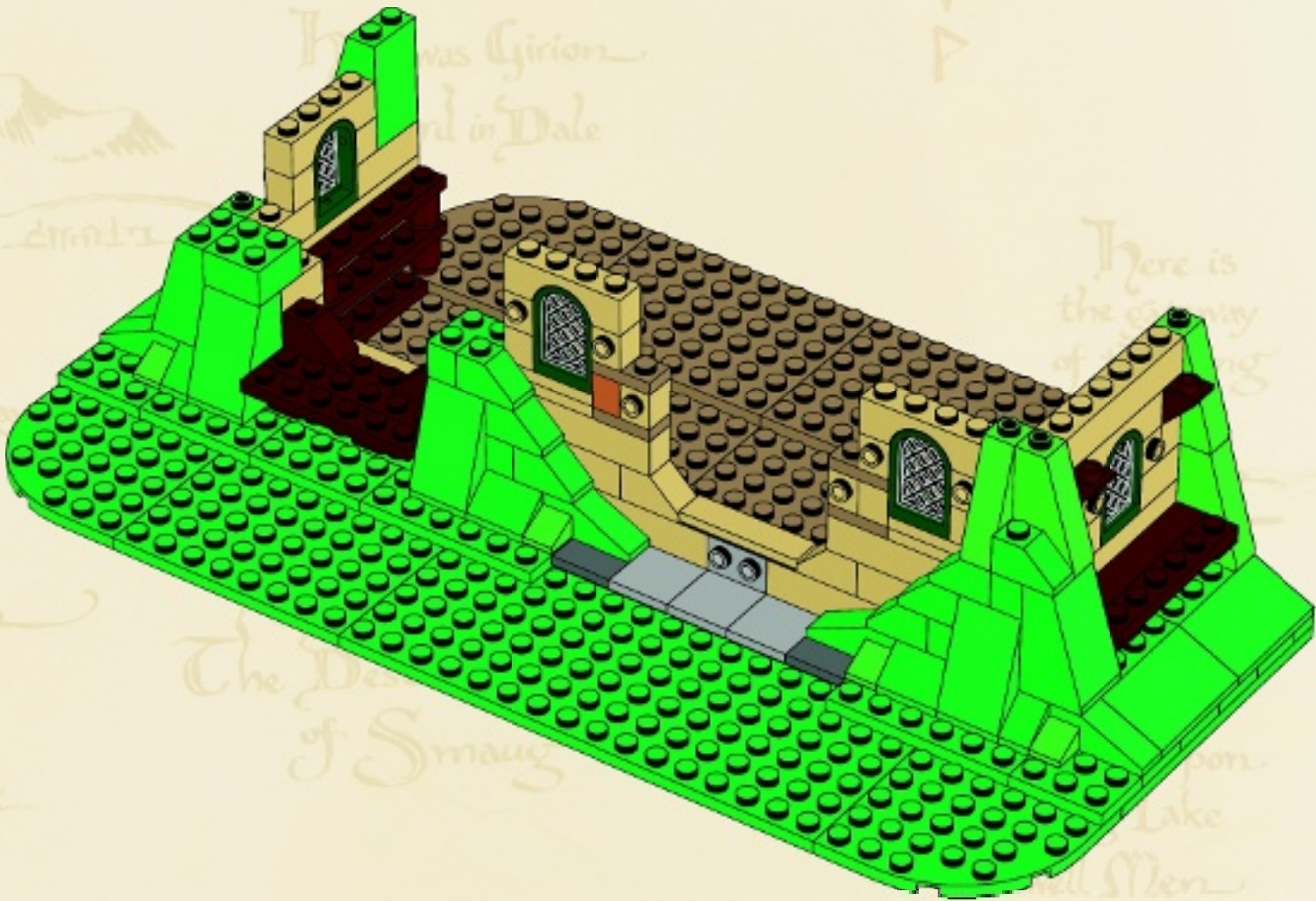

1x  2x 

53

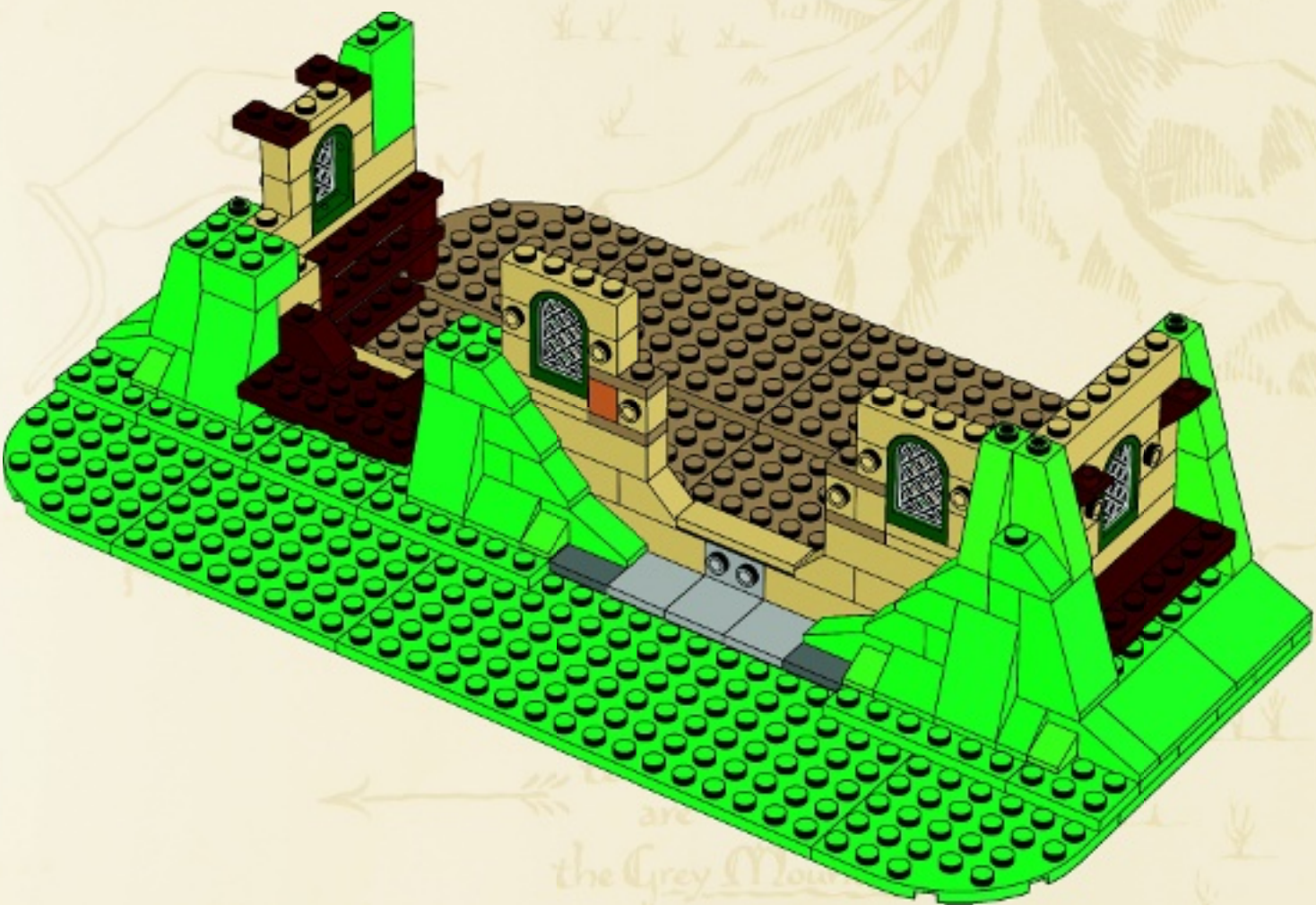

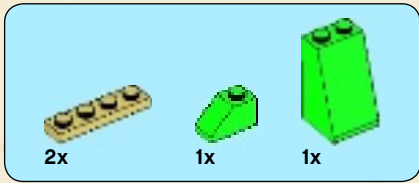

54

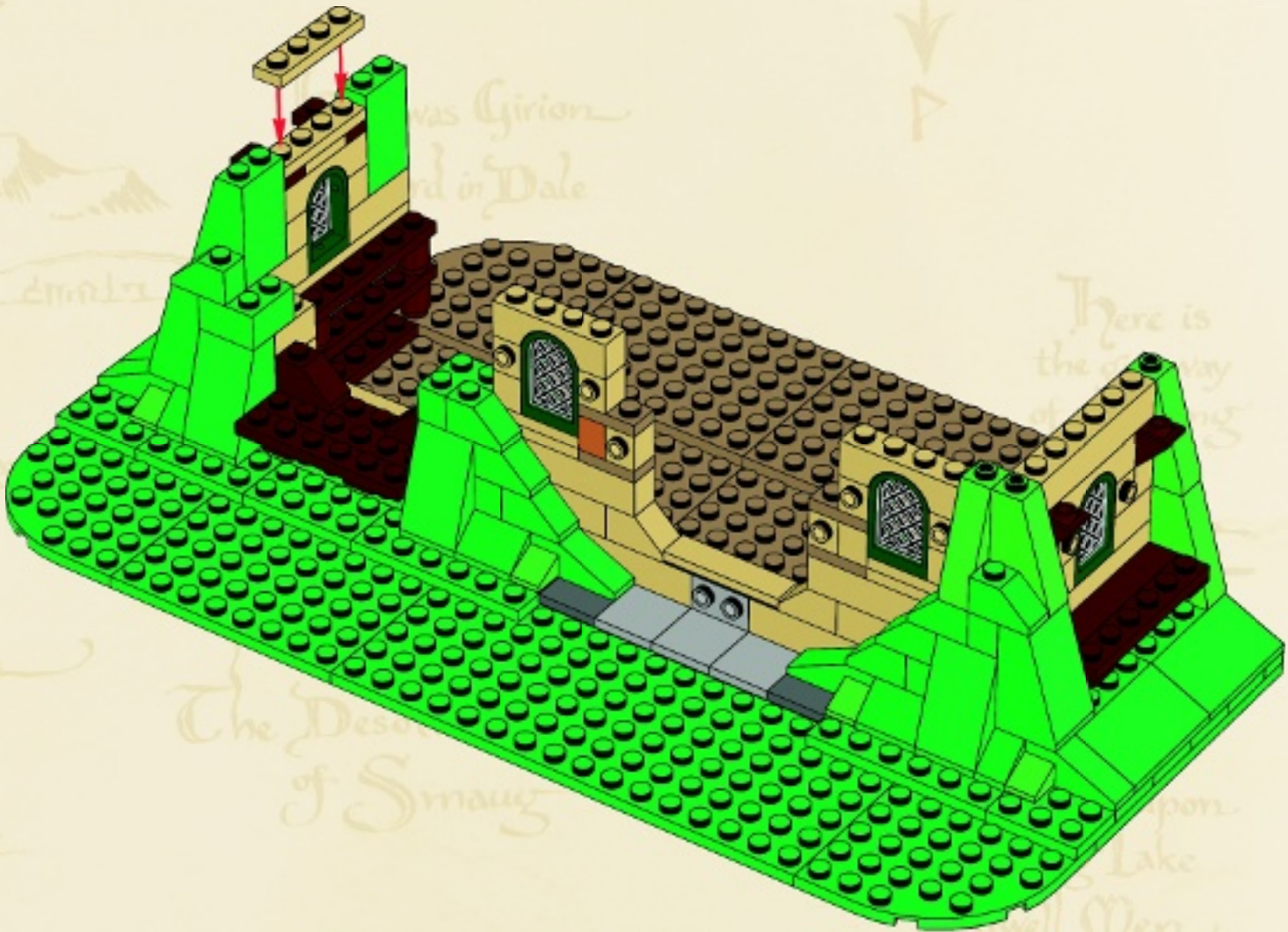

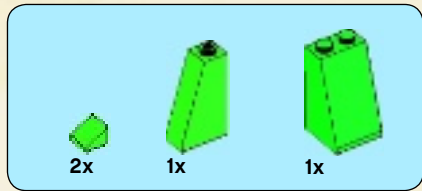

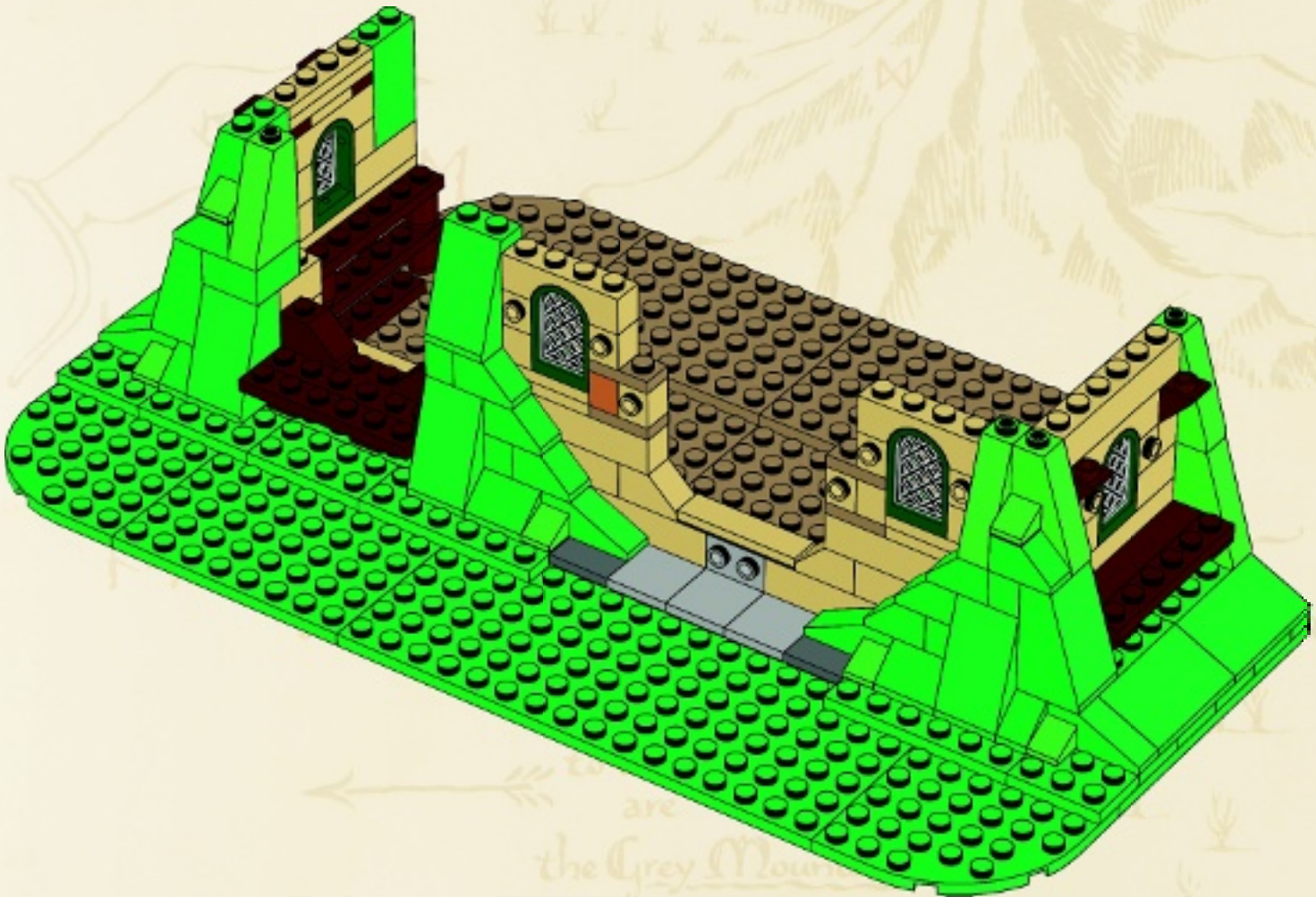

55

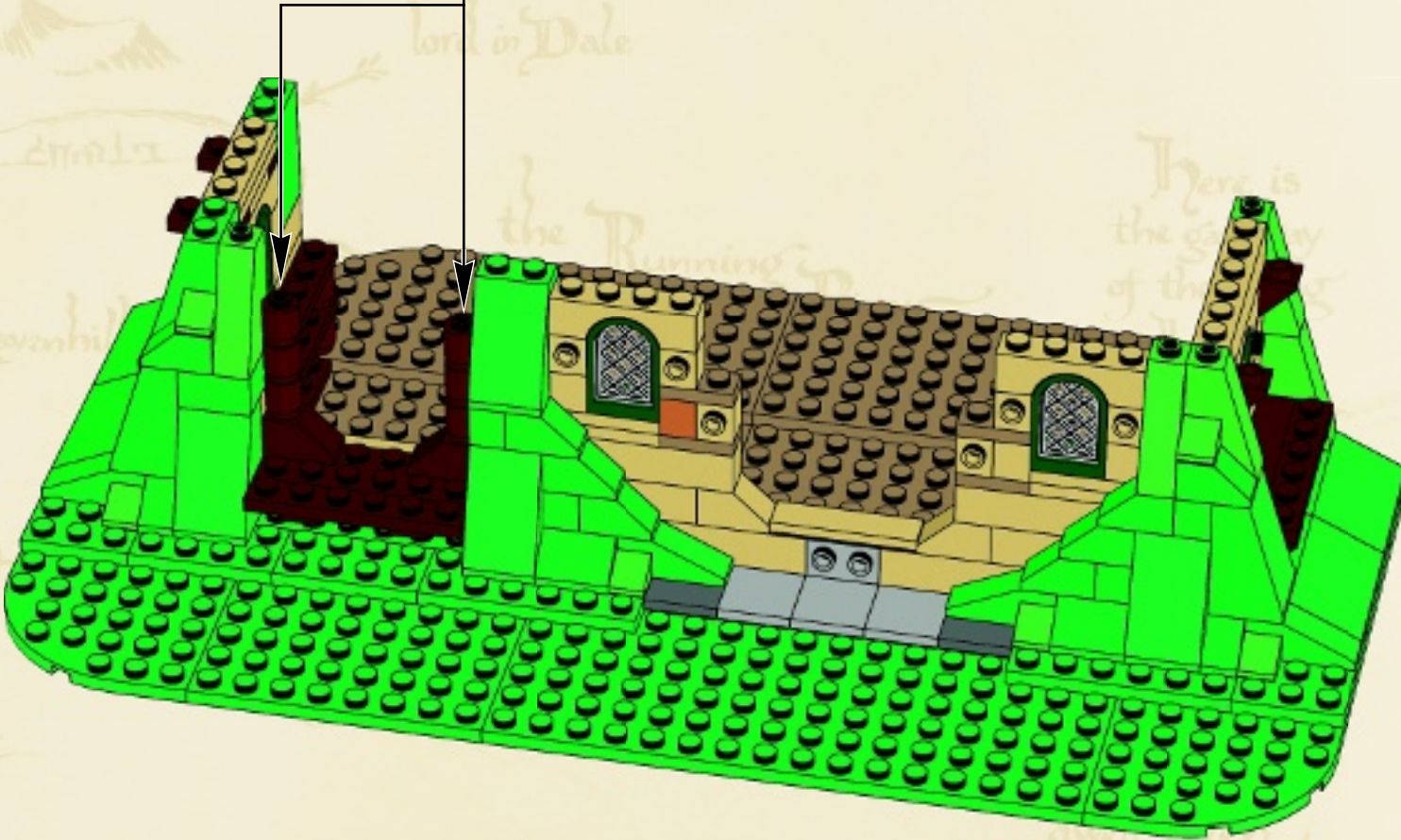
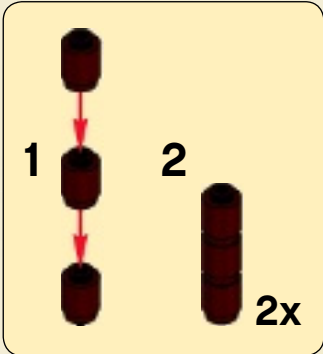

6x

56



2x  1x 

57

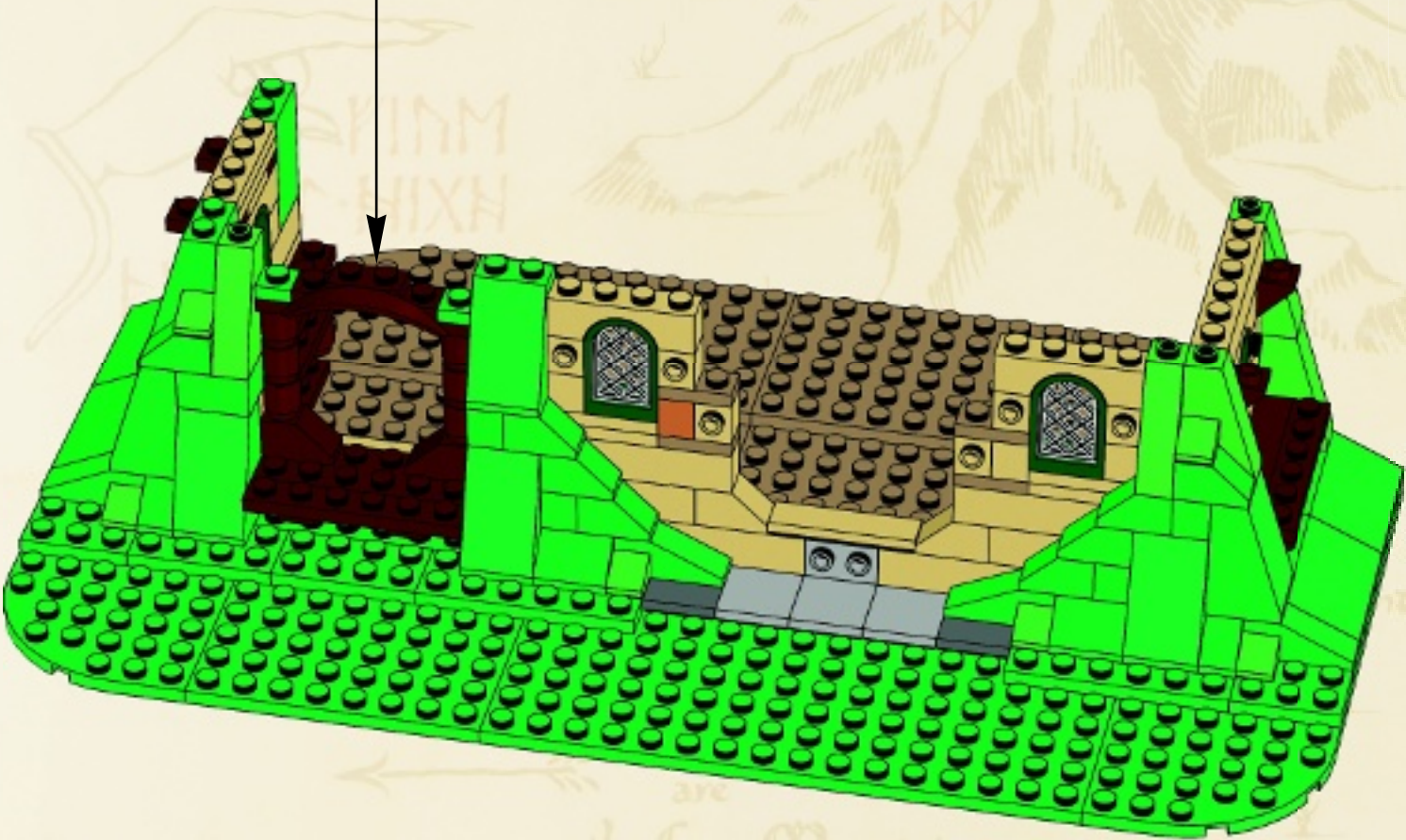

1 

2 







The
Lovely
Mountain

are
the Grey Mountains
&
the Withered Heath
whence came the

 2x
  2x
  4x

58

- 1 
- 2 
- 3 

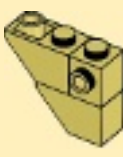
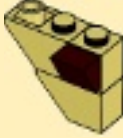
- 1 
- 2 
- 3 

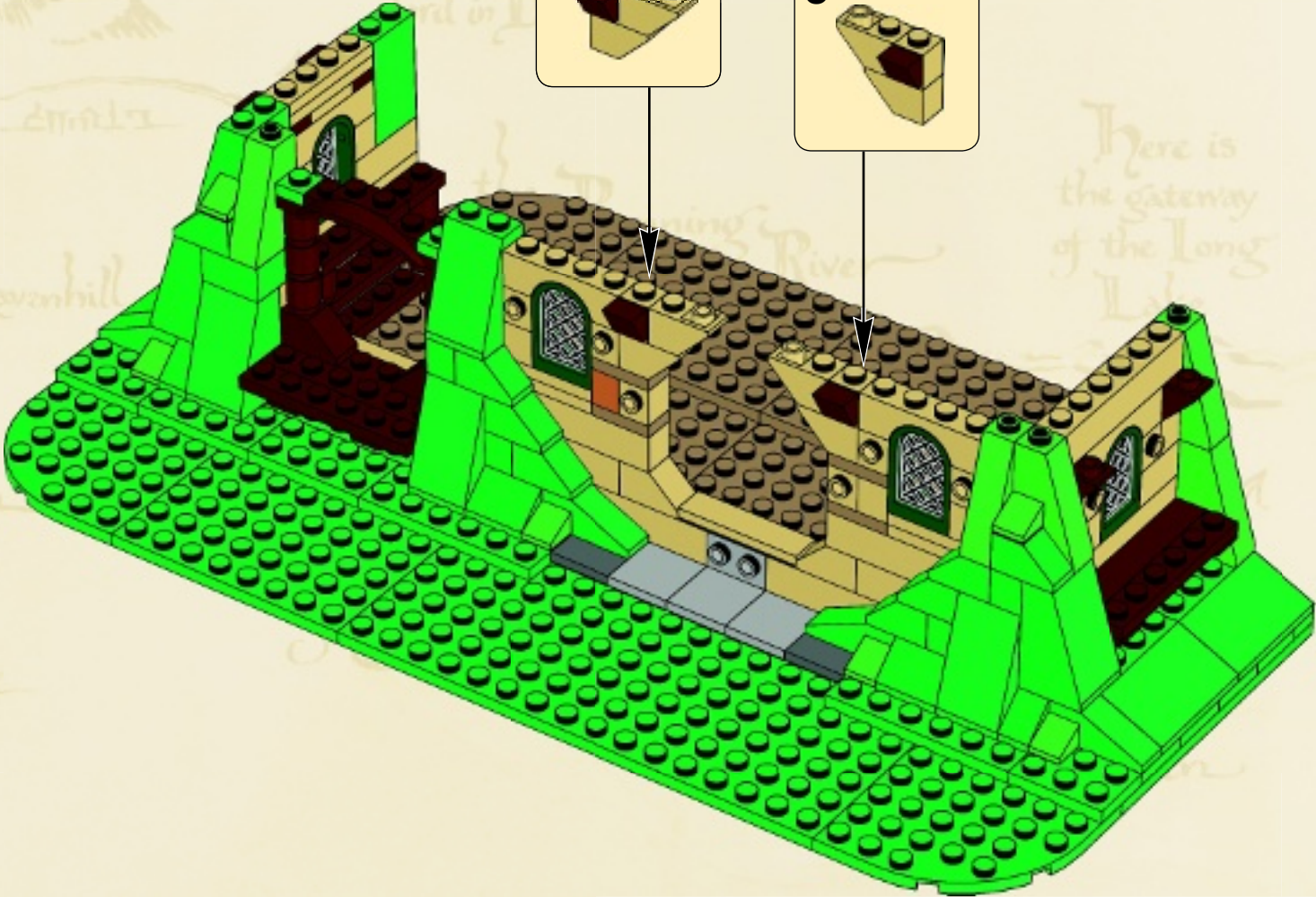

2x

59

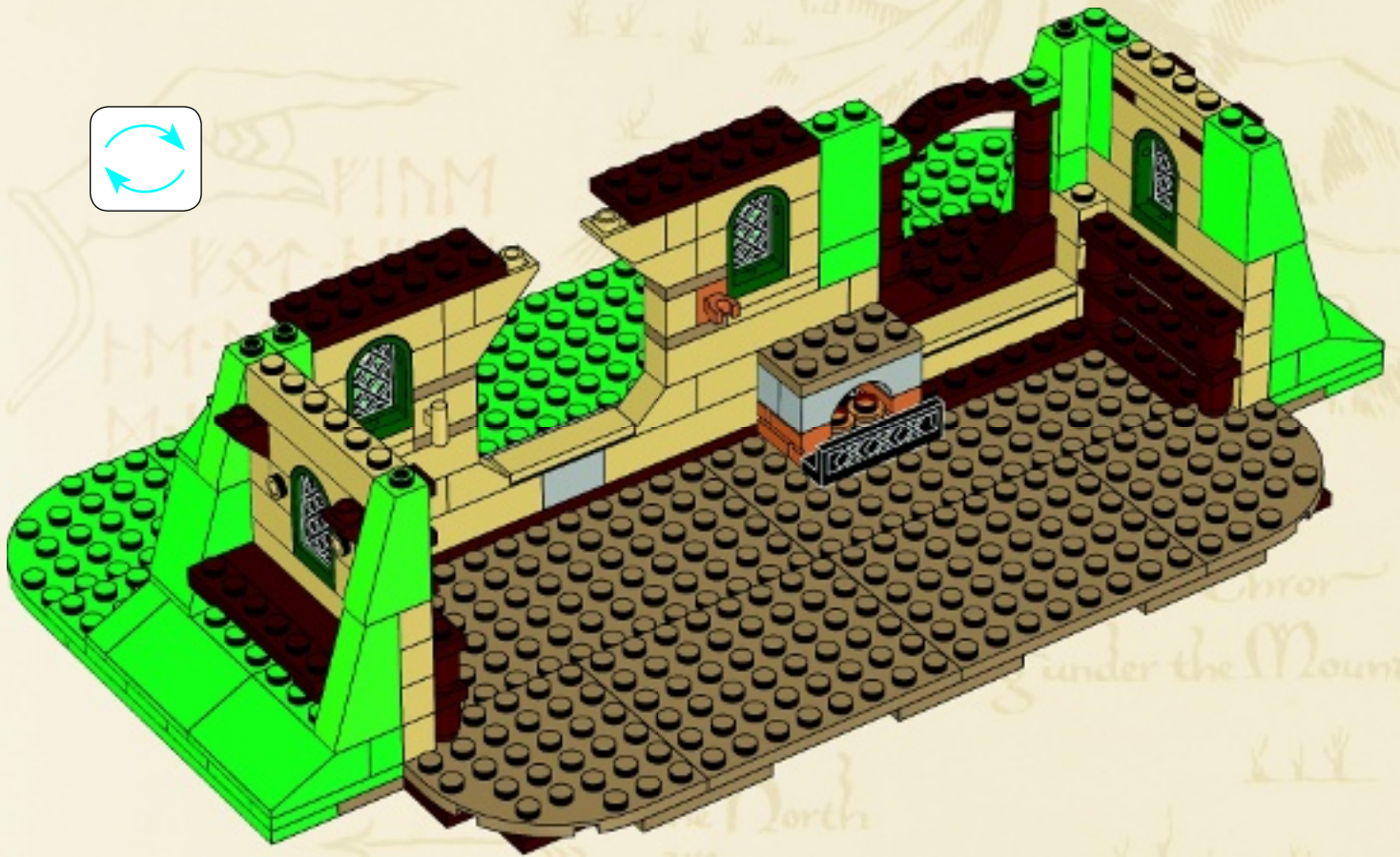



60

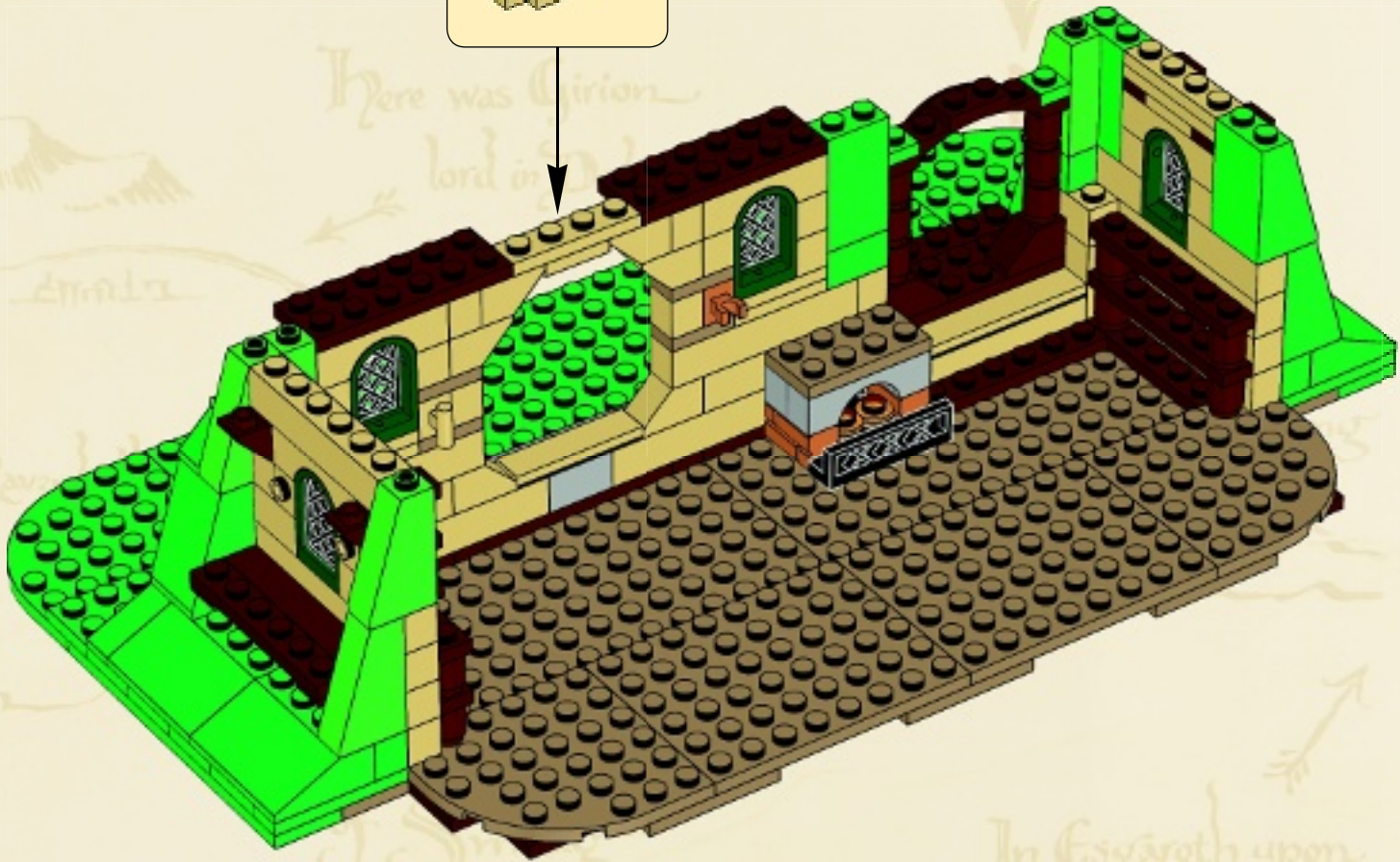
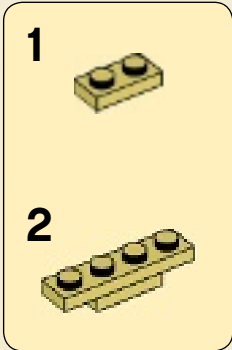

In Esgaroth upon
the Long Lake
dwell Men

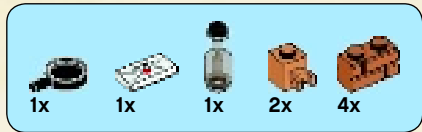

61

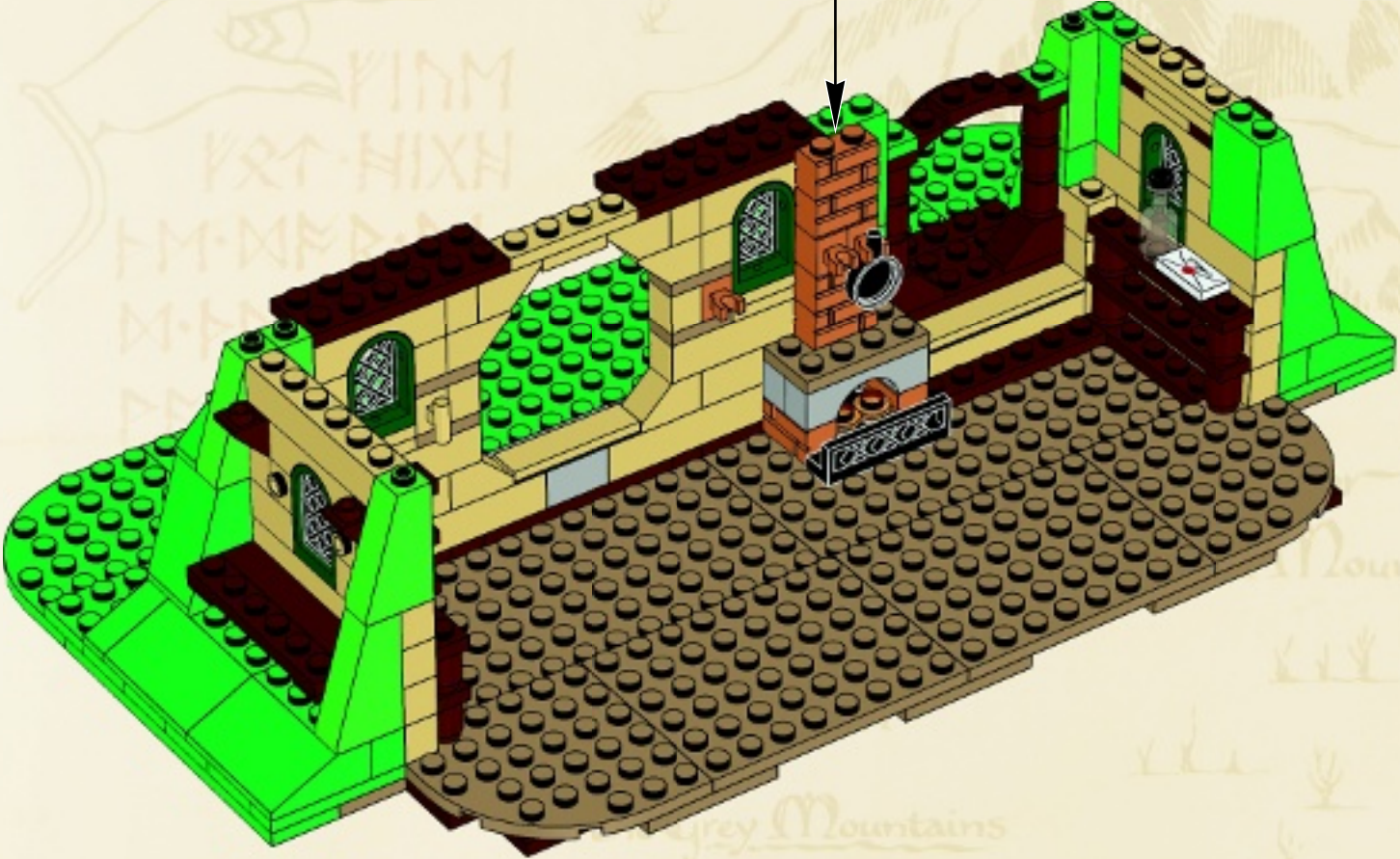
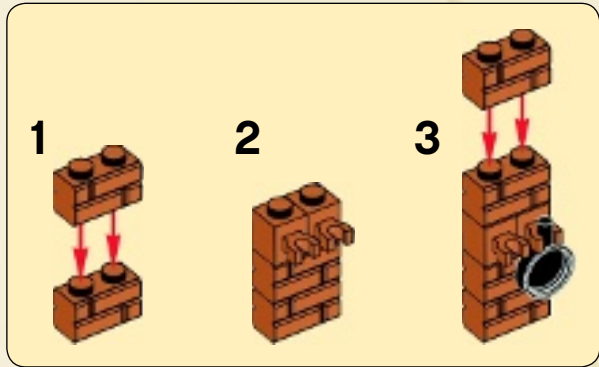

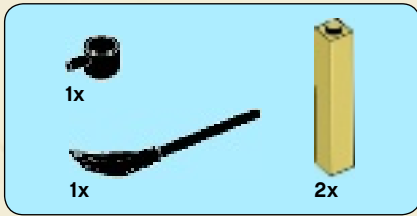

62

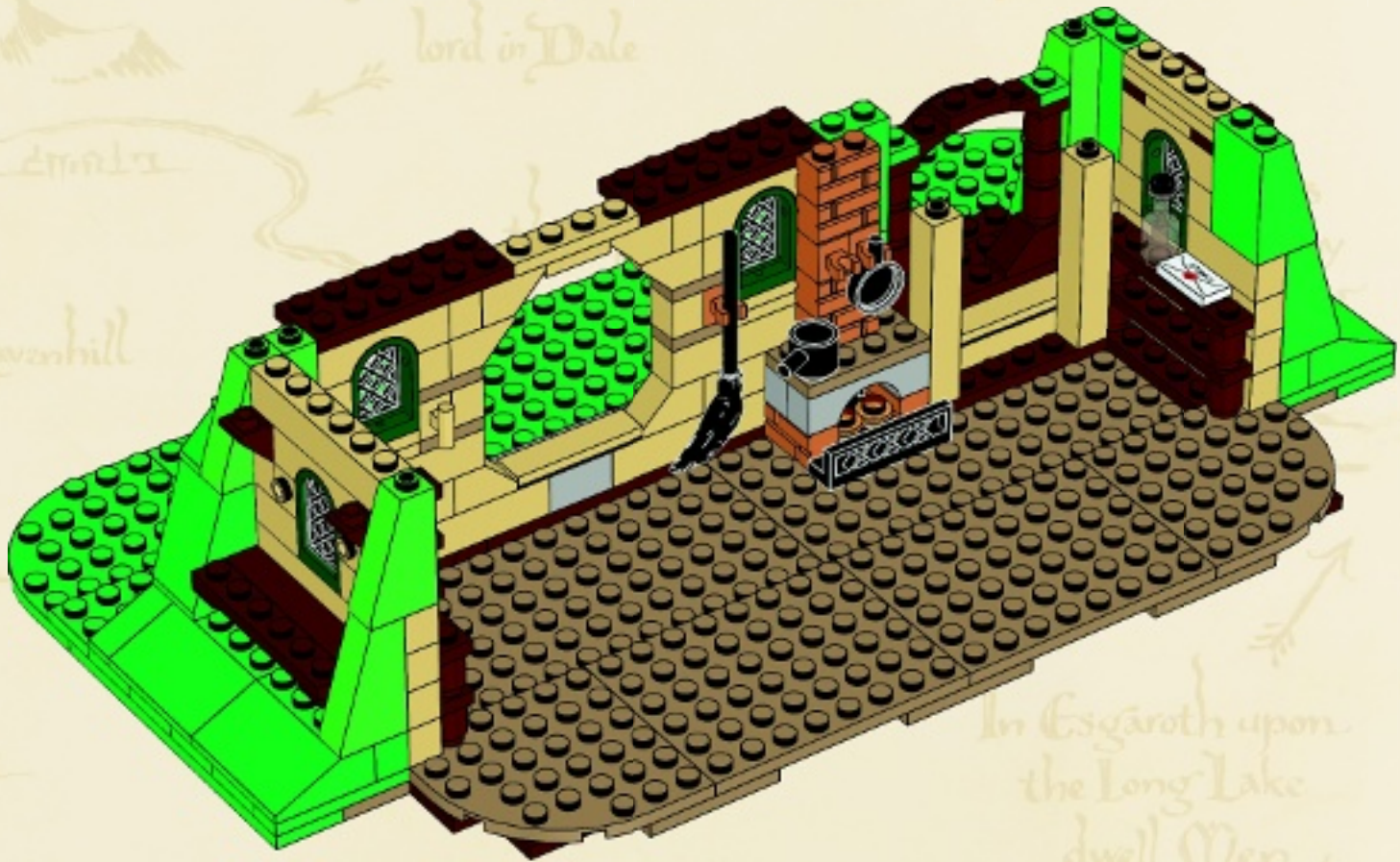

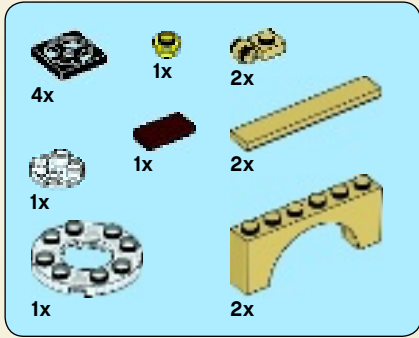

63

1



2



3

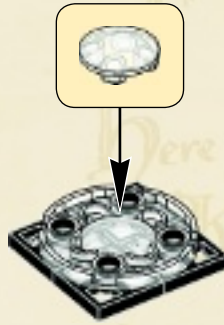
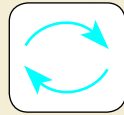

4



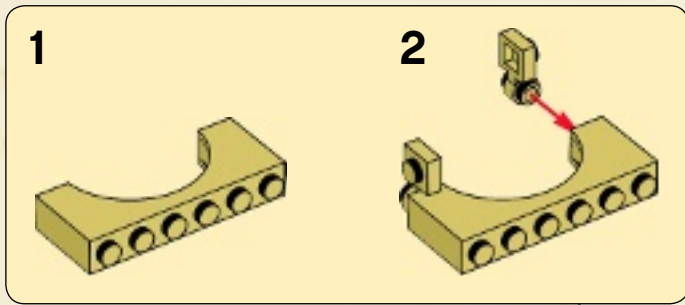

5

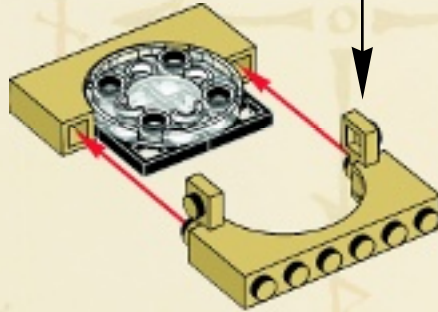

6



7

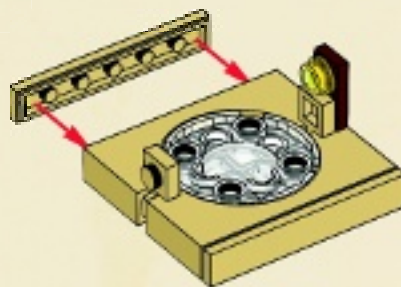

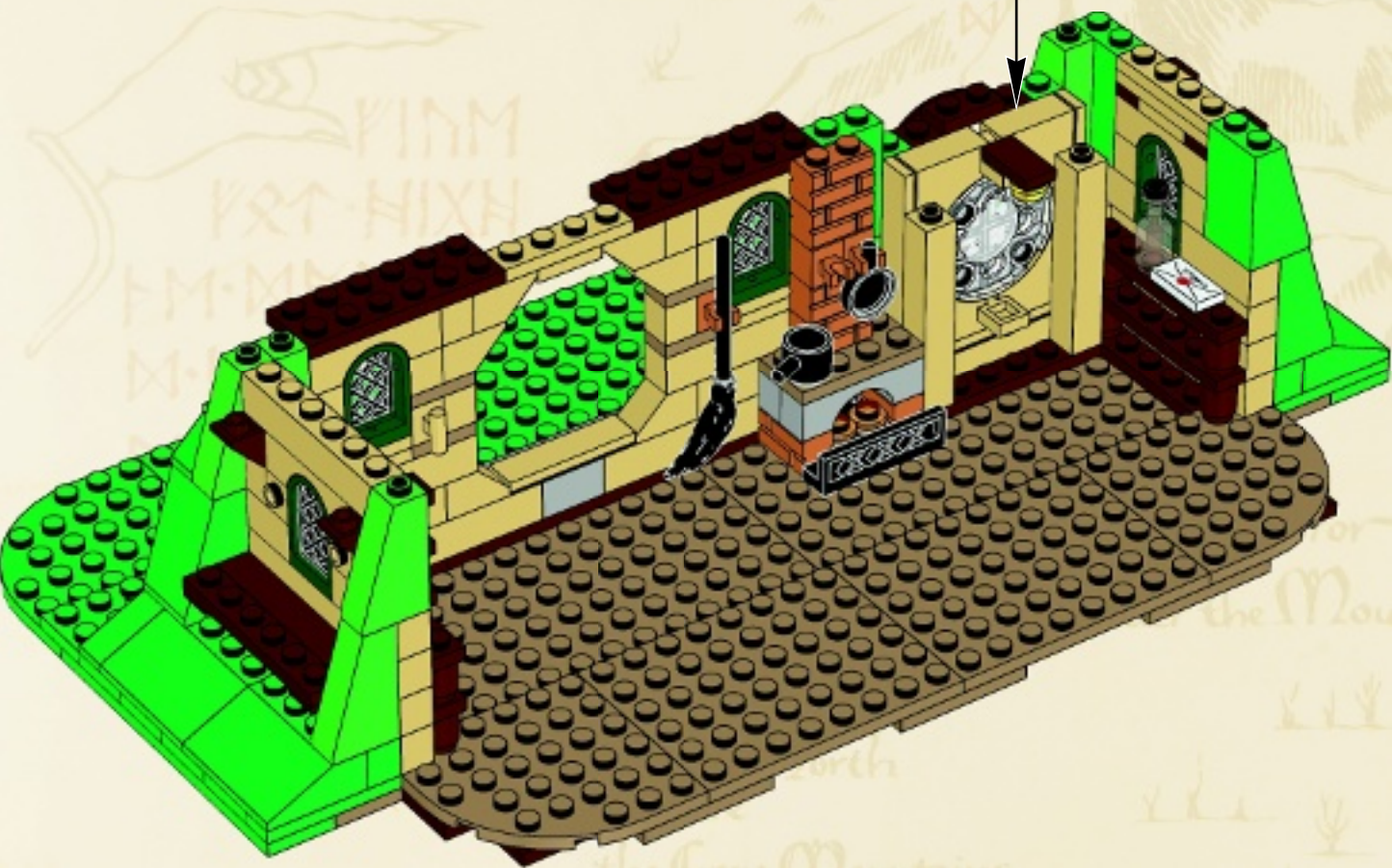
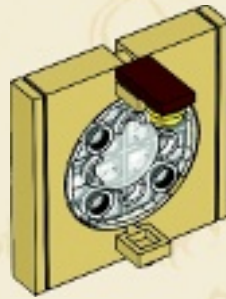
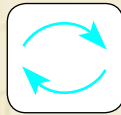



2x

64

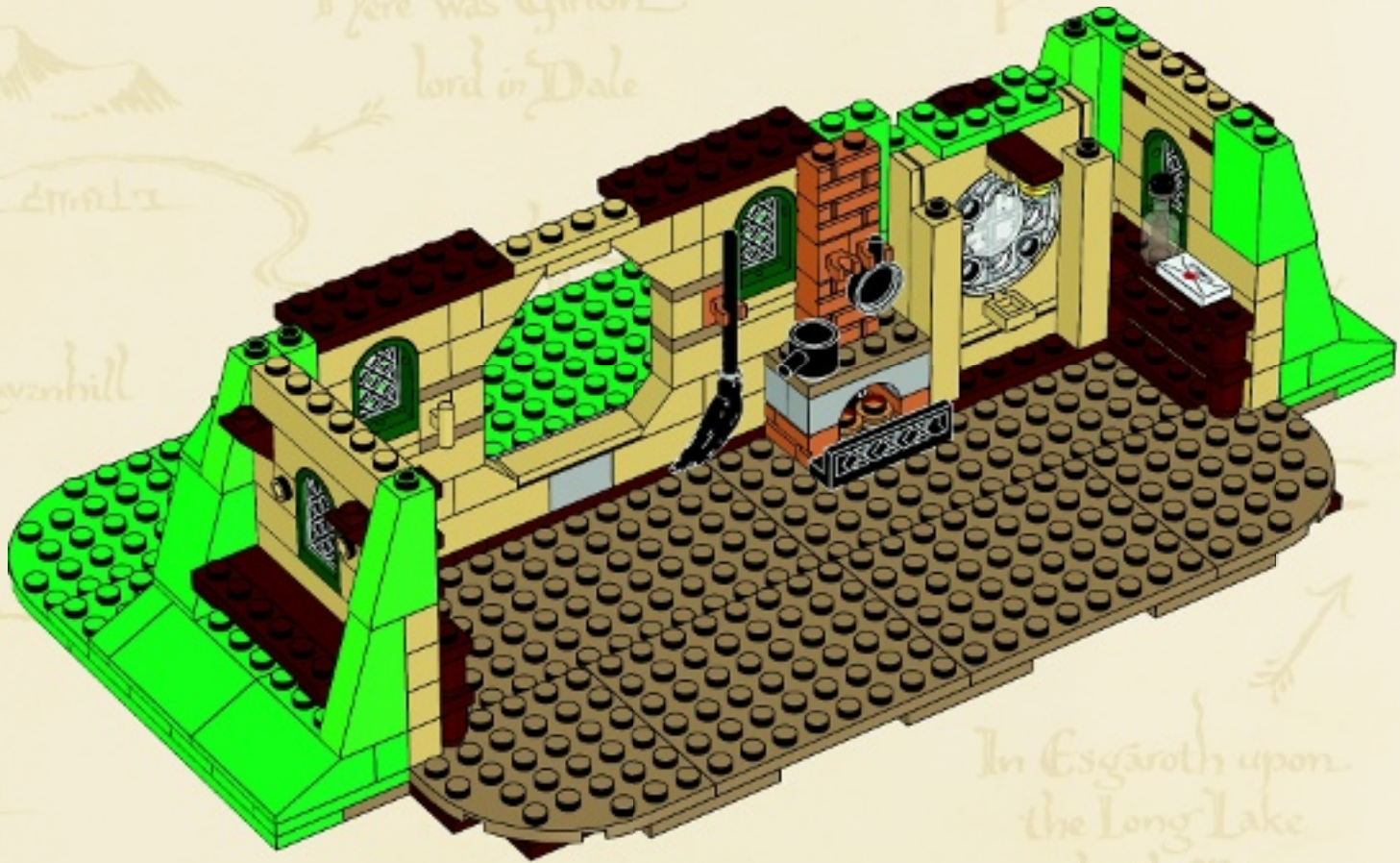

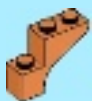

2x

65

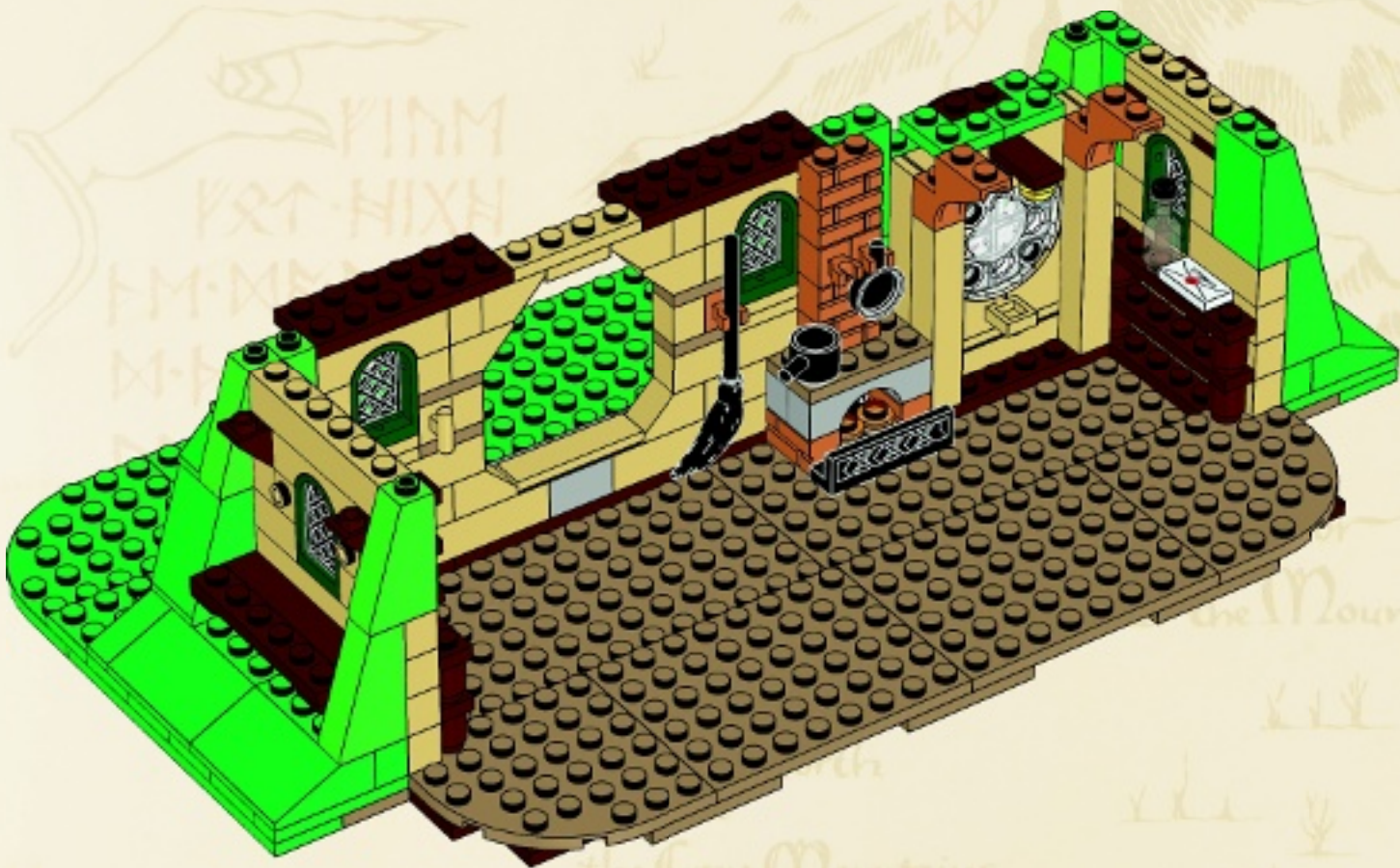

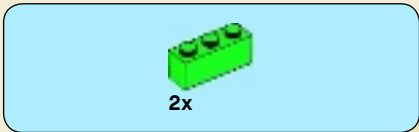

66

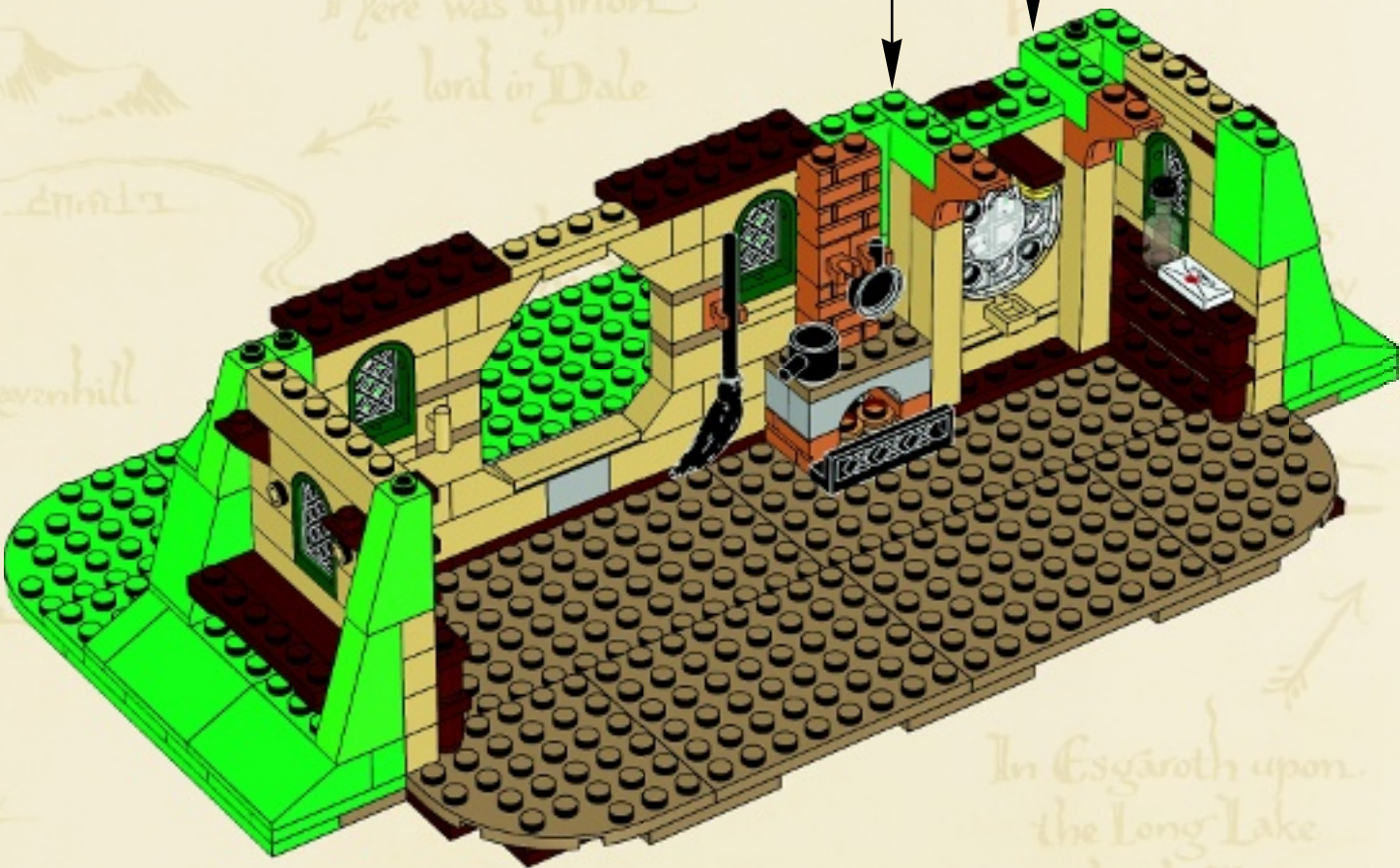
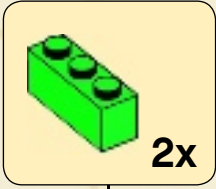



2x

67

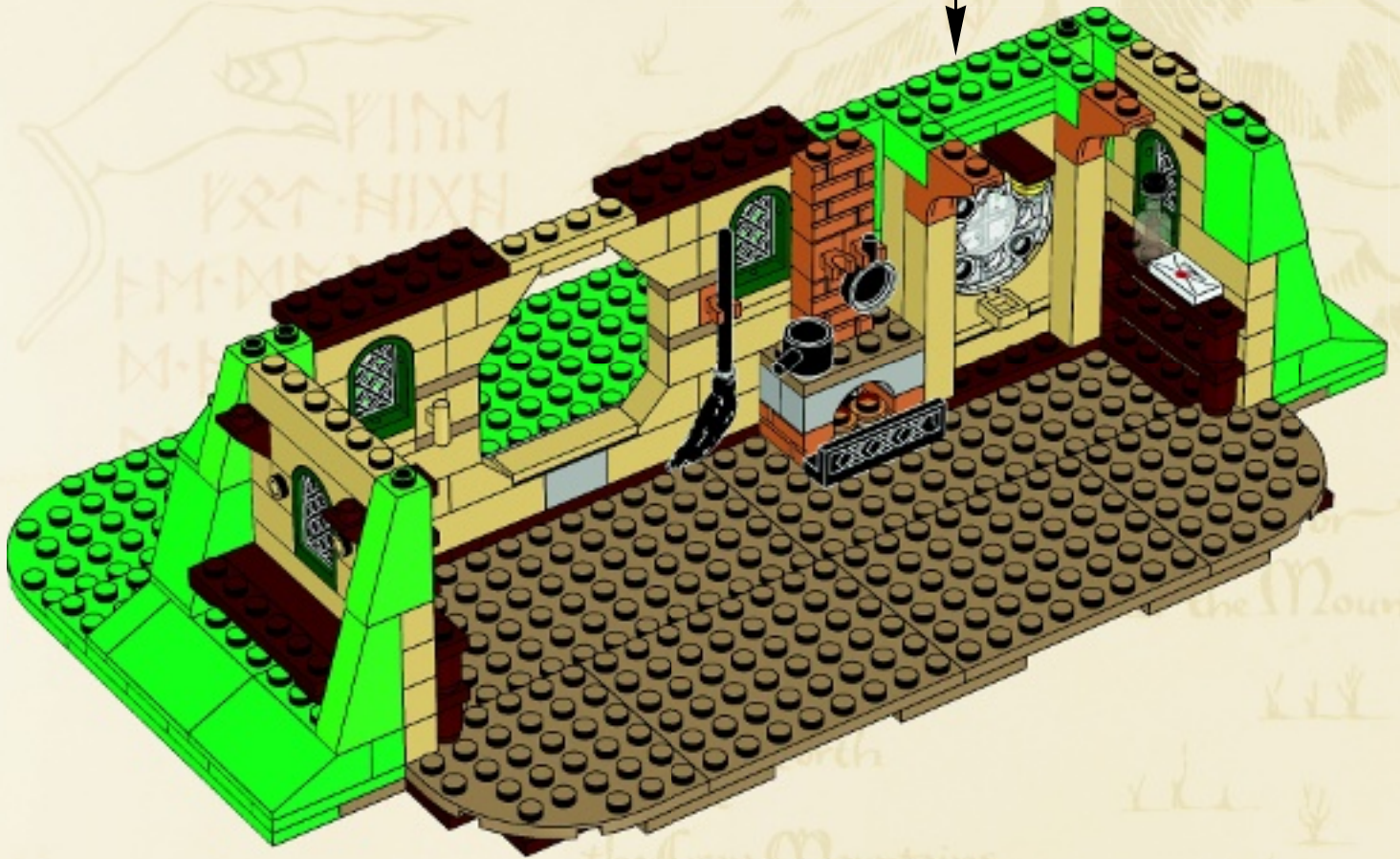
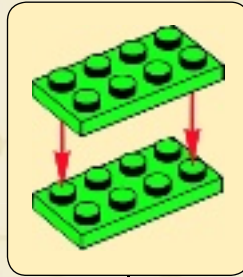

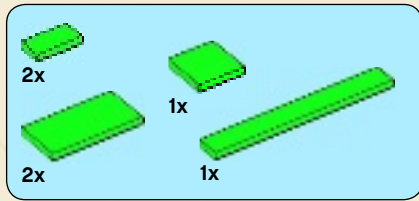

68

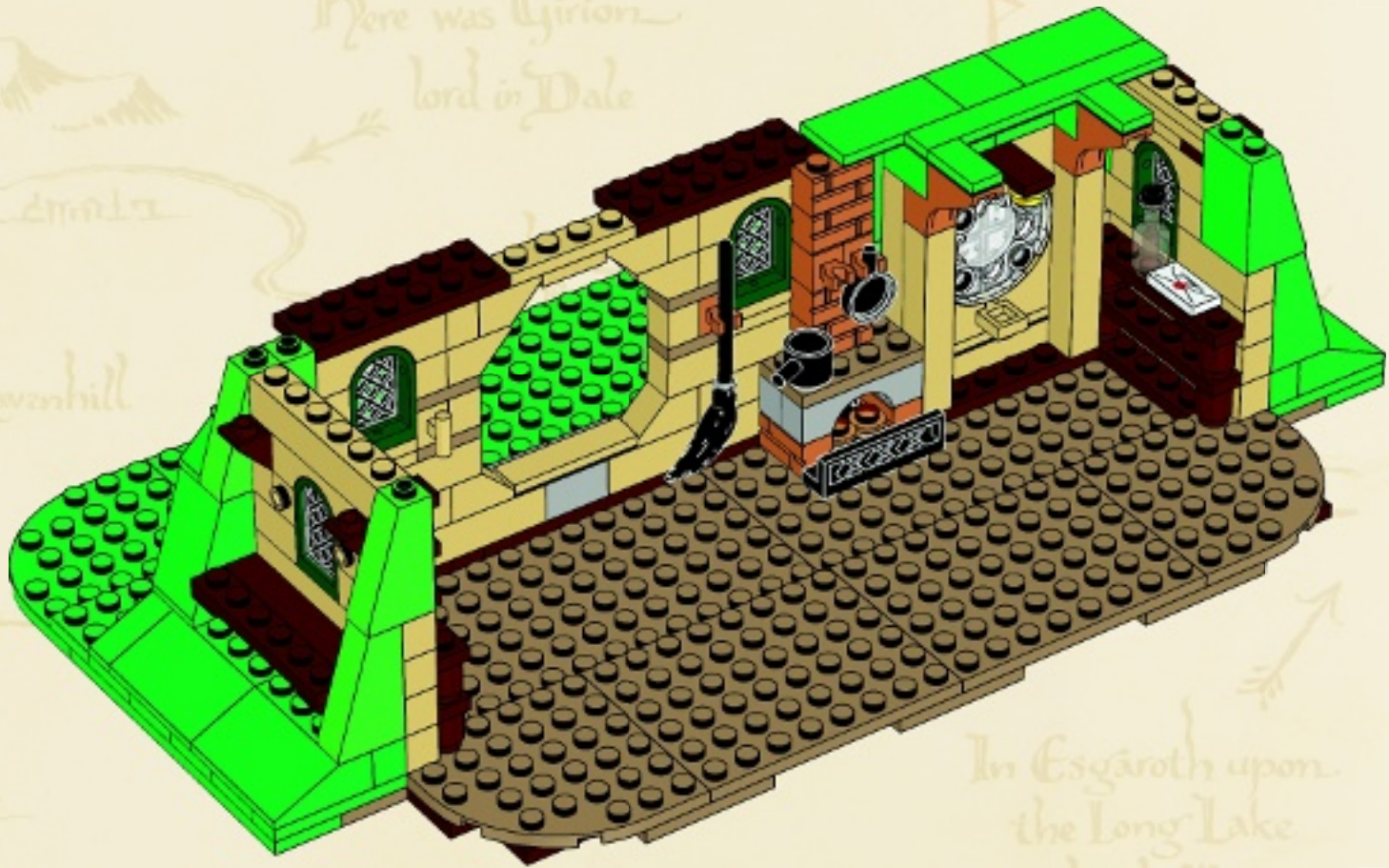



69

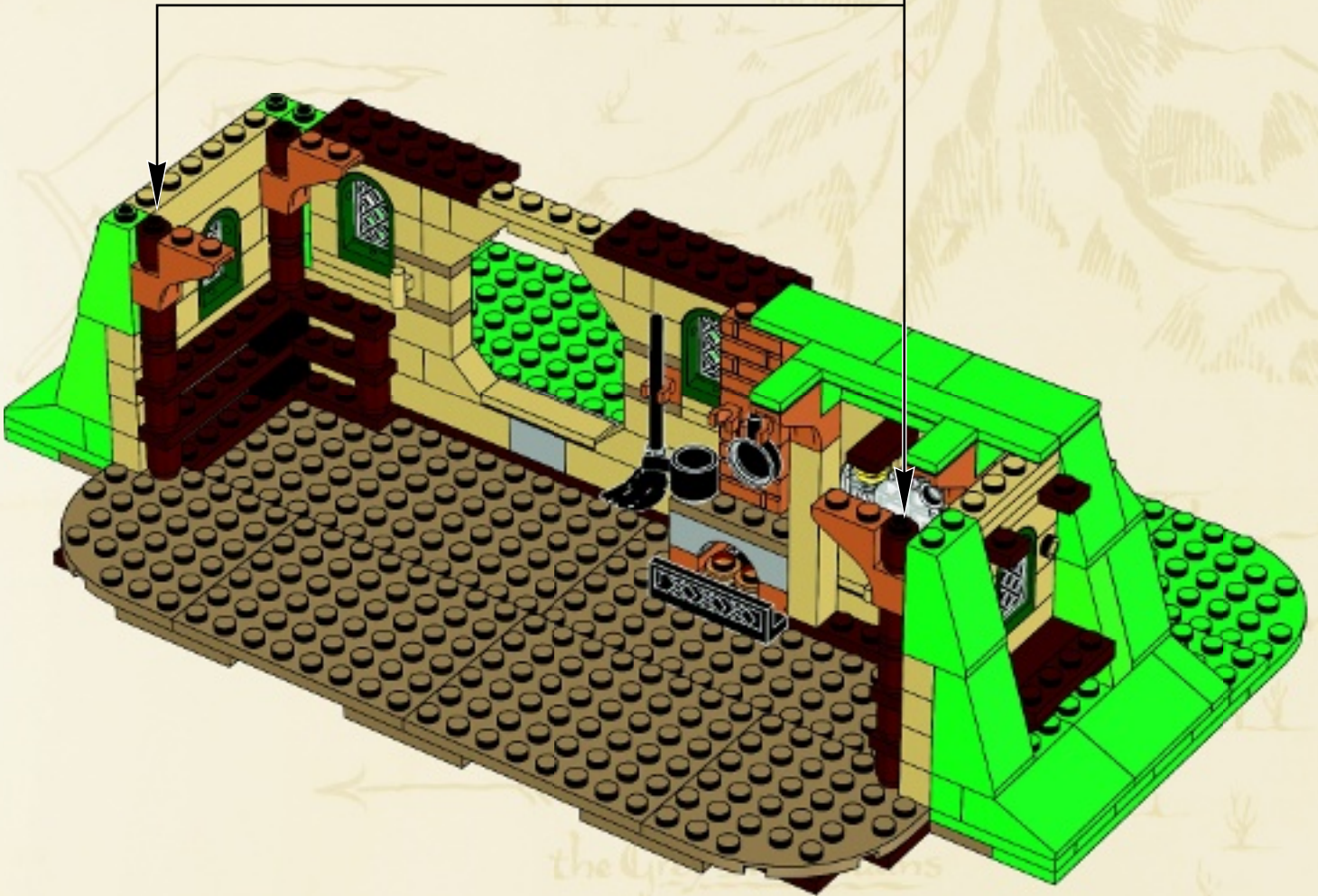
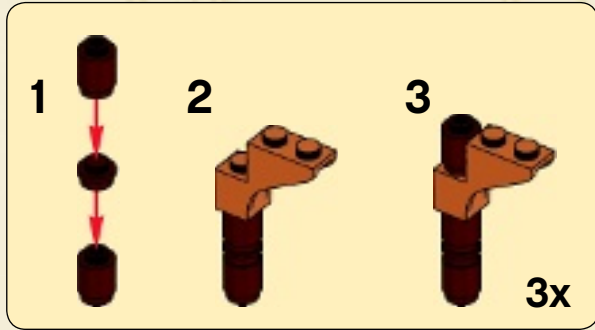

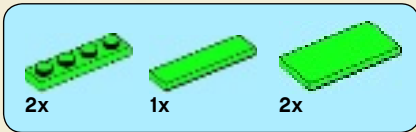

70

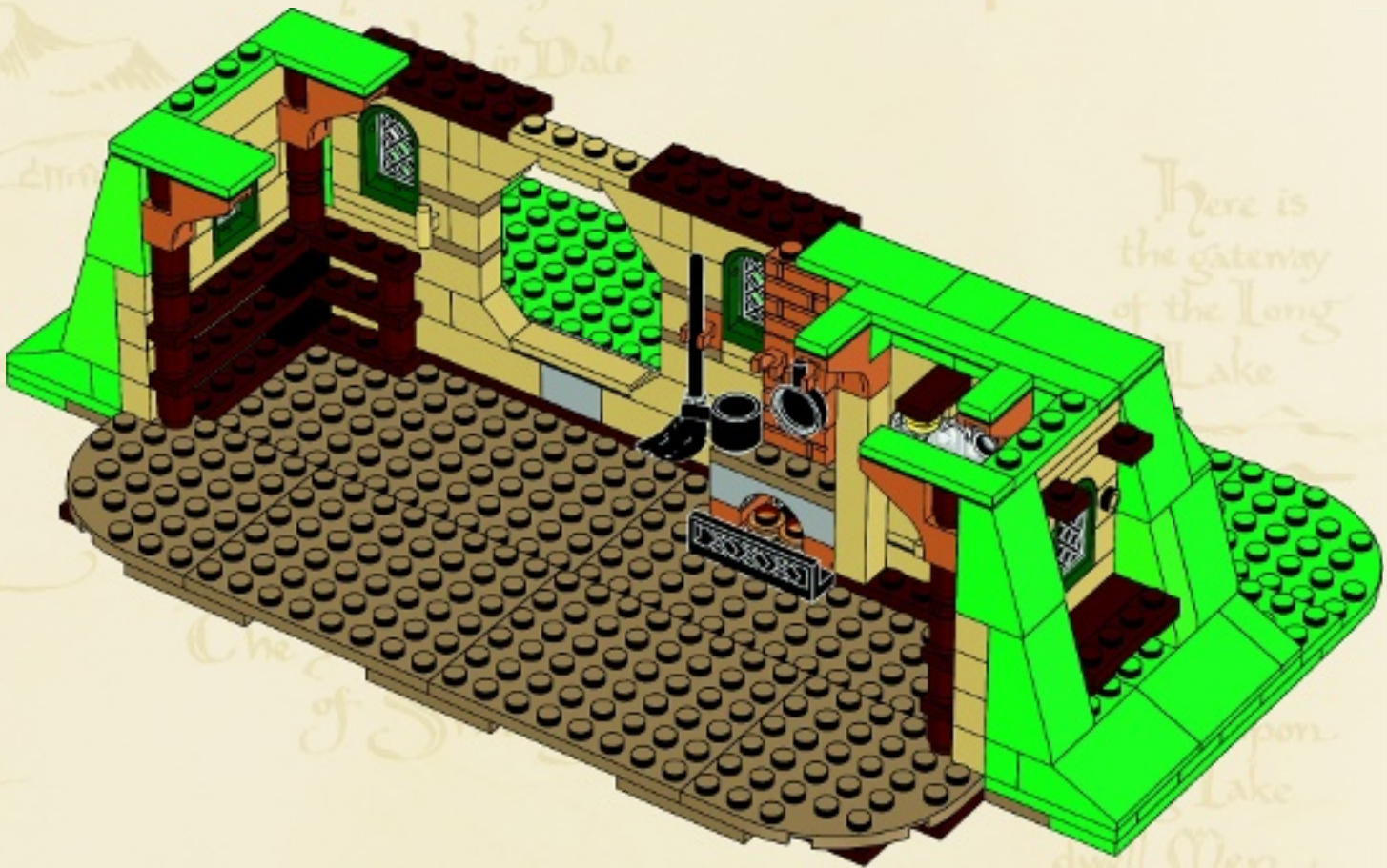

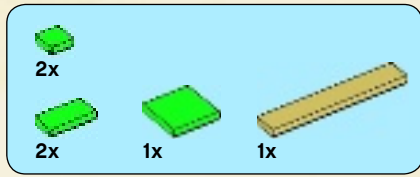

71

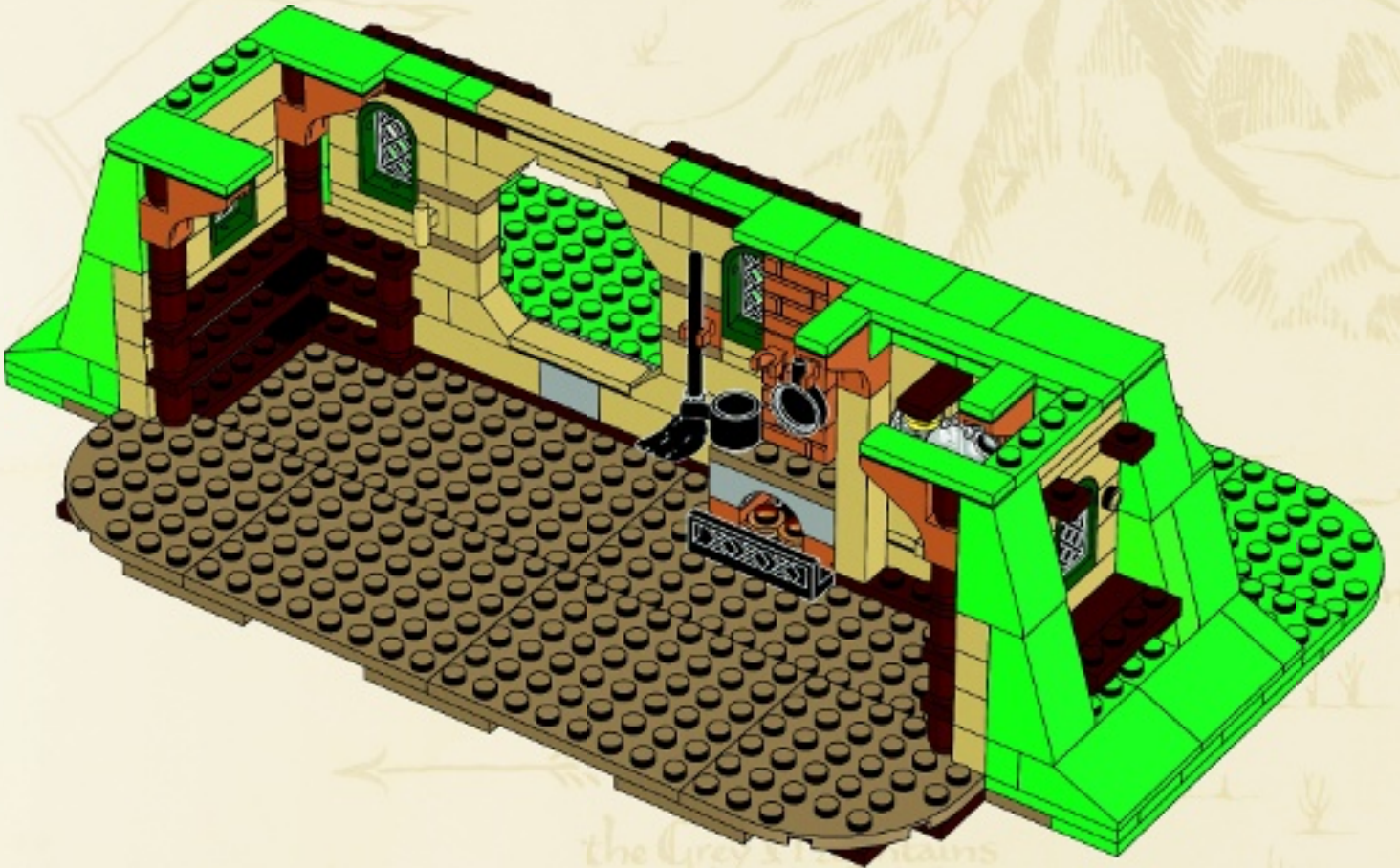

*the Grey's...
&
the Withered Heath
whence came the*

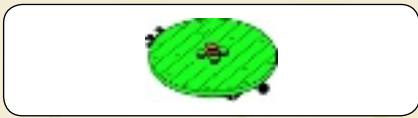

1

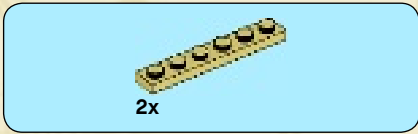
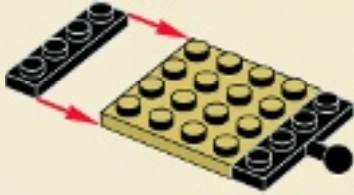

2



3

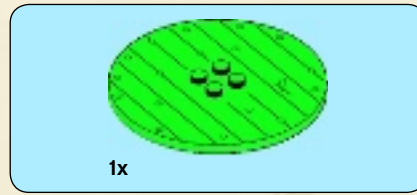
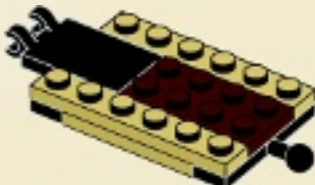

4

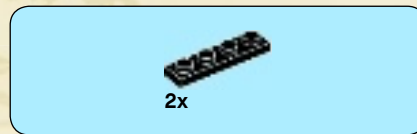
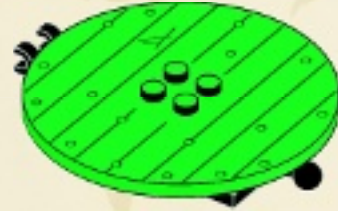

5

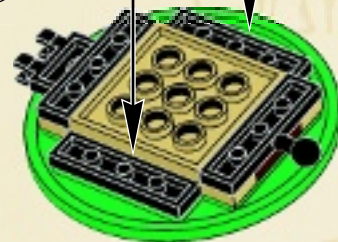
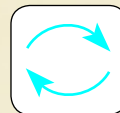
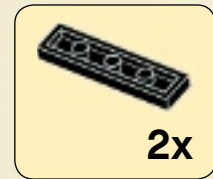





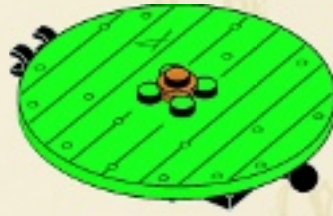
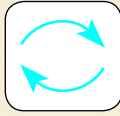

1x

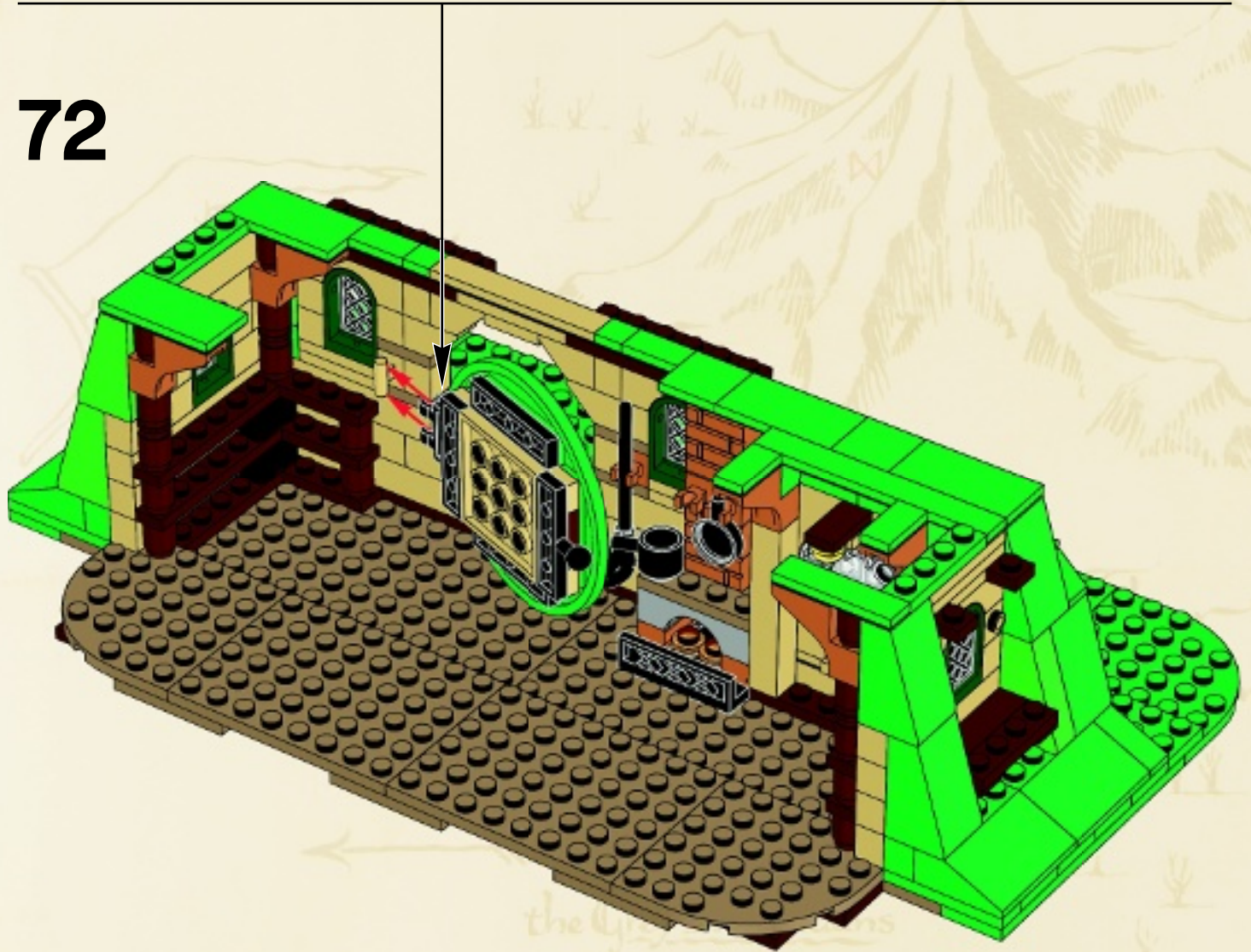
6



72



-  1x
-  2x
-  1x
-  1x
-  1x

73

- 1 
- 2 

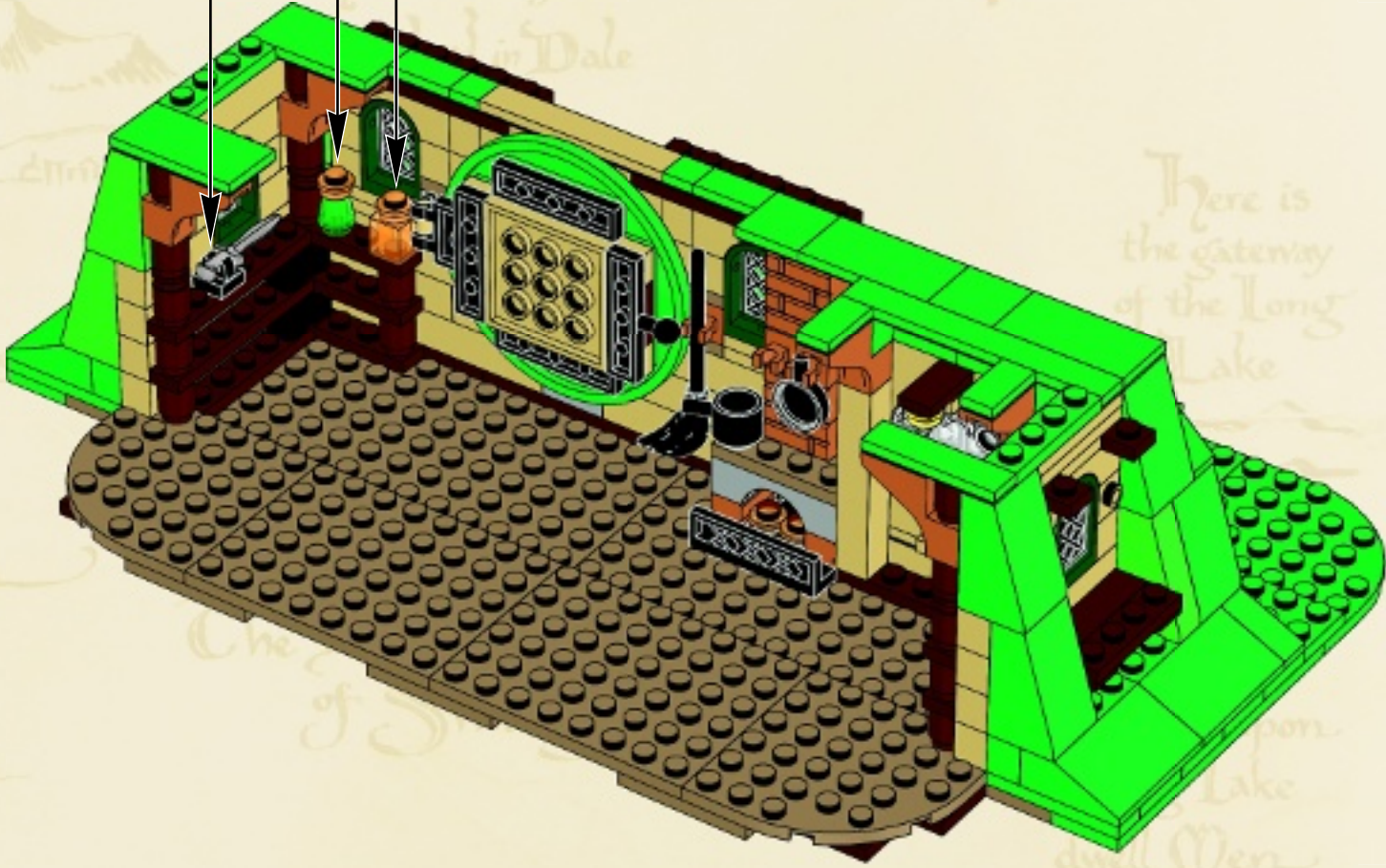

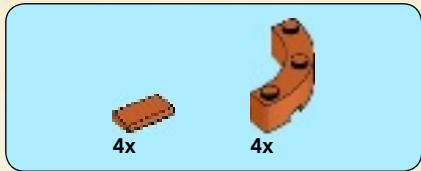

74

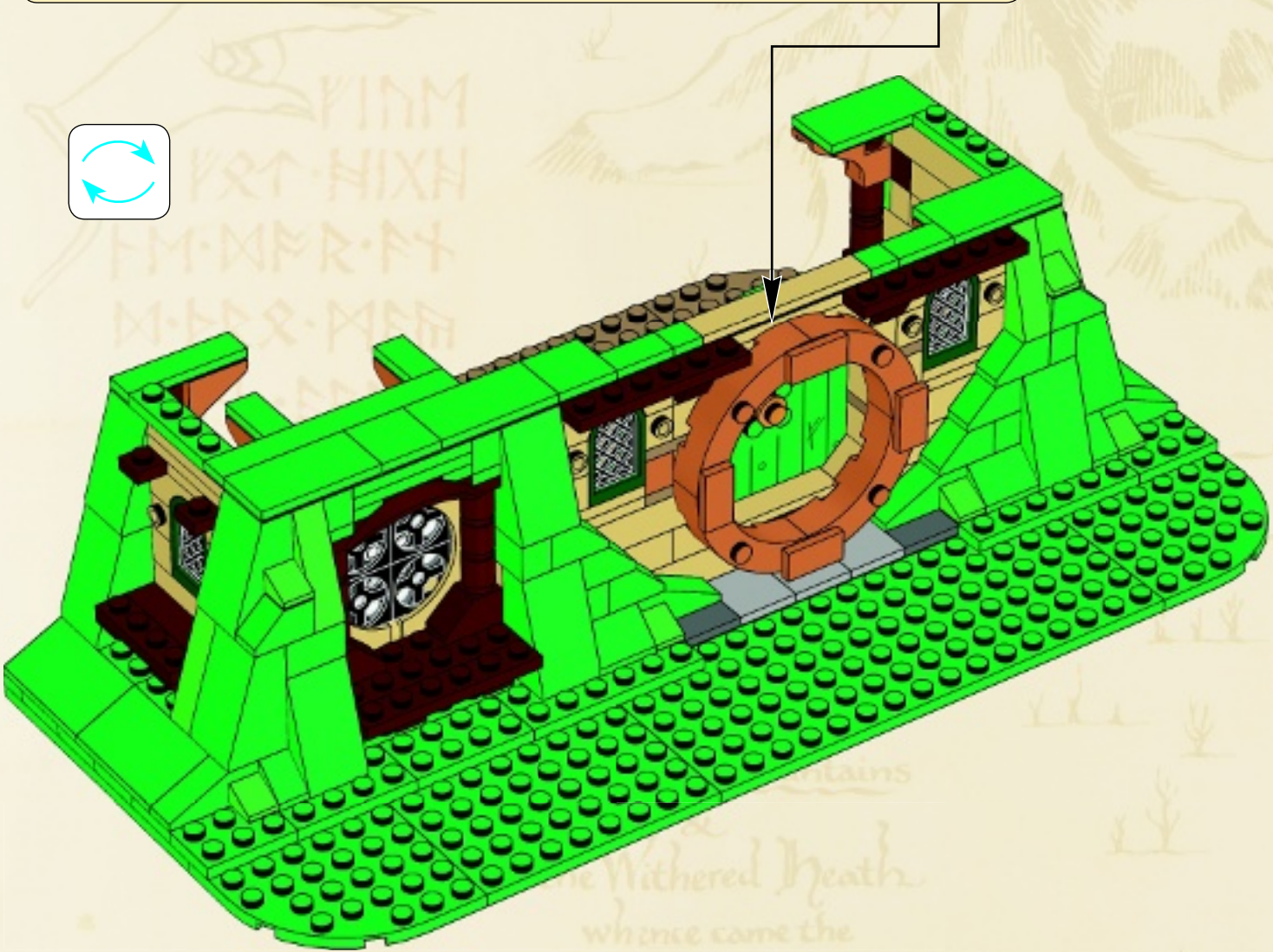
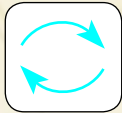
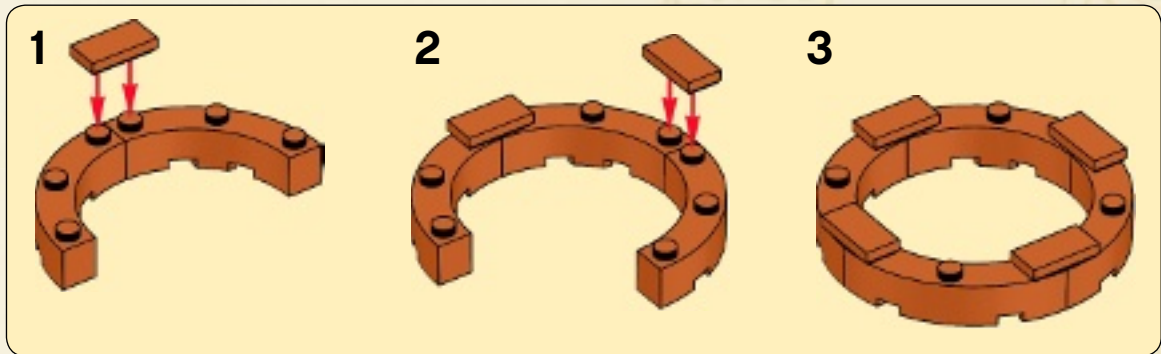



75

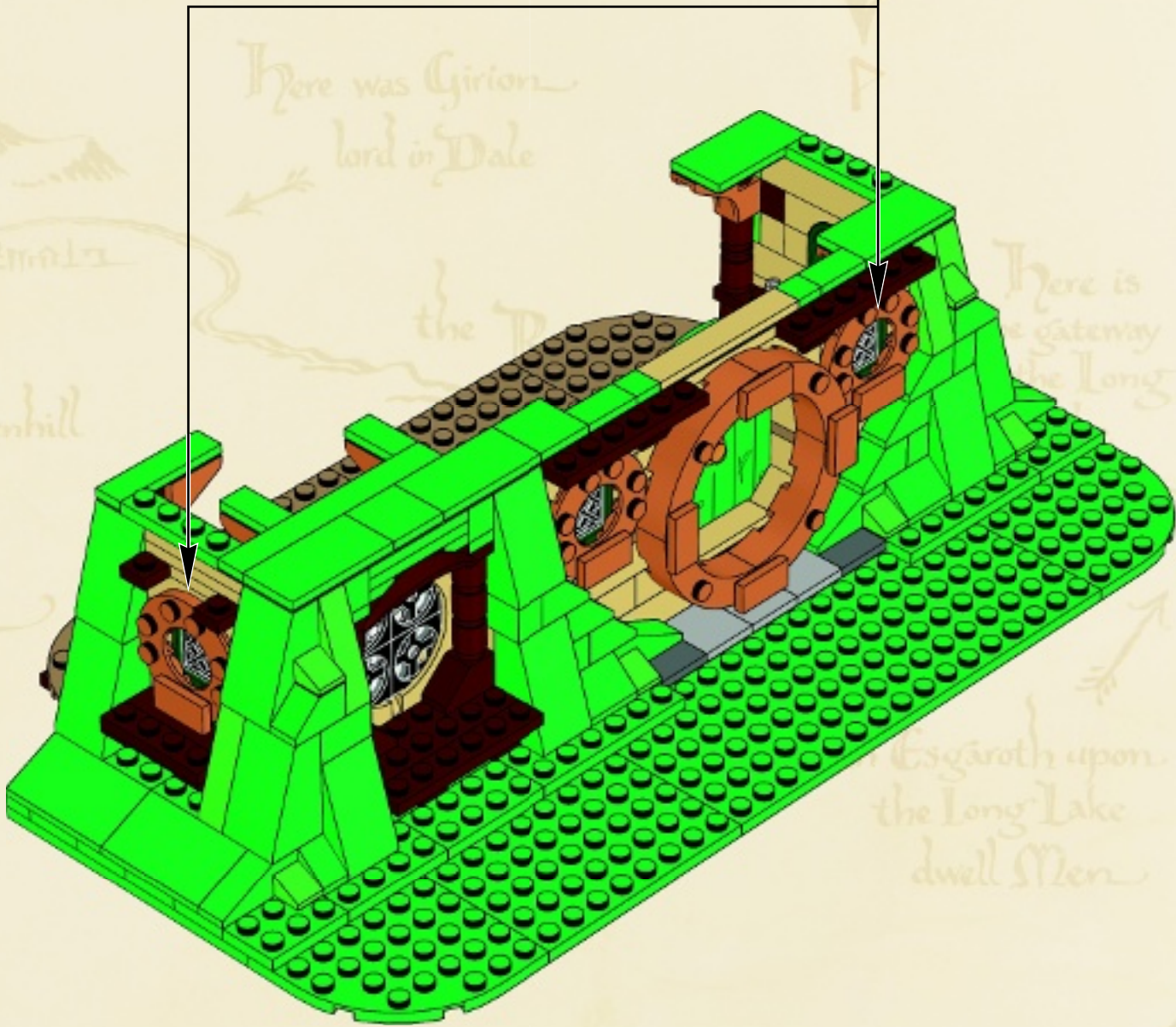

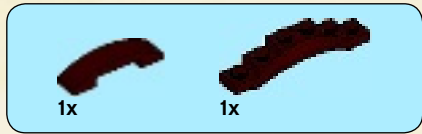

76

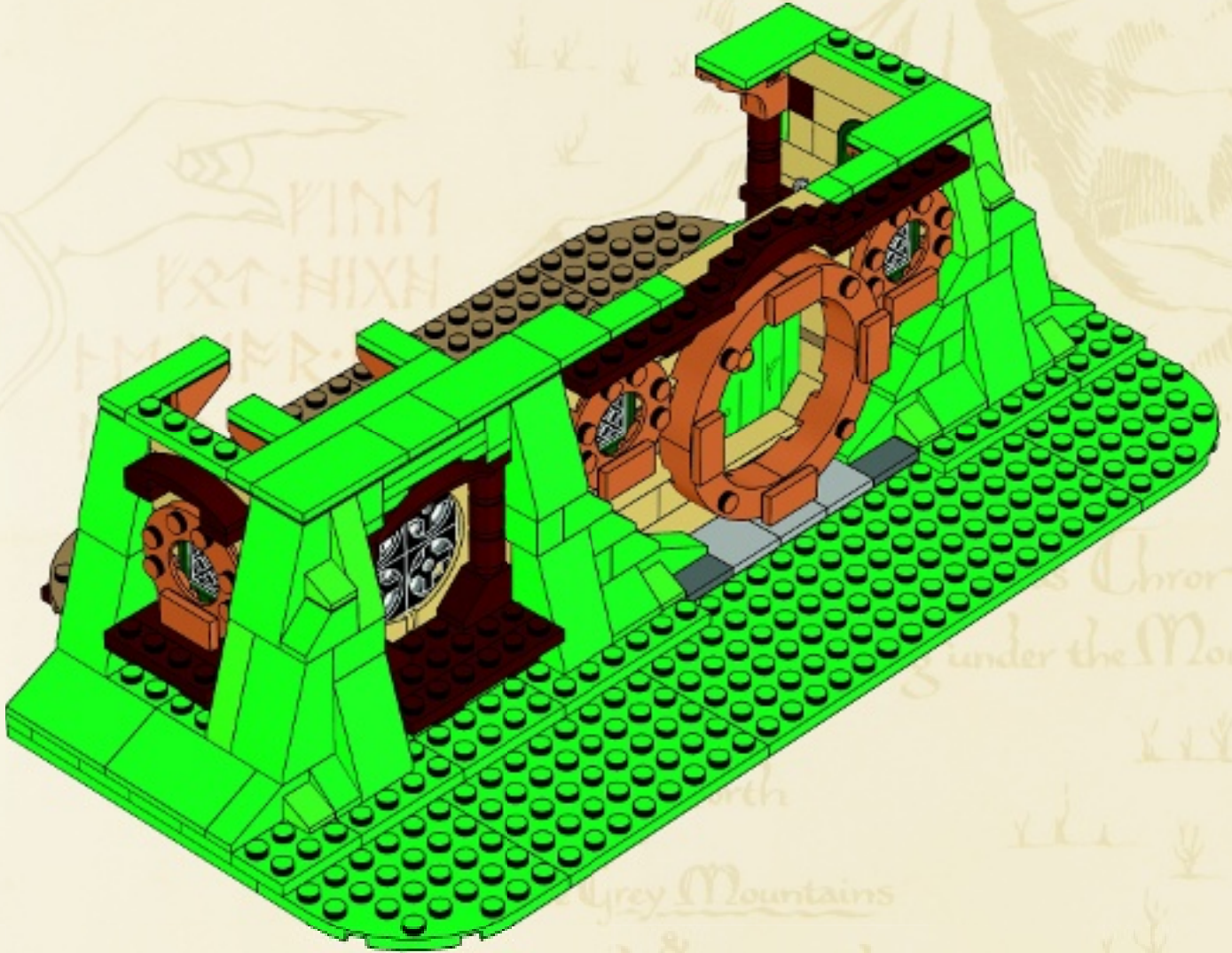

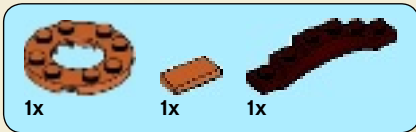

77

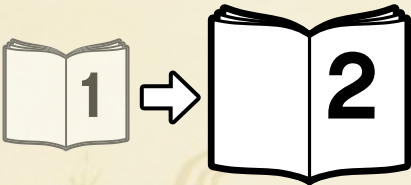
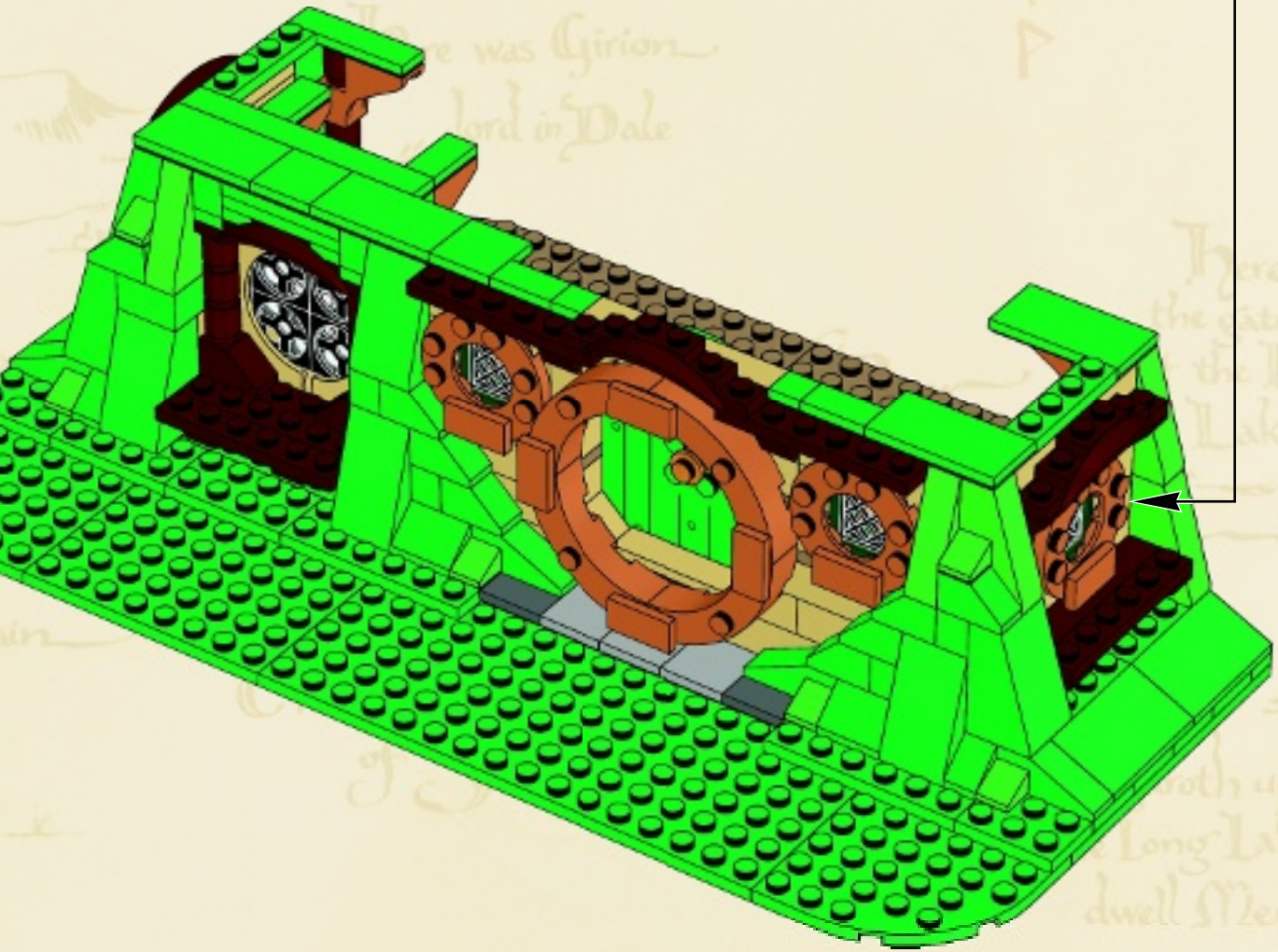



WIN!

Go to www.LEGOsurvey.com/product to fill out a survey for a chance to win a cool LEGO® Product.

No purchase necessary.

Open to all residents where not prohibited.



www.LEGOsurvey.com/product

GEWINNE!

Nimm an der Umfrage auf www.LEGOsurvey.com/product teil und hab die Chance ein cooles LEGO® Produkt zu gewinnen!

Die Teilnahme am Gewinnspiel führt zu keinerlei Kaufverpflichtungen. Teilnahme in allen nicht ausgeschlossenen Ländern möglich.

WIN!

Ga naar www.LEGOsurvey.com/product, vul een enquêteformulier in en maak kans op een cool LEGO® product.

Geen aankoopverplichting. Iedereen mag deelnemen, uitgezonderd ingezetenden van landen waar een enquêteverbod geldt.

GAGNE!

Visite www.LEGOsurvey.com/product pour répondre à un questionnaire et avoir une chance de gagner un produit LEGO® très cool!

Aucune obligation d'achat. Ouvert à tous les résidents des pays autorisés.

当てよう!

www.LEGOsurvey.com/product にアクセスして、アンケートにご記入ください。当選者にはレゴ製品を差し上げます。

お買い上げの必要はありません。禁止されていない限り、すべての皆様にご利用いただけます。



LEGO and the LEGO logo are trademarks of the/sonnt des marques de commerce de/son marcas registradas de LEGO Group.
©2012 The LEGO Group. 6036617

THE HOBBIT: AN UNEXPECTED JOURNEY: © NLP™ Middle-earth Ent. Lic. to New Line. (s12)
LE HOBBIT : UN VOYAGE INATTENDU : © NLP™ Middle-earth Ent. Lic. à New Line. (s12)
EL HOBBIT: UN VIAJE INESPERADO: © NLP™ Middle-earth Ent.; uso autorizado a New Line. (s12)



THE HOBBIT™

AN UNEXPECTED JOURNEY

79003



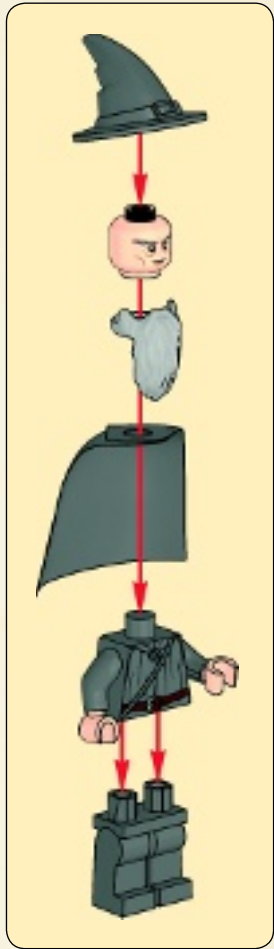
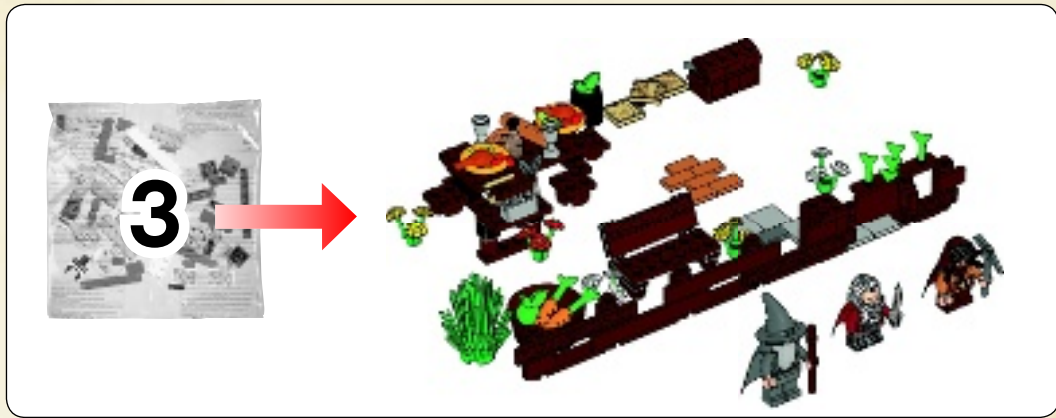

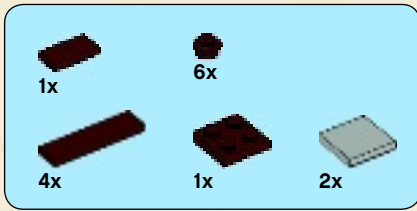

78

LEGO THE HOBBIT™
AN UNEXPECTED JOURNEY

LEGO LE HOBBIT™
UN VOYAGE INATTENDU

LEGO IL HOBBIT™
UN VIAGGIO INASPETTATO

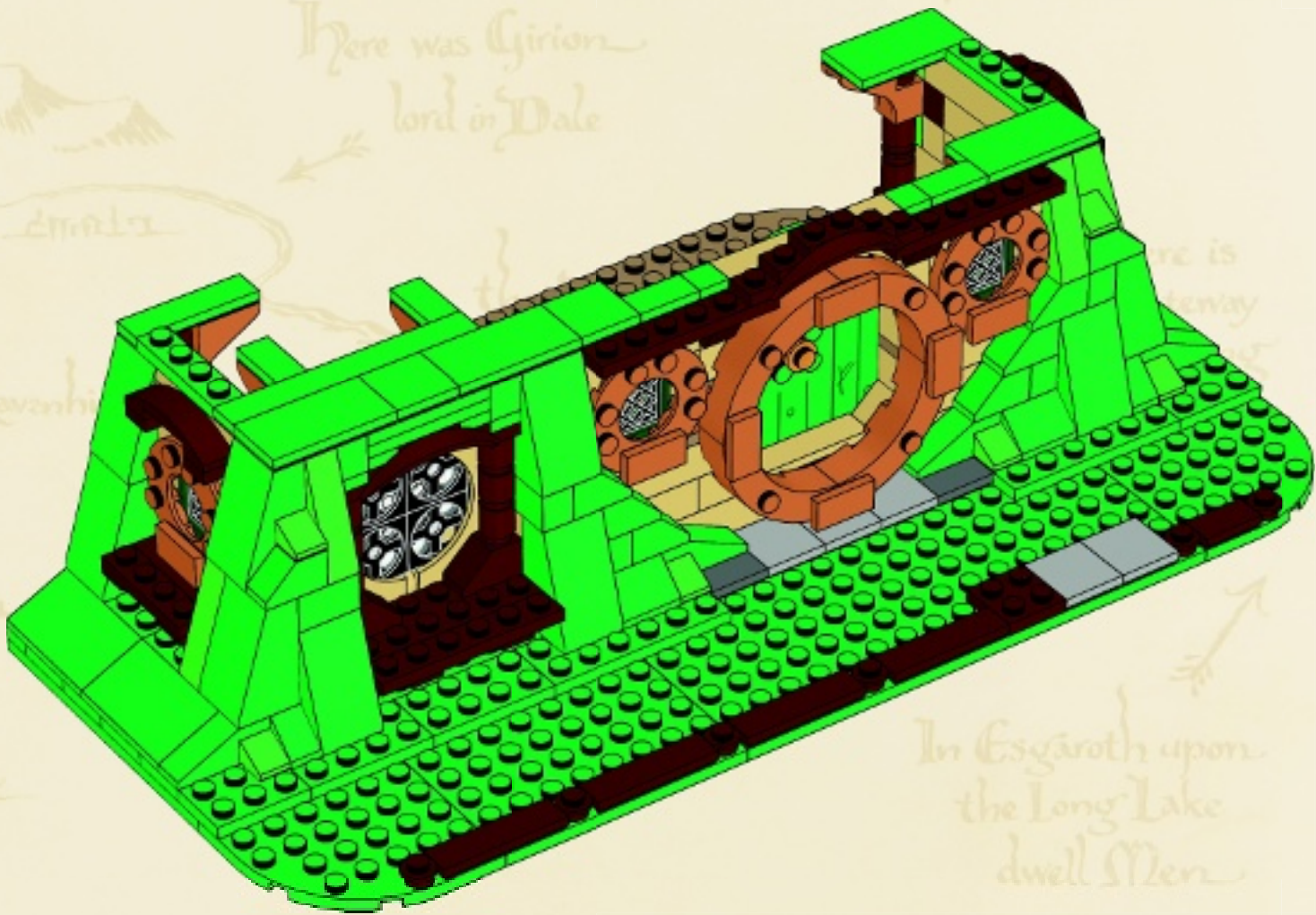



3x



5x

79

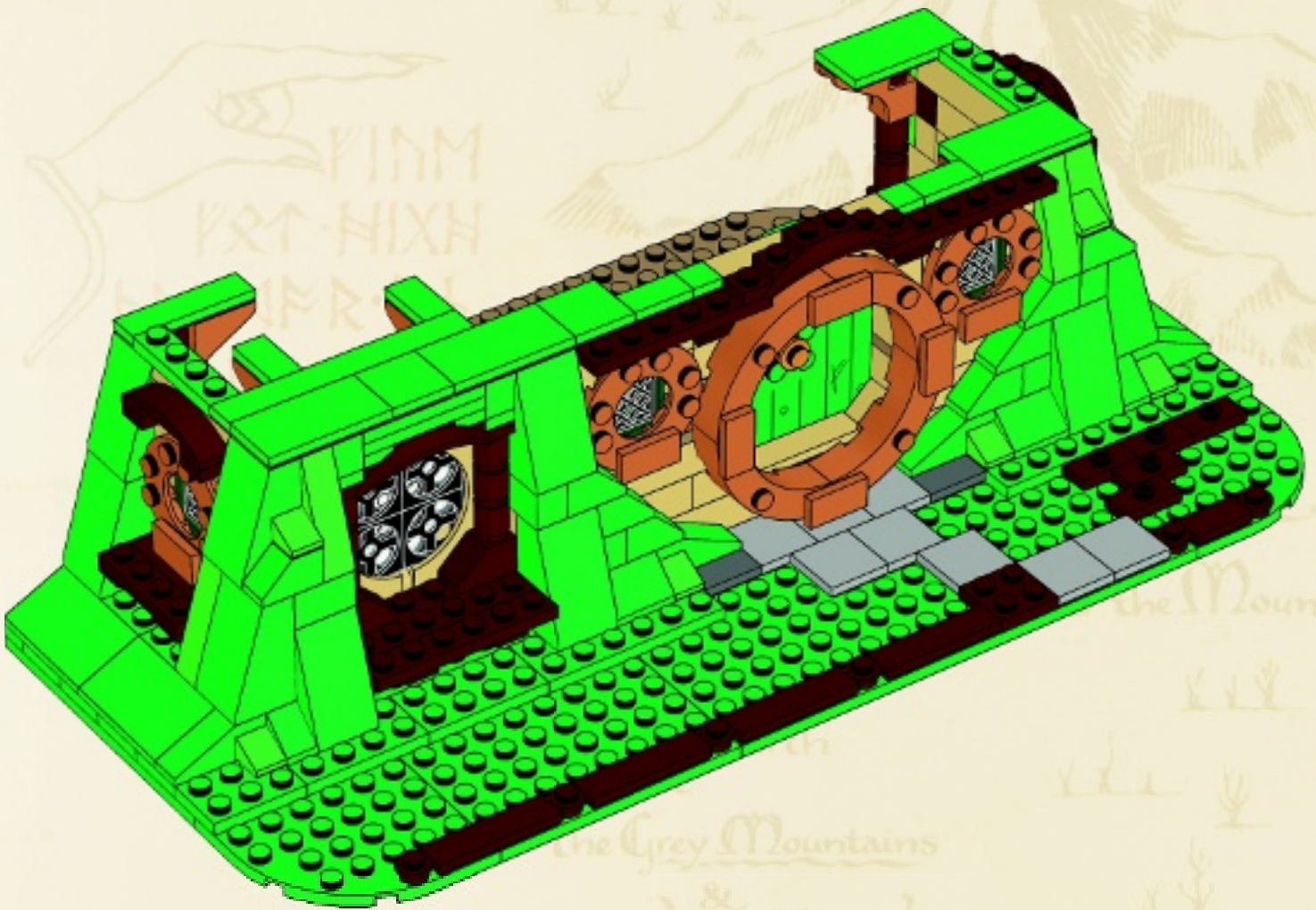

5x

2x

80

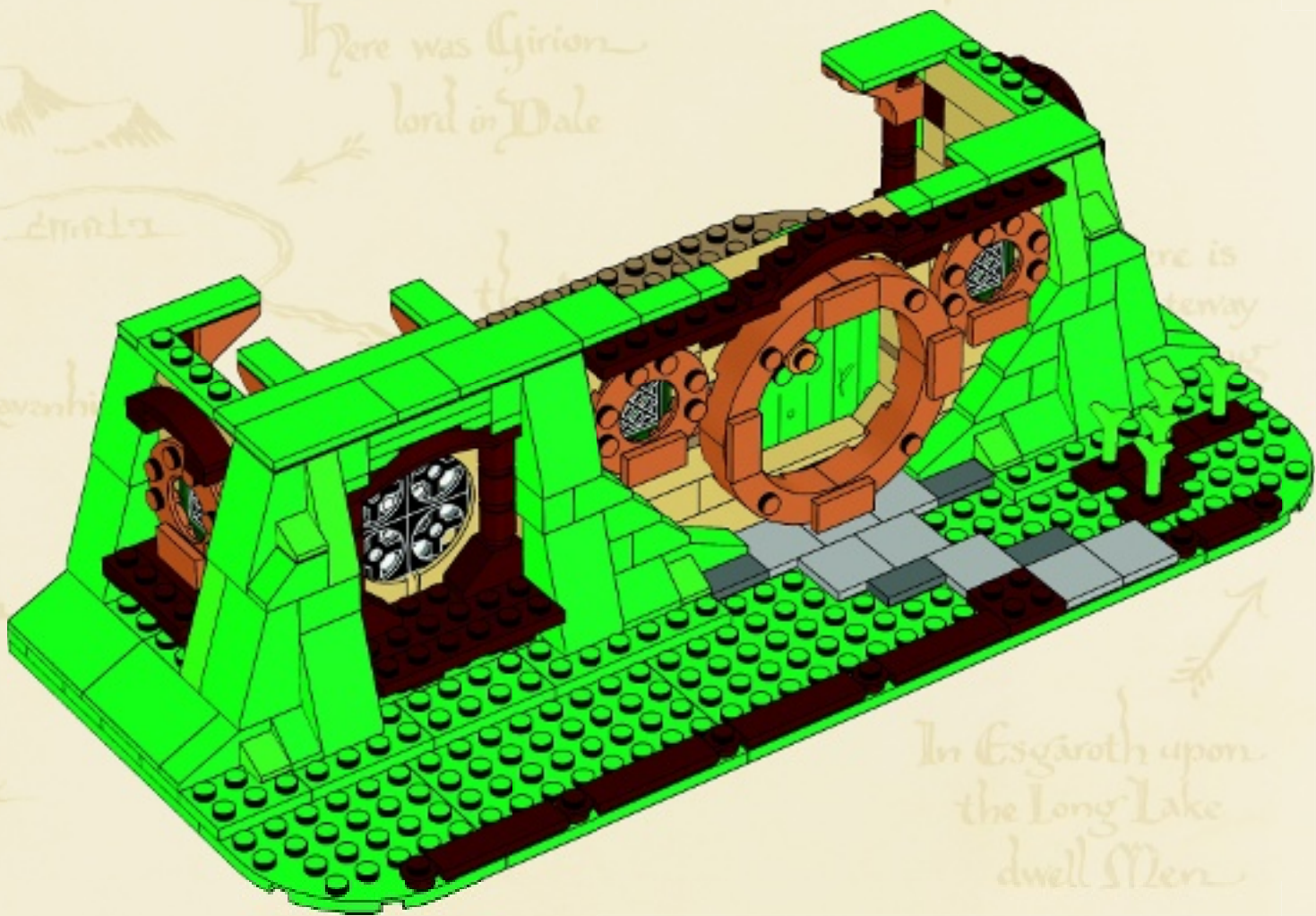

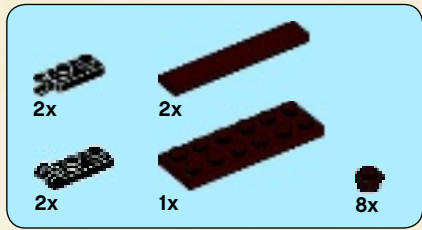

81

1



2



3

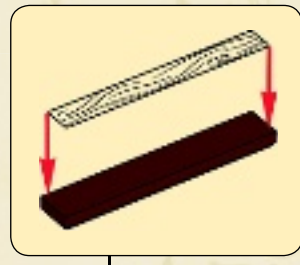

4

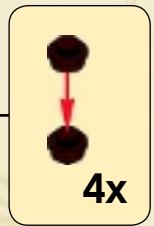
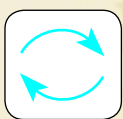

↑ East lie the Iron Hills
where is Dair

5

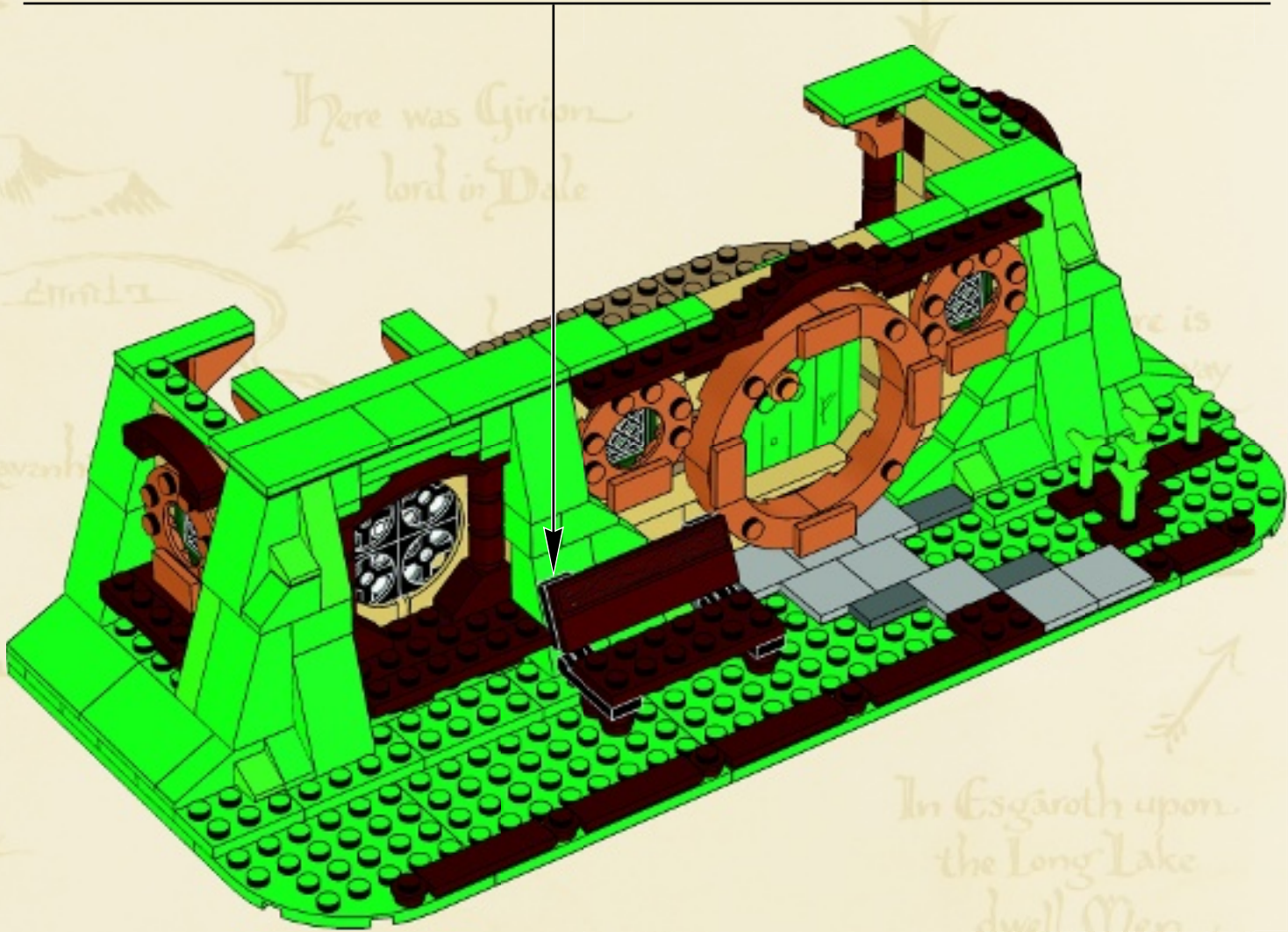
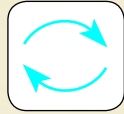

In Esgaroth upon
the Long Lake
dwell Men

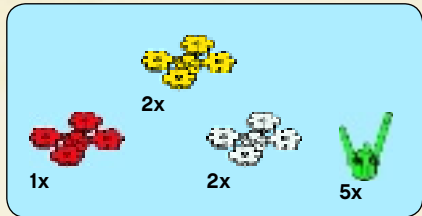

82

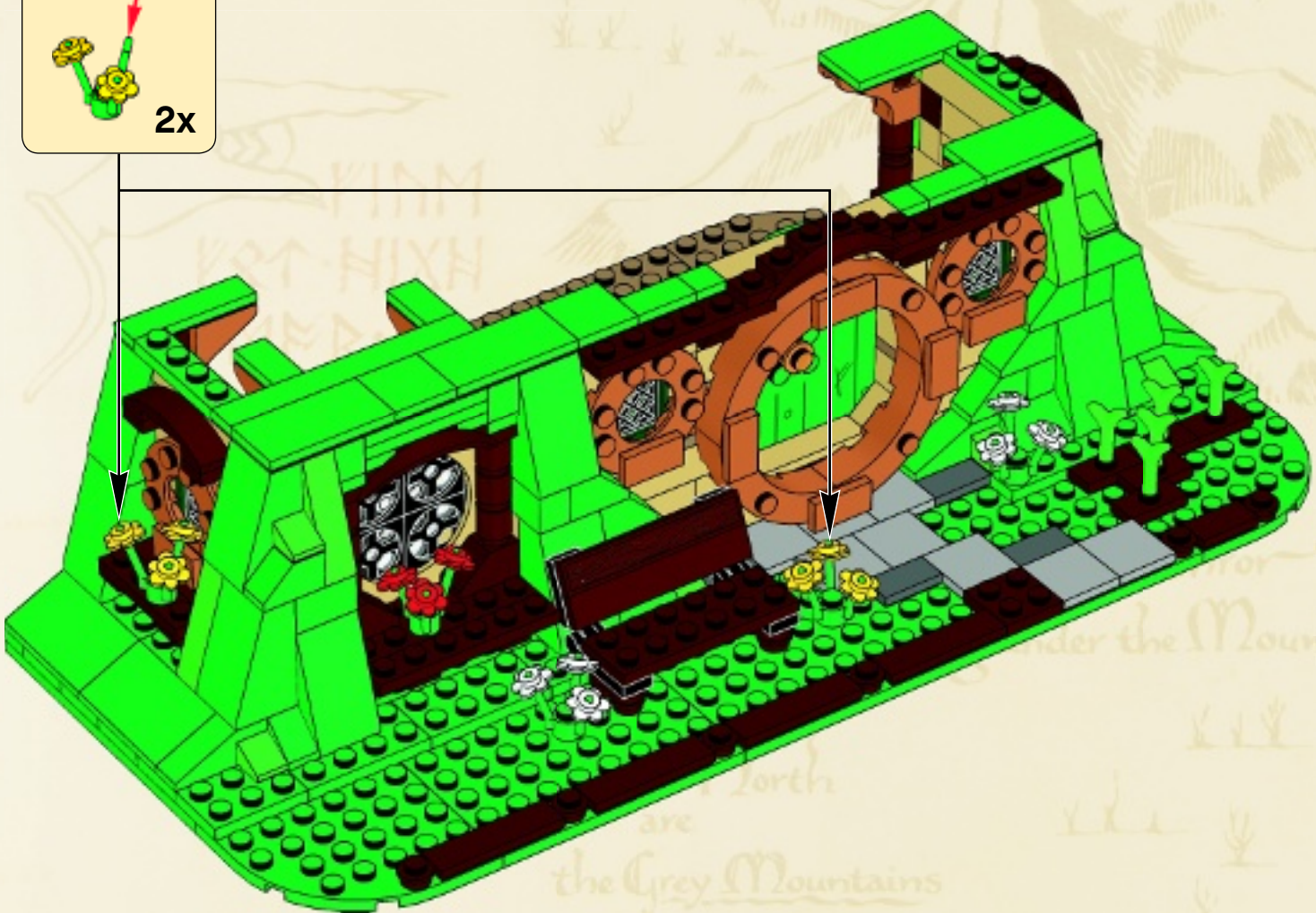
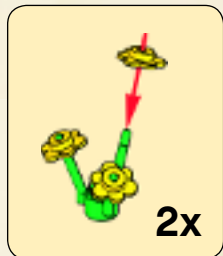

5x

10x

83

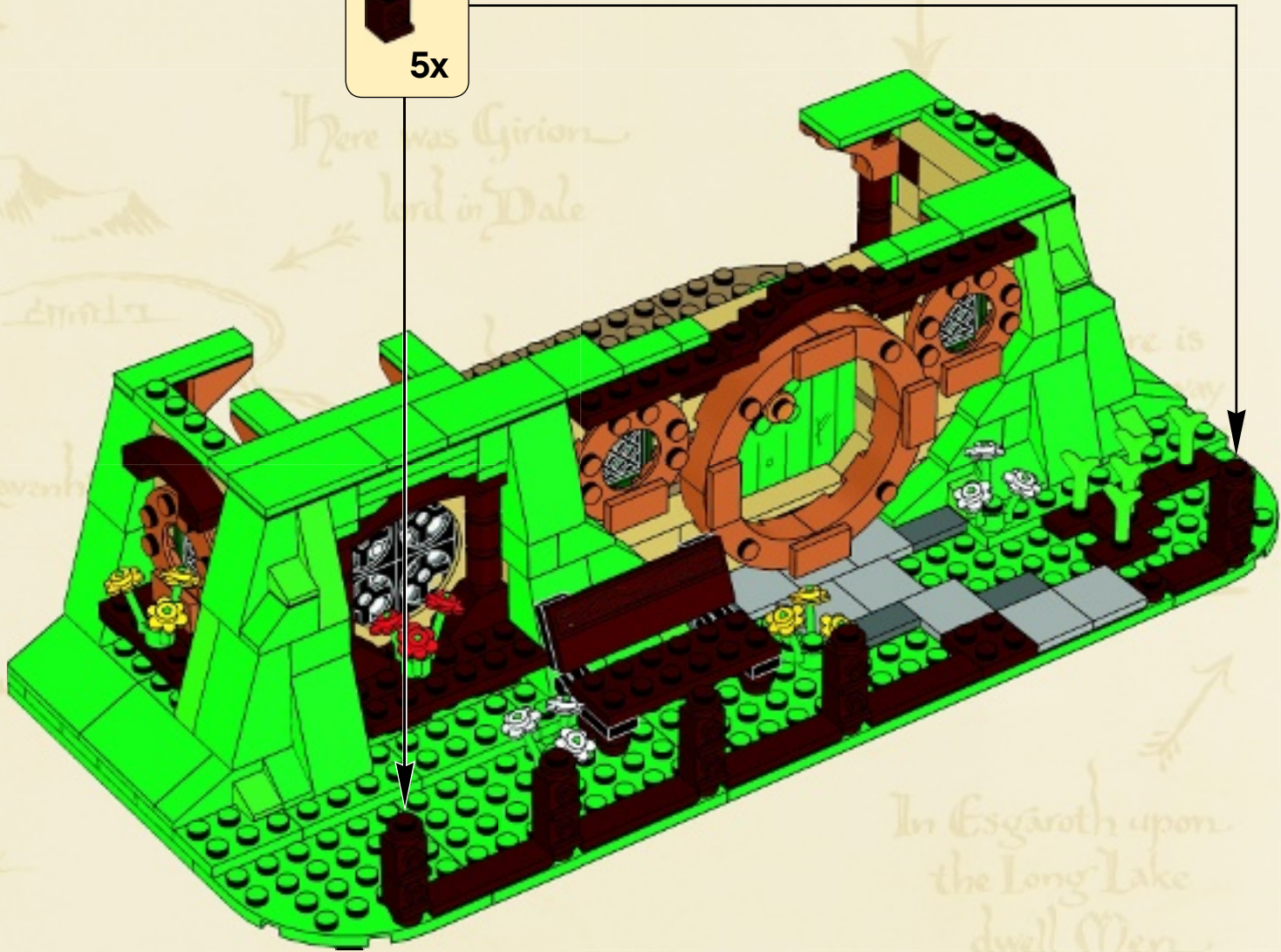
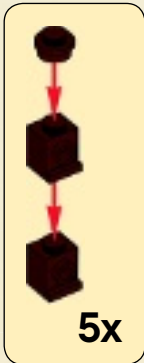

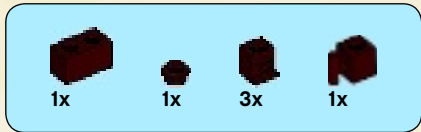

84

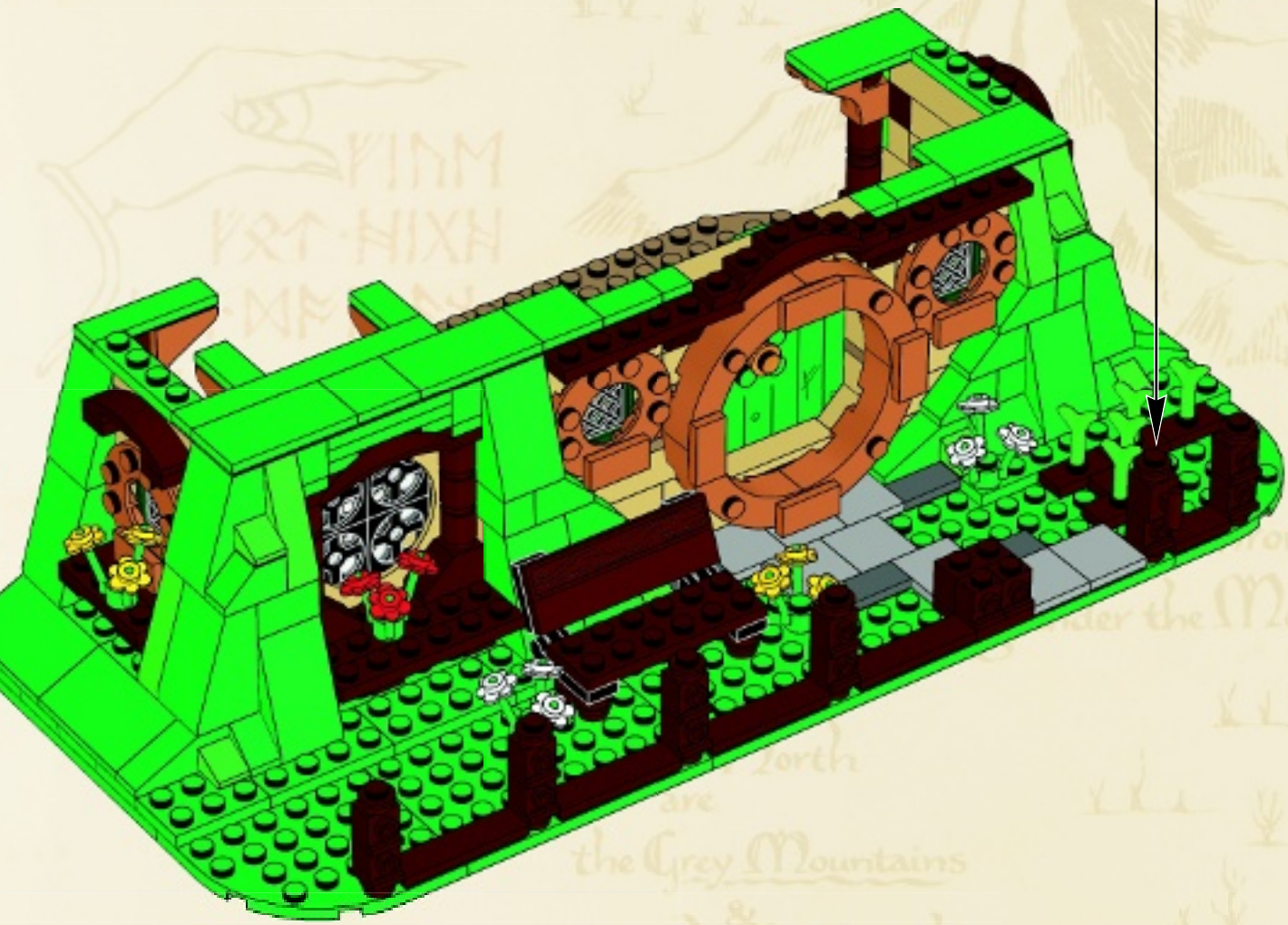
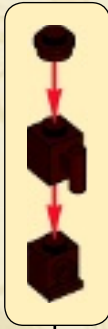



85

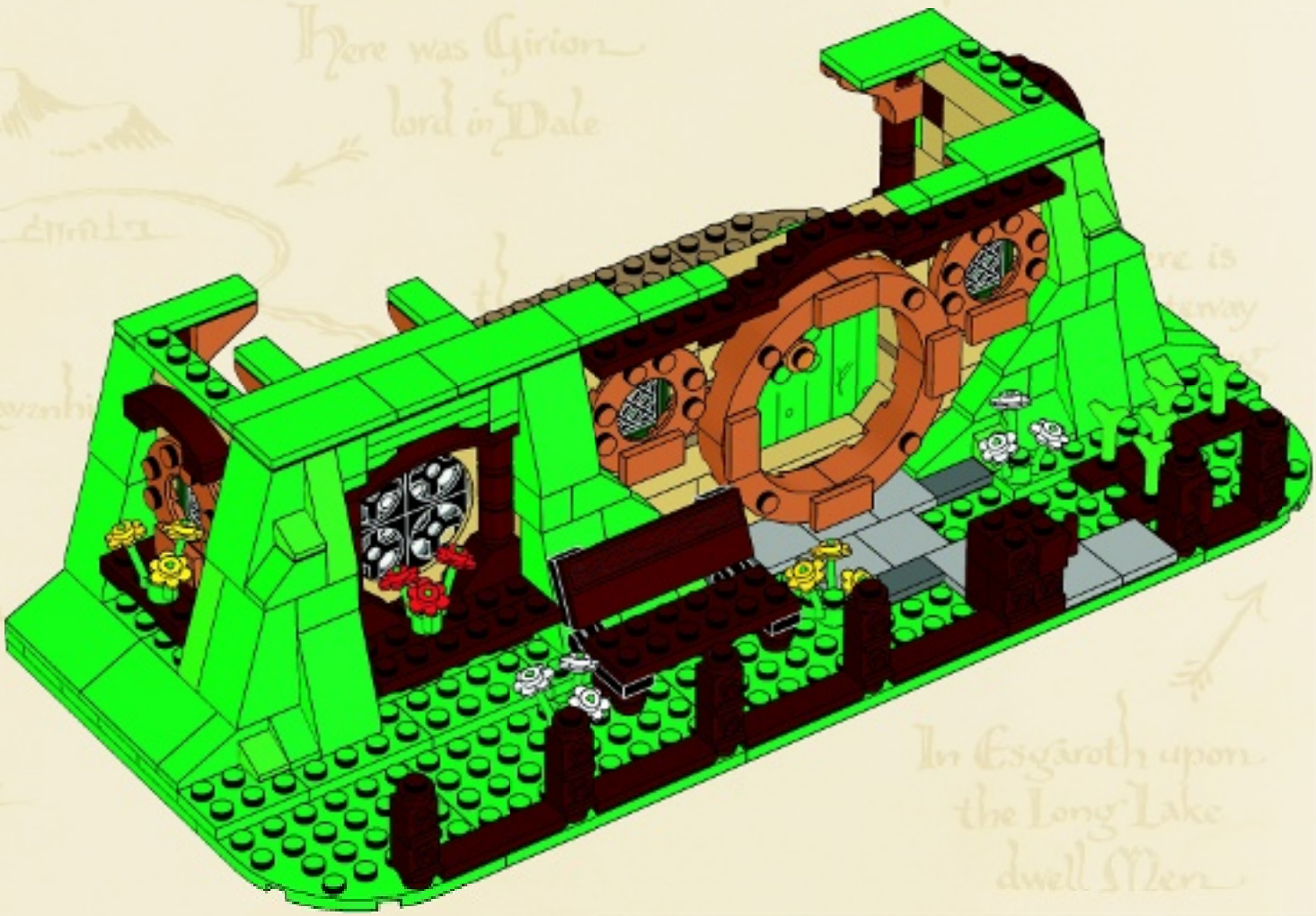

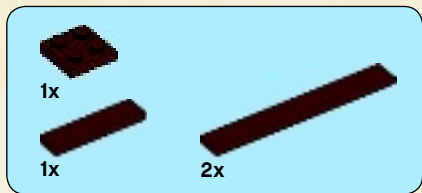

86

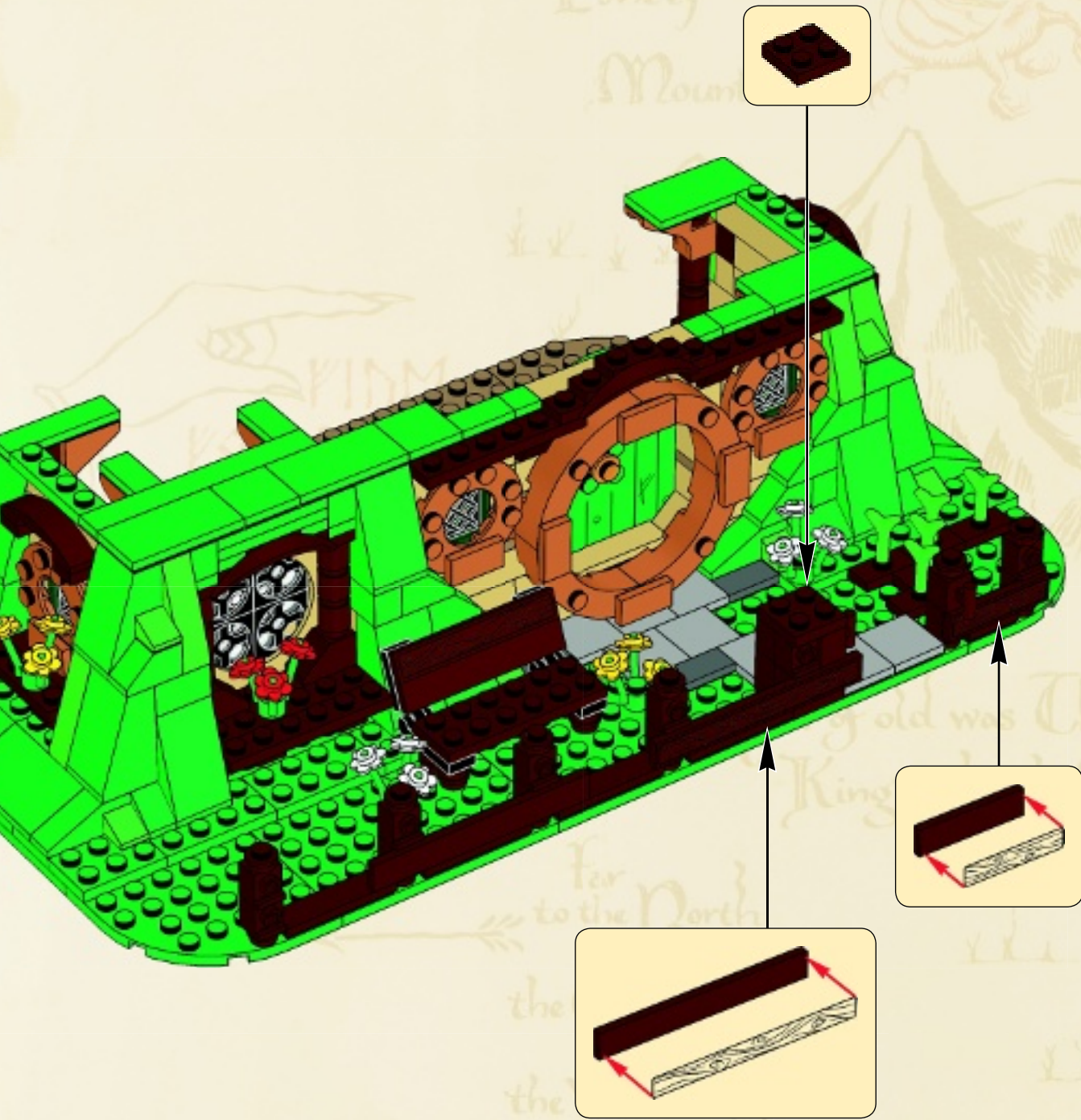

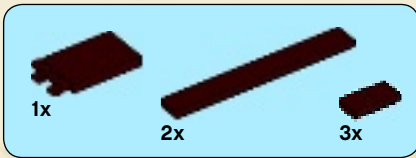

87

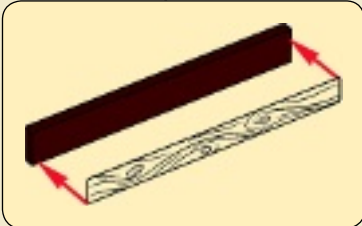
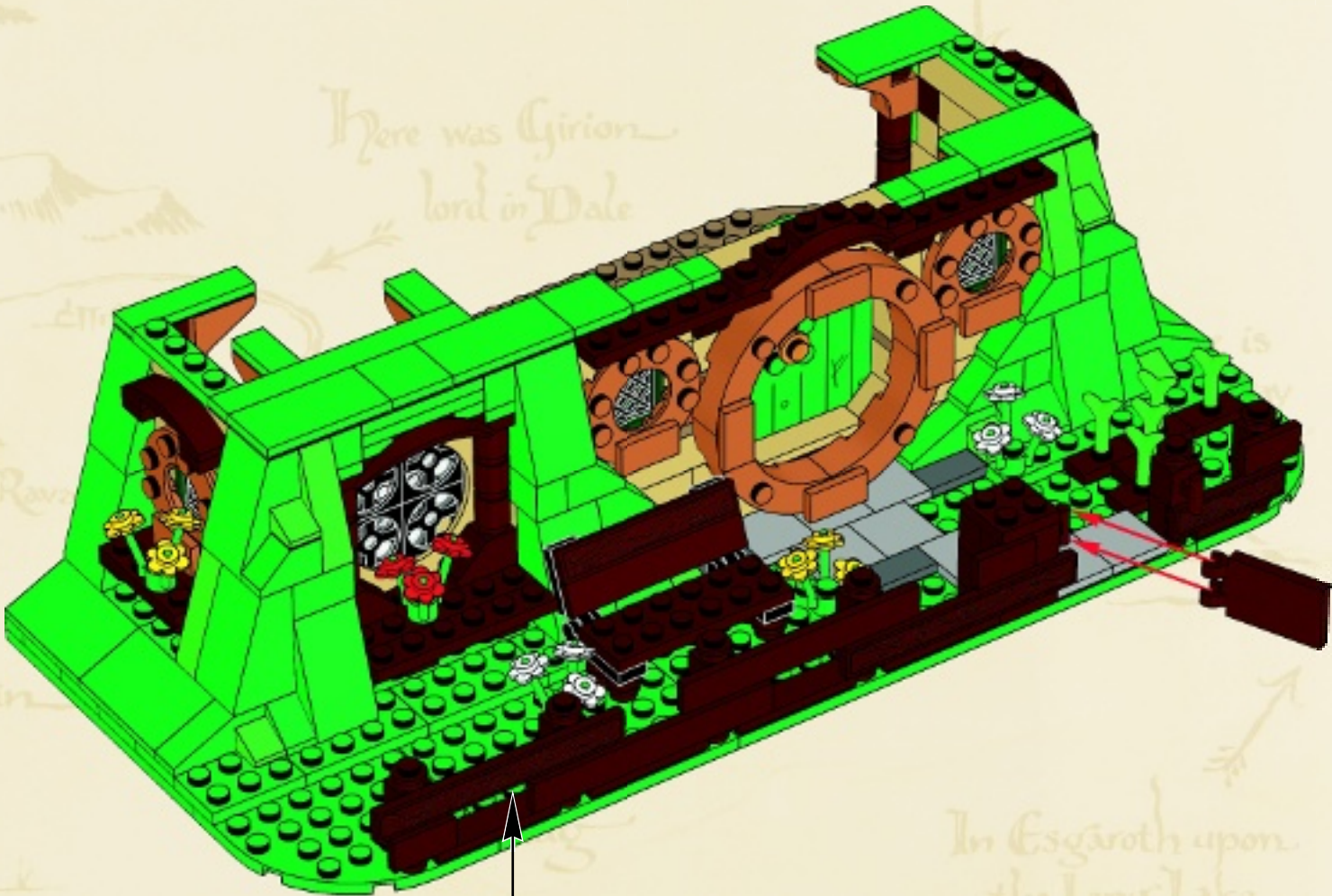

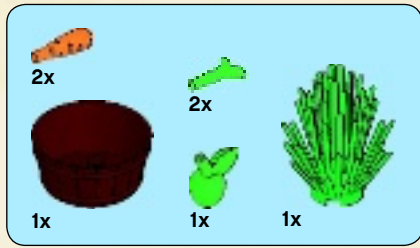

88

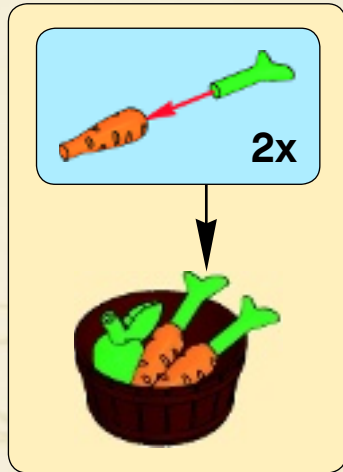

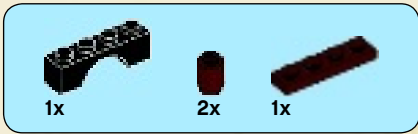

89

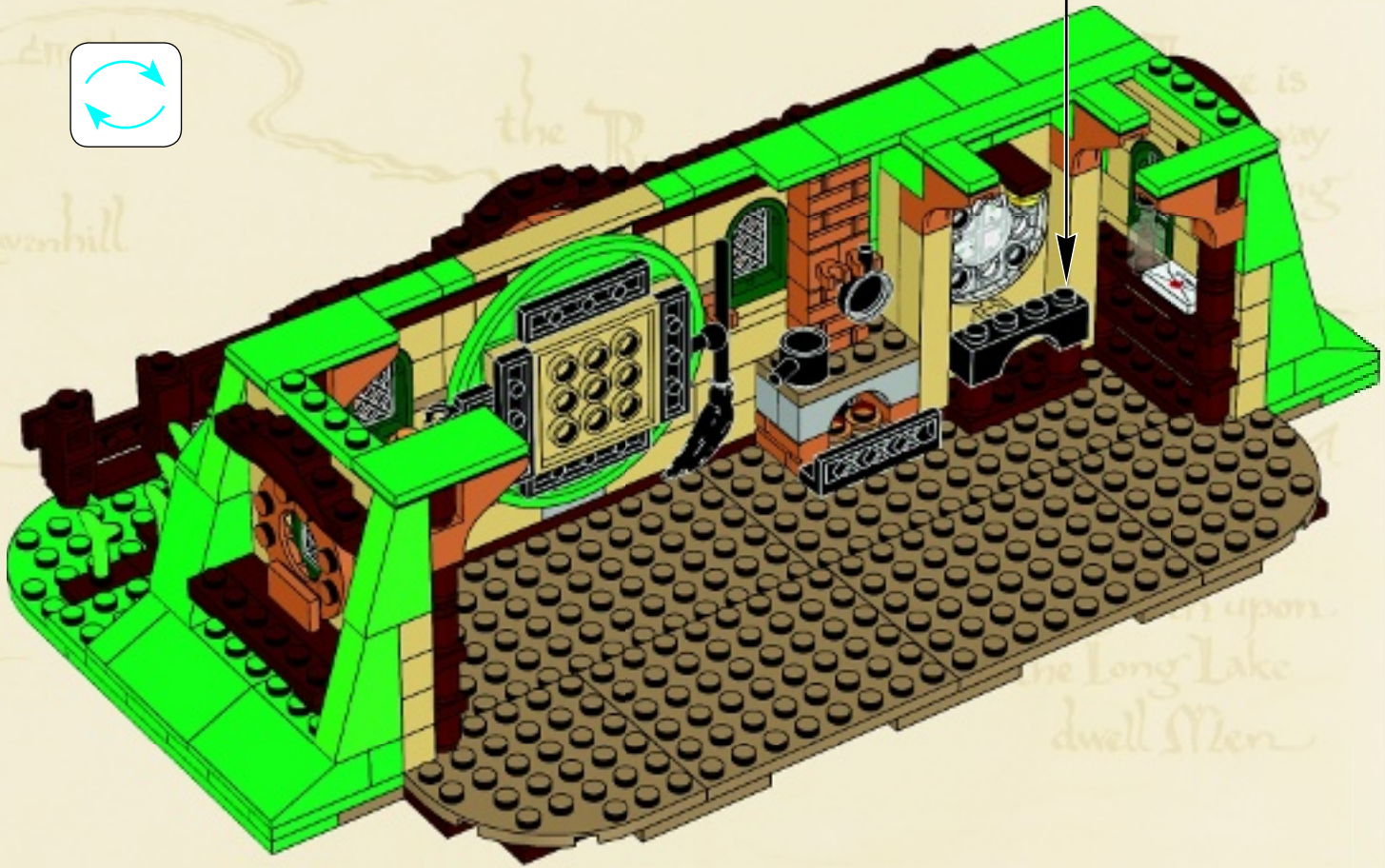
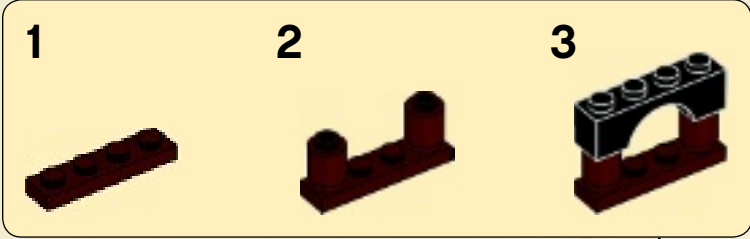

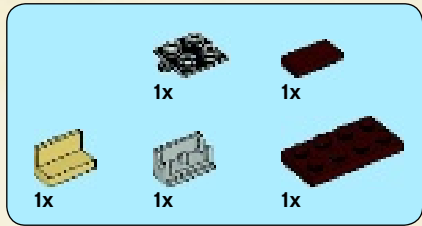

90

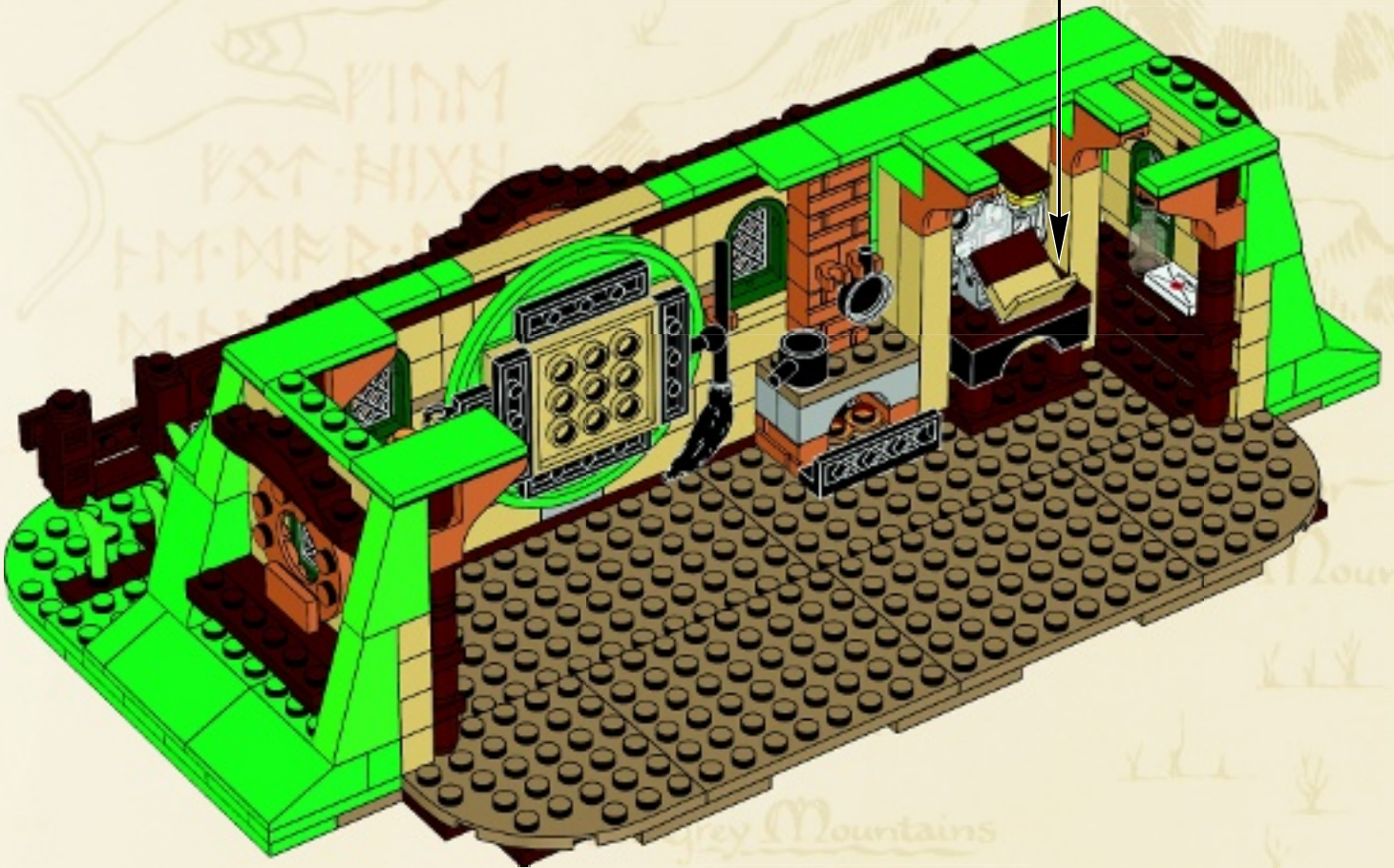
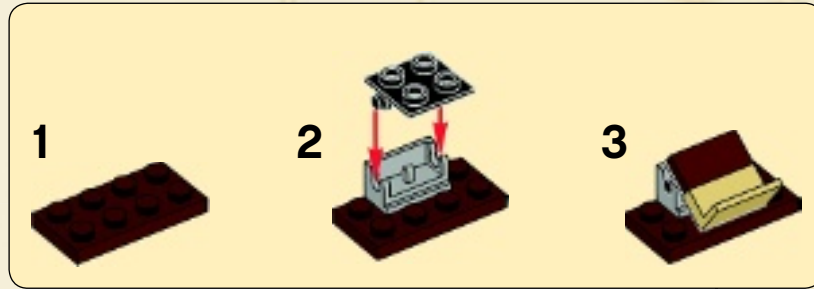



91

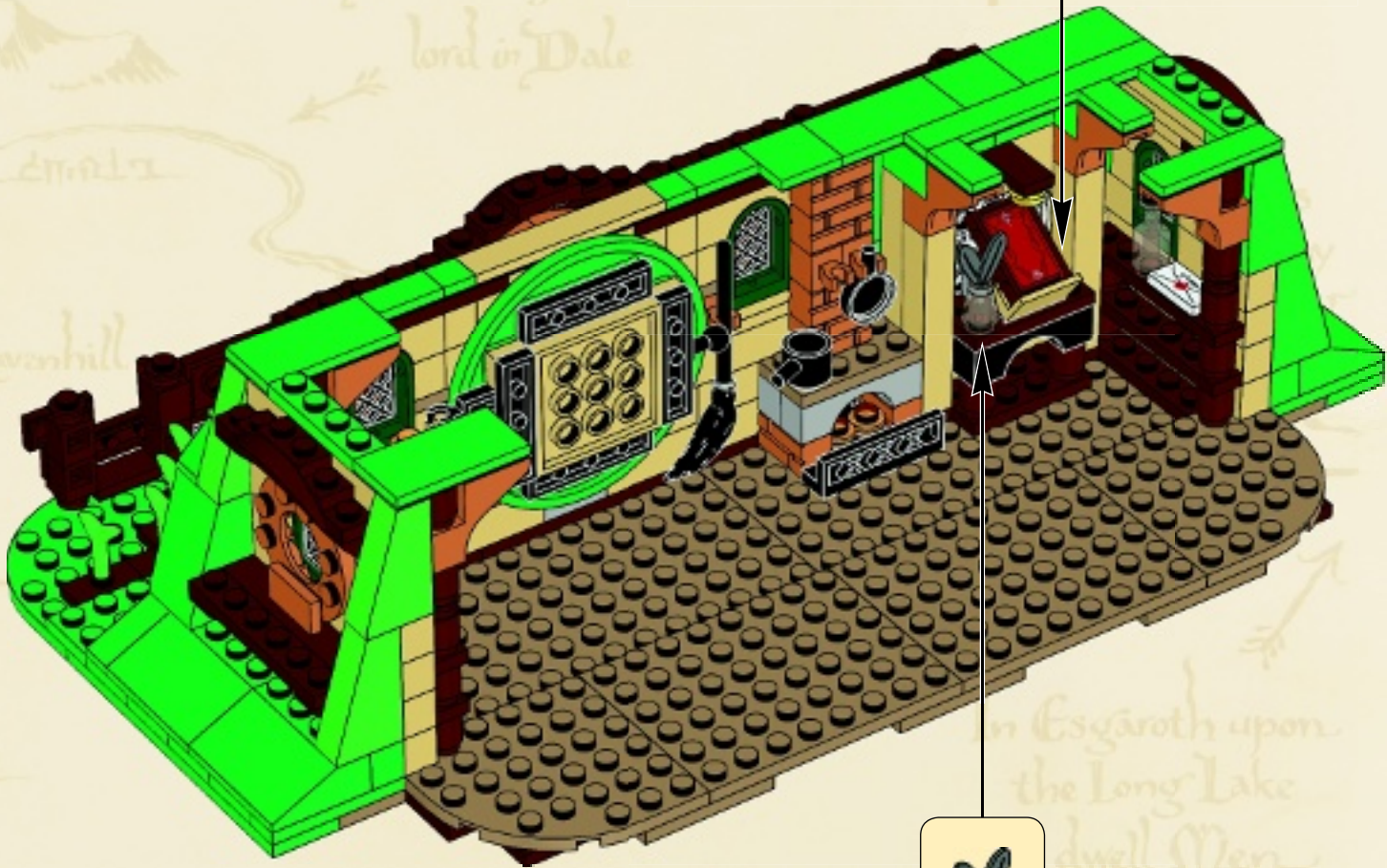
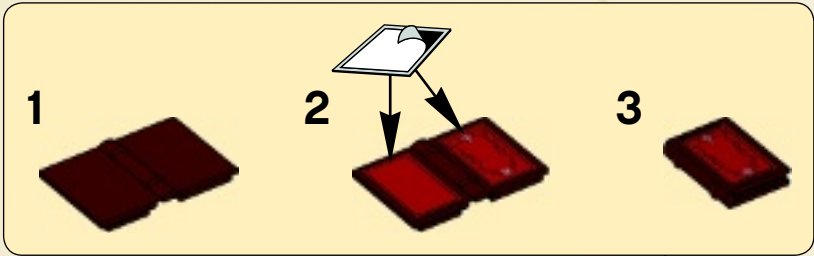

6x 4x 2x

92

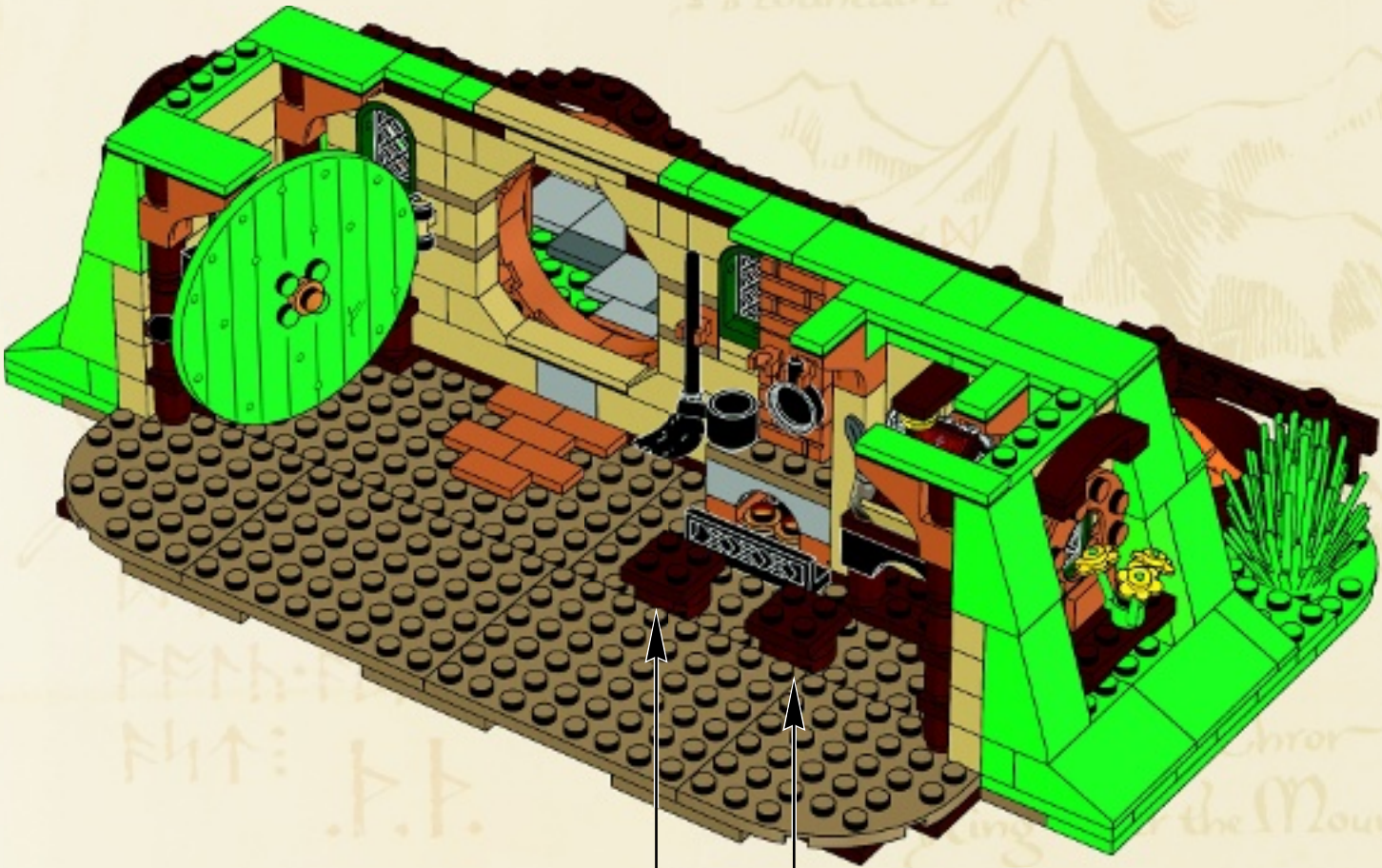

1 2

2x

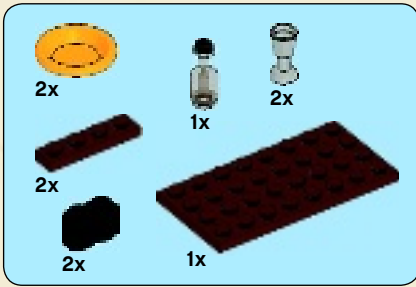

93

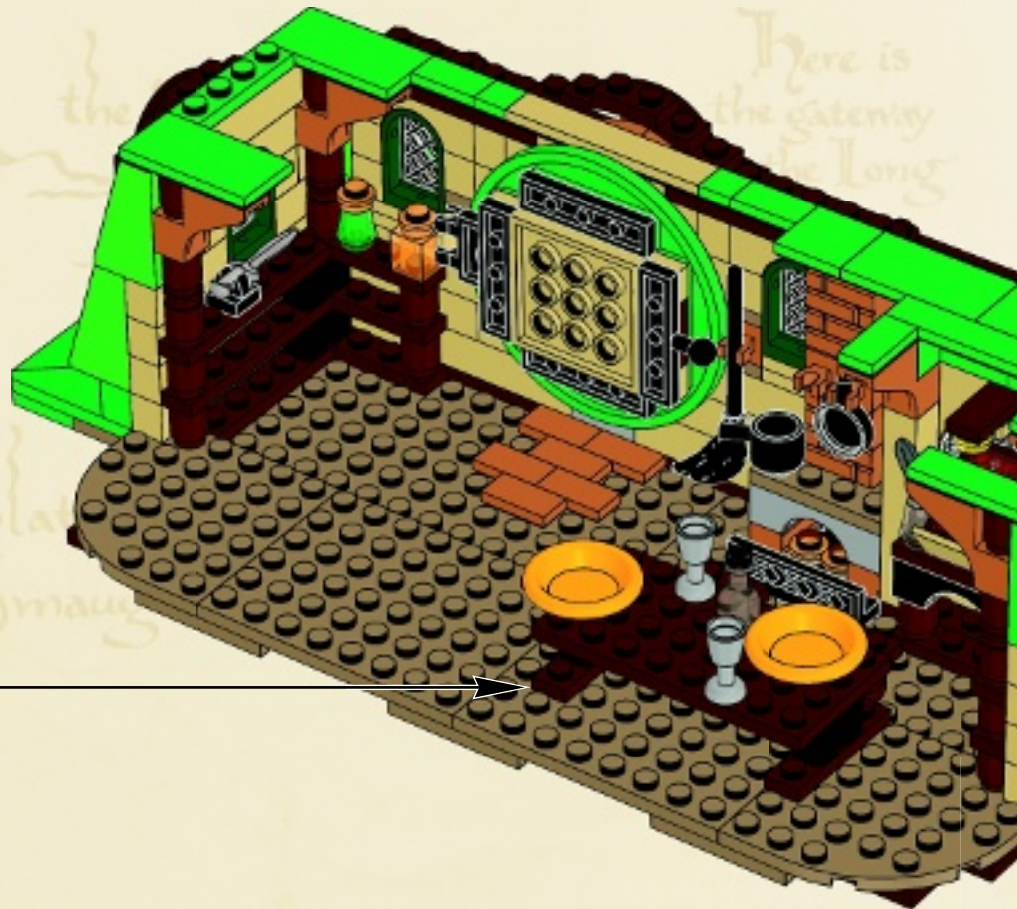
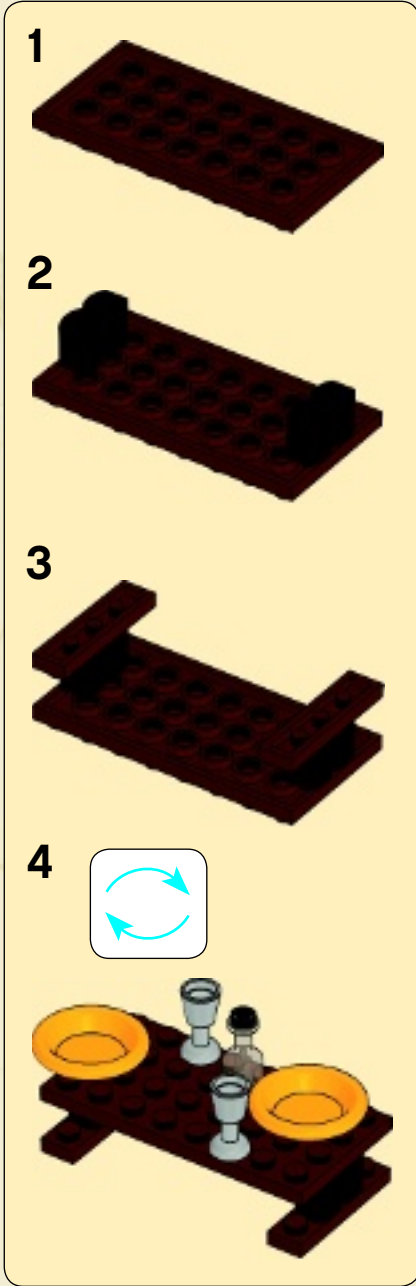

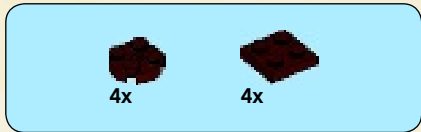

94

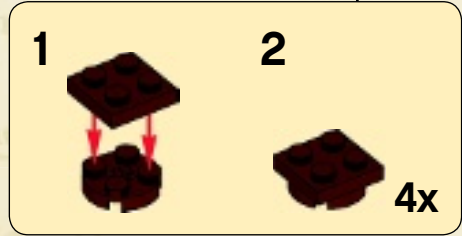
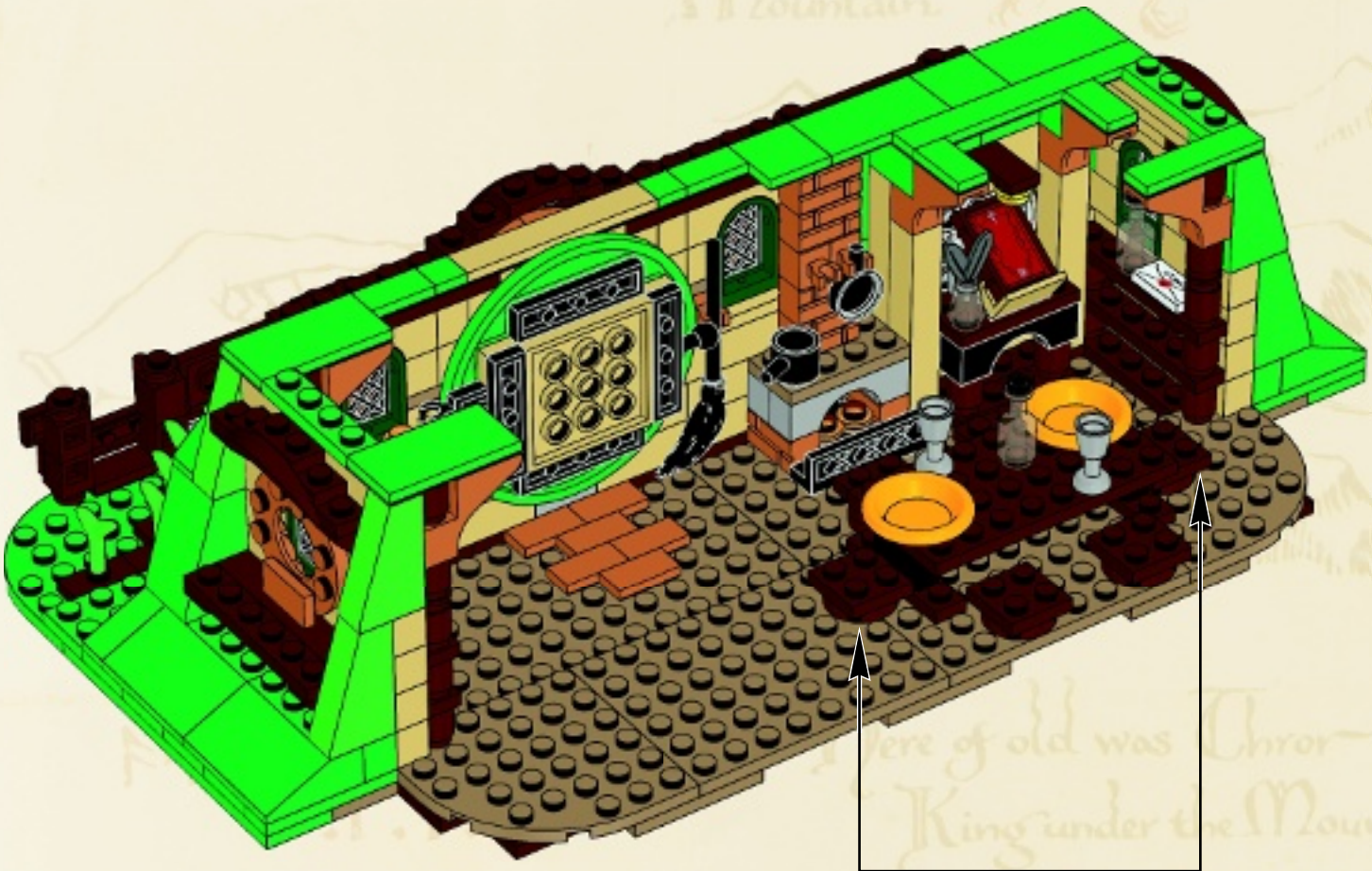

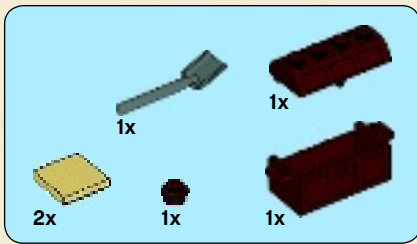

95

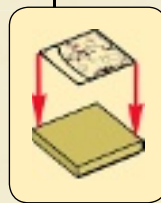
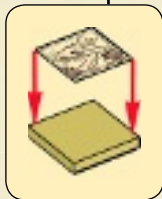
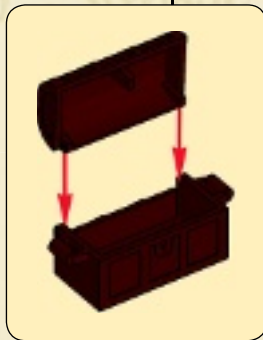
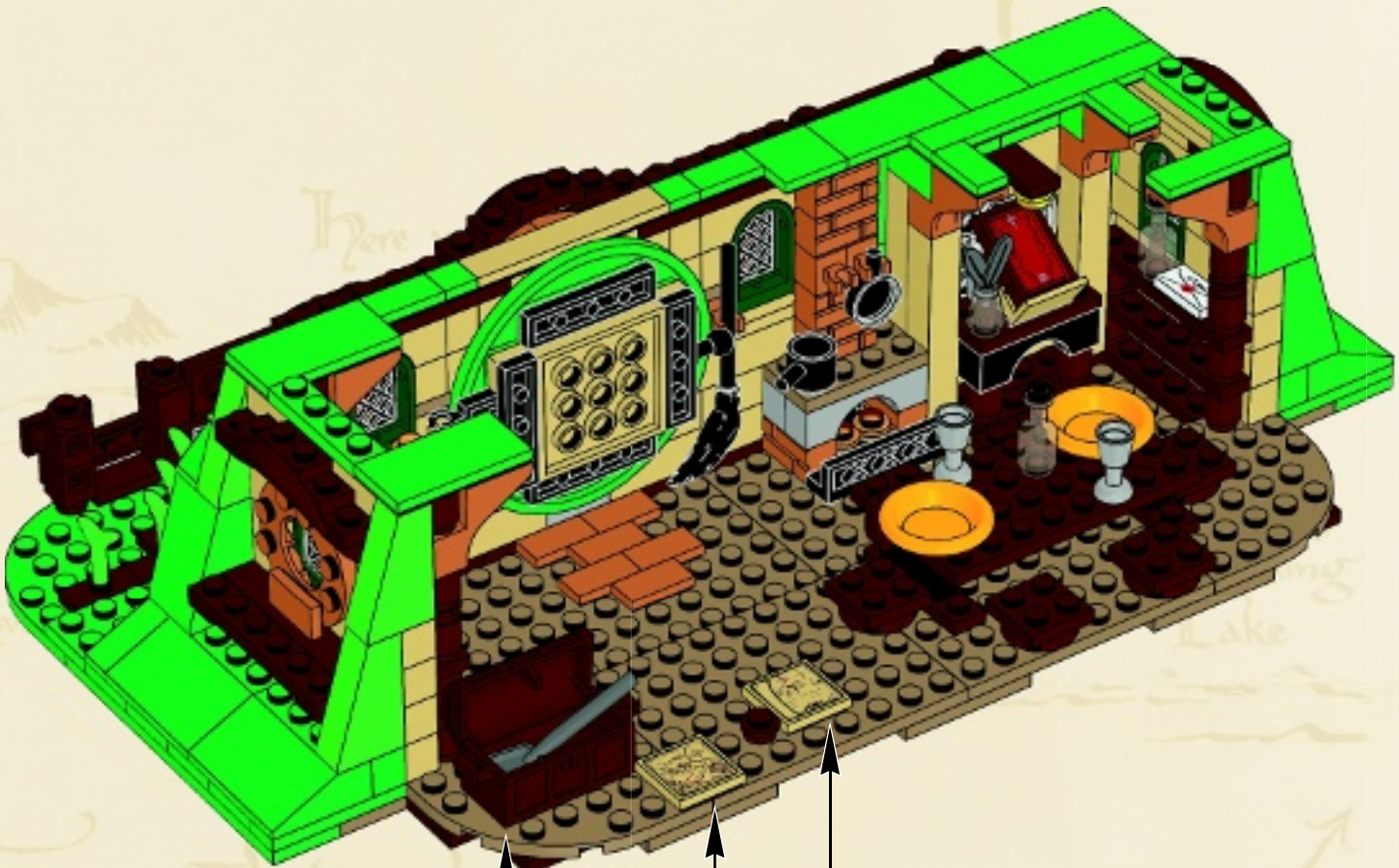

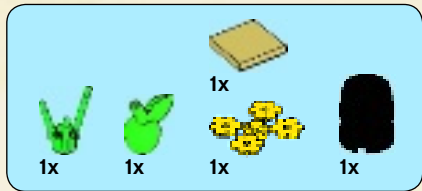

96

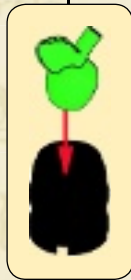
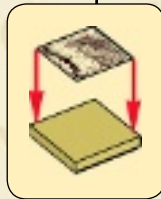
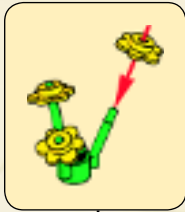

2x	2x	2x	1x	1x

97

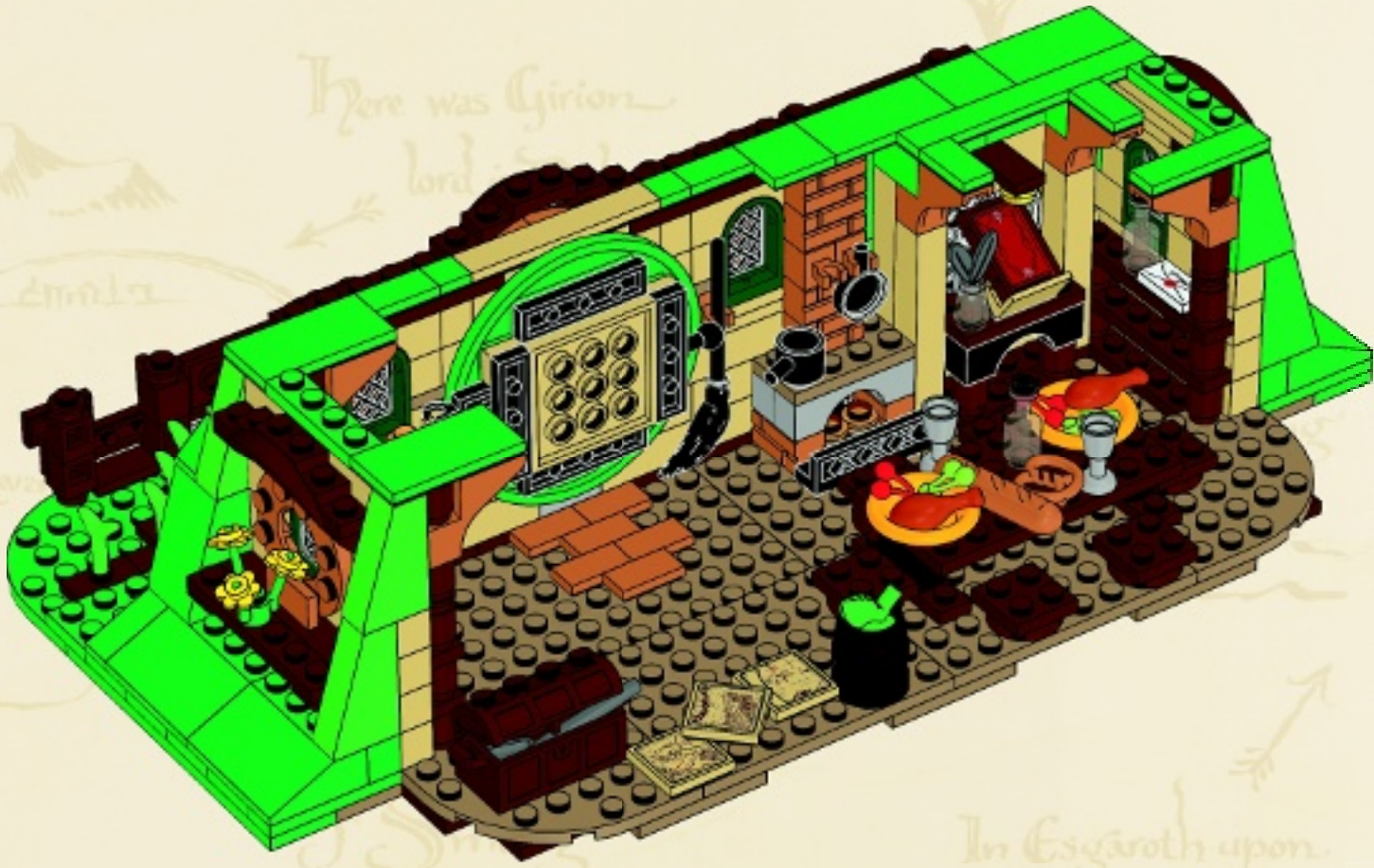

In Esgaroth upon
the Long Lake
dwell Men

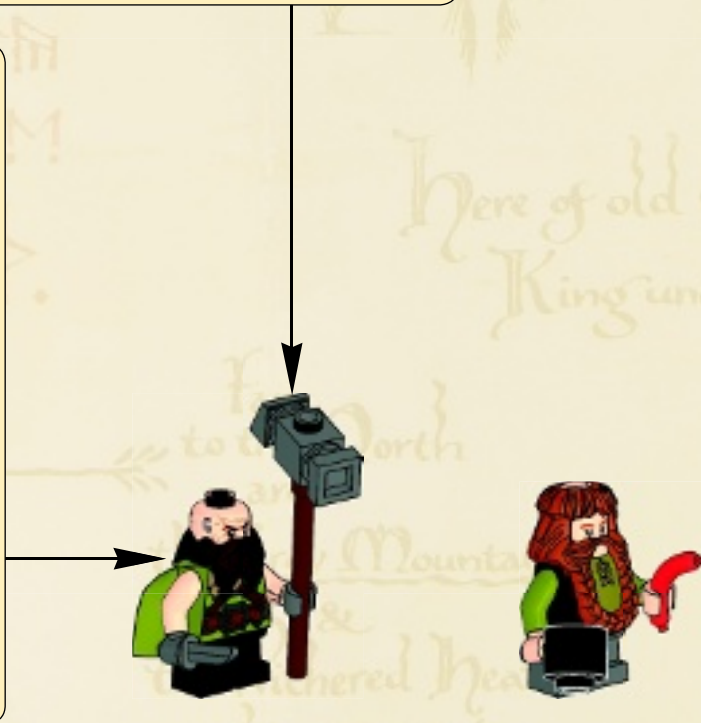
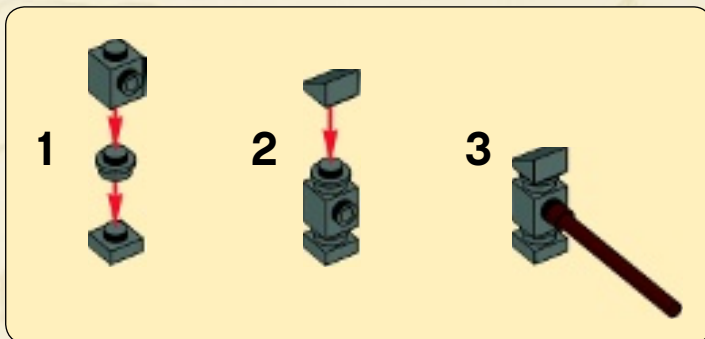
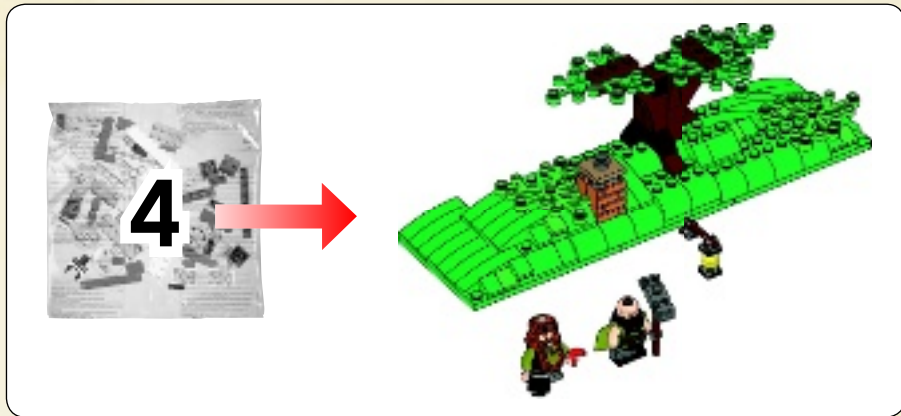

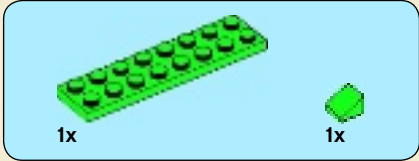
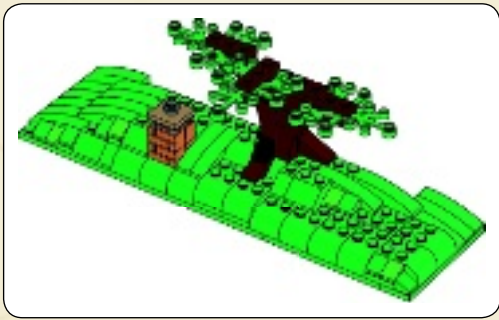

1

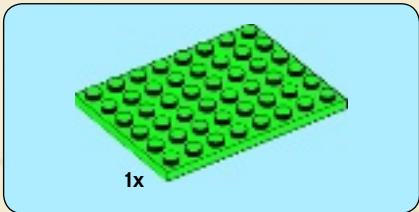
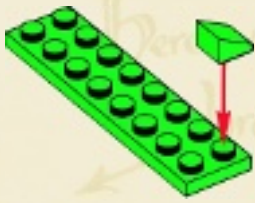

2



3

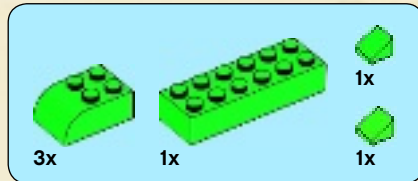
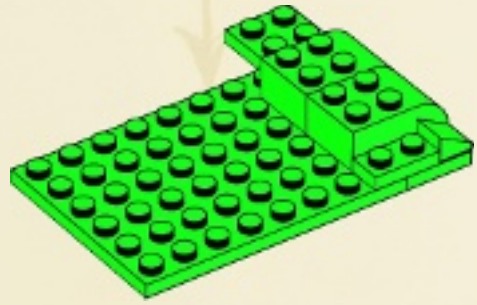

4

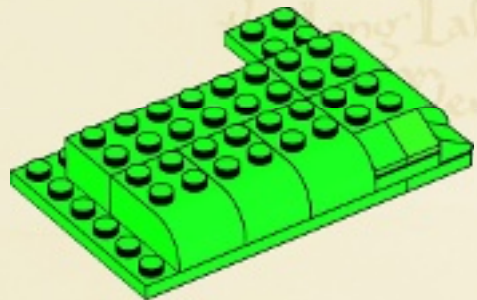

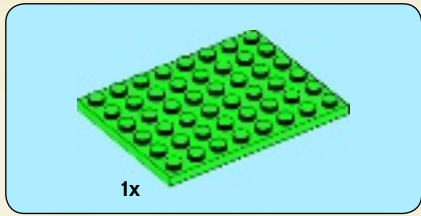

5

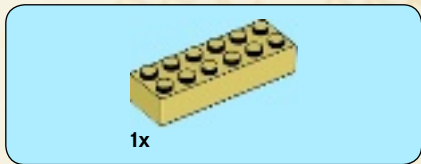
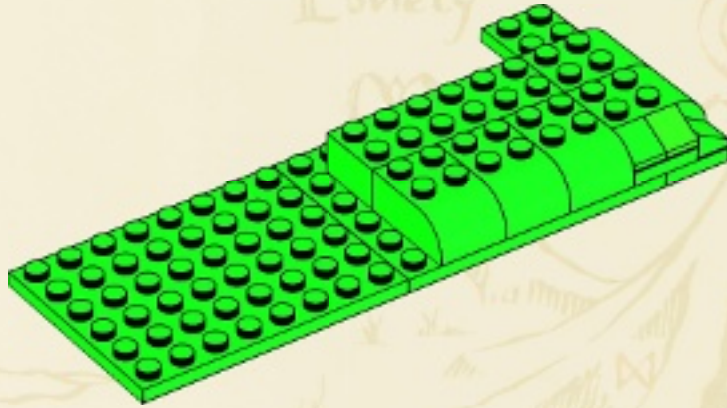

6

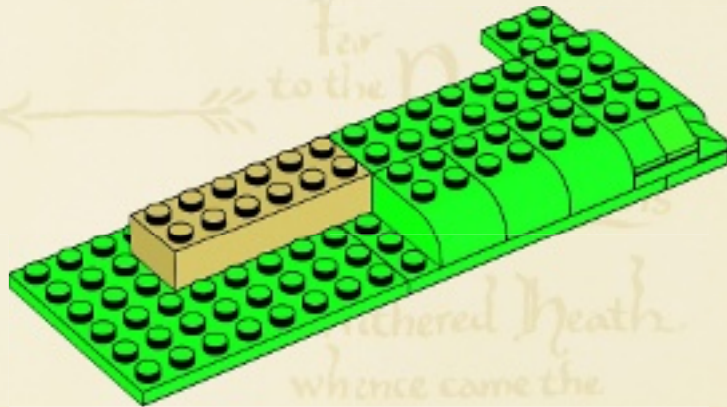



7

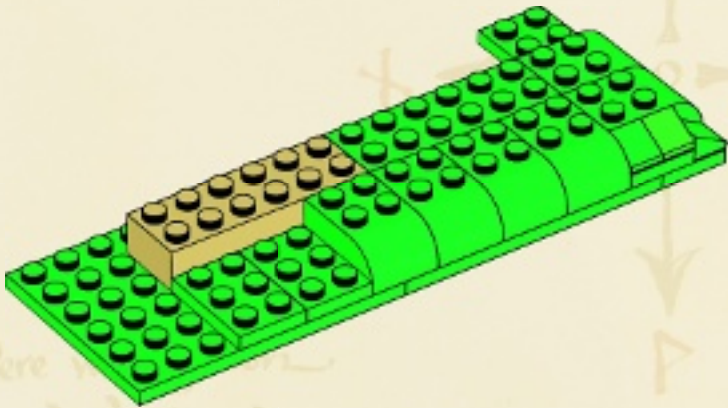

8

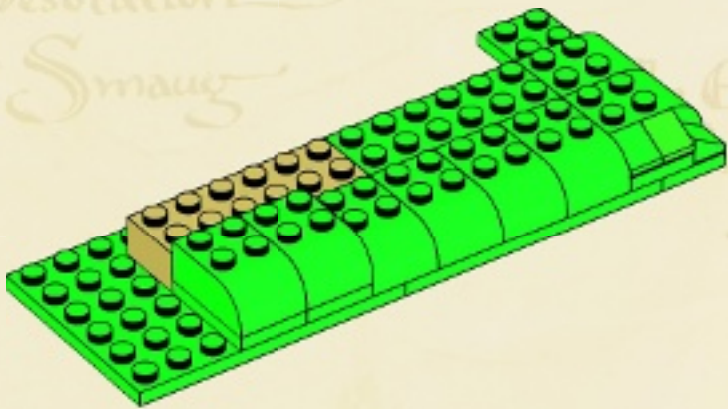

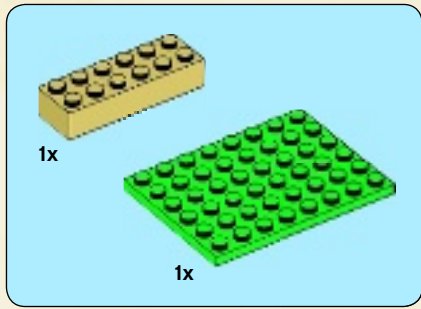

9

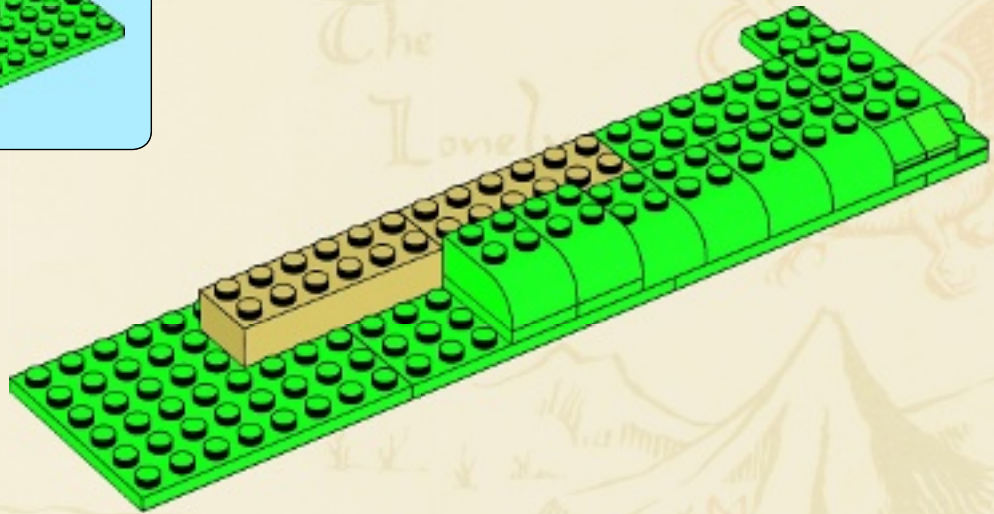

10

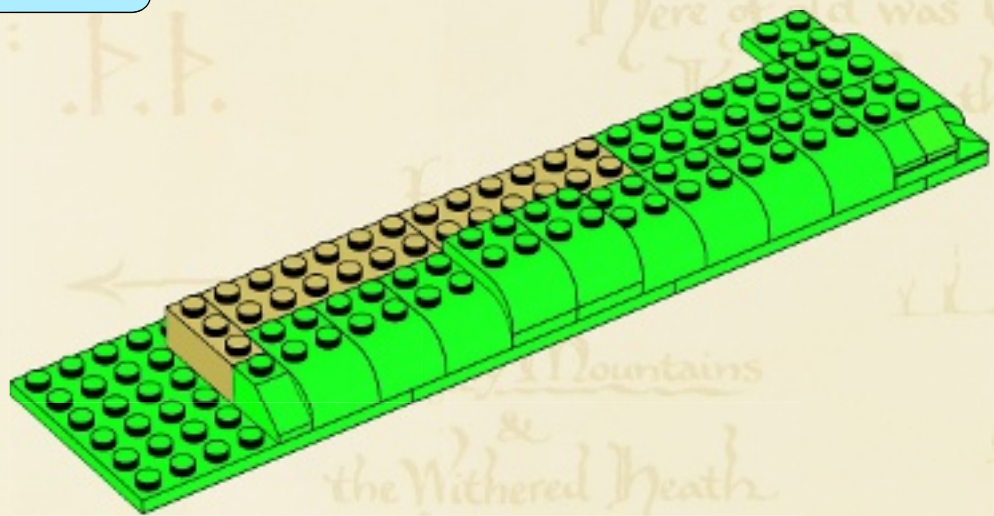

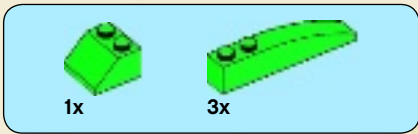

11

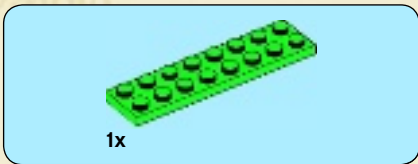
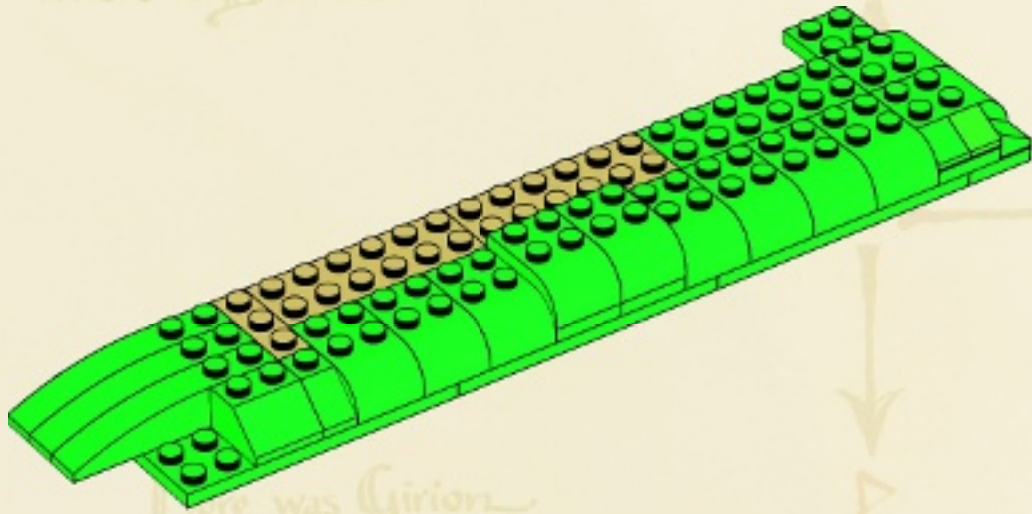

12

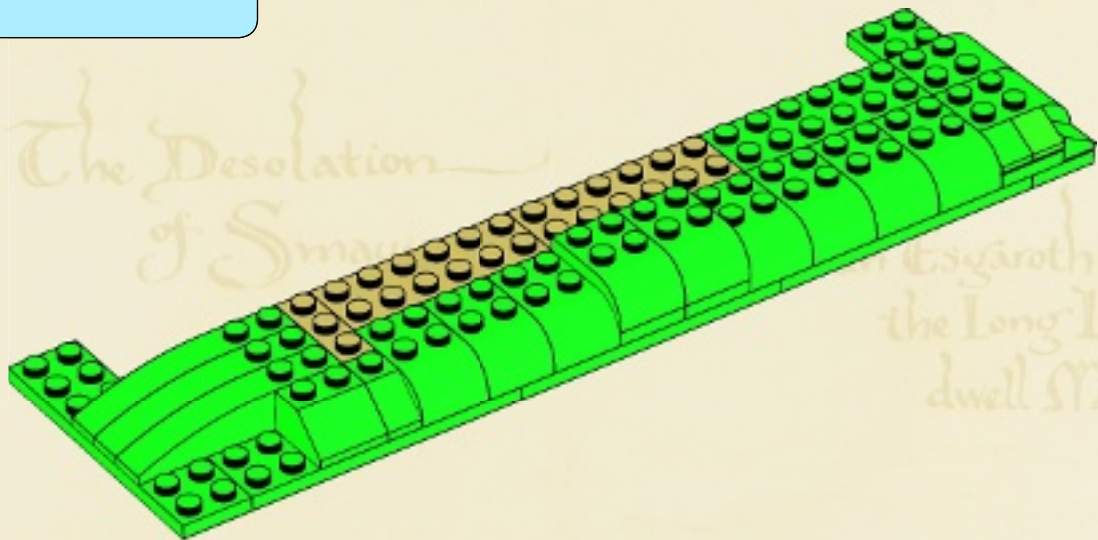



13

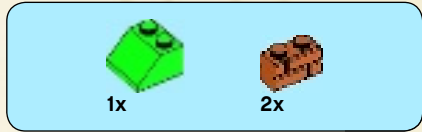
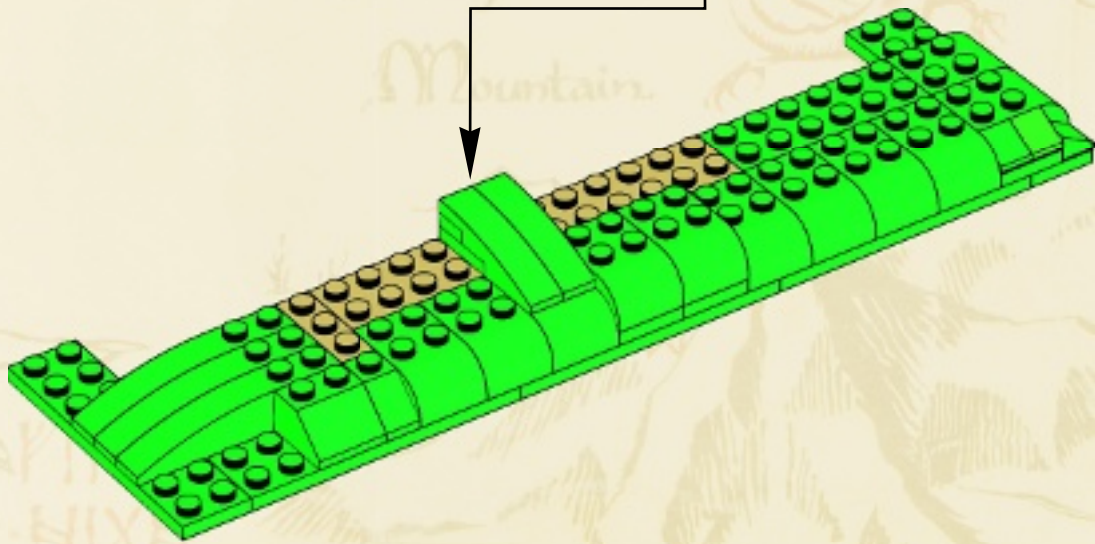
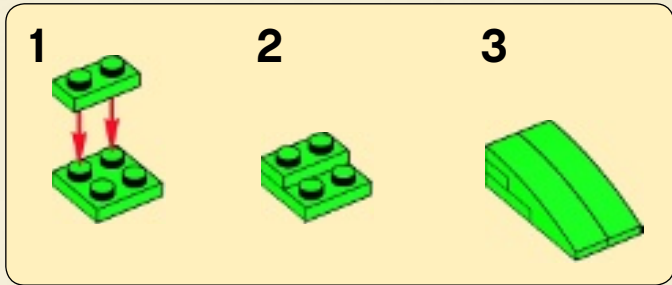

14

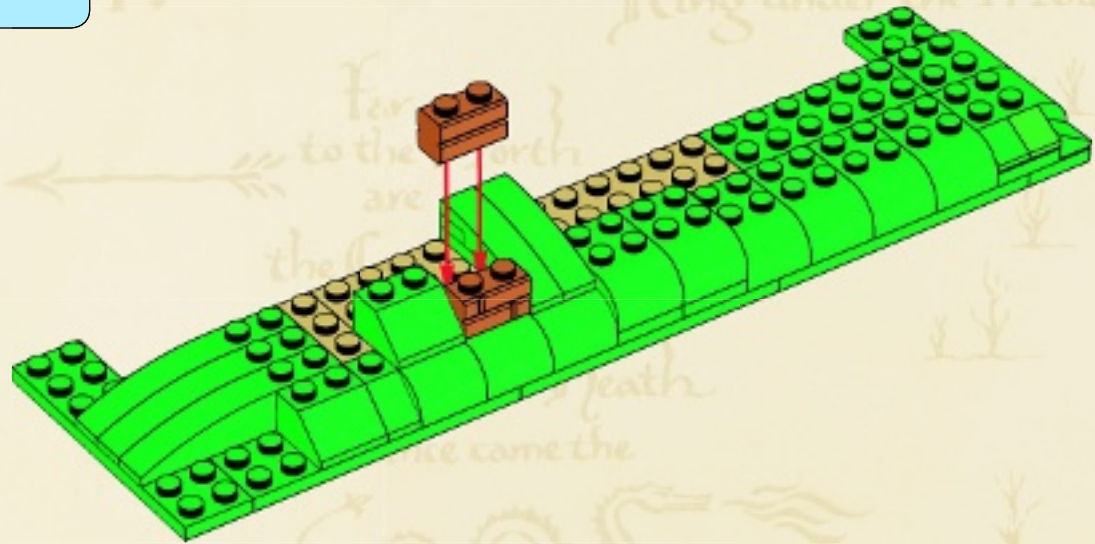



15

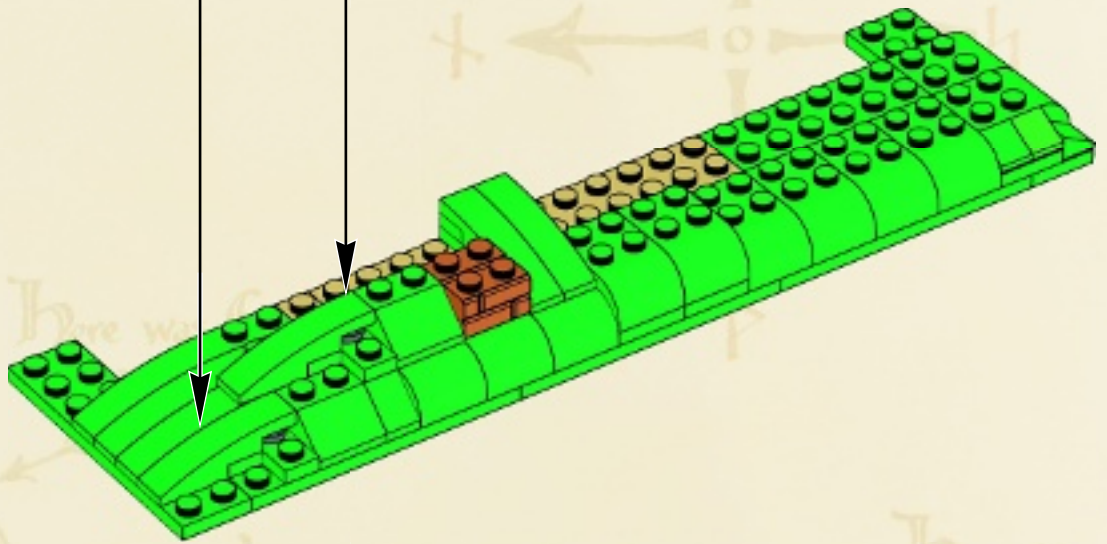

16

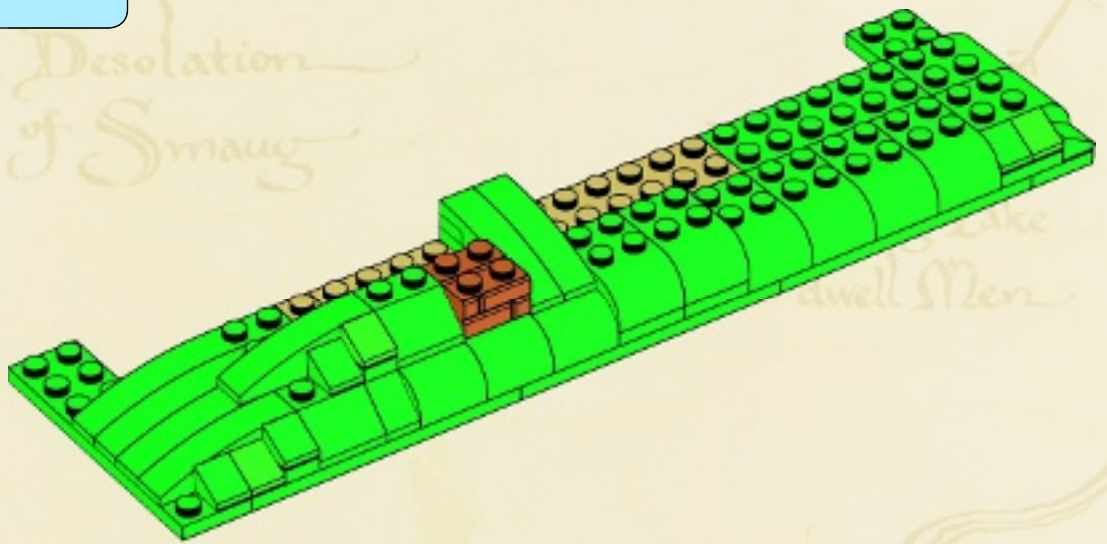



17

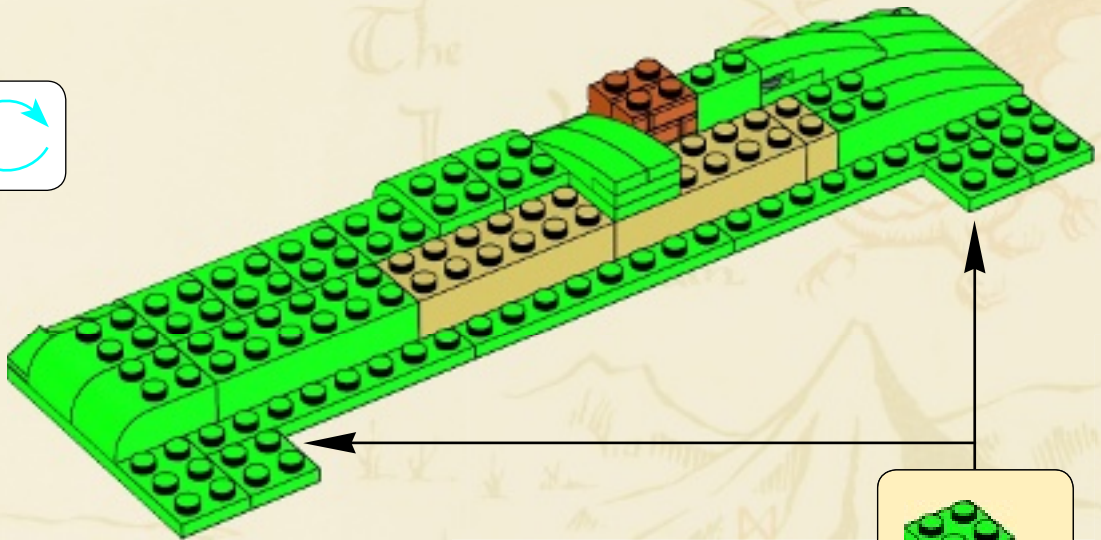
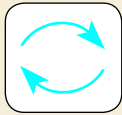

18

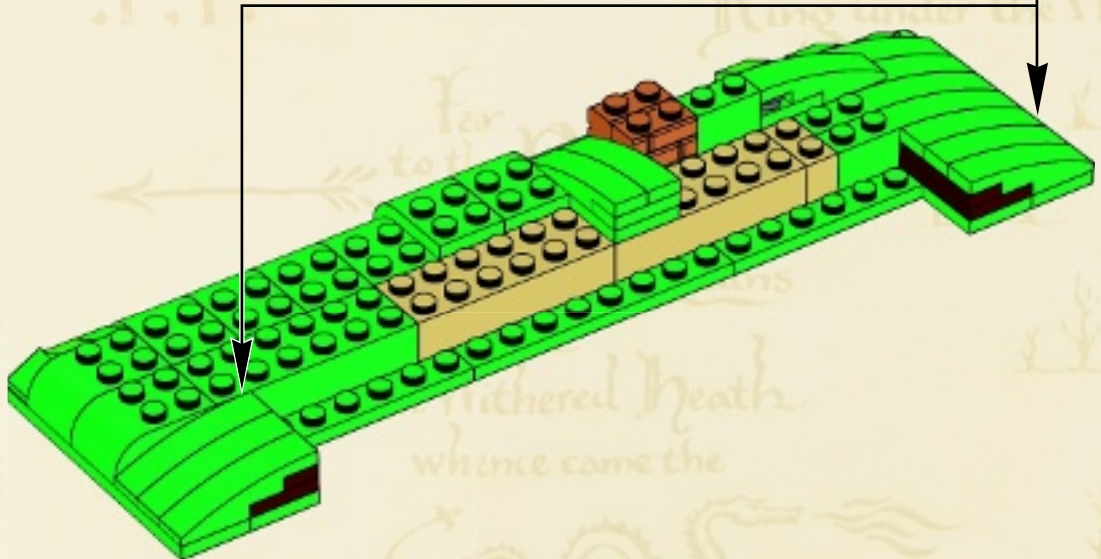

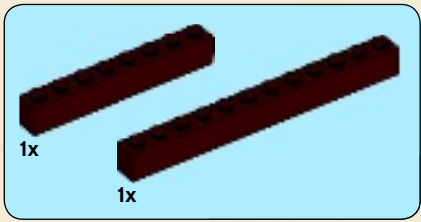

19

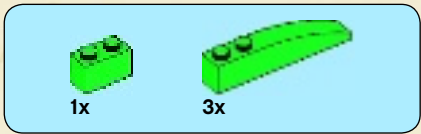
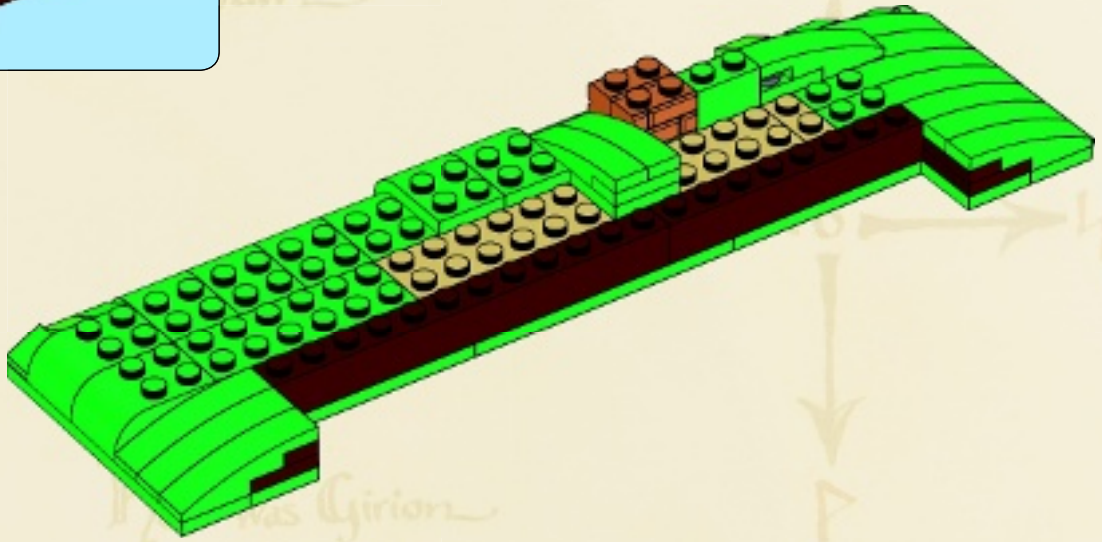

20

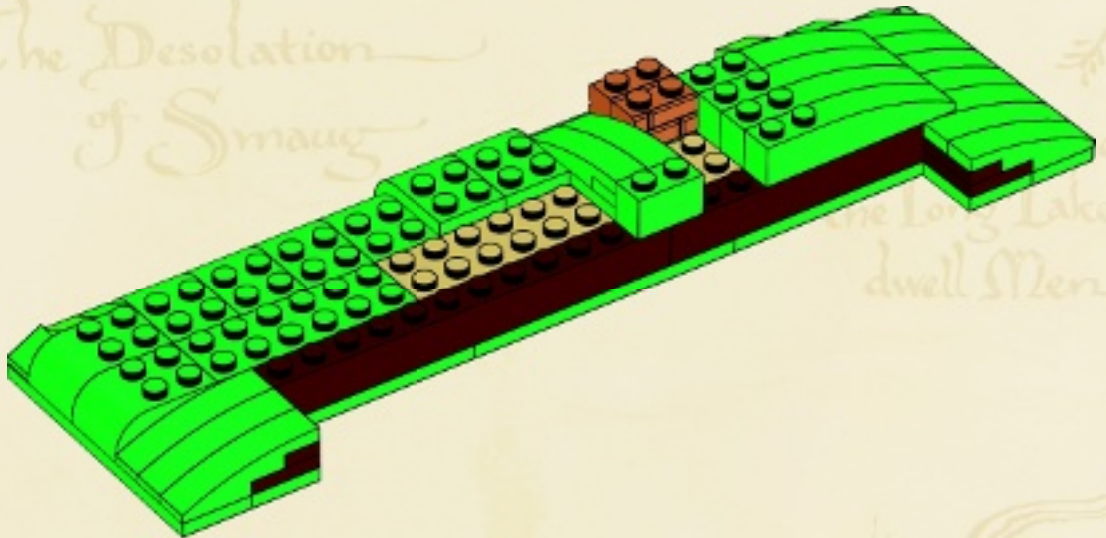



21

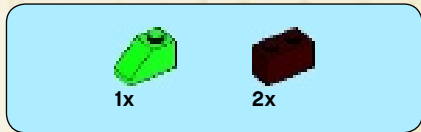
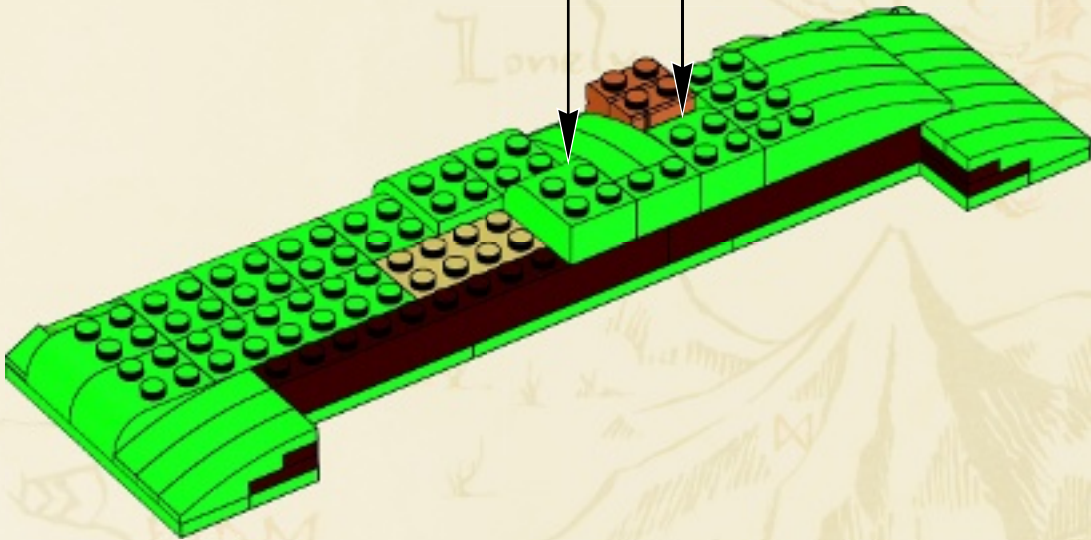
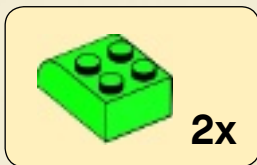

22

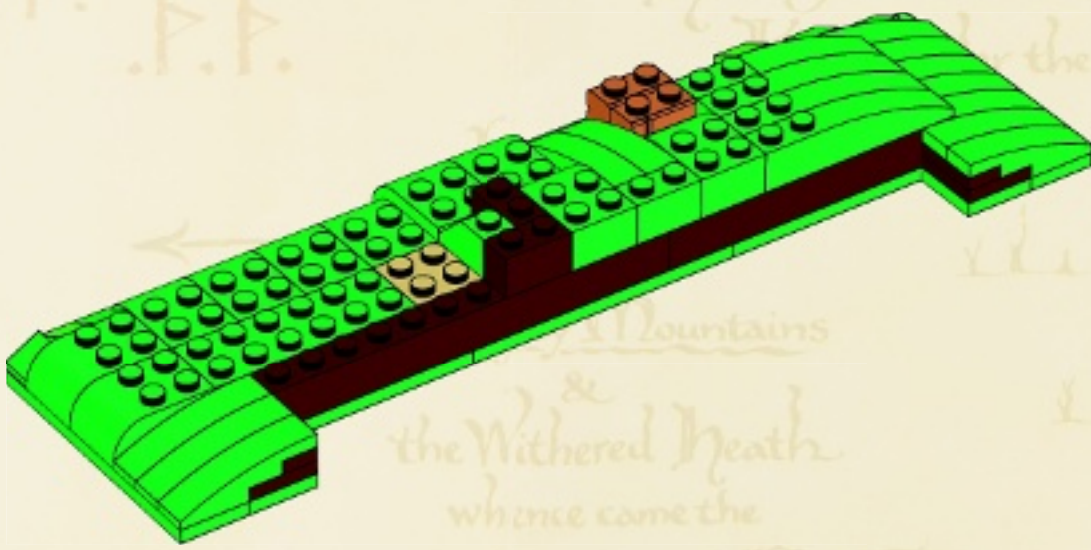

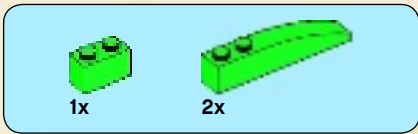

23

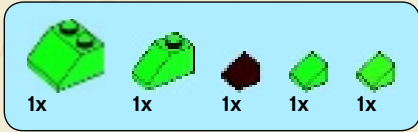
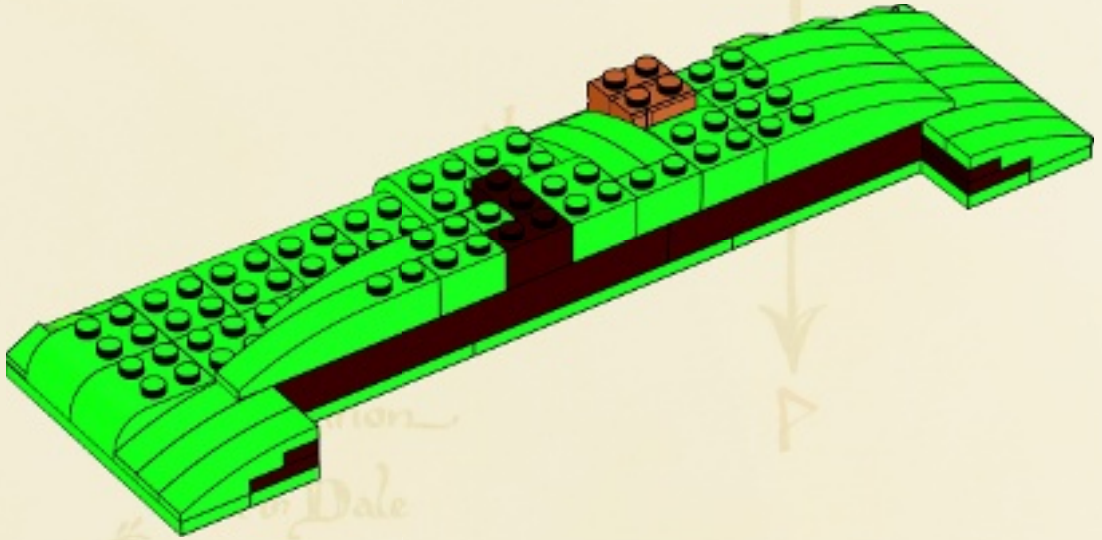

24

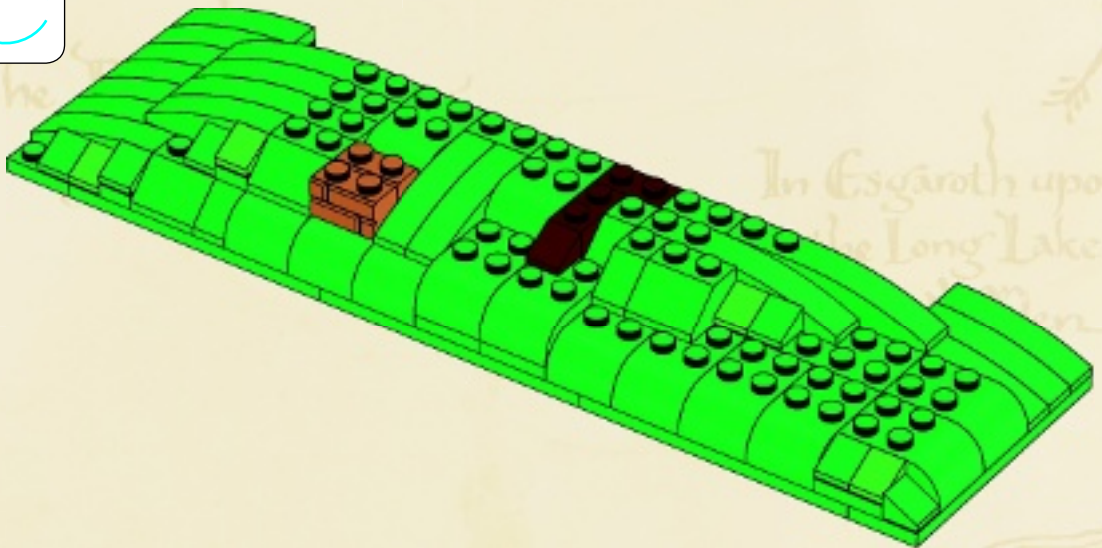



25

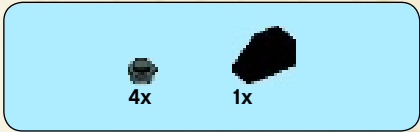
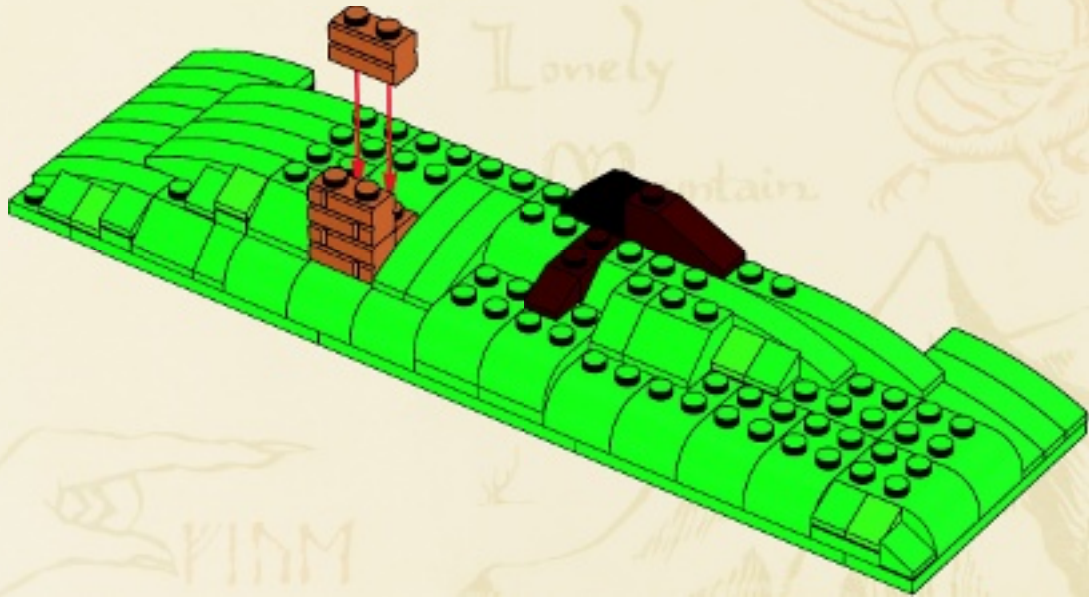

26

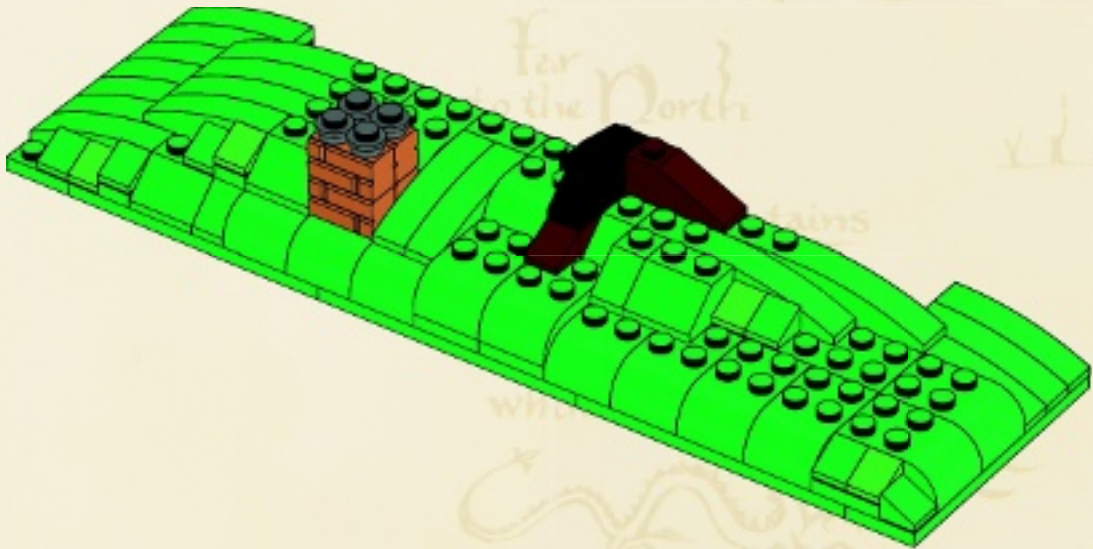

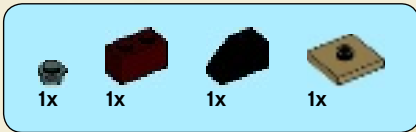

27

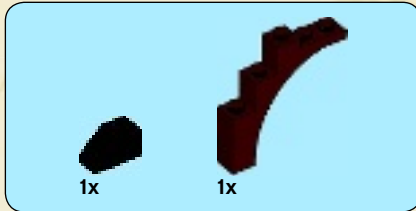
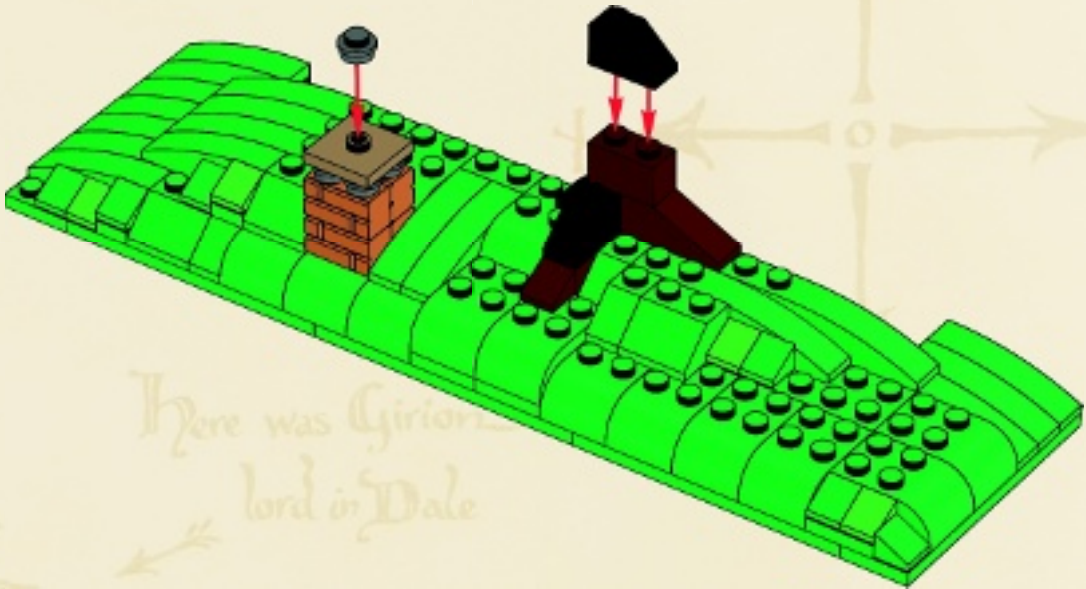

28

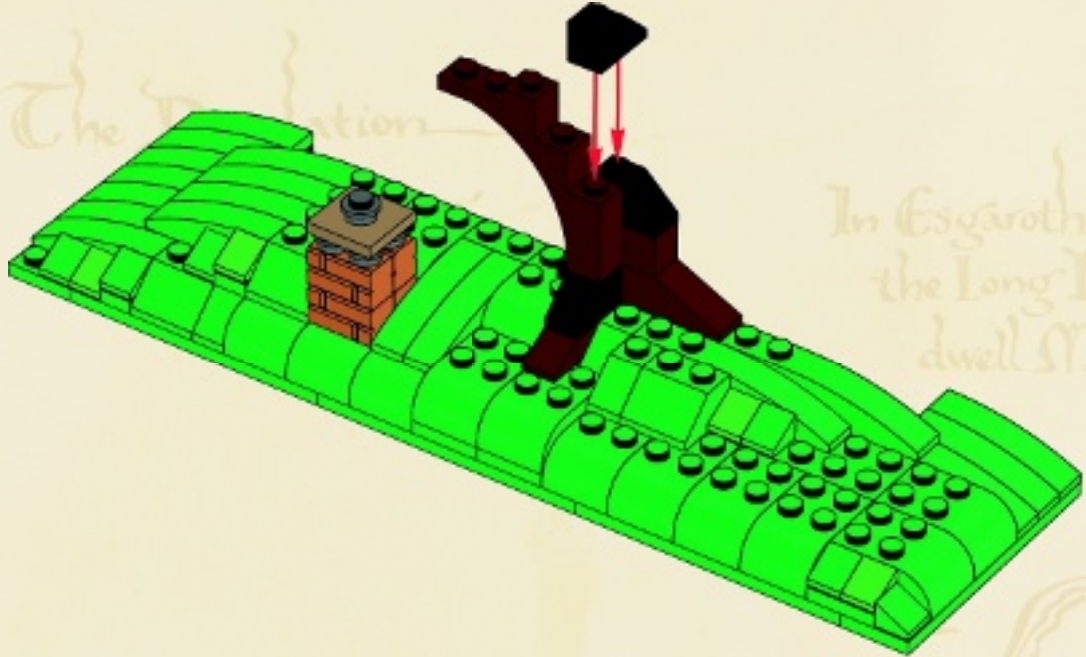

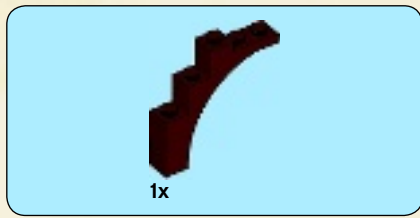

29

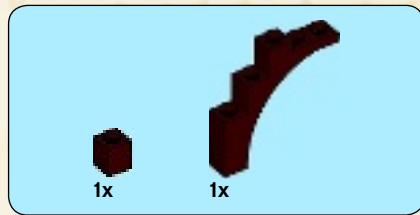
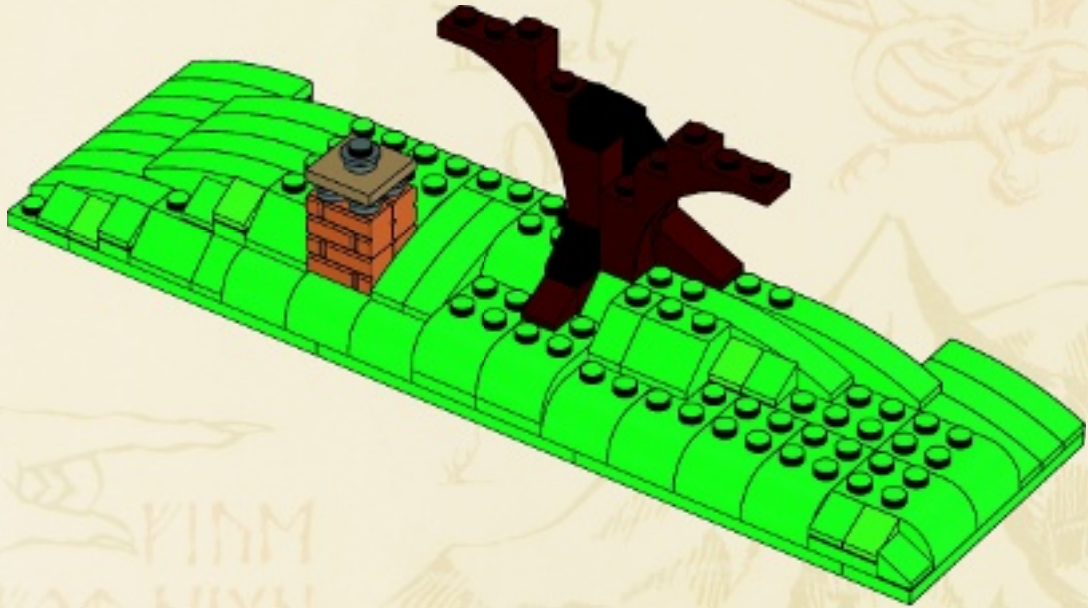

30

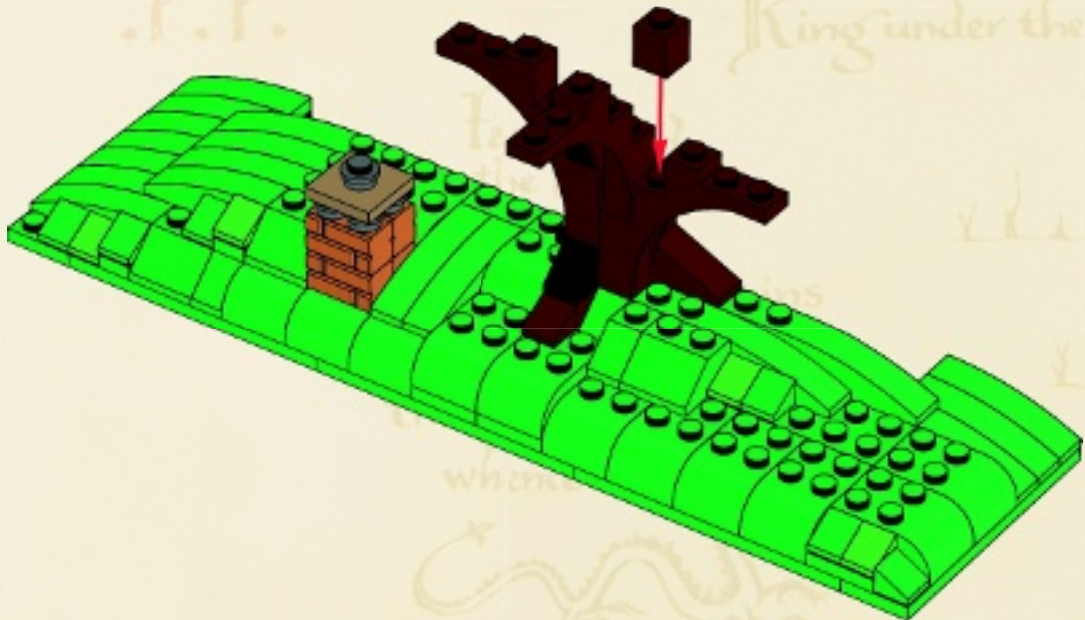



31

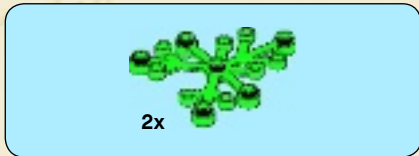
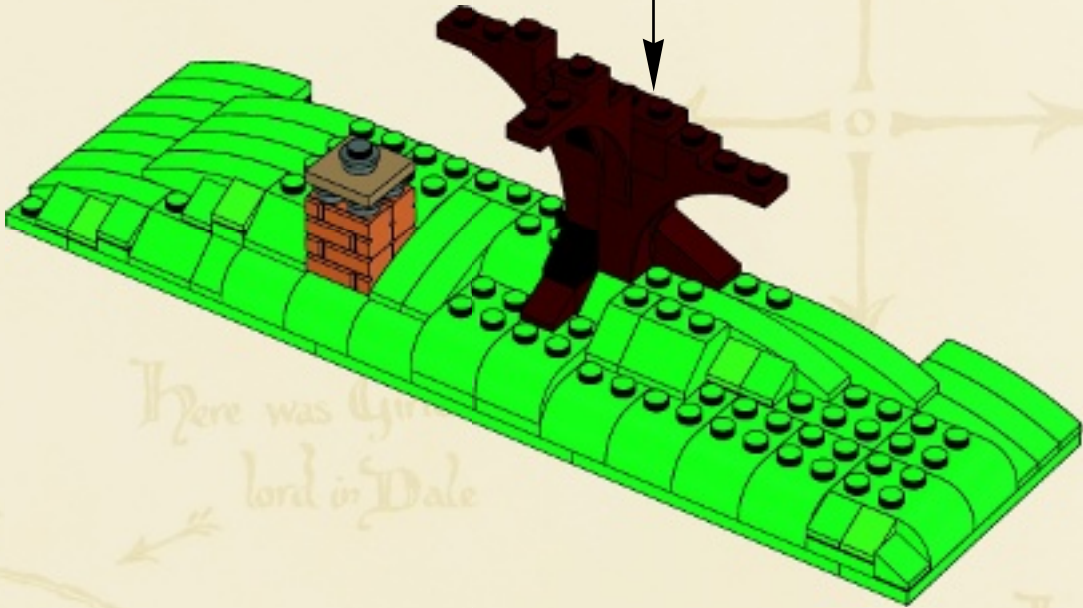
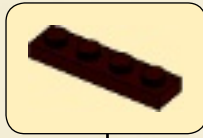

32

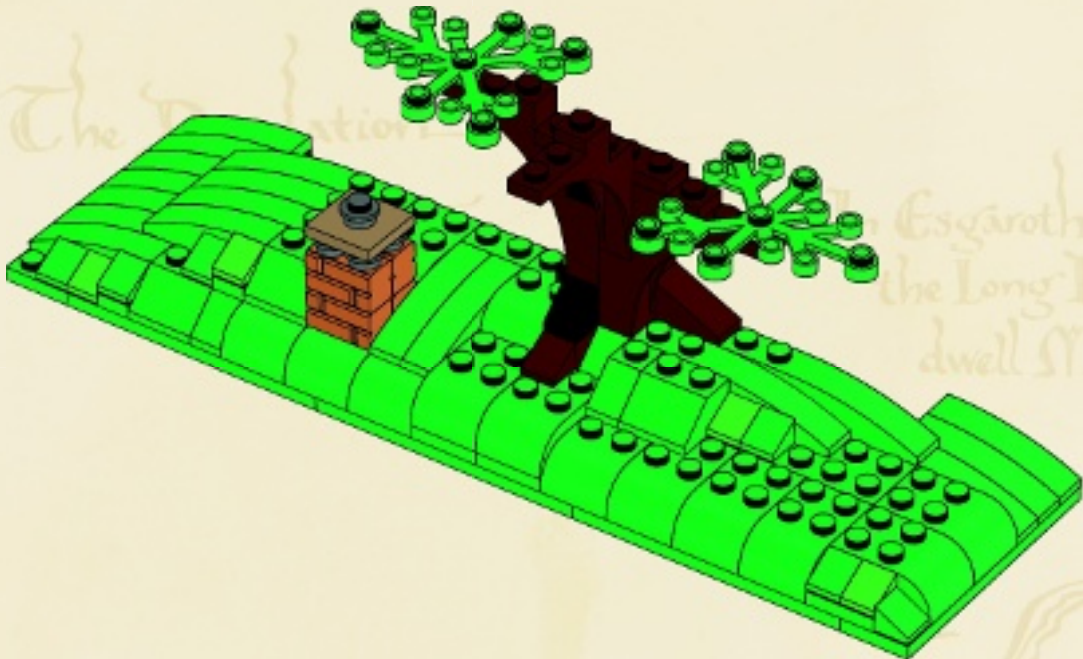

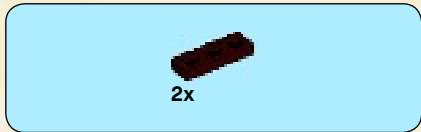

33

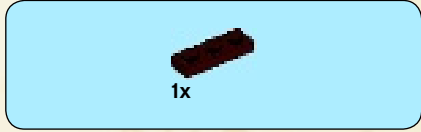
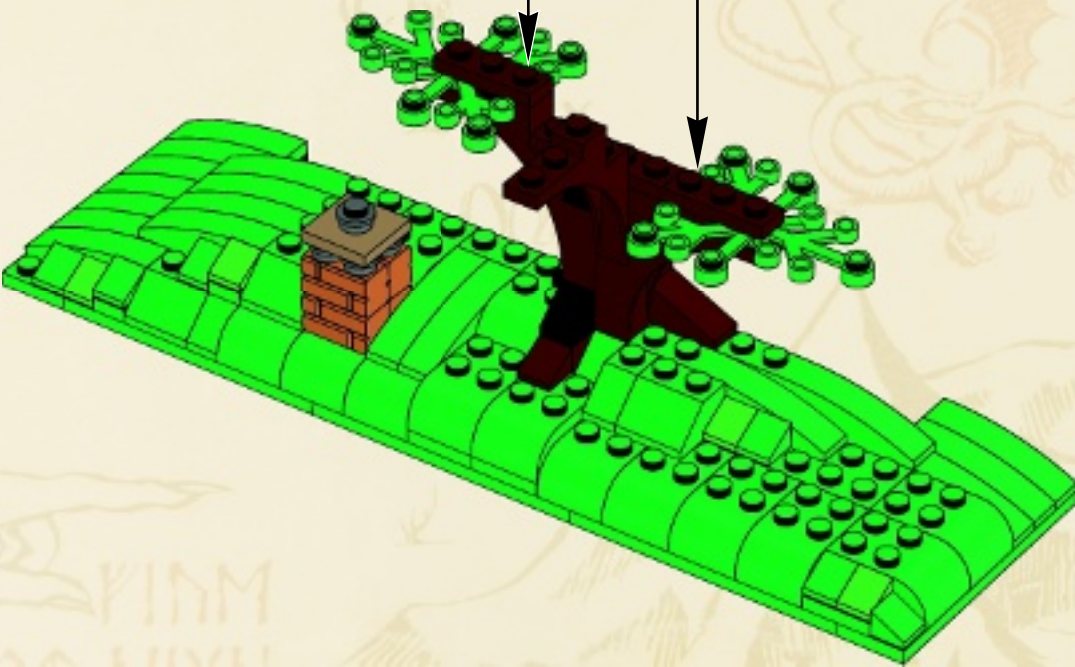

34

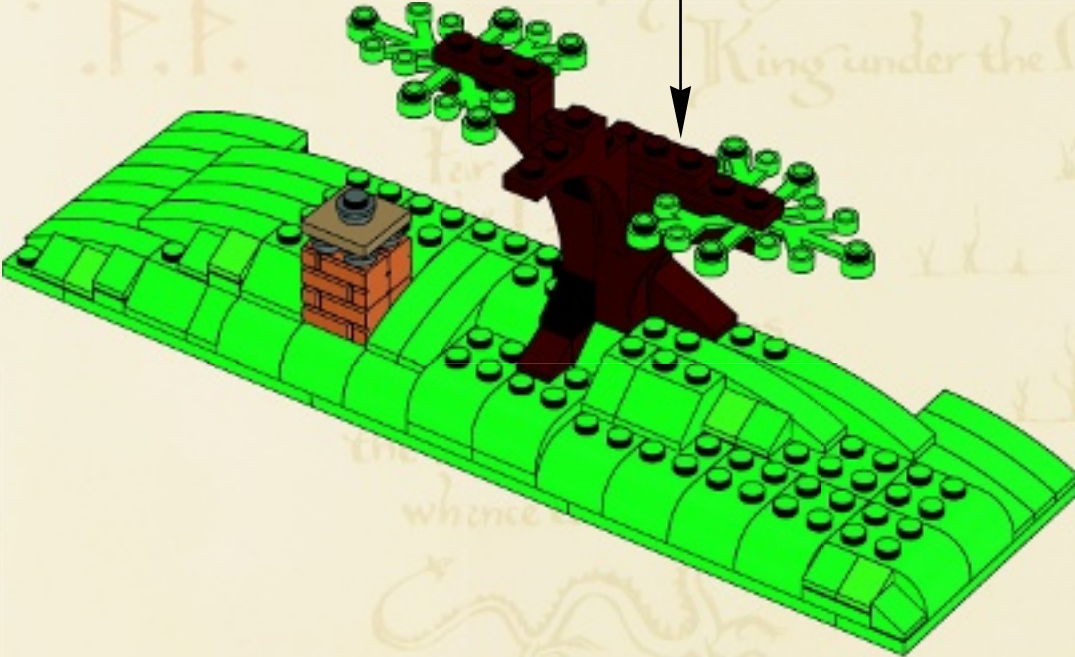



1x

35

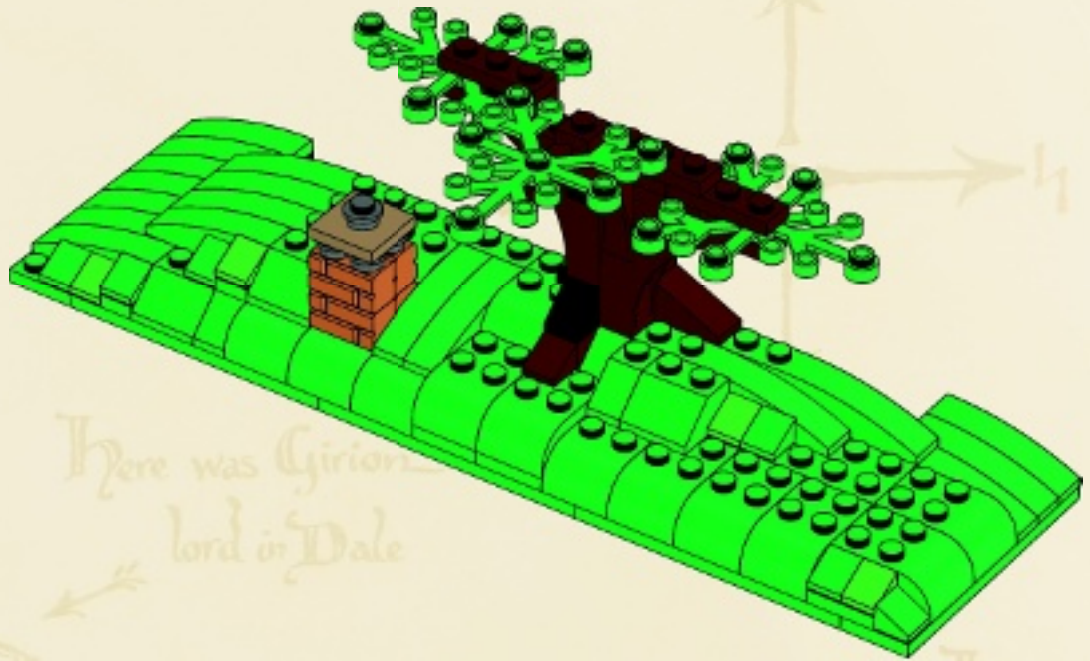

1x

36

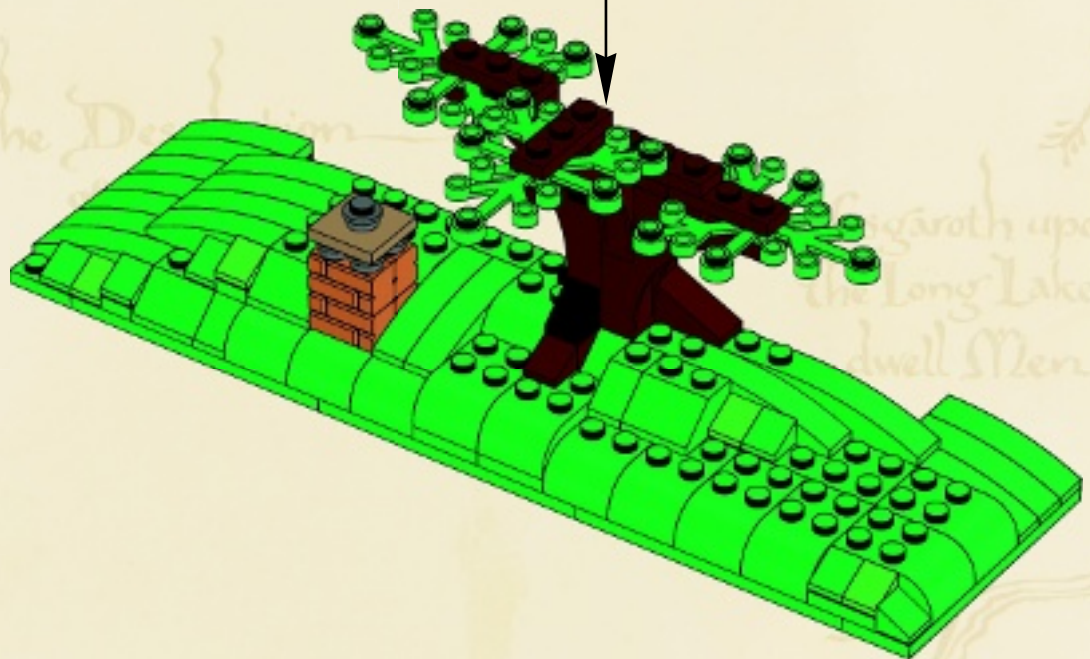

37





38





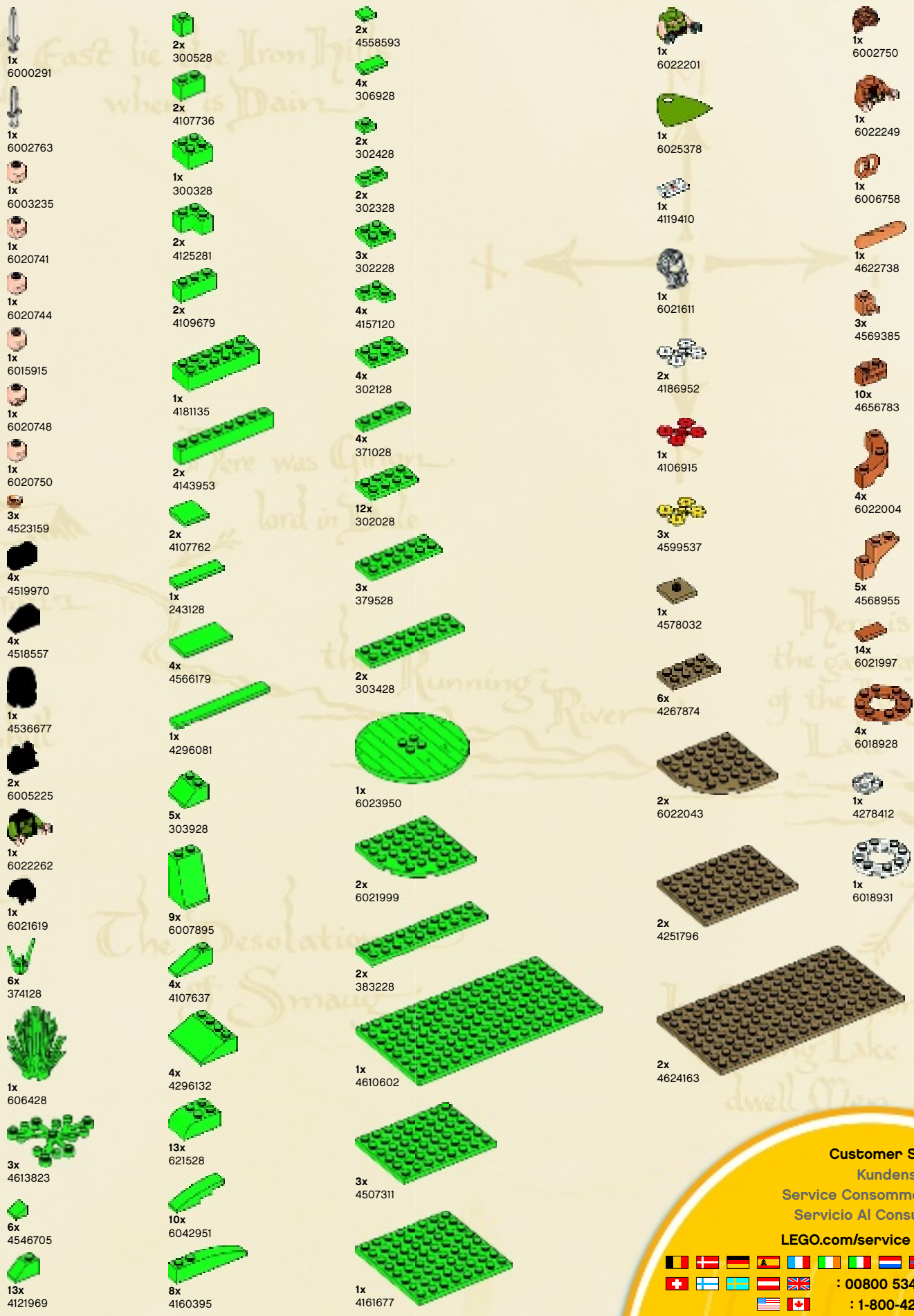

1x 6000291
 1x 6002763
 1x 6003235
 1x 6020741
 1x 6020744
 1x 6015915
 1x 6020748
 1x 6020750
 3x 4523159
 4x 4519970
 4x 4518557
 1x 4536677
 2x 6005225
 1x 6022262
 1x 6021619
 6x 374128
 1x 606428
 3x 4613823
 6x 4546705
 13x 4121969

2x 300528
 2x 4107736
 1x 300328
 2x 4125281
 2x 4109679
 1x 4181135
 2x 4143953
 2x 4107762
 1x 243128
 4x 4566179
 1x 4296081
 5x 303928
 9x 6007895
 4x 4107637
 4x 4296132
 13x 621528
 10x 6042951
 8x 4160395

2x 4558593
 4x 306928
 2x 302428
 2x 302328
 3x 302228
 4x 4157120
 4x 302128
 4x 371028
 12x 302028
 3x 379528
 2x 303428
 1x 6023950
 2x 6021999
 2x 383228
 1x 4610602
 3x 4507311
 1x 4161677

1x 6022201
 1x 6025378
 1x 4119410
 1x 6021611
 2x 4186952
 1x 4106915
 3x 4599537
 1x 4578032
 6x 4267874
 2x 6022043
 2x 4251796
 2x 4624163

1x 6002750
 1x 6022249
 1x 6006758
 1x 4622738
 3x 4569385
 10x 4656783
 4x 6022004
 5x 4568955
 14x 6021997
 4x 6018928
 1x 4278412
 1x 6018931

Customer Service
Kundenservice
Service Consommateurs
Servicio Al Consumidor
LEGO.com/service or dial



 : 00800 5346 5555
 : 1-800-422-5346



□ 79010
Goblin Soldier
Soldat gobelin
Soldado Trasgo

□ 79010
Nori the Dwarf
Le nain Nori
Nori el Enano



□ 79010
Goblin Soldier
Soldat gobelin
Soldado Trasgo



□ 79010
Dori the Dwarf
Le nain Dori
Dori el Enano



□ 79004
Bilbo Baggins™



□ 79003
Dwalin the Dwarf
Le nain Dwalin
Dwalin el Enano



□ 79002
Hunter Orc
Orque chasseur
Orco Cazador



□ 79004
Oin the Dwarf
Le nain Óin
Oin el Enano

□ 79004
Mirkwood™ Elf Chief
Le chef des elfes de Mirkwood™
Jefe Elfo del Mirkwood™



□ 79003
Balin the Dwarf
Le nain Balin
Balin el Enano

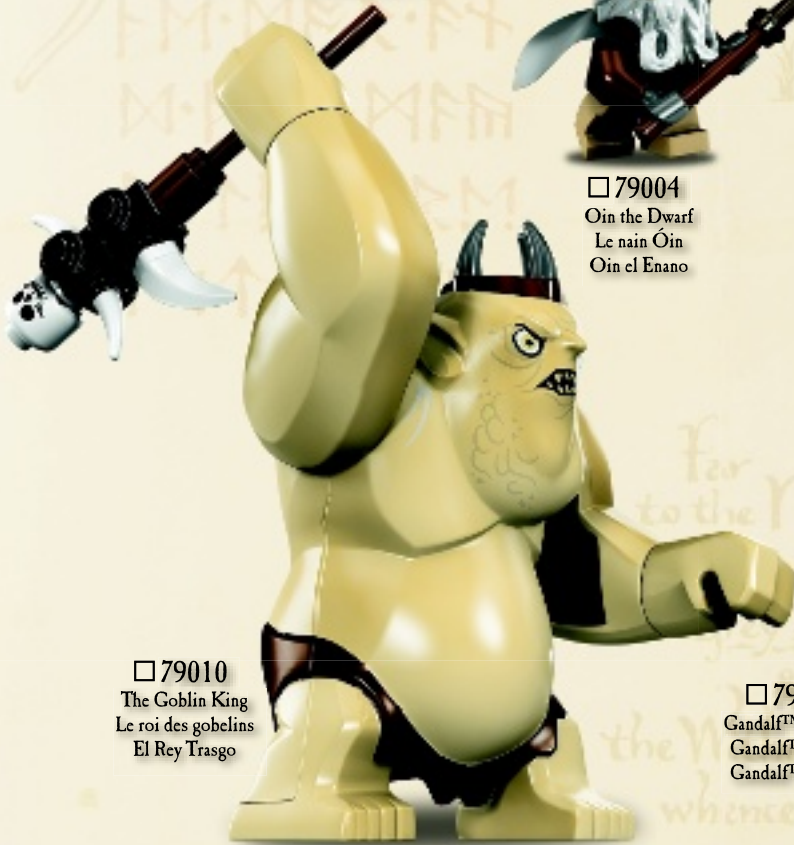

□ 79010
The Goblin King
Le roi des gobelins
El Rey Trasgo



□ 79001
Kili the Dwarf
Le nain Kili
Kili el Enano



□ 79010
Gandalf™ the Grey
Gandalf™ le Gris
Gandalf™ el Gris



□ 79003
Bilbo Baggins™



□ 79000
Bilbo Baggins™

□ 79000
Gollum™



□ 79004
Mirkwood™ Elf Guard
Garde elfe de Mirkwood™
Guardia Elfo del Mirkwood™

□ 79004
Gloin the Dwarf
Le nain Glóin
Gloin el Enano



□ 79003
Bofur the Dwarf
Le nain Bofur
Bofur el Enano



□ 79002
Thorin Oakenshield™



□ 79002
Yaznec™



□ 79001
Legolas Greenleaf™

□ 79001
Fili the Dwarf
Le nain Fili
Fili el Enano



□ 79002
Warg
Ouargue
Wargo



□ 79002
Warg
Ouargue
Wargo



□ 79002
Bifur the Dwarf
Le nain Bifur
Bifur el Enano



□ 79010
Goblin Scribe
Scribe goblin
Escriba Trasgo

□ 79010
Ori the Dwarf
Le nain Ori
Ori el Enano



□ 79003
Bombur the Dwarf
Le nain Bombur
Bombur el Enano



□ 79003
Gandalf™ the Grey
Gandalf™ le Gris
Gandalf™ el Gris



□ 79001
Tauriel™



□ 79002
Hunter Orc
Orque chasseur
Orco Cazador

Special The Hobbit Trilogy
Preview Set!

Ensemble spécial
de prévisualisation
Trilogie Le Hobbit!

Set especial:
¡Adelántate al estreno
de la trilogía de El Hobbit!



79004



79010

79000



79001



Special The Hobbit Trilogy
Preview Set!

Ensemble spécial
de prévisualisation
Trilogie Le Hobbit!

Set especial:
¡Adelántate al estreno
de la trilogía de El Hobbit!



THE LORD OF THE RINGS



The Quest of the Fellowship
Continues in 2013



La quête de la Communauté
se poursuit en 2013



La Aventura de la Comunidad
Continúa en 2013

LEGO.com/thelordoftherings

THE HOBBIT™

AN UNEXPECTED JOURNEY



3920
The Hobbit: An
Unexpected Journey

7+  2-4  15-25





THE HOBBIT

AN UNEXPECTED JOURNEY

LEGO.com/thehobbit



LEGO and the LEGO logo are trademarks of the/sonnt des marques de commerce de/son marcas registradas de LEGO Group.
©2012 The LEGO Group.
THE HOBBIT: AN UNEXPECTED JOURNEY: © NLP™ Middle-earth Ent. Lic. to New Line.
(s12)
LE HOBBIT : UN VOYAGE INATTENDU : © NLP™ Middle-earth Ent. Lic. à New Line.
(s12)
EL HOBBIT: UN VIAJE INESPERADO: © NLP™ Middle-earth Ent.; uso autorizado a New Line.
(s12)