

# BASIC

# 720

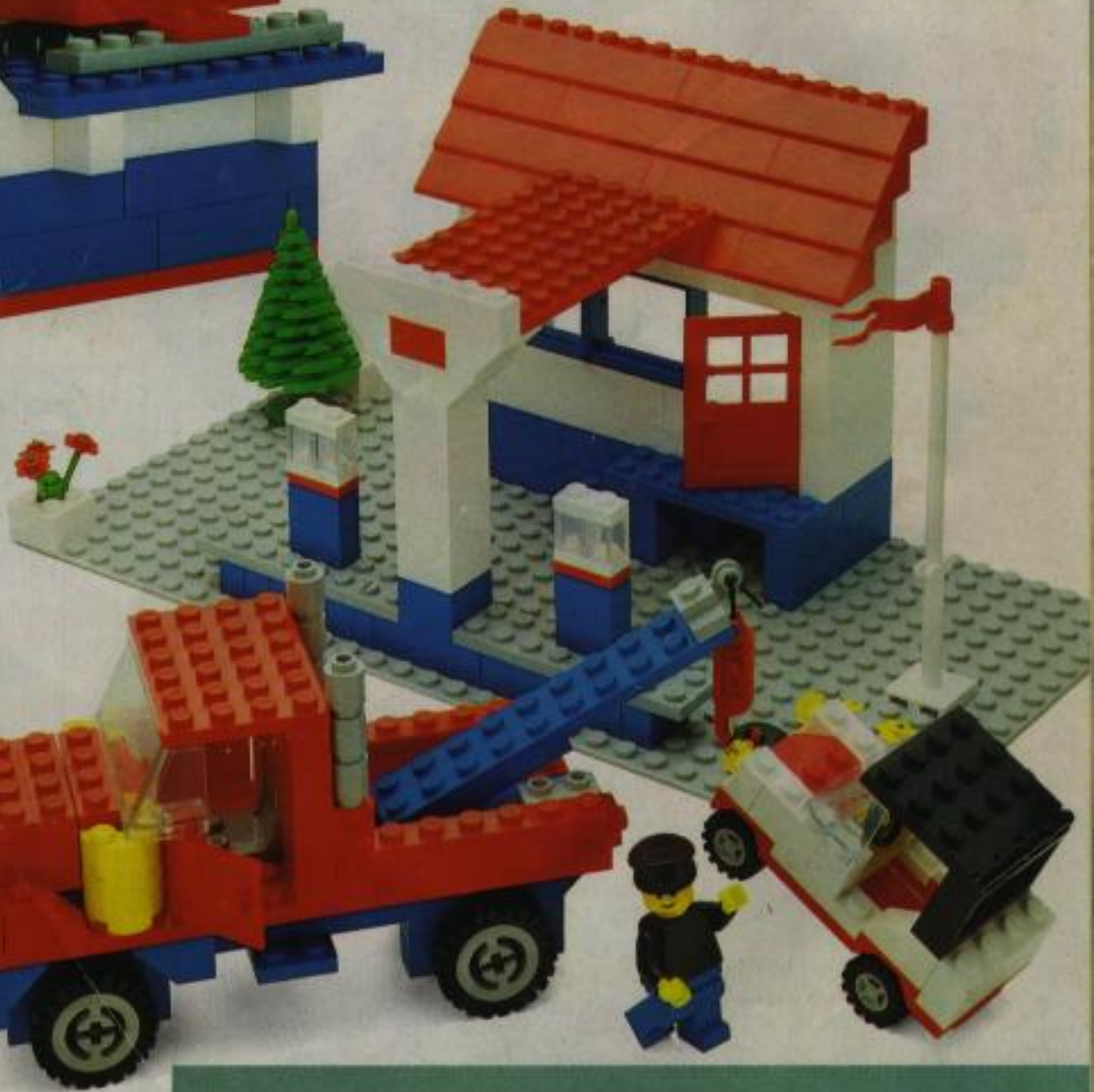

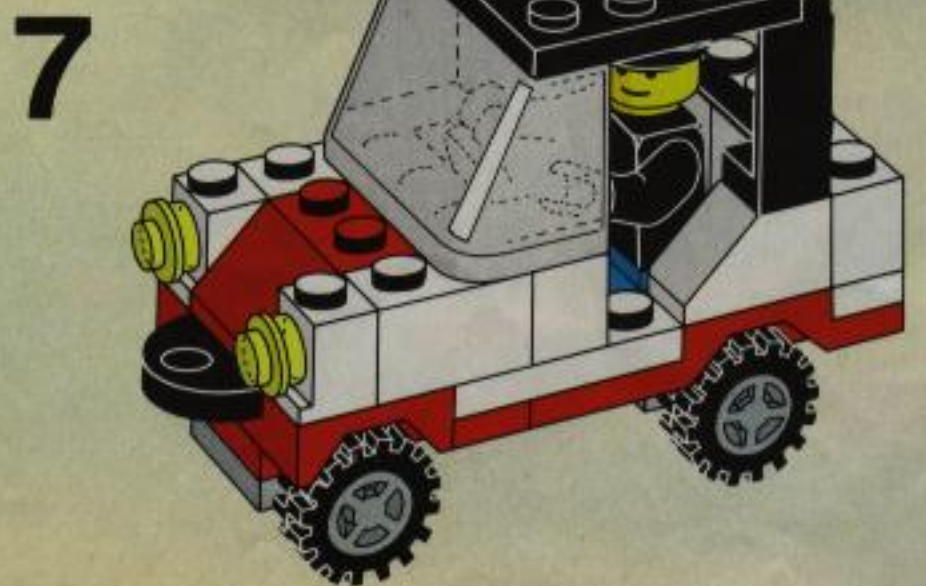

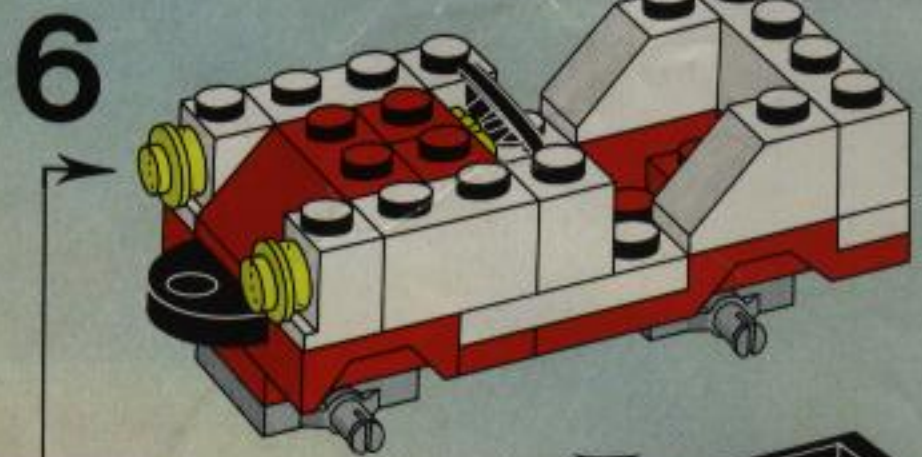
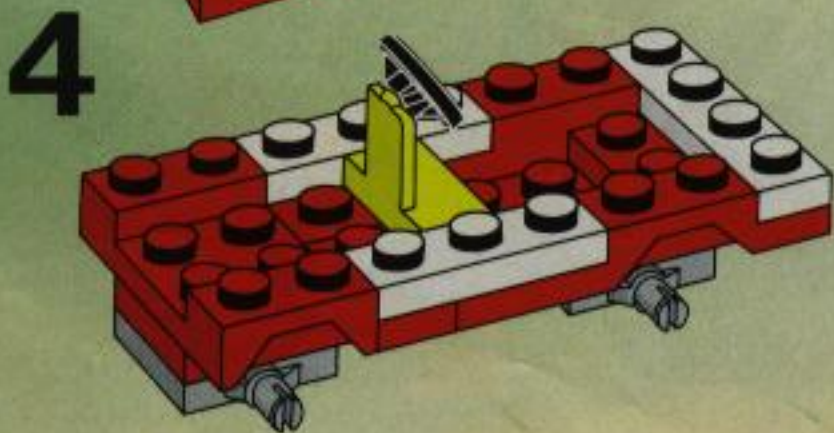
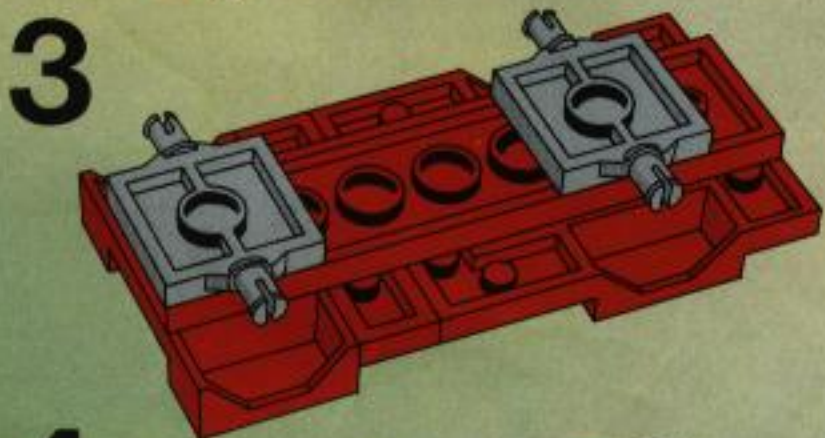
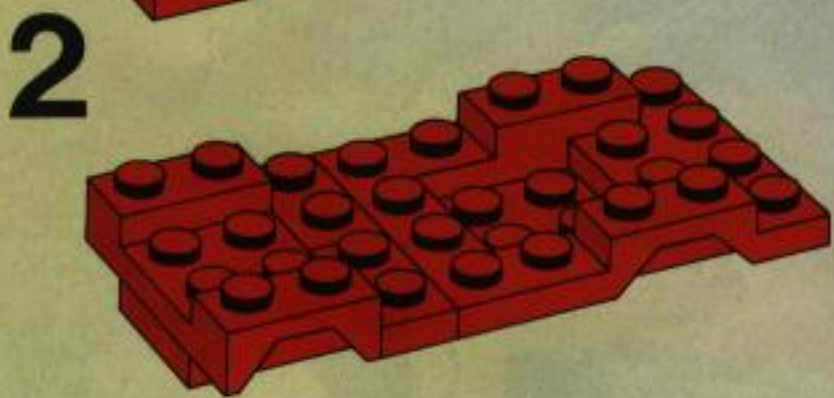
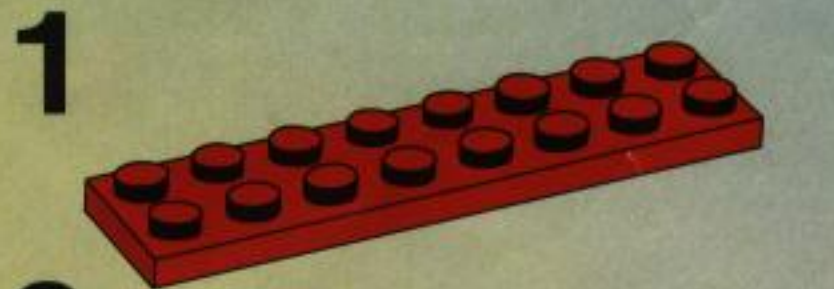
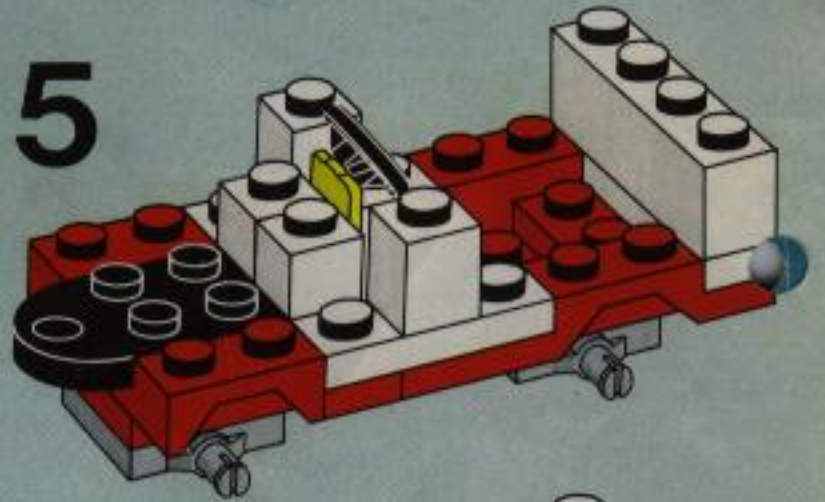
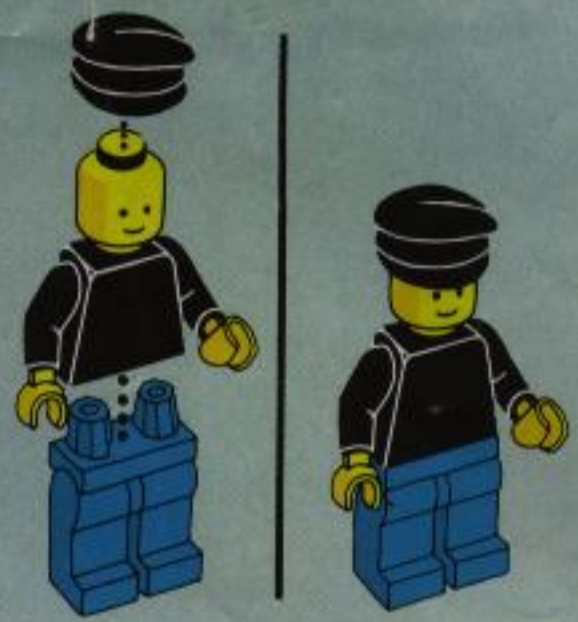
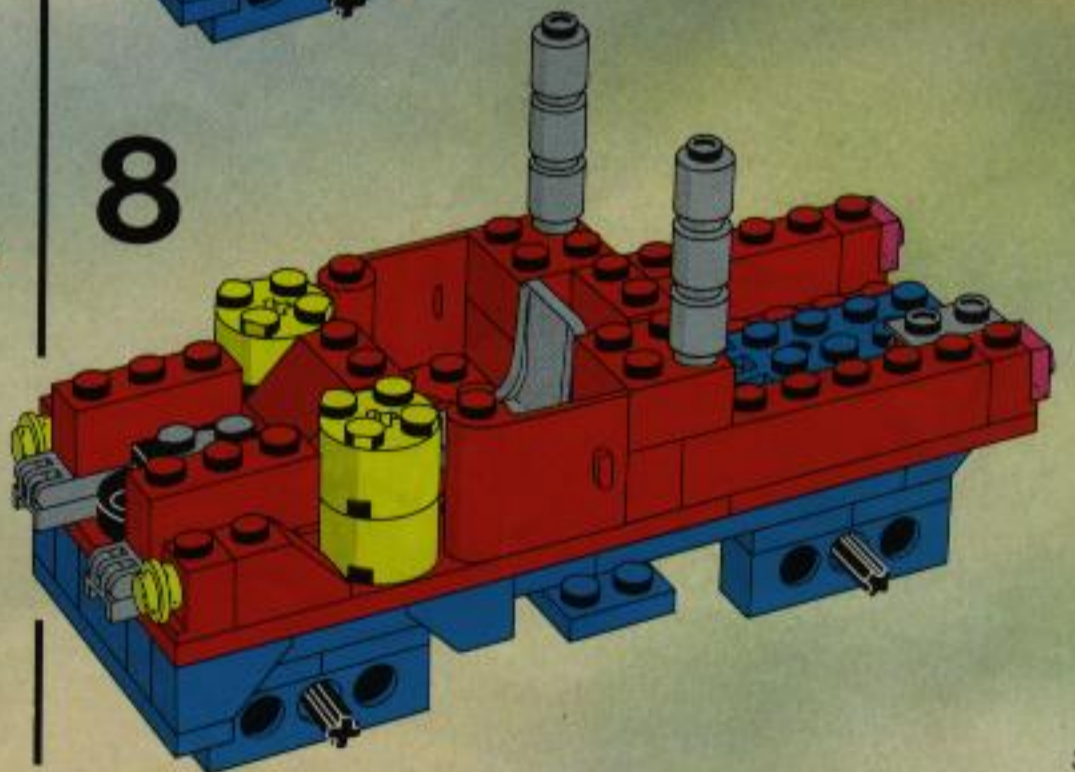
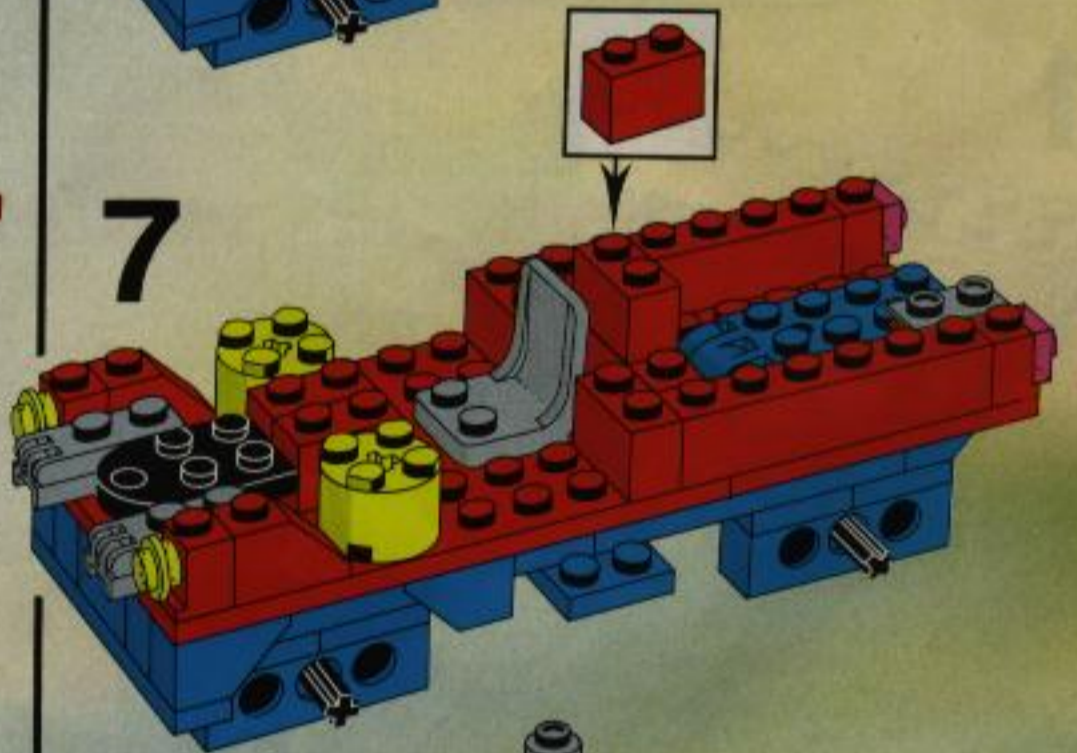
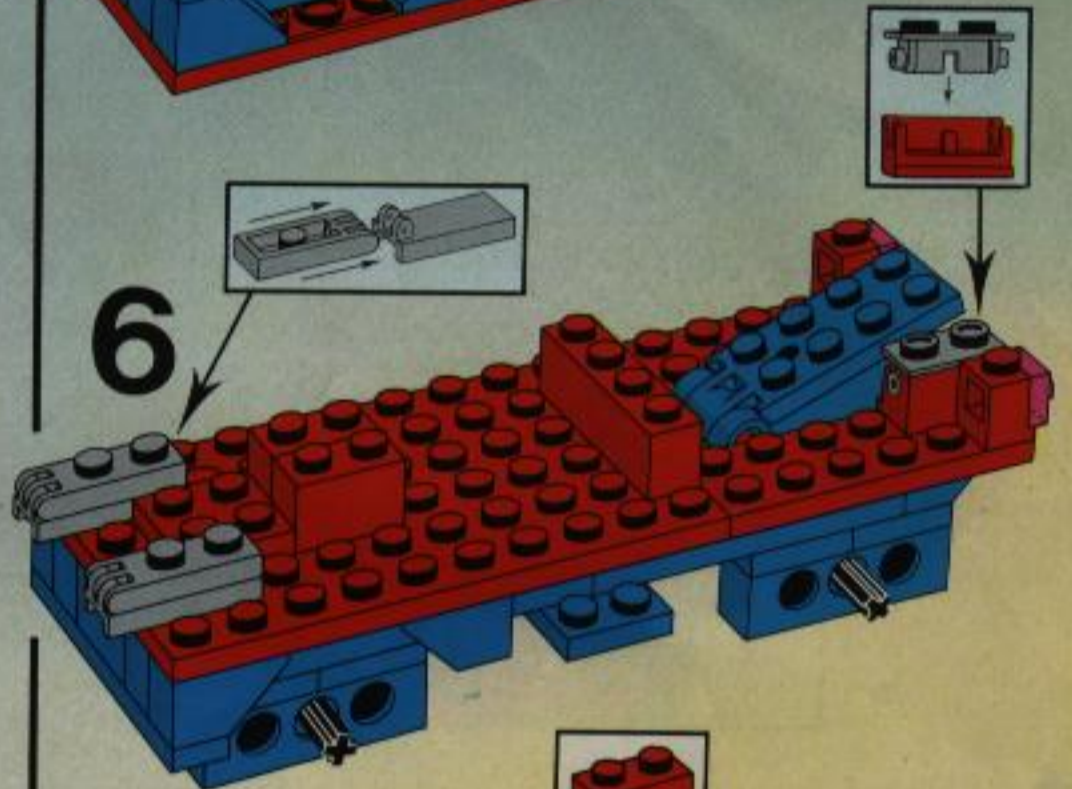
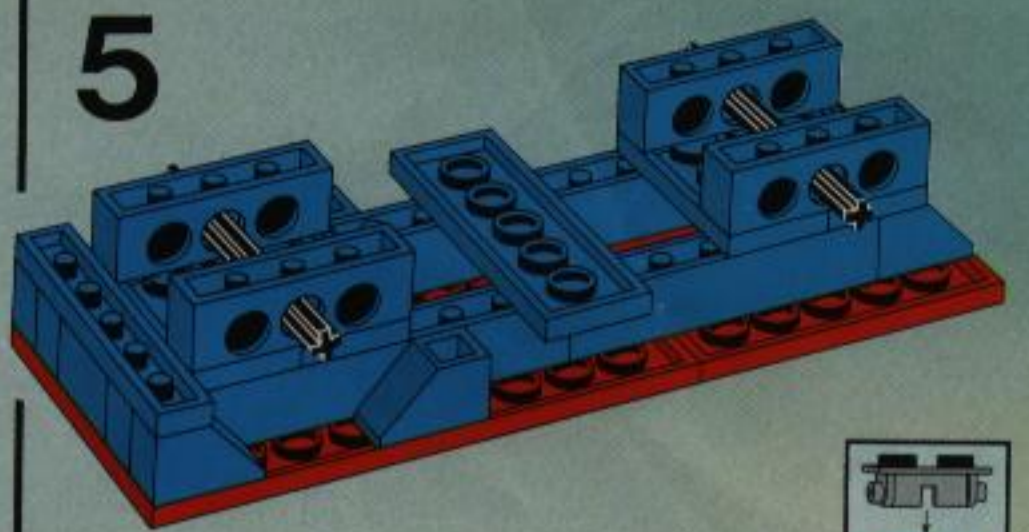
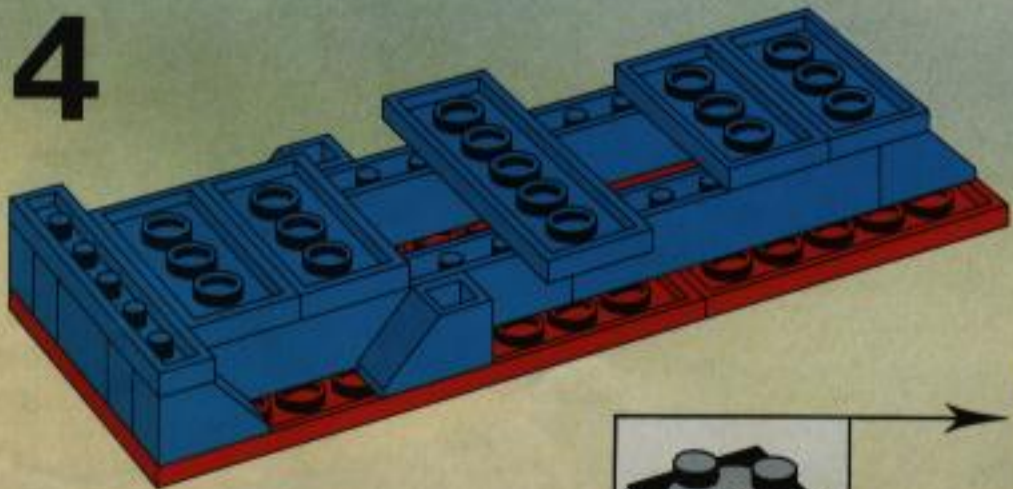
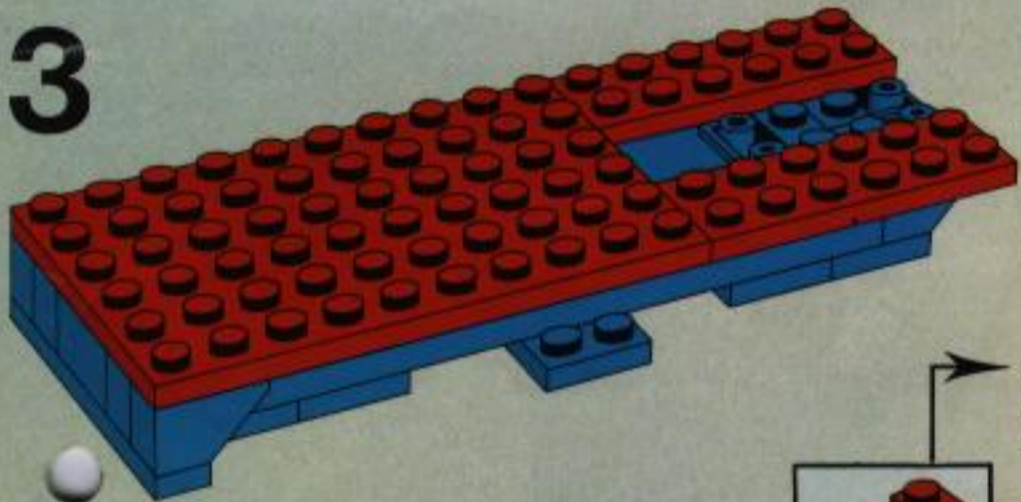
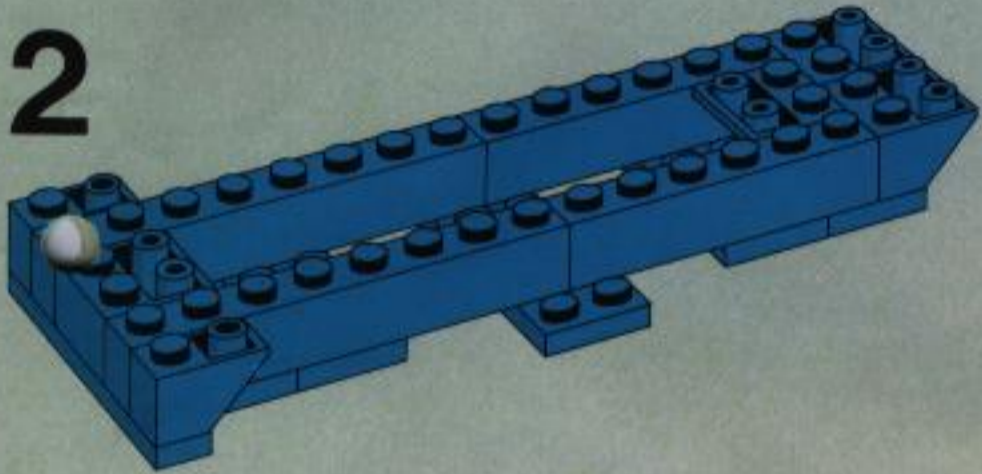
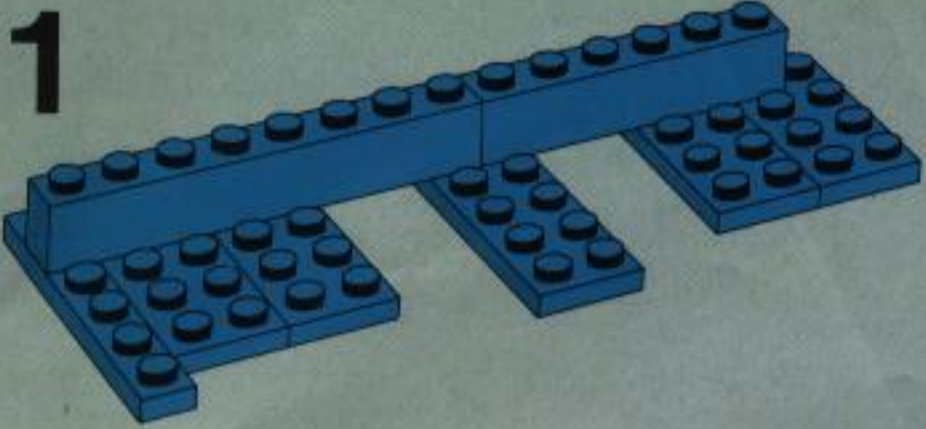

9

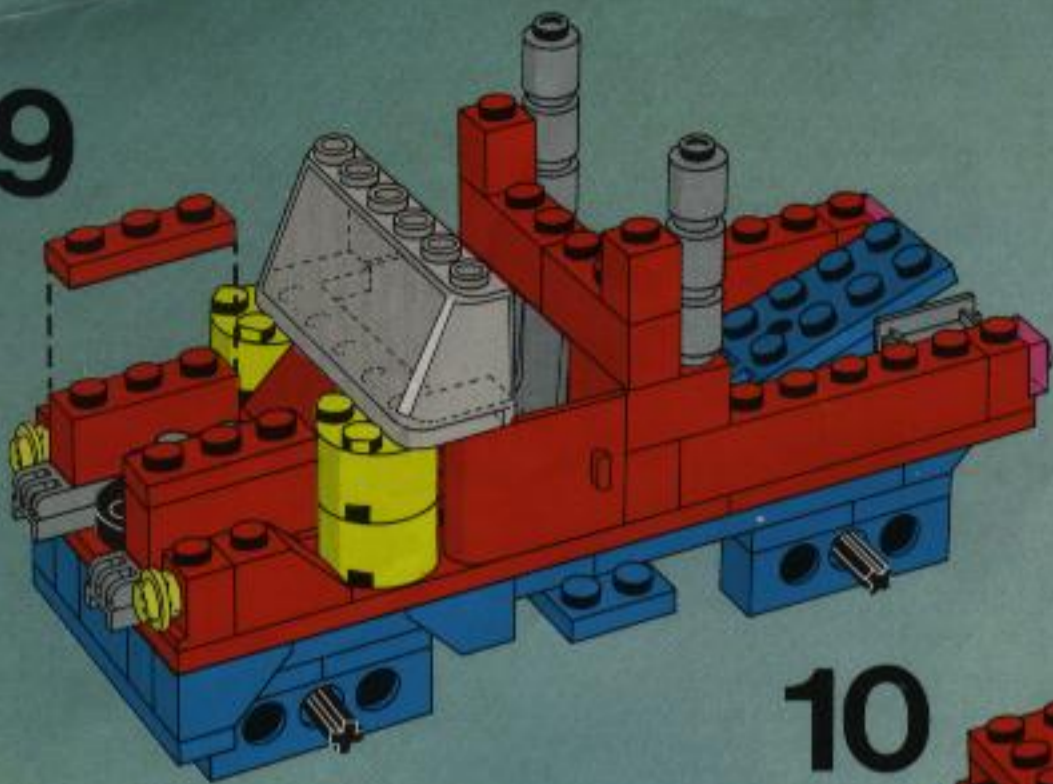

1

2

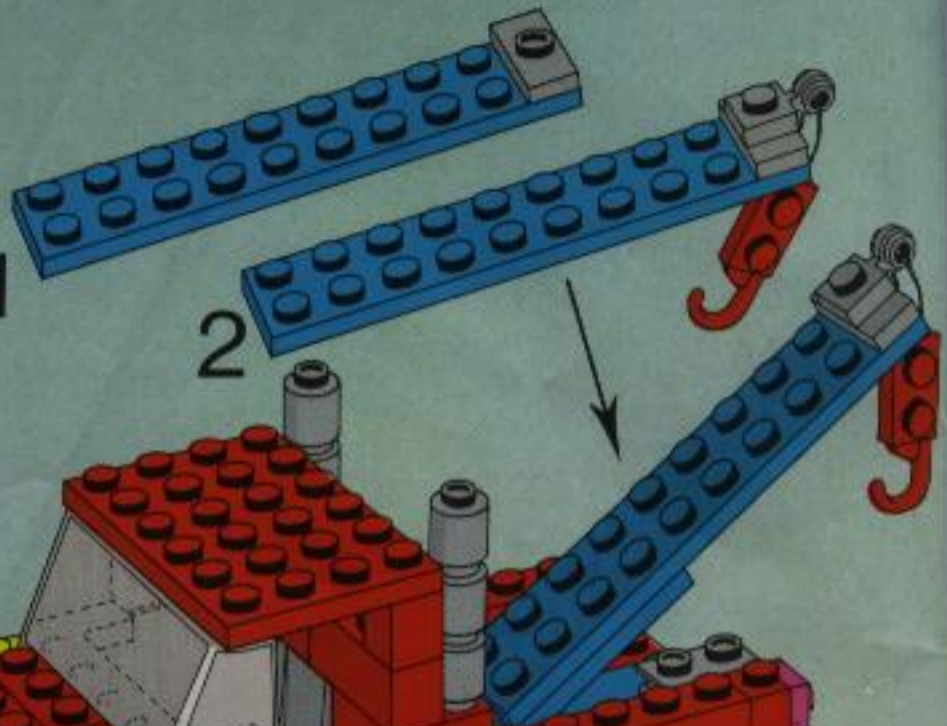

10

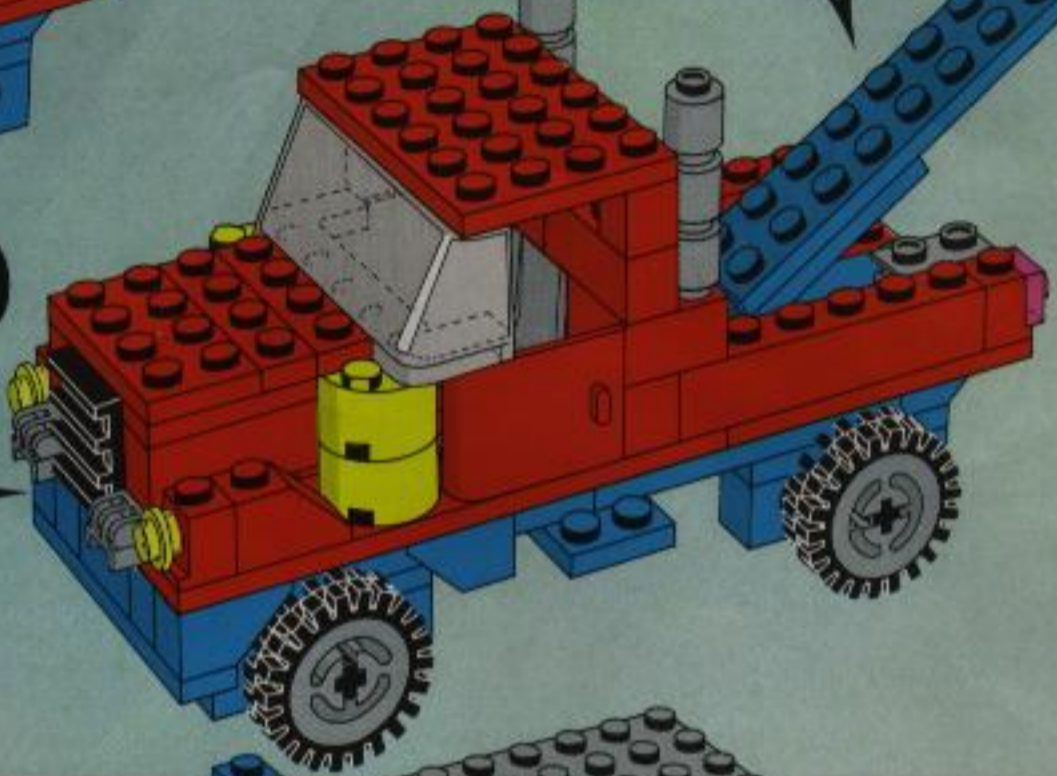
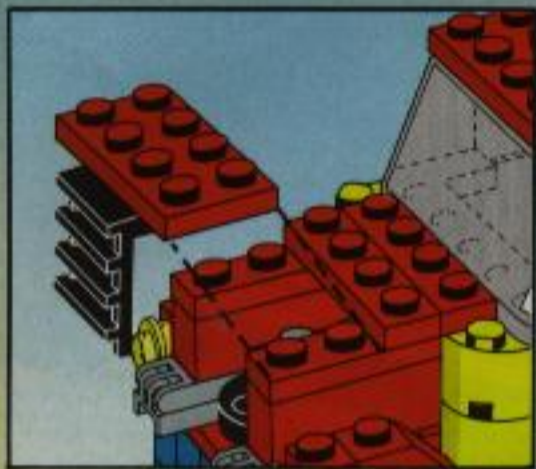

1

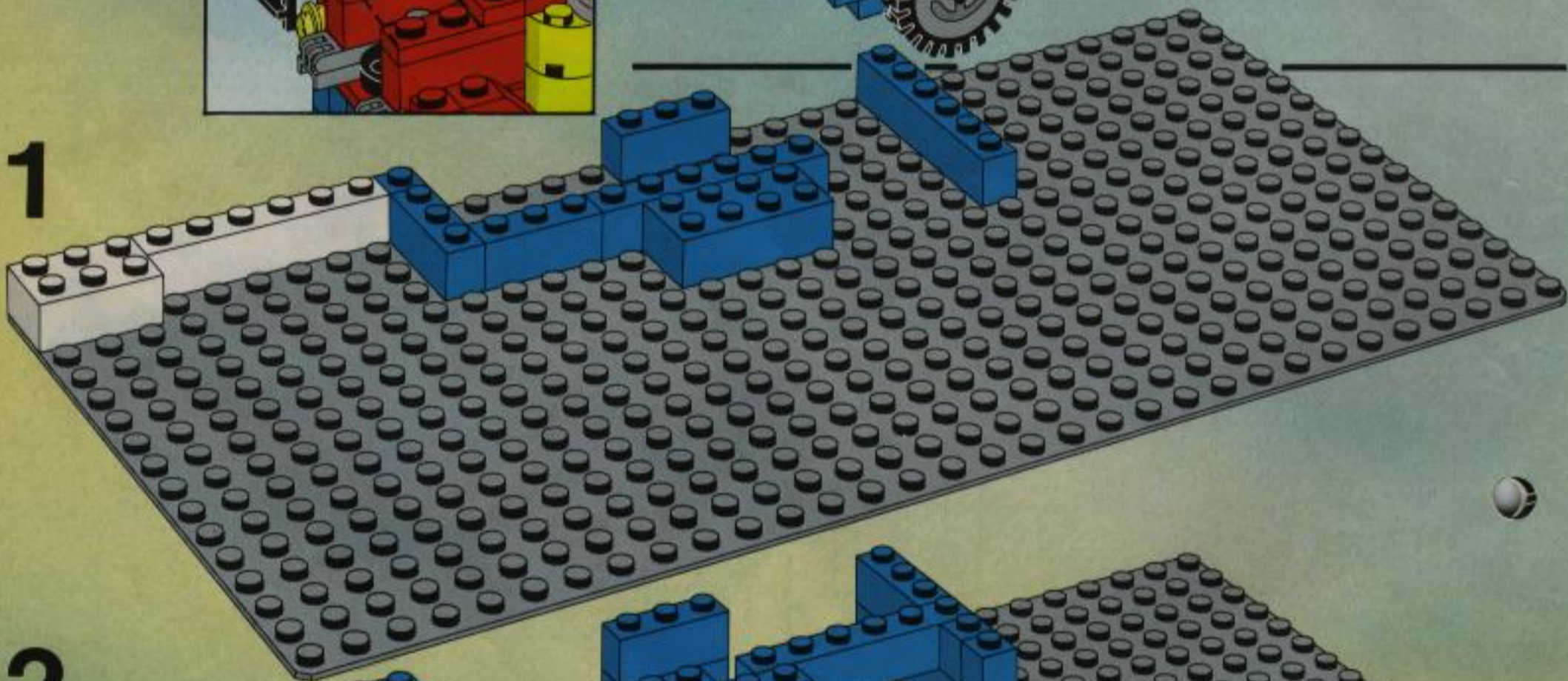

2

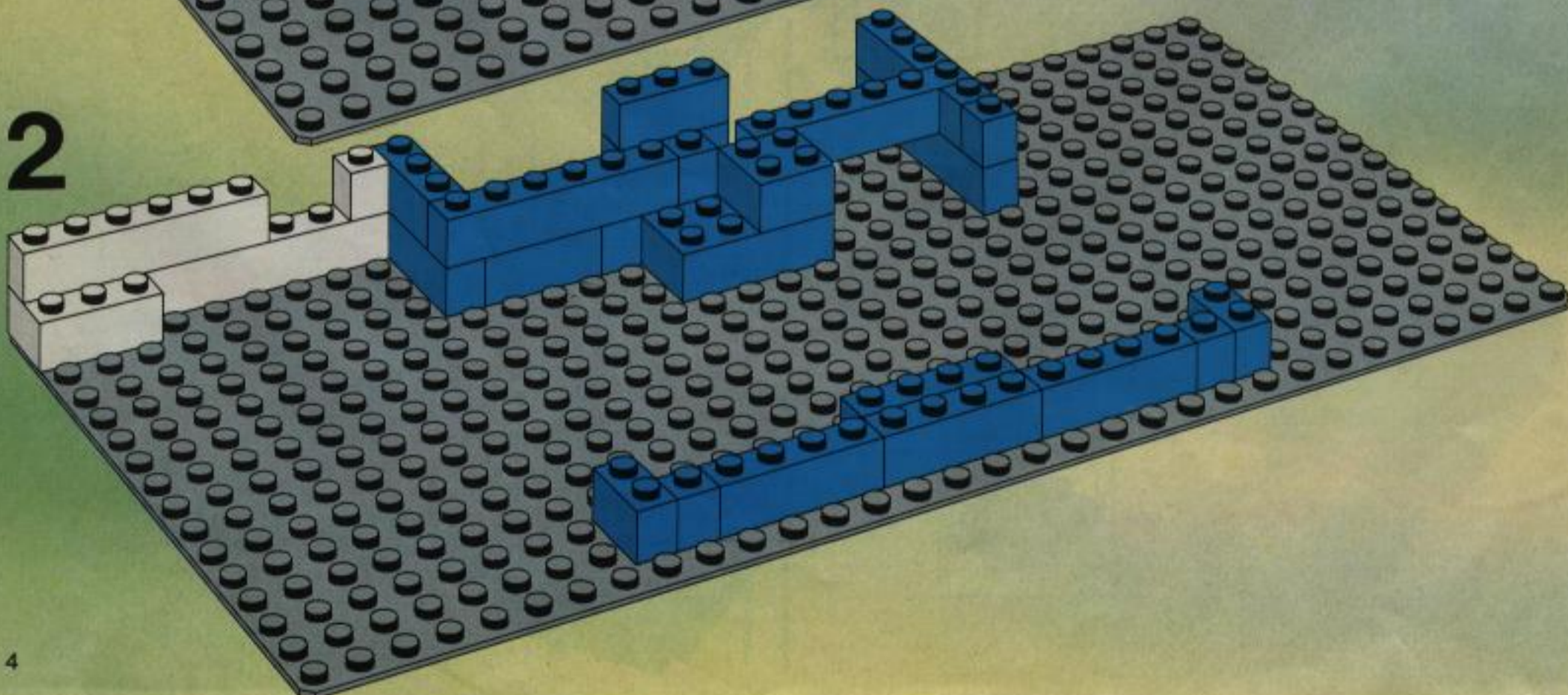

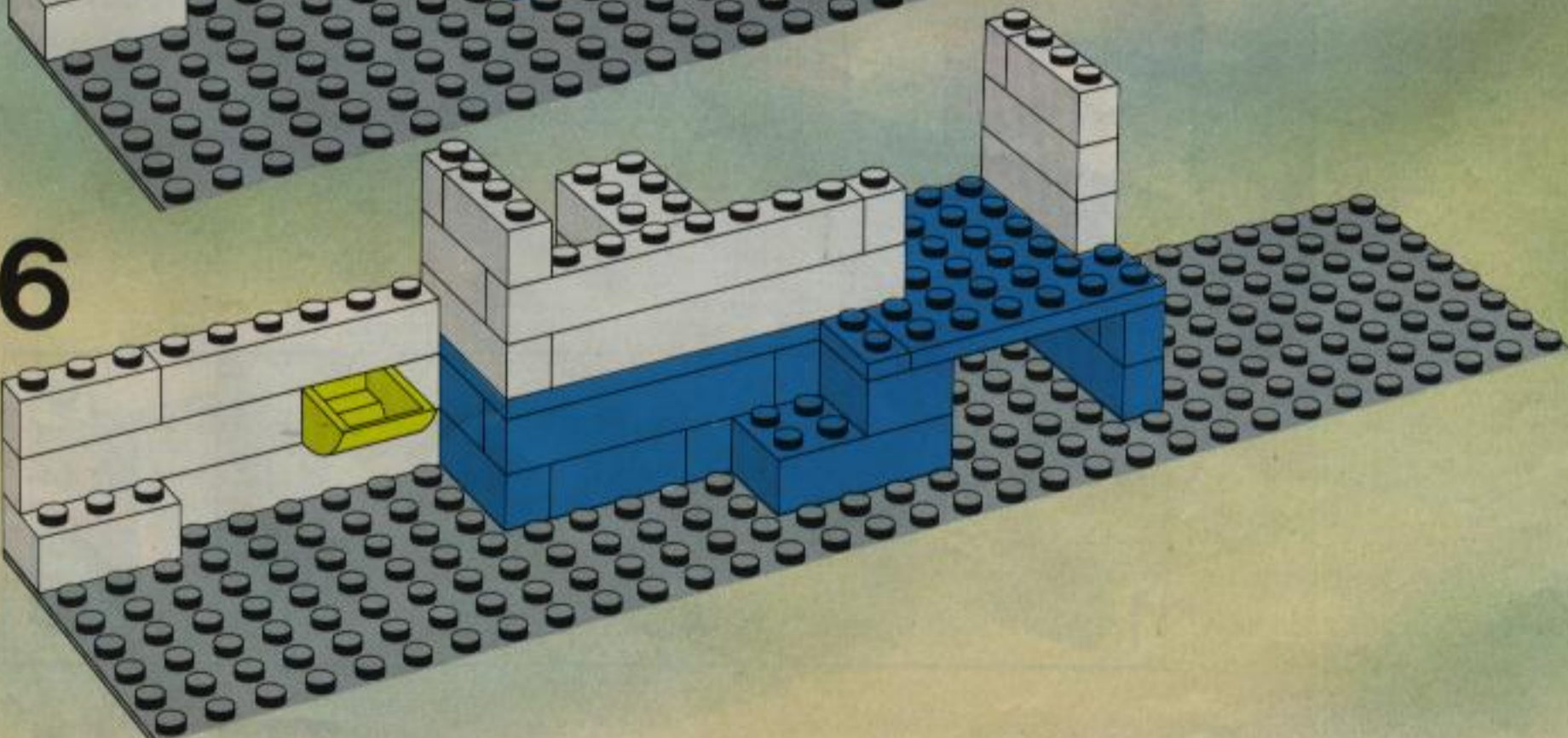
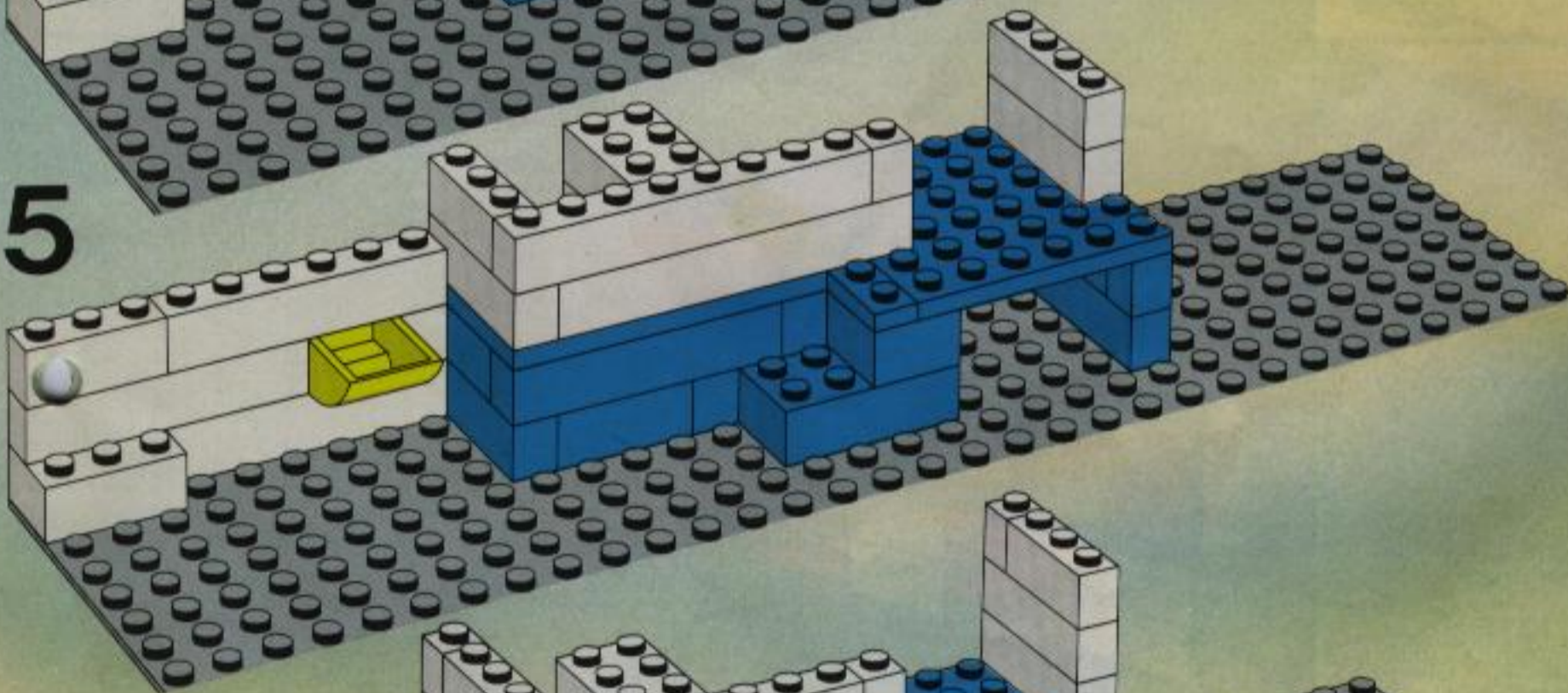
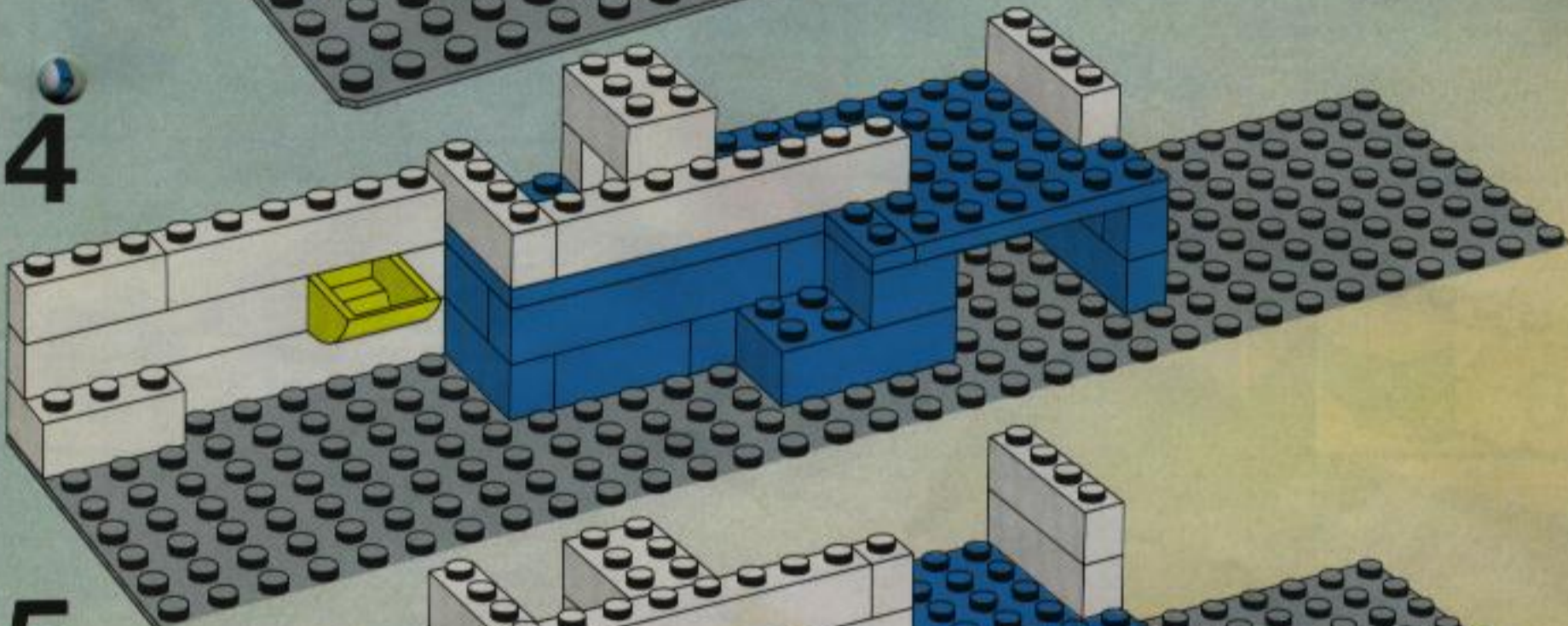
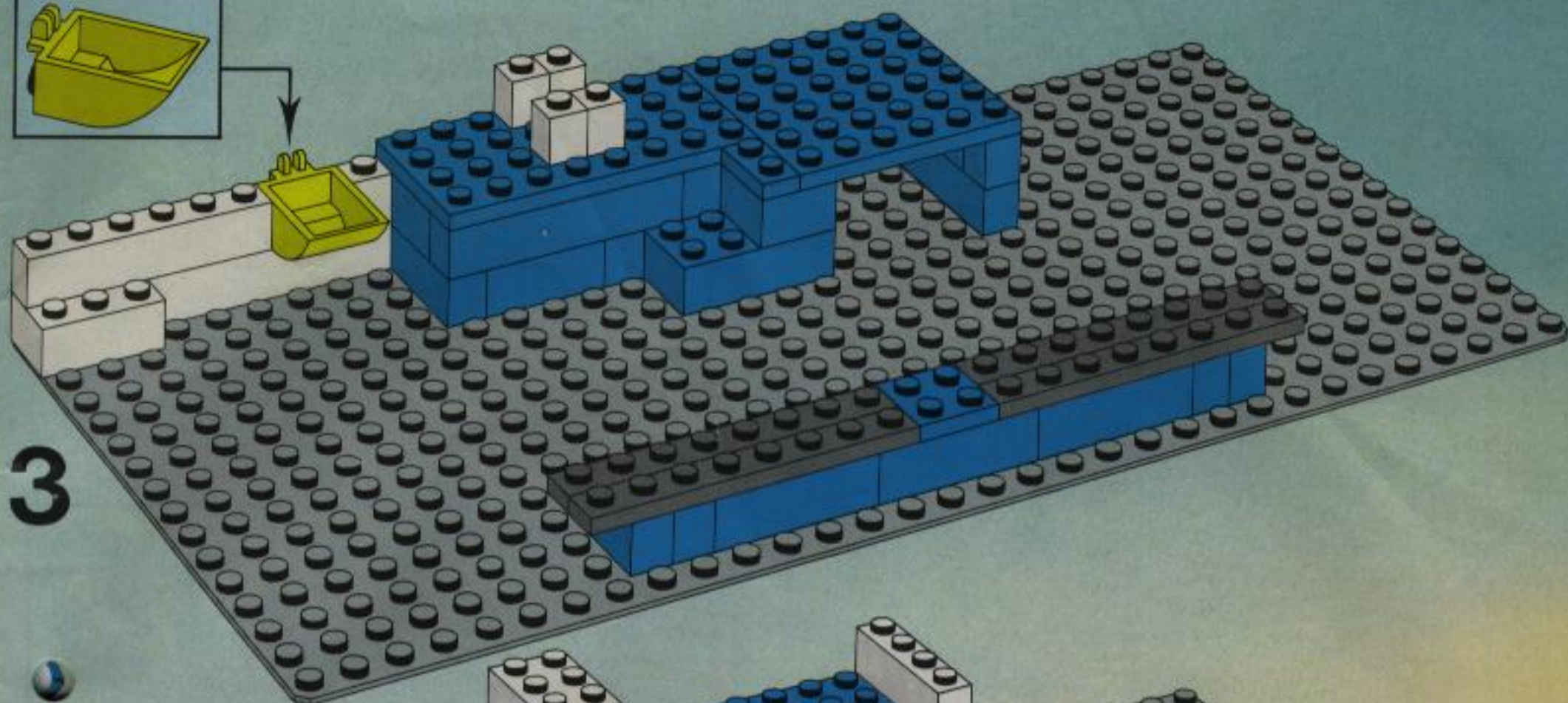

7

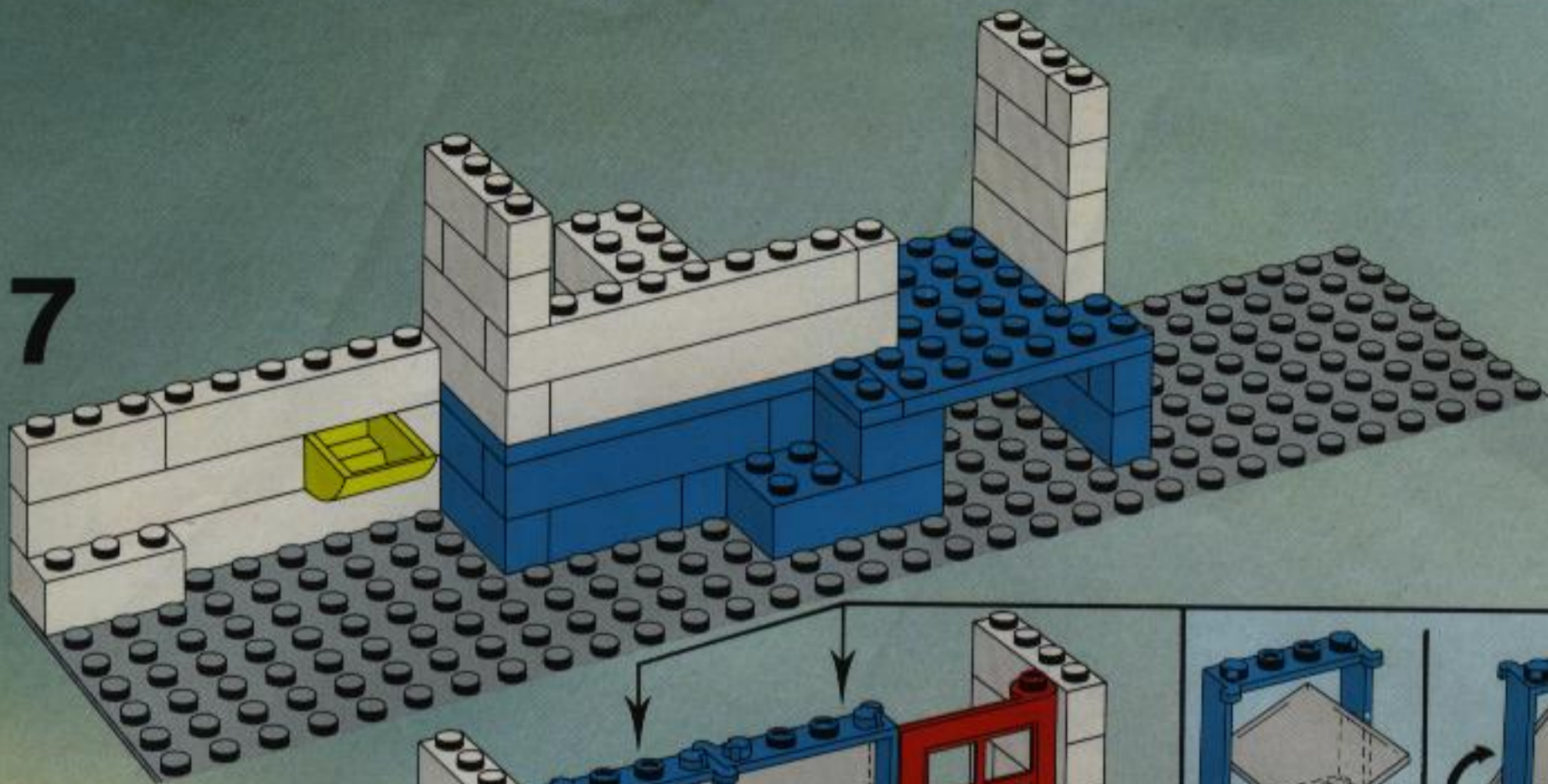

8

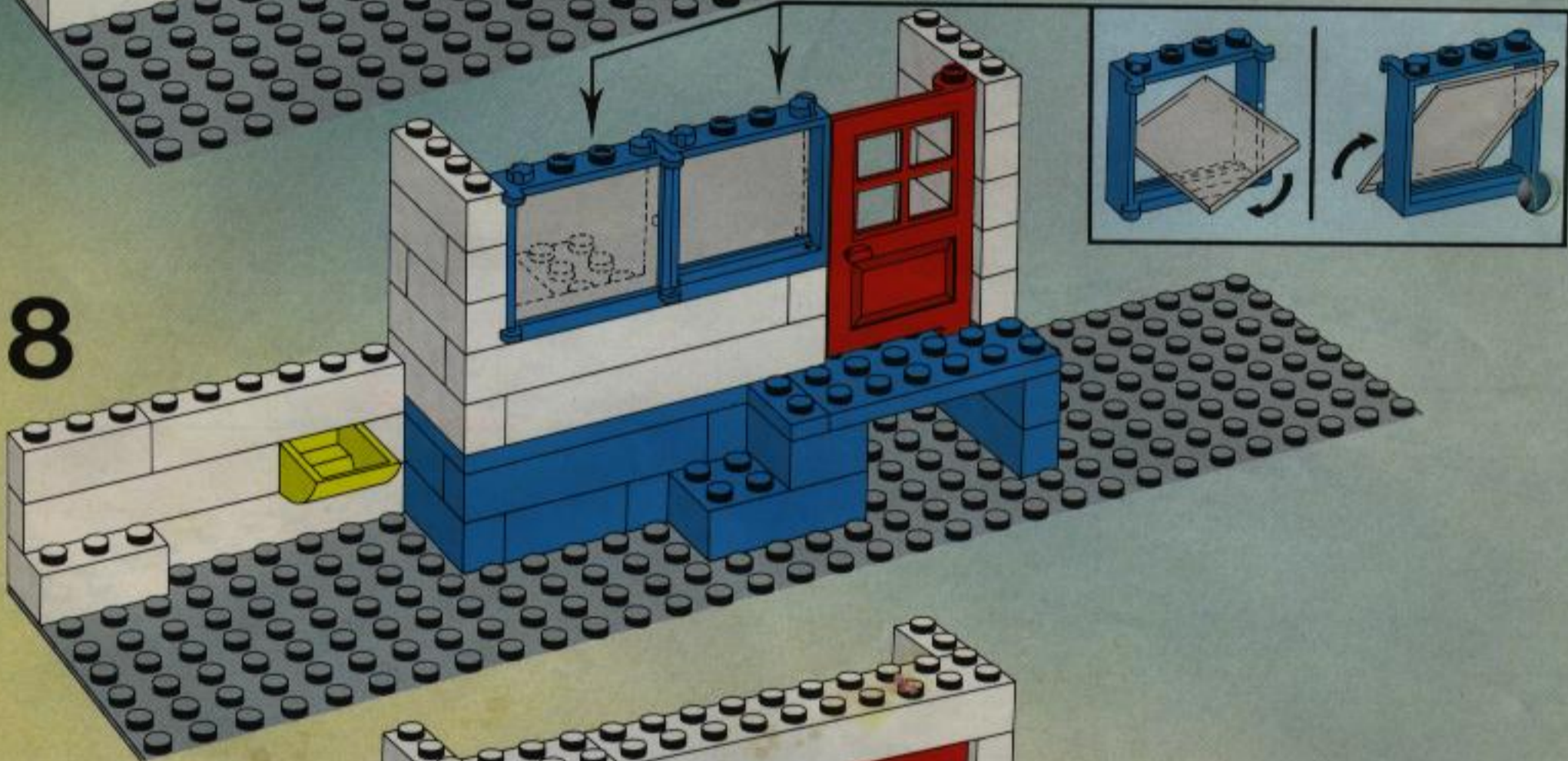

9

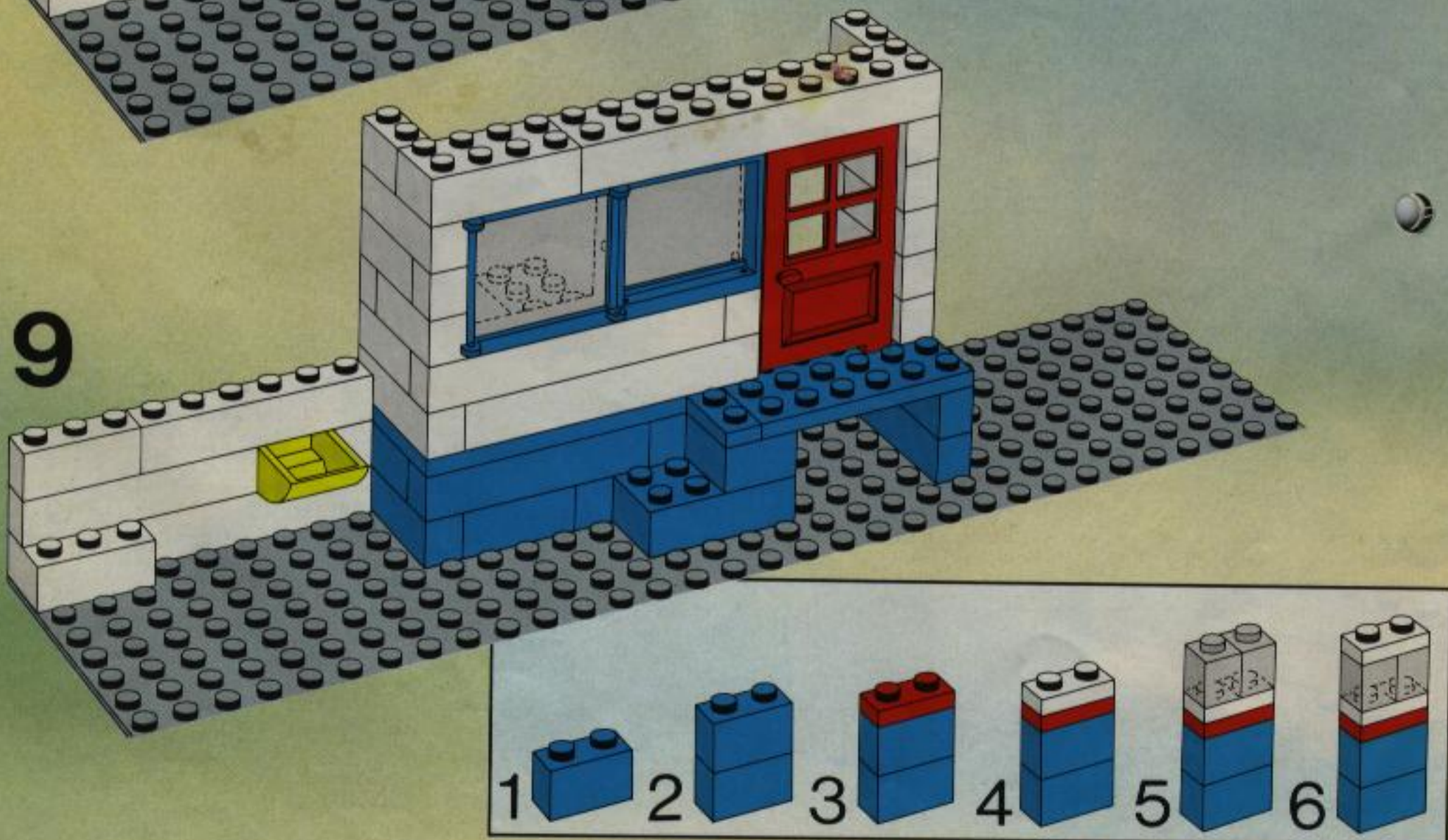

10

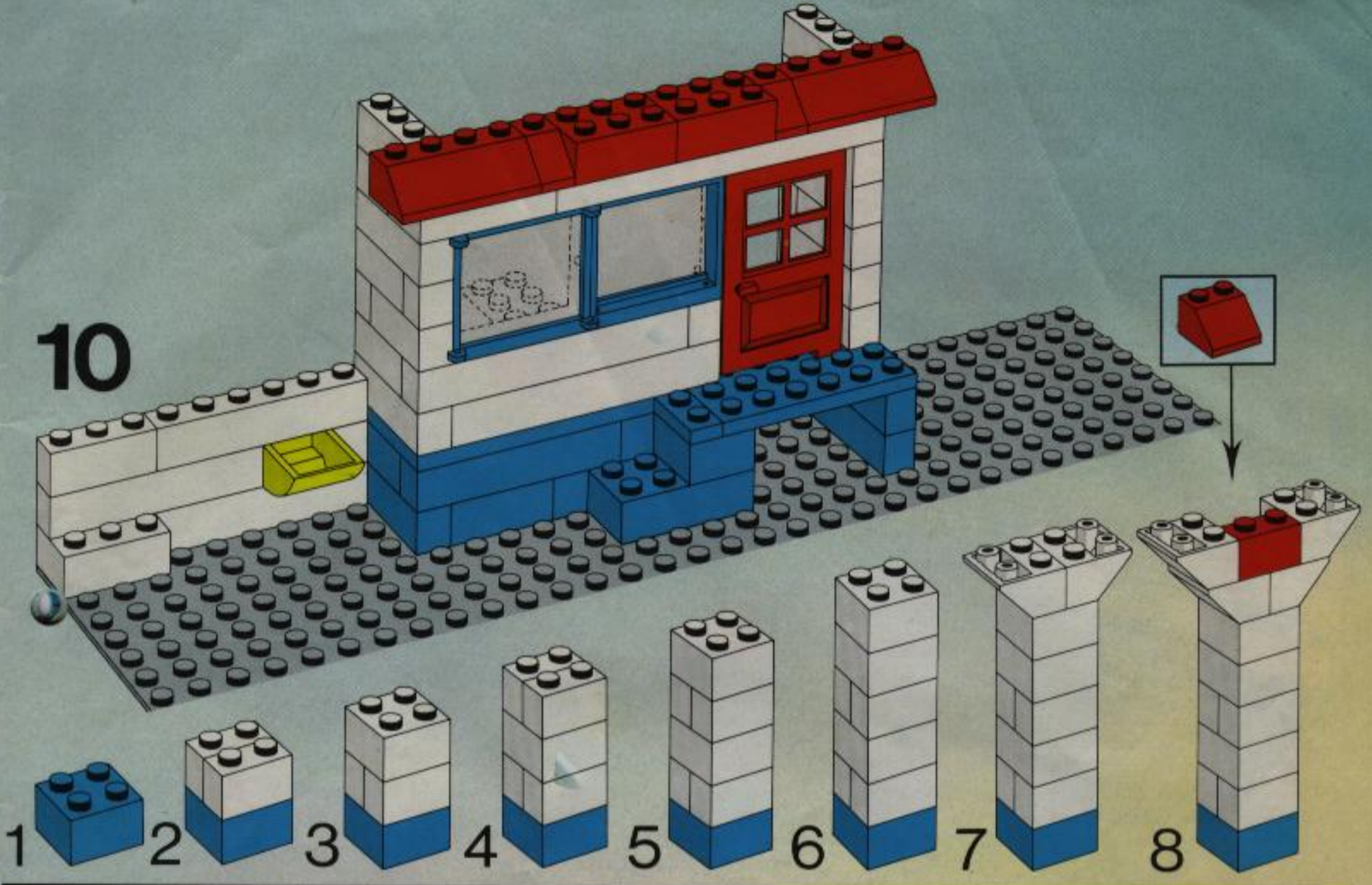

11

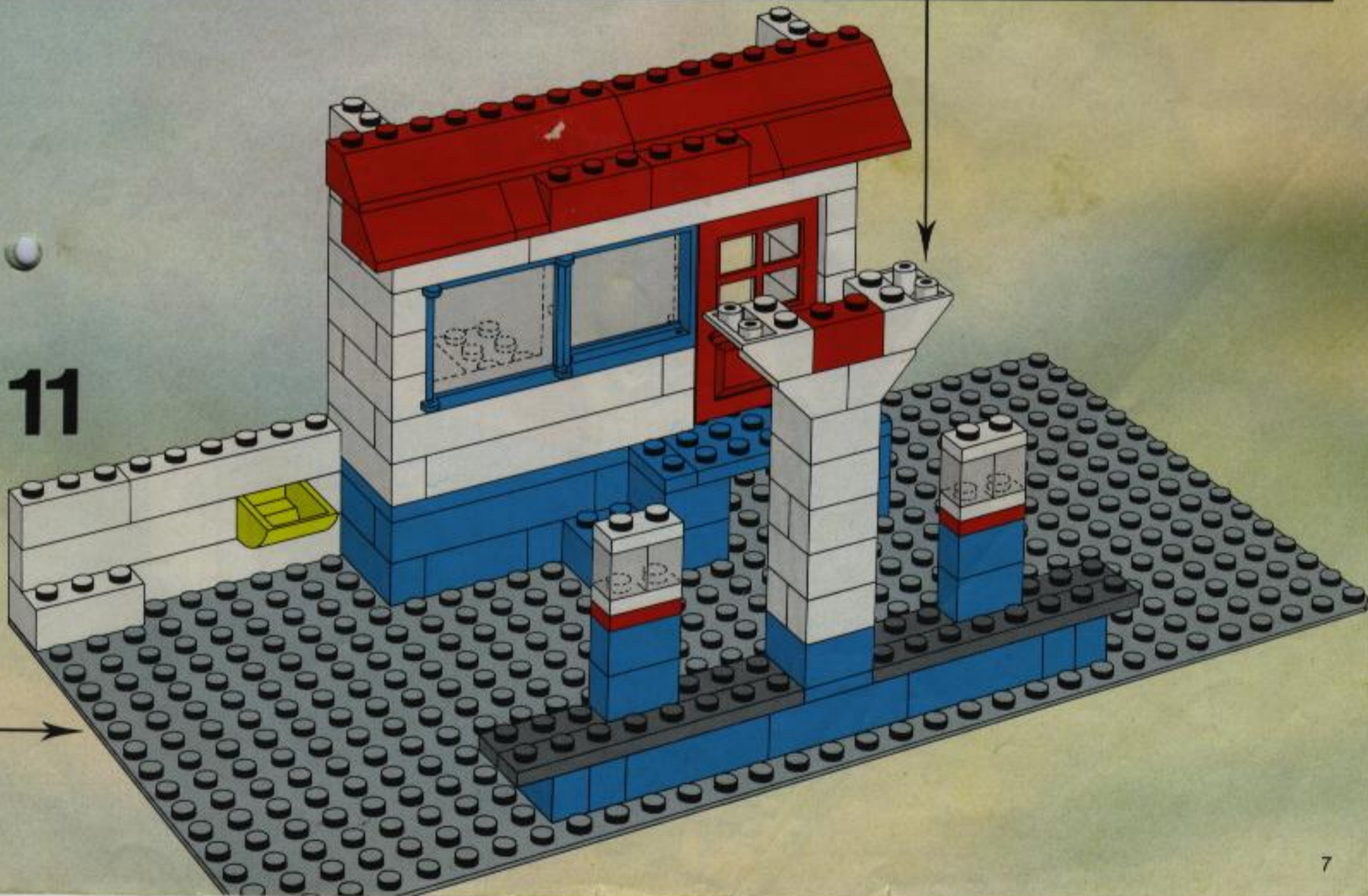

12

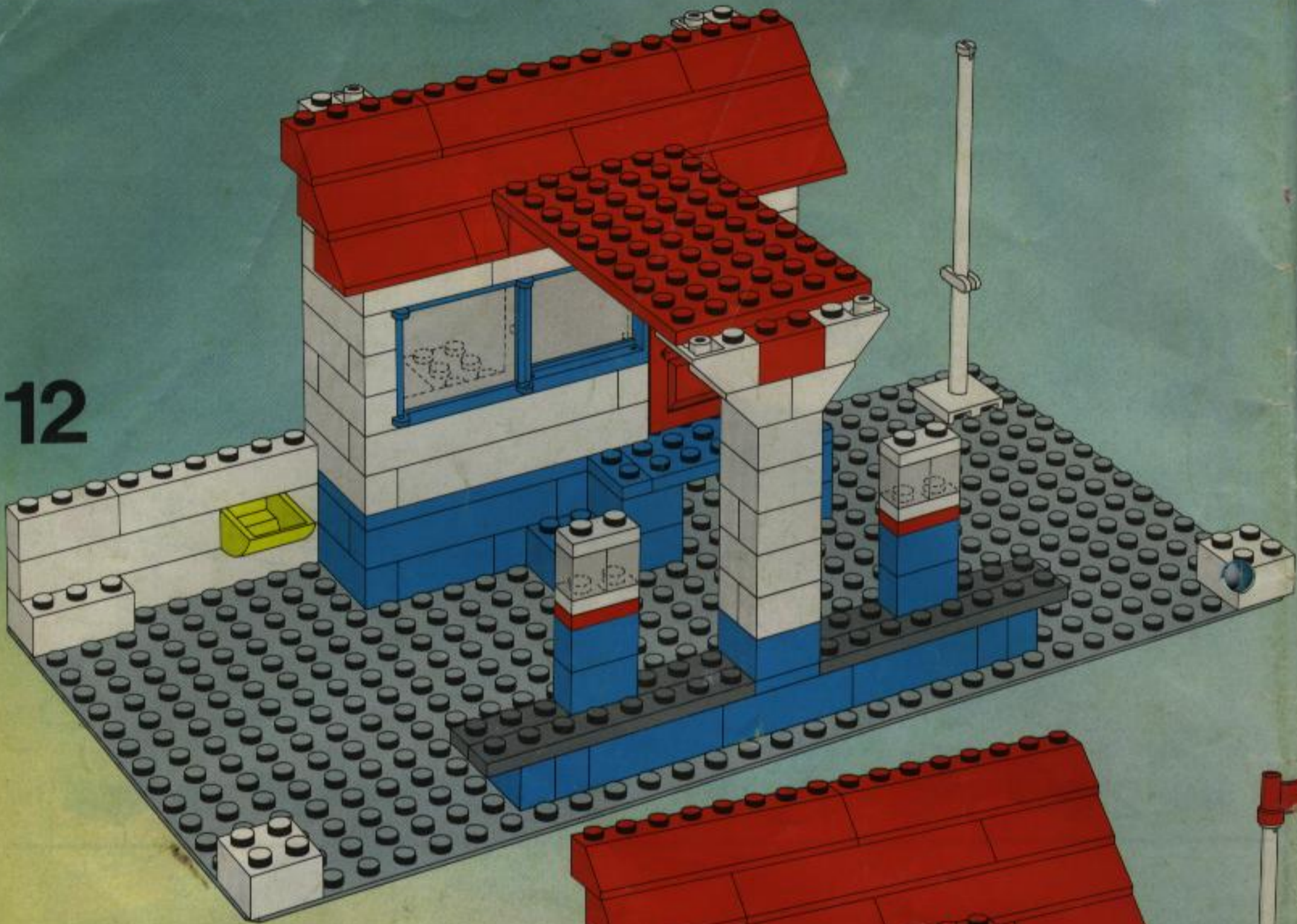

13

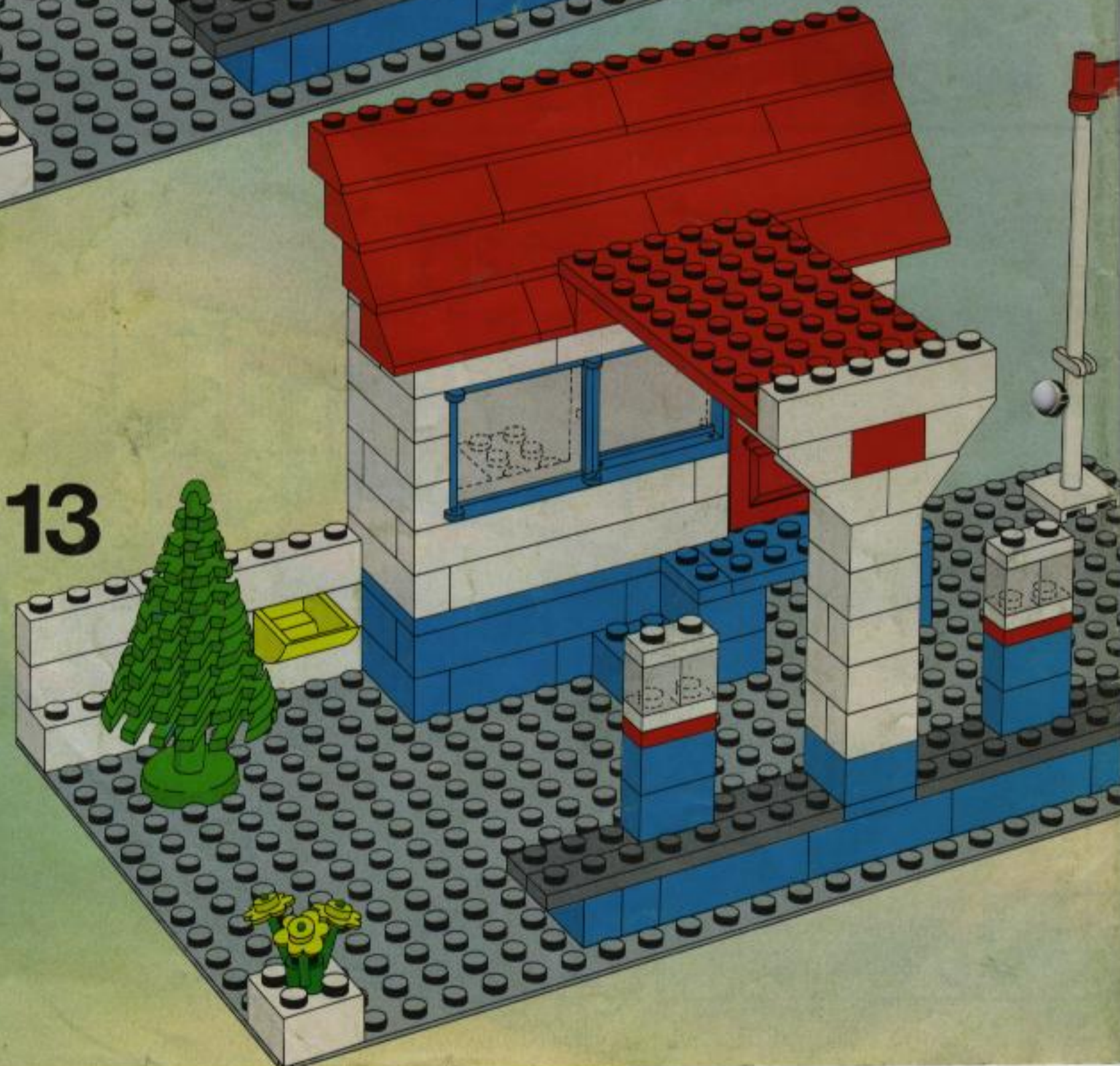



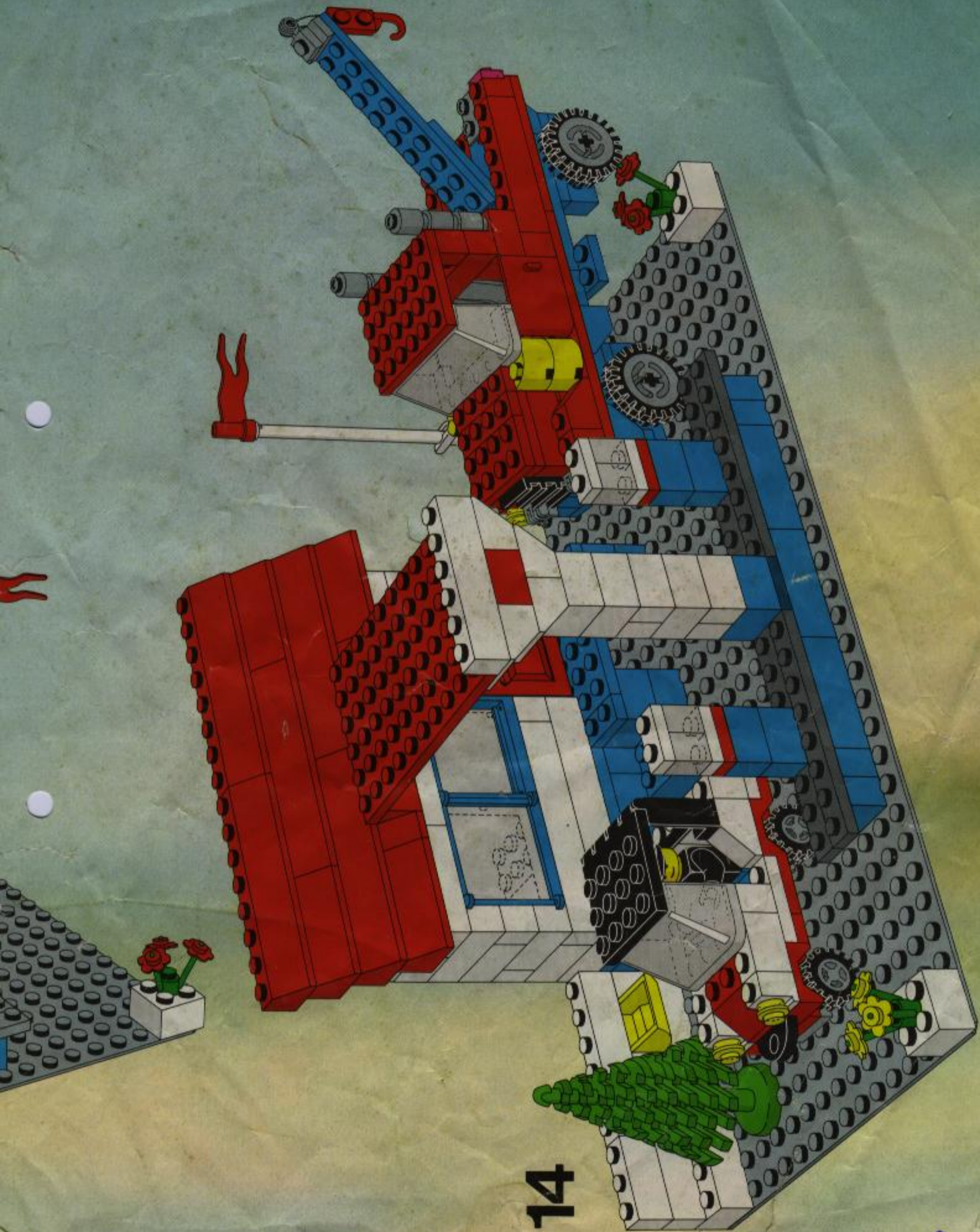

14

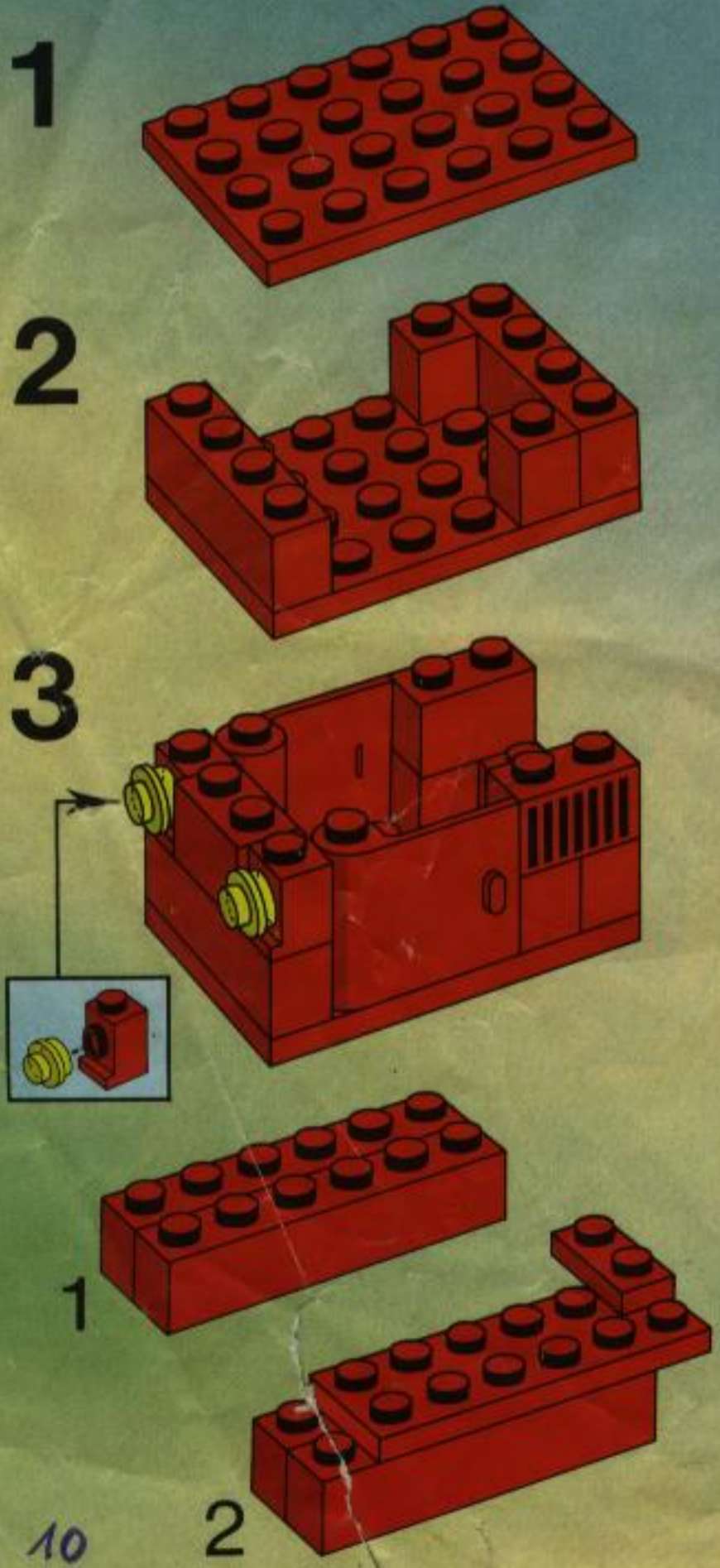

4

5

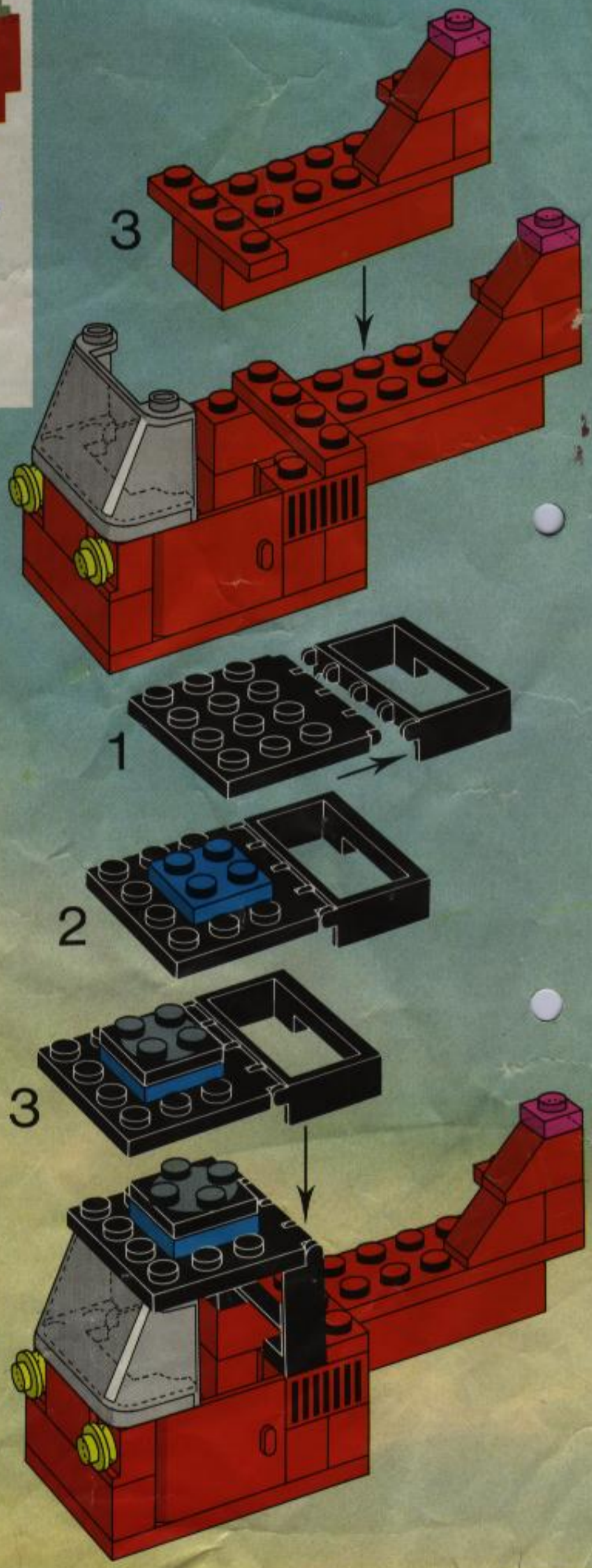

6

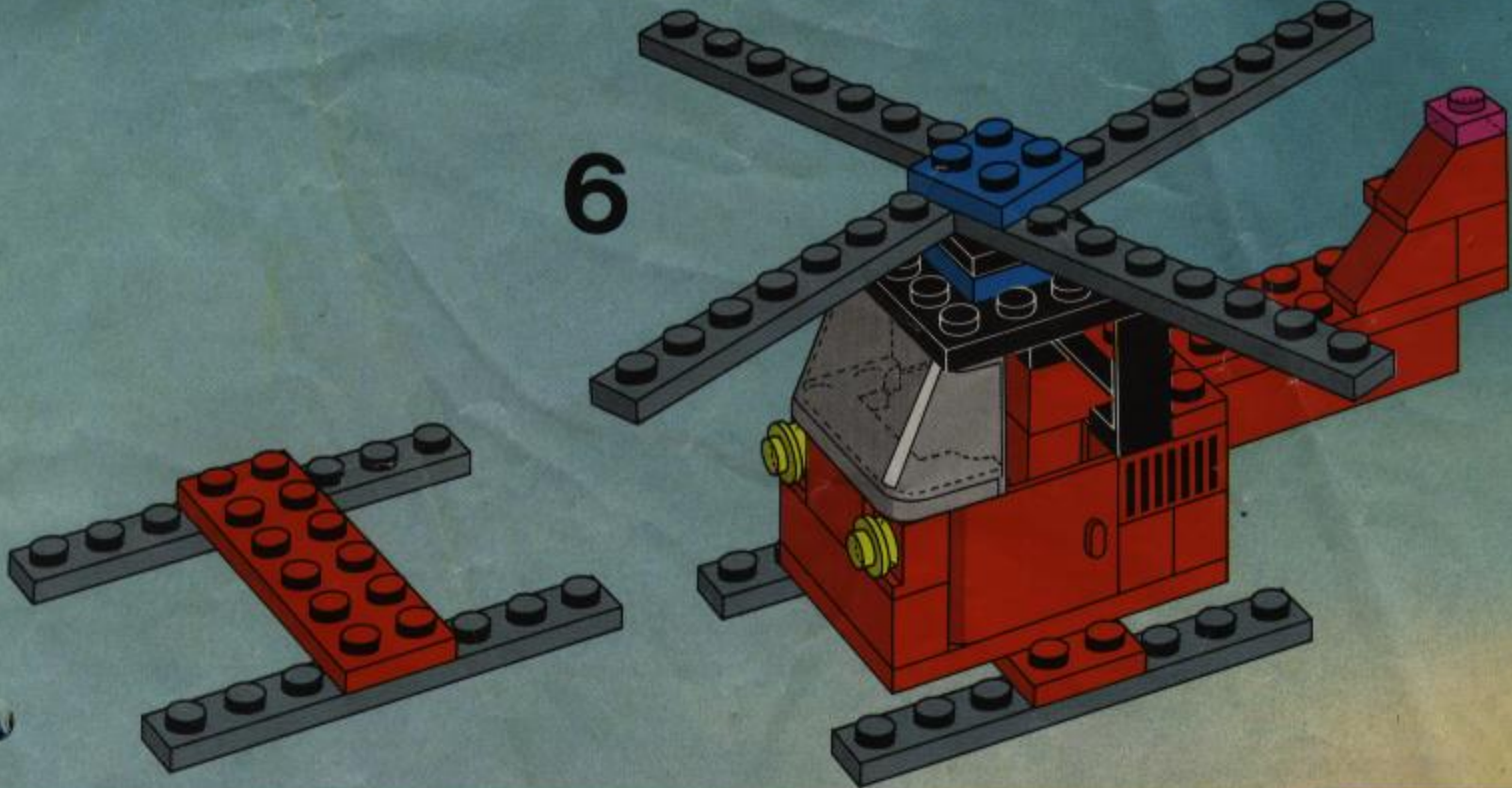

1

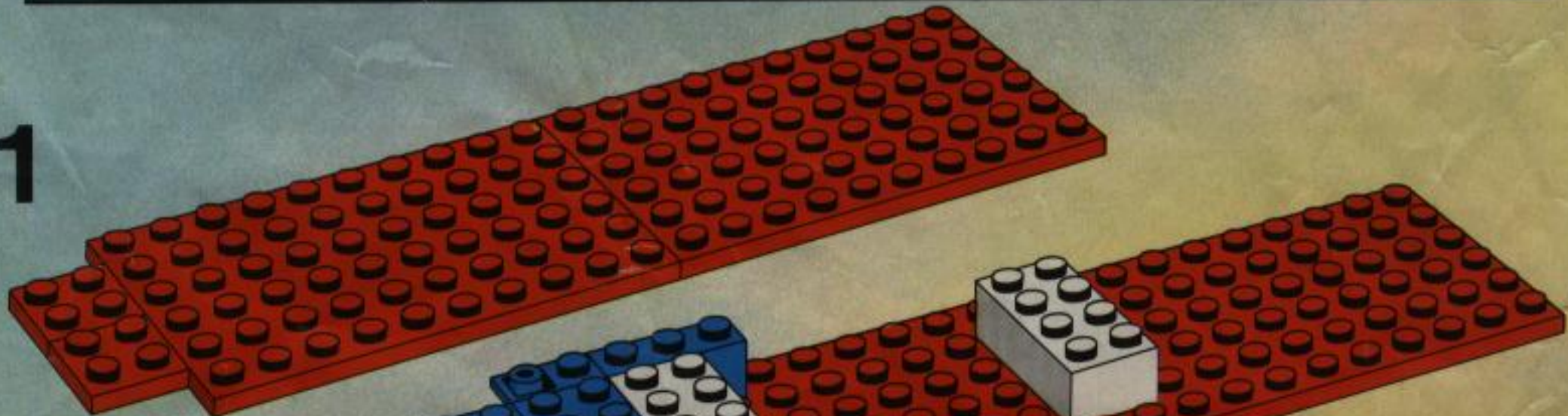

2

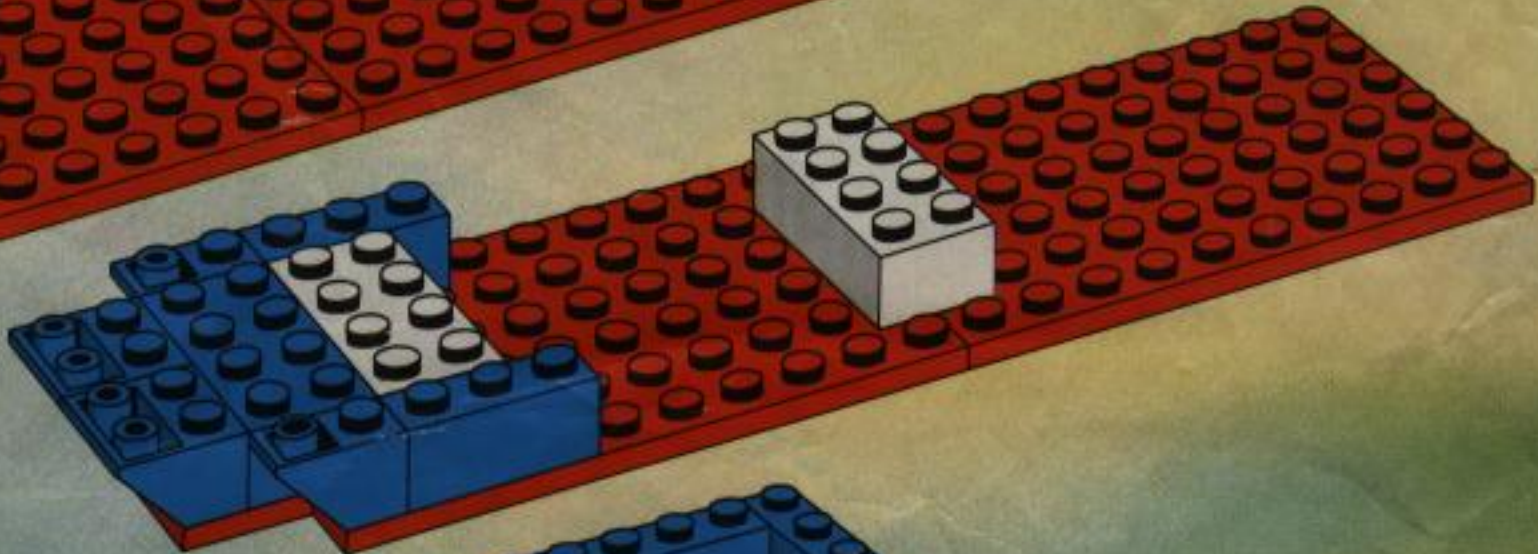

3

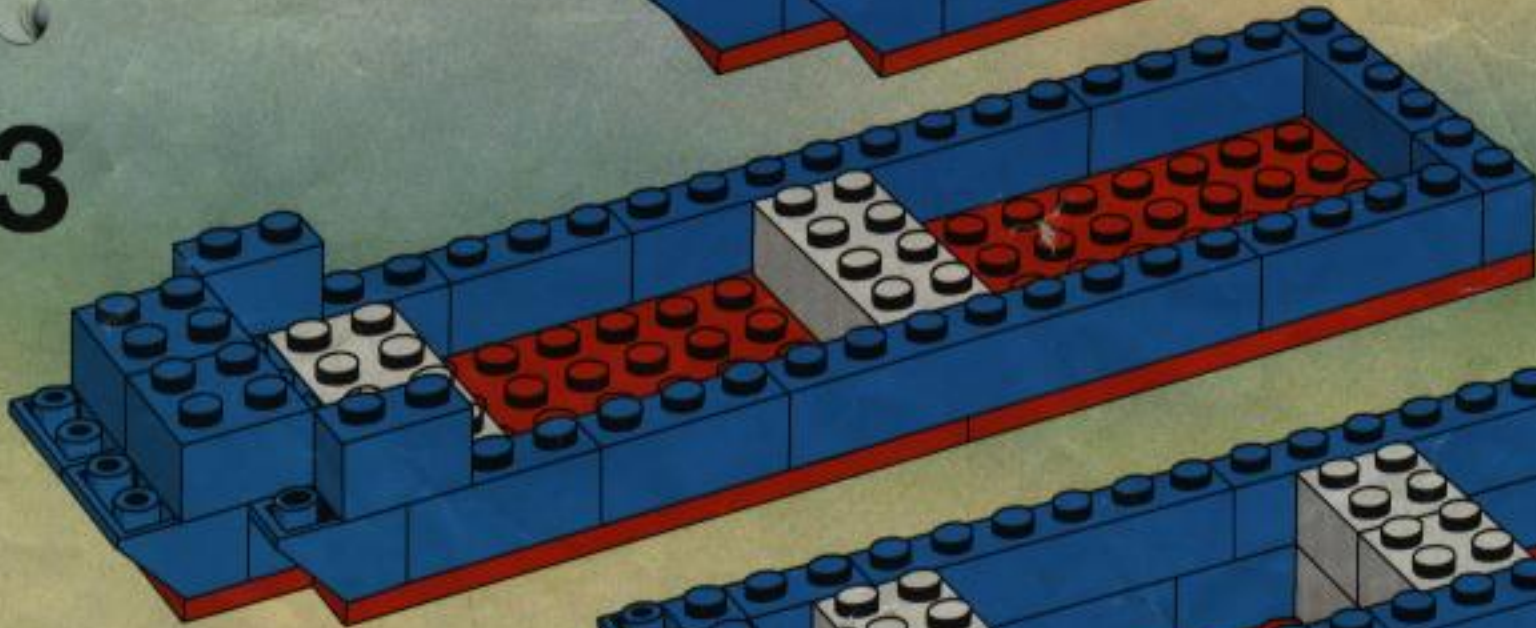

4

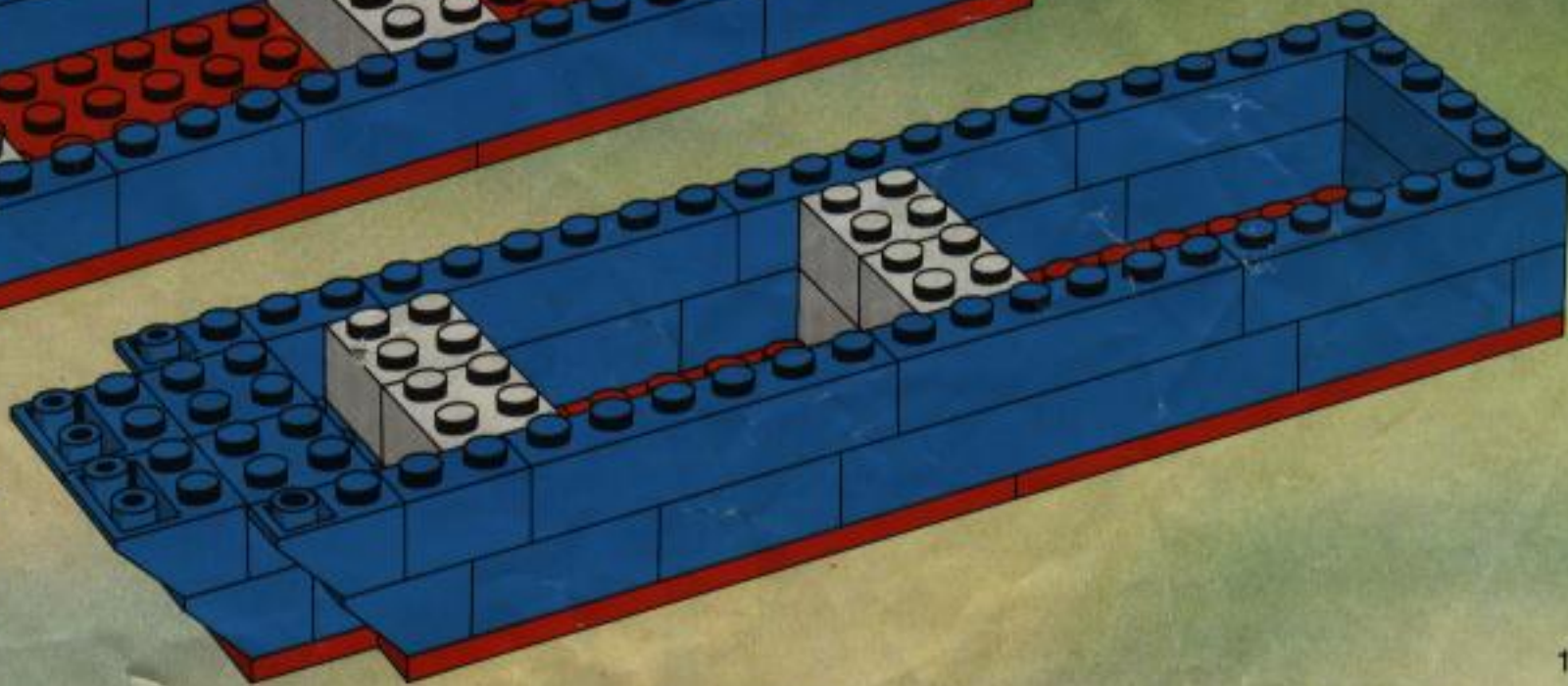

5

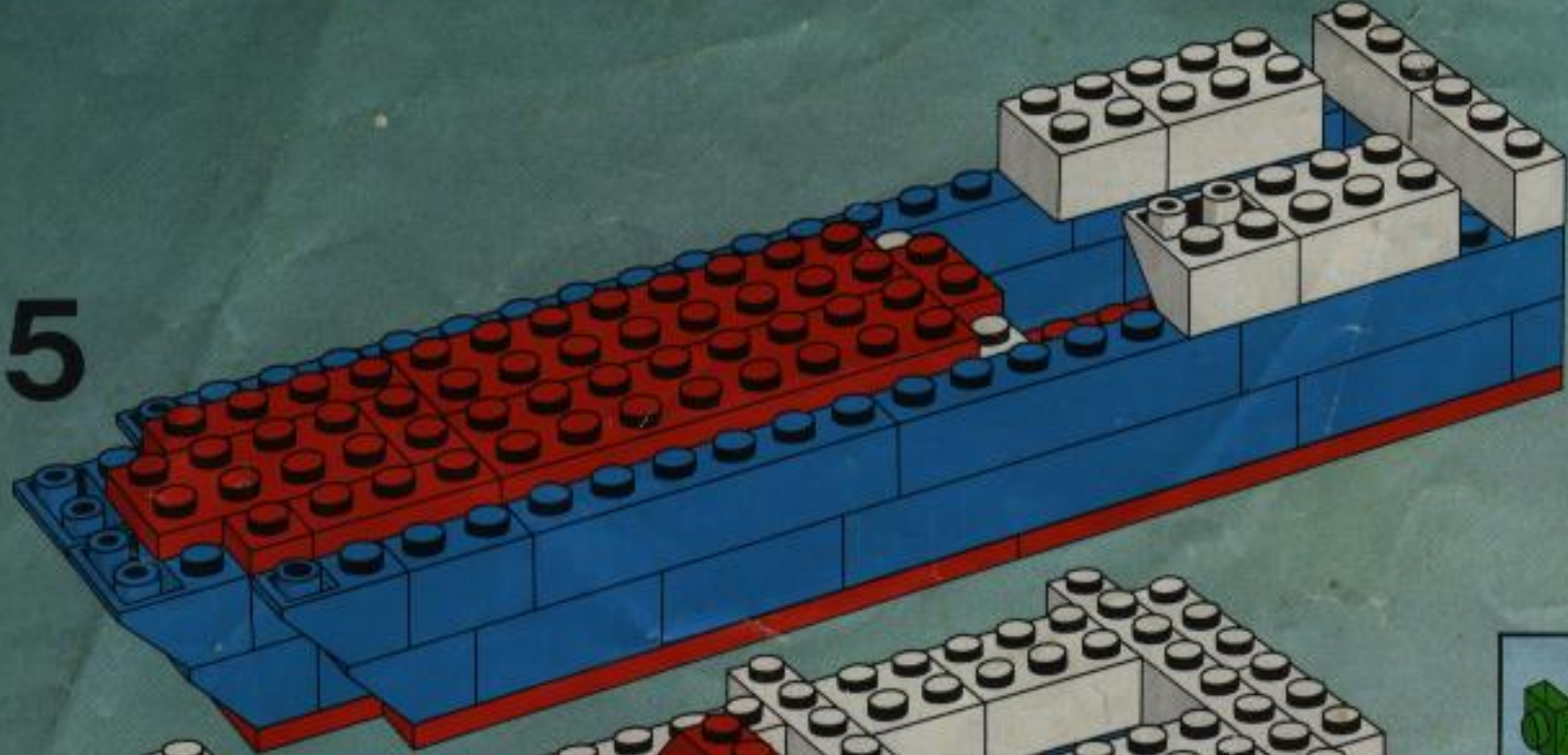

6

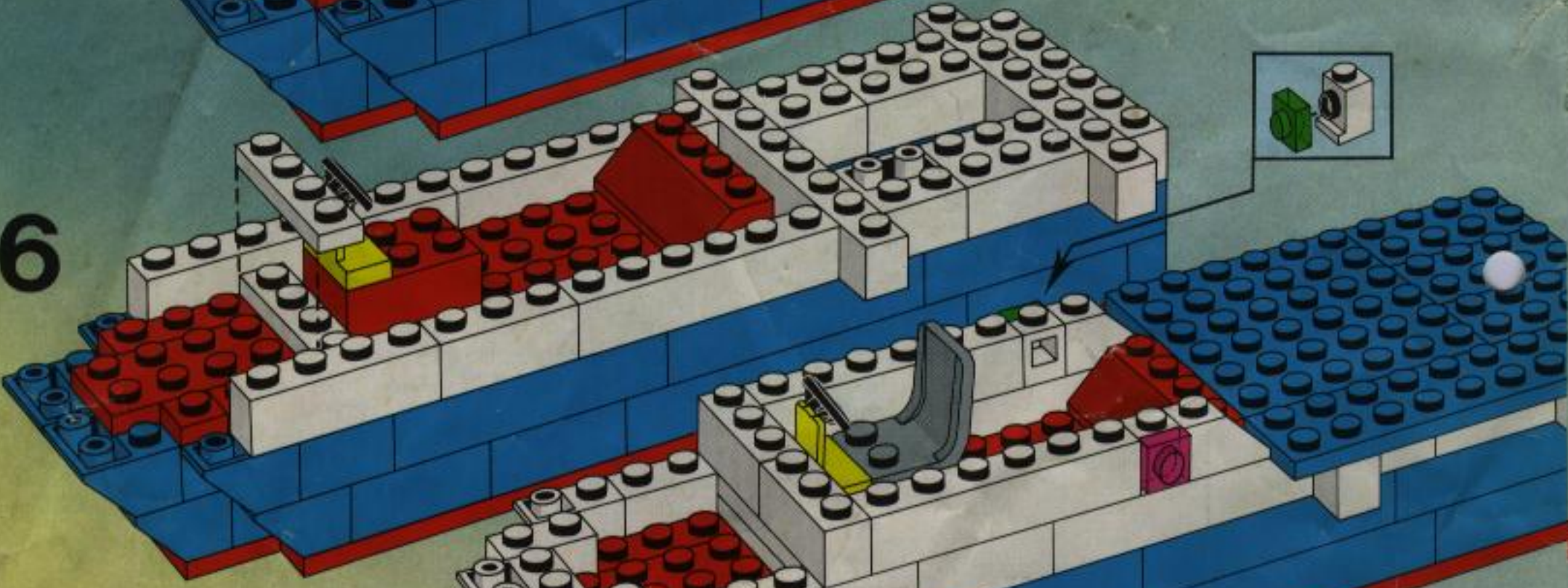

7

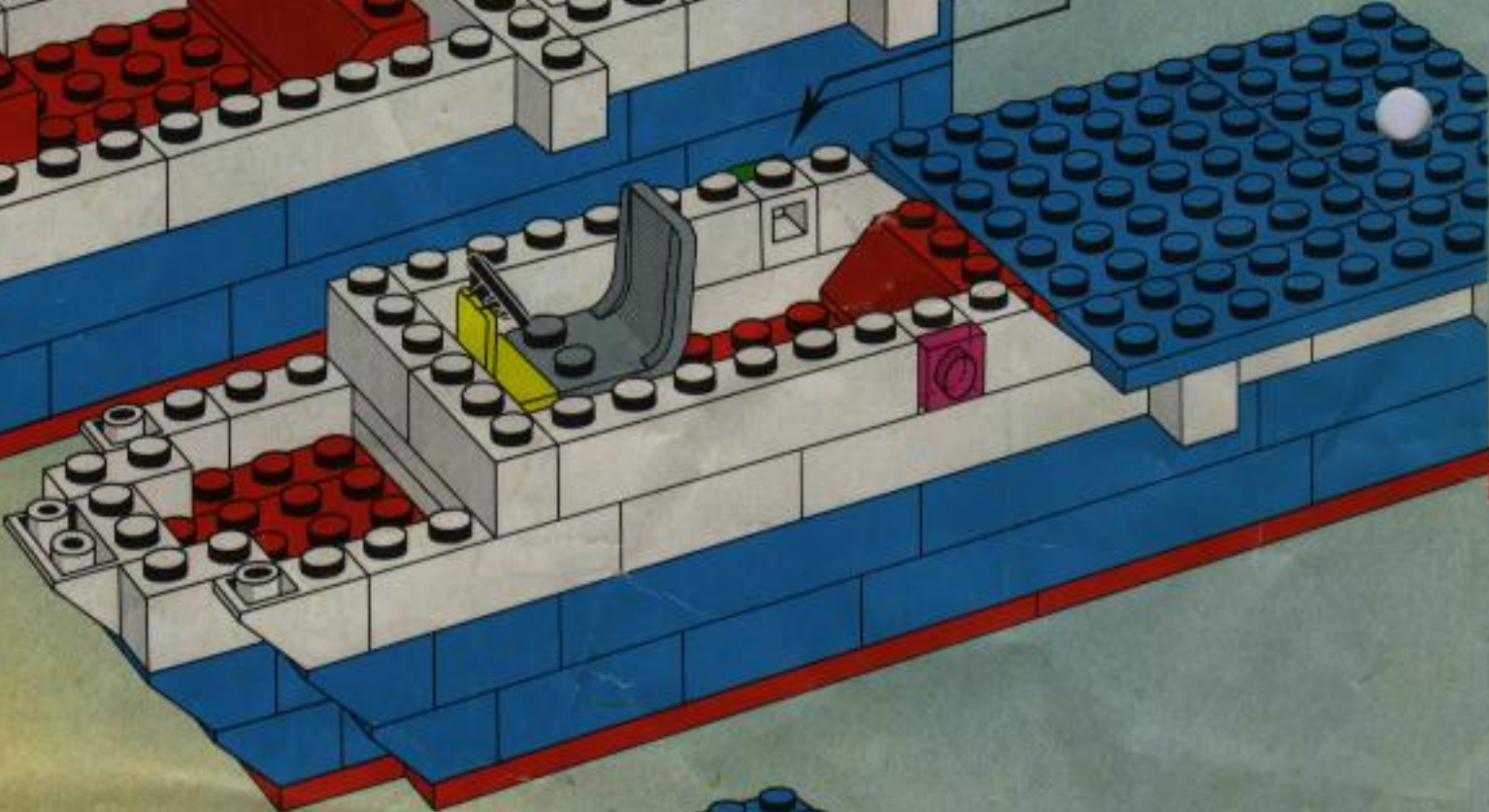

8

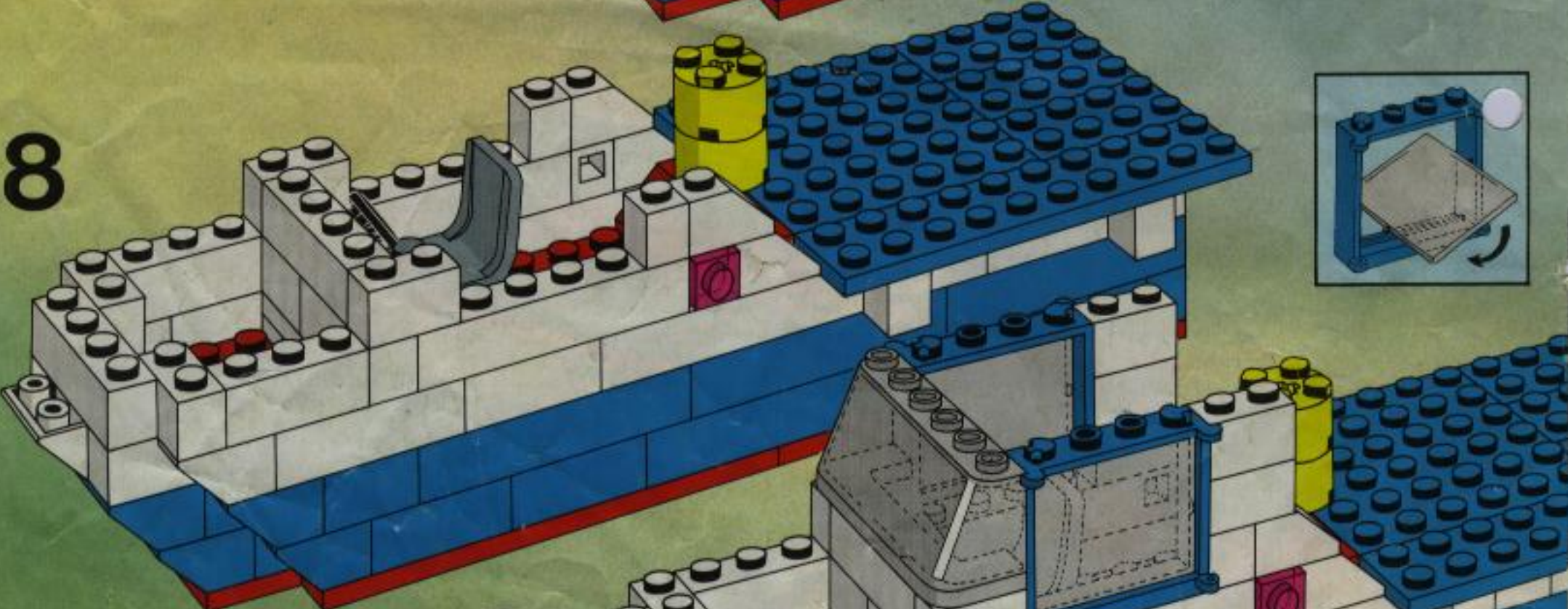

9

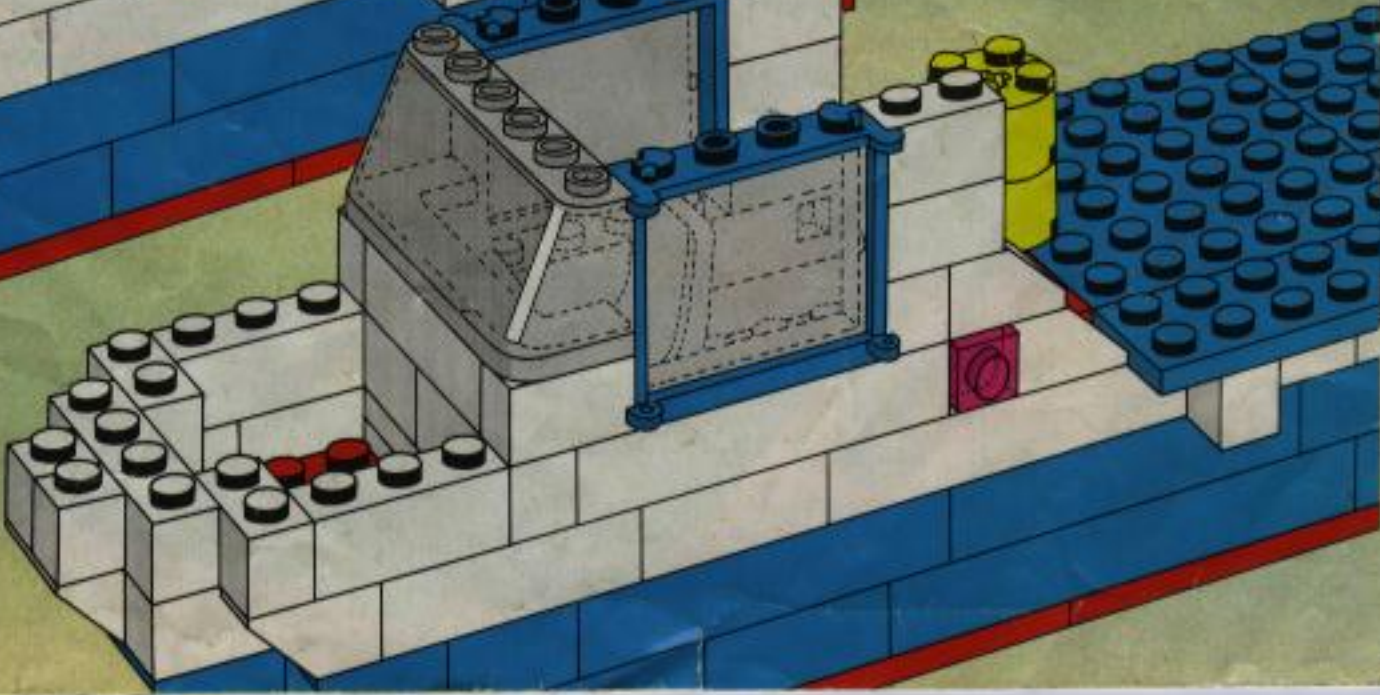

10

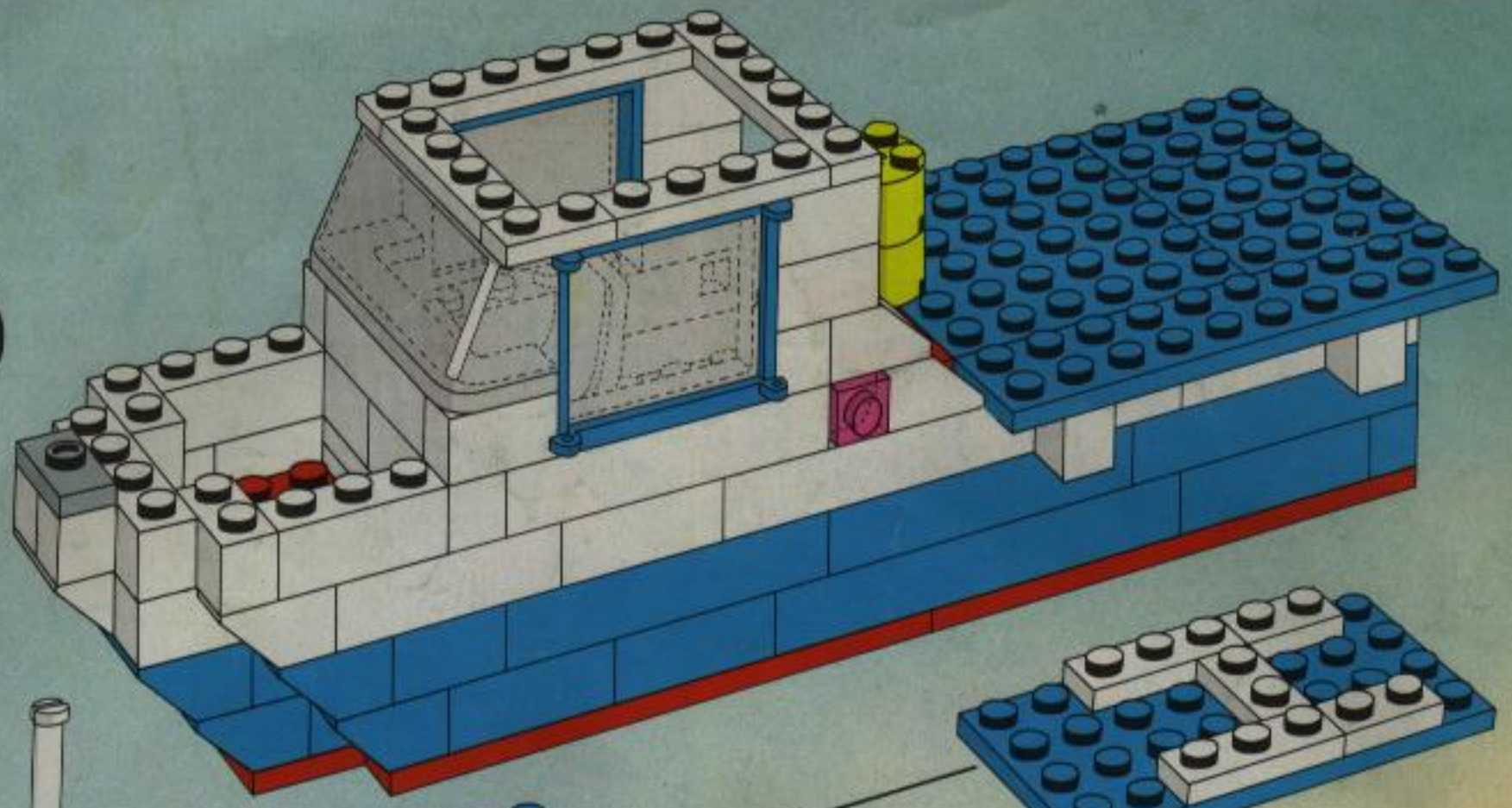

11

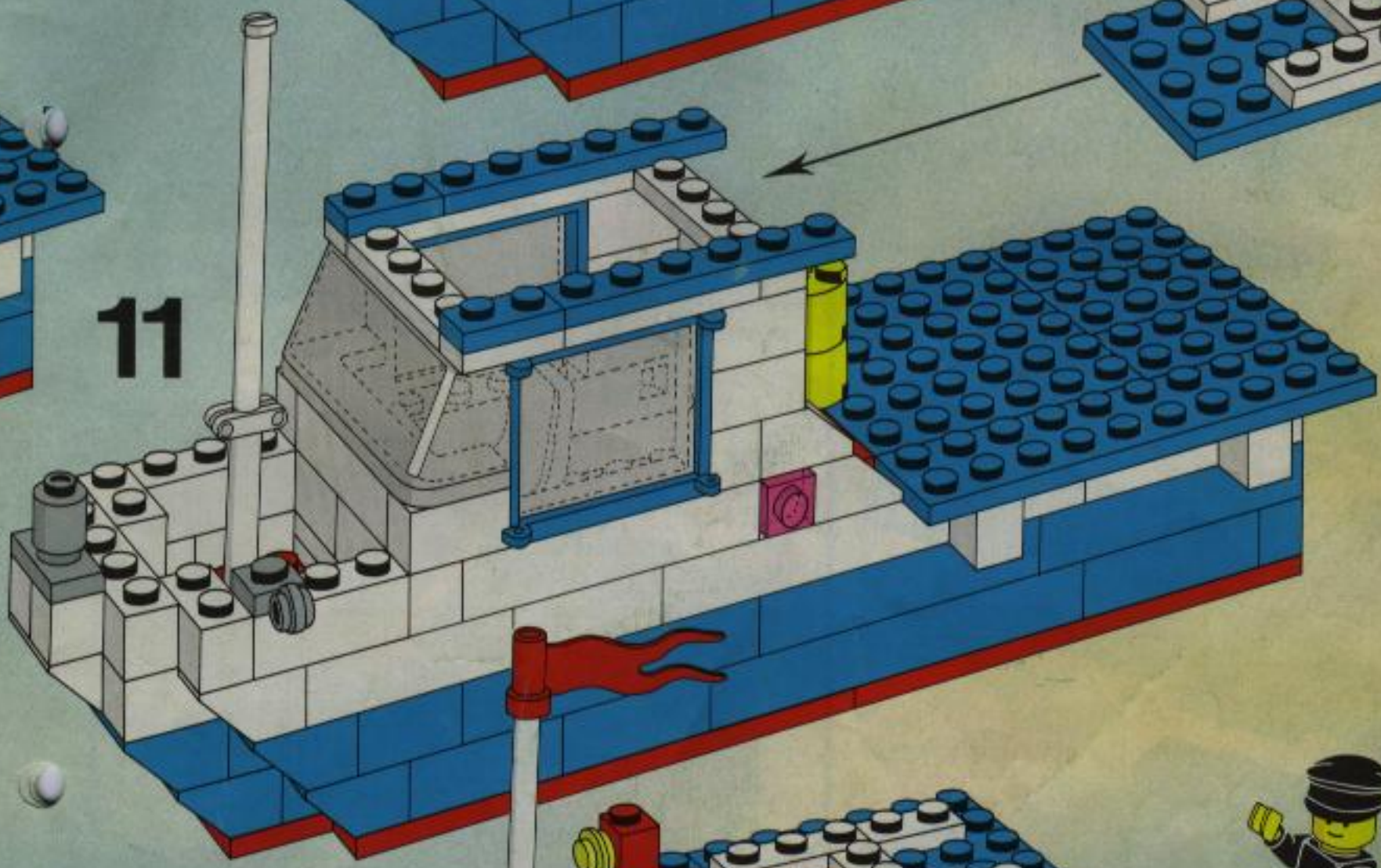

12

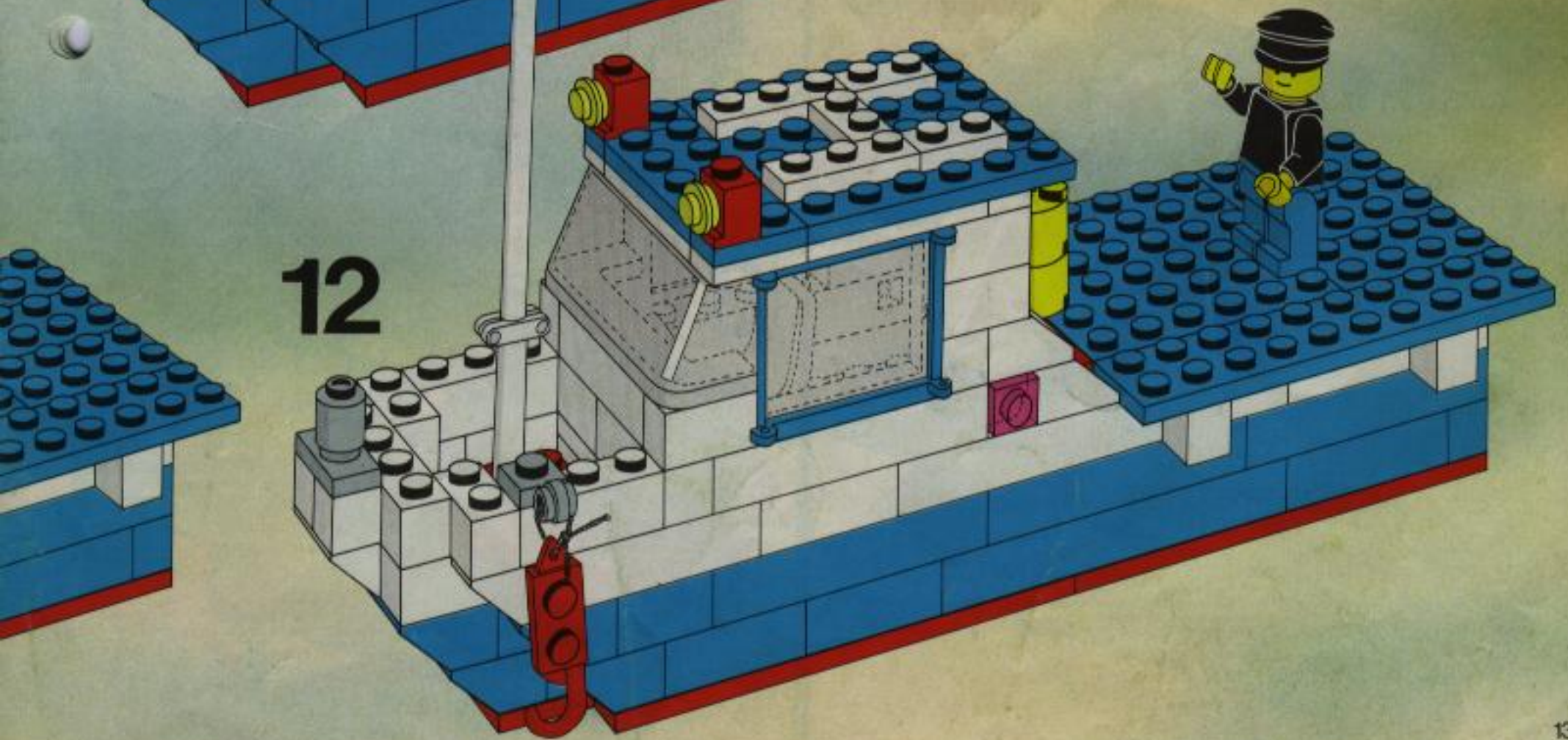

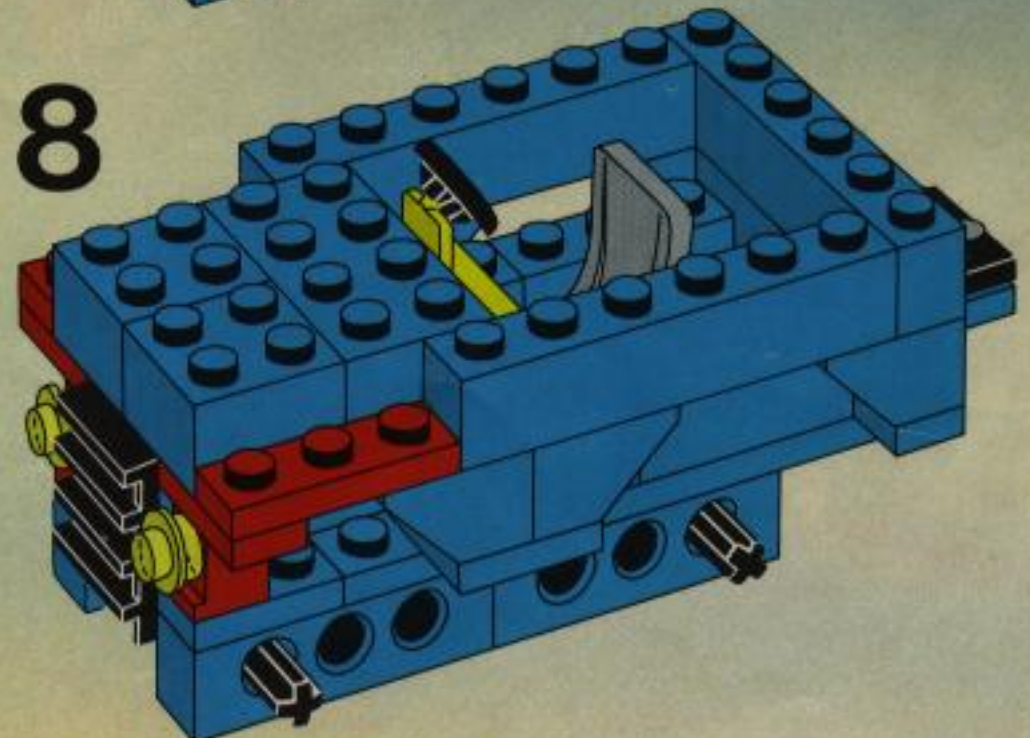
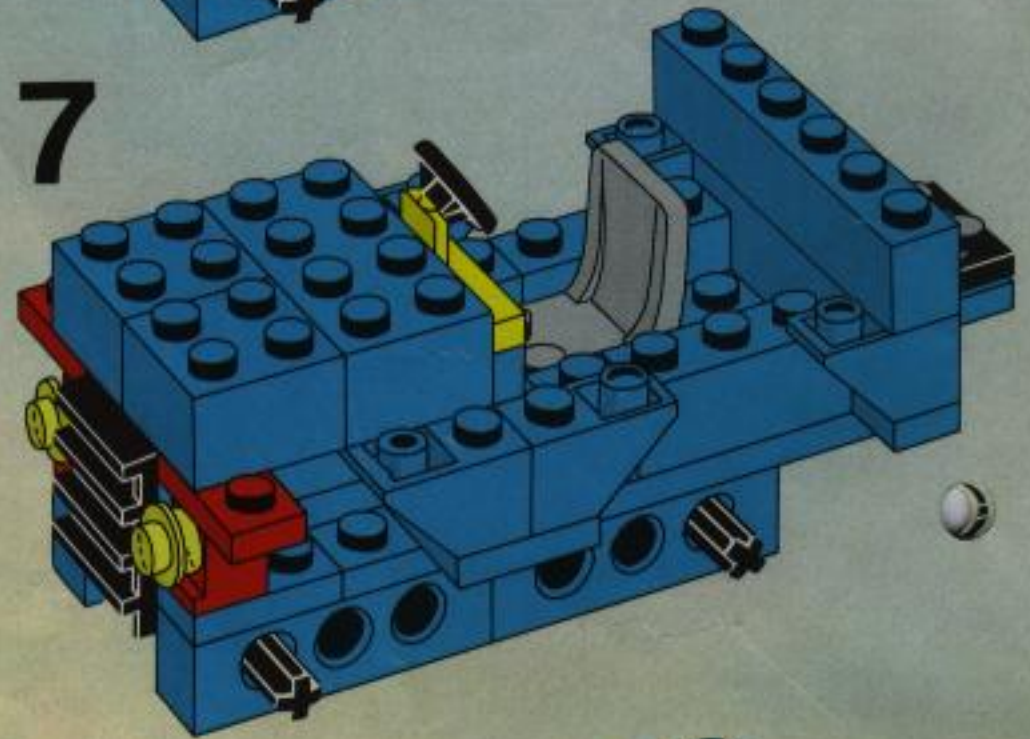
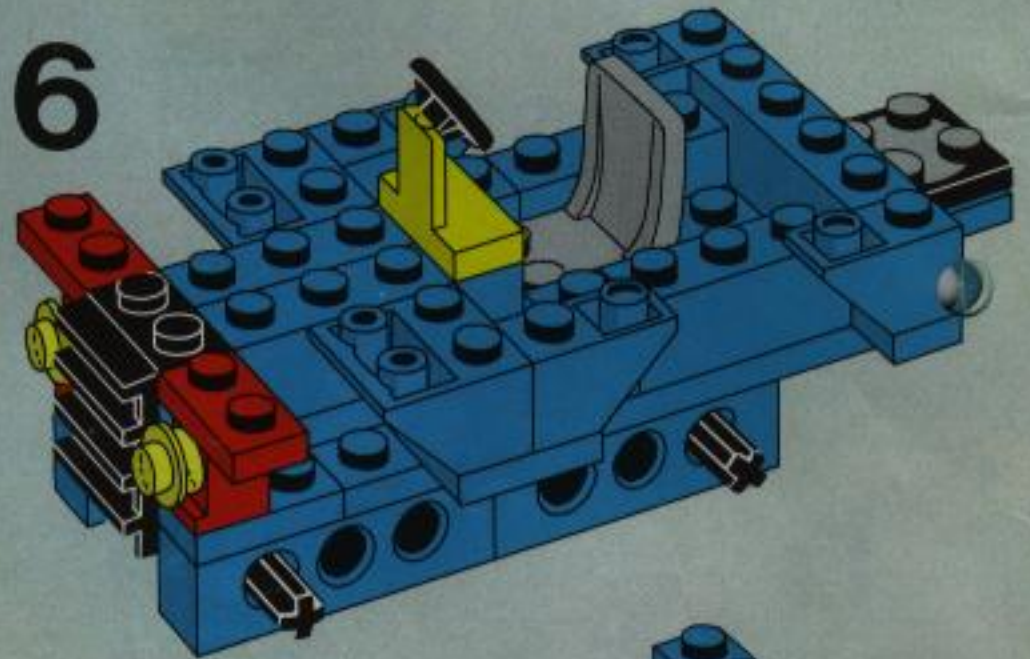
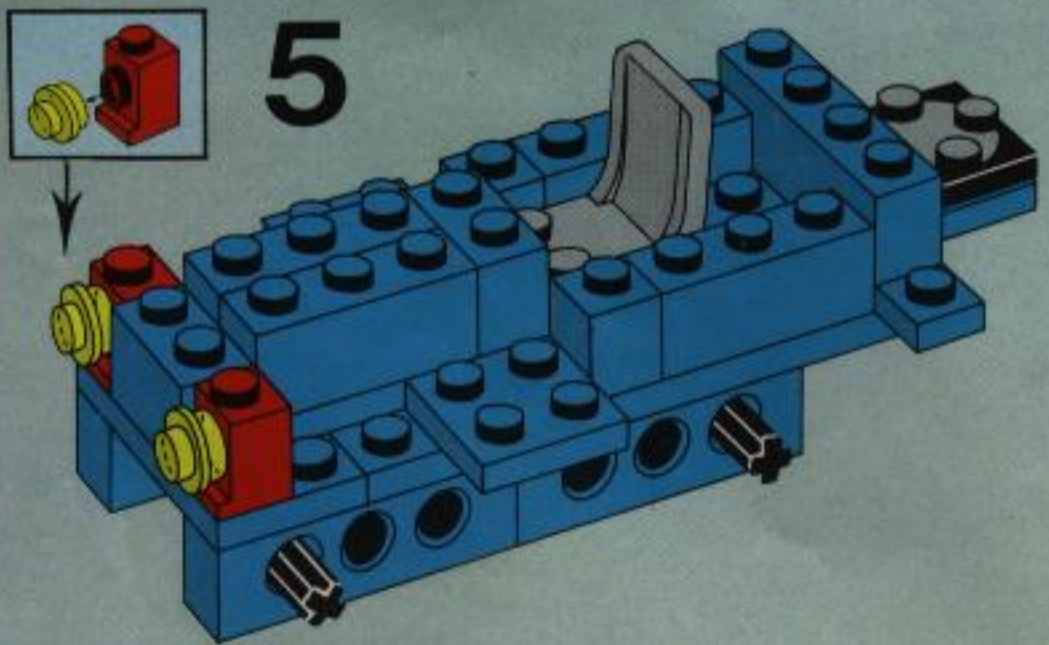
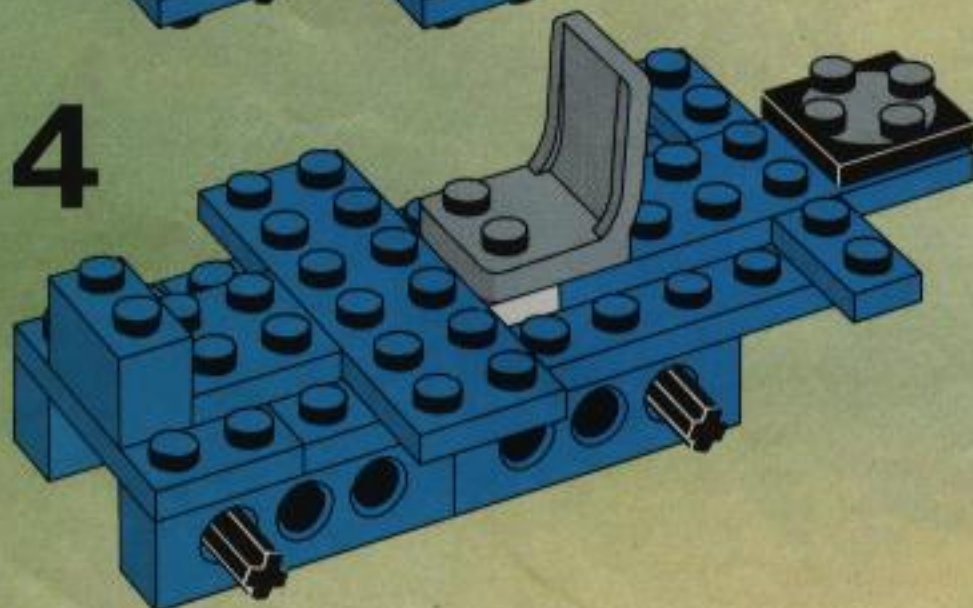
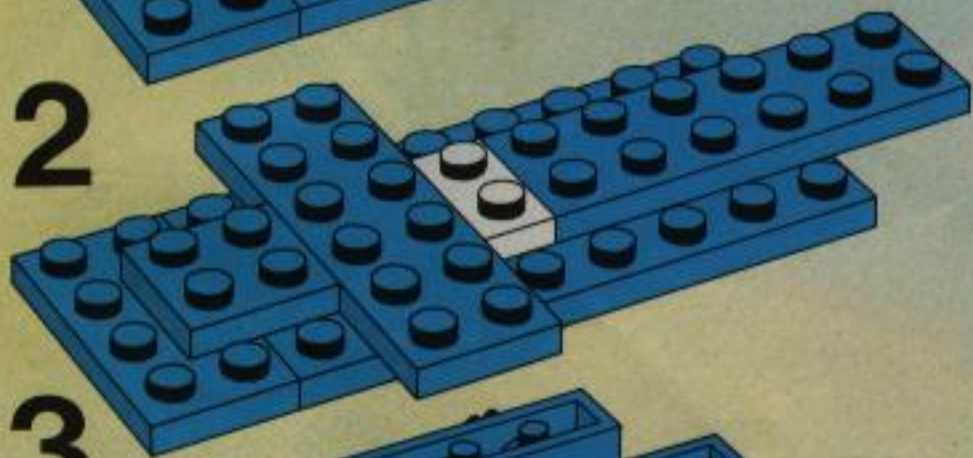
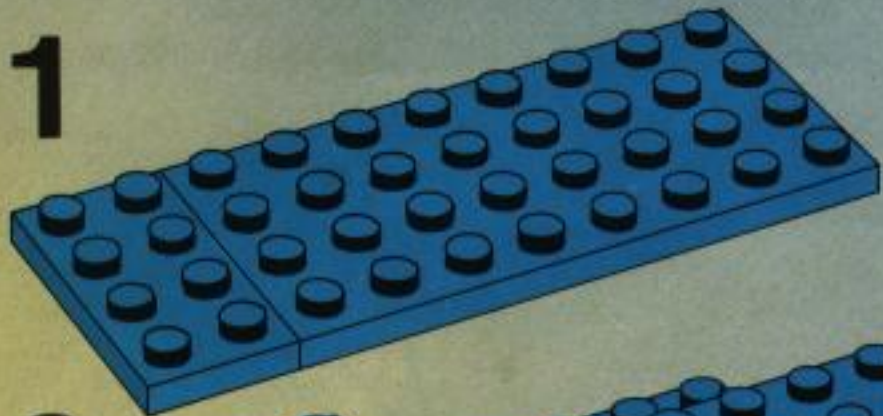

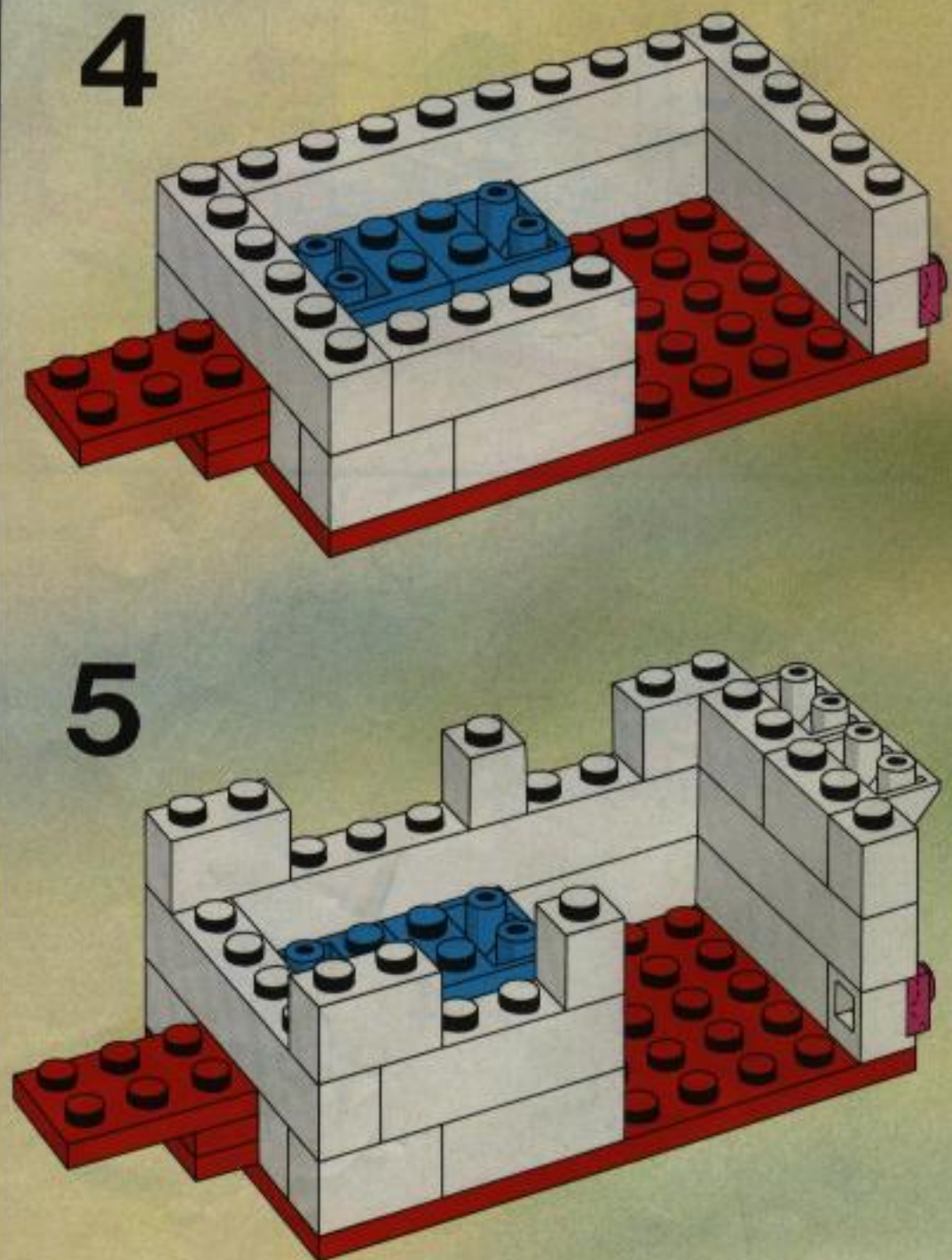
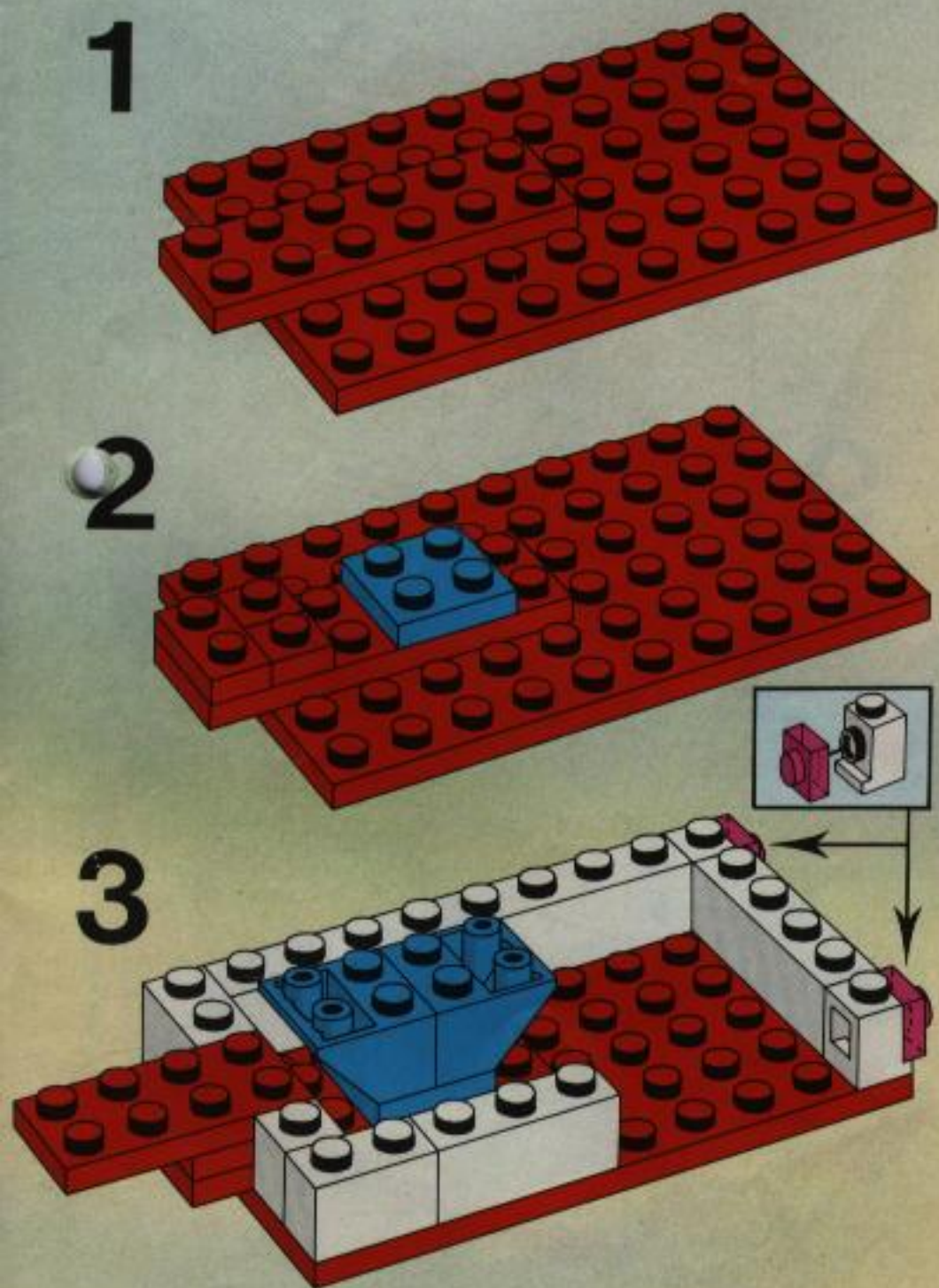
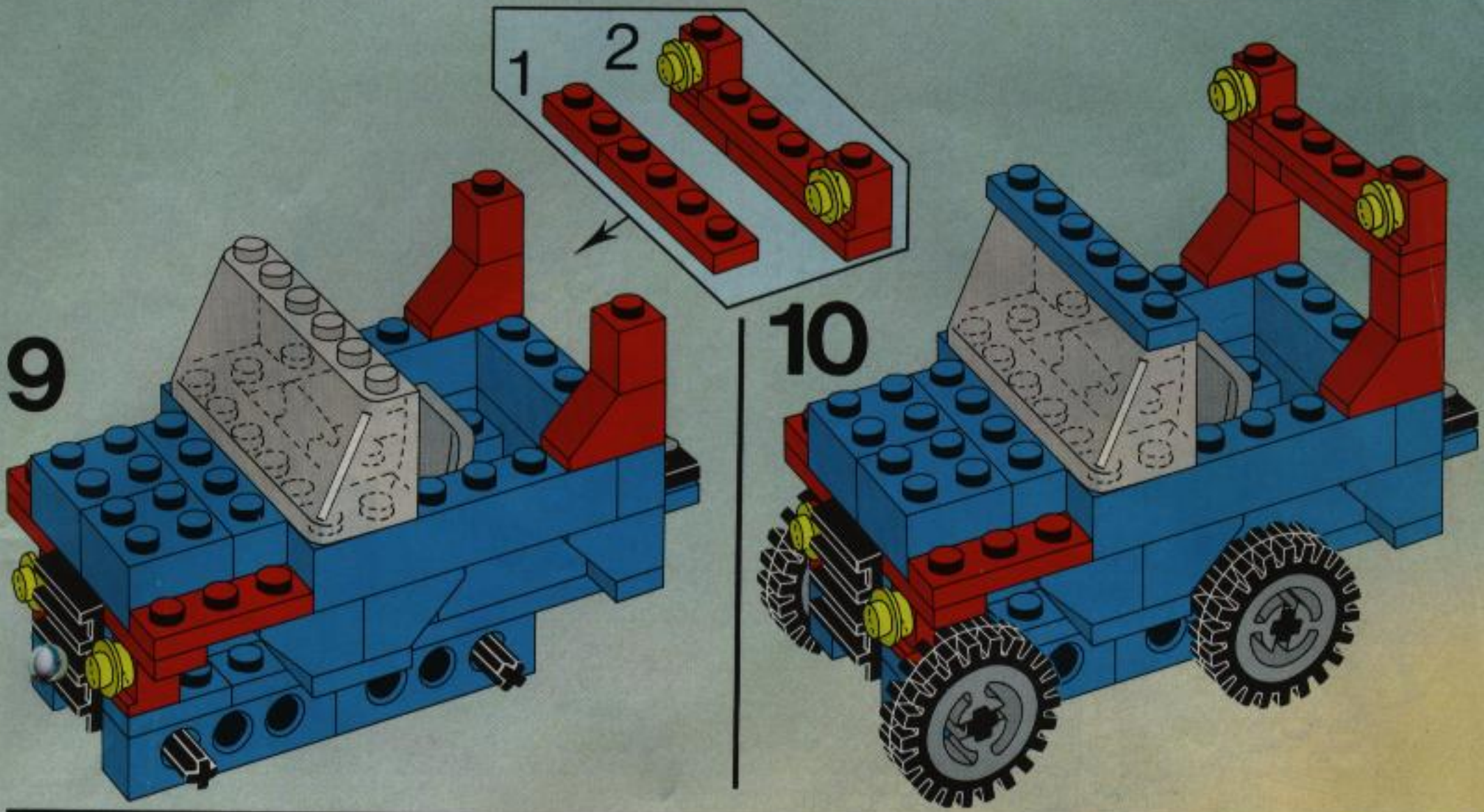

6

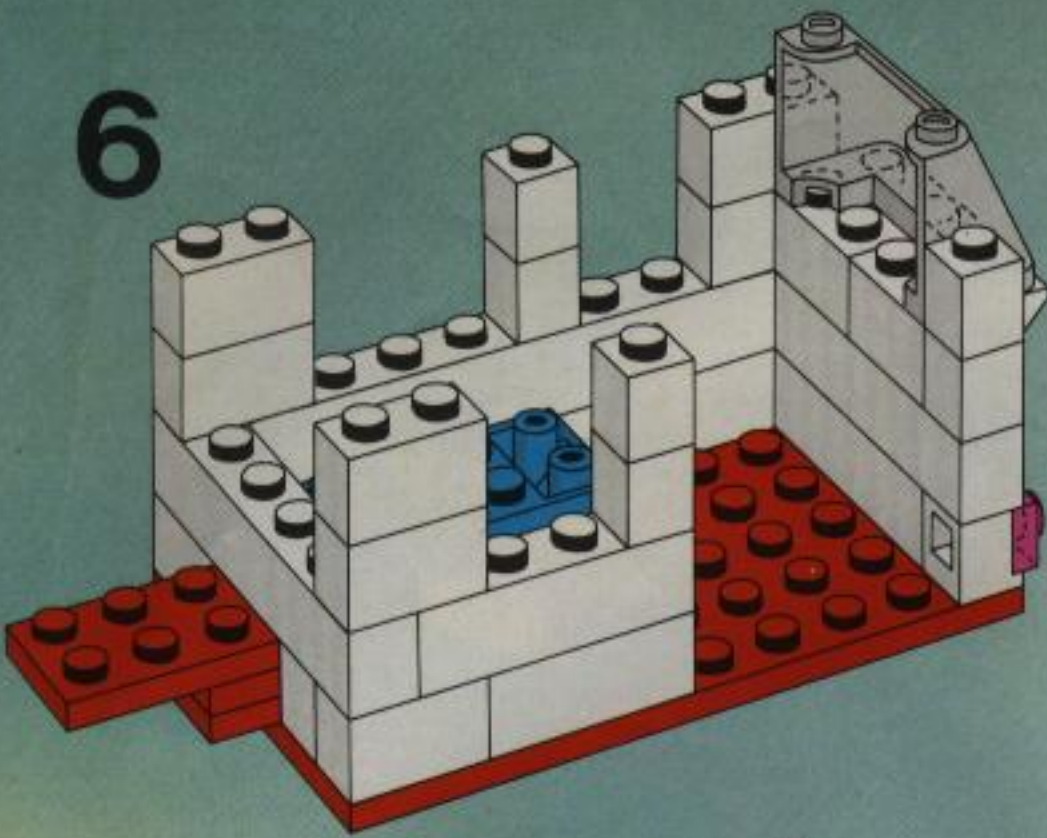

7

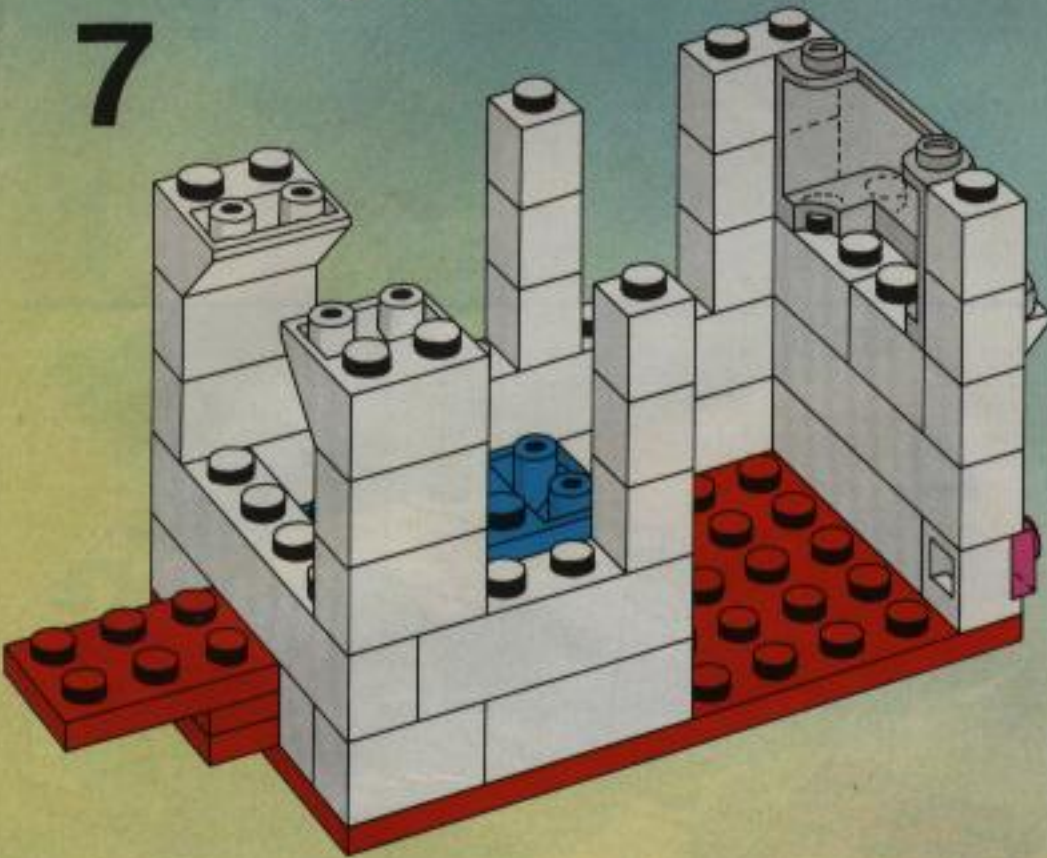

8

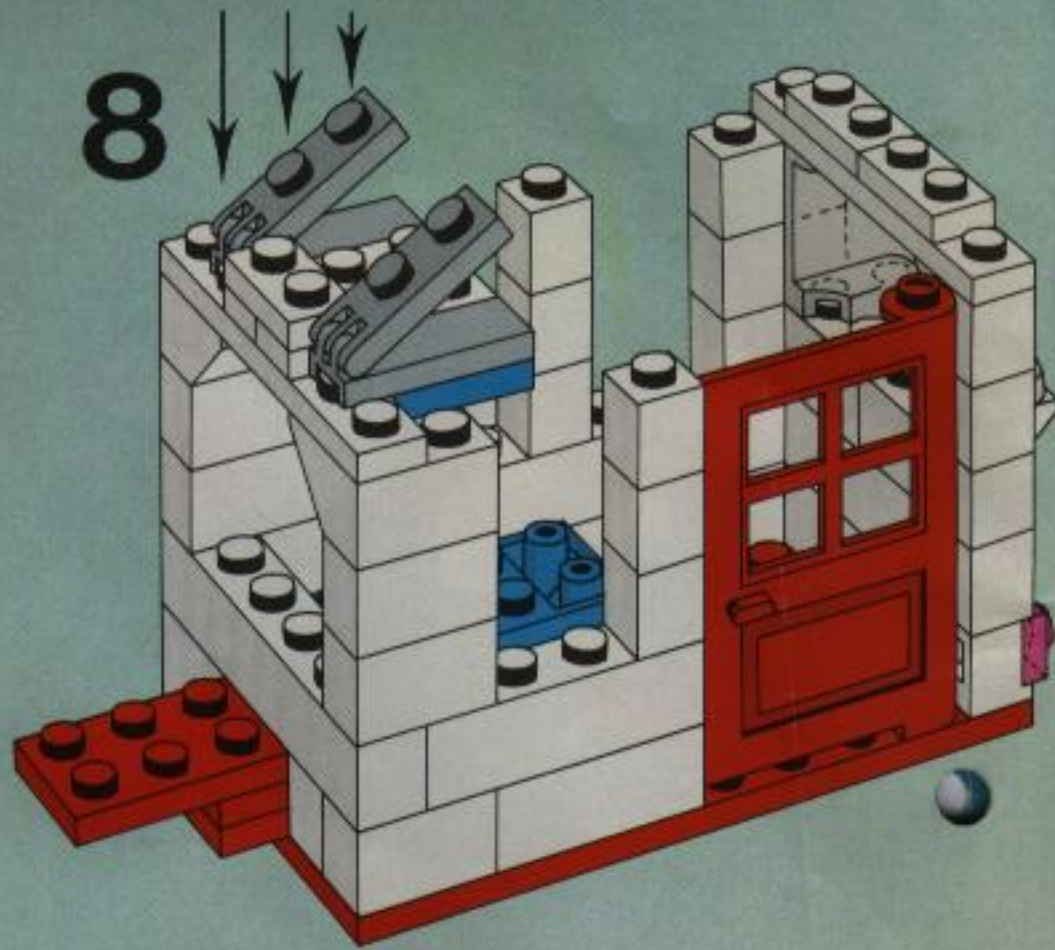

9

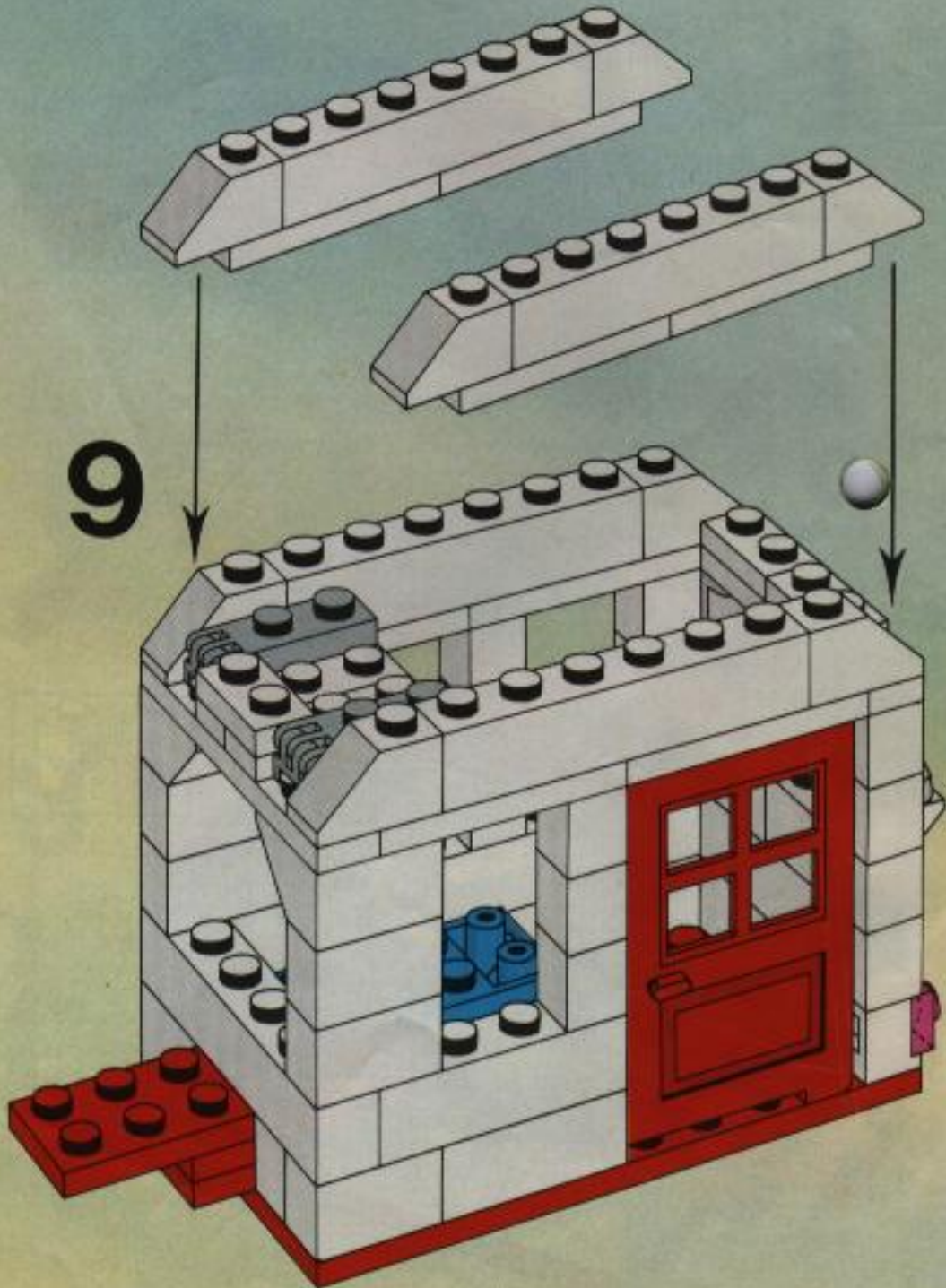

1

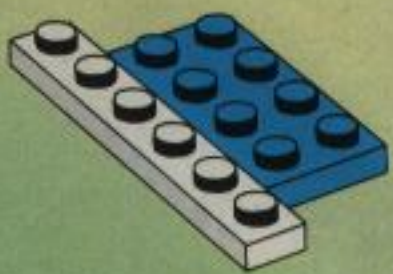

2

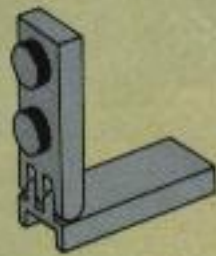

3

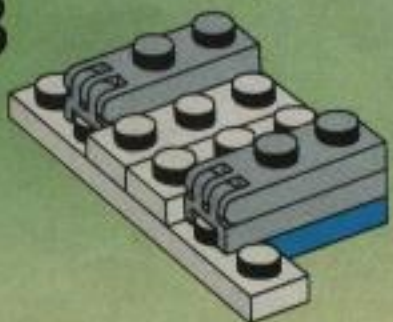

4

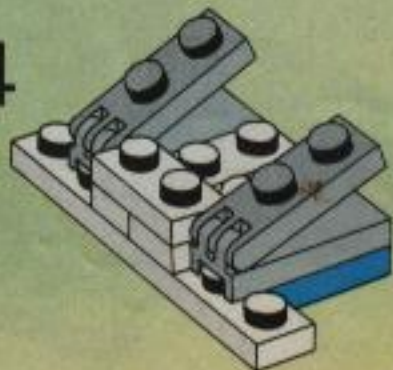



10

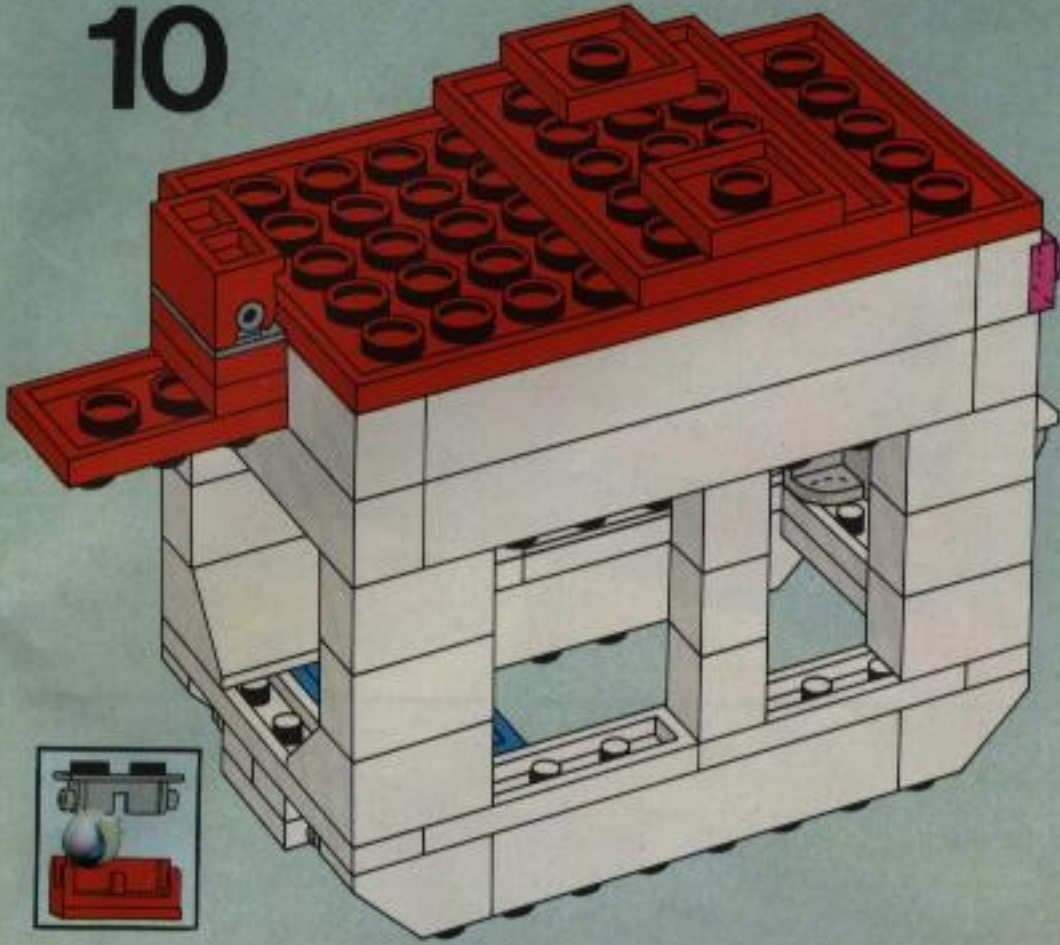

11

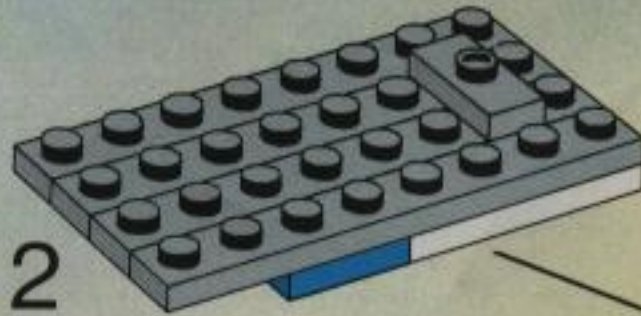
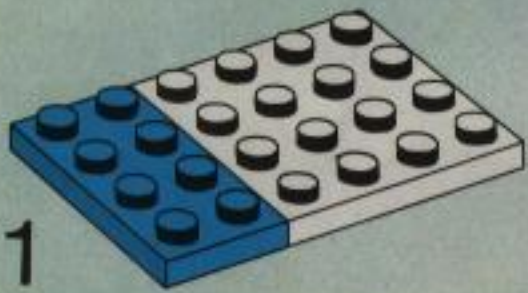
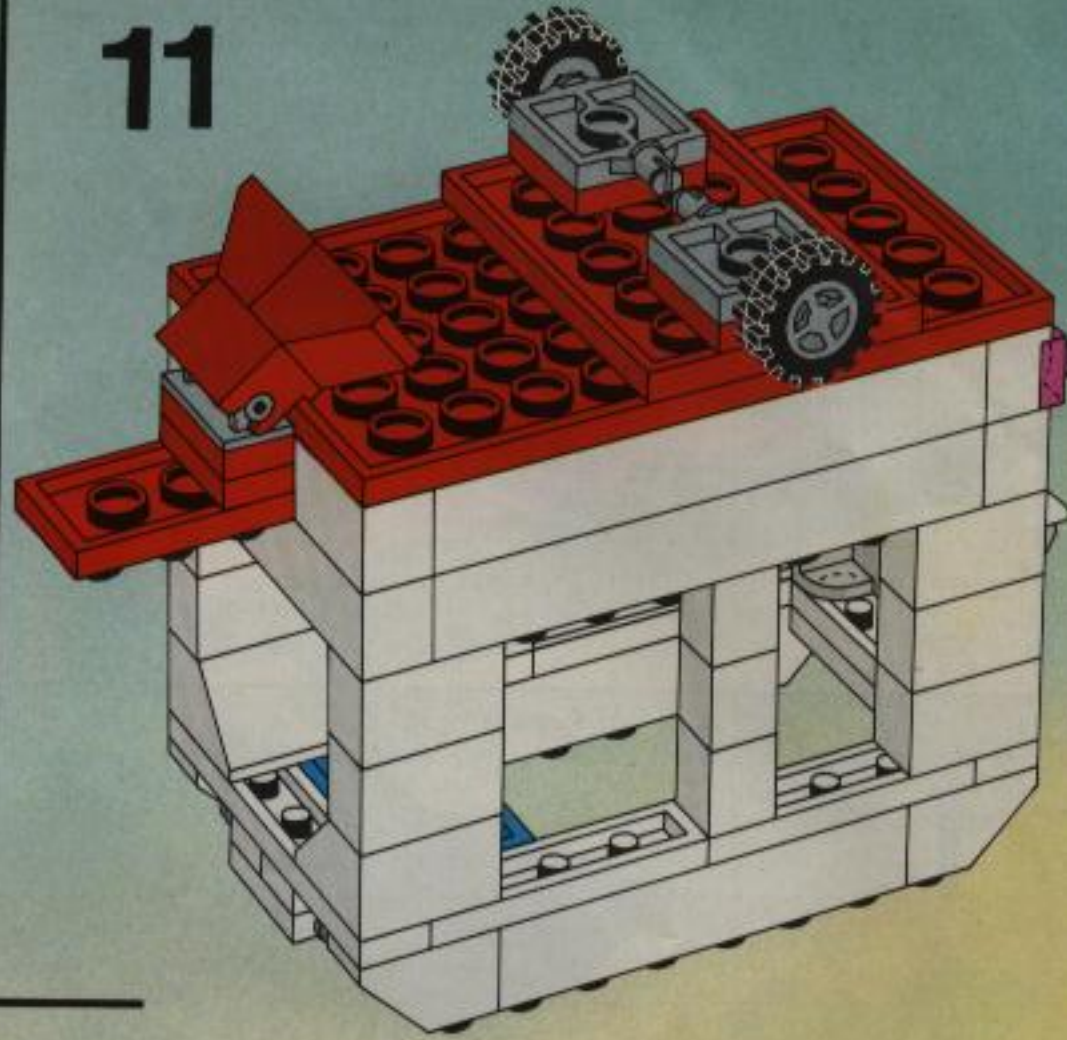

12

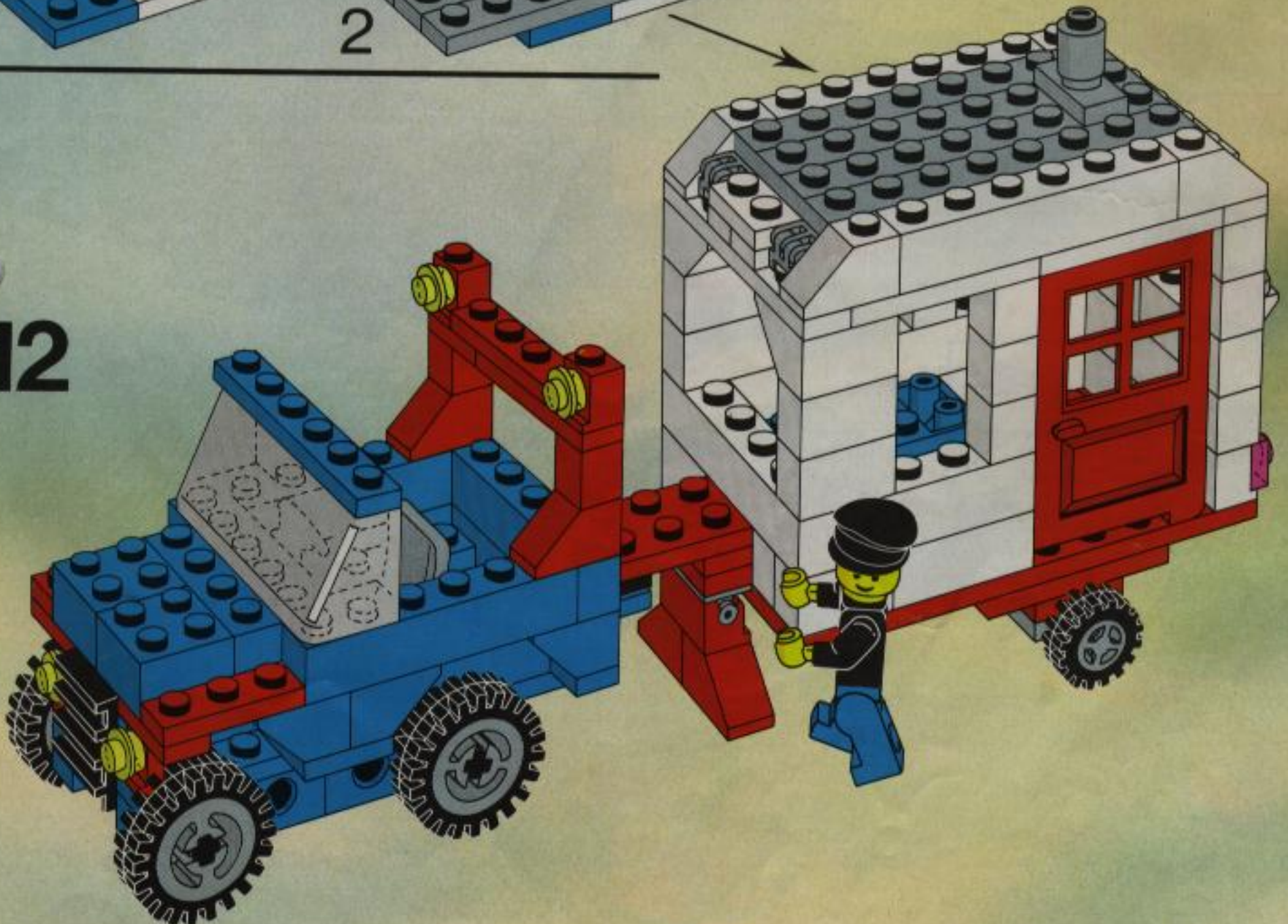

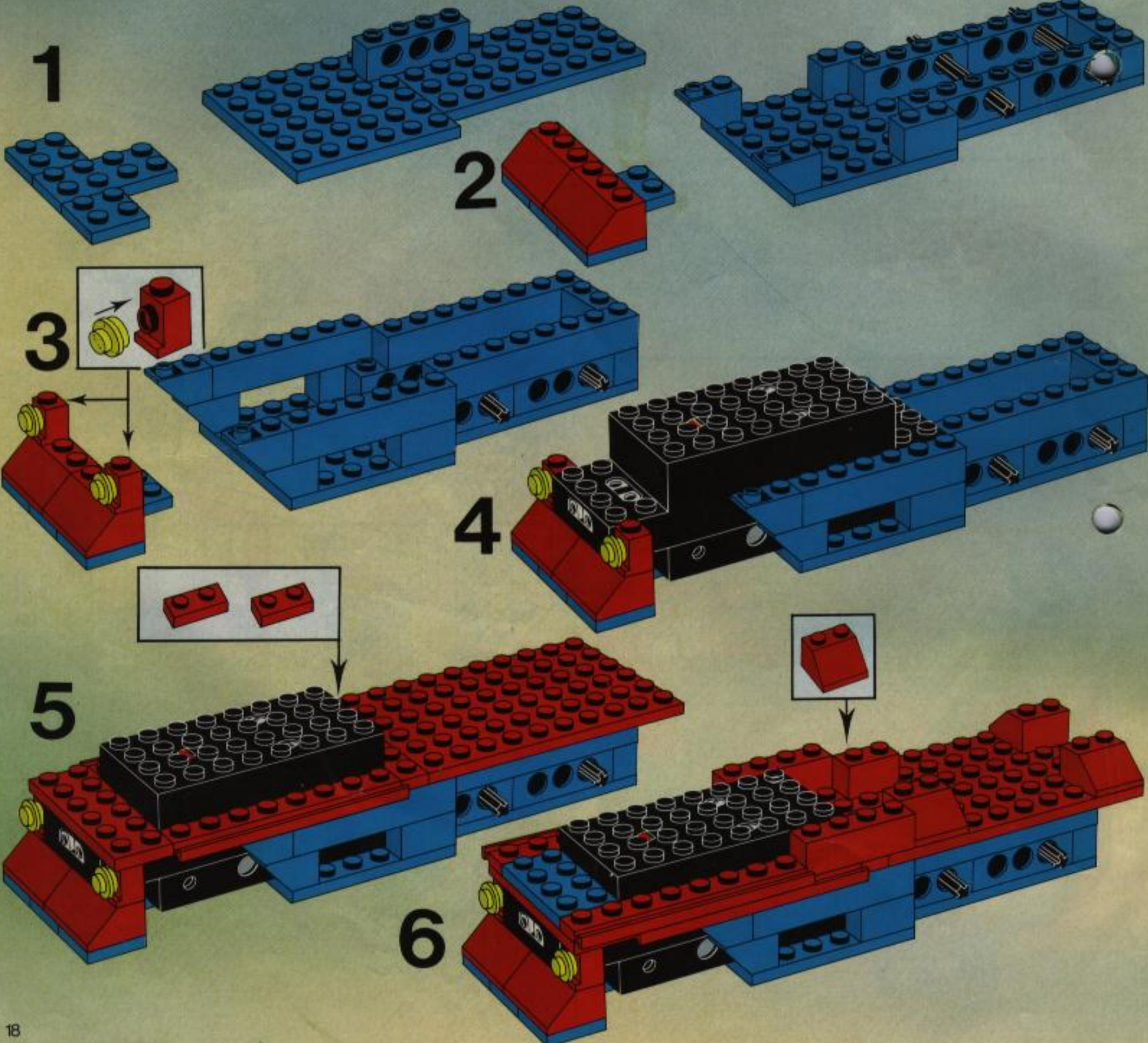
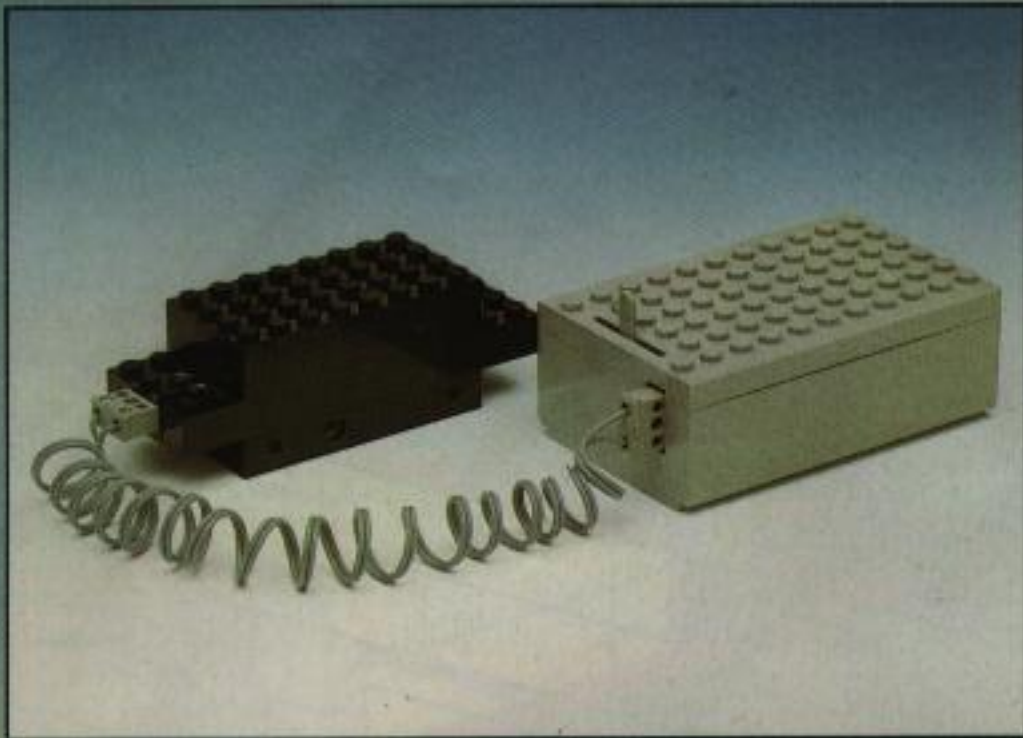

7

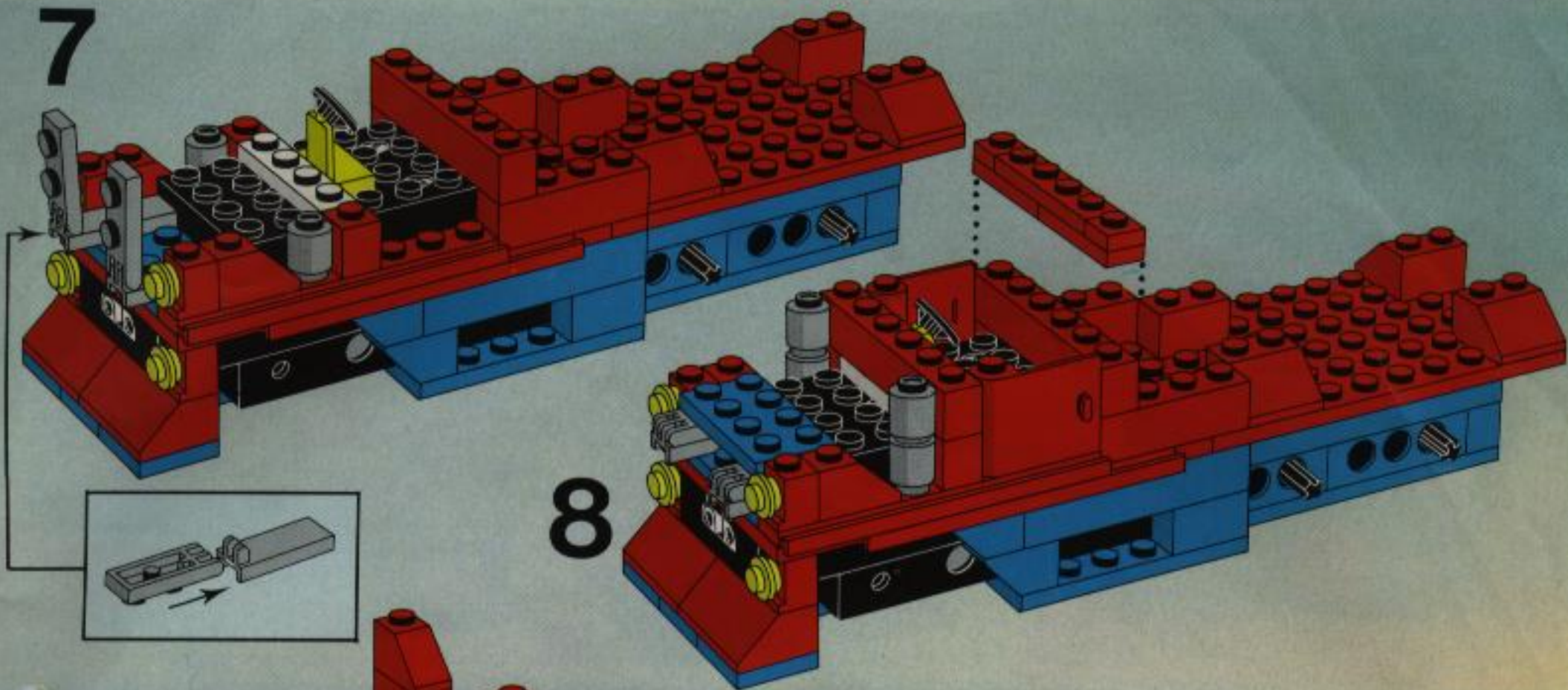

8

9

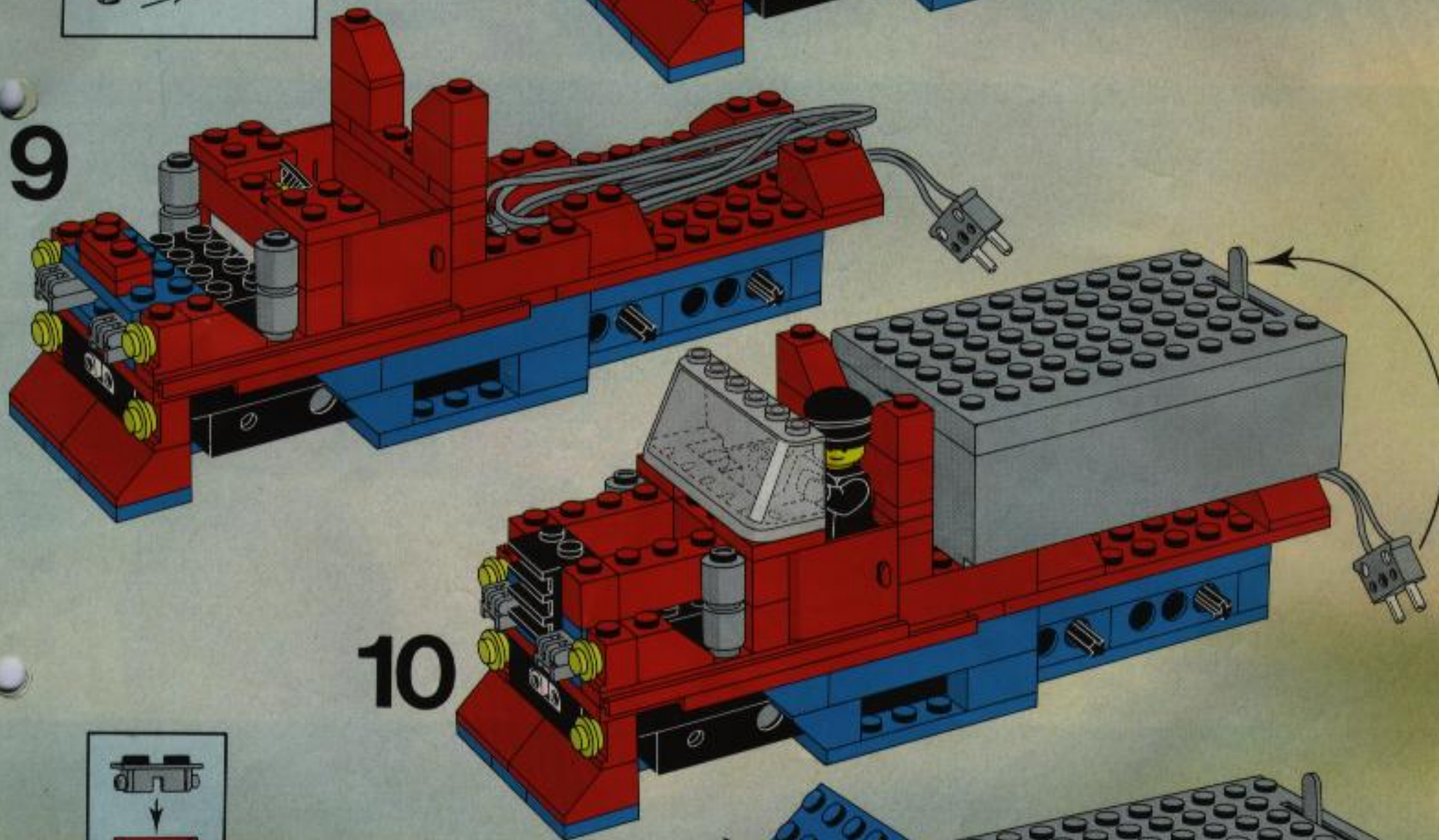

10

1

2

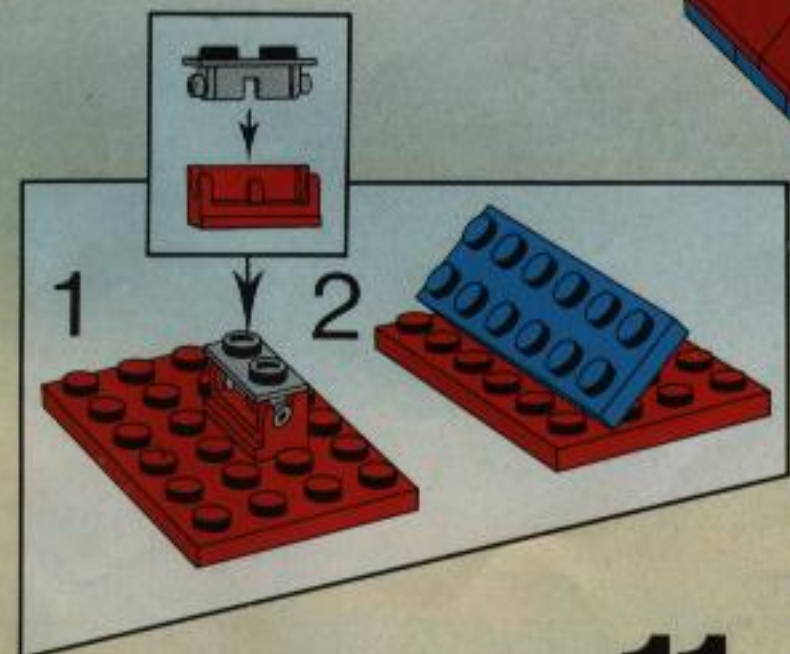

11

