

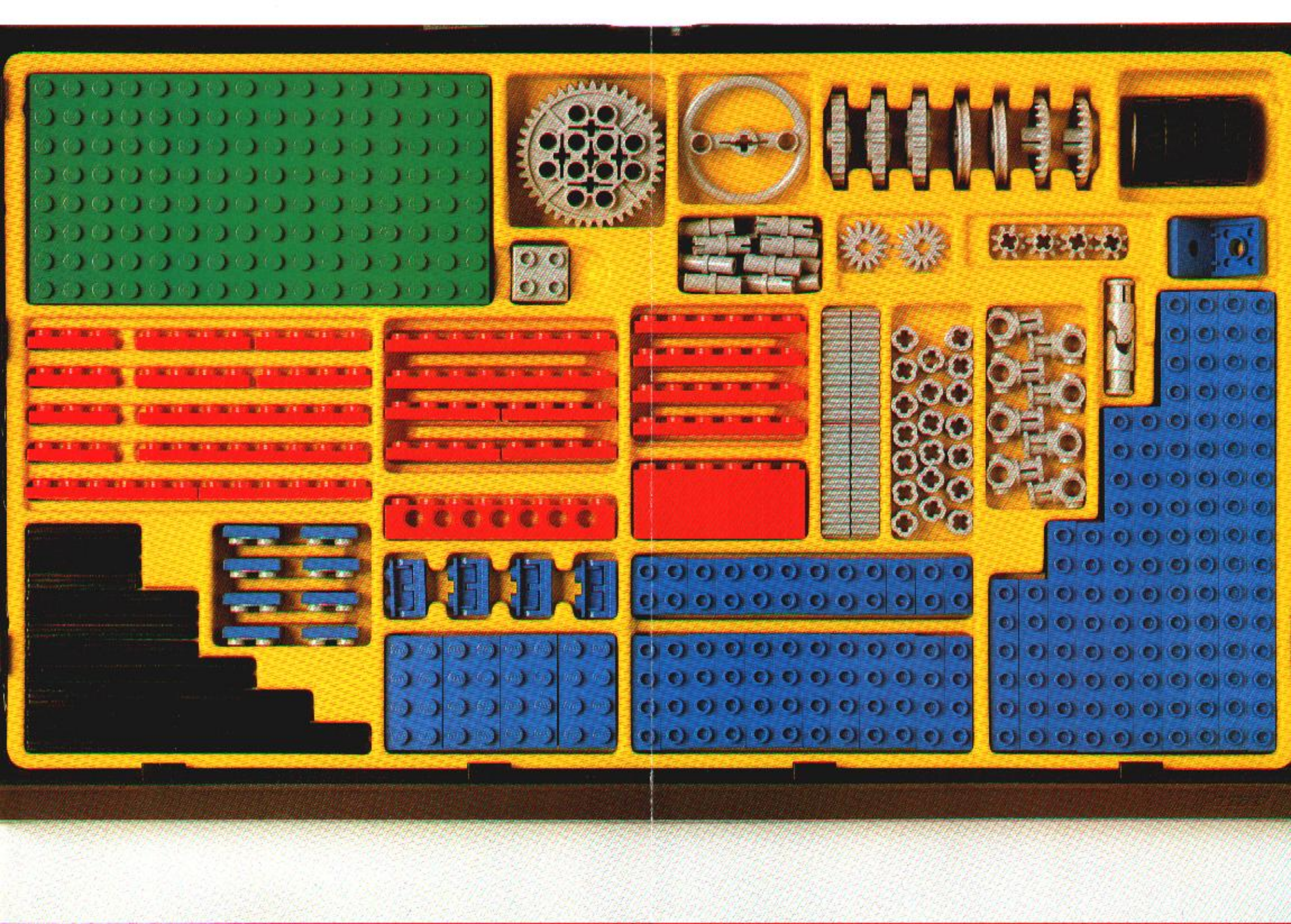

LEGO dacta

Technic

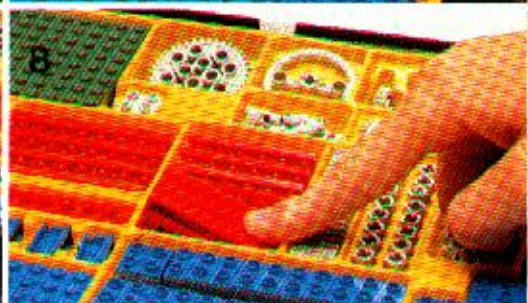

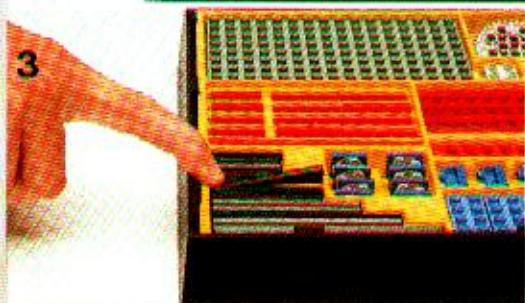
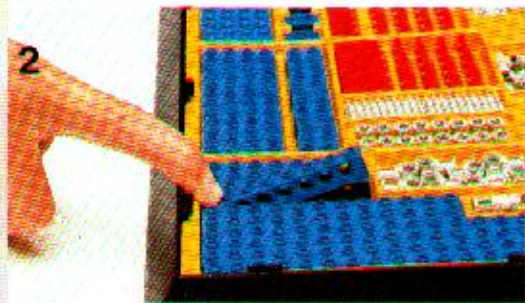
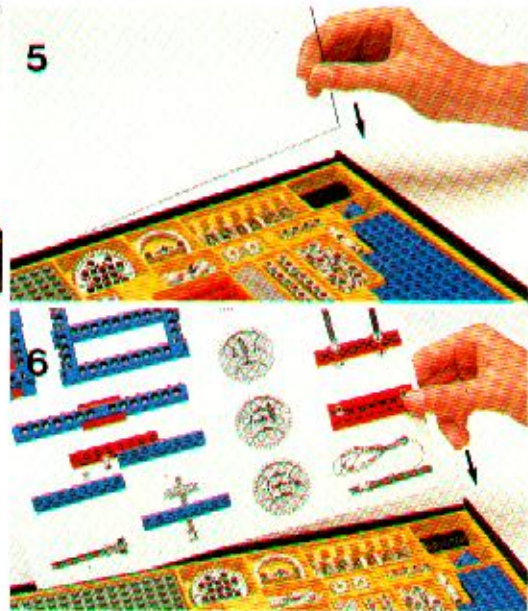
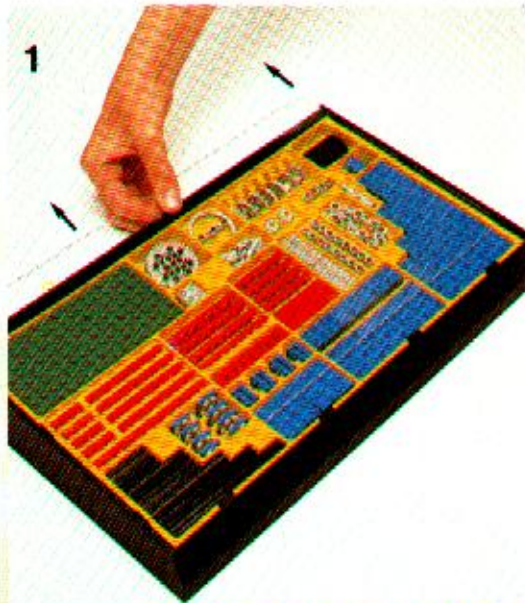



1031

2

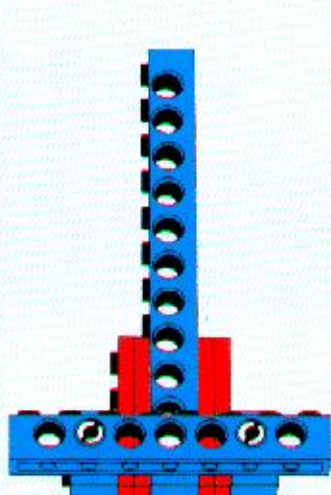
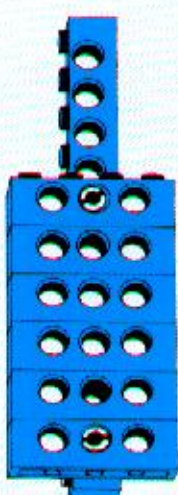
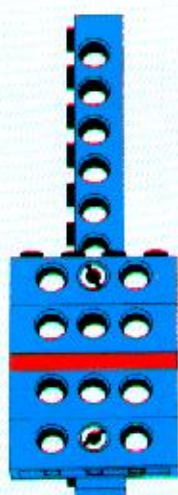
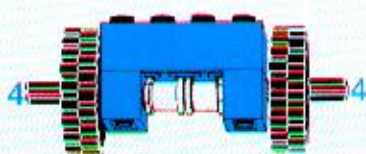
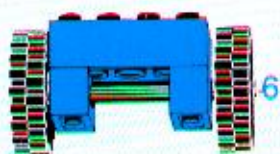
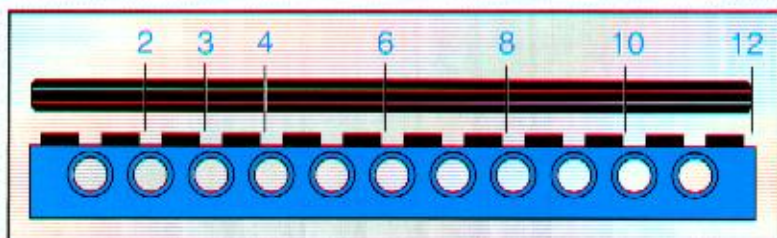
**LEGO** dacta

Technic

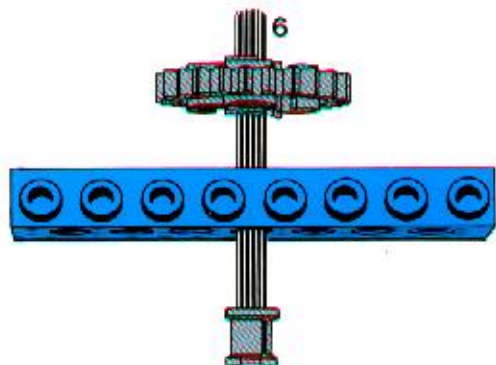
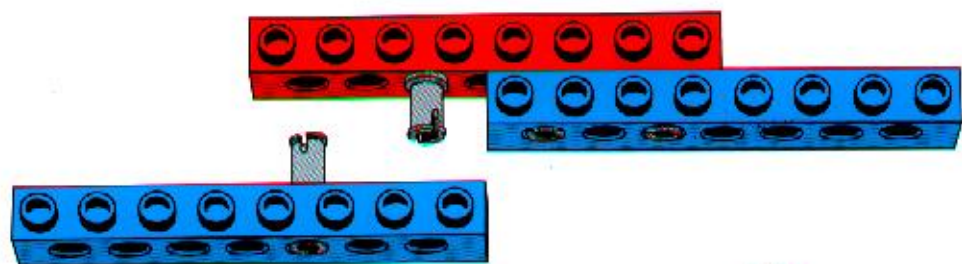
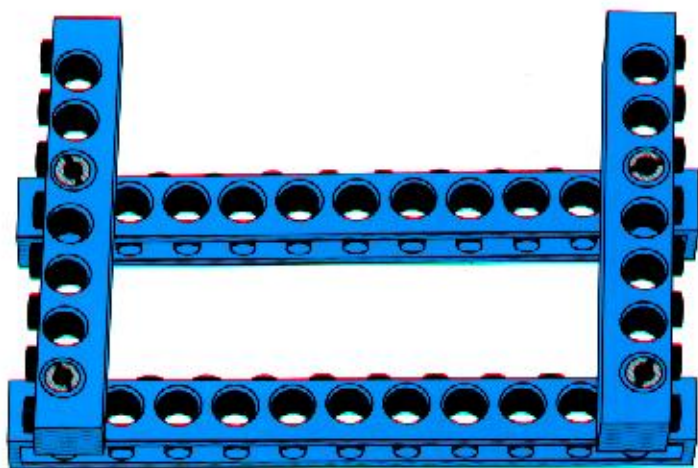
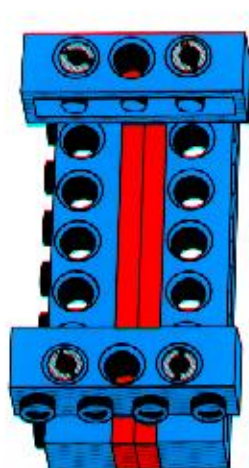

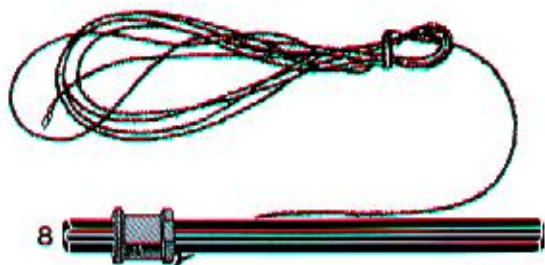
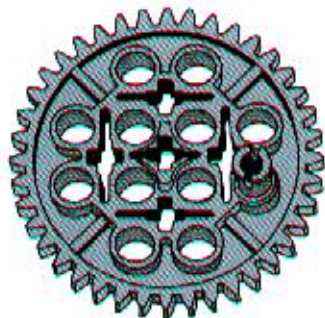
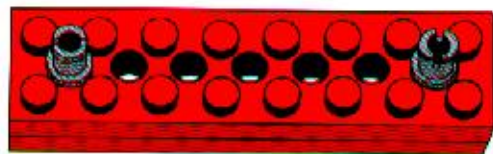
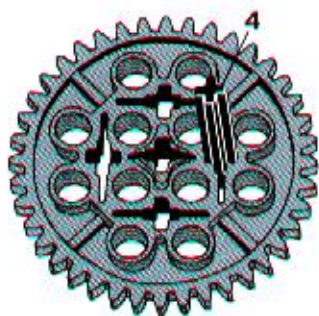
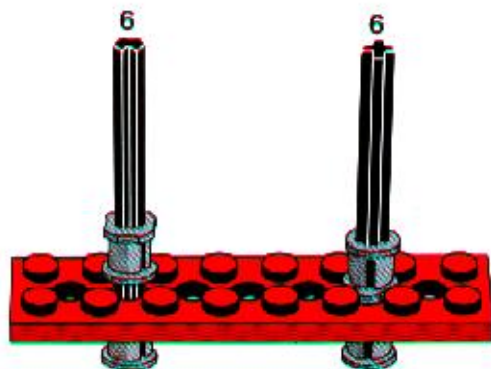
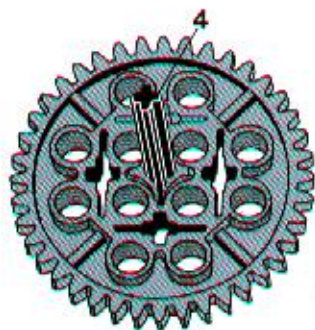
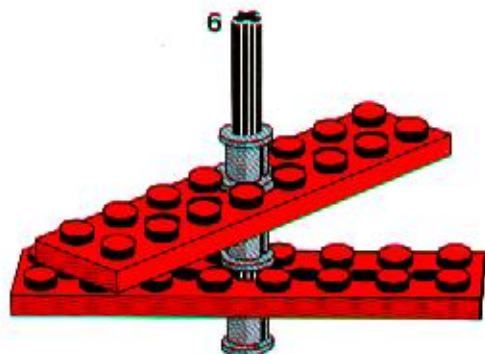
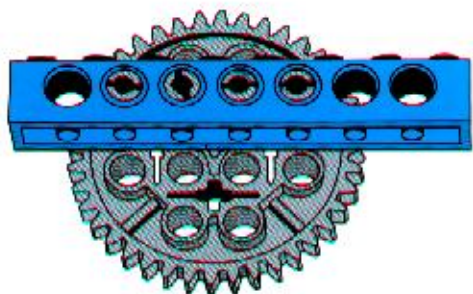

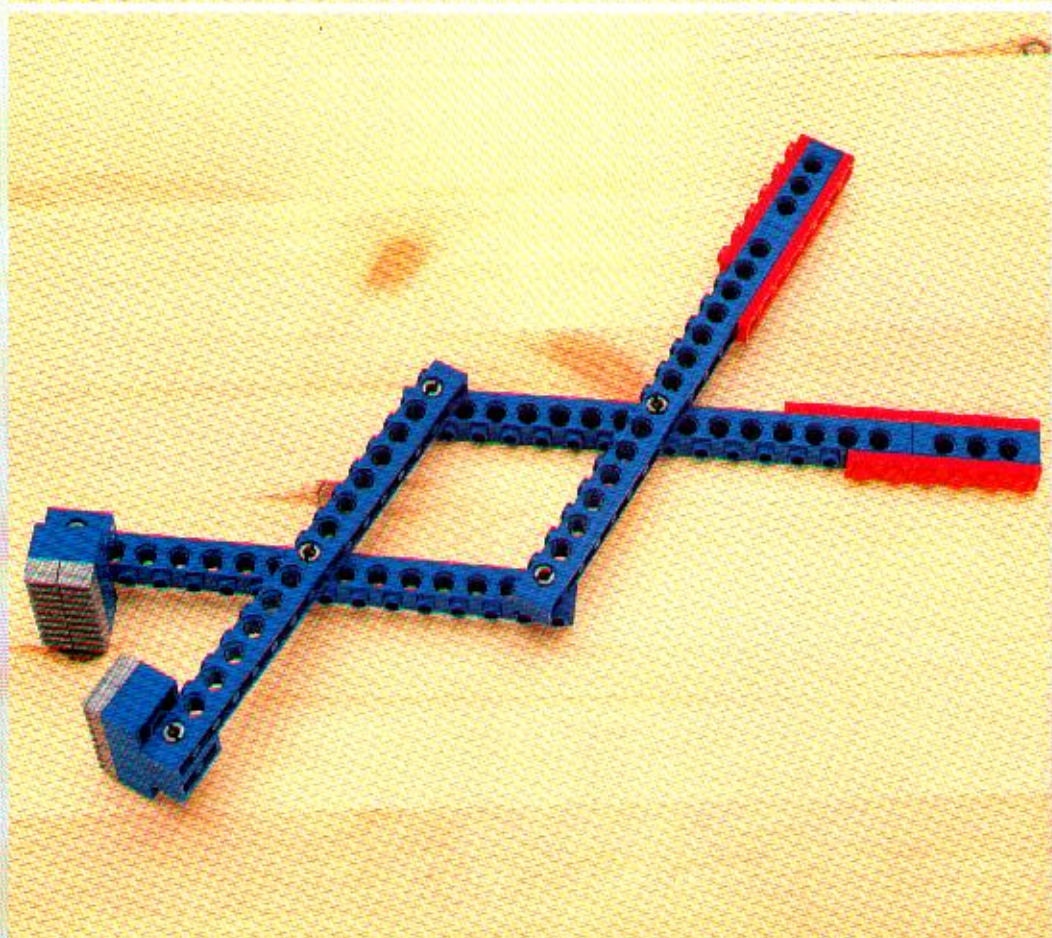
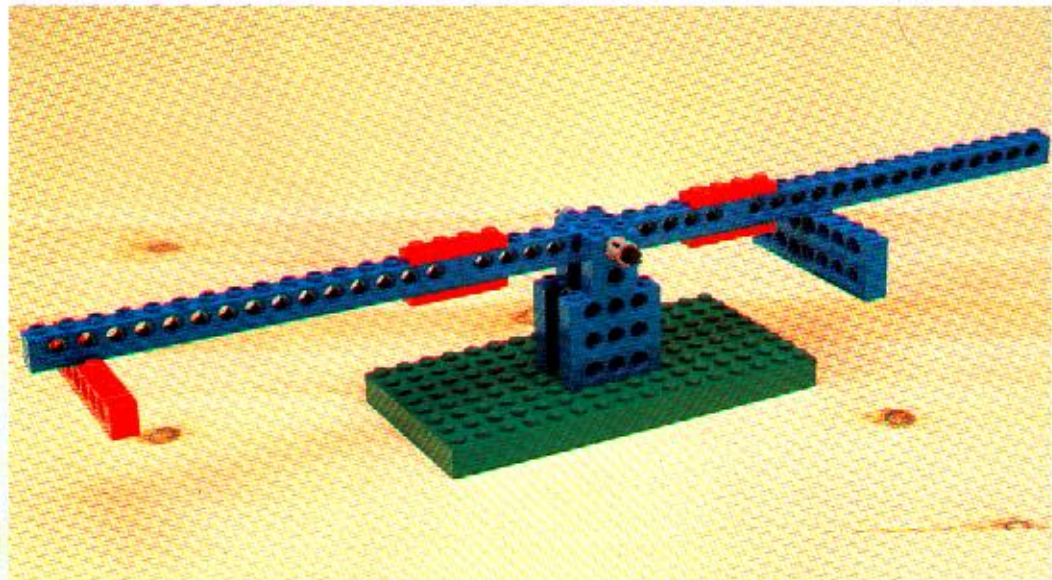



1031

3

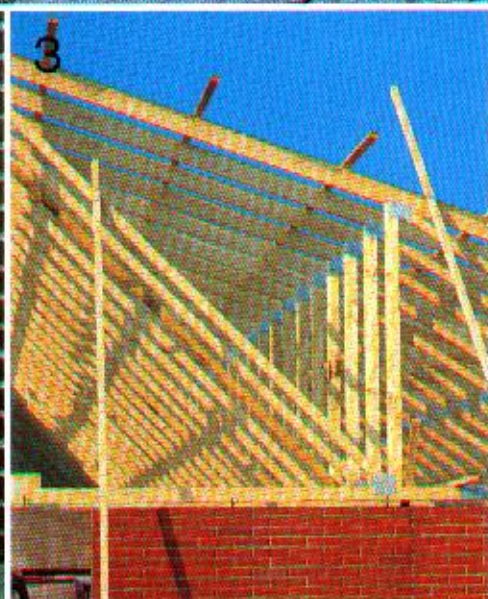
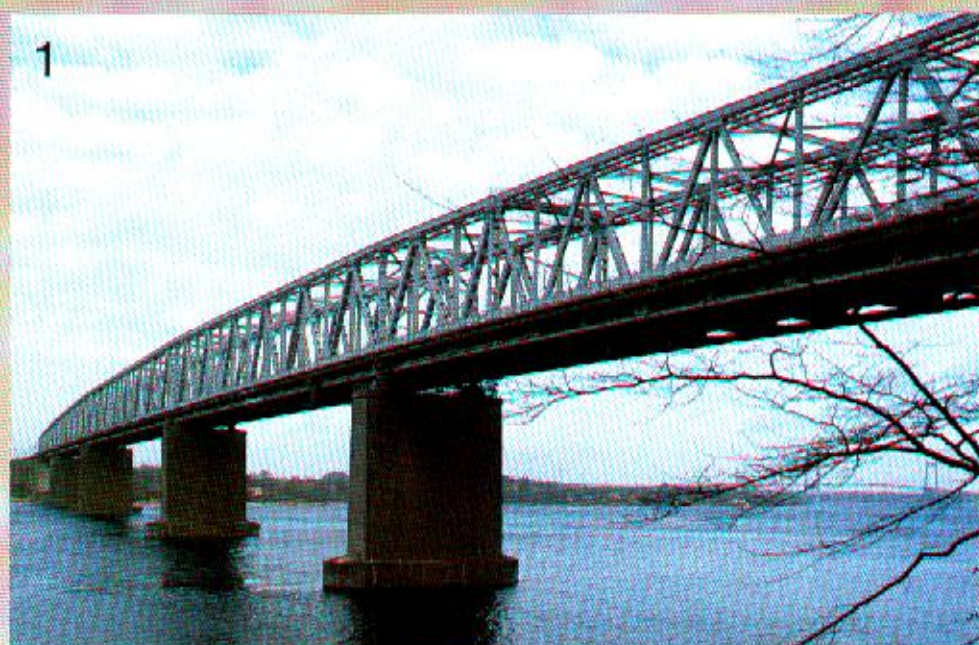

LEGO dacta

Technic

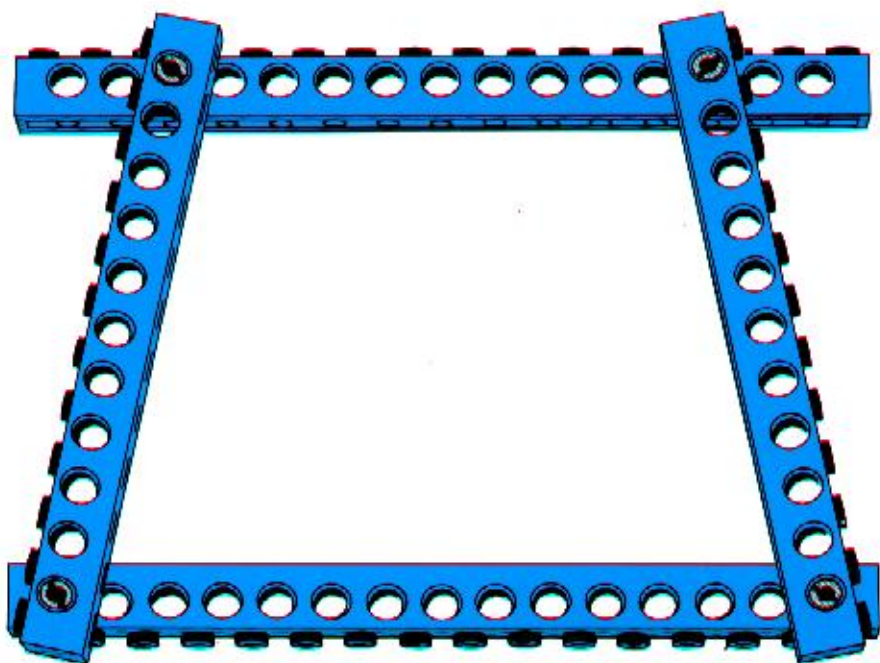
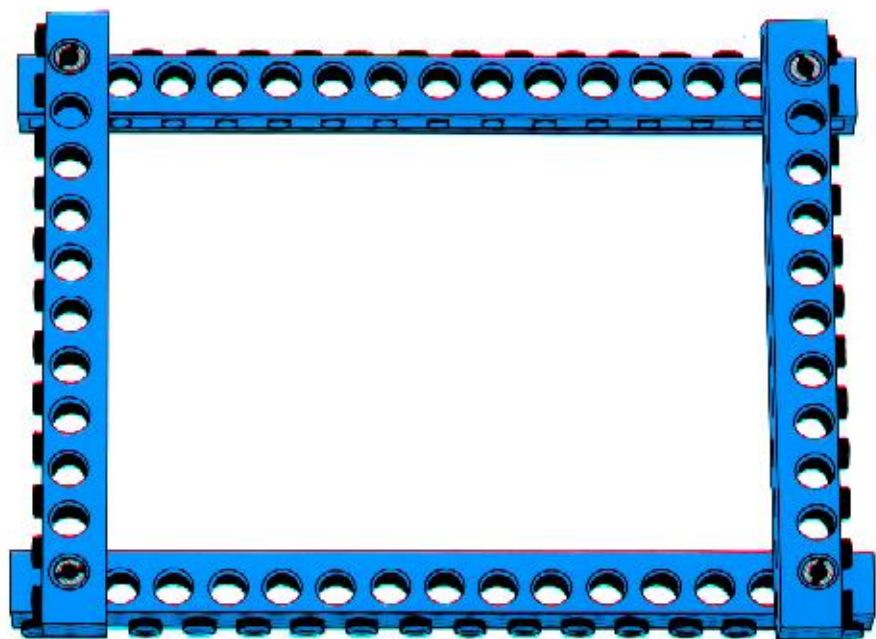

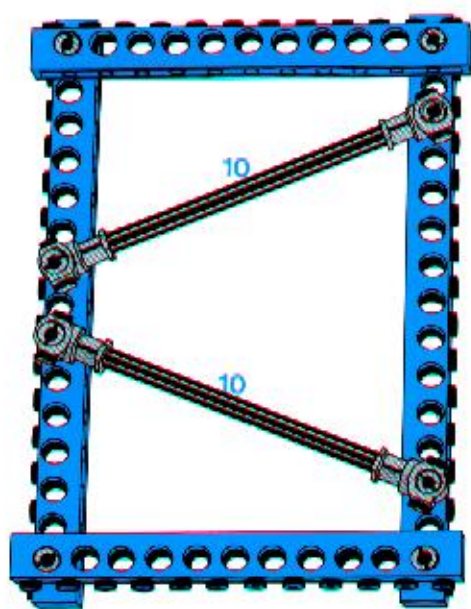
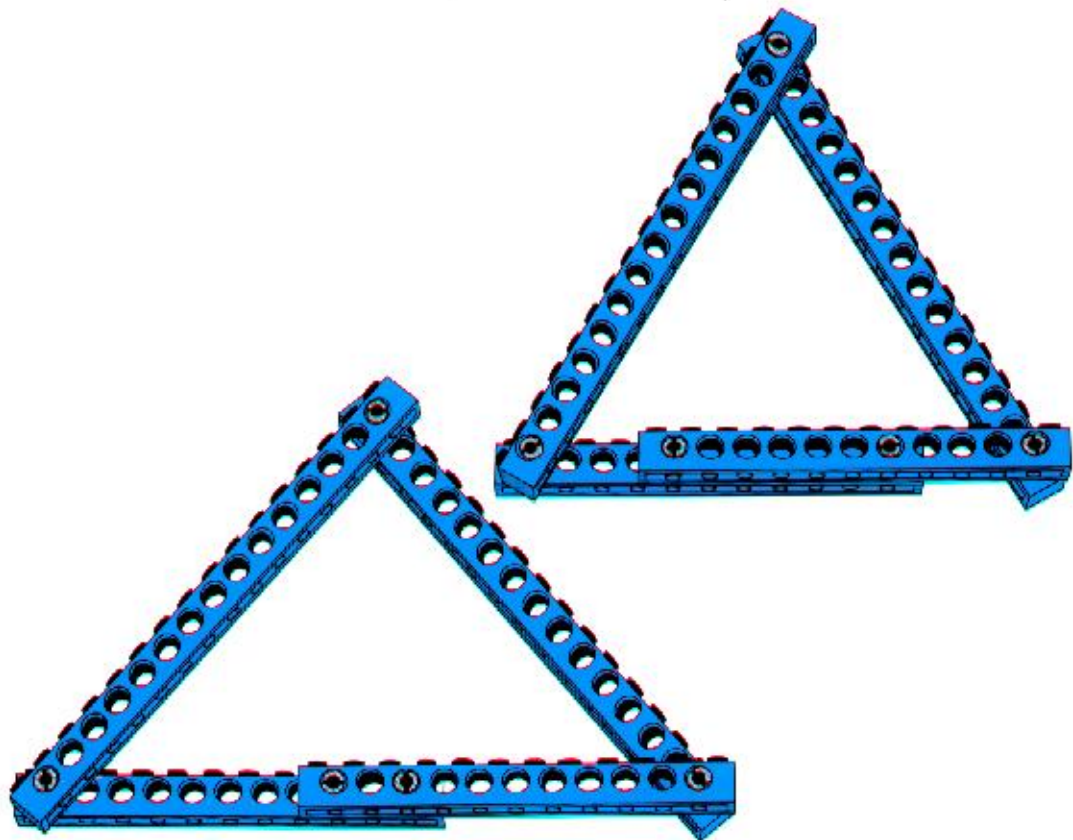

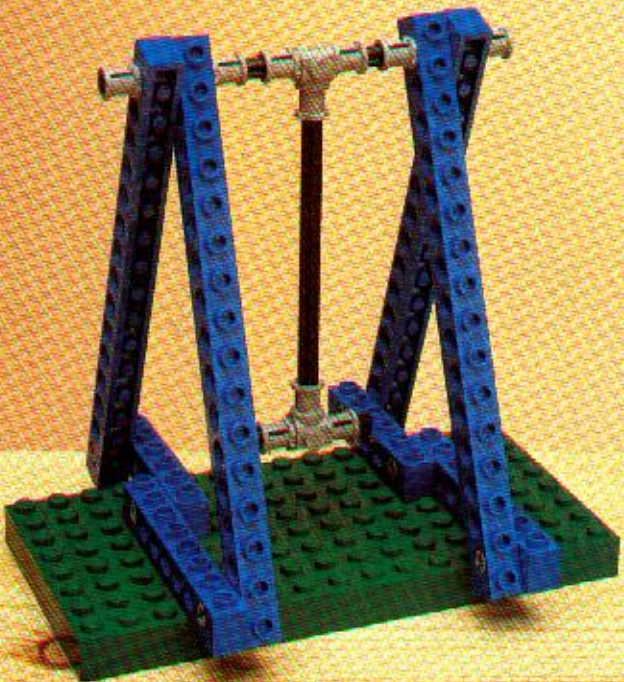
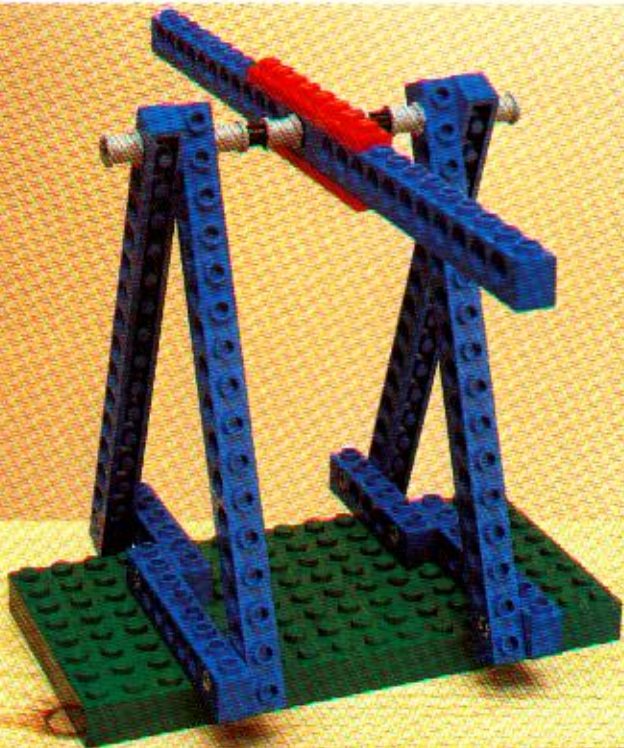



1031

4



2

**LEGO** dacta

Technic

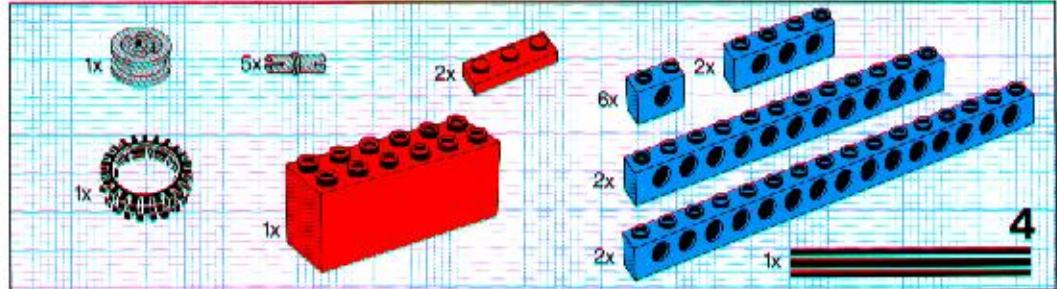

①

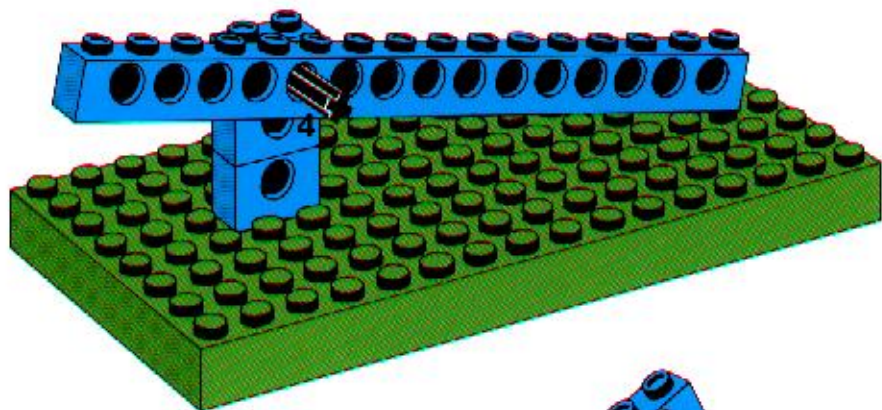

②

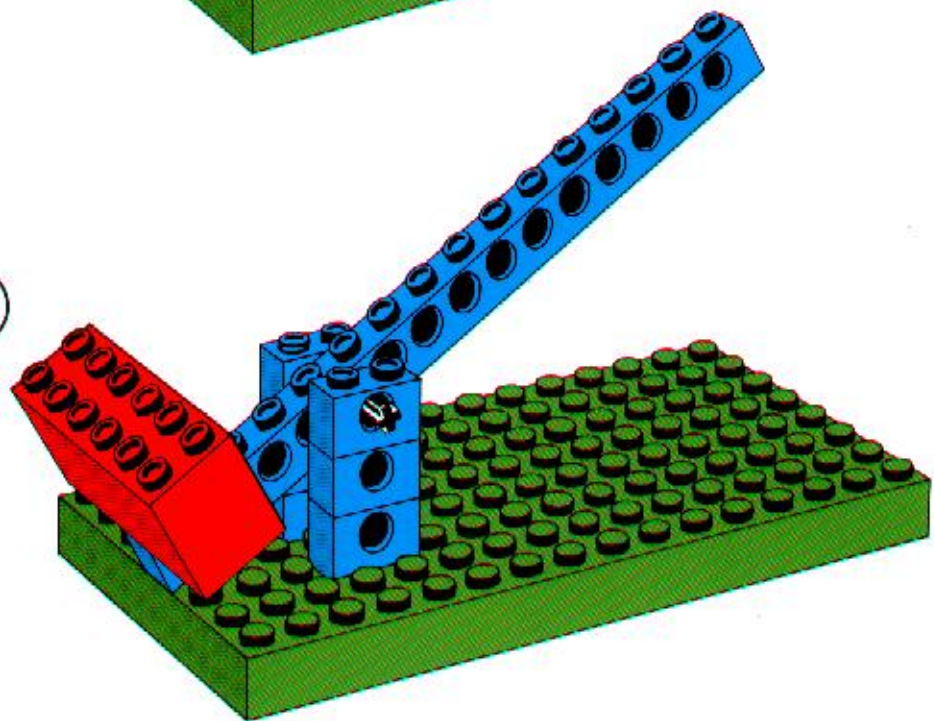

1

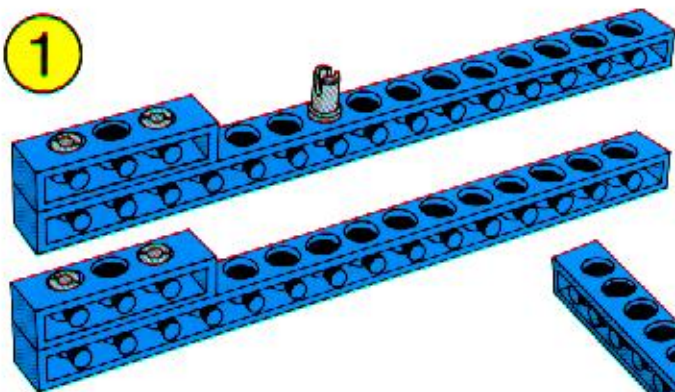

2

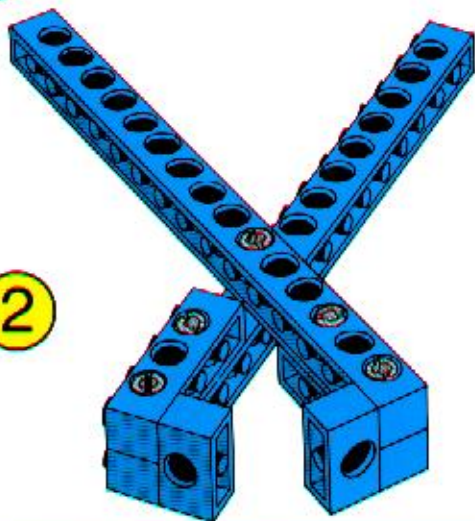

1

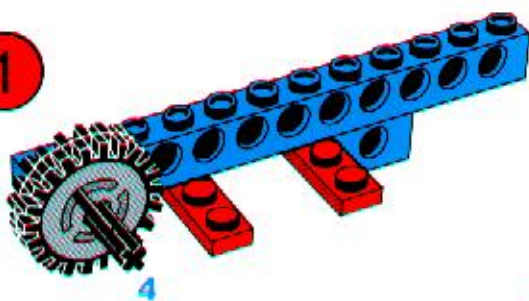

2

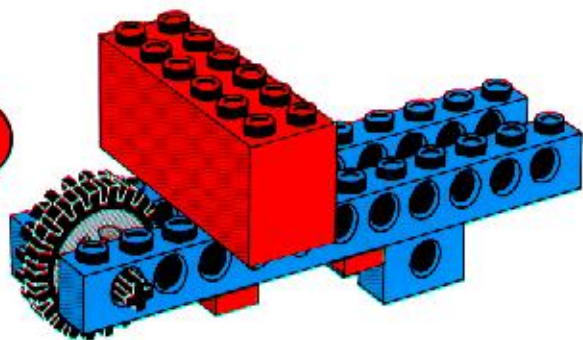

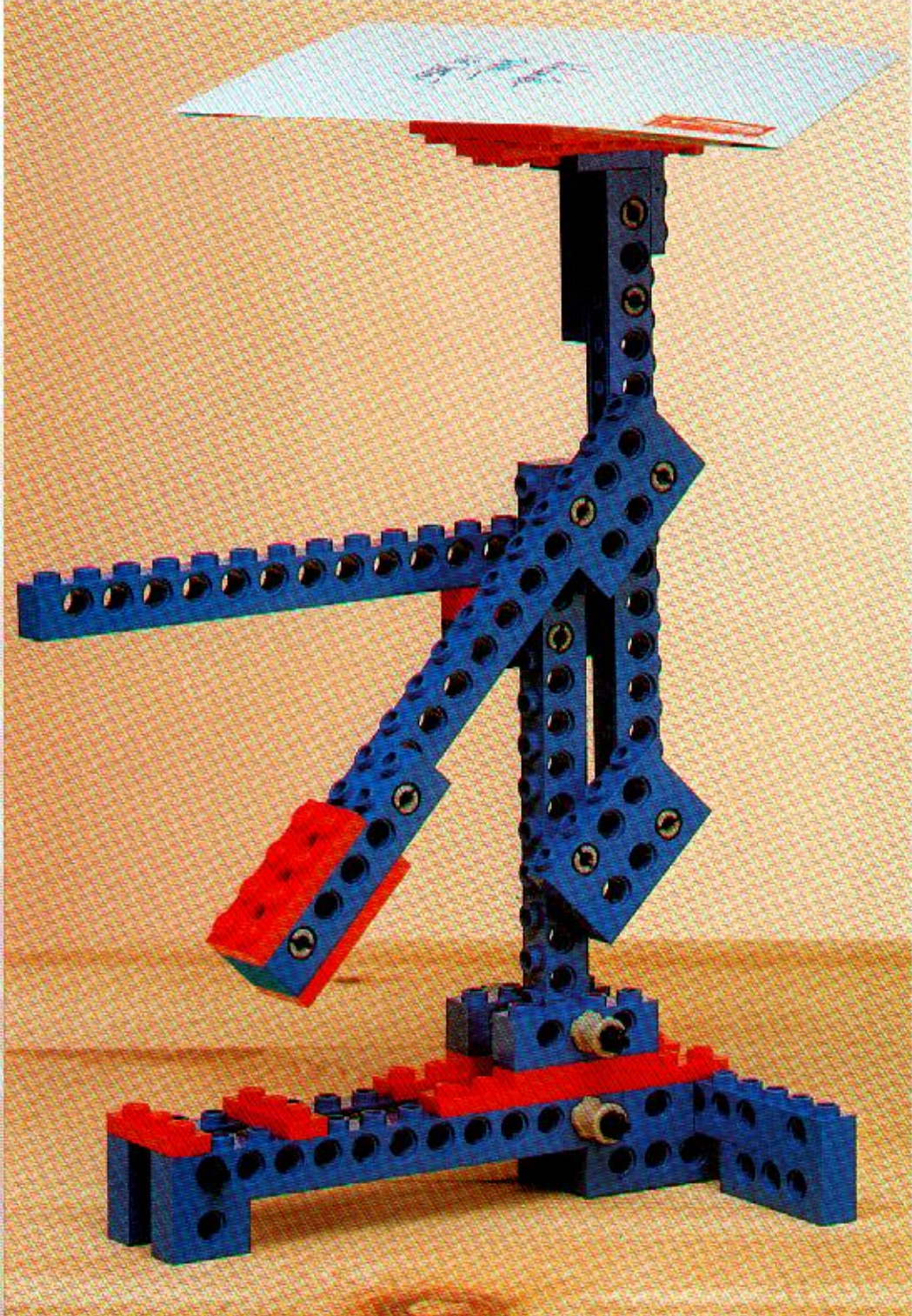



1031

5

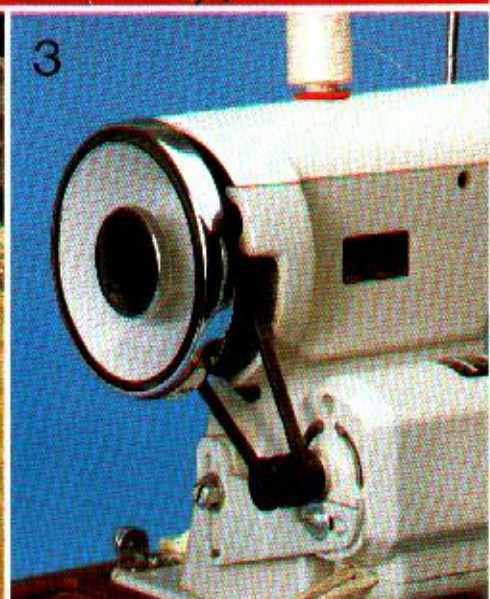
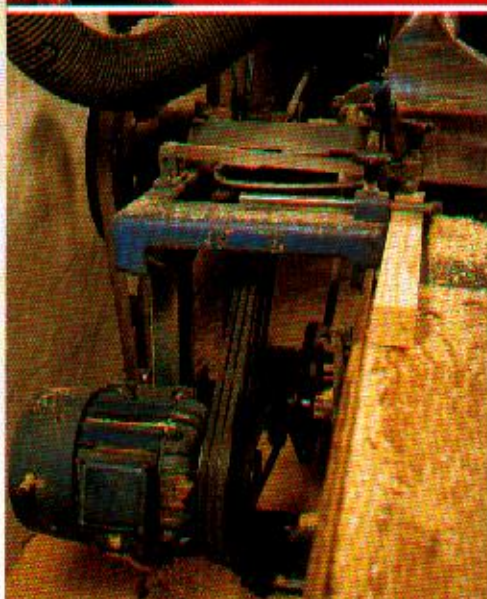
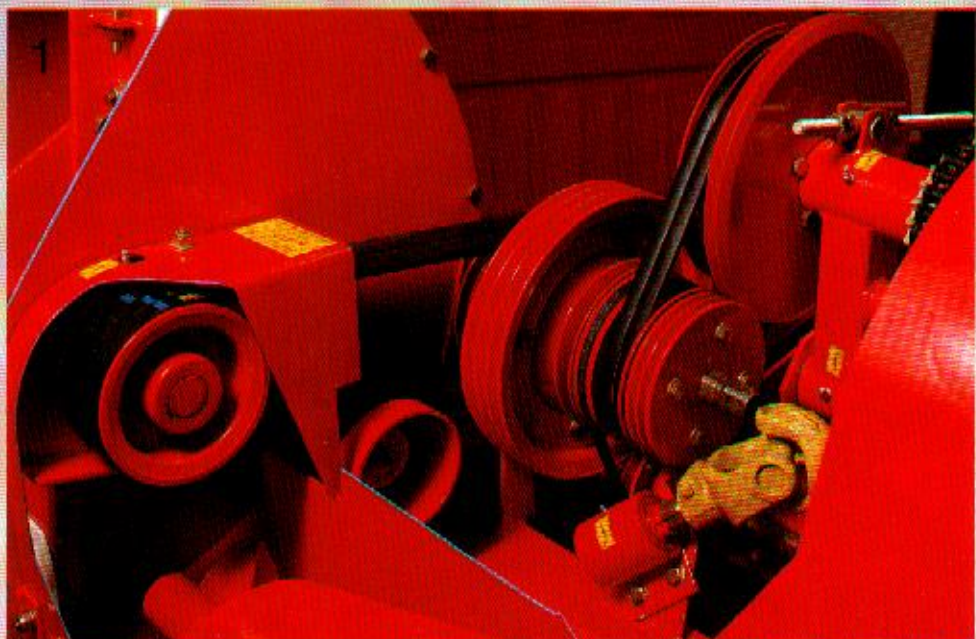

LEGO dacta

Technic

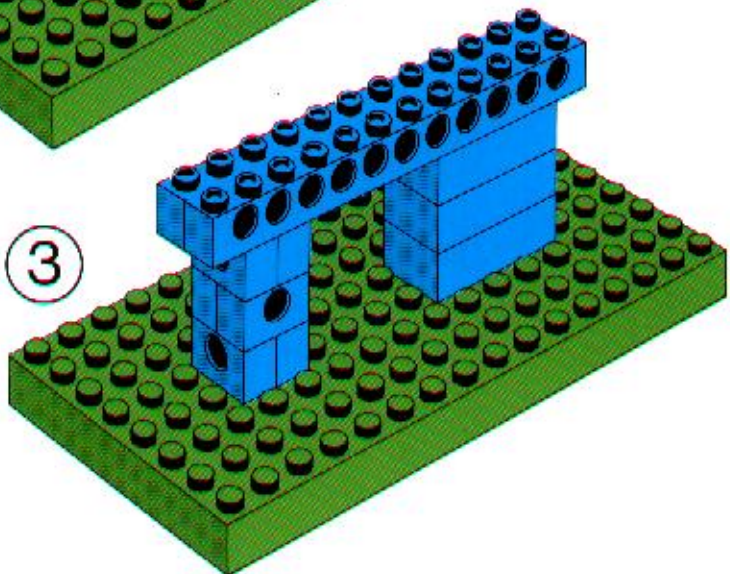
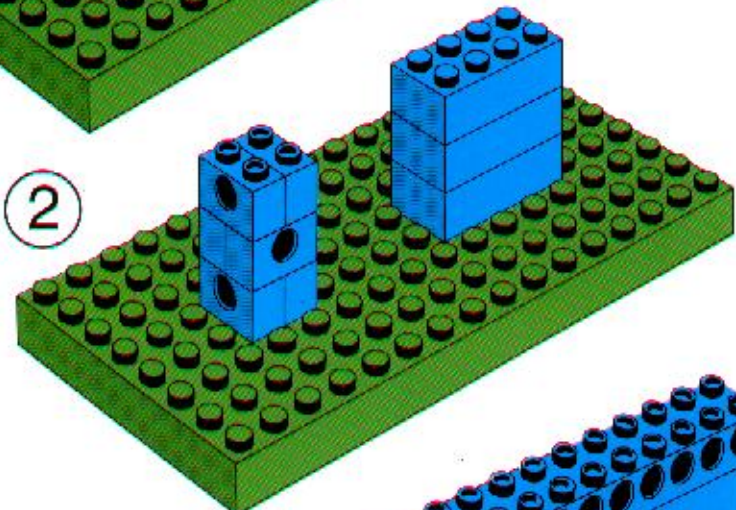
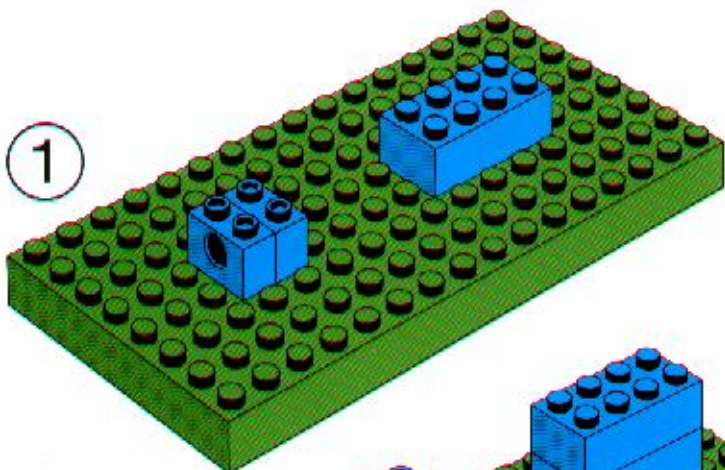
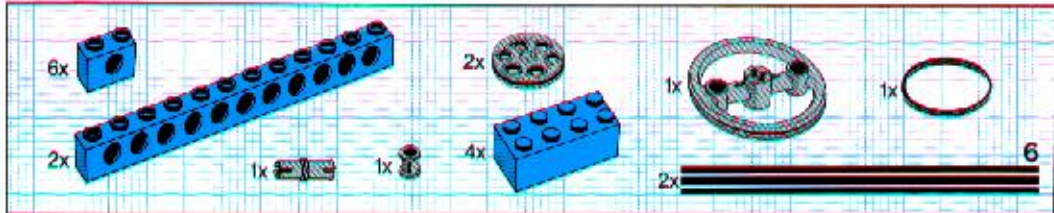

4

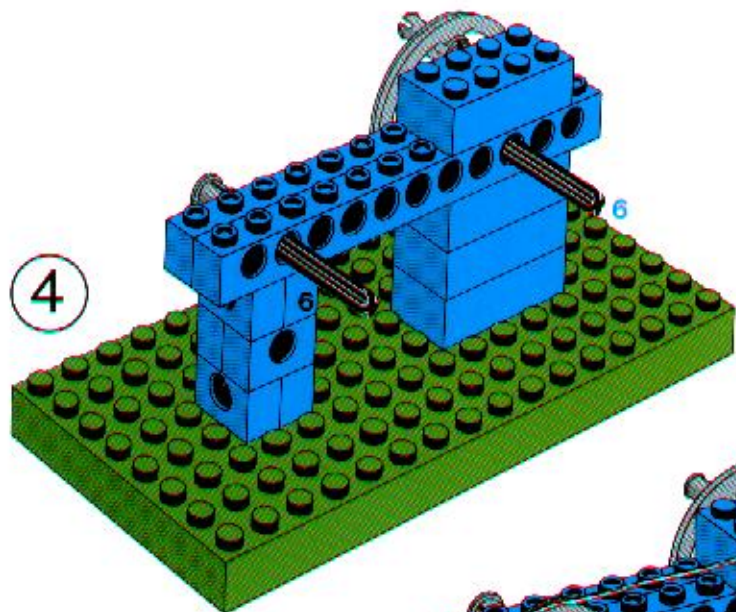

5

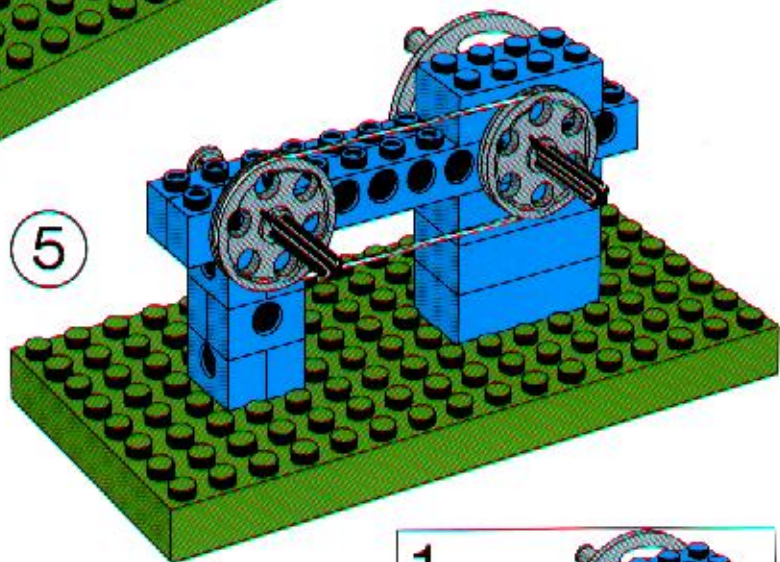

1

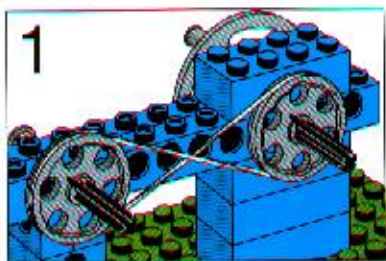

2

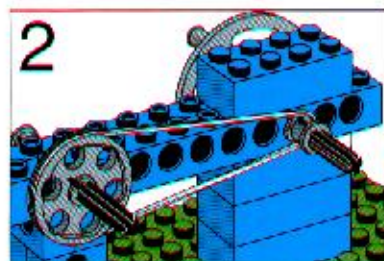

3

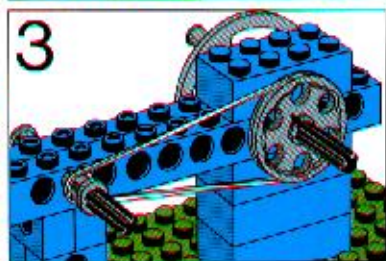

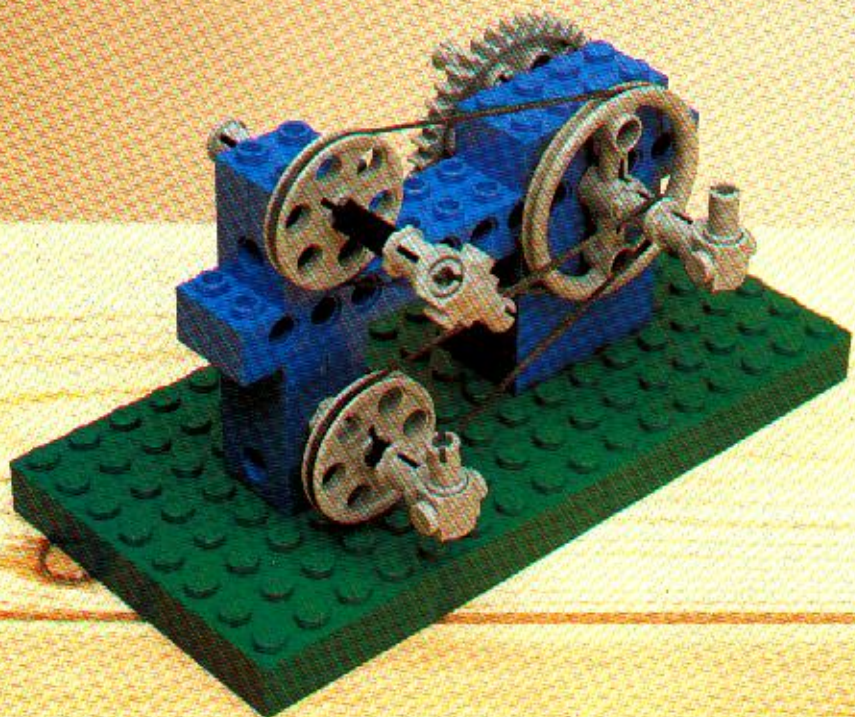
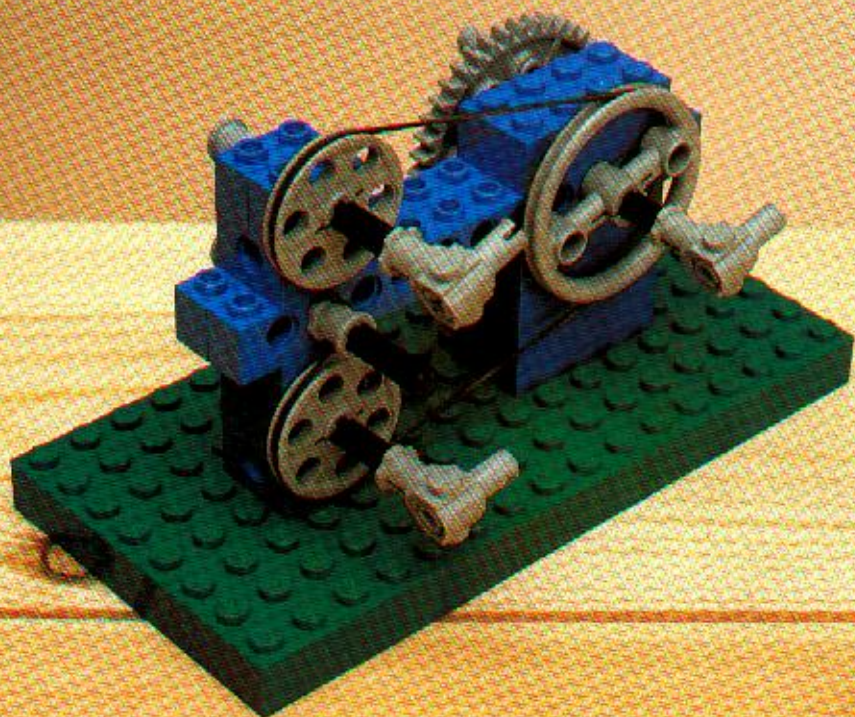



1031

6

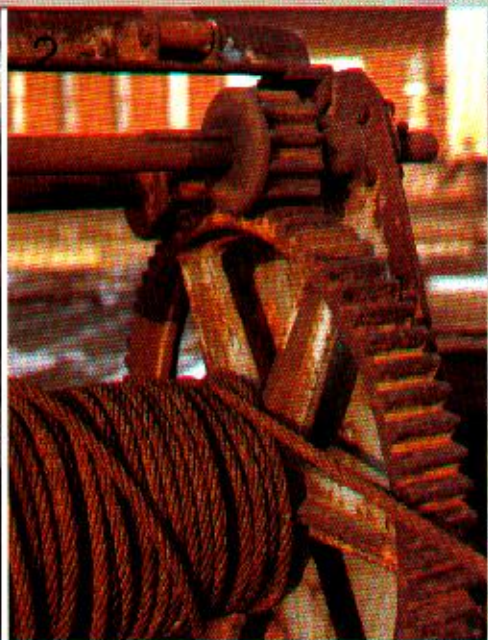

LEGO dacta

Technic

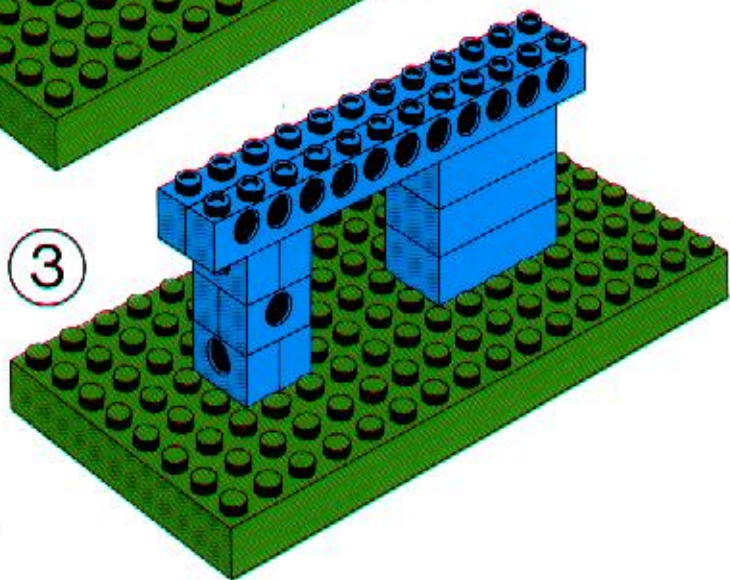
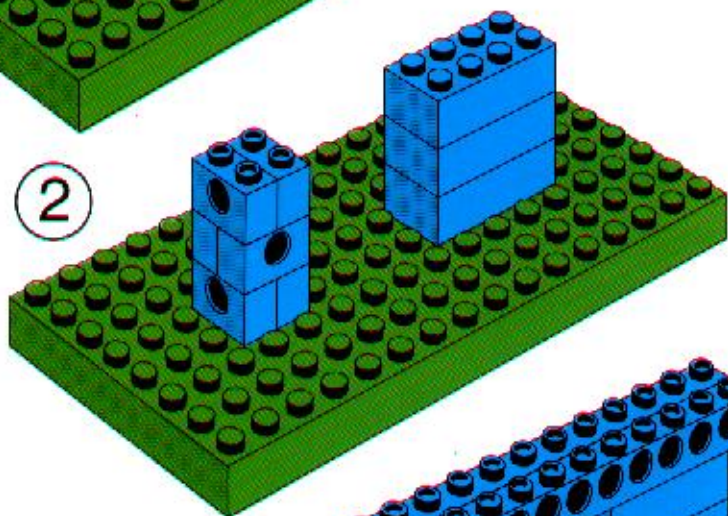
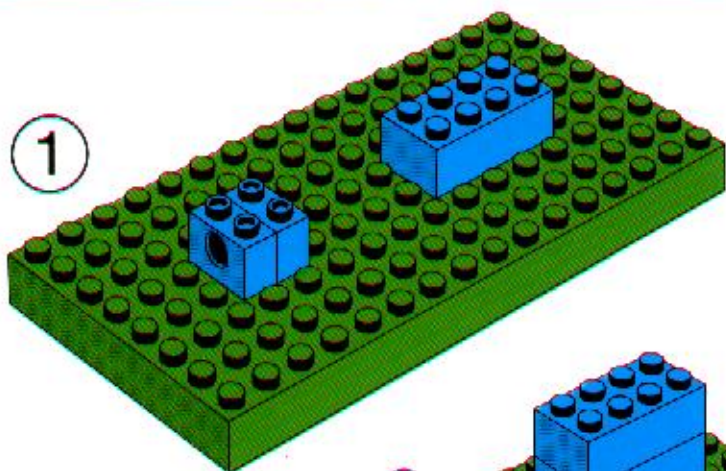
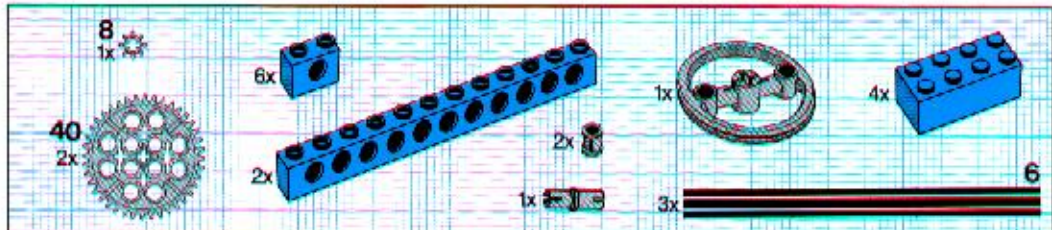

4

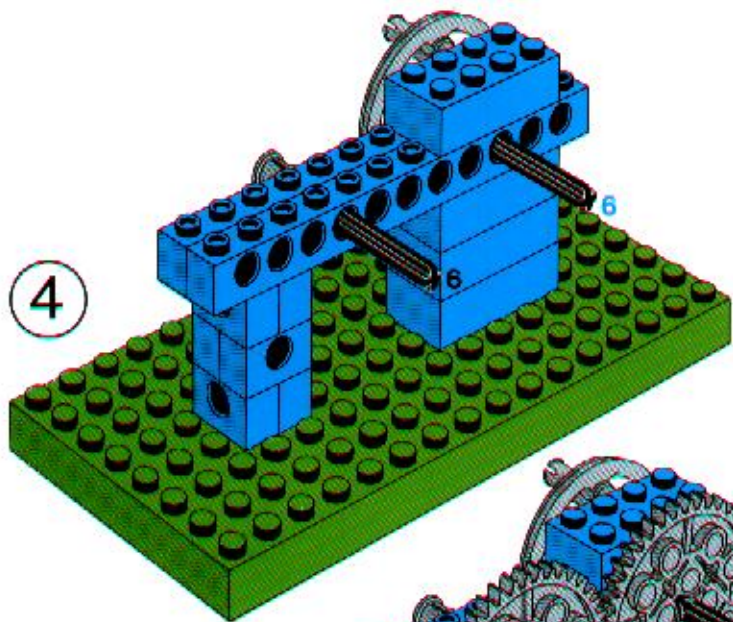

5

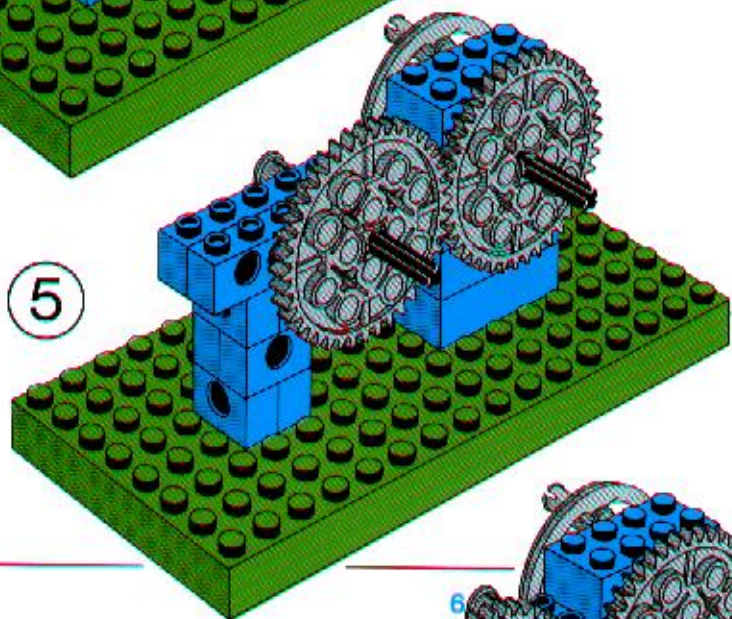

1

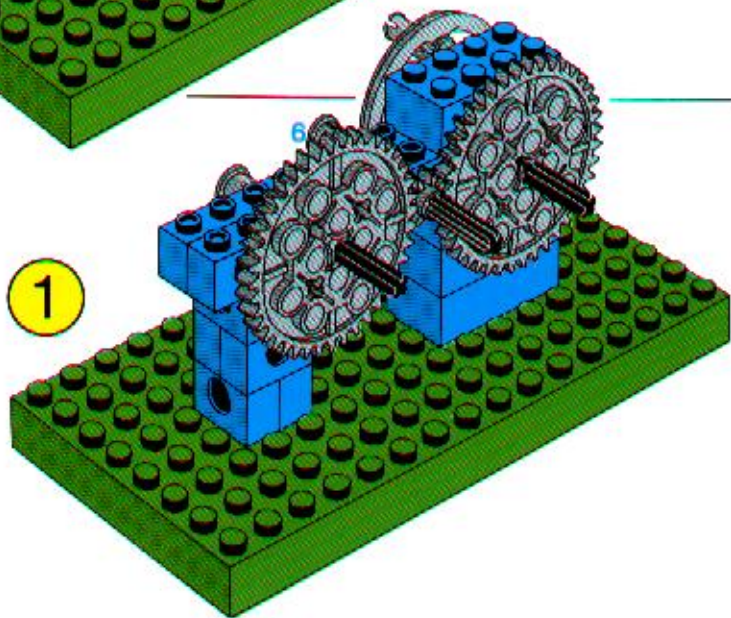

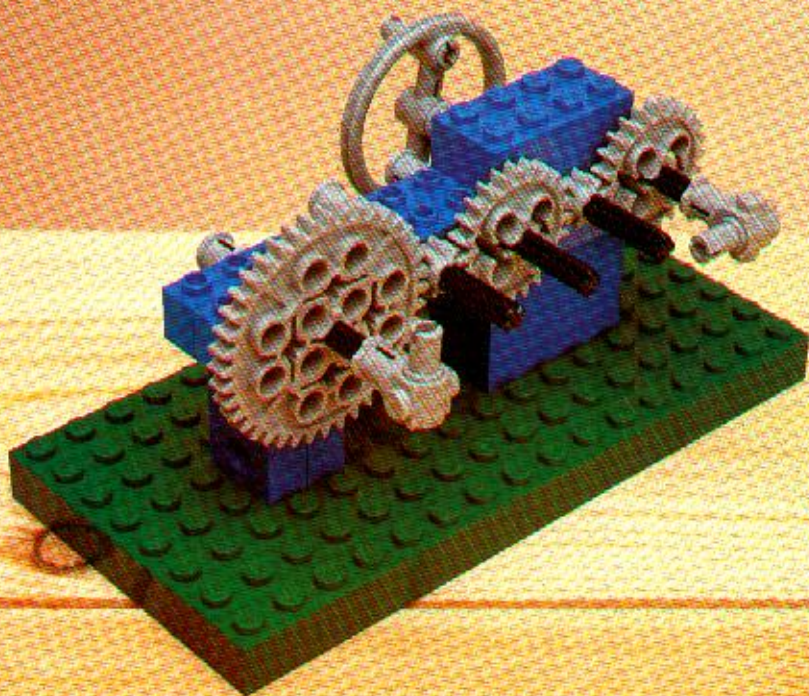
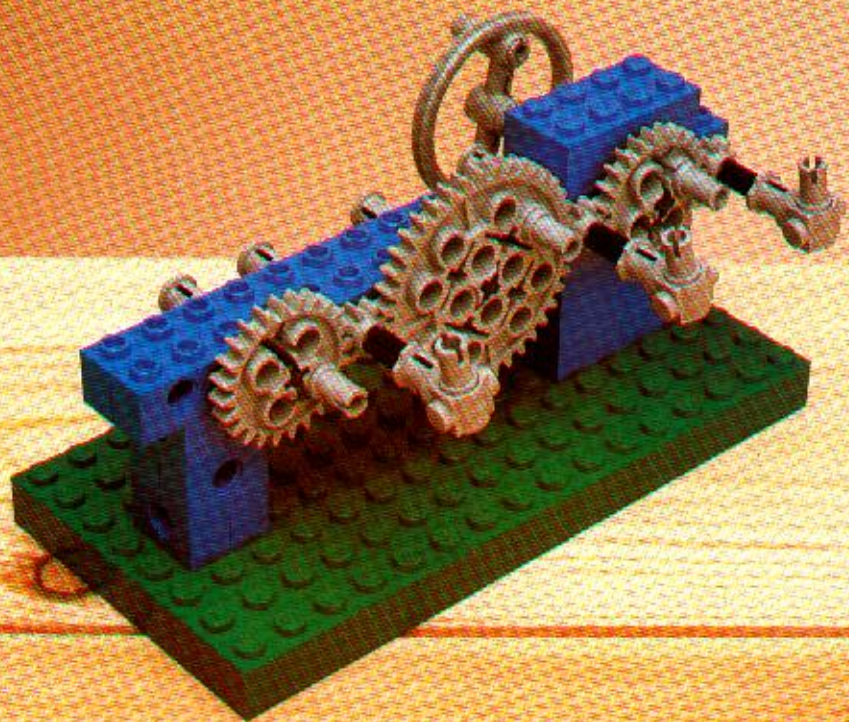

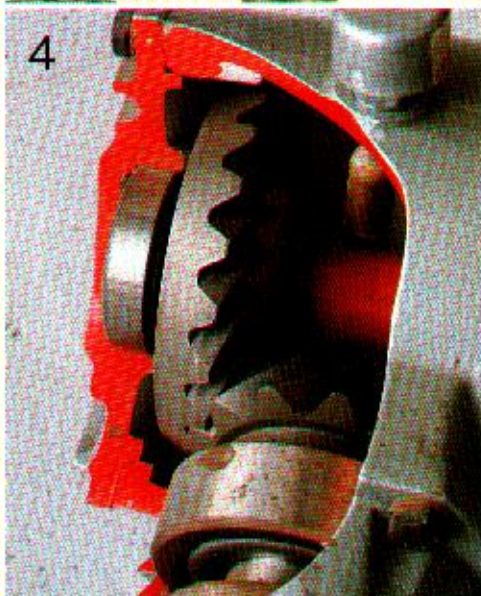

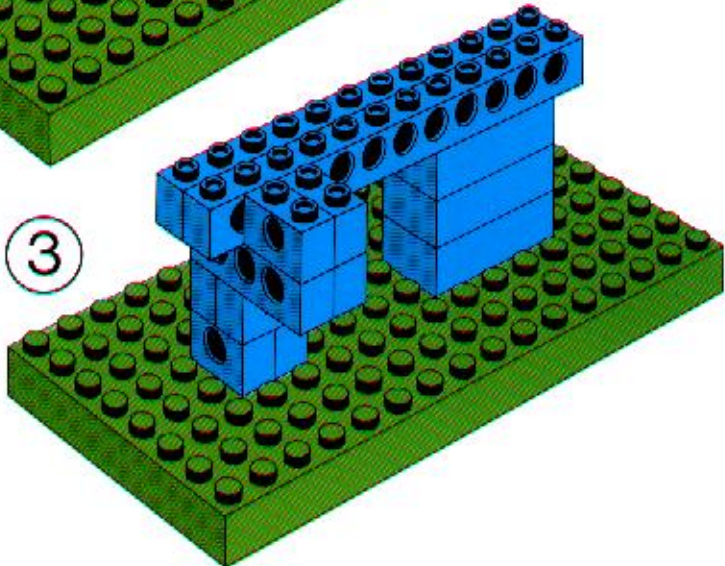
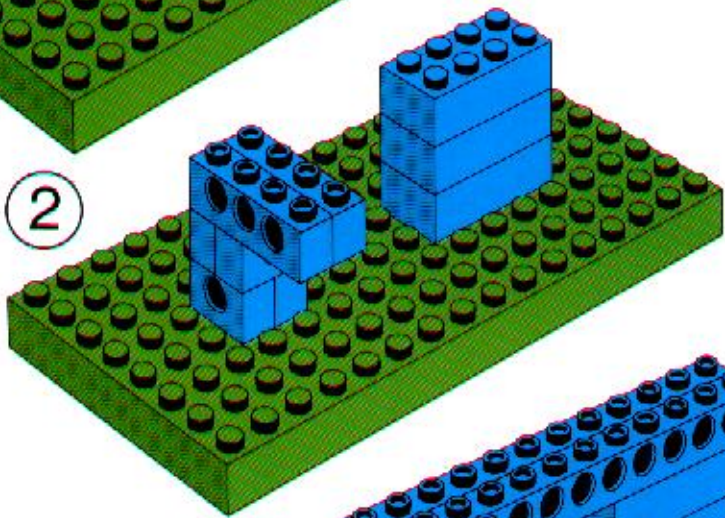
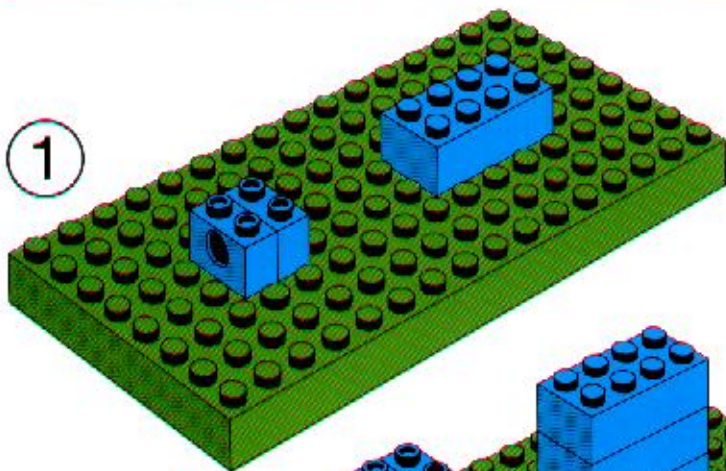
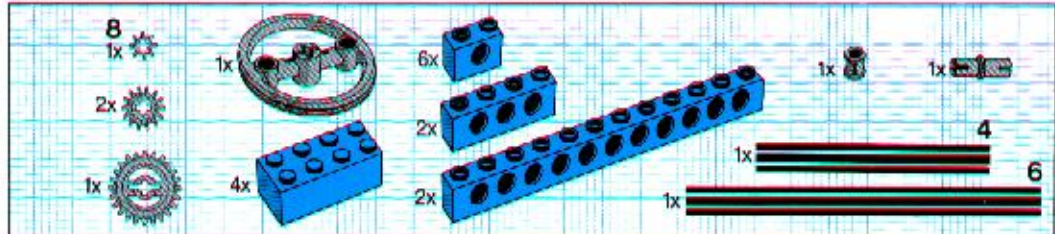



4

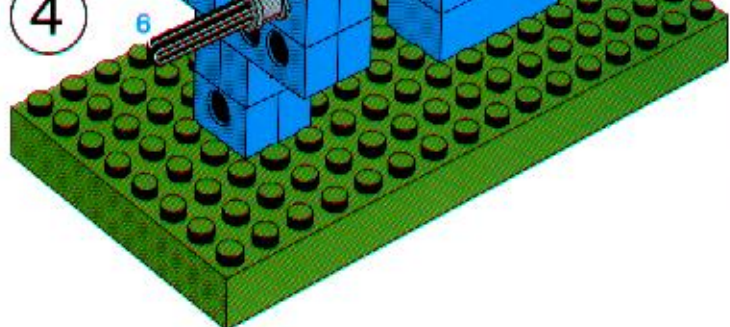

1

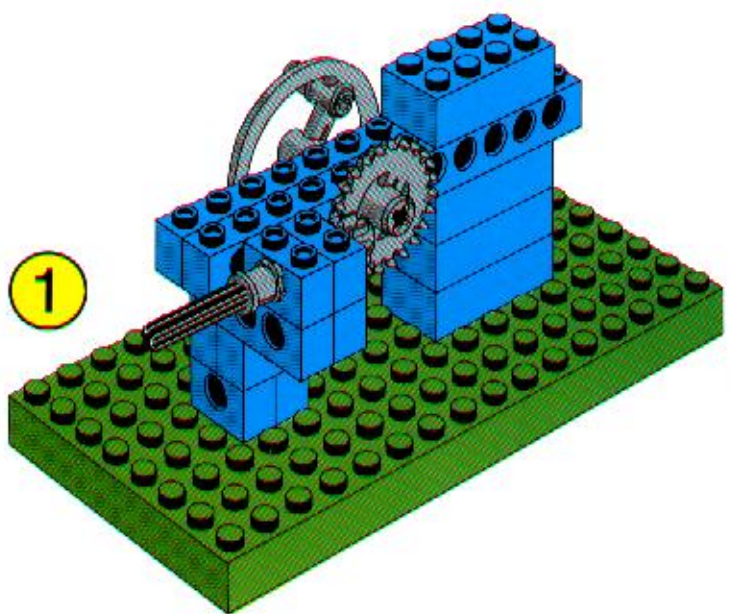

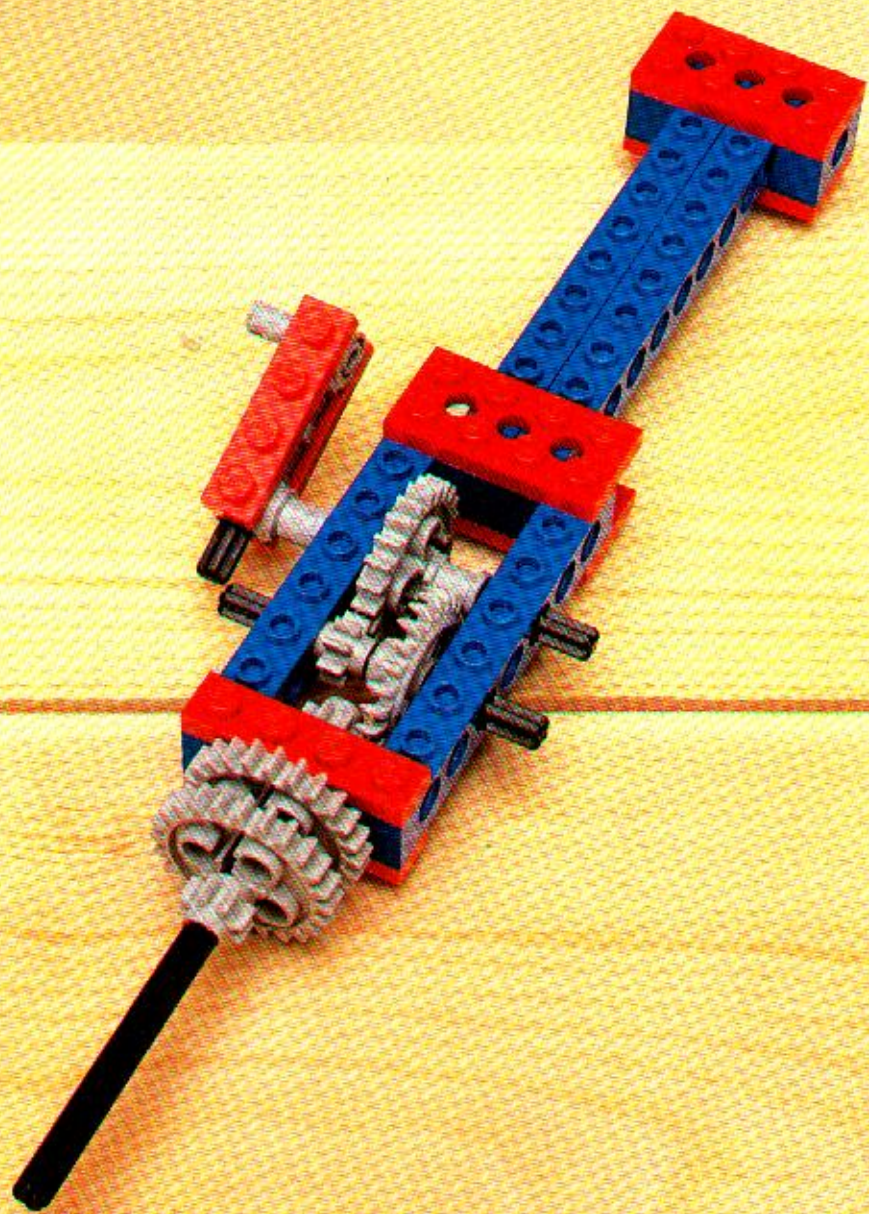



1031

8

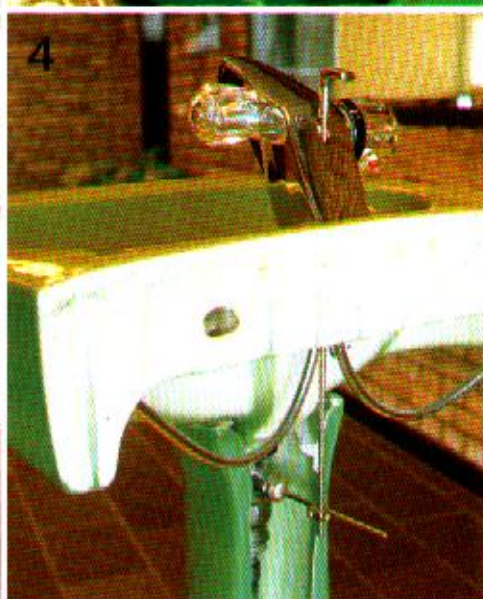

LEGO dacta

Technic

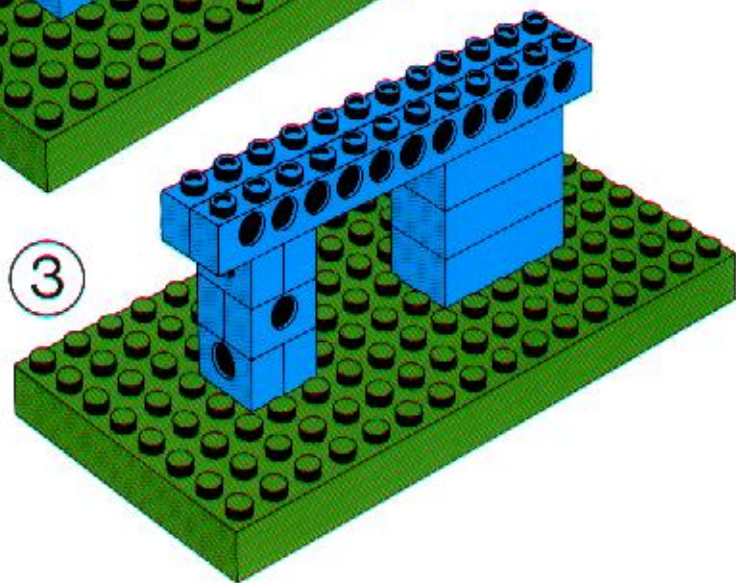
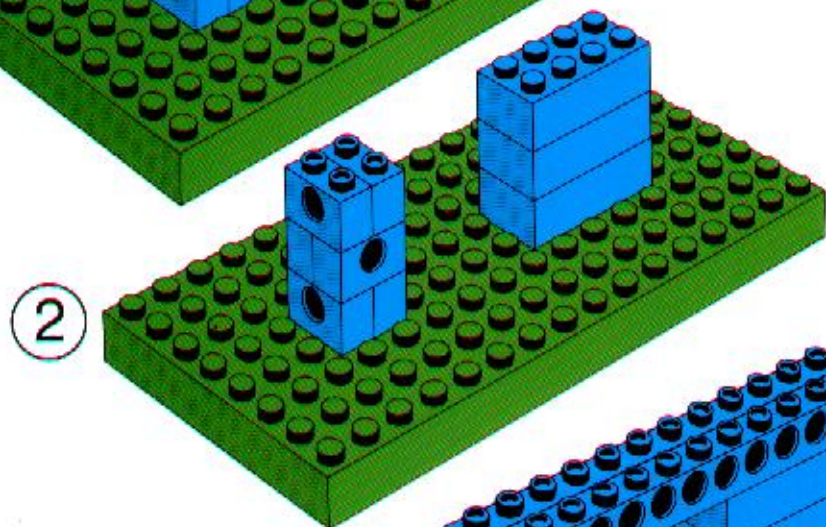
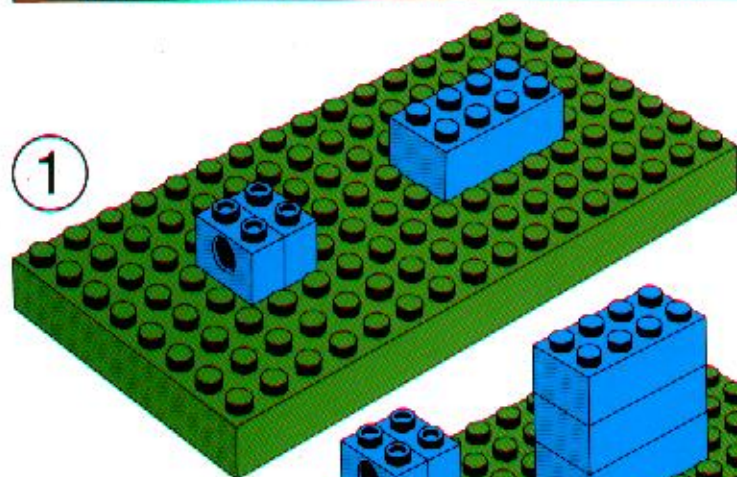
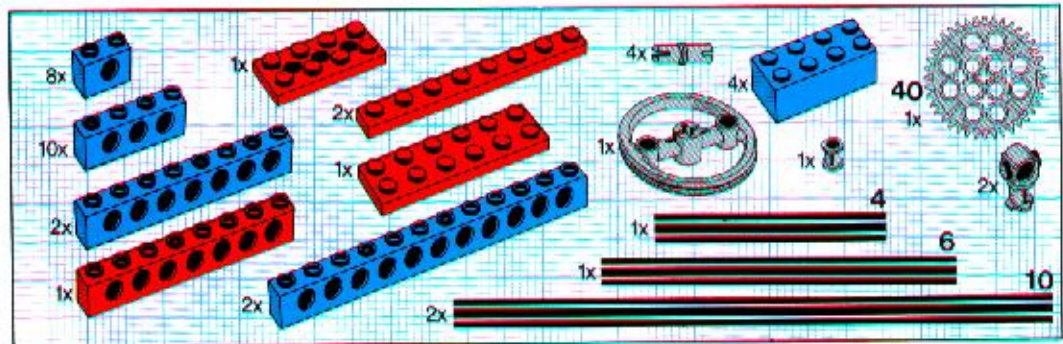

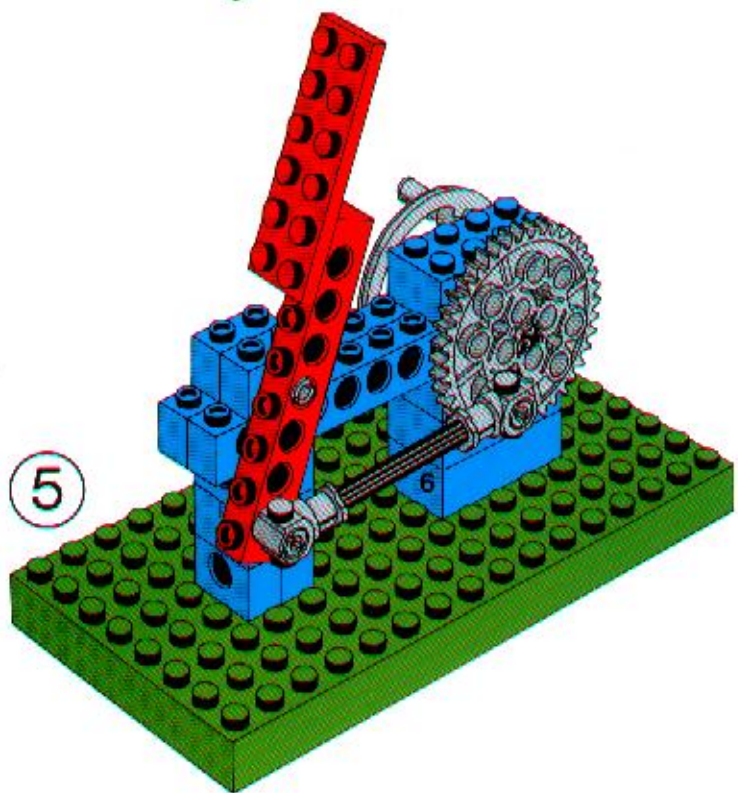
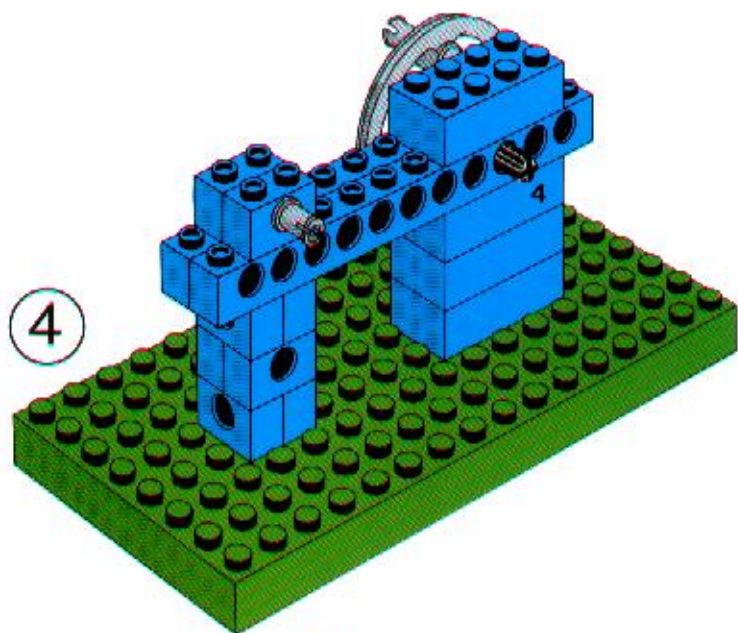

1

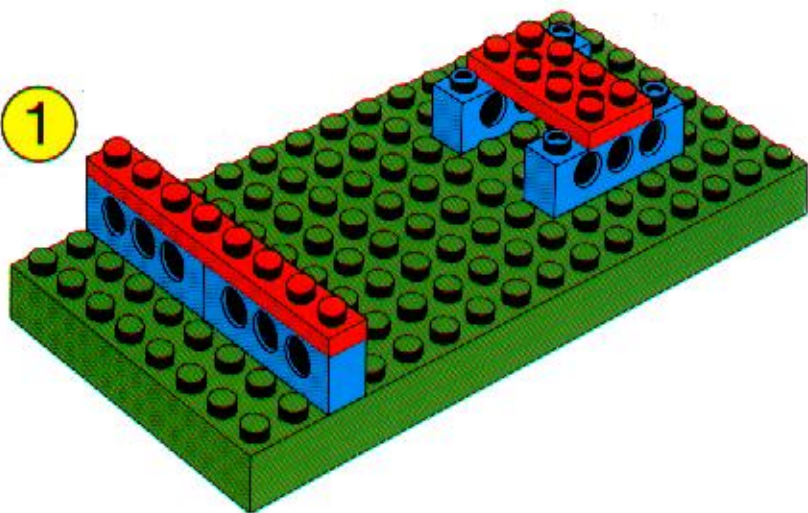

2

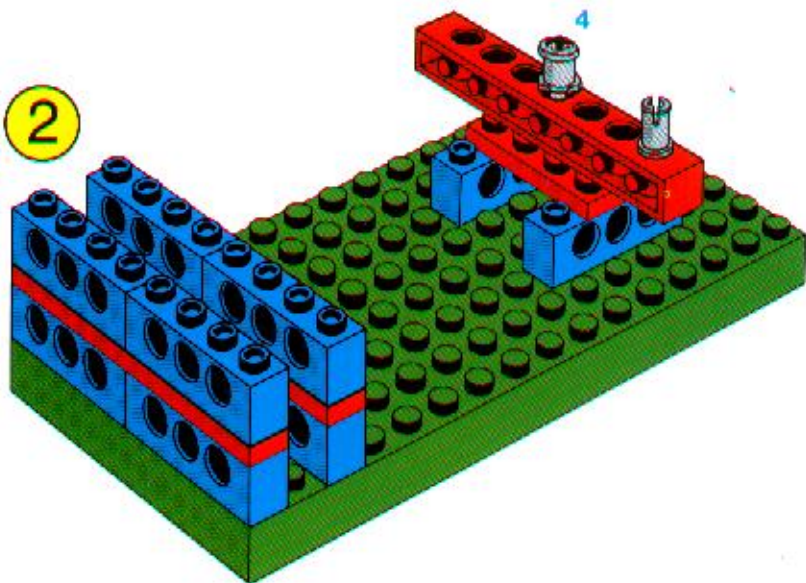

3

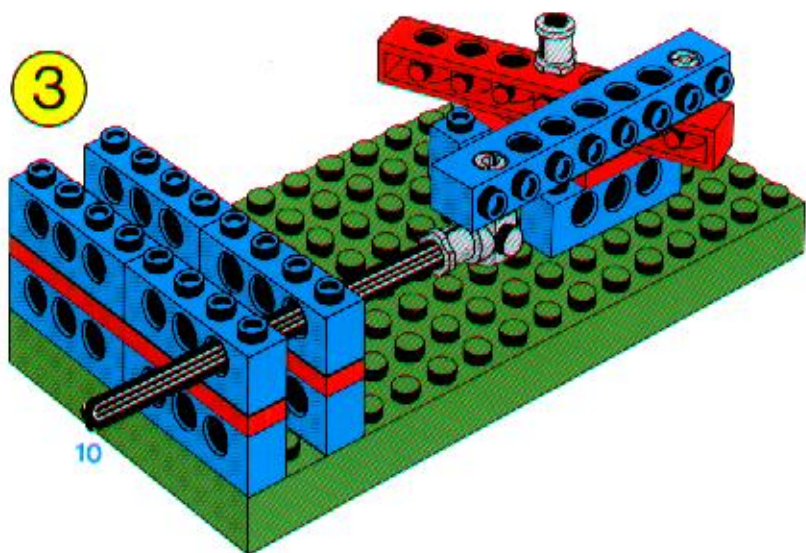

10

1

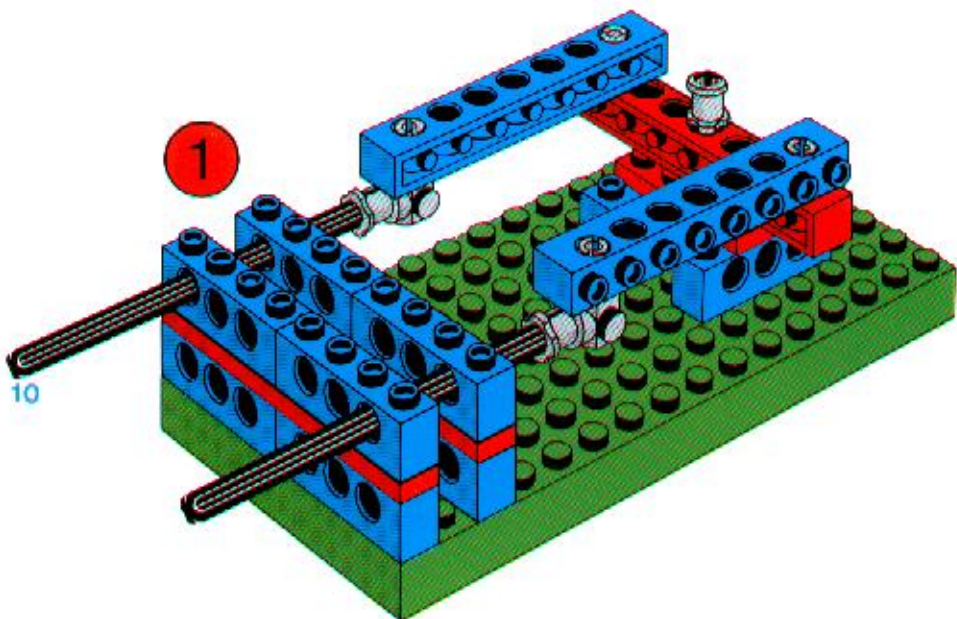

10

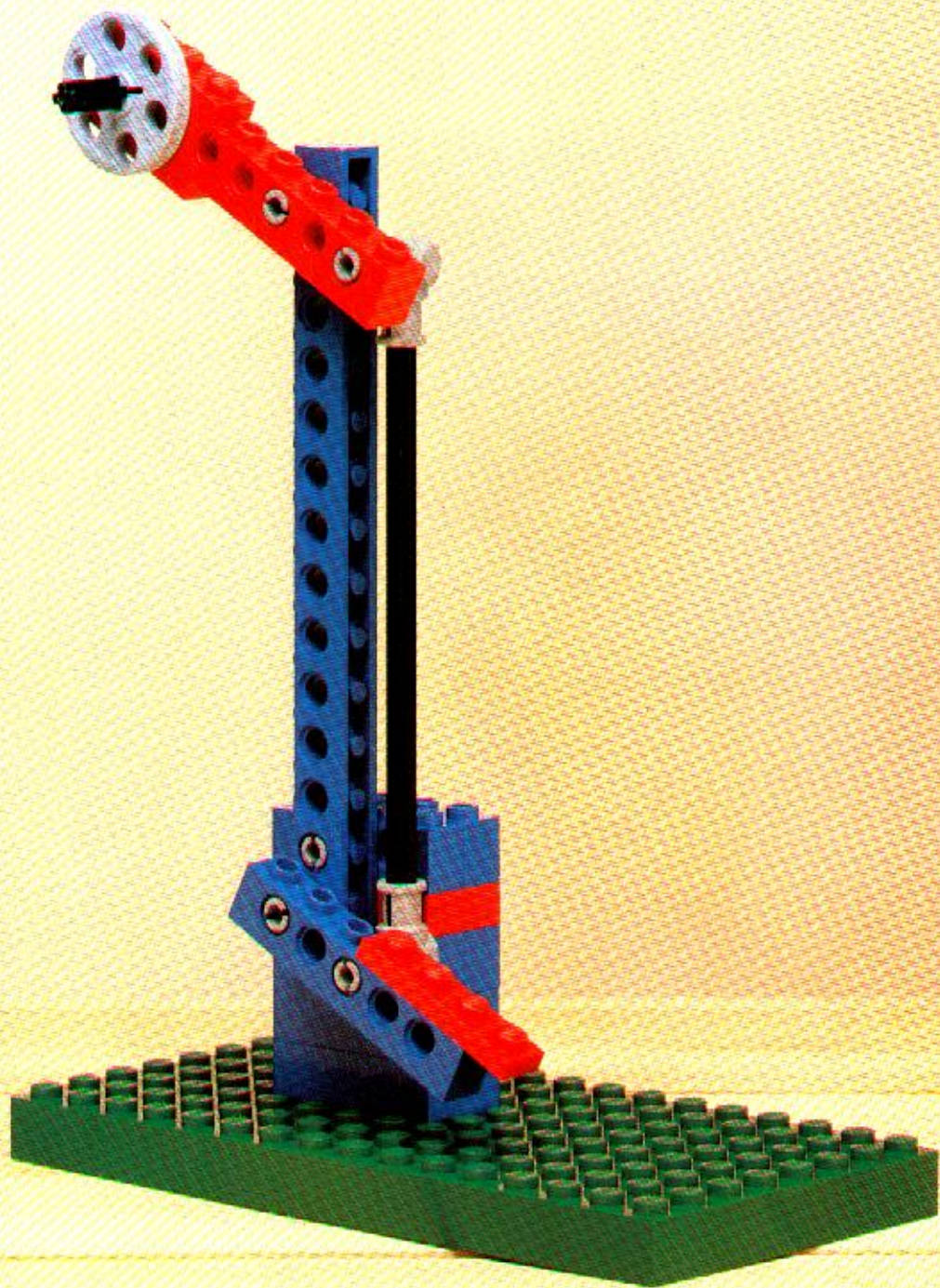

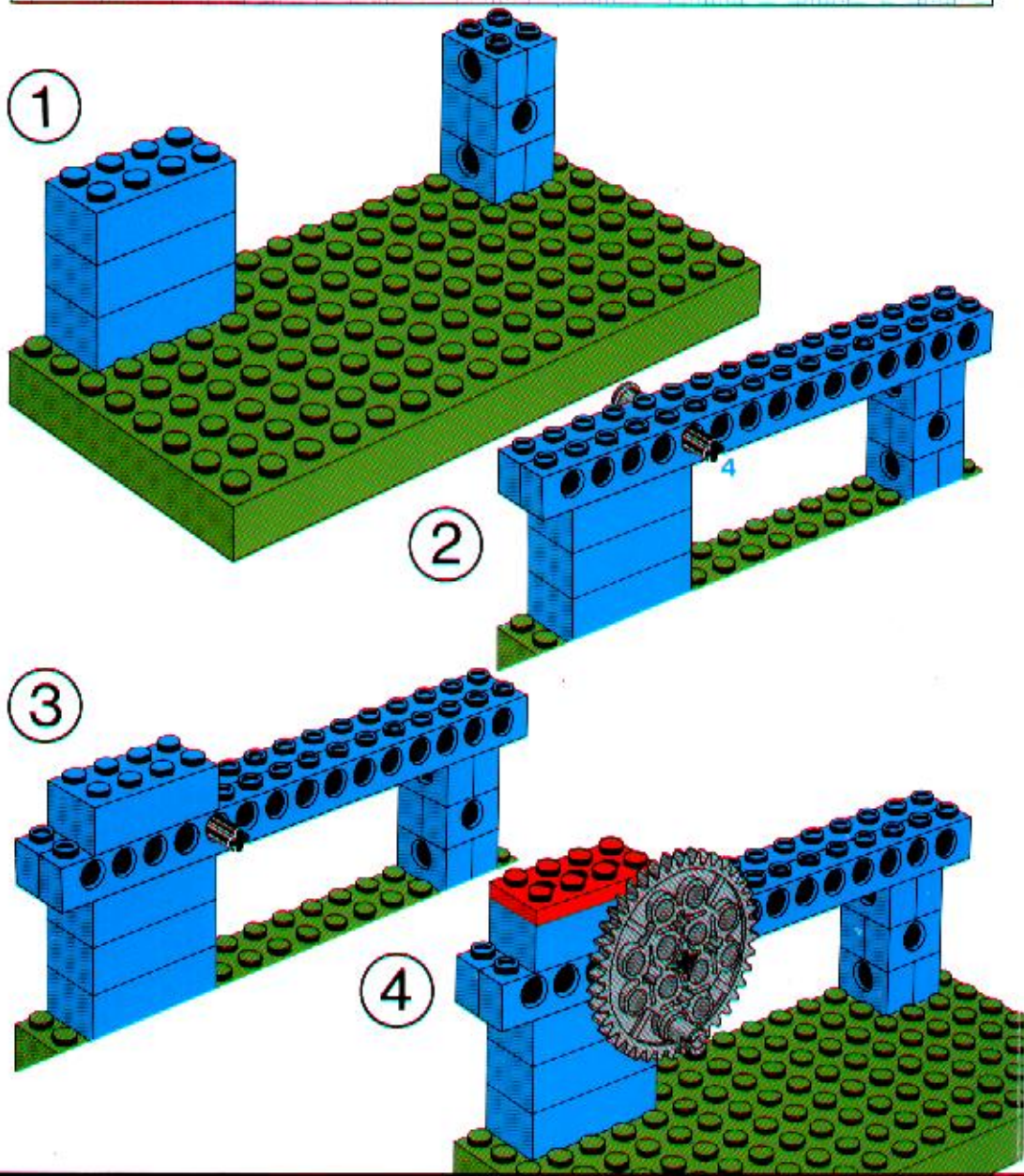
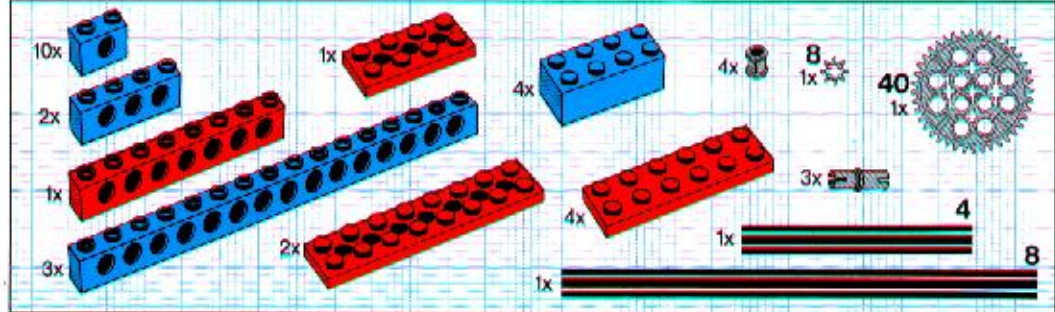

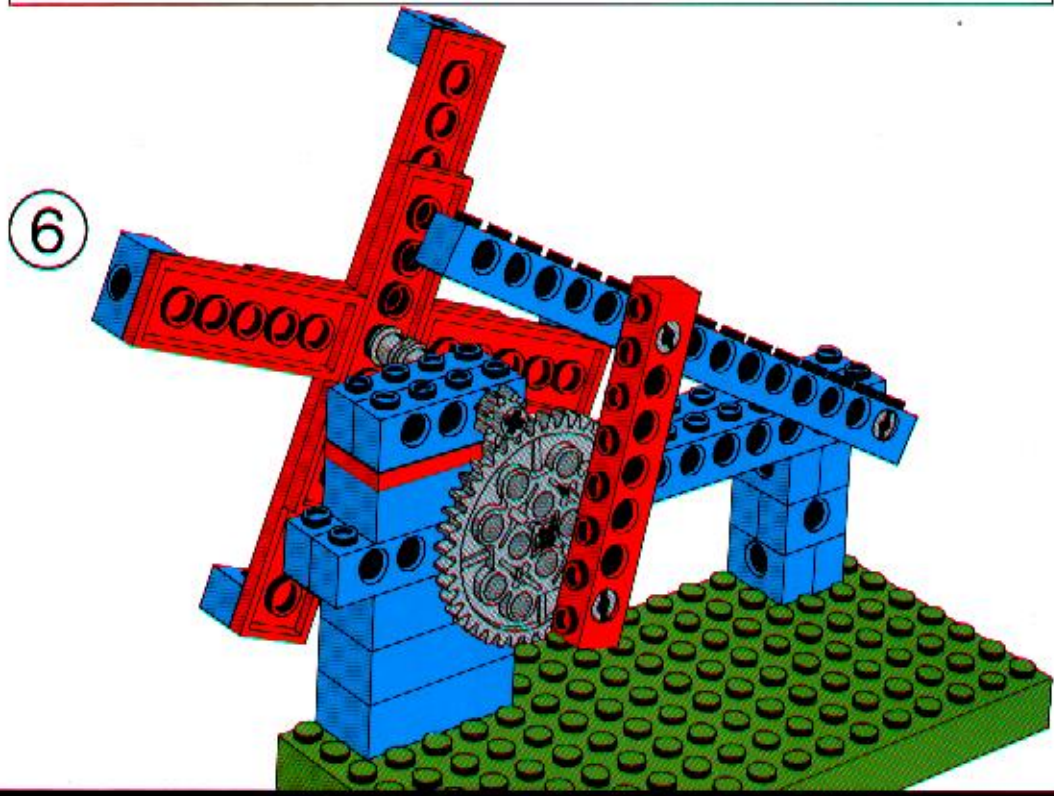
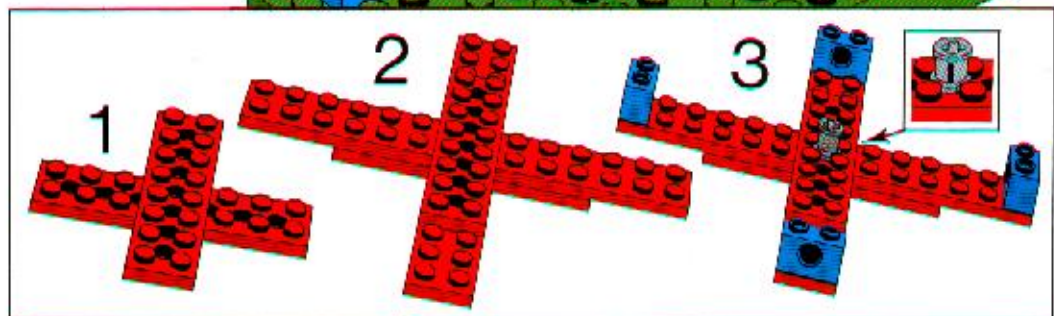
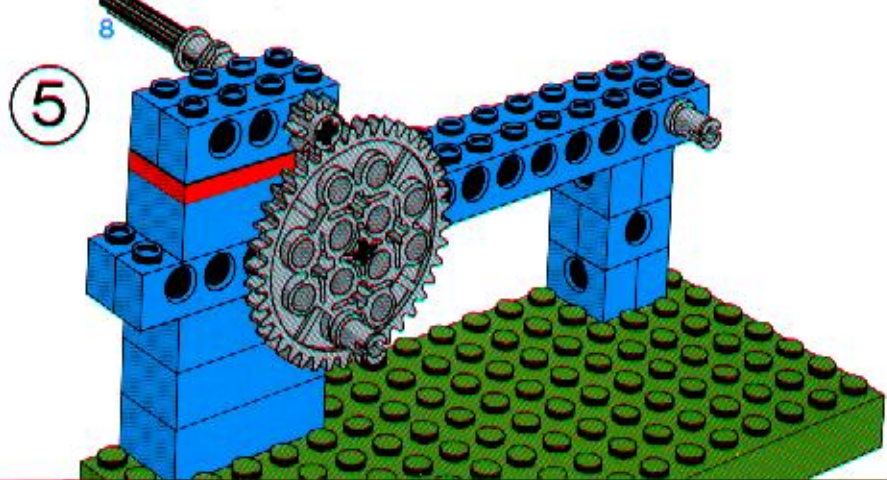

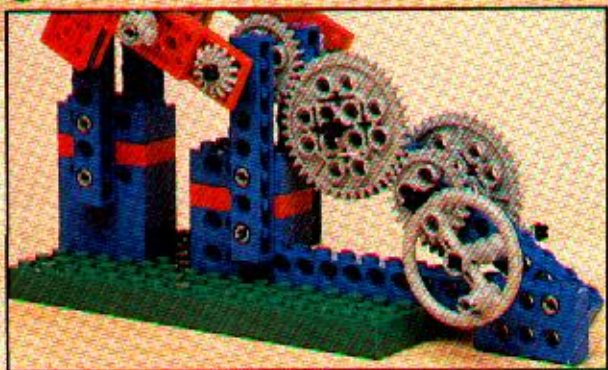
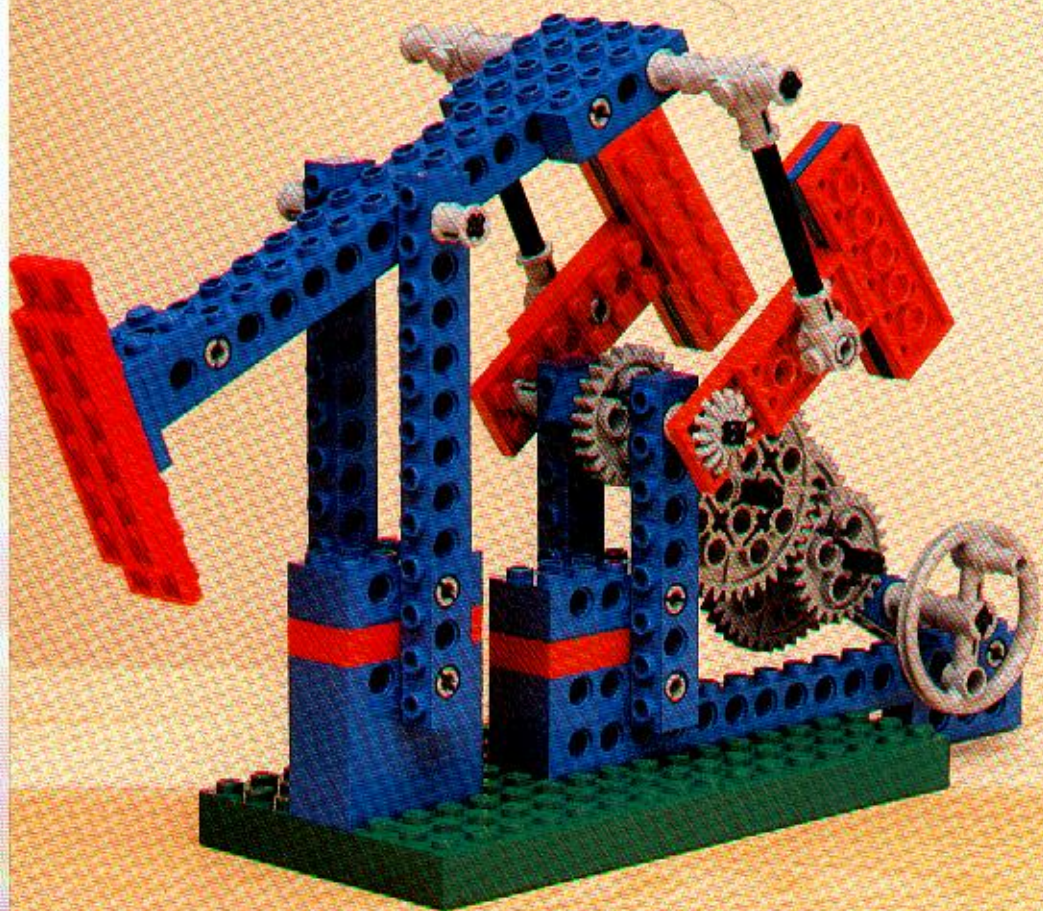



1031

10

**LEGO** dacta

Technic

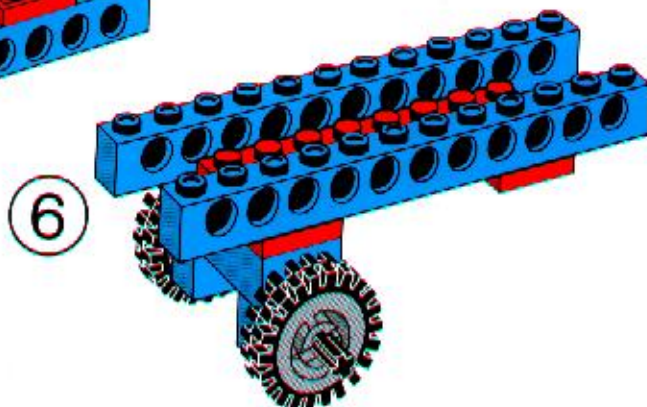
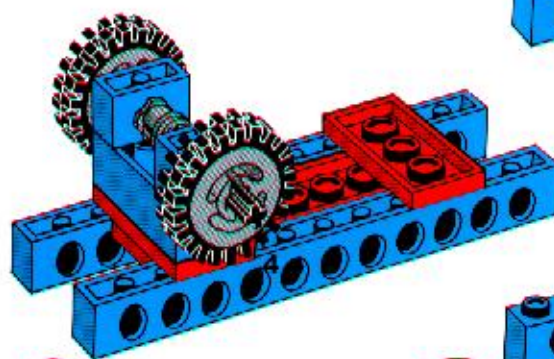
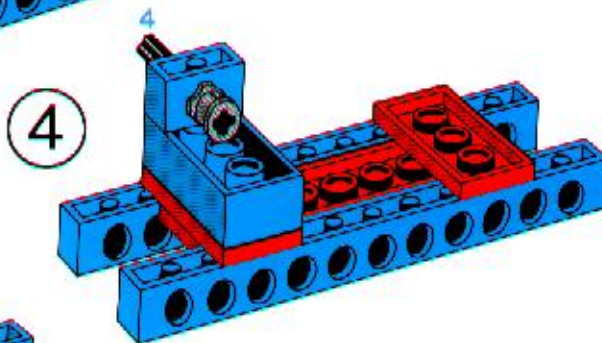
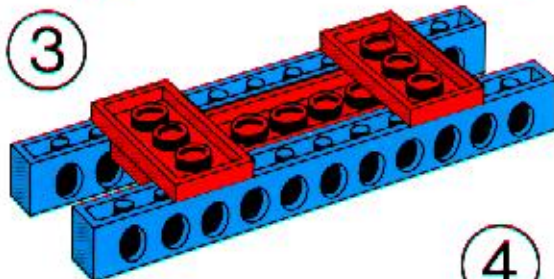
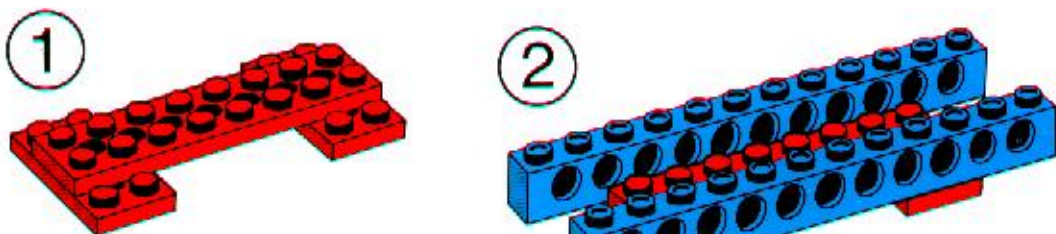
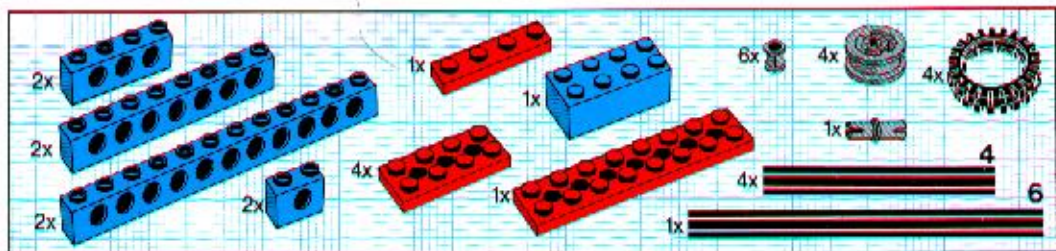

1

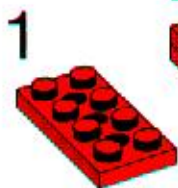

3

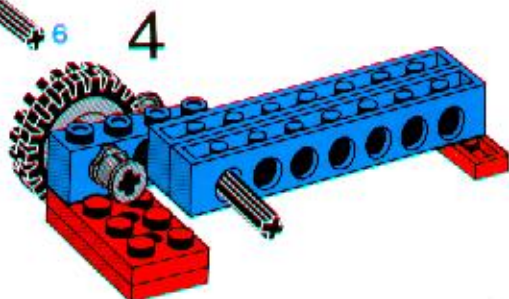
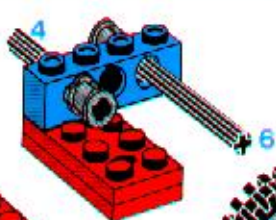

5

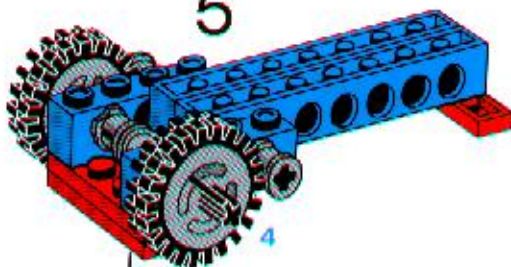

2

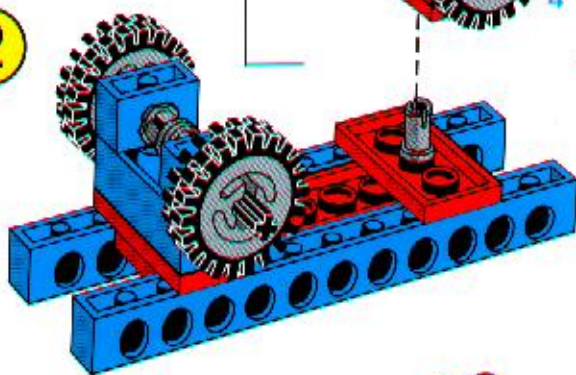

3

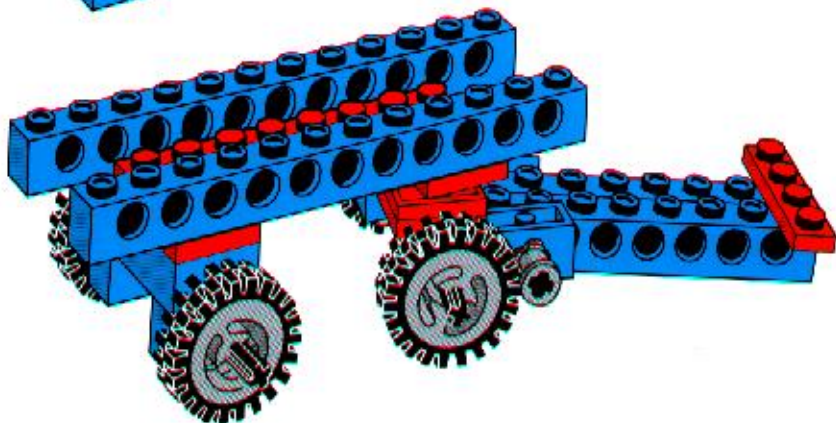

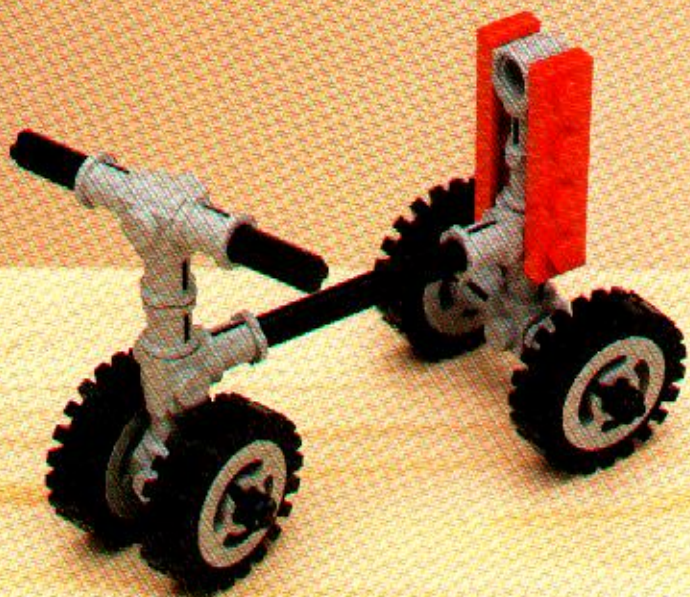
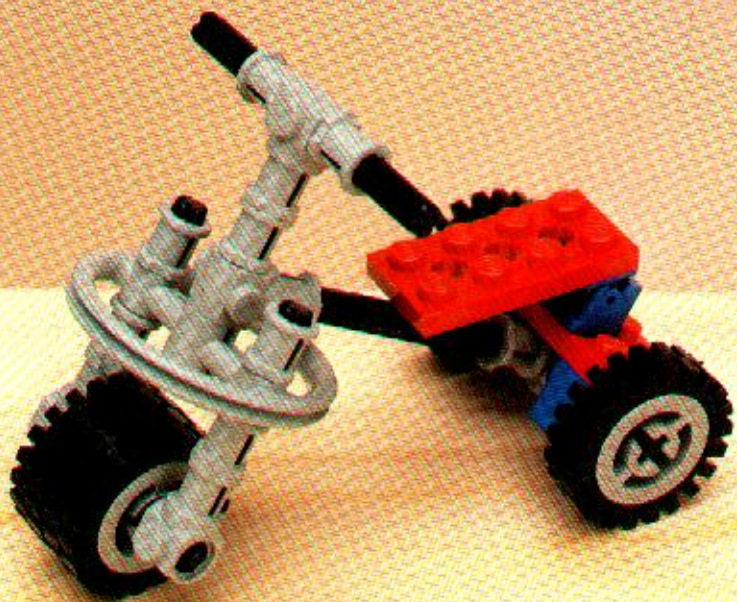



1031

11



LEGO dacta

Technic

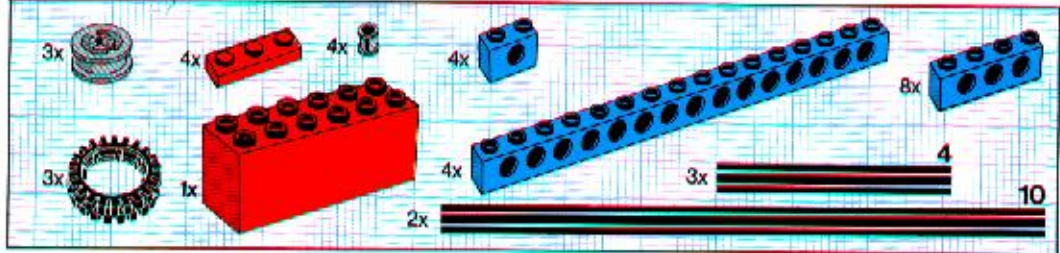

1

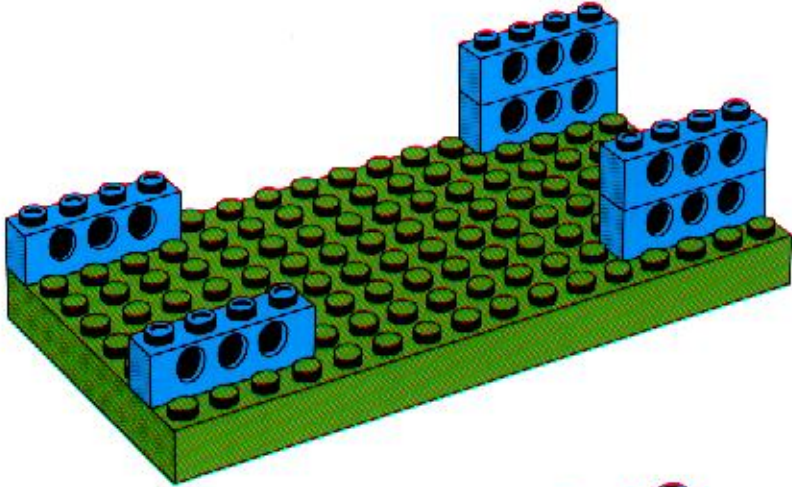

2

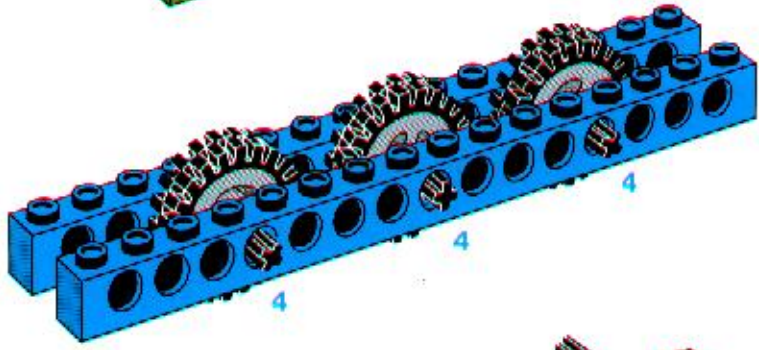

3

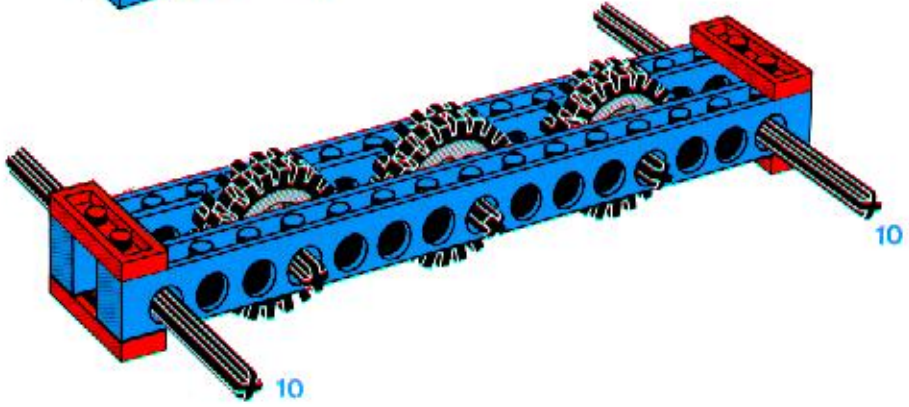

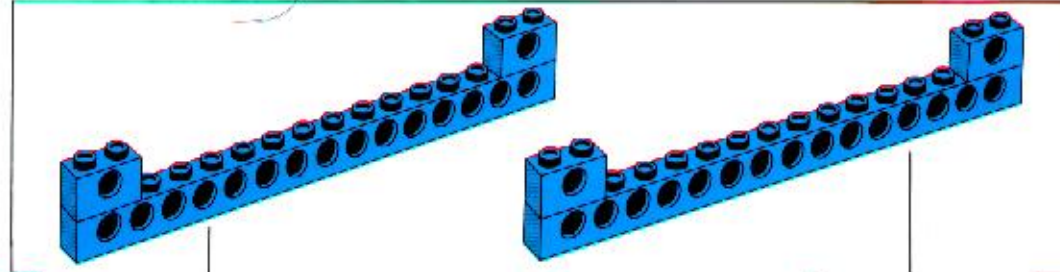

4

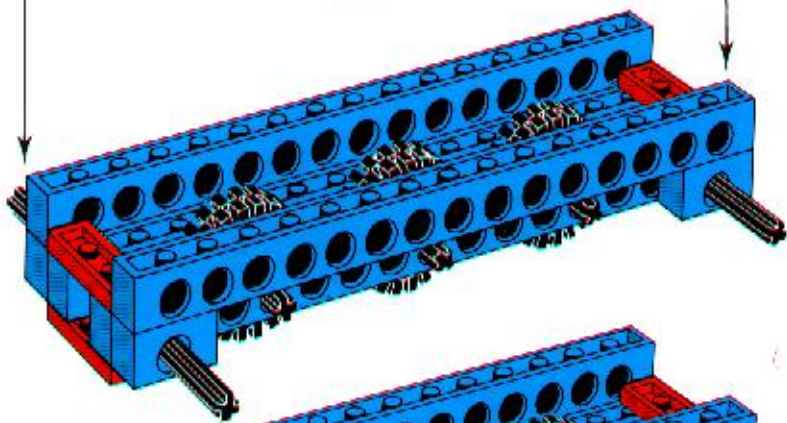

5

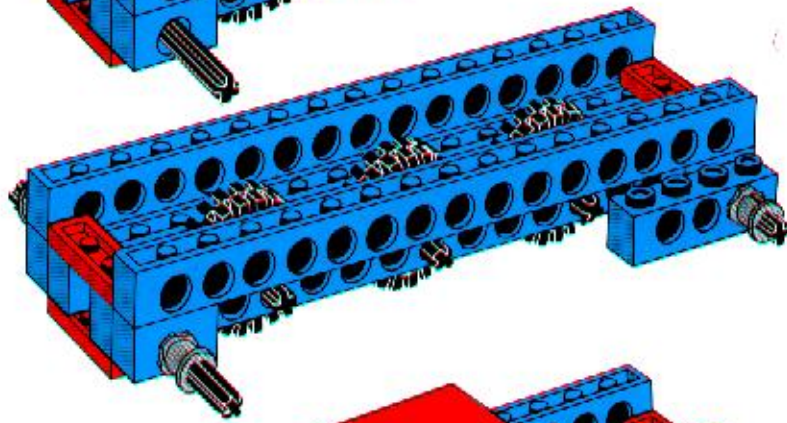

6

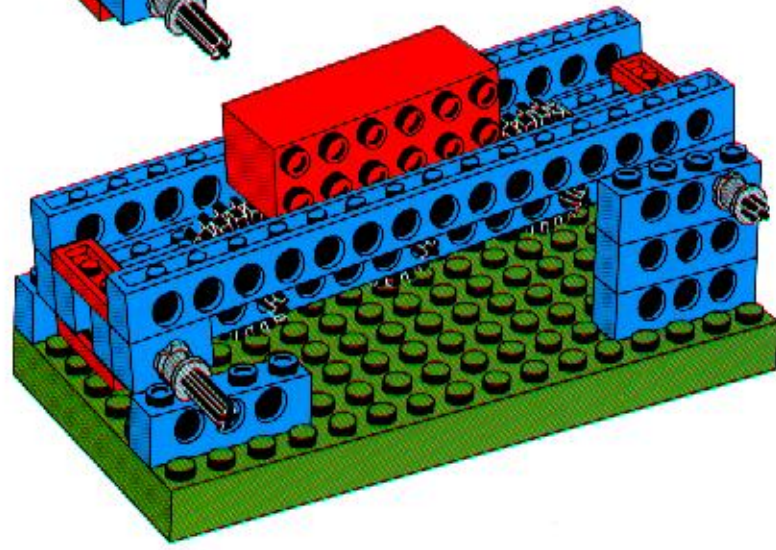

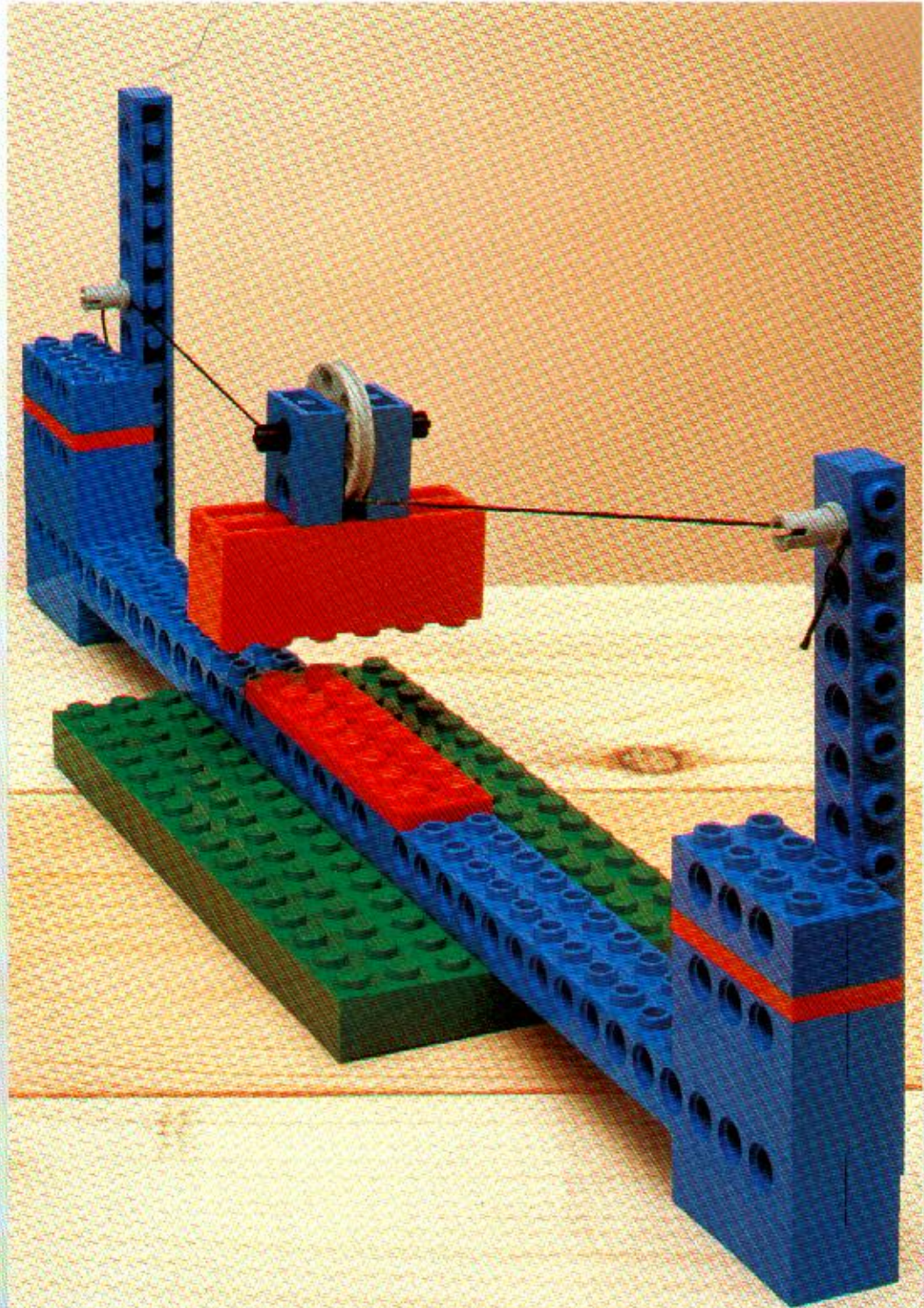



1031

12

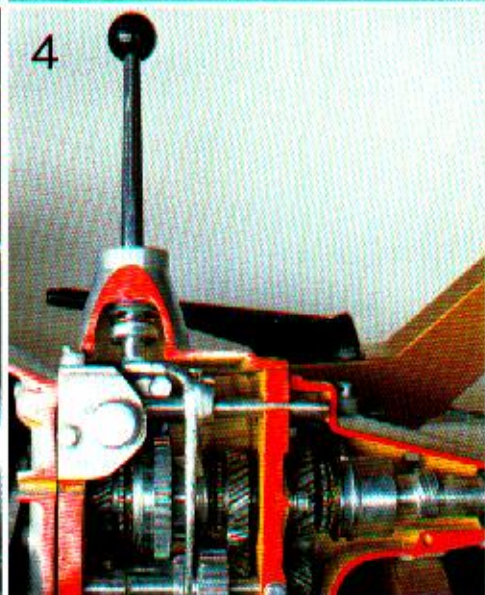
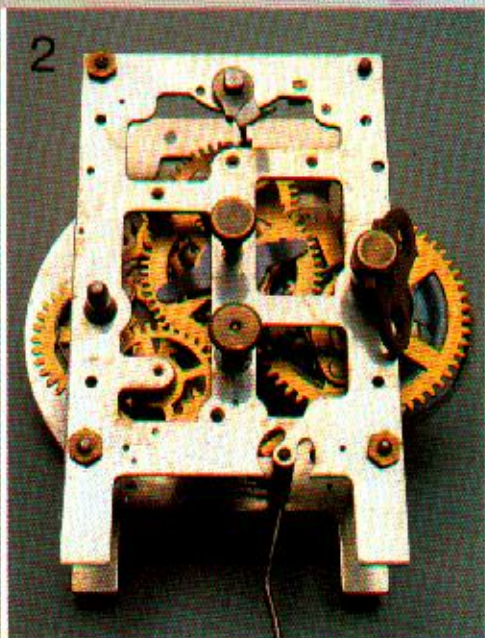
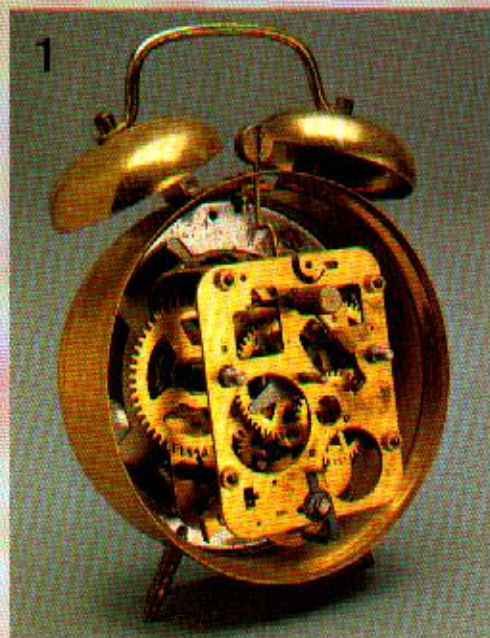

LEGO dacta

Technic

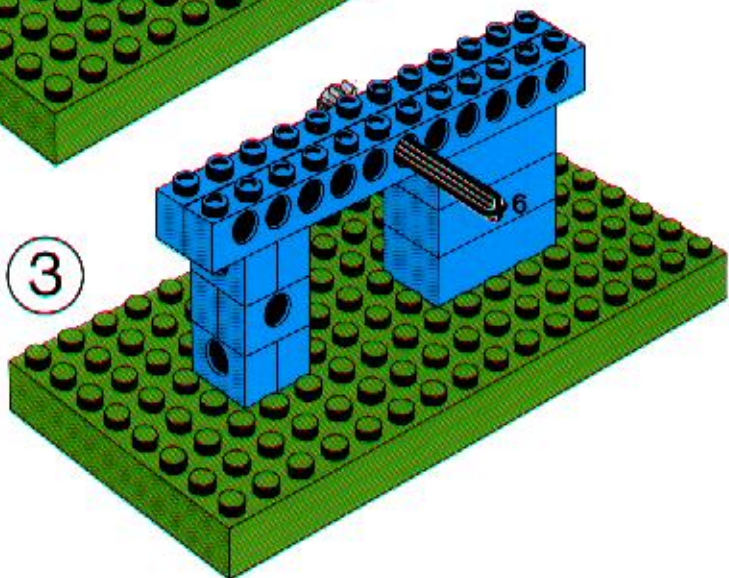
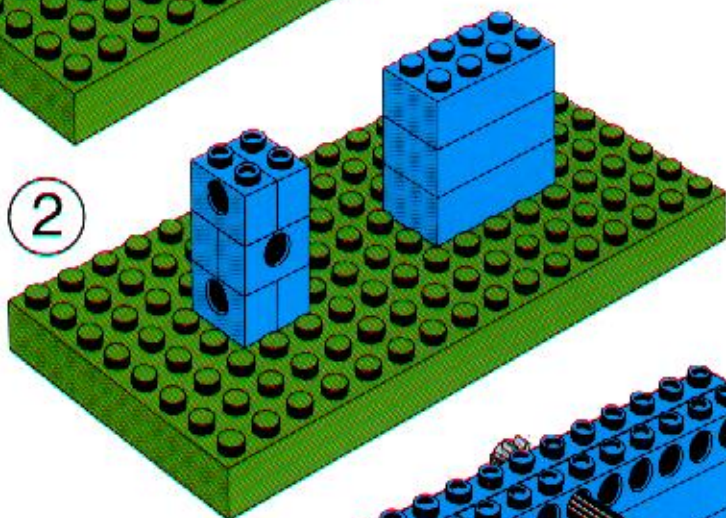
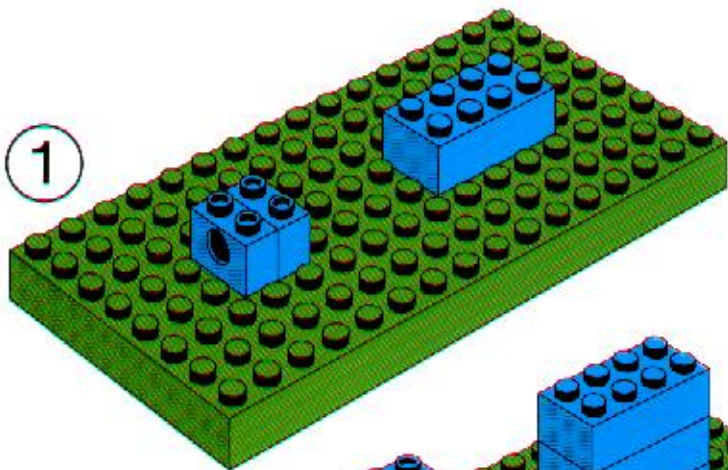
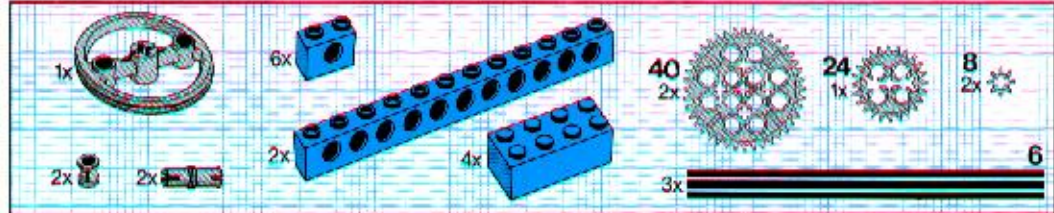

4

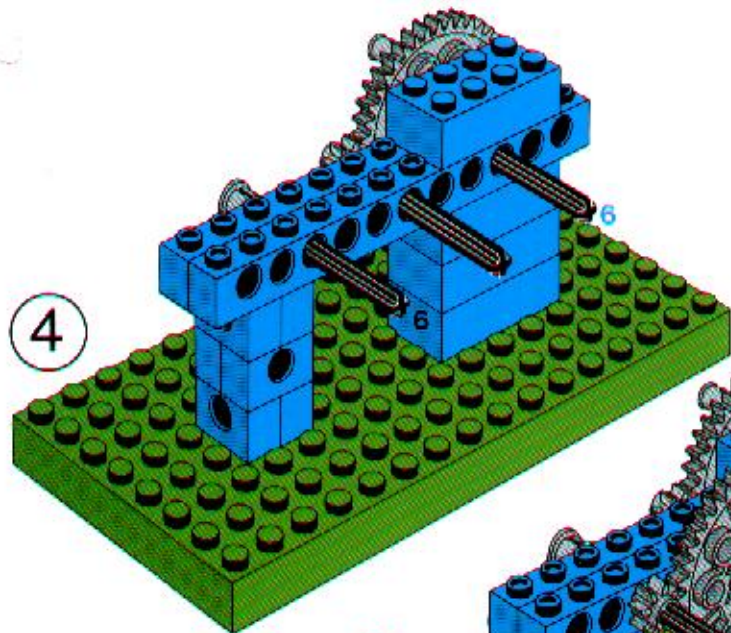

5

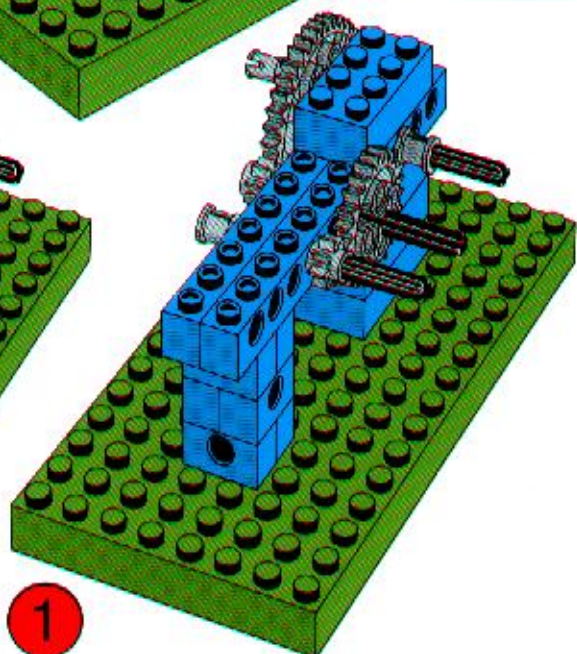
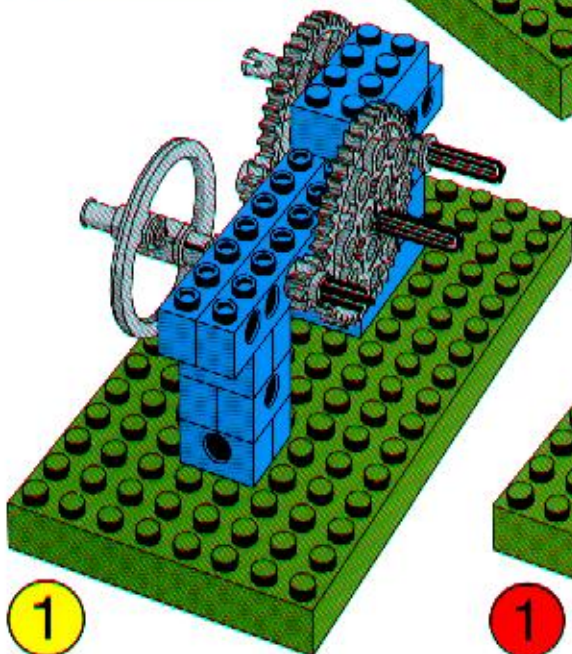
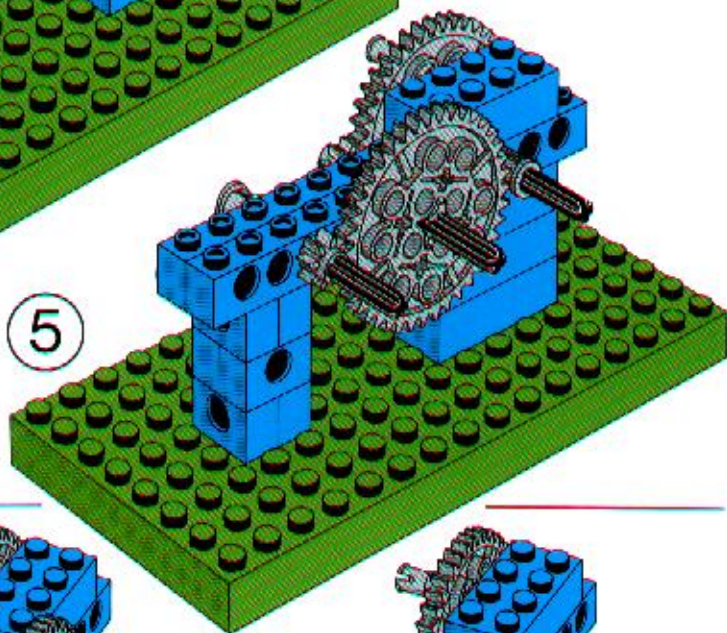

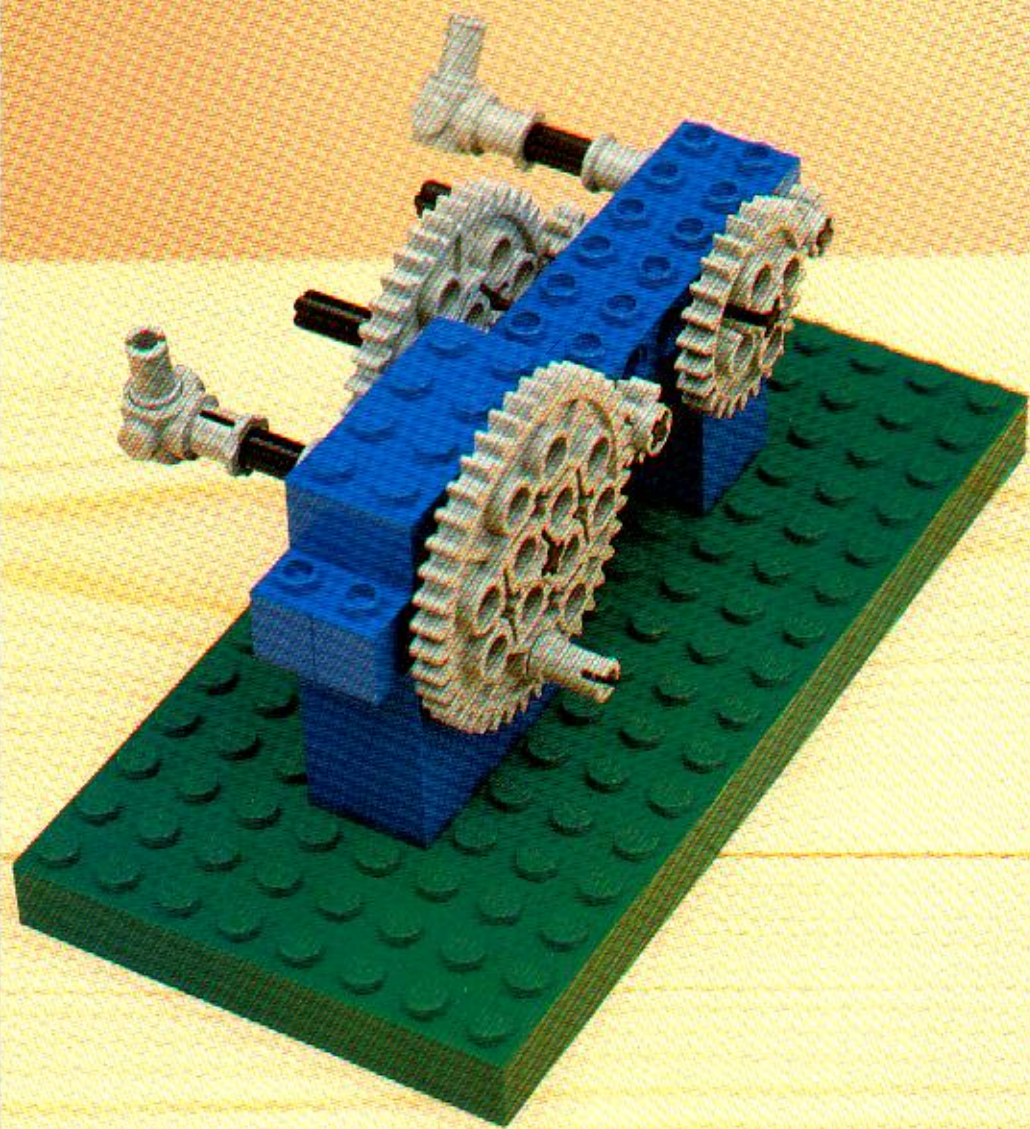



1031

13

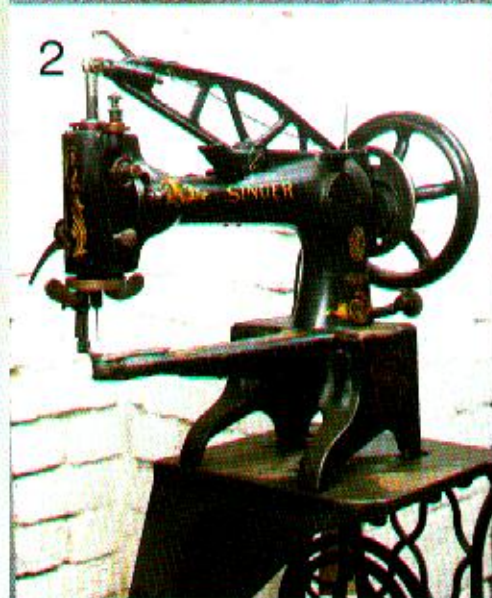

LEGO dacta

Technic

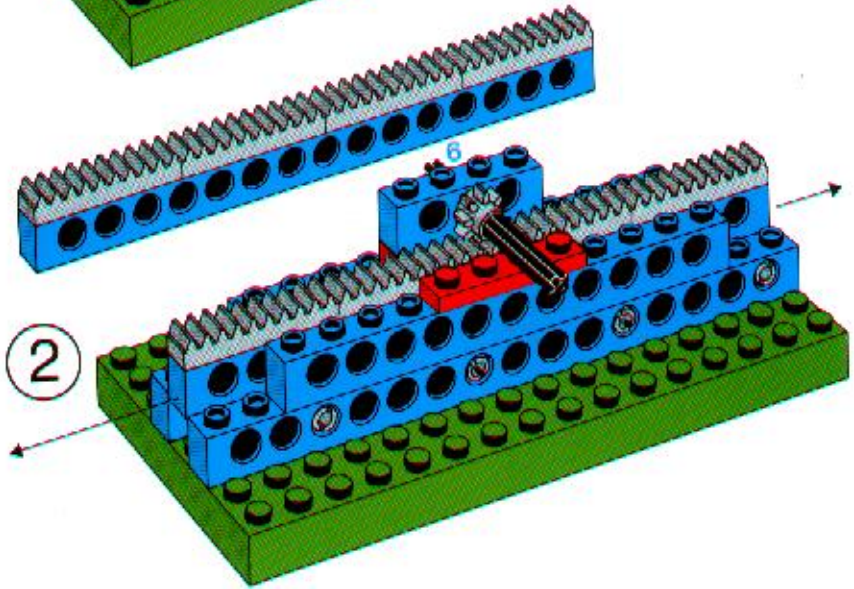
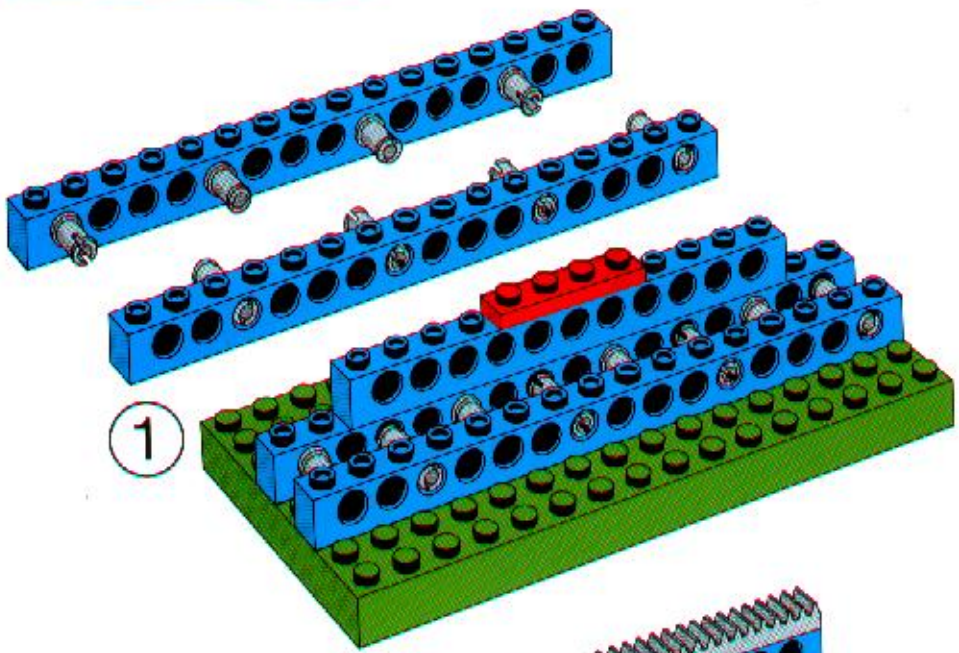
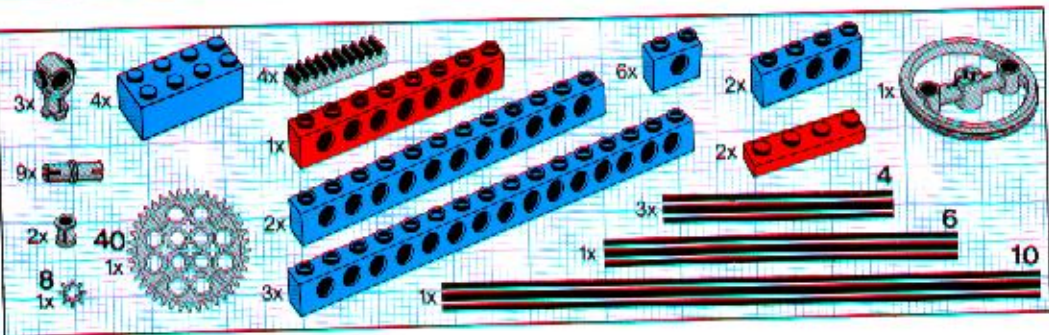

3

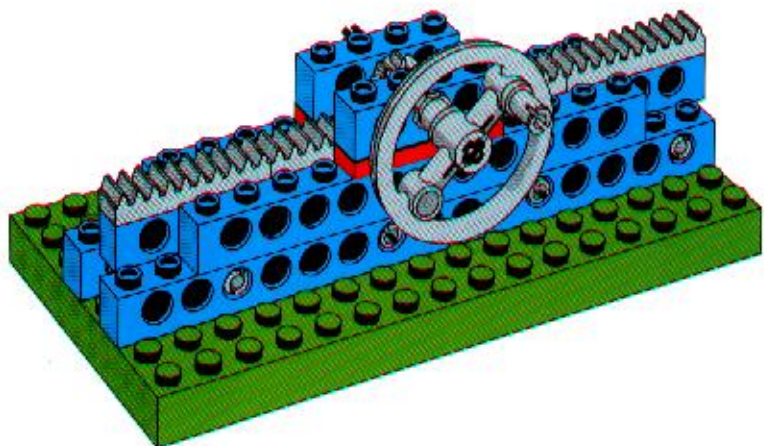

1

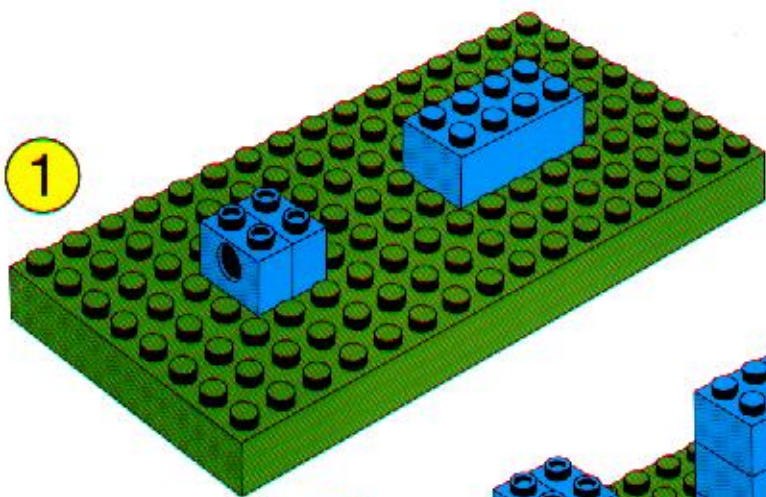

2

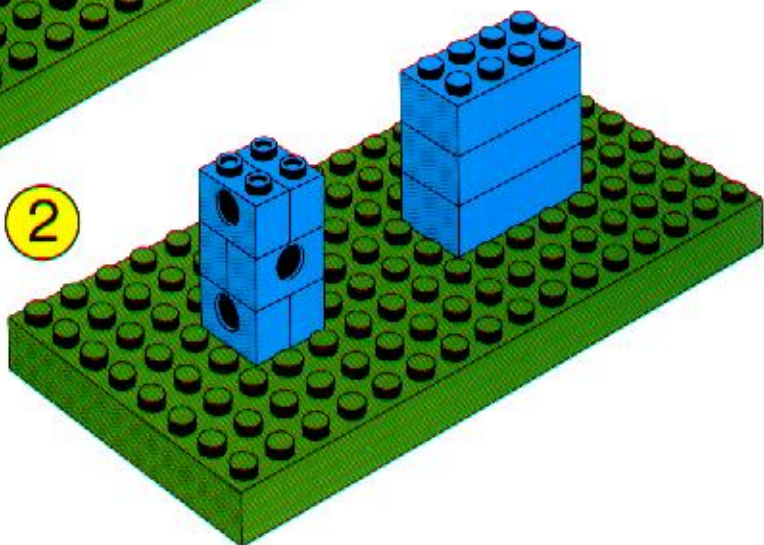

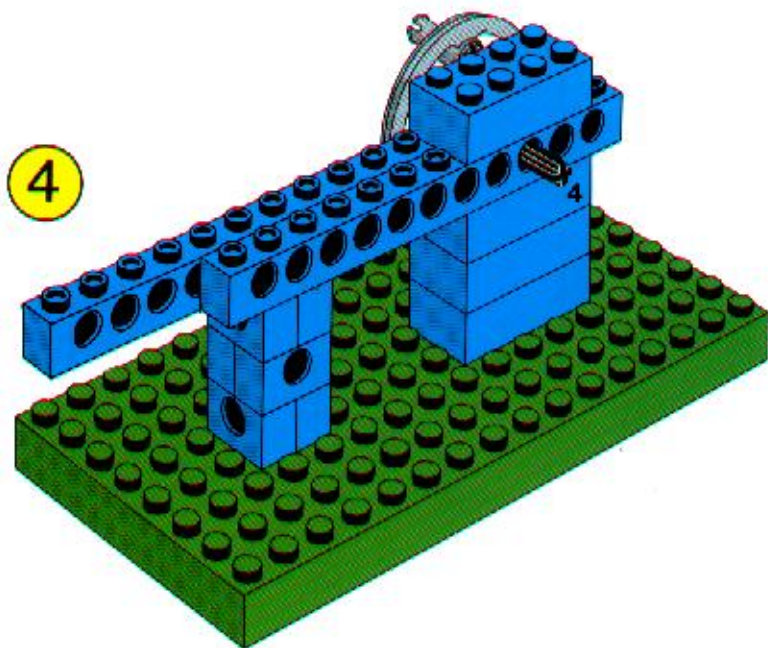
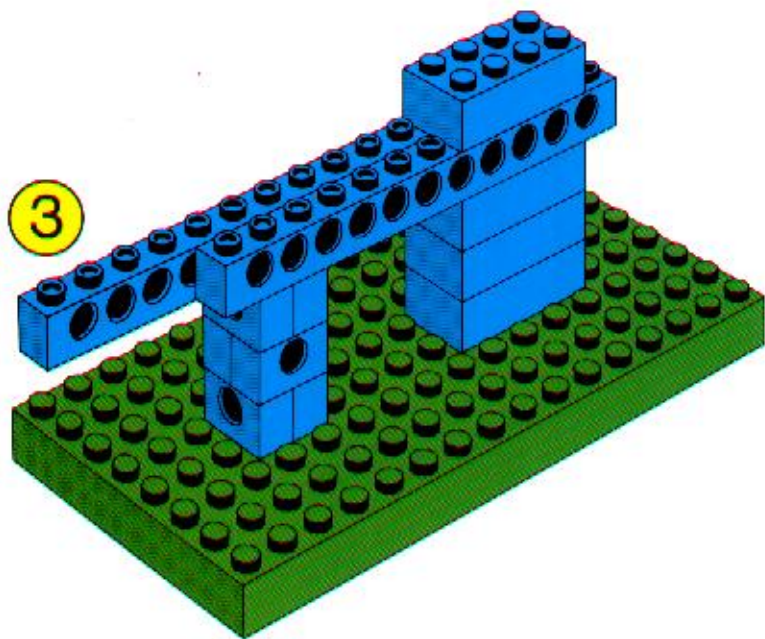

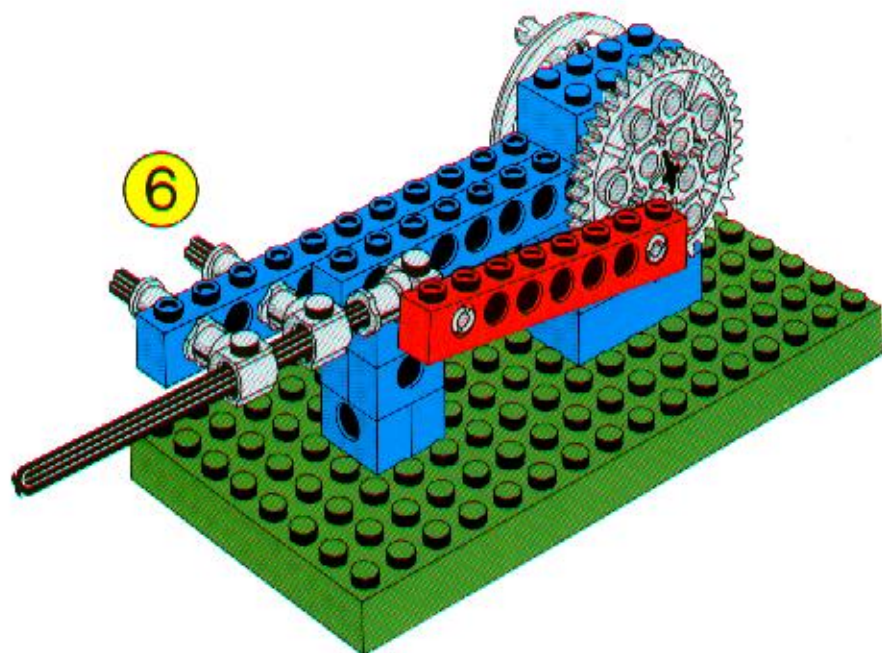
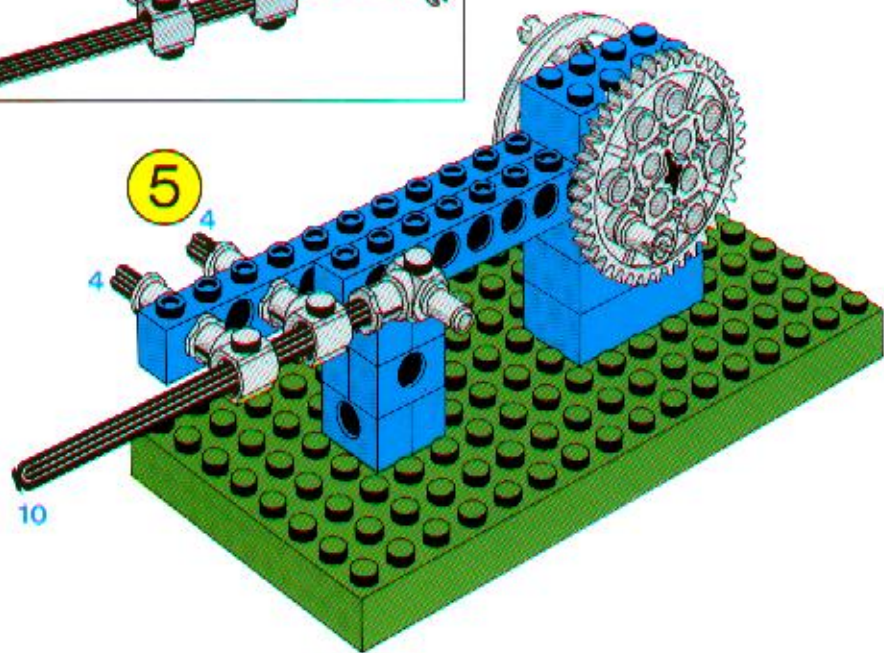
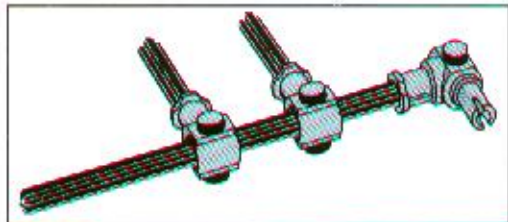

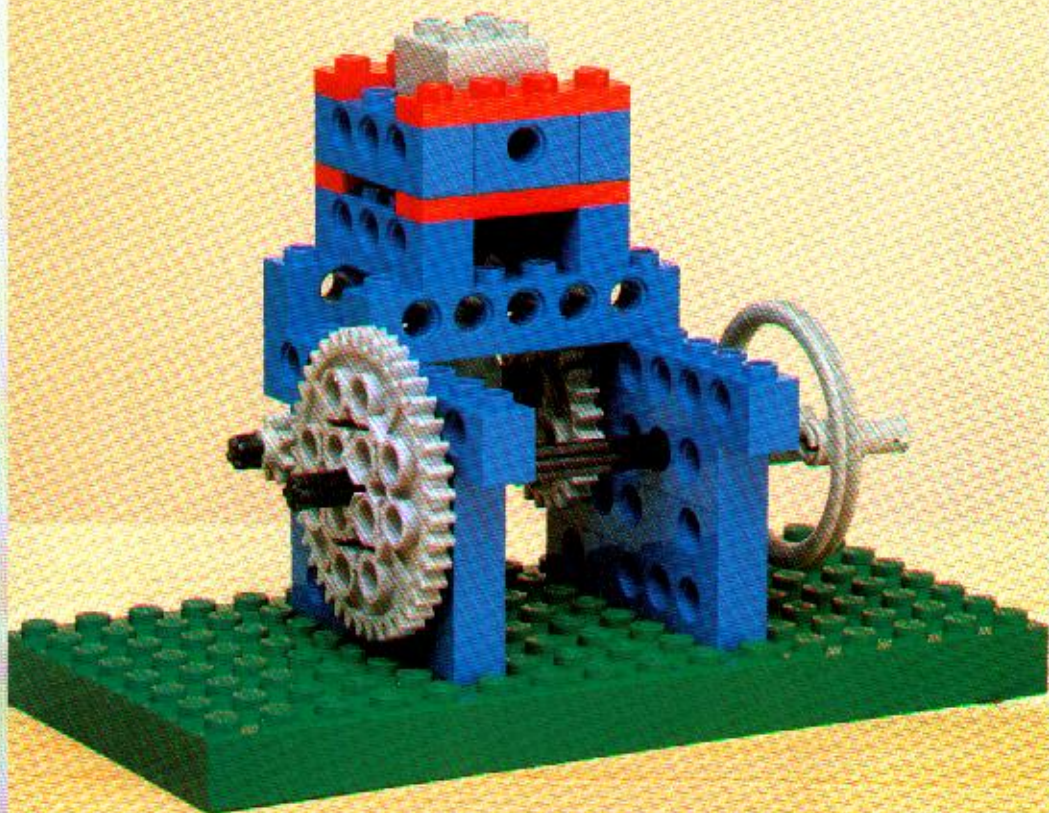
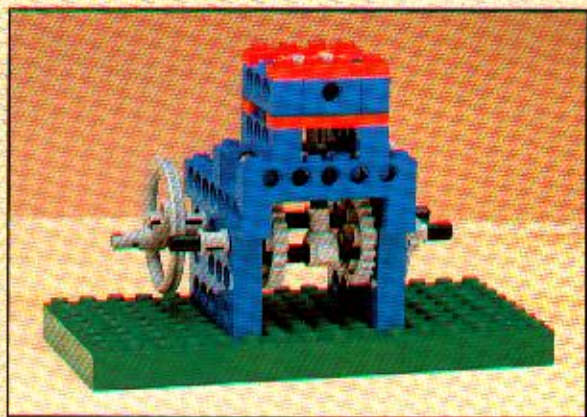



1031

14

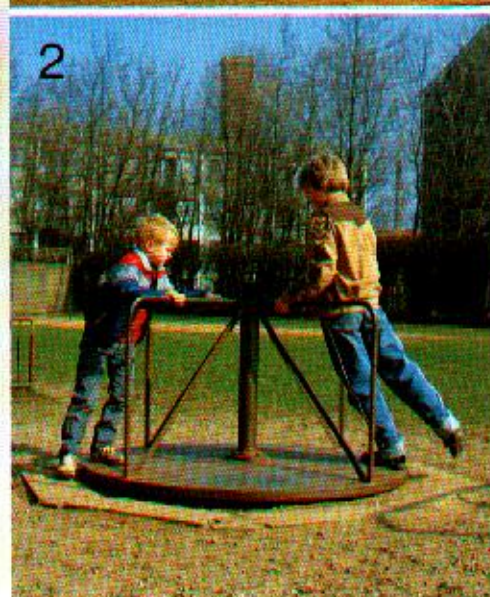

LEGO dacta

Technic

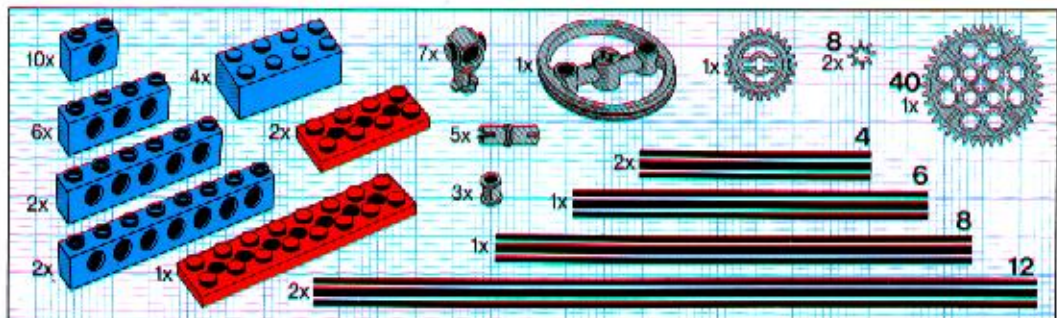

1

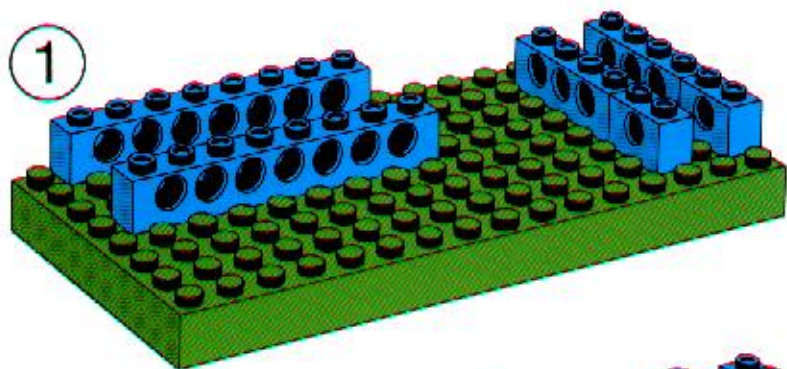

2

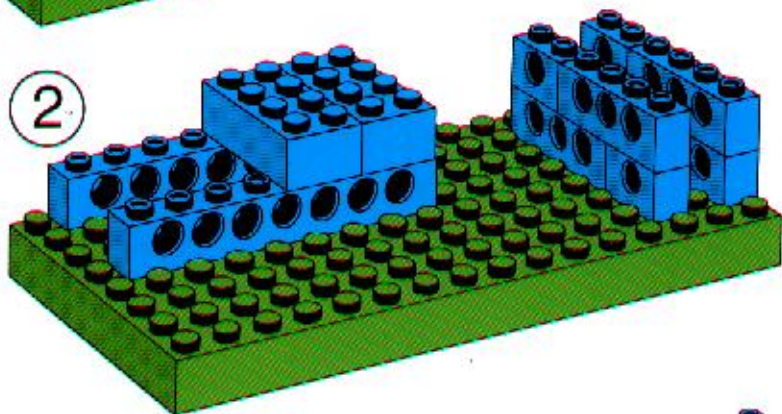

3

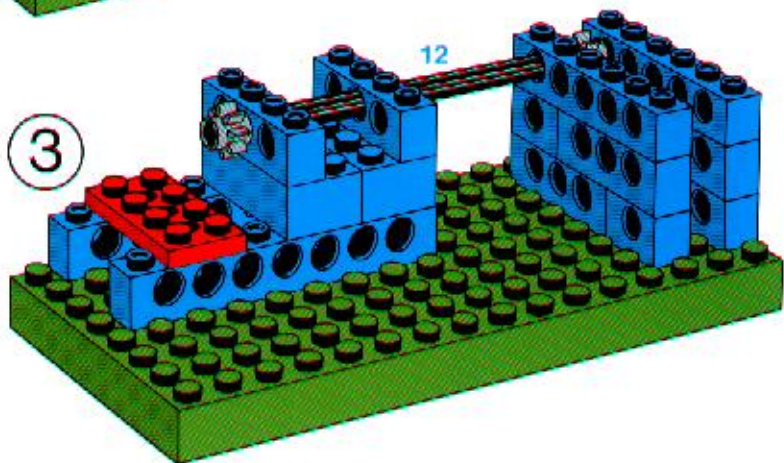

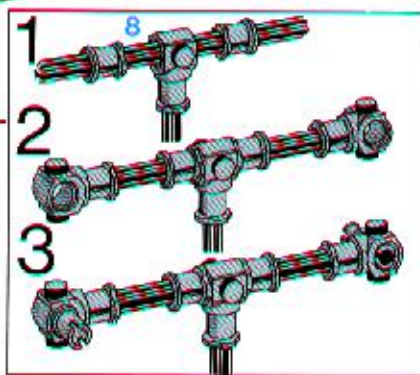
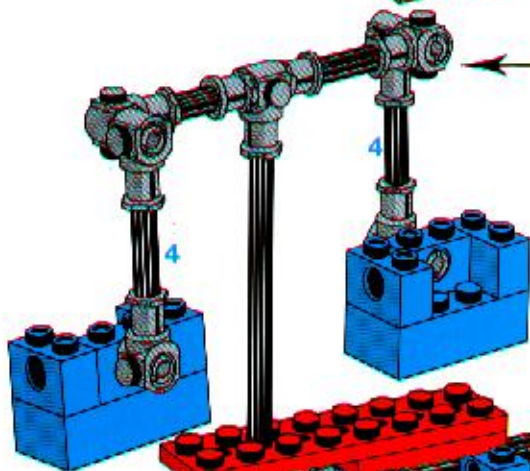
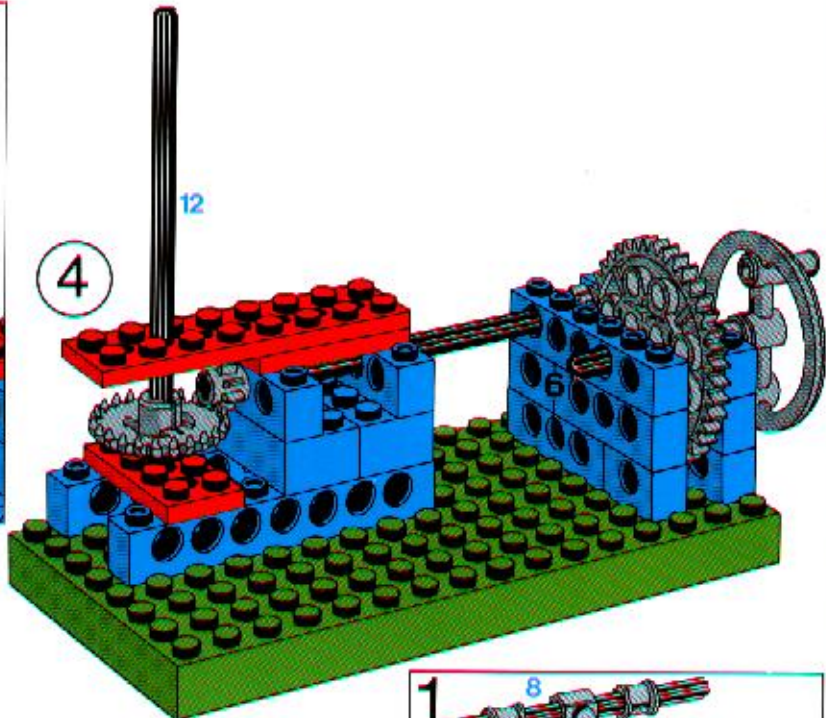
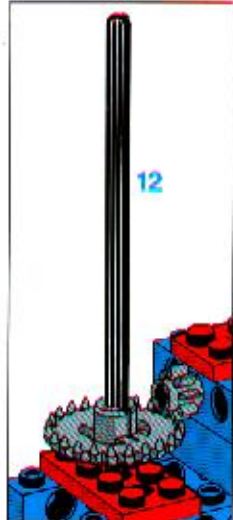

5

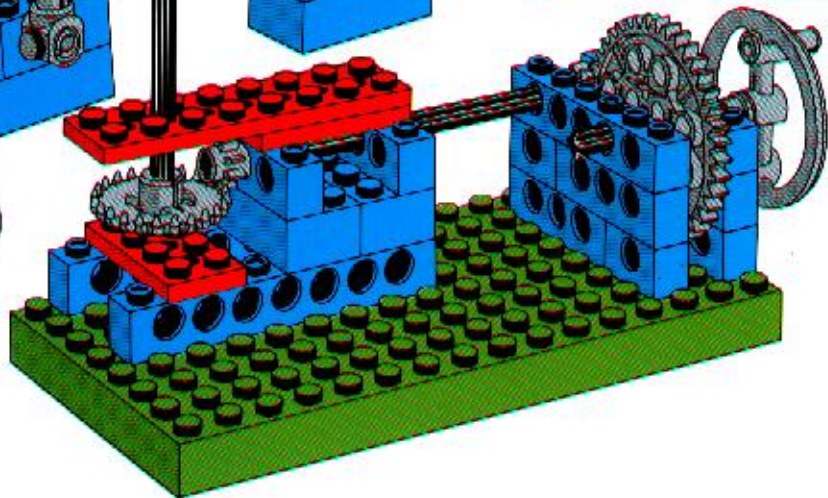

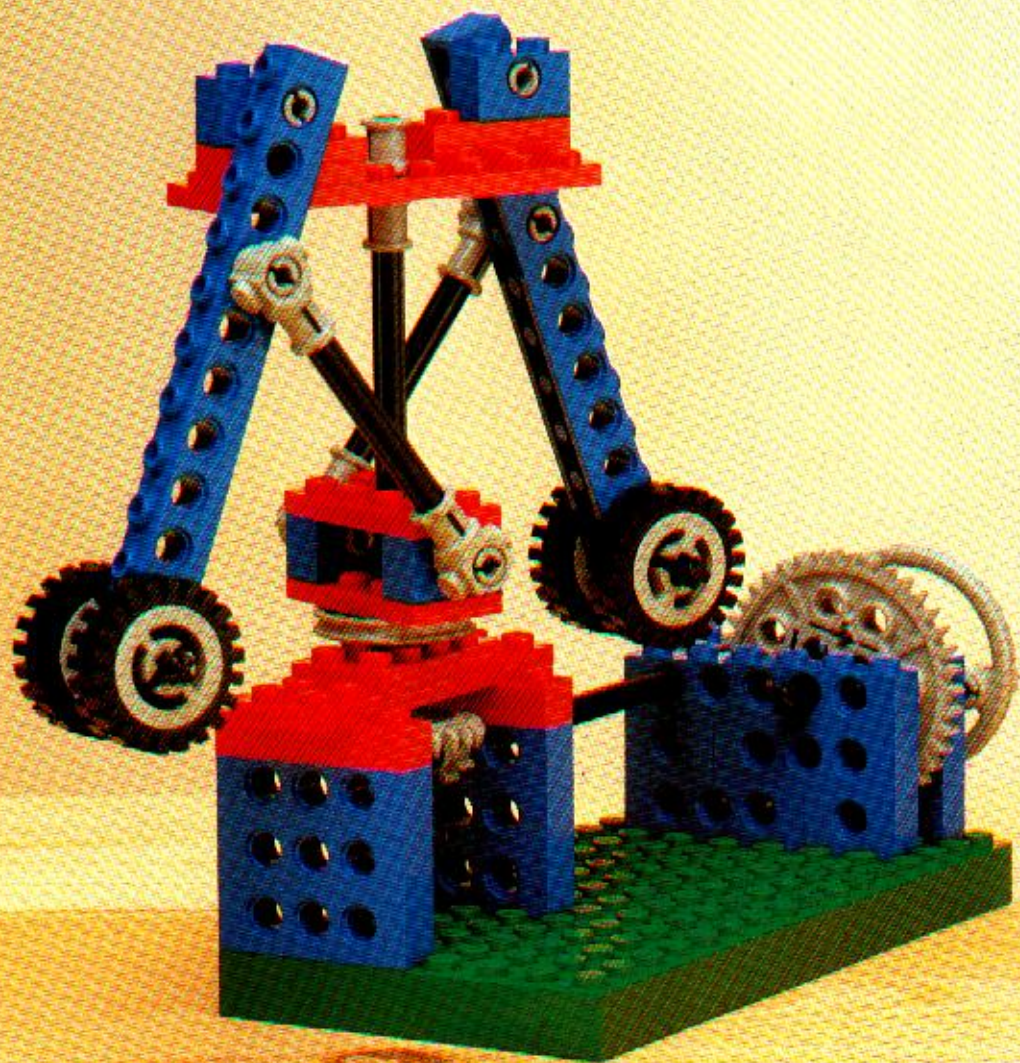



1031

15

1



2



3

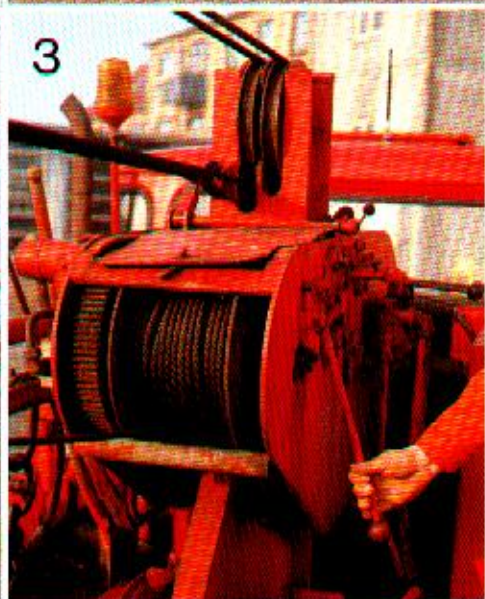

LEGO dacta

Technic

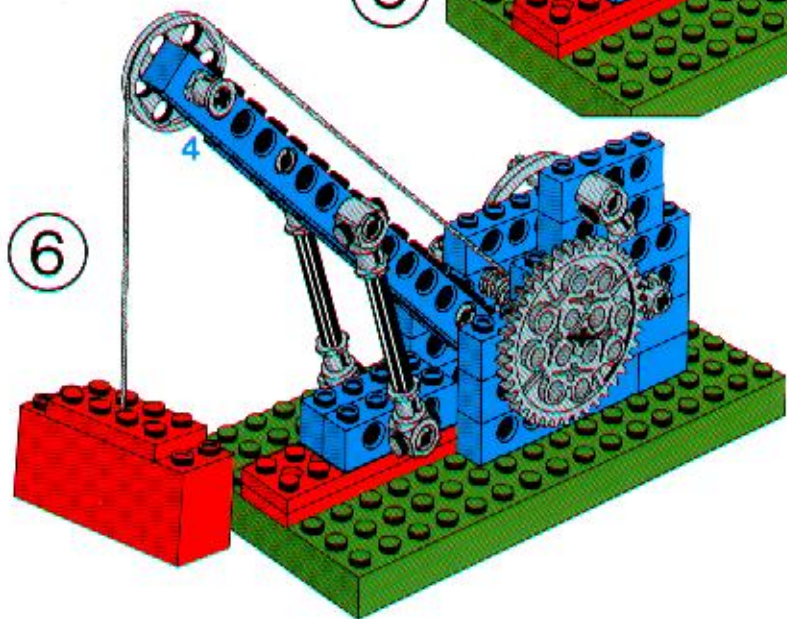
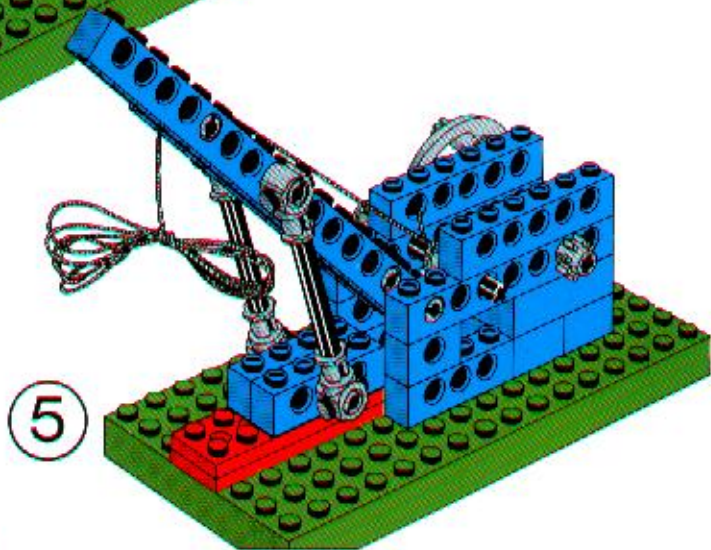
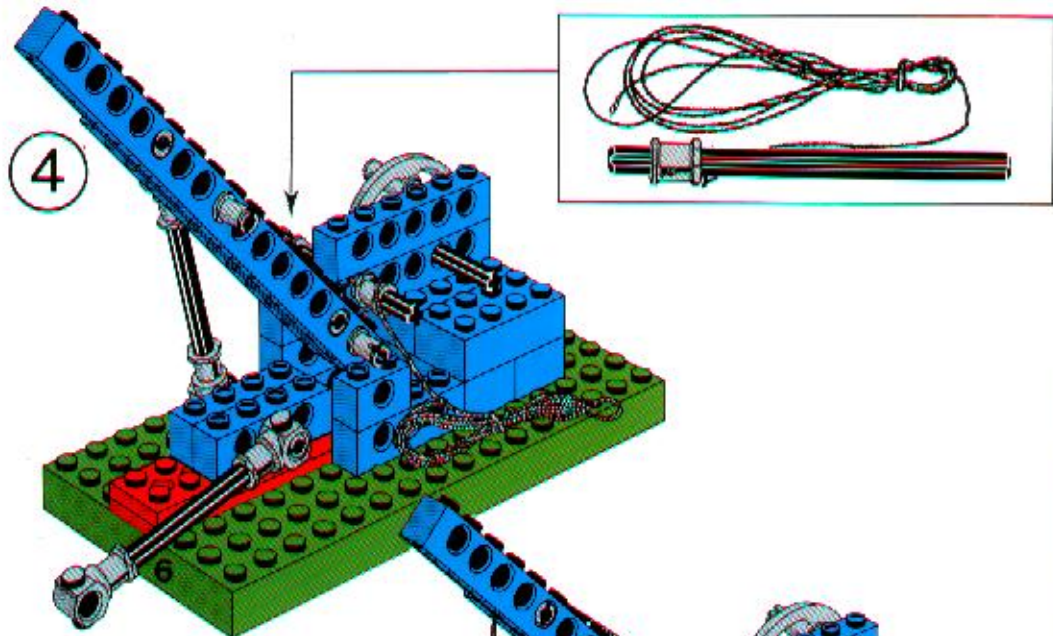

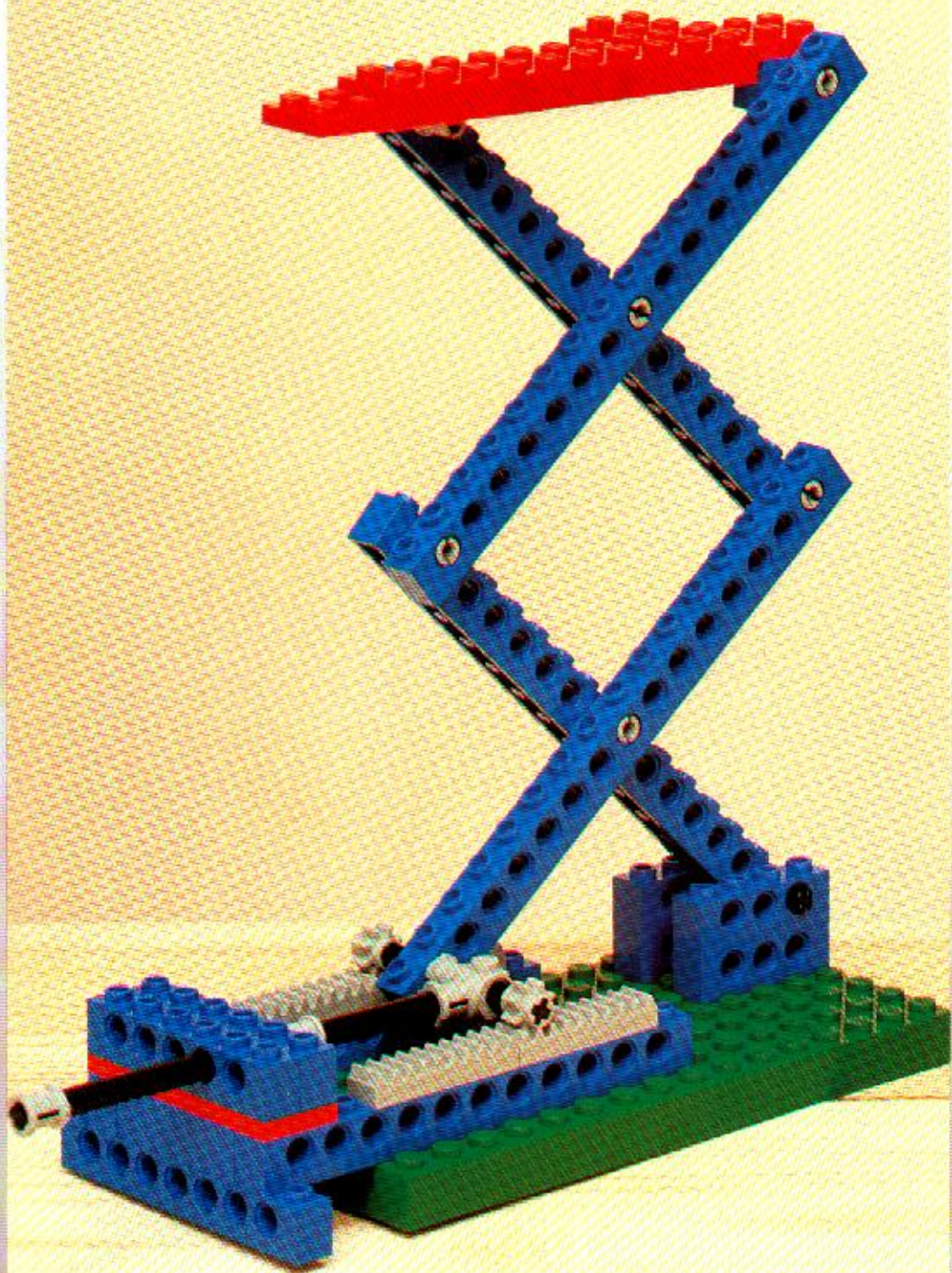



1031

16

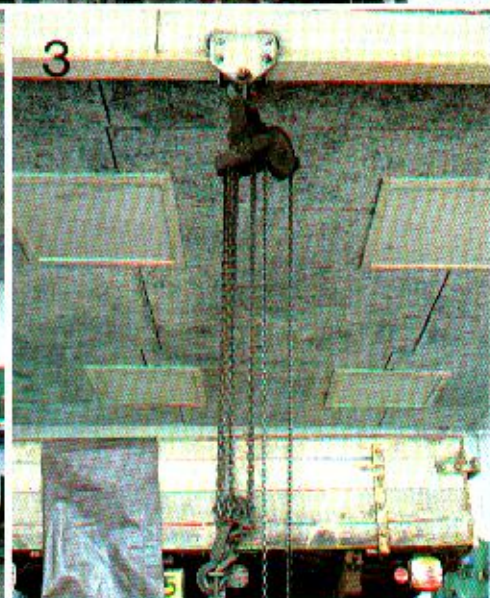

LEGO dacta

Technic

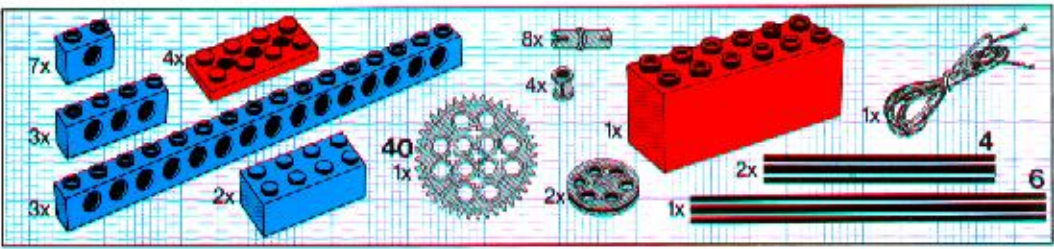

1

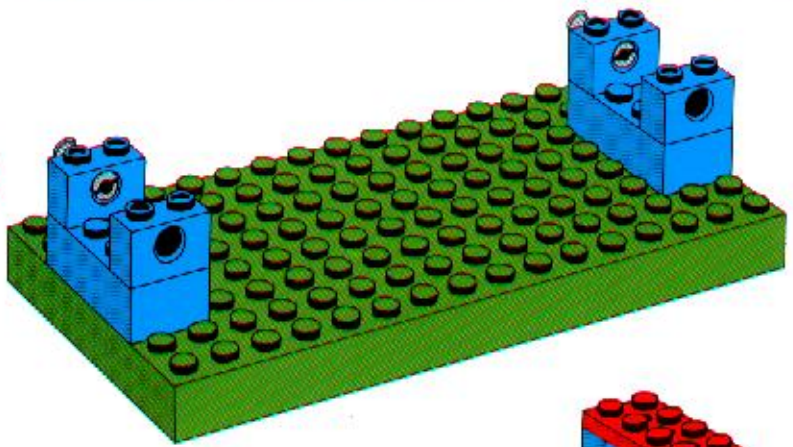

2

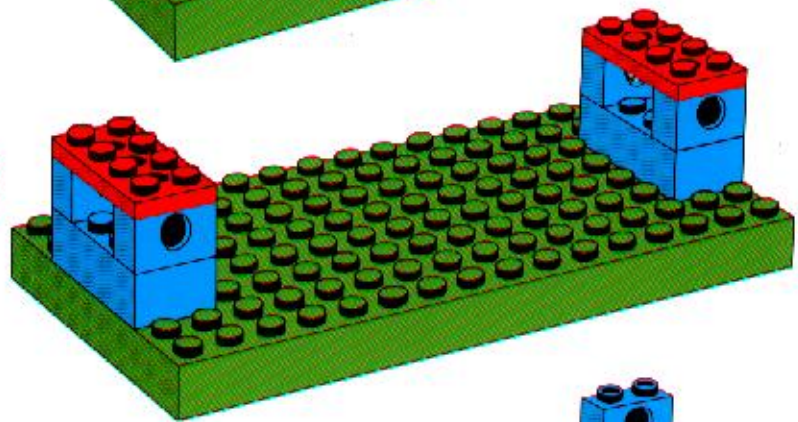

3

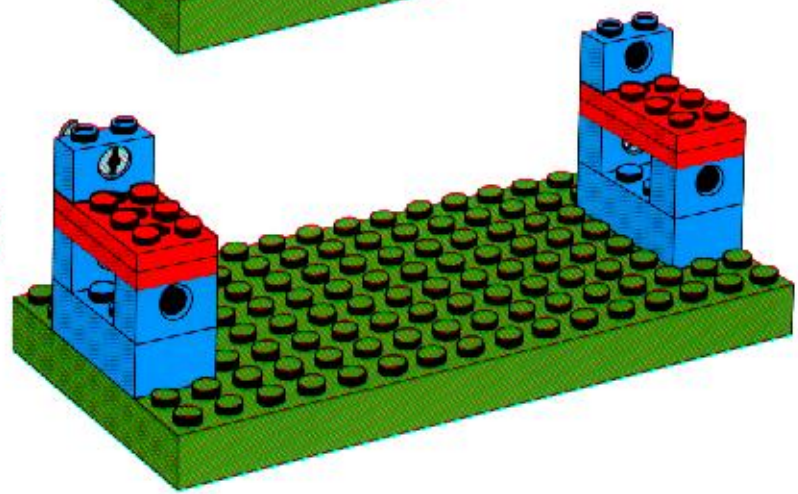

4

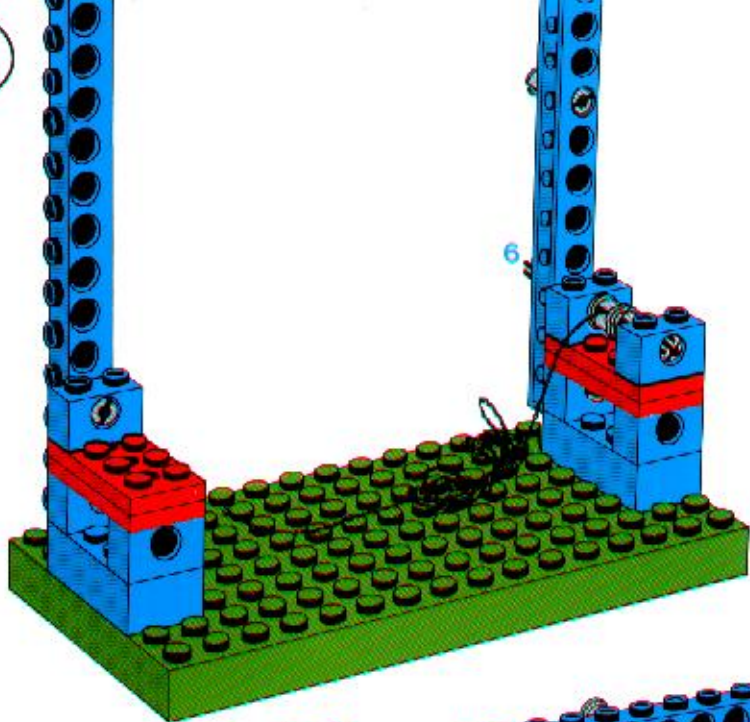

5

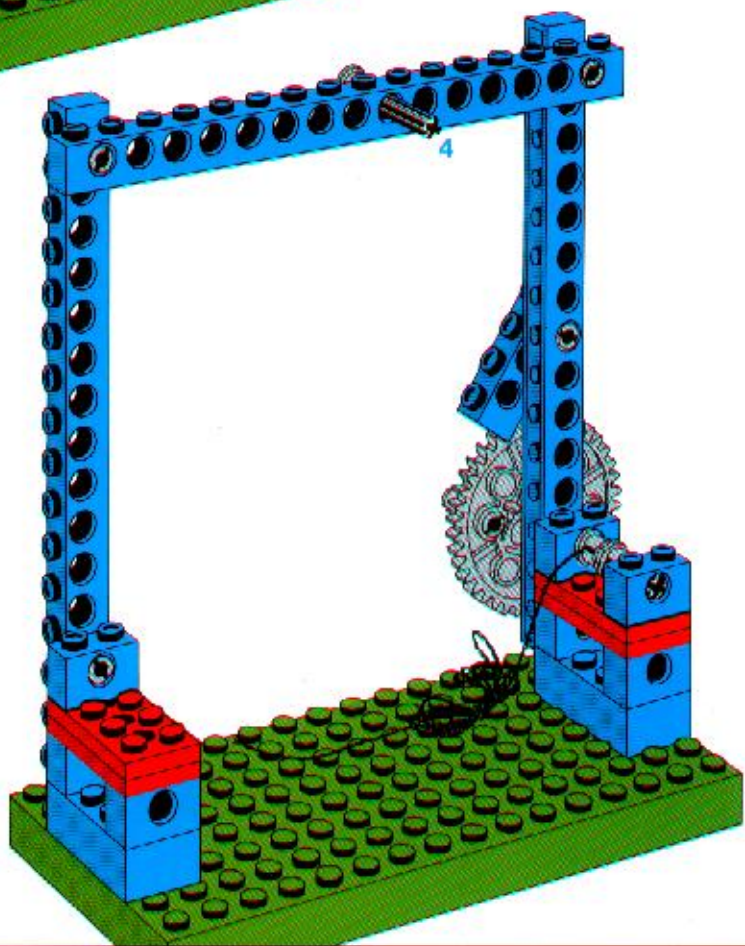

6

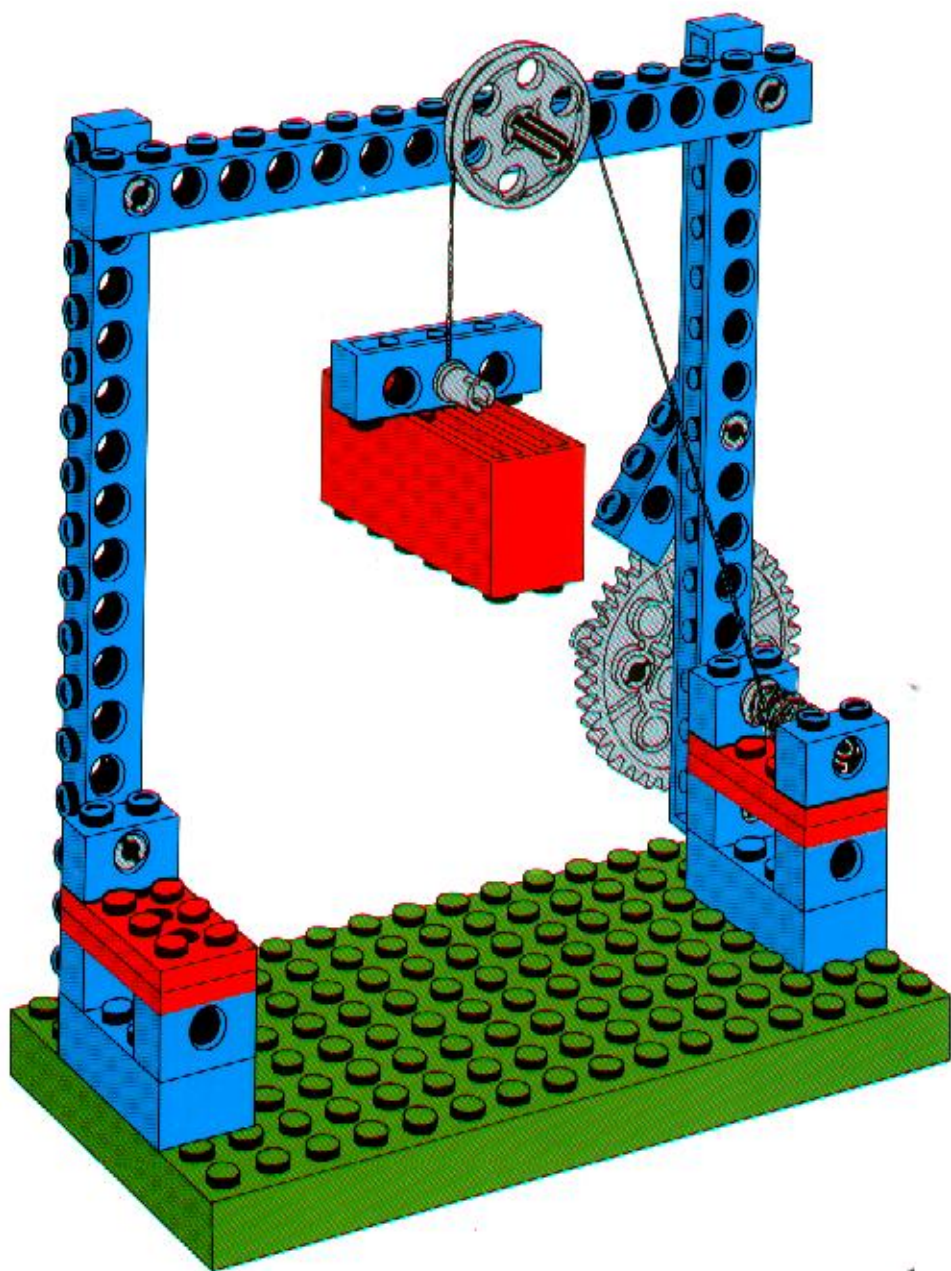

1

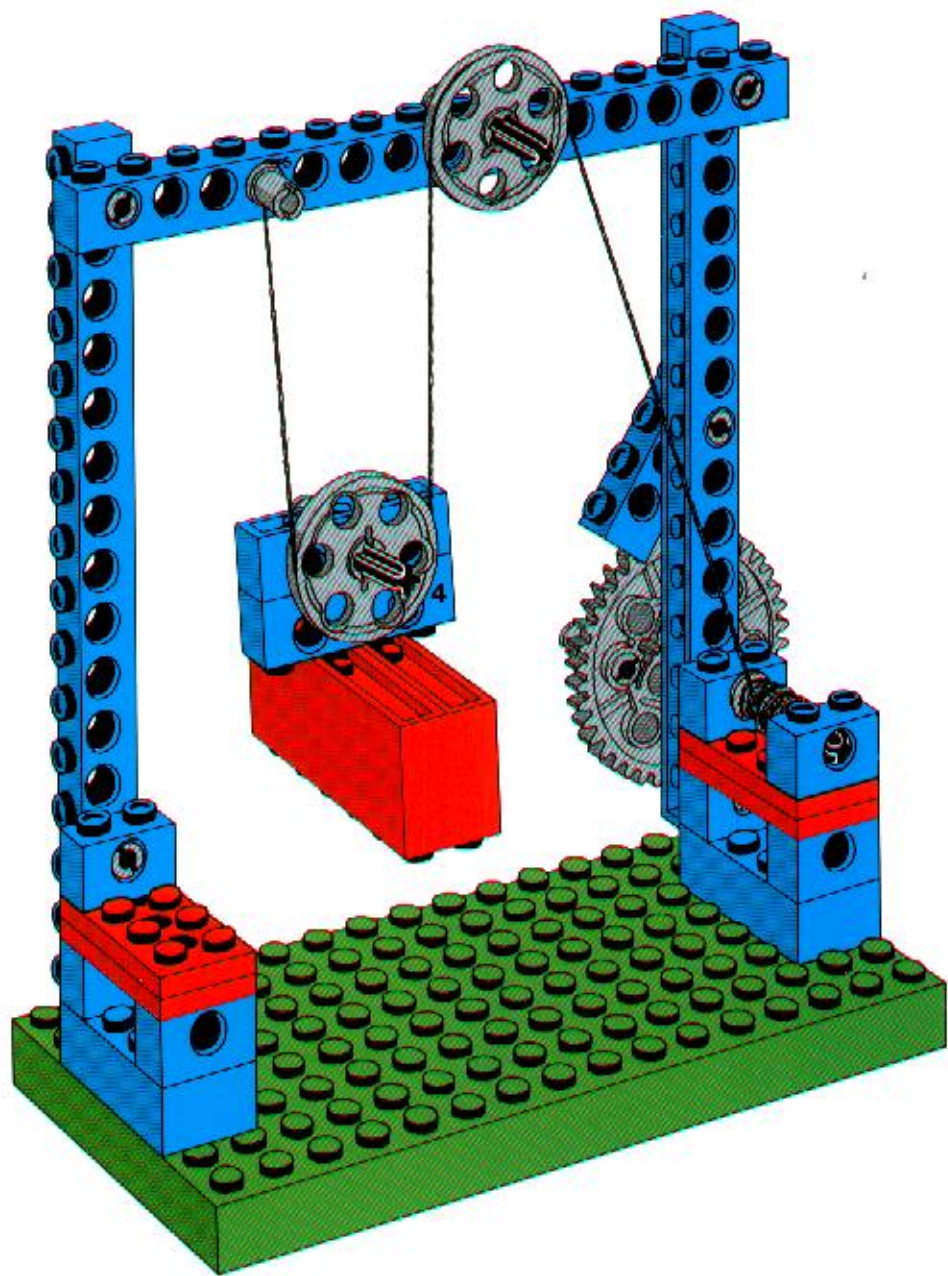

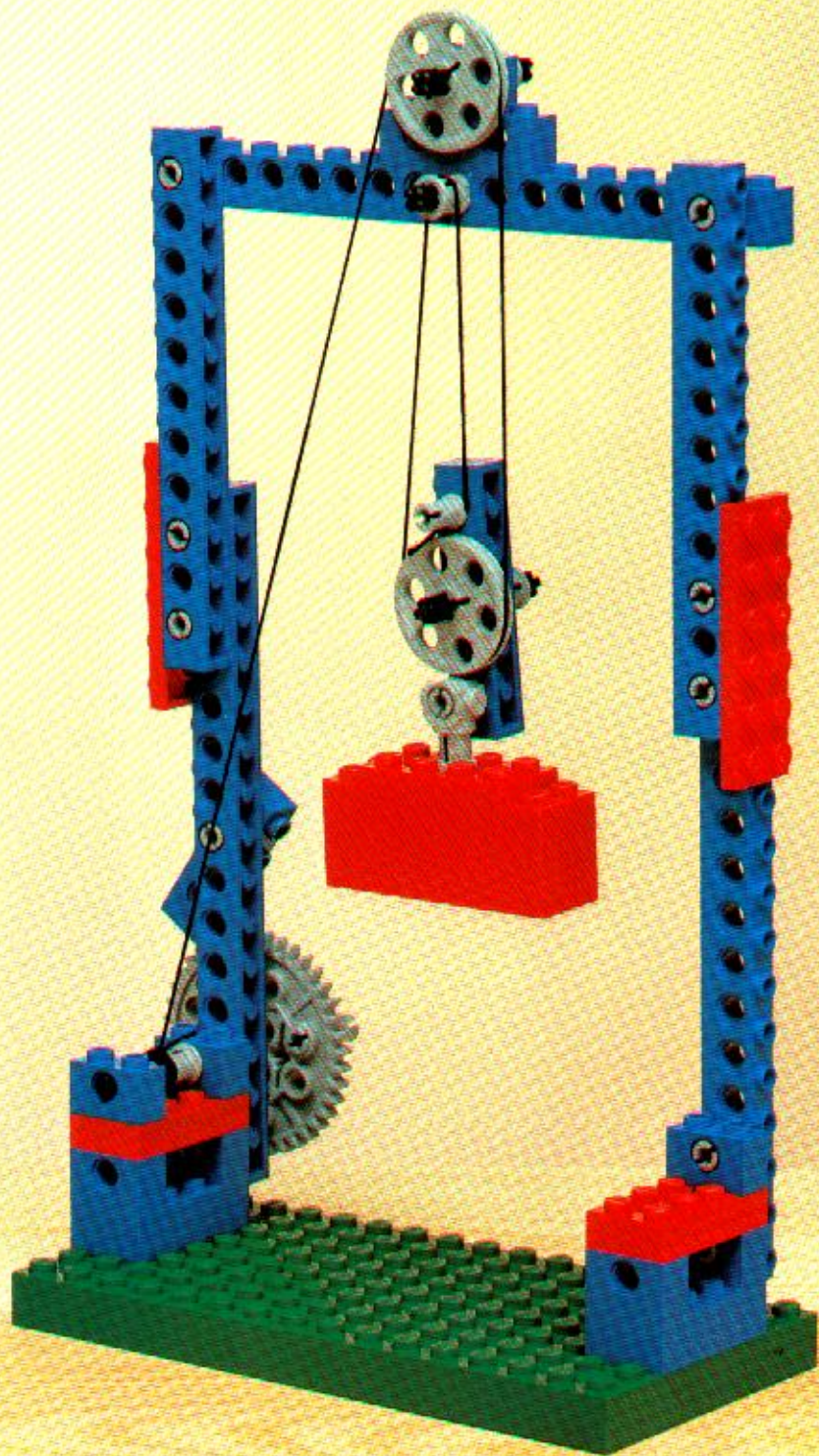



1031

17



2



3



LEGO dacta

Technic

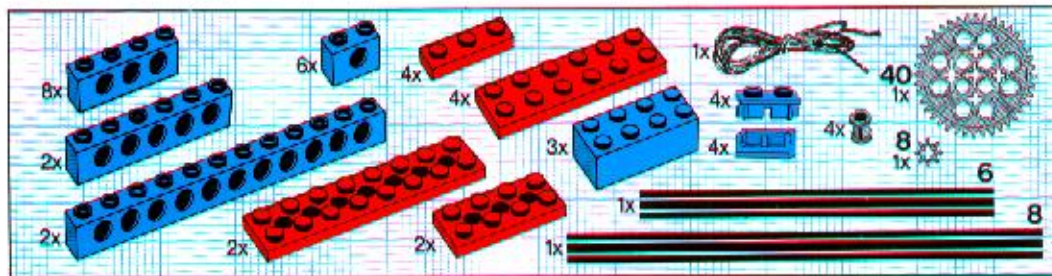

①

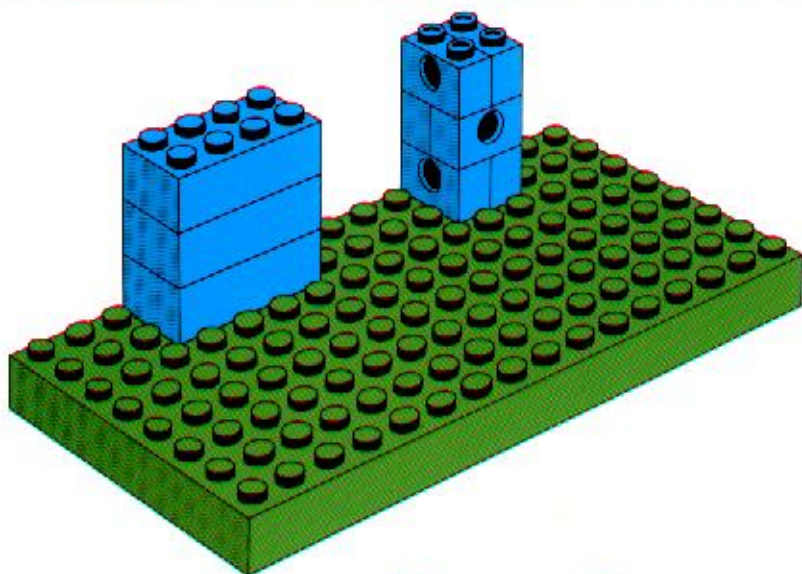

②

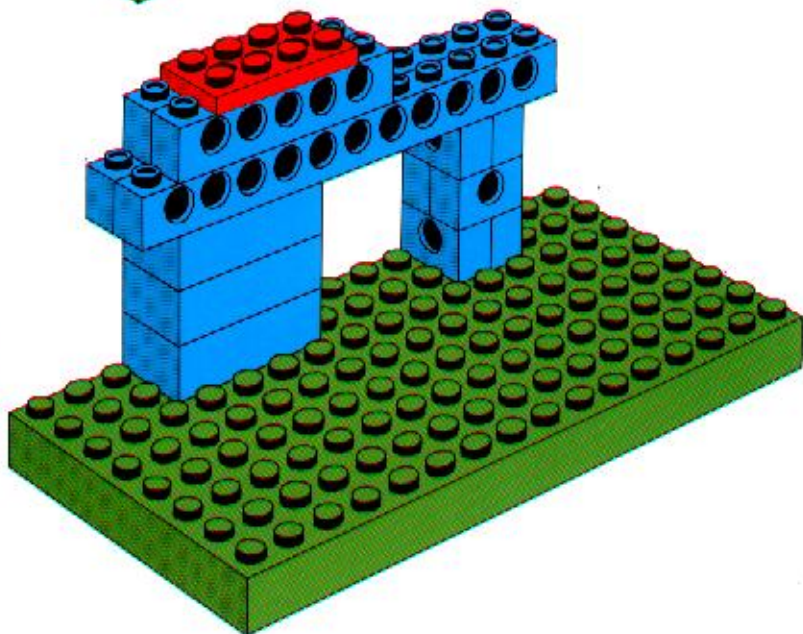

3

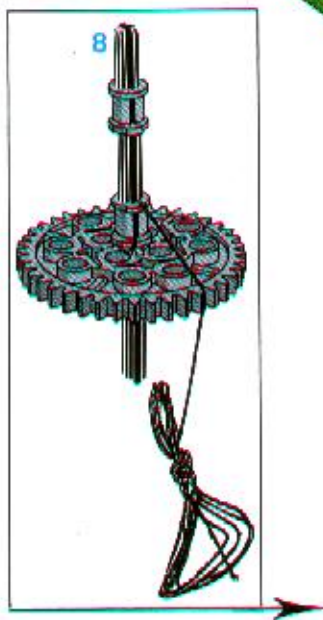
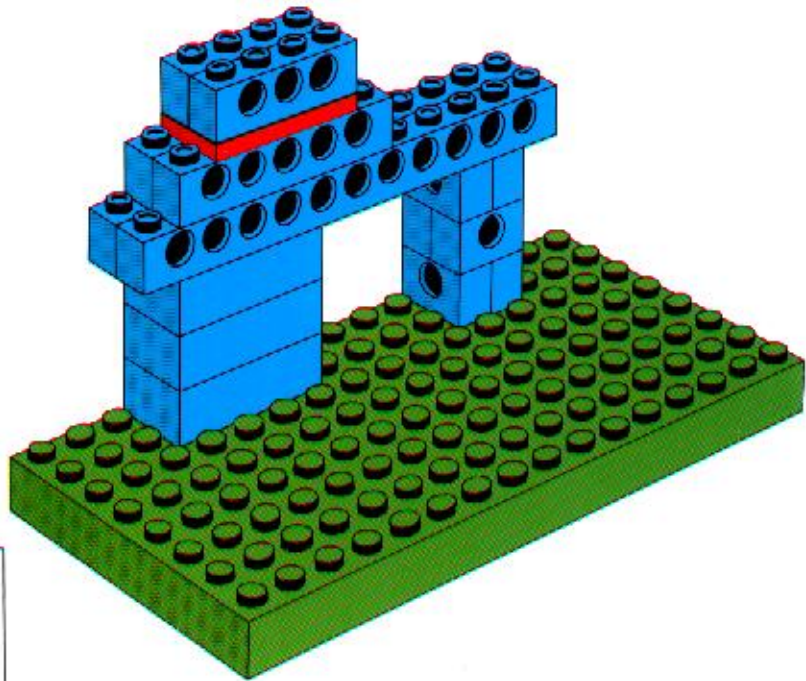

4

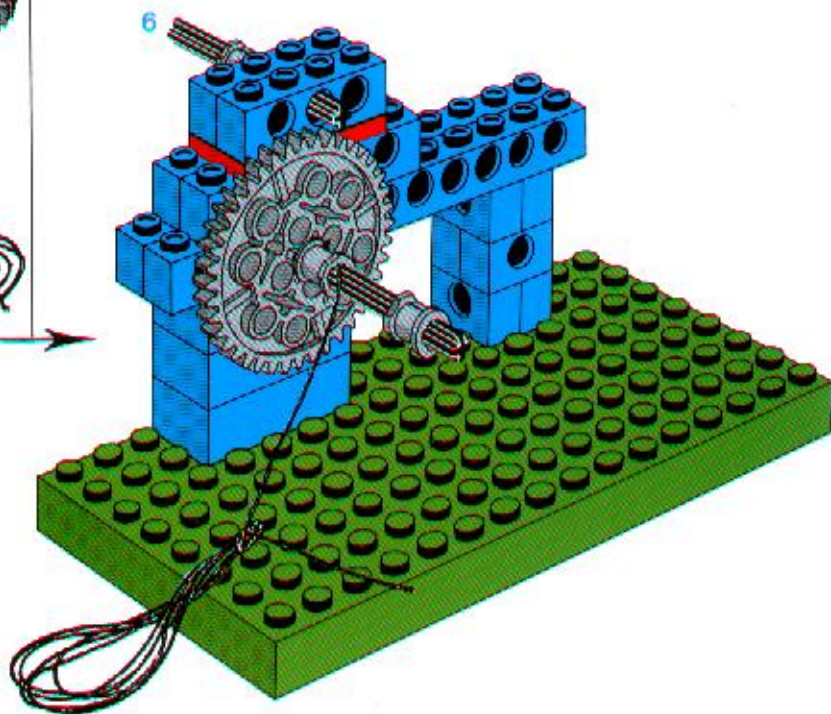

5

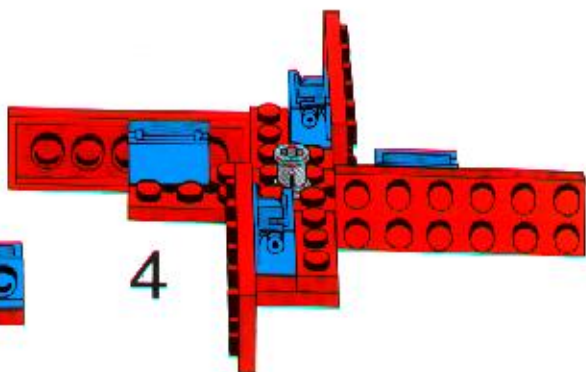
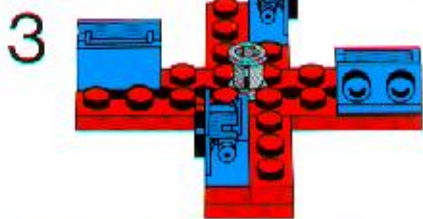
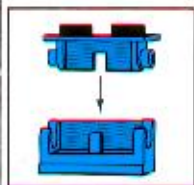
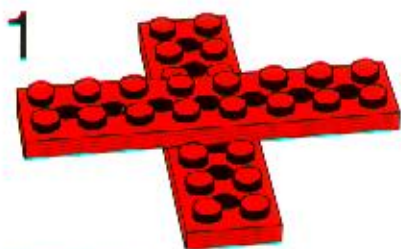
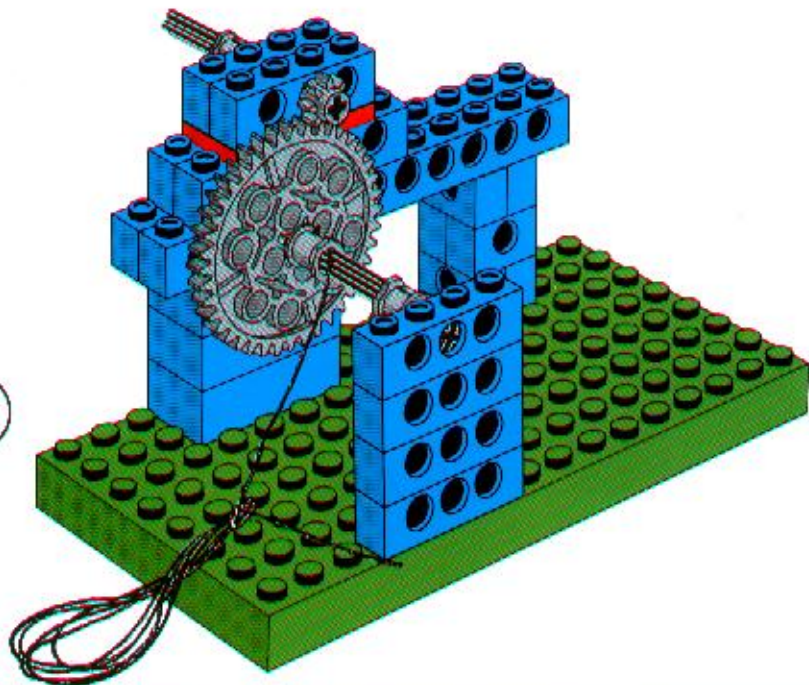

⑥

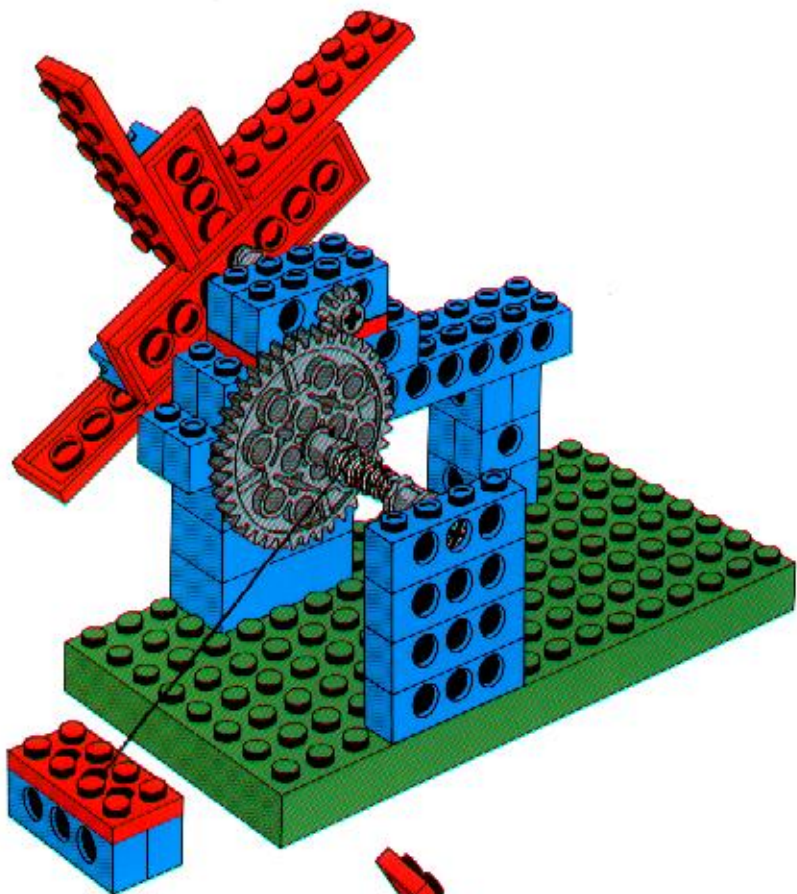

⑥

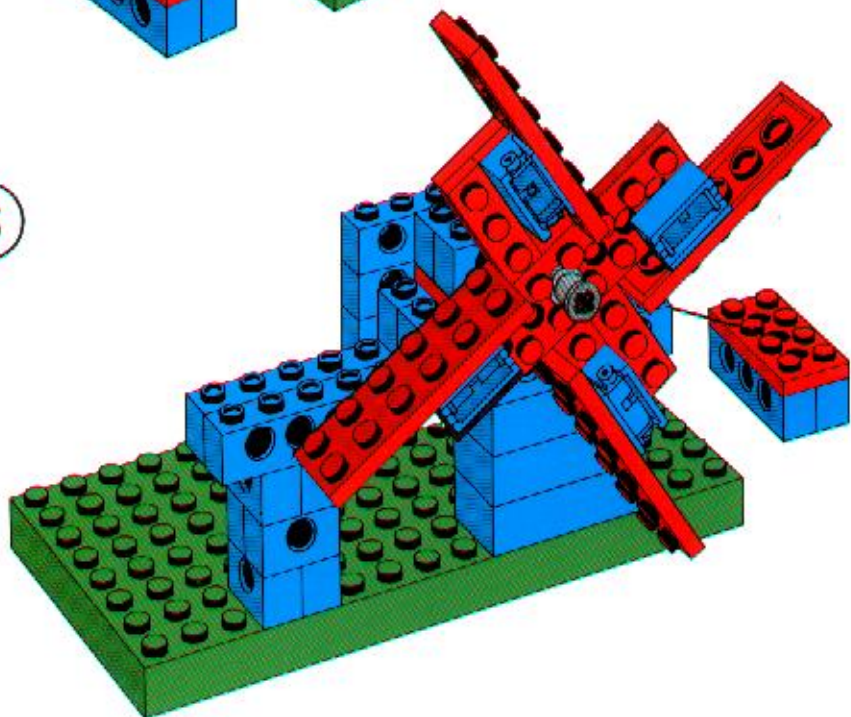

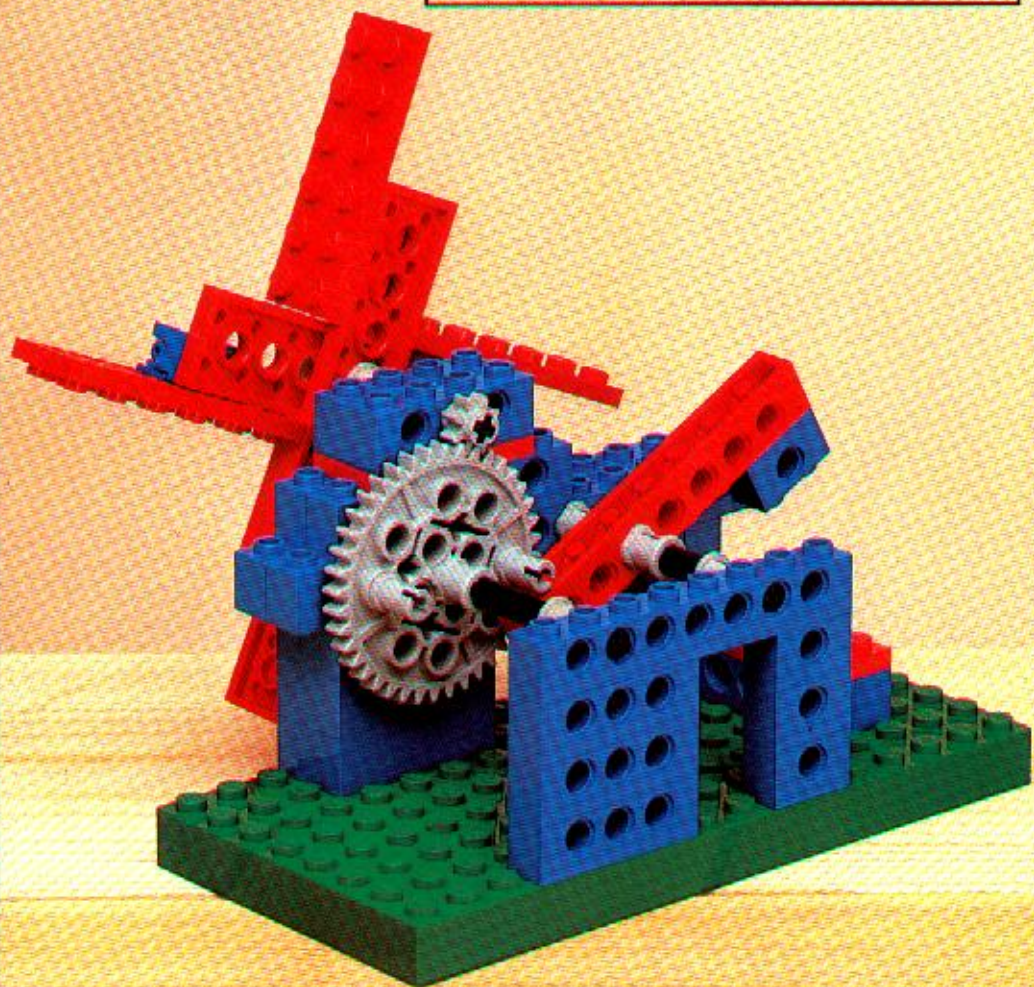
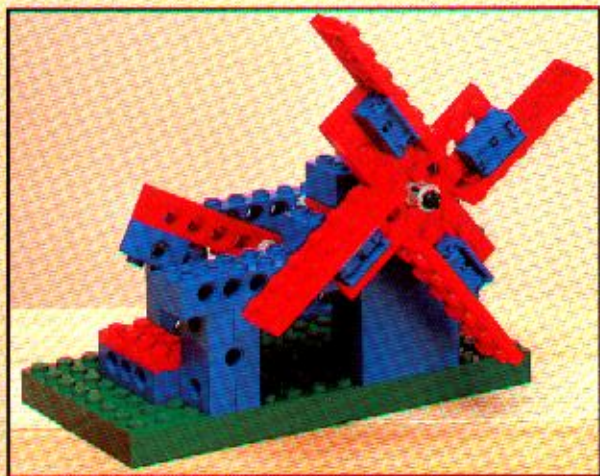



1031

18

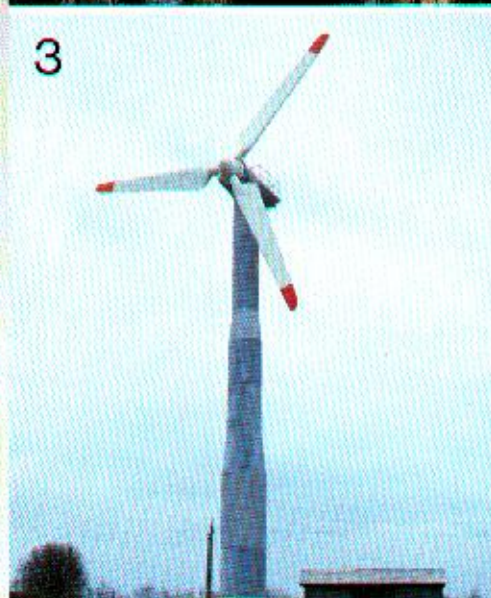
**dacta****Technic**

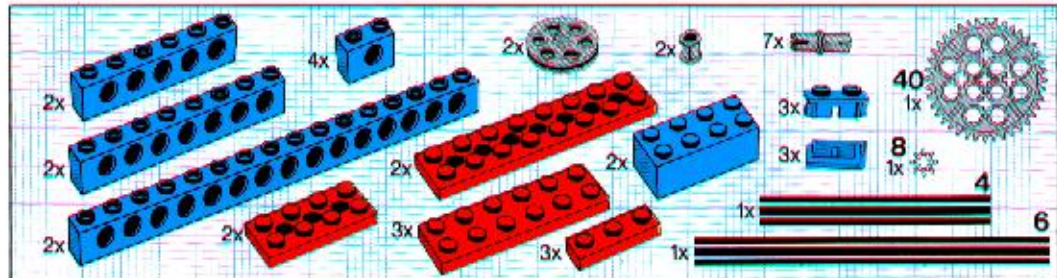

1

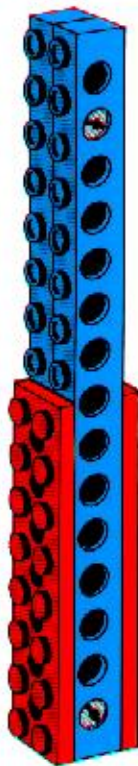

2

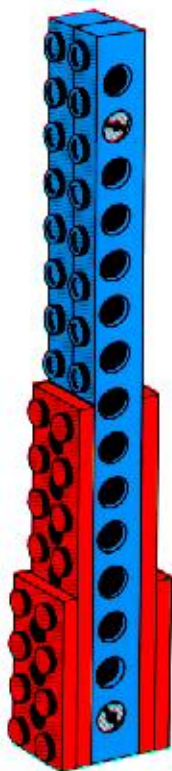

3

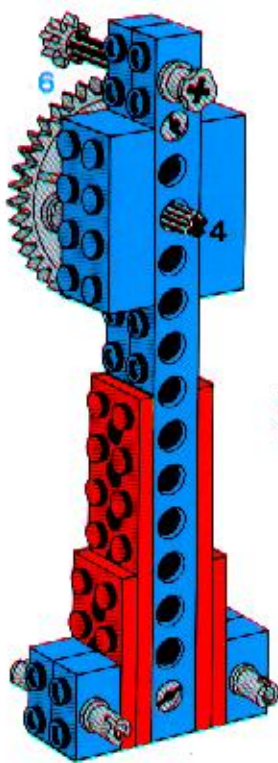

4

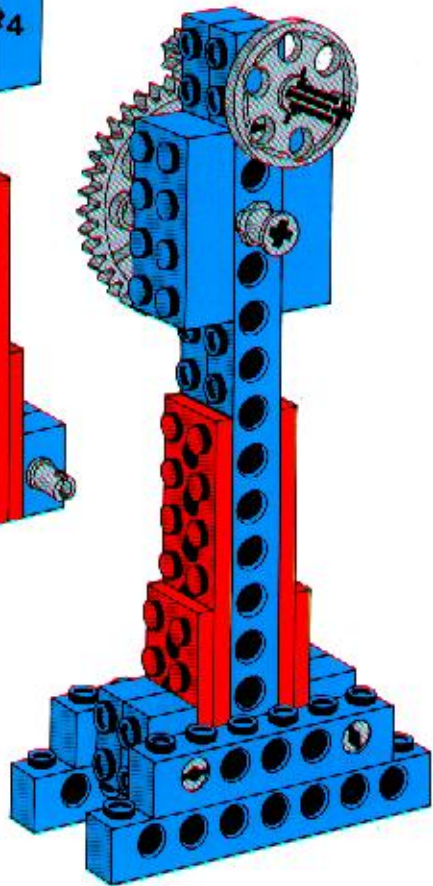

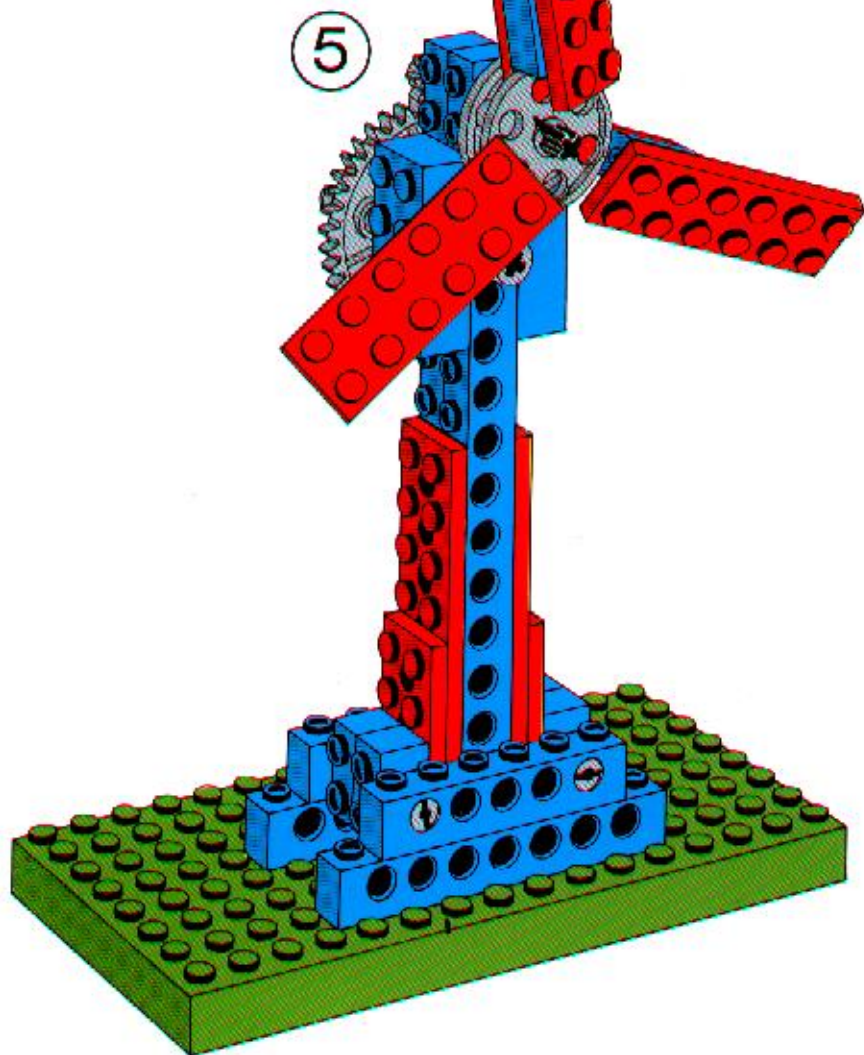
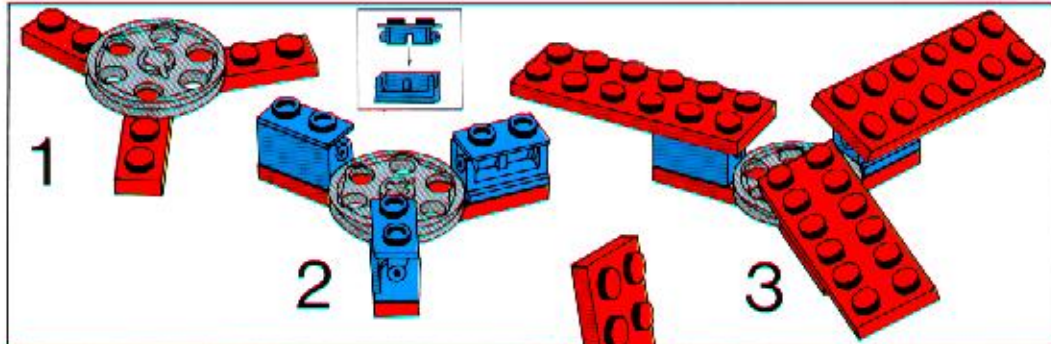

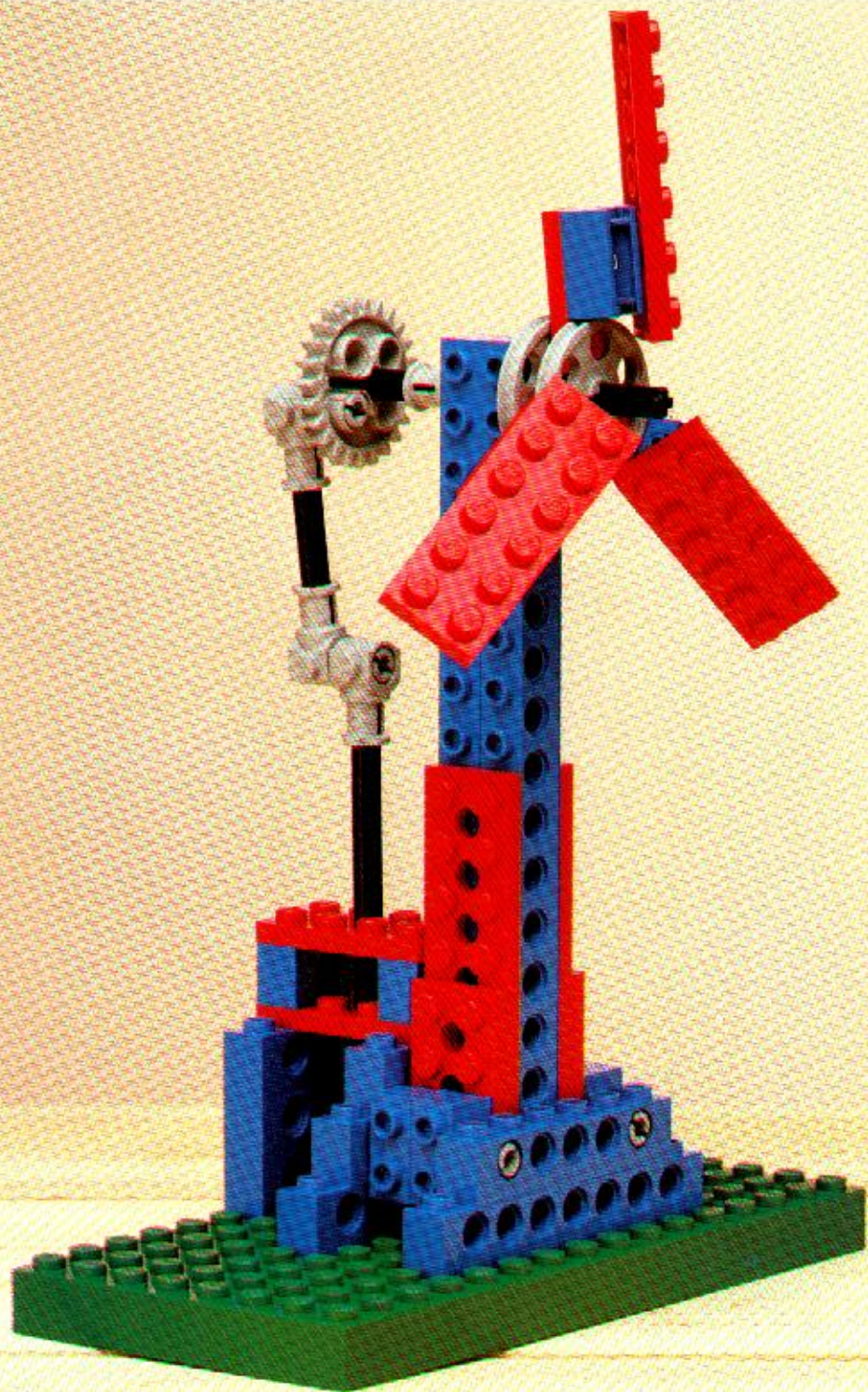



1031

19

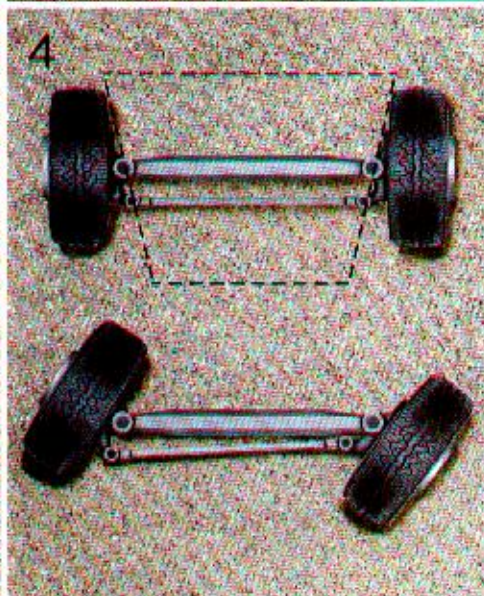
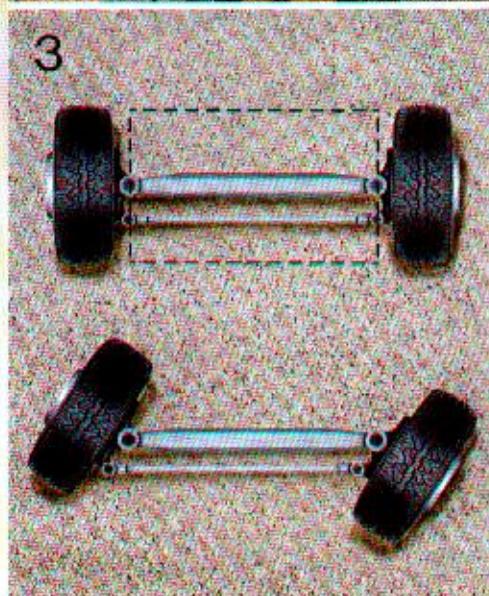

LEGO **dacta**

Technic

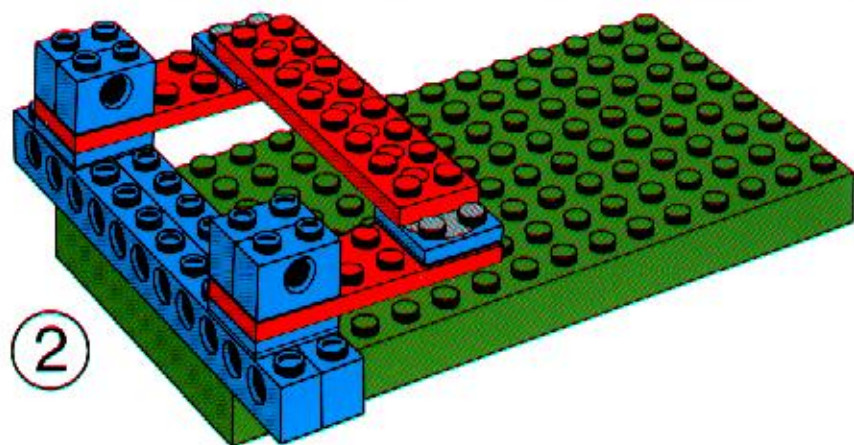
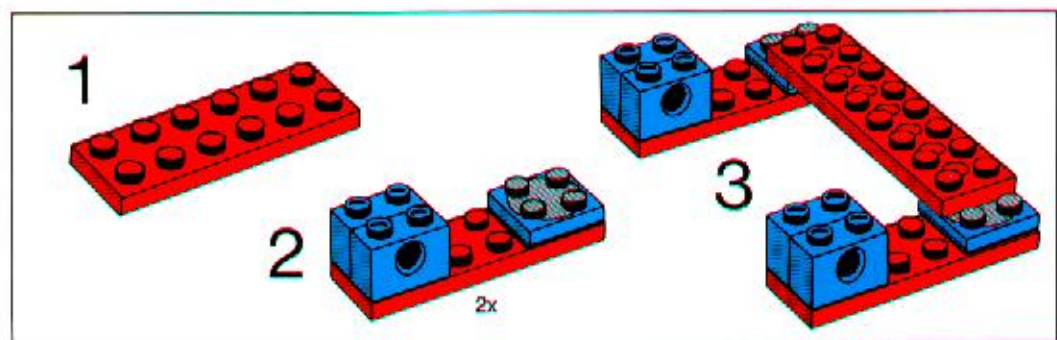
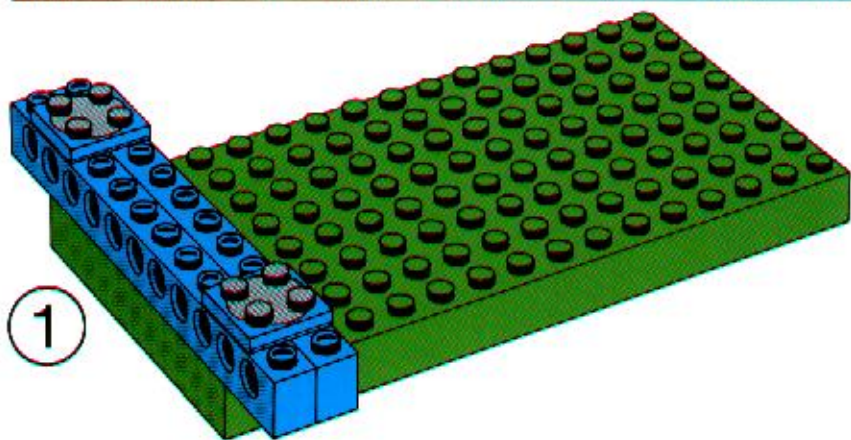
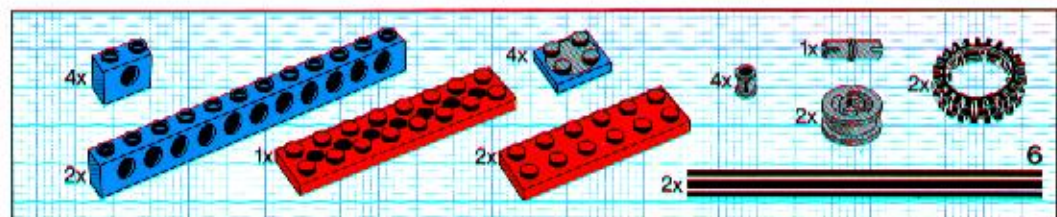

6

3

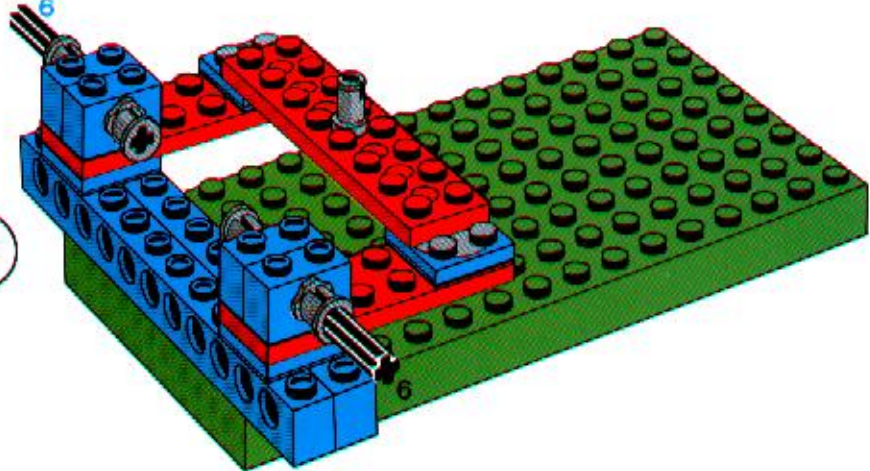

4

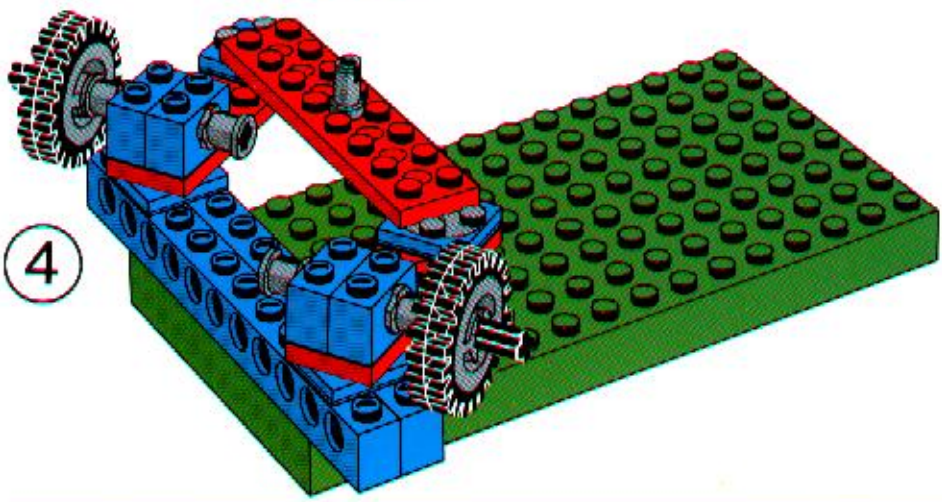

1

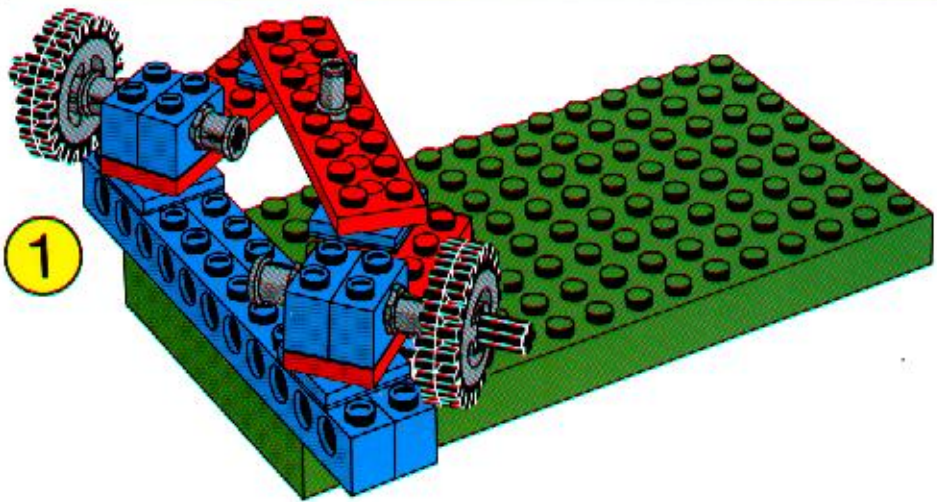

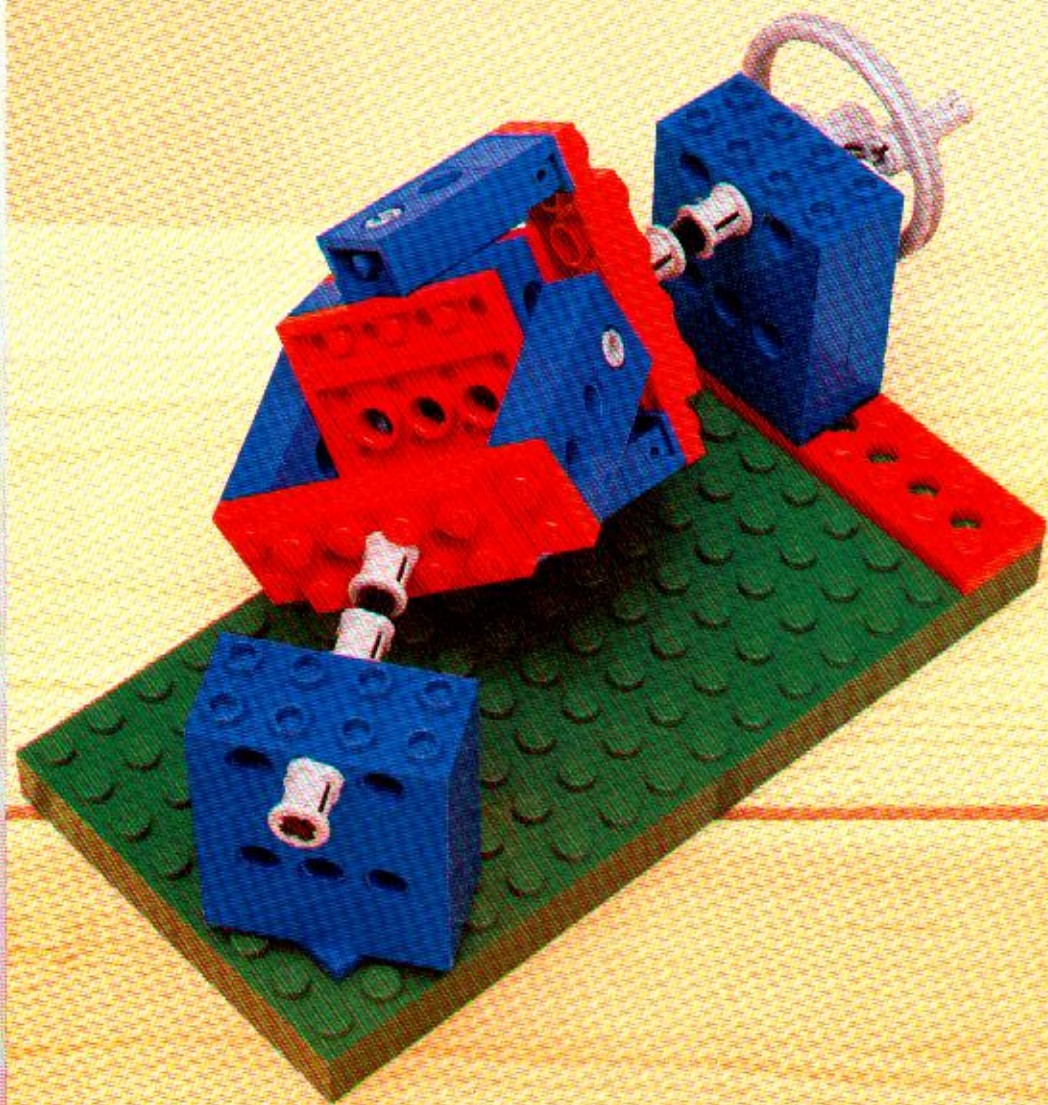



1031 20



2



LEGO dacta

Technic

