



Mixels™

SPUGG



41542



 LEGO.com

6126525

1



2

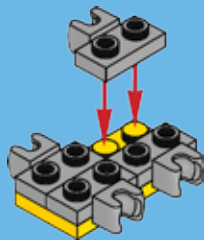

3

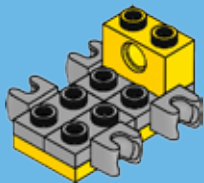

4

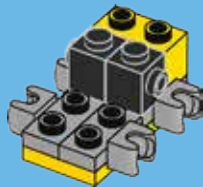

5

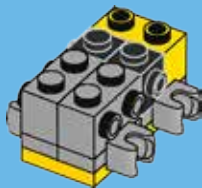

6

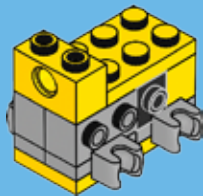

7

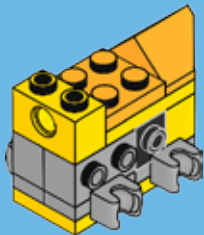

8

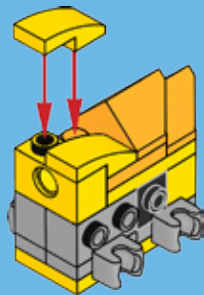

9

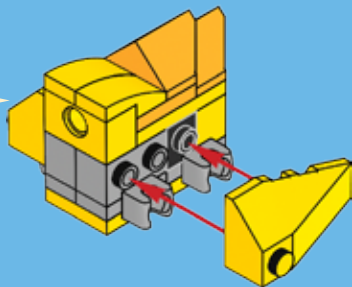
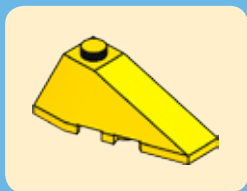

10

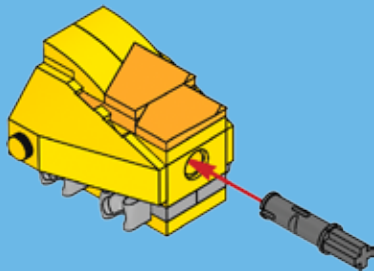

11

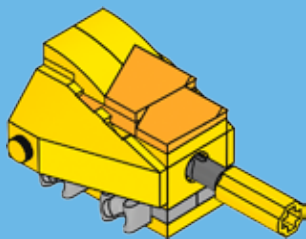

12

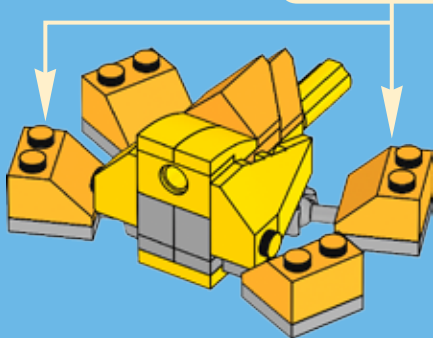
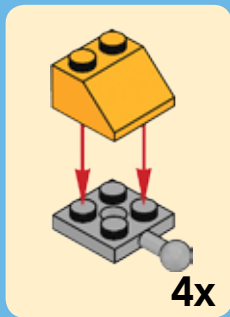

13

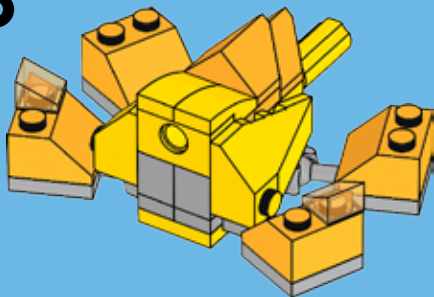

14

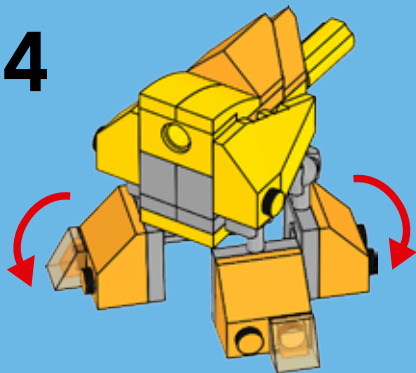



15



16



17



18



19



20



21



22



23



24

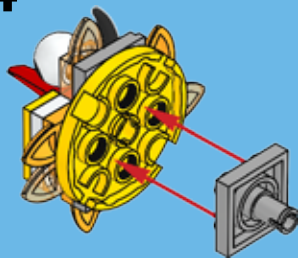

25

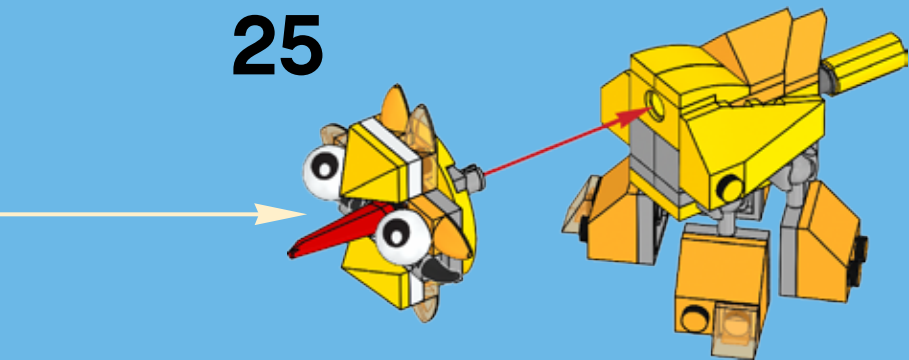

26

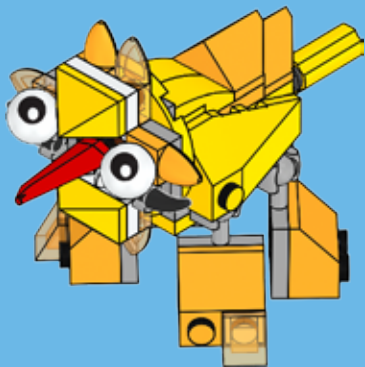

2x
6029947

2x
370024

1x
6015356

4x
6043656

3x
4282860

2x
6046381

2x
6075085

1x
302124

2x
4558954

2x
4598526

2x
6015238

2x
6056225

1x
4519010

1x
302024

2x
4568385

1x
4237084

4x
6020181

1x
4616842

1x
6056681

1x
4515349

2x
4244369

4x
6063611

1x
6003033

1x
6056679

1x
6102360

3x
6104016

2x
6015344

Customer Service

Kundenservice

Service Consommateurs

Servicio Al Consumidor

LEGO.com/service or dial





Mixels™

SERIES
5



**41536
GOX**



**41537
JINKY**



**41538
KAMZO**



**41539
KROG**



**41540
CHILBO**



**41541
SNOOF**



**41542
SPUGG**



**41543
TURG**



**41544
TUNGSTER**



LEGO.com/mixels





**SPUGG
41542**



**LIXERS
MAX!**



**TURG
41543**



**TUNGSTER
41544**



LEGO.com/mixels





LEGO.com/mixels





**YOU CAN
BUY THE
GAME!**

MIXELS RUSH

P2PSYDA1SY

IN GAME CODE!



Apple, the Apple logo, iPad, iPhone and iPod touch are trademarks of Apple Inc. Google Play is a trademark of Google Inc.

WIN

GO TO WWW.LEGO.COM/PRODUCTFEEDBACK AND
GIVE US YOUR SHORT **FEEDBACK** ABOUT THIS
LEGO® SET FOR A CHANCE TO WIN
A COOL LEGO PRIZE.

LEGO.com/productfeedback



GEWINNE



Erzähle uns auf
www.LEGO.com/productfeedback

etwas über die Erfahrungen, die
du mit diesem LEGO® Set gemacht
hast, und sichere dir die Chance auf
einen coolen LEGO Preis!

GAGNE



Rends-toi sur
www.LEGO.com/productfeedback

et donne-nous quelques commen-
taires sur ce produit LEGO® pour
avoir une chance de gagner un
prix LEGO !

GANA



Visita
www.LEGO.com/productfeedback

y envíanos tu opinión acerca de este
set LEGO®. ¡Participarás en el sorteo
de un premio LEGO!

获取奖品



登录
www.LEGO.com/productfeedback

给出关于此乐高®套装的简短反馈，
就有机会获得炫酷乐高奖品

LEGO, the LEGO logo and MIXELS are trademarks and/or copyrights of the LEGO Group.
©2015 The LEGO Group.
TM & © 2015 Cartoon Network

6126525