



CREATOR

31031



LEGO.com/creator

1



2



3



4





1x



1x

1

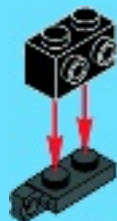

4x



2x

2

1



2



2x

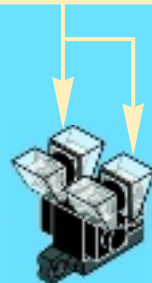



1x



2x

3

1



2

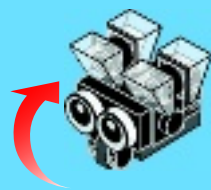
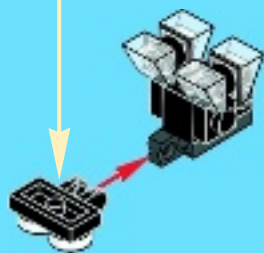



1x

1



1x

2

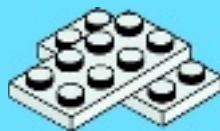



2x

3



2x

4





1x

5



2x

6





1x

7



1x

8

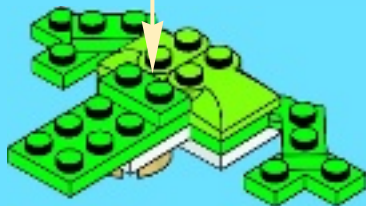



2x

9



1x

10





2x

11



1x

12



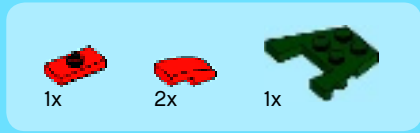

13





1x

14

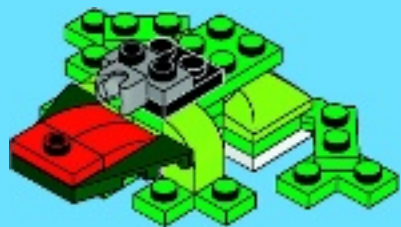

1x

15

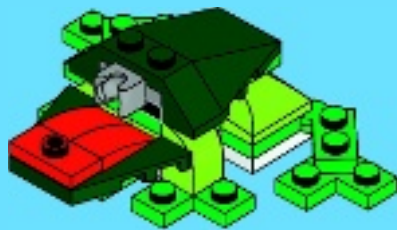



1x



2x



2x



2x



1x



1x

16

1



2



3



4



5







1x

1



1x

2





2x

3



2x



2x

4

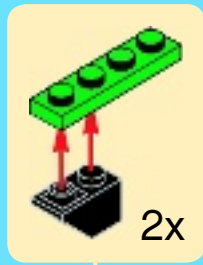

2x

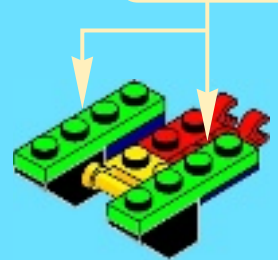



2x

5

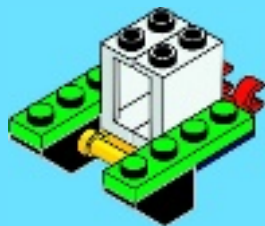

2x



2x

6

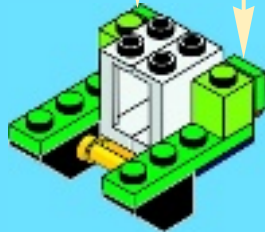
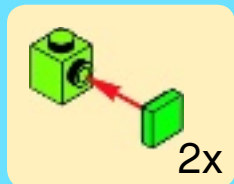



2x

7

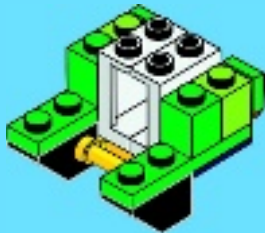

2x



2x

8

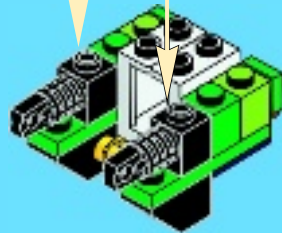
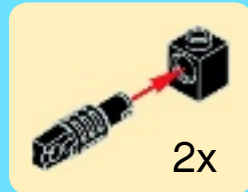



2x

9





1x



1x



1x

10

1



2





1x



2x

11



22



2x

12





1x



1x

13

1



2

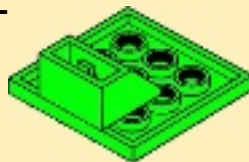



2x



1x

14





1x

15



2x

16





2x

17

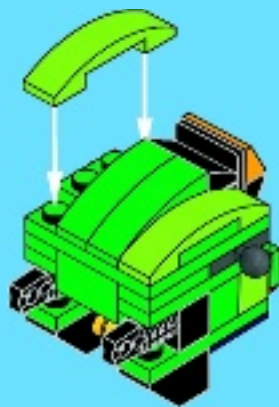



2x



4x



2x

18



2x

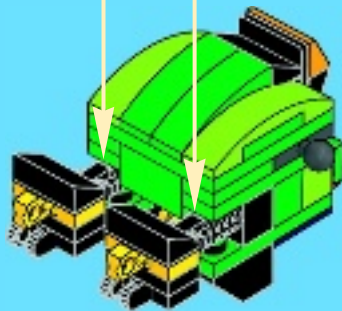



2x



4x

19

1



2



2x

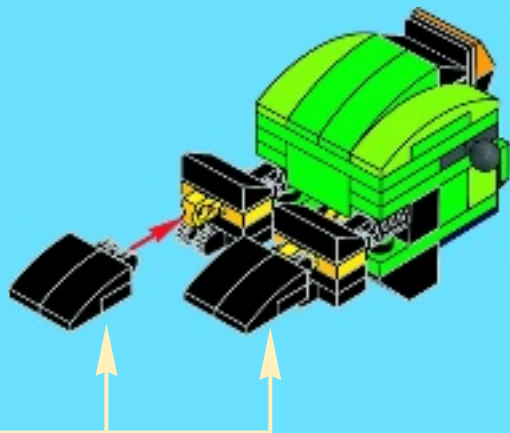



2x



2x



2x

20

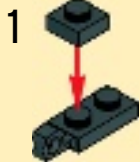

2



2x

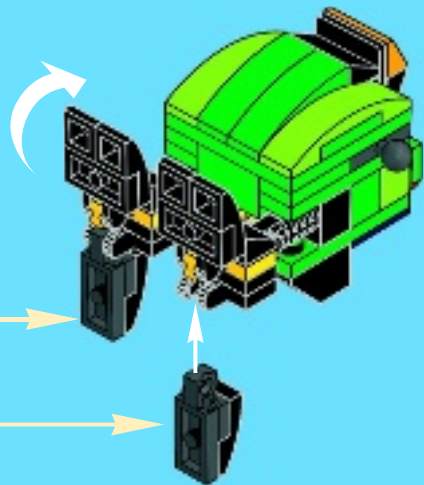



1x



1x

1

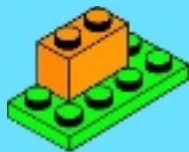

2x

2





1x

3



1x



2x

4





2x



2x

5

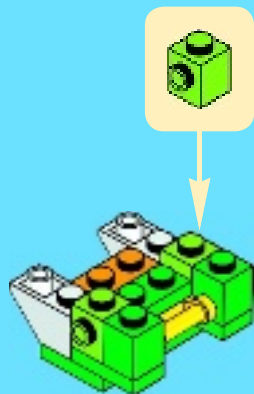

1x



2x

6

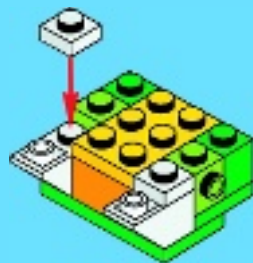



1x



1x

7



1x



1x

8

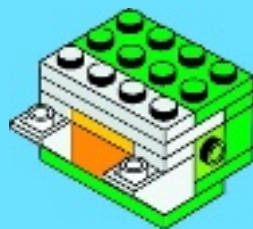



1x

9



2x

10





2x



2x

11

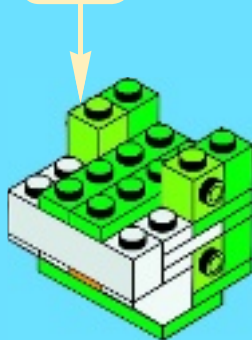

1x



1x

12

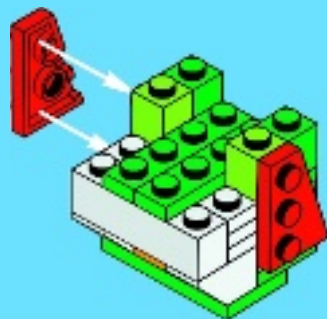



2x

13

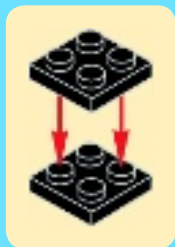

2x



2x

14

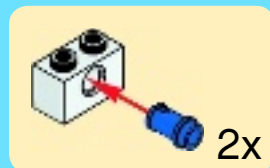



1x

15



1x

16

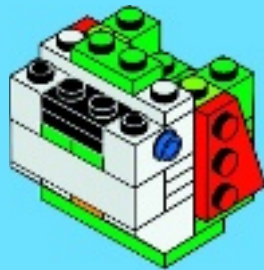



2x

17



38



2x

18

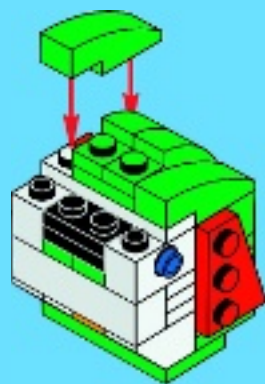



2x

19

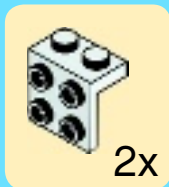

2x

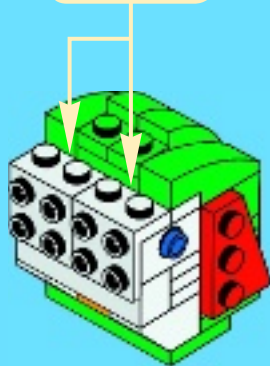

2x

20





1x



1x



1x



1x



1x

21

1

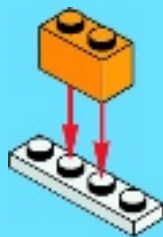

2



3



4

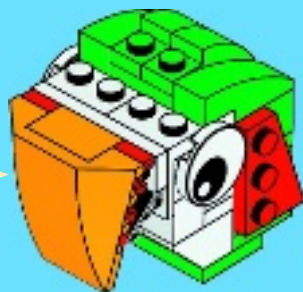



2x

22



1x

23

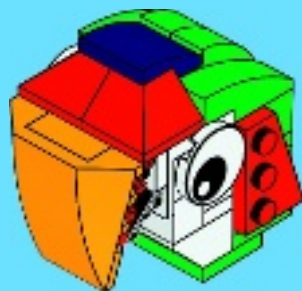

21

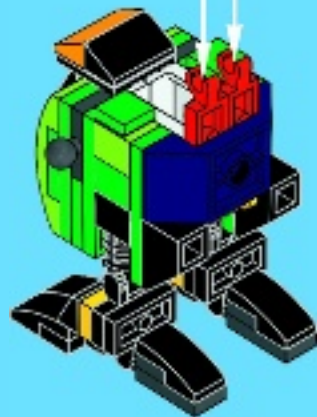
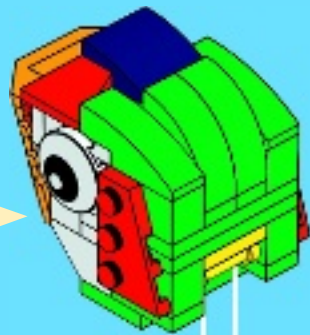



1x

1



1x

2





1x



1x

3



2x

4





1x

5



2x

6

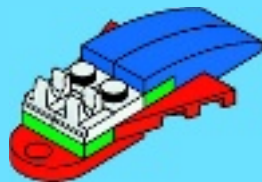



1x

7



22

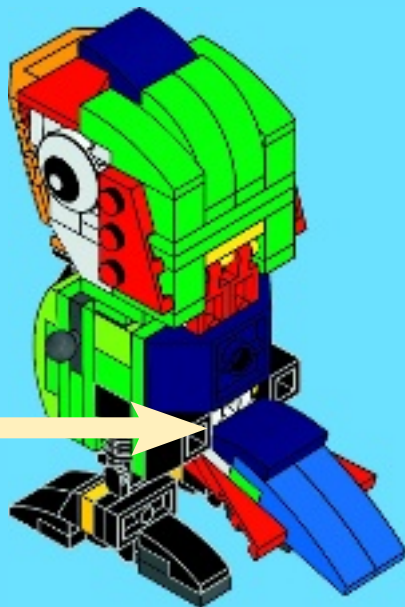



2x



1x



3x



1x



2x



1x

23

1

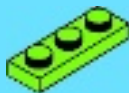

2



3



4



5



6

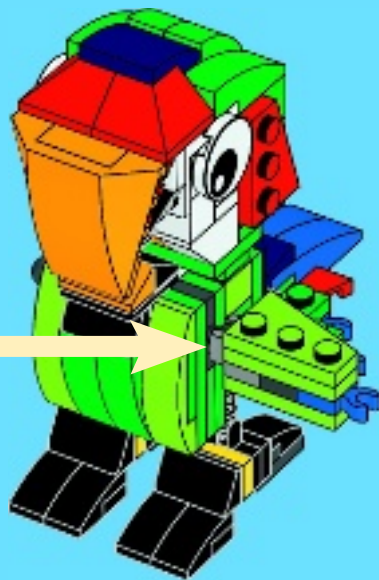



2x



1x



3x



1x



2x



1x

24

1



2



3



4



5



6



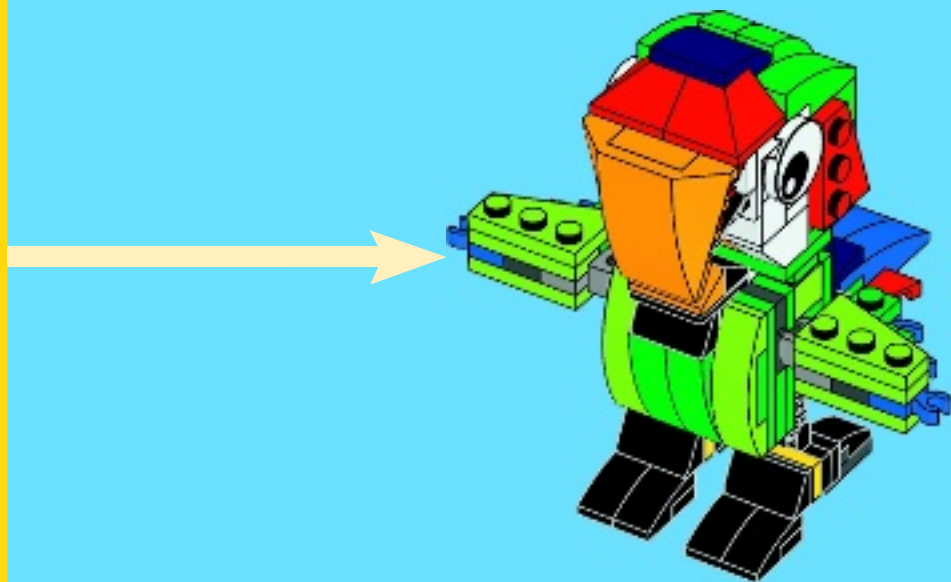

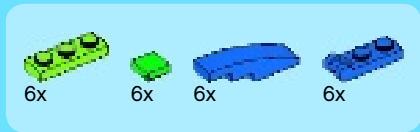
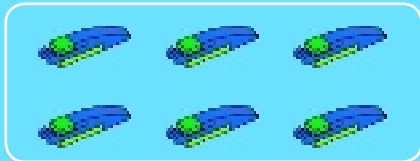

25

1



2

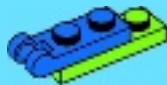

3

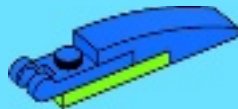

4

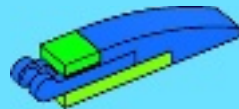

6x

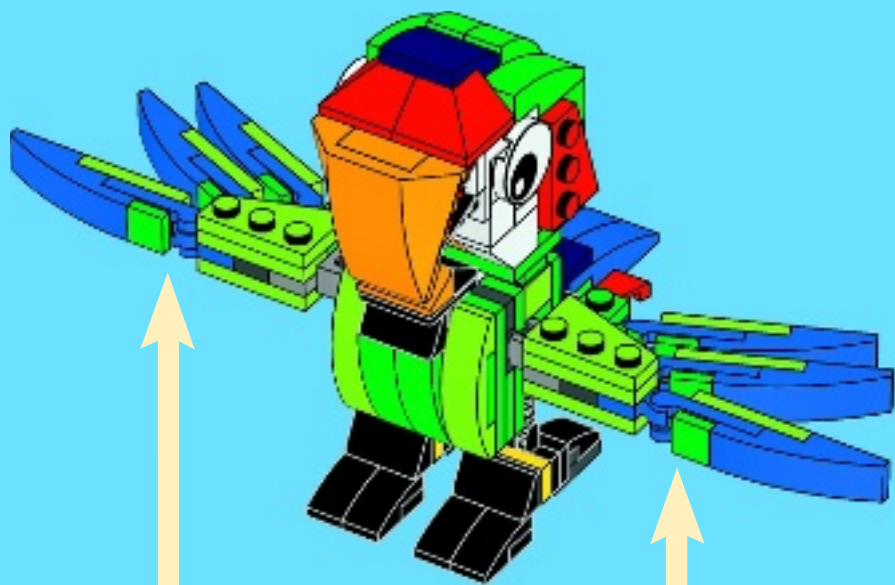



3x

26

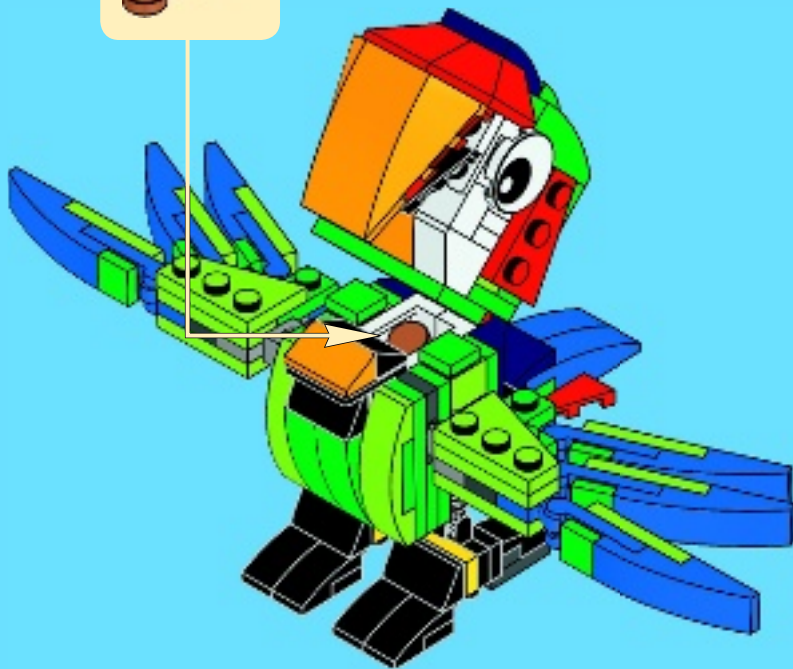

27



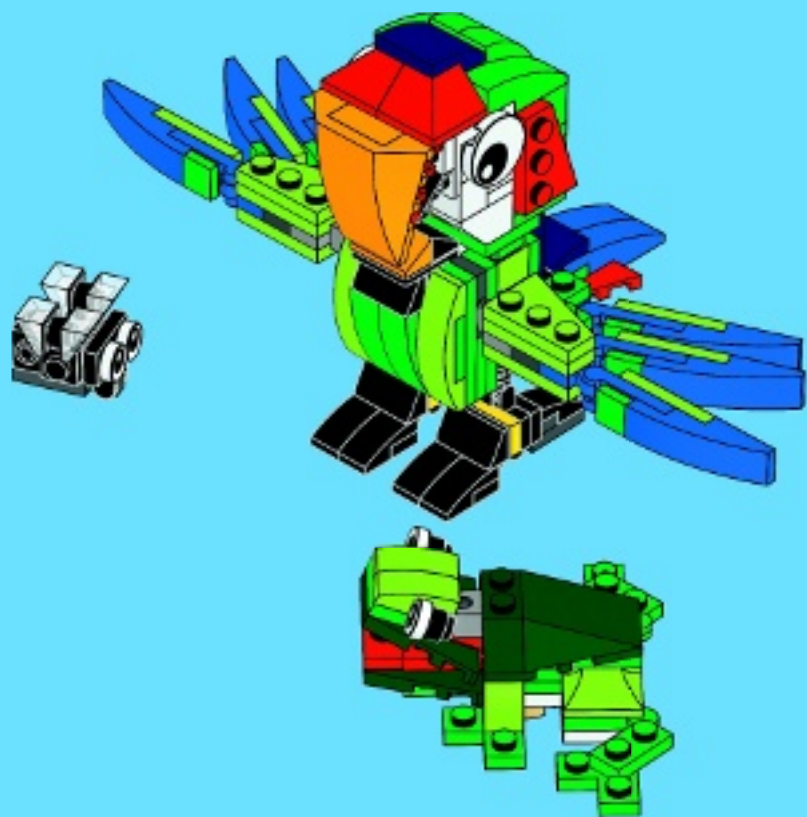



1x
301001



2x
370001



2x
366501



2x
302401



3x
371001



3x
302001



2x
6060734



2x
4598527



2x
4615649



4x
6029156



2x
4585458



1x
4140562



2x
4163087



2x
6029946



1x
6092565



2x
4534648



1x
4188189



2x
4180504



2x
4180533



1x
4649048



8x
6045938



6x
4613257



6x
6073890



2x
4143005



1x
302124



4x
4185617



2x
4501232



1x
4253815



2x
654126



4x
4548180



2x
366526



6x
6047276



4x
302226



4x
4632571



8x
4515340



1x
6000650



1x
4531412



2x
4159335



6x
300528



1x
4142717



2x
4644085



4x
6039946



8x
4558593



11x
302328



10x
4157120



7x
371028



4x
302028



1x
4243821



2x
6102767



4x
4244362



6x
6073026



2x
6069006



2x
4212446



2x
4617069



10x
4210210



1x
4539907



1x
4539908



2x
6025028



1x
4261784



2x
6061569



4x
4210719



3x
6039479



3x
4210883



1x
6101853



2x
4649051



3x
6055383



3x
6043656



2x
6003003



1x
6024286



1x
6020141

Customer Service

Kundenservice

Service Consommateurs

Servicio Al Consumidor

LEGO.com/service or dial



: 00800 5346 5555

: 1-800-422-5346

WIN

GO TO WWW.LEGO.COM/PRODUCTFEEDBACK AND
GIVE US YOUR SHORT **FEEDBACK** ABOUT THIS
LEGO® SET FOR A CHANCE TO WIN
A COOL LEGO PRIZE.



LEGO.com/productfeedback

GEWINNE



Erzähle uns auf
www.LEGO.com/productfeedback

etwas über die Erfahrungen, die du mit
diesem LEGO® Set gemacht hast, und
sichere dir die Chance auf einen coolen
LEGO Preis!

GAGNE



Rends-toi sur
www.LEGO.com/productfeedback

et donne-nous quelques commentaires
sur ce produit LEGO® pour avoir une
chance de gagner un prix LEGO !

GANAN



Visita
www.LEGO.com/productfeedback

y envíanos tu opinión acerca de este set
LEGO®. ¡Participarás en el sorteo de un
premio LEGO!

获取奖品



登录
www.LEGO.com/productfeedback

给出关于此乐高®套装的简短反馈，
就有机会获得炫酷乐高高奖品

LEGO and the LEGO logo are trademarks of the/son des marques de commerce du/son marcas registradas de LEGO Group. ©2015 The LEGO Group.

6129369 / 6129372



CREATOR

31031



LEGO.com/creator



1x

1

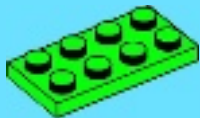

2



2x

2

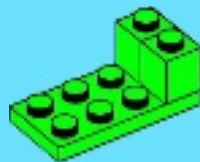



2x



2x

3

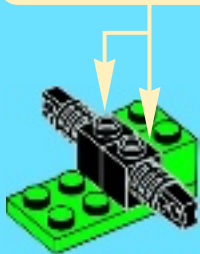
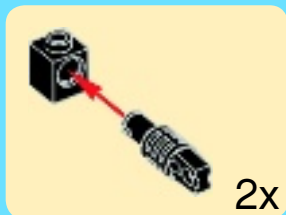

2x

4

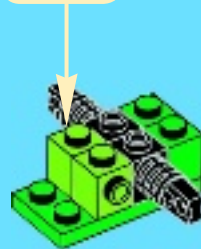



2x

5

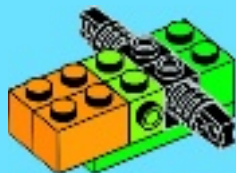

1x

6

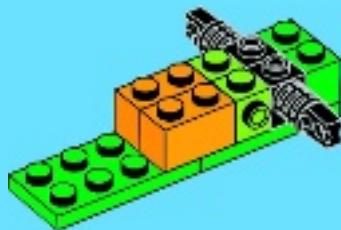



2x

7

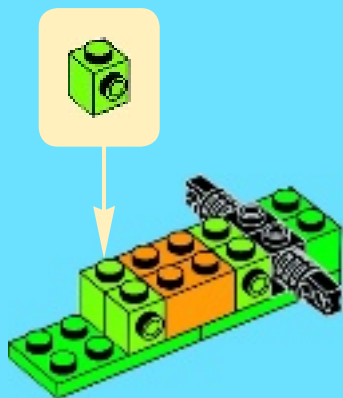

1x



1x

8

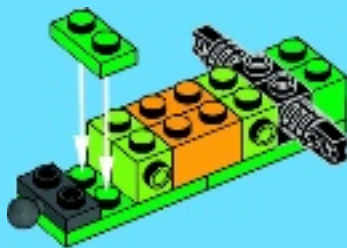



2x

9

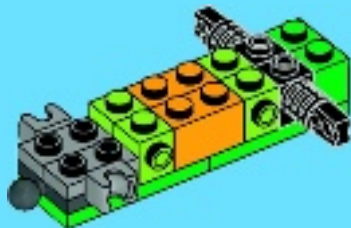

1x

10

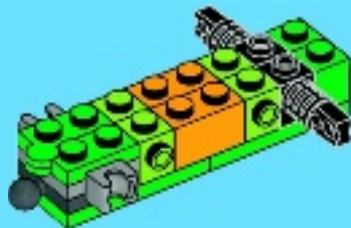



2x



2x

11

1



2



2x

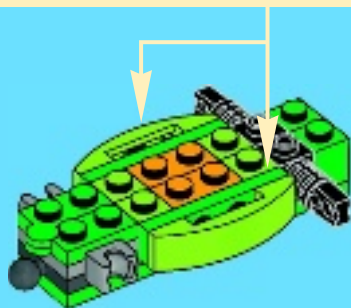

2x



1x

12





1x



1x

13



1x

14





1x



1x



1x

15



1x



1x



1x

16

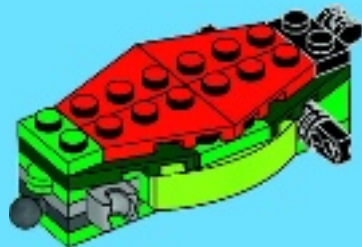



1x



2x

17

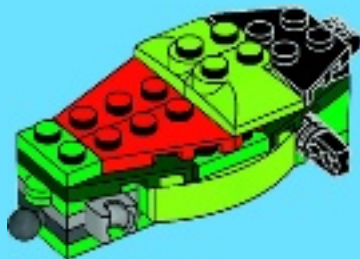



1x



1x

18

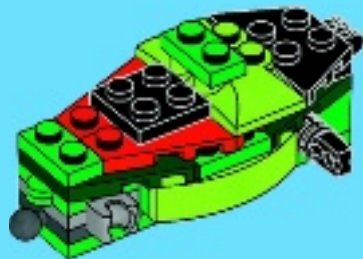

1x

19





2x

20

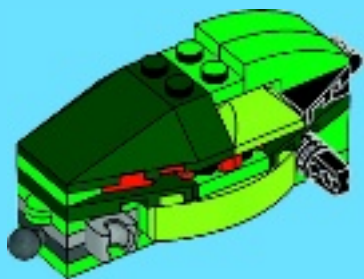

2x

21

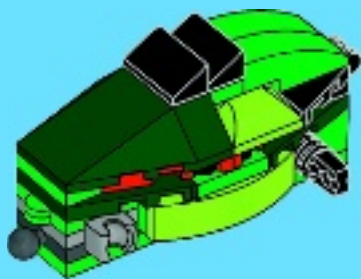



1x



1x

1

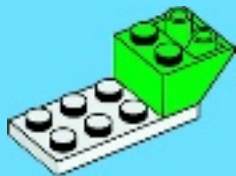

2x

2





2x

3

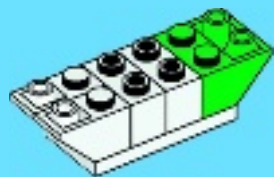

2x

4

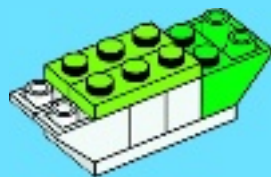



2x



1x

5



22

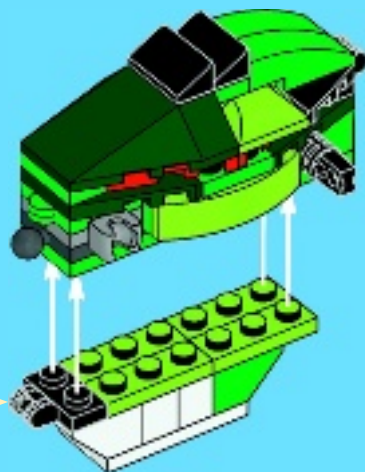



1x



3x



2x



1x

23

1



2

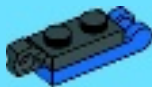

3

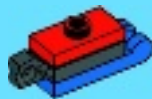

4

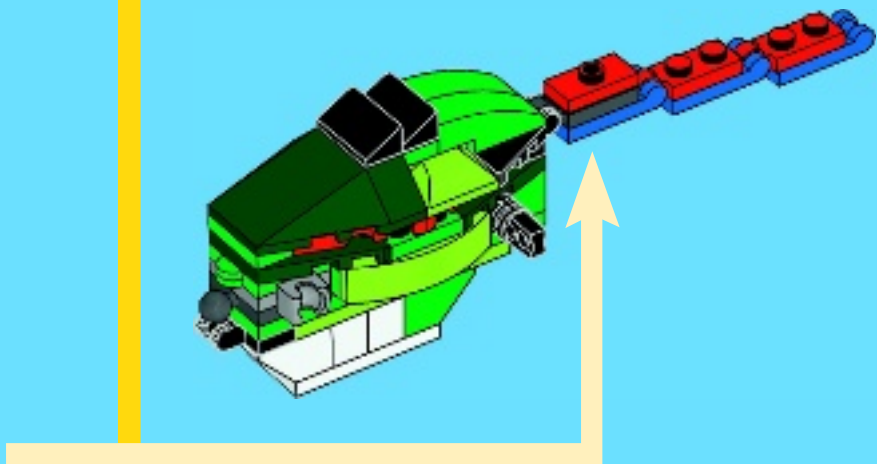
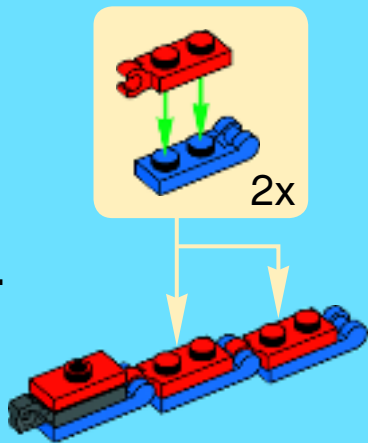



1x



1x



1x



2x



1x

24

1

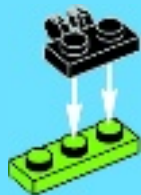

2



3

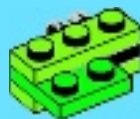

4



5





1x



1x



1x



1x



1x

25

1



2

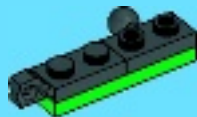

3

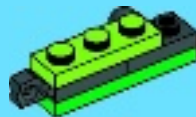

4

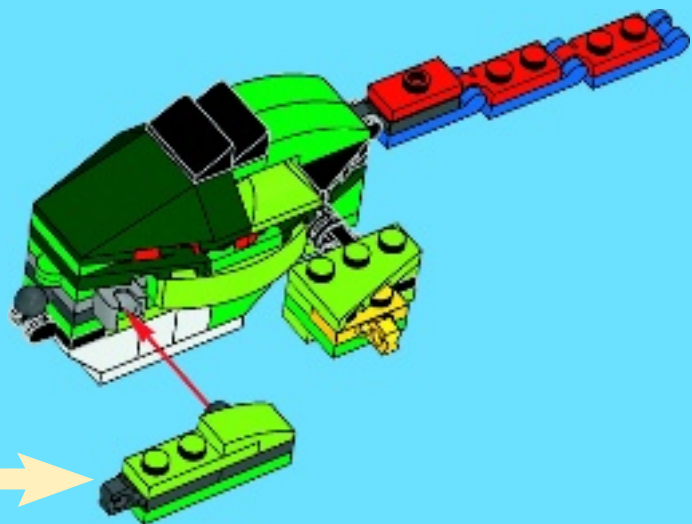
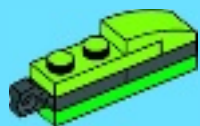



4x



2x



2x



26

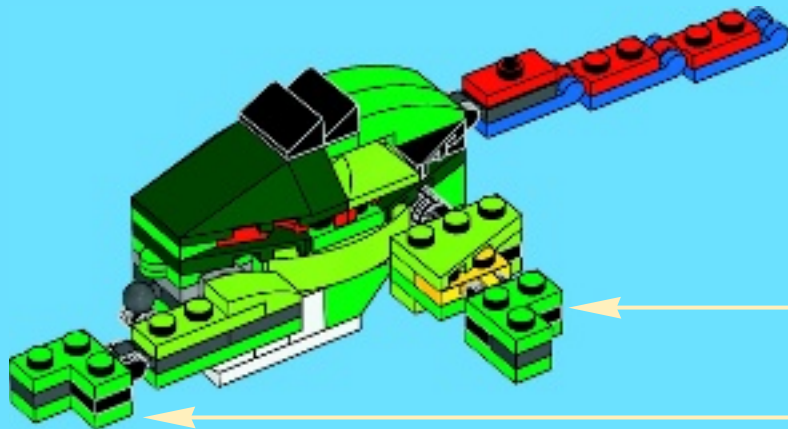



1x



1x



1x



1x



2x

27

1



2



3



4



5

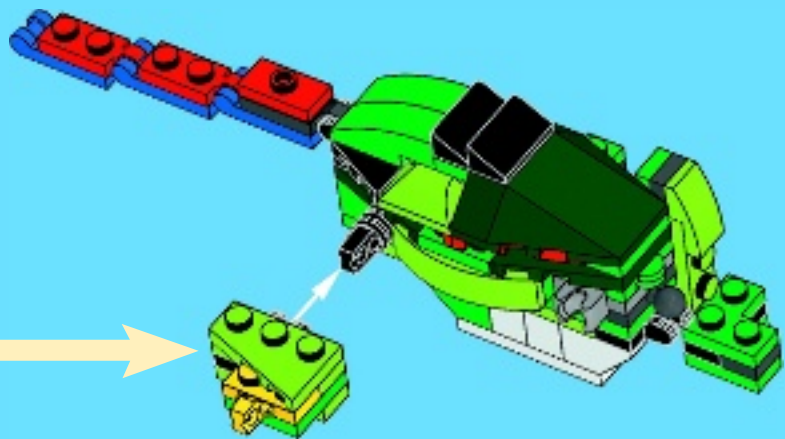



1x



1x



1x



1x



1x

28

1

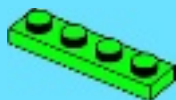

2

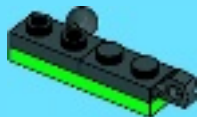

3

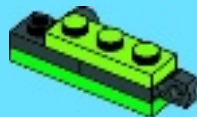

4

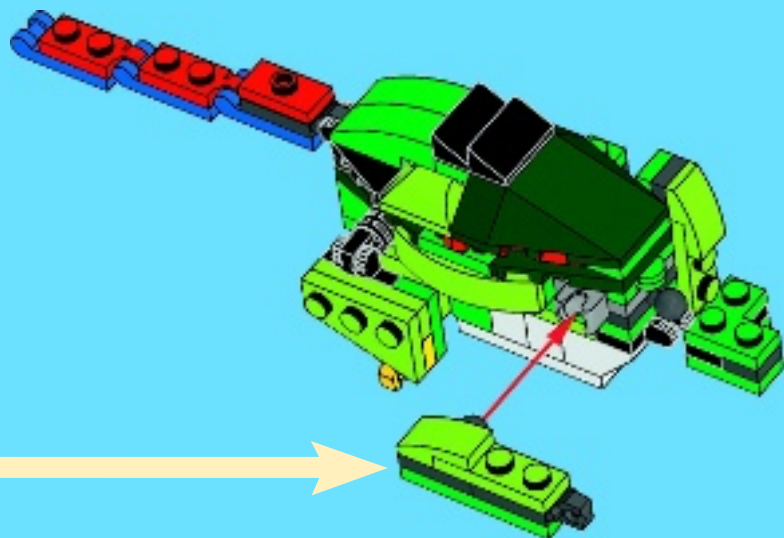
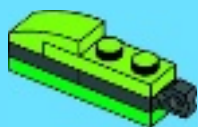



29

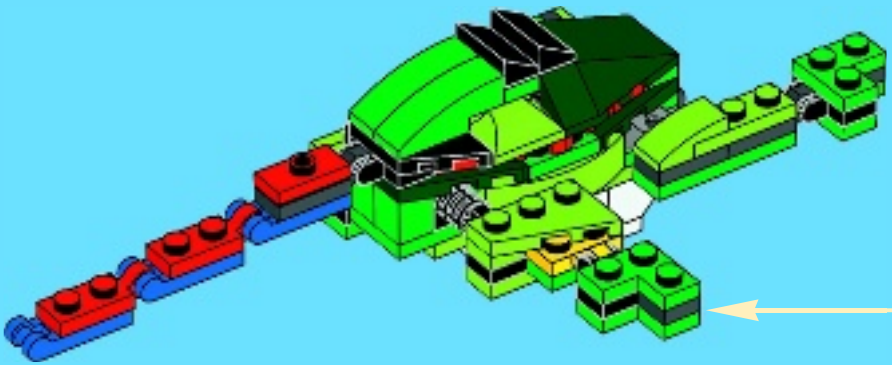
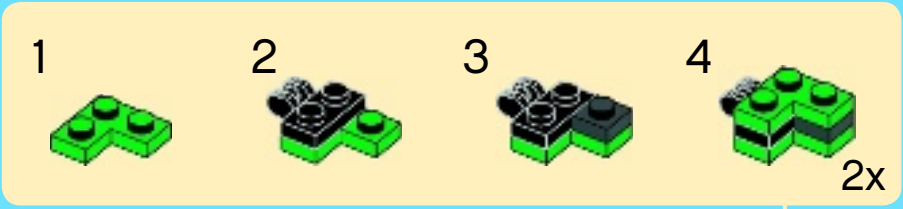



1x

1



1x

2





2x

3

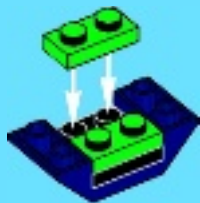

1x

4





1x

5



30



1x



2x

6

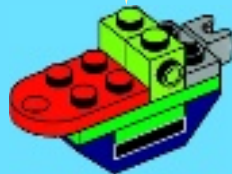



2x

7



2x

8

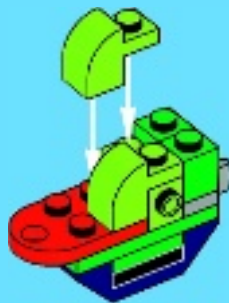



1x

9

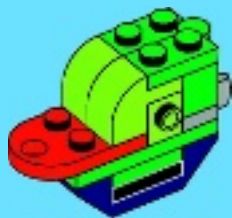

32



2x



2x

10





1x

11

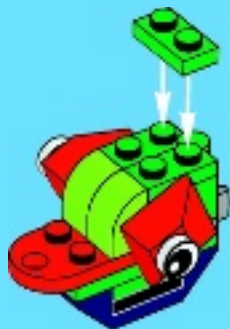

2x

12





2x

13



30

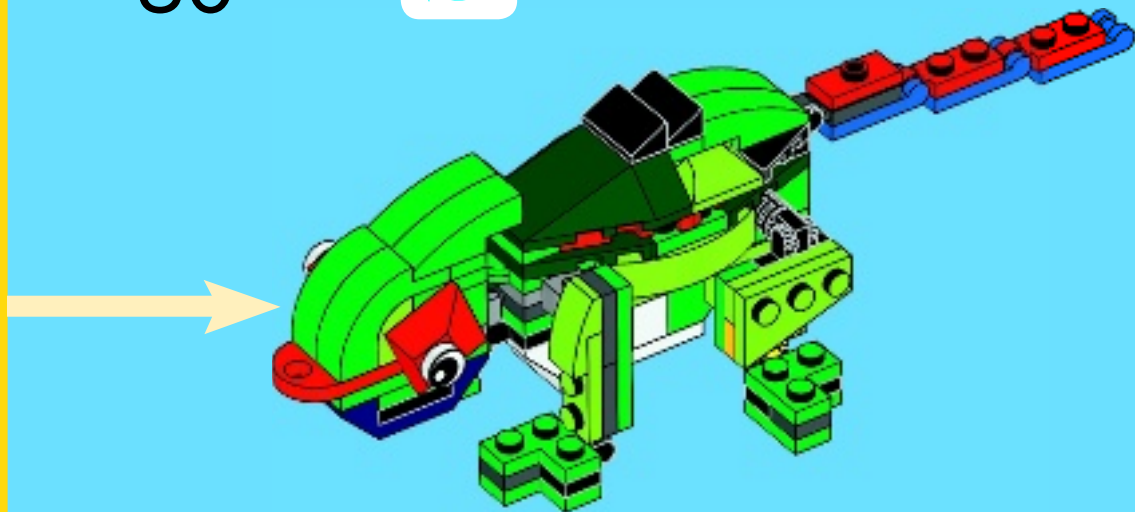



CREATOR

LEGO and the LEGO logo are trademarks of the/son des marques de commerce du/son marcas registradas de LEGO Group. ©2015 The LEGO Group. 6112365 / 6112367



31030



31031



31032



31033



LEGO.com/creator



CREATOR

31031



LEGO.com/creator



1x

1



2



4x

2

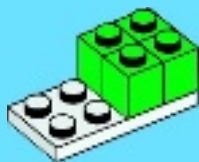



1x

3

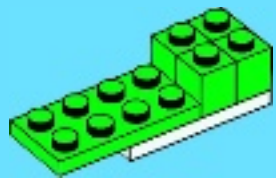

1x

4

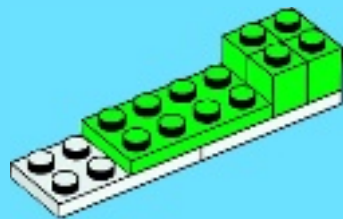



2x

5

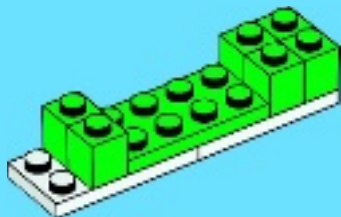

4



1x

6

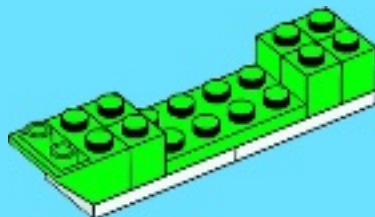



1x



1x

7

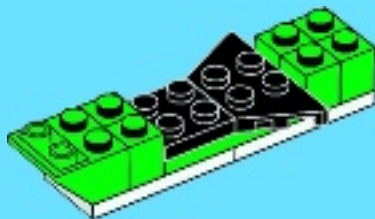

2x

8

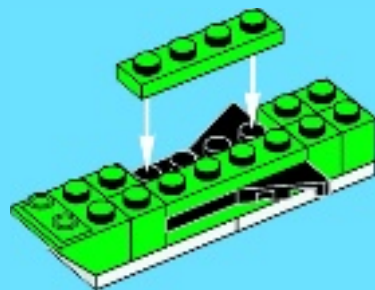



4x



1x



1x

9



6



2x



2x

10





2x

11

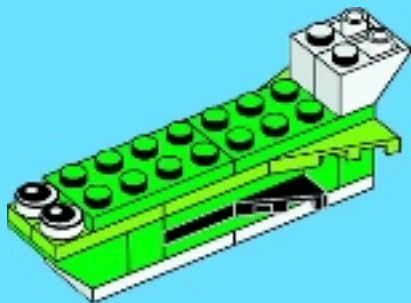

2x



2x

12

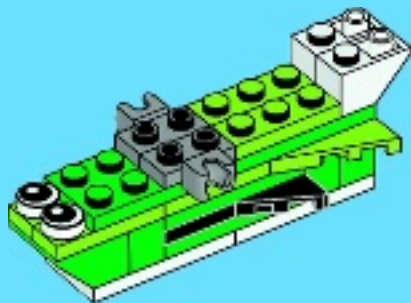



4x

13

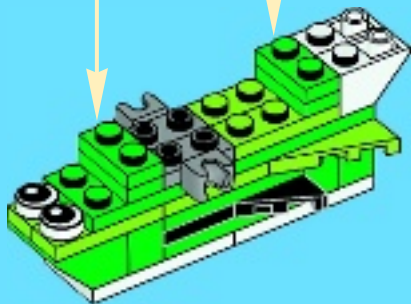
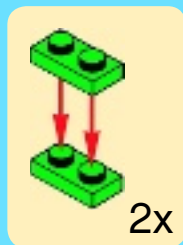



1x



1x

14

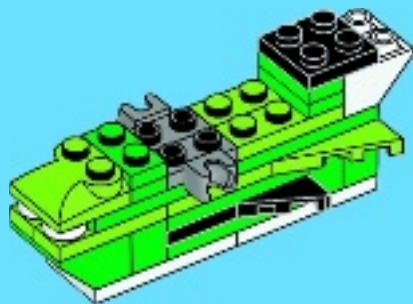

1x



1x

15

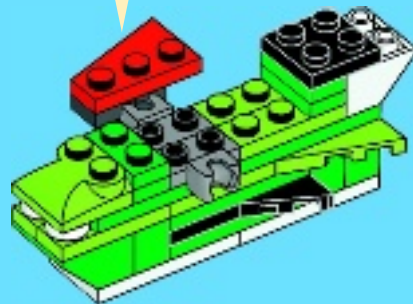



1x



1x

16





1x



2x

17

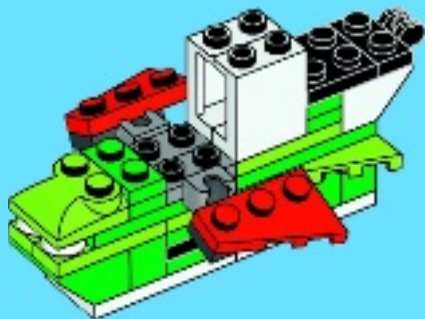

2x

18

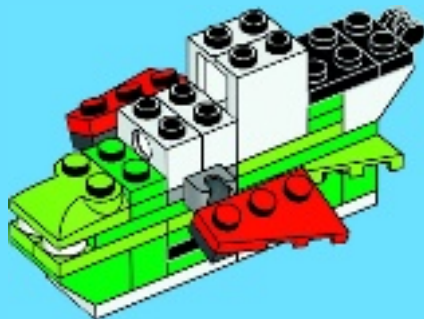



2x

19

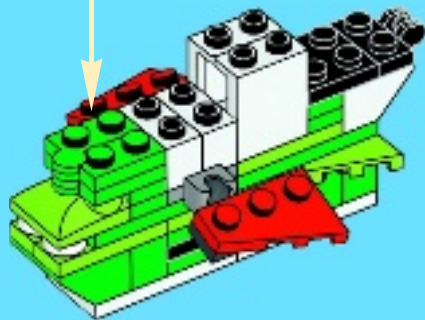
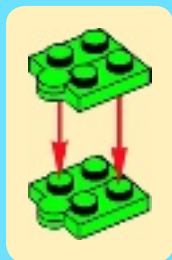



4x

20

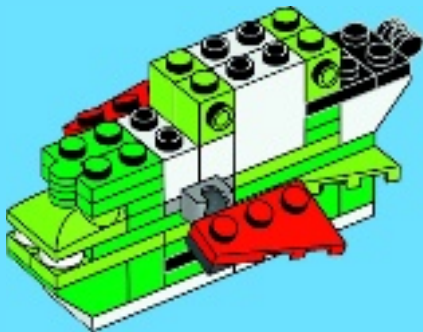

2x



2x



1x

21

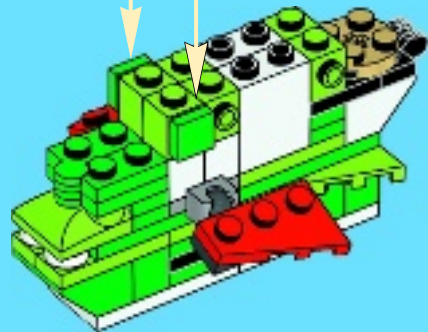
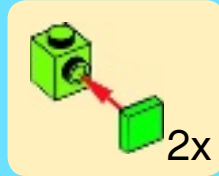



2x



2x

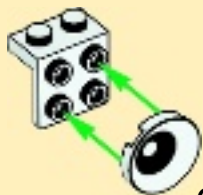

2x

22

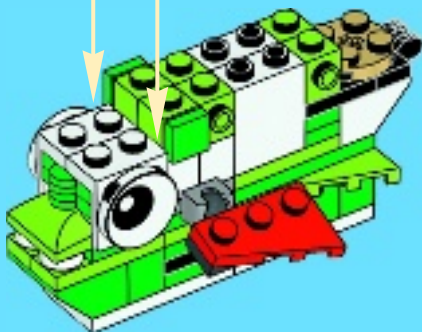



1x

23

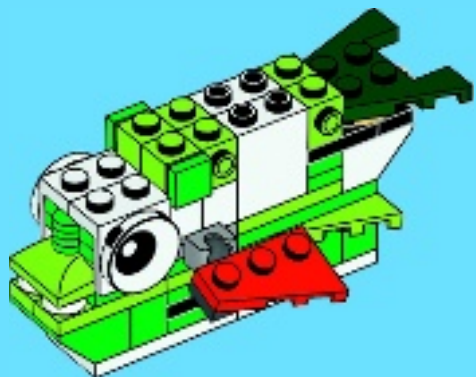

1x



1x

24





2x



2x



4x

25

1



2

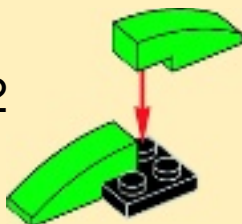

3

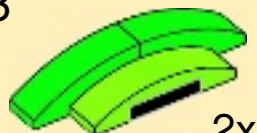

2x

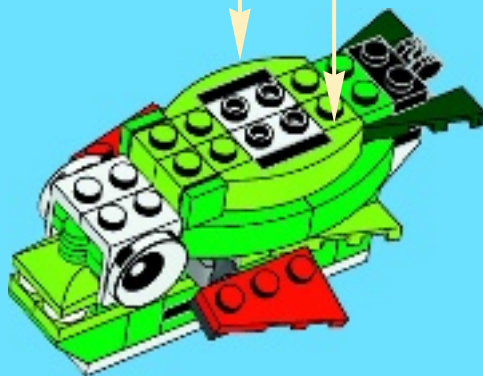



4x



2x

26

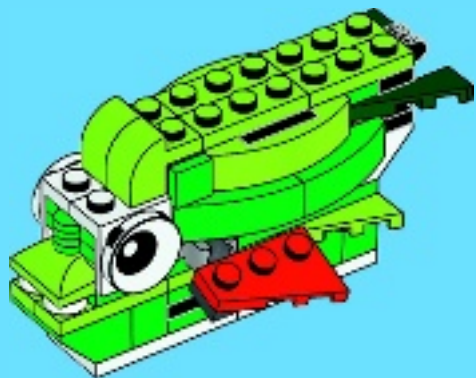

1x

27

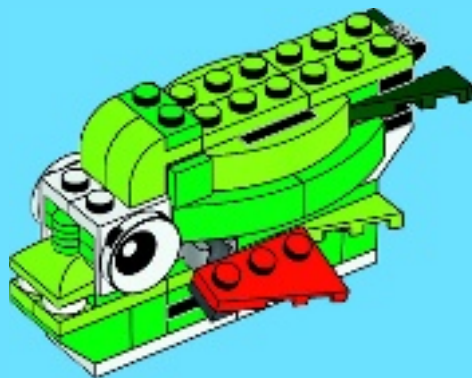



1x

28

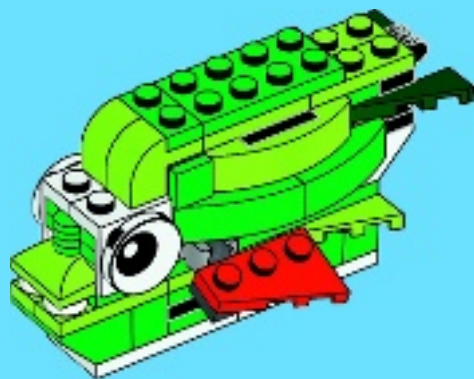



2x

29

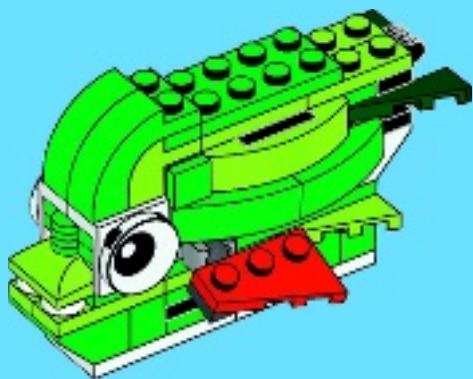

3x

30

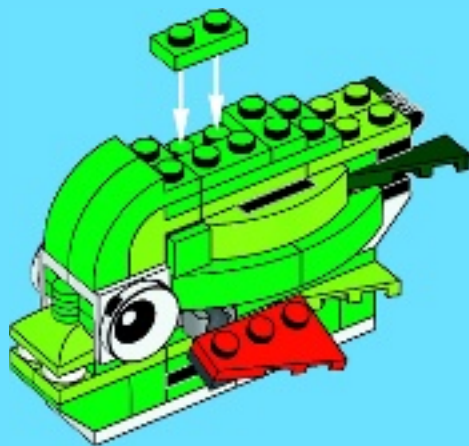



2x

31

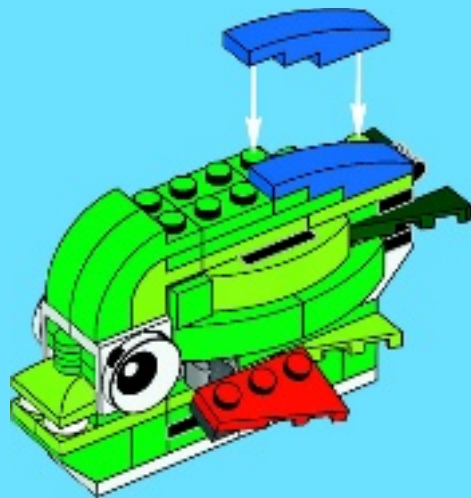



1x

32

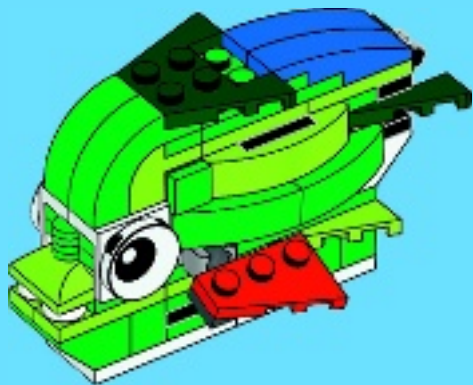



2x

33

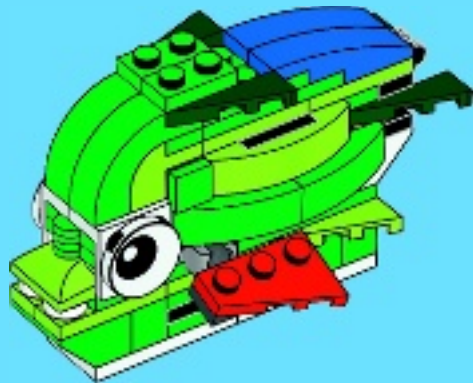



1x

34

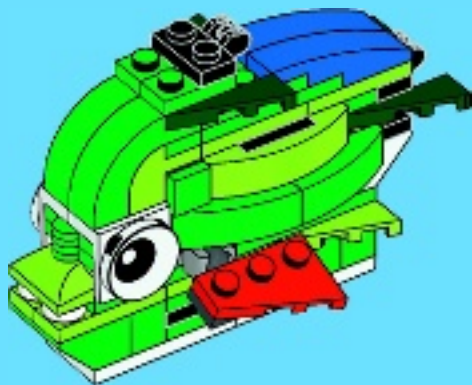

2x

35

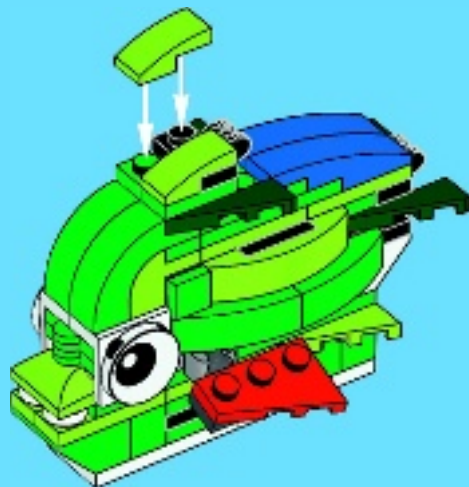

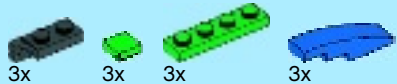

36

1



2

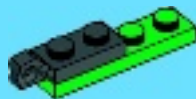

3

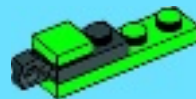

4

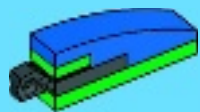

3x

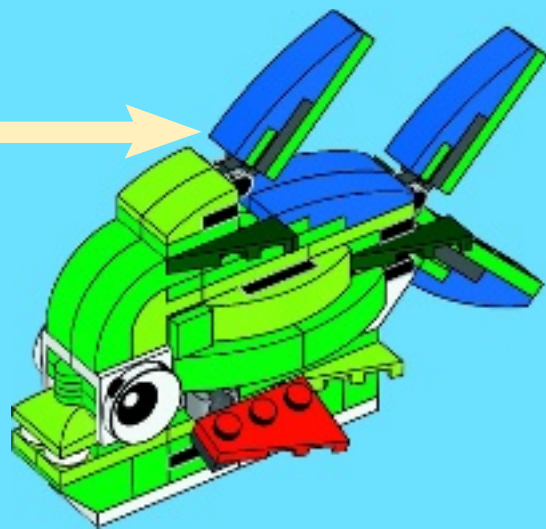



CREATOR

31033

3 IN 1



LEGO.com/creator



CREATOR



LEGO

Available on the
App Store

ANDROID APP ON
Google play

CREATOR ISLANDS



Apple, the Apple logo, iPad, iPhone and iPod touch are trademarks of Apple Inc., registered in the U.S. and other countries. App Store is a service mark of Apple Inc./Apple, le logo Apple, iPad, iPhone et iPod touch sont des marques de commerce d'Apple Inc., déposées aux Etats-Unis et dans d'autres pays. App Store est une marque de service d'Apple Inc./Apple, el logotipo de Apple, iPad, iPhone e iPod touch son marcas comerciales de Apple Inc. registradas en EE. UU. y otros países. App Store es una marca de servicio de Apple Inc.

Google Play is a trademark of Google Inc./Google Play est une marque de commerce de Google Inc./Google Play es una marca comercial de Google Inc.

LEGO.com/creator





CREATOR

LEGO and the LEGO logo are trademarks of the/son des marques de commerce du/son marcas registradas de LEGO Group. ©2015 The LEGO Group. 6112368 / 6112369



31029



31027



31033



31033



31029



31027



LEGO.com/creator