



WOMEN OF NASA

21312



 LEGO.com/ideas

Booklet available in English on
Heft in deutscher Sprache erhältlich auf
Livret disponible en français sur
Libretto disponibile in italiano su
Folleto disponible en español en
Folheto disponível em português em
A füzet magyarul ezen a honlapon olvasható:
如需中文版手册, 请访问 LEGO.com/ideas



MARGARET HAMILTON

COMPUTER SCIENTIST

Born in 1936, Margaret Hamilton was always interested in mathematics. Her early work, beginning in 1959, included developing weather predicting and air-defense software at MIT, in an era when computer science and software engineering were not yet established disciplines.

When NASA contracted with MIT to develop the guidance and navigation system for its Apollo Moon-landing program, Hamilton's experience led to her becoming the leader of the team responsible for developing the spacecraft's on-board flight software for the command module and the lunar module.

On July 20, 1969, as the Apollo 11 lunar lander approached the Moon's surface, its computer suddenly became overtaxed. Priority displays designed by Hamilton warned the astronauts with 1201 and 1202 alarms, allowing NASA's Mission Control to understand what was happening and alerting the astronauts to place the rendezvous radar switch in the right position. The mission was a success, Apollo 11's crew became the first humans ever to walk on the Moon; and the software became the first software to land on the moon.

Hamilton and her team's software was so reliable that NASA went on to use parts of it in the Skylab space station and the Space Shuttle.

Hamilton is CEO of Hamilton Technologies. Its Universal Systems Language, together with its preventative life cycle and its automation, is based on her mathematical theory of control for systems and software. For her work as a pioneering computer scientist, she received NASA's Exceptional Space Act Award in 2003, and the Presidential Medal of Freedom from President Obama in 2016.





SALLY RIDE

PHYSICIST, ASTRONAUT AND ENTREPRENEUR

Sally Ride was born in Los Angeles in 1951. While completing her PhD in physics at Stanford University, she read in a student newspaper that NASA was recruiting astronauts, and for the first time, women could apply. Ride was one of 8,000 applicants and one of six women selected by NASA in 1978.

While training for her first spaceflight, Ride endured intense media attention focused on her gender. She insisted on being treated the same as any other astronaut. On June 18, 1983, she blasted off aboard the space shuttle *Challenger* to become America's first woman in space. During the flight, Ride used *Challenger's* robotic arm to capture a satellite hurtling around Earth. Her historic flight made her a symbol of women's ability to break barriers and an inspiration to generations of adventurous girls.

Ride flew aboard the *Challenger* again in 1984 and later led a task force that wrote an influential report on America's future in space. After leaving NASA in 1987, she became a physics professor. She cowrote science books for young people and cofounded a company, Sally Ride Science, to inspire students in math and science.

Ride died in 2012. She was posthumously awarded the Presidential Medal of Freedom.





NANCY GRACE ROMAN

ASTRONOMER



Born in 1925, Nancy Grace Roman formed an astronomy club with her classmates at the age of 11. After graduating early from high school, she worked at several observatories while earning a Bachelor of Arts degree and a PhD in Astronomy. Throughout her education, she battled against the belief that women should not want to be scientists.

In her late twenties, Roman discovered unusual behavior in the emission spectra of the star AG Draconis. She published her findings, becoming well recognized in the astronomy field. After working at the Naval Research Laboratory, she applied to the newly formed NASA and became the first Chief of Astronomy for its Office of Space Science, as well as the first woman to hold an executive position at the agency.

Over the course of her career at NASA, Roman was involved in the development and launching of numerous satellites. She is most famous for her work in the planning of the Hubble Space Telescope, launched in 1990, and is often called the “Mother of Hubble”.

Roman received the NASA Exceptional Scientific Achievement Medal in 1969. NASA's Nancy Grace Roman Technology Fellowship in Astrophysics and the asteroid 2516 Roman are named in her honor.



MAE JEMISON, M.D.

ASTRONAUT, ENGINEER,
PHYSICIAN, DANCER



Insatiably curious, Mae Jemison set her mind early to exploration. Pursuing everything from dinosaurs and stars to fishing, travel and dance, her mission has always included science, teaching and discovering something new!

Starting Stanford University at the age of 16, Jemison graduated with Bachelor's degrees in Chemical Engineering and African Studies. She then earned her Doctorate in Medicine from Cornell University Medical College. She practiced medicine and lived in West Africa as the Area Peace Corps Medical Officer for Sierra Leone and Liberia.

In 1987, Jemison was one of 15 individuals chosen from among 2000 applicants to train to be a NASA astronaut. On September 12, 1992, she launched into space aboard the Space Shuttle Endeavour, spending over 190 hours conducting life sciences, material sciences and medical experiments. Traveling over three million miles, Jemison was the first woman of color in the world in space.

Jemison founded an international science camp for 12-16 year olds, started two technology companies and was an environmental studies professor. Today, Jemison leads 100 Year Starship—a global initiative that is pushing the frontiers of space exploration—ensuring human interstellar travel in 100 years.

The recipient of many awards and honors, Jemison is a member of the National Academy of Medicine, the Women's Hall of Fame and the International Space Hall of Fame. Jemison loves cats, science fiction, art, dance, gardening and mysteries!

Science editor and writer Maia Weinstock combined three of her personal passions in designing the Women of NASA set for LEGO® Ideas: space exploration, the history of women in science and engineering, and LEGO building.

“I thought people might like to build their own display featuring minifigs of accomplished women in the STEM [Science, Technology, Engineering and Mathematics] professions. For the vignettes, I wanted to contextualize each person in terms of her contribution to NASA history.”

“I was absolutely elated when the project reached 10,000 supporters! The set clearly touched and inspired many, as it reached 10,000 supporters in just 15 days. The night on which it appeared we’d reach 10K, I stayed up until 4:30 or 5 in the morning so that I could watch the 10,000th vote come in. I didn’t get much sleep that day, but it was thrilling!”

“It is incredibly rare for a company — much less a global powerhouse like LEGO — to crowdsource ideas from fans/customers/potential customers. I give LEGO Ideas a ton of credit for pushing the envelope in terms of giving the public a say in what ultimately becomes available. I also value LEGO Ideas for simply being a platform where nontraditional set ideas can be seen and appreciated for what they are.”

FAN DESIGNER

MAIA WEINSTOCK



LEGO® DESIGNERS

GEMMA ANDERSON & MARIE SERTILLANGES

LEGO® designers Gemma Anderson and Marie Sertillanges were thrilled to help refine Maia's model into an official LEGO set.

"I was extremely excited about working on this one, especially as I had already heard of it and really wanted it to become a set," says Gemma. "My focus was on ensuring that the model had stability, the colors were aligned and the subjects were accurately portrayed, all while staying respectful to the design of the original model."

For Marie, "The main challenge in designing the minifigures and the decorations was that I could not make anything up. Every detail was important and needed to match reality, since they represent real-life women. It was beautiful to hear some of the stories behind the scenes, like how Sally's name tag was changed from 'Sally Ride' to just 'Sally' at her own request."

The designers were extremely happy about their collaboration with the fan designer, Maia Weinstock. They hope to have truly captured the achievements of Margaret Hamilton, Sally Ride, Nancy Grace Roman and Mae Jemison, four very inspirational women.

Photo right: Marie, Gemma and project Design Lead Tara Wike dream of their own outer space adventures.





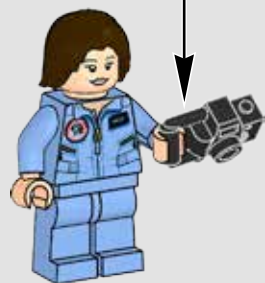
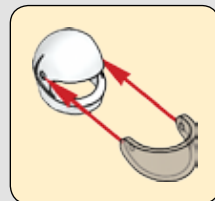
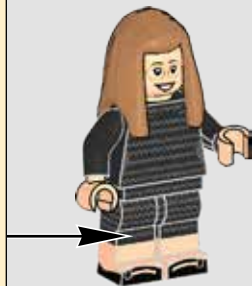
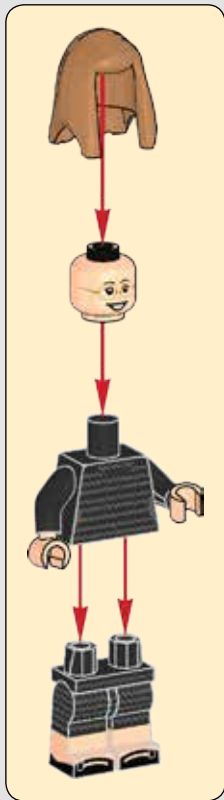

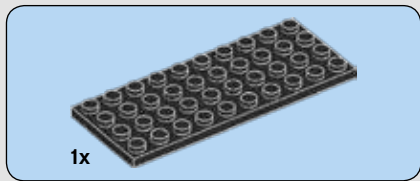

1

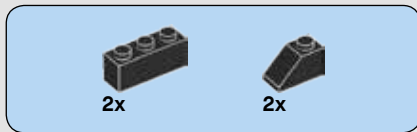
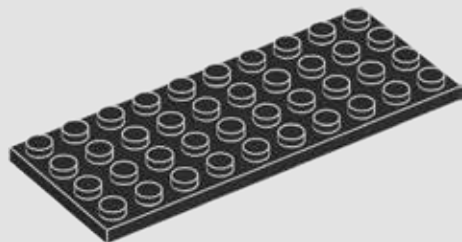

2

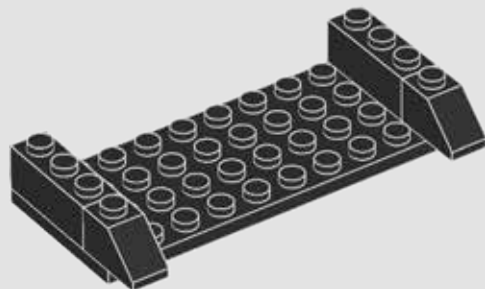

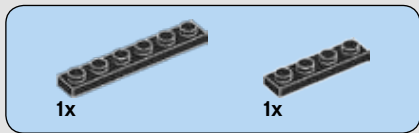

3

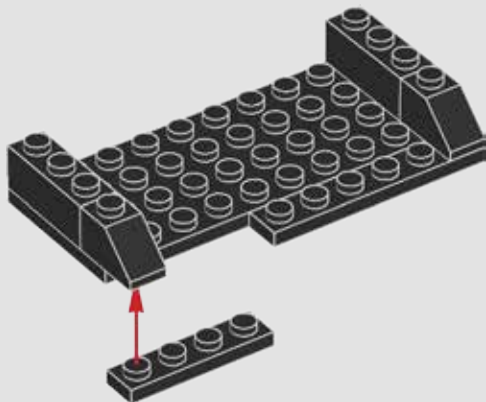

4

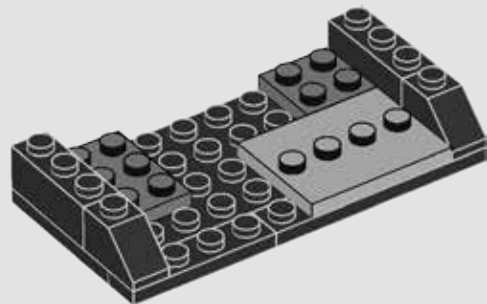



2x

5

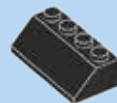
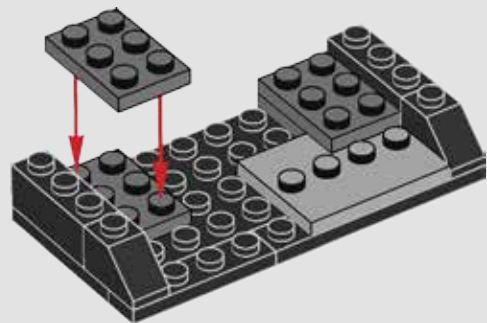

1x



2x

6

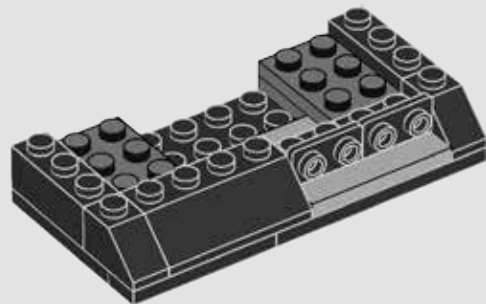

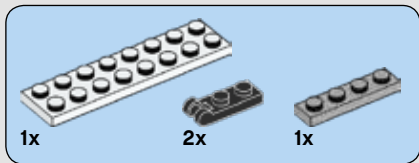

7

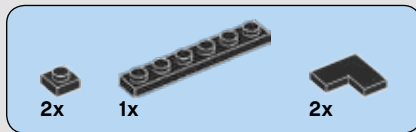
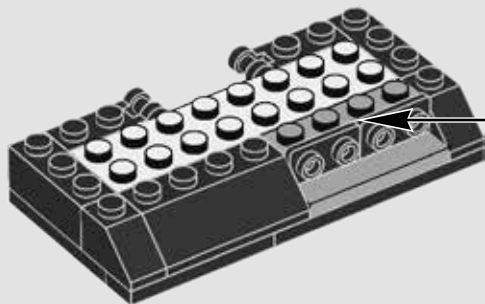
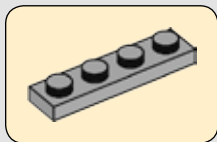

8

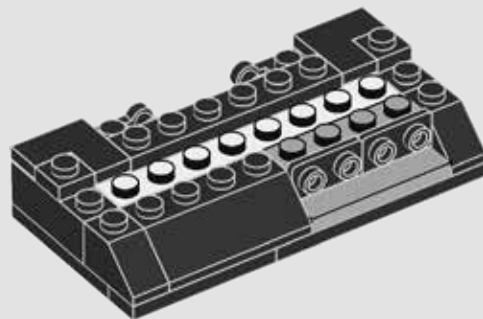

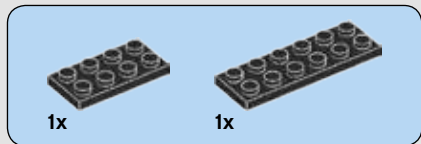

9

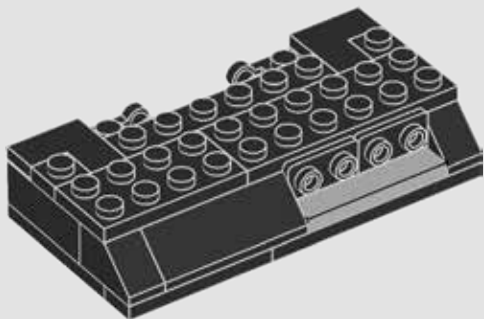

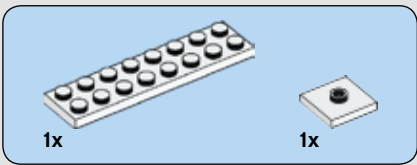

10

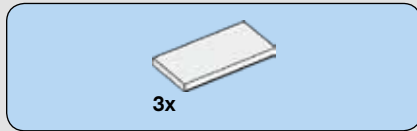
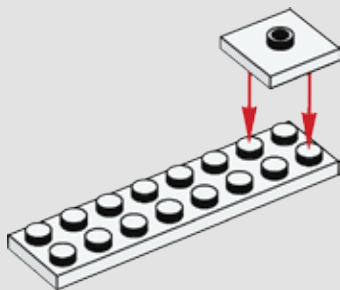

11

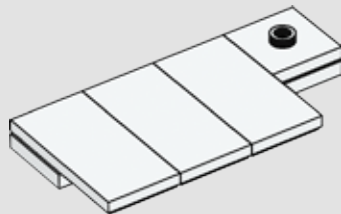

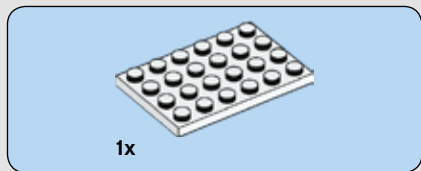

12

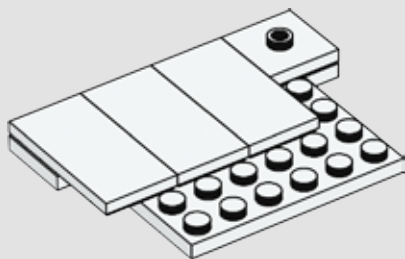

16

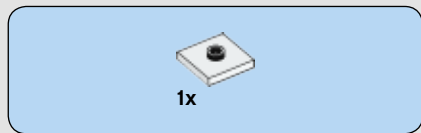

13

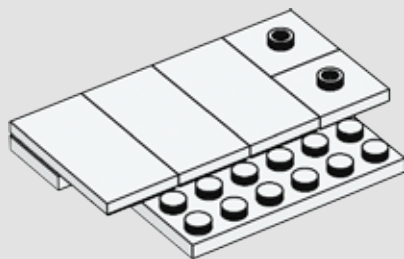

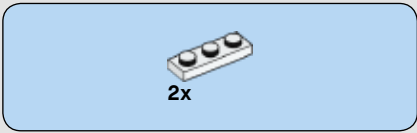

14

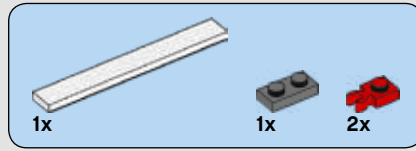
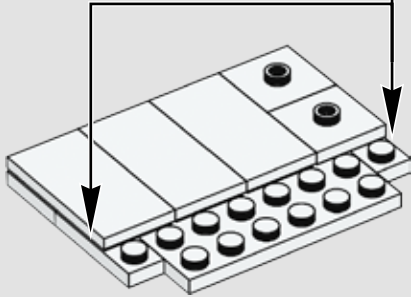
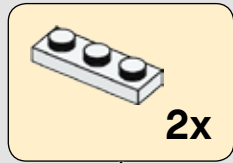

15

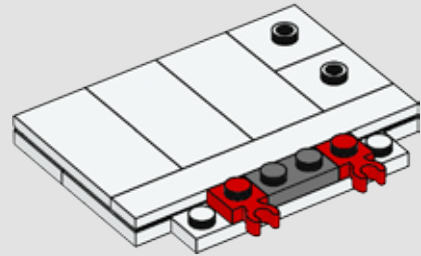



16

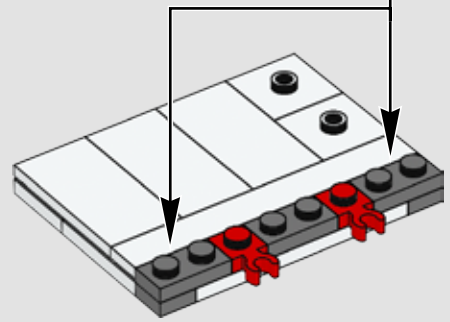
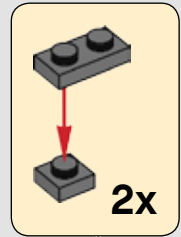

18

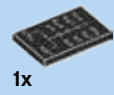
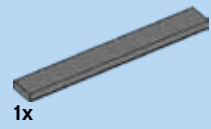

17

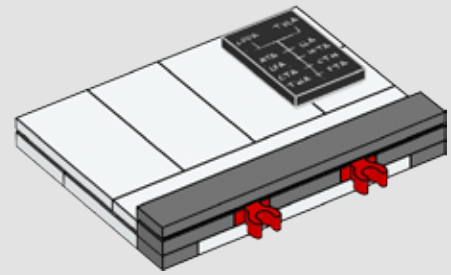

18

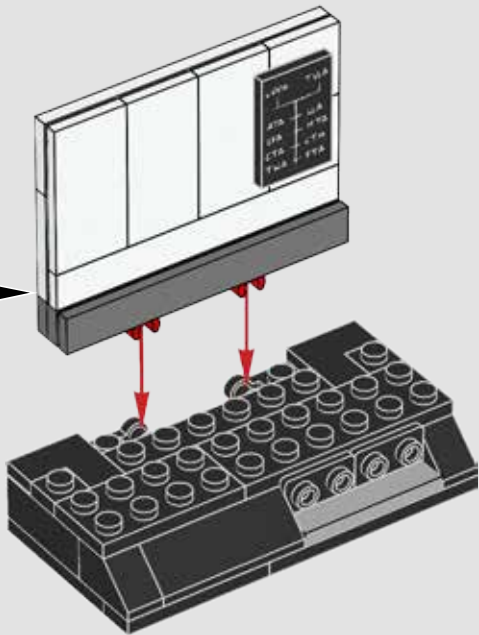

19

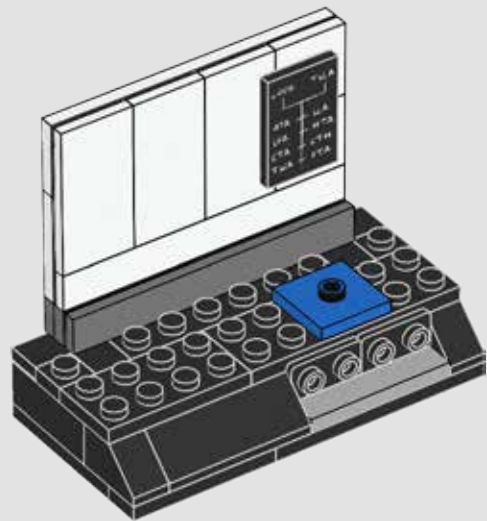

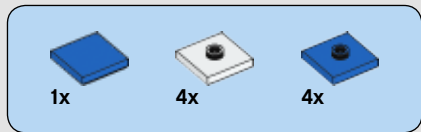

20

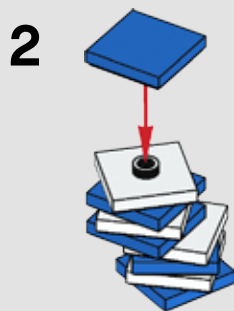
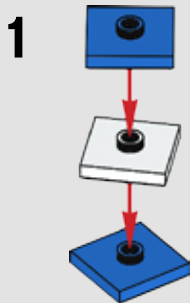



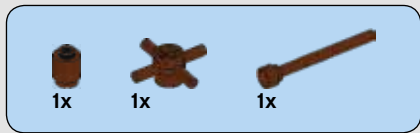

21

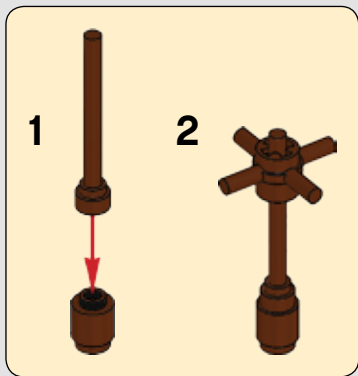

22

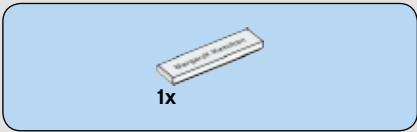

22



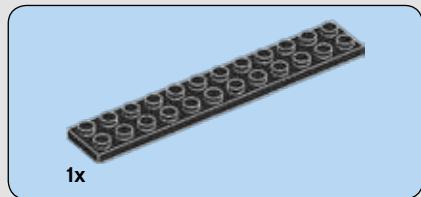
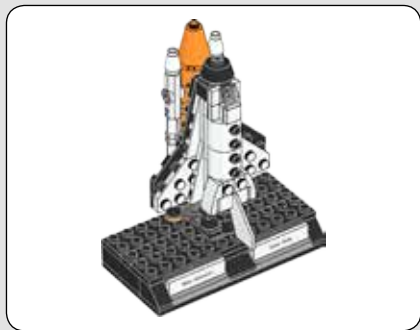

1

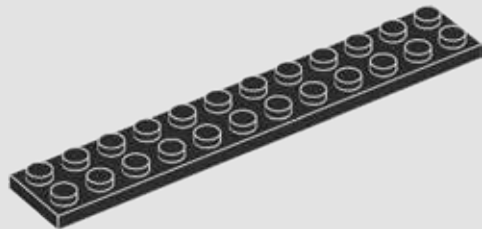



2x



1x

2

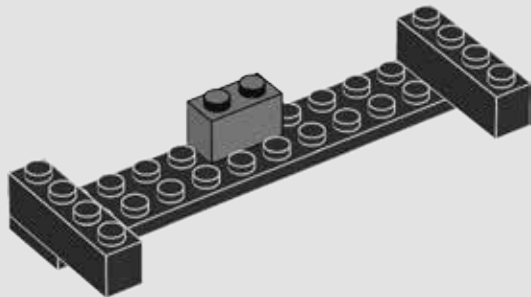

2x

3

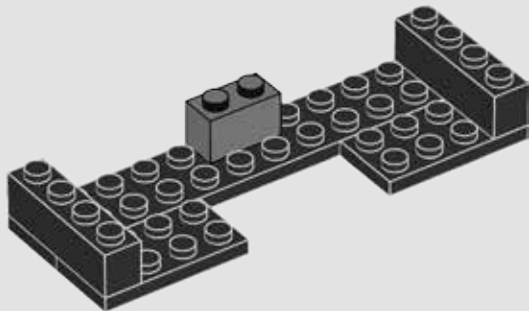

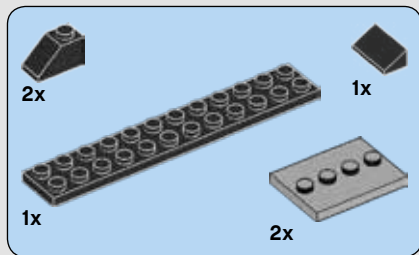

4

1

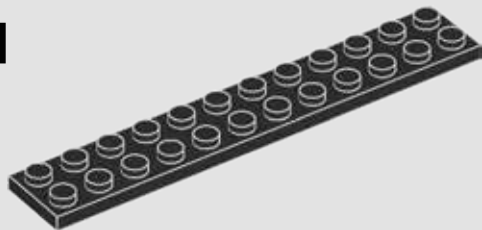

2

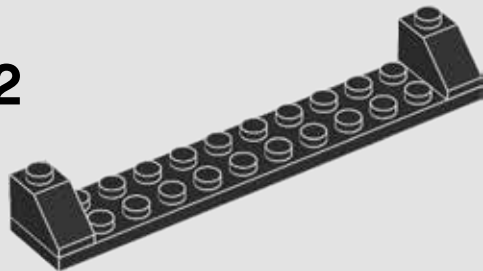

3

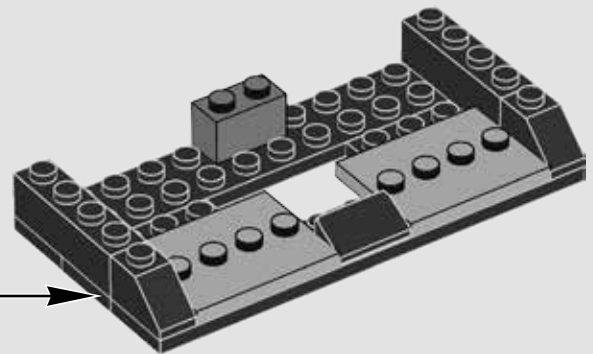
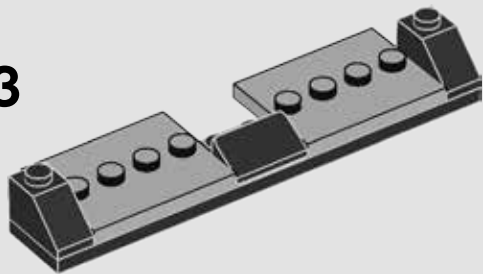

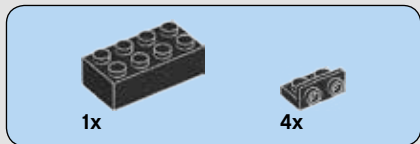

5

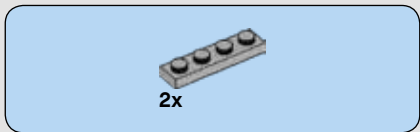
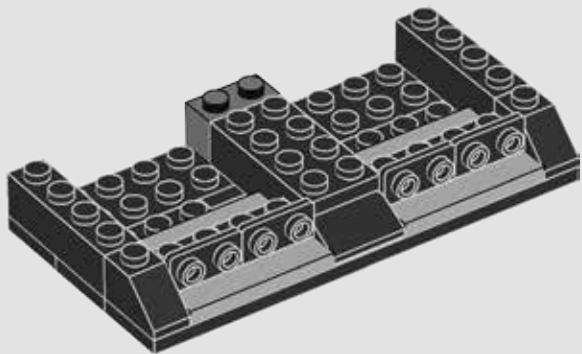

6

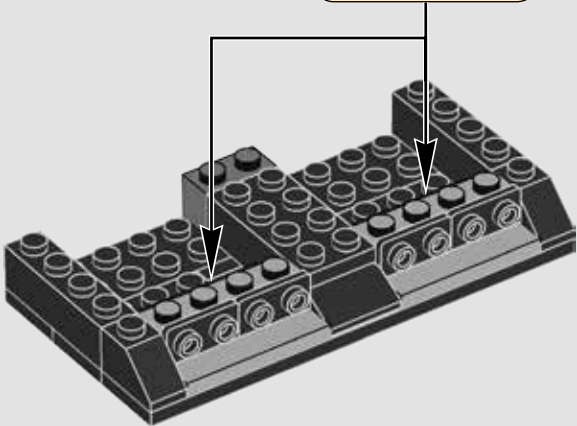
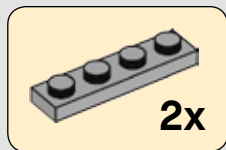

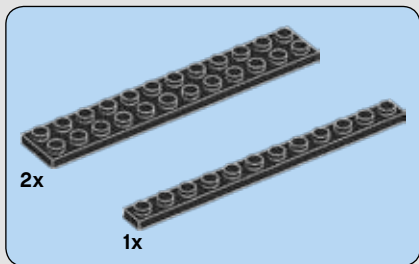

7

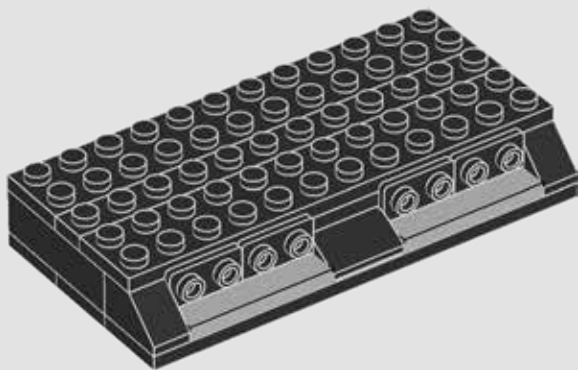



8

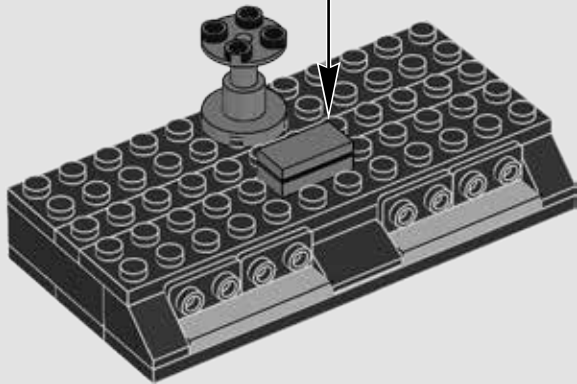
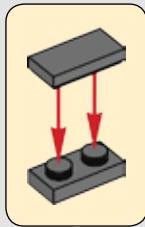

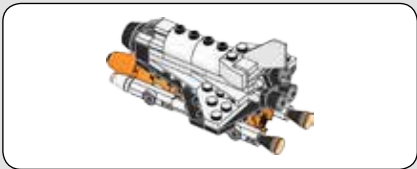

9

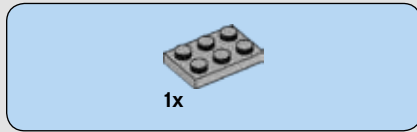
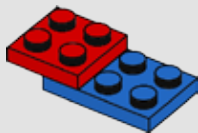

10



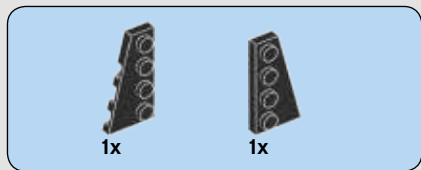

11

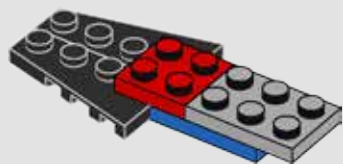

32



12

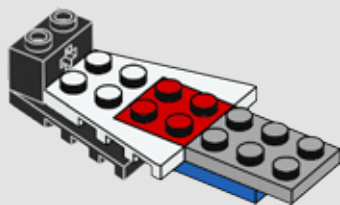



1x



1x

13

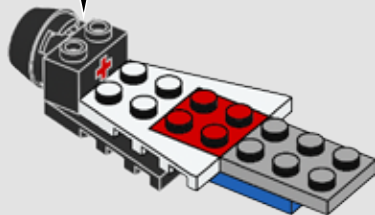
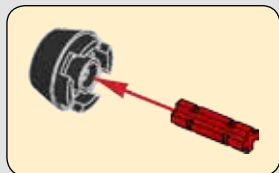

1x



1x



2x

14

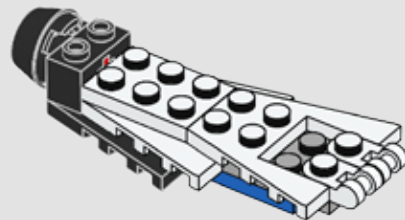



2x



1x

15

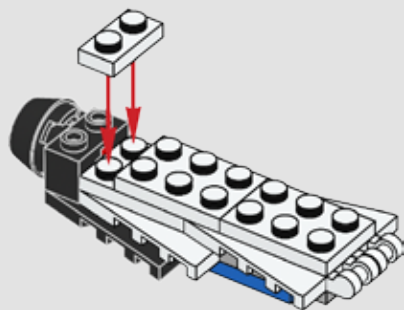

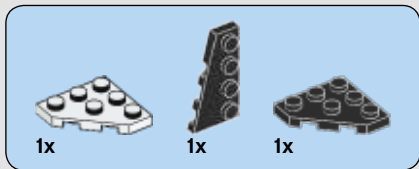

16

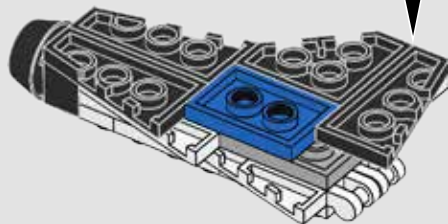
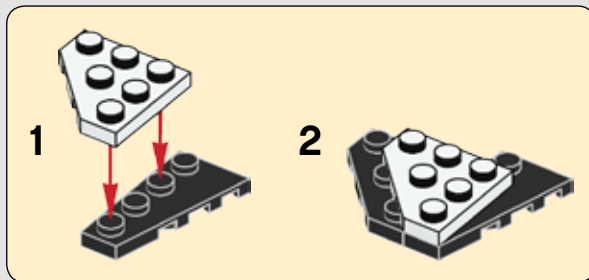
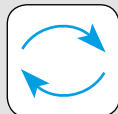

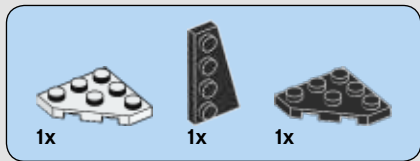

17

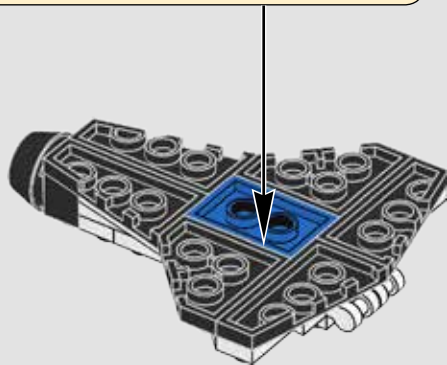
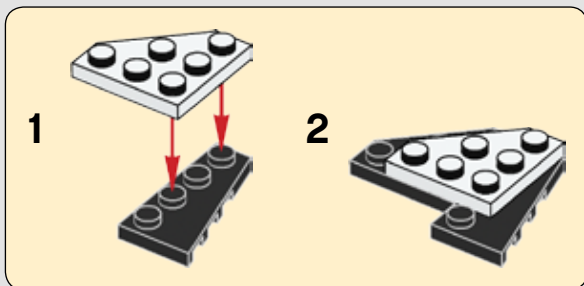



2x

18

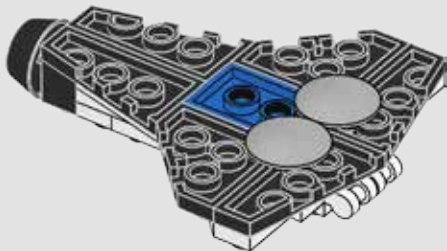

2x

19

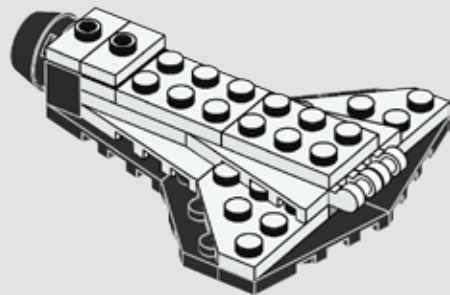
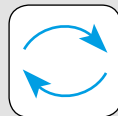



1x



1x



1x

20

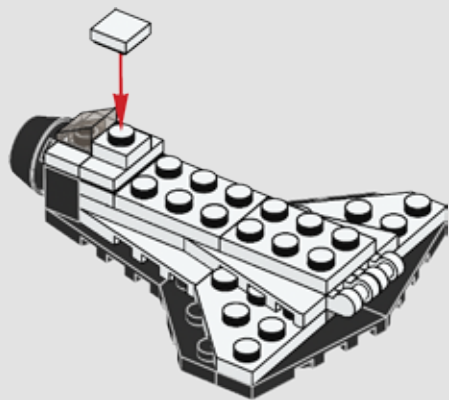

2x



2x

21

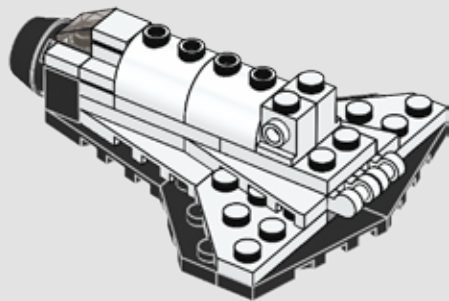



22

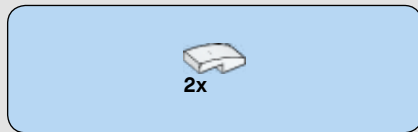
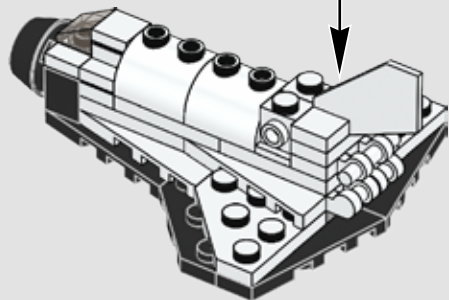
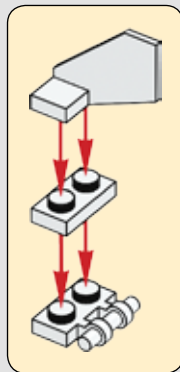

23

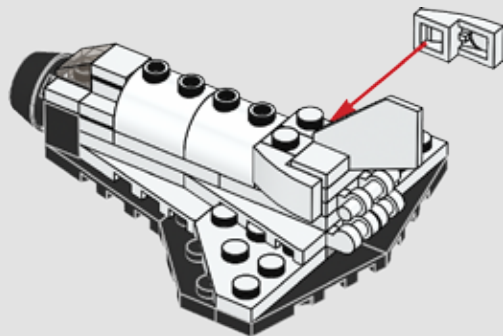



3x



3x

24



3x

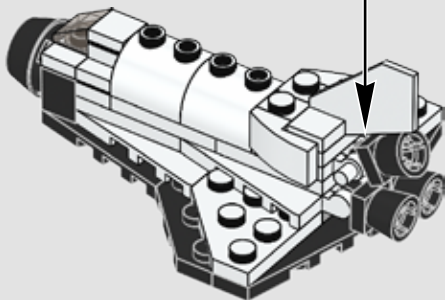

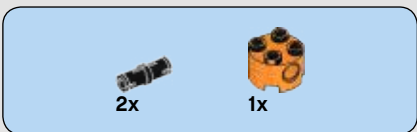
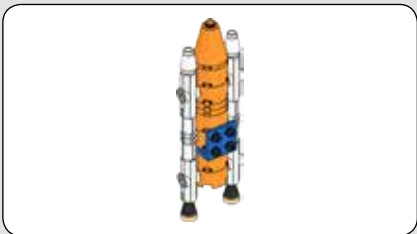

25

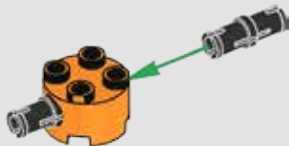

26

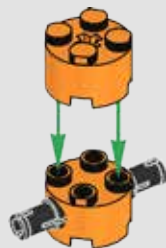



1x



1x

27



2x

28

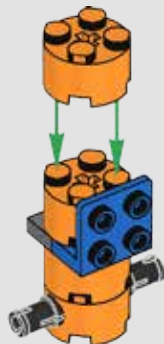



29

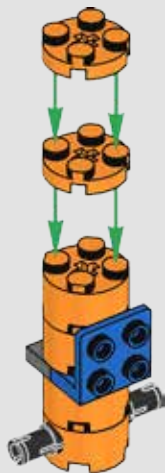

30

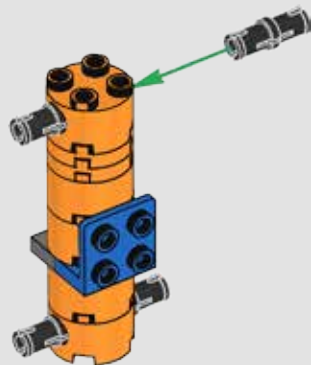



1x



1x

31



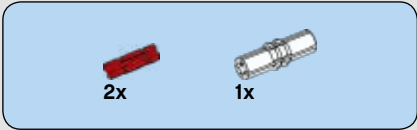
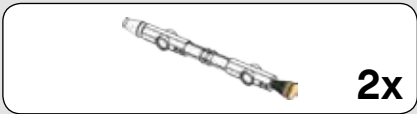

32

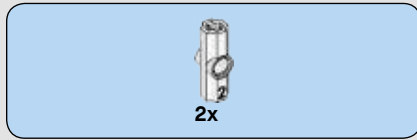
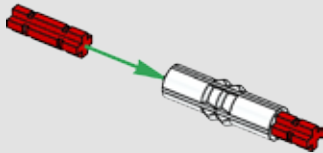

33

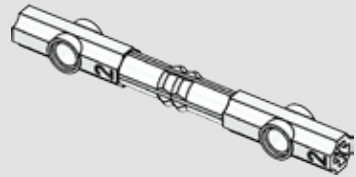



1x



1x

34

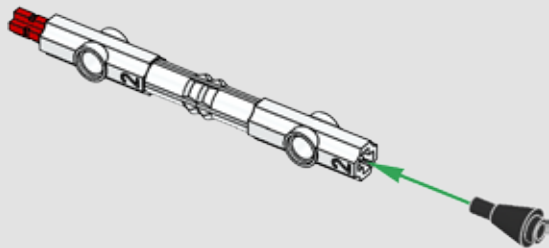

1x



1x

35

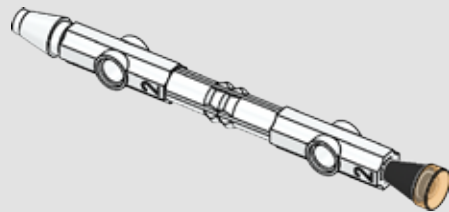

2x

36

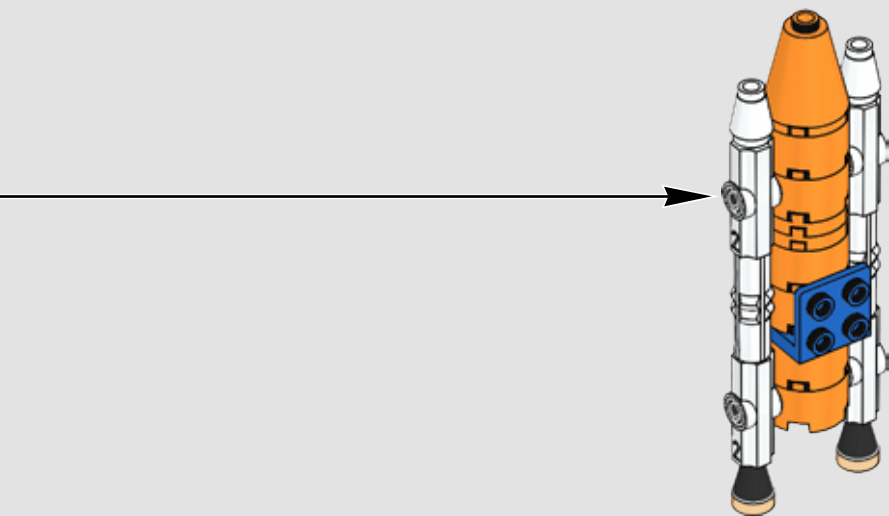

37

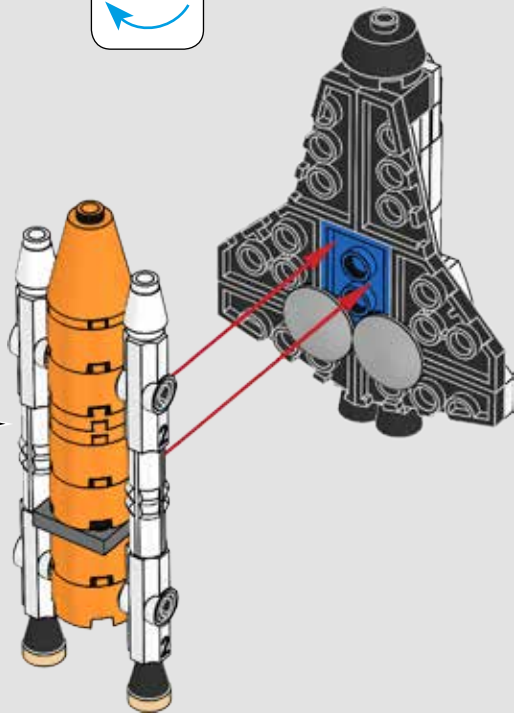
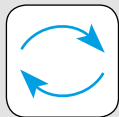

38

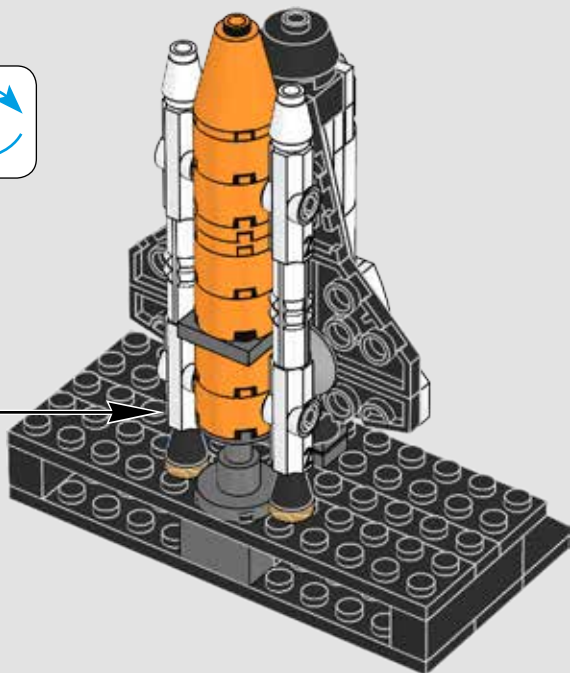
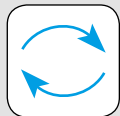



1x



1x

39

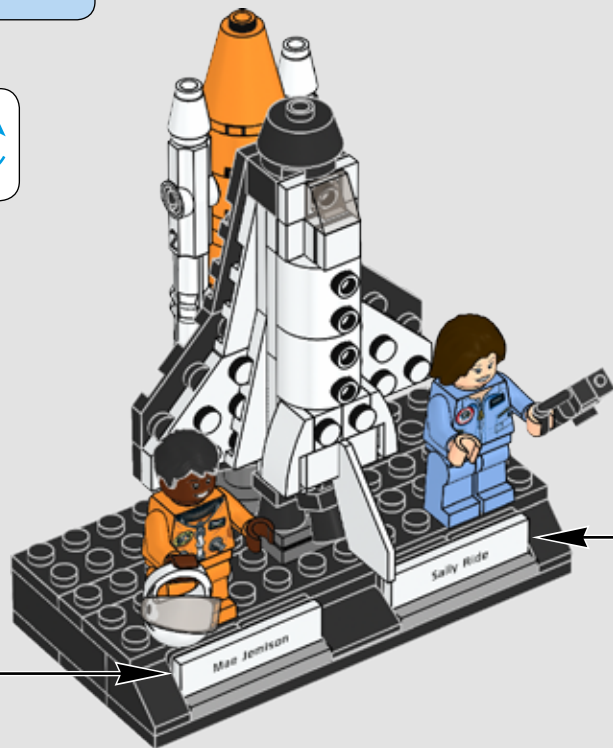
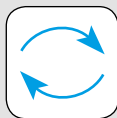

Mae Jemison

Sally Ride

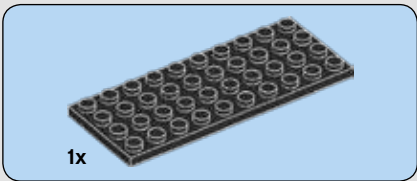

1

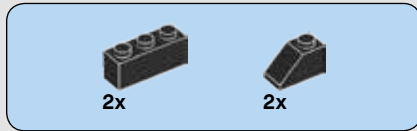
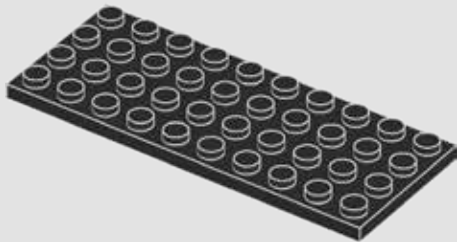

2

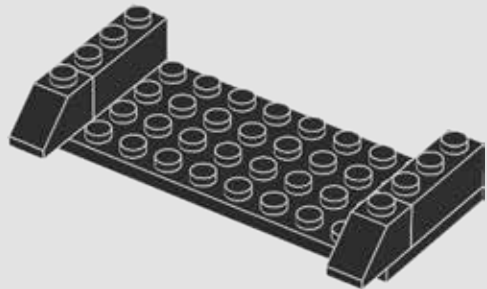

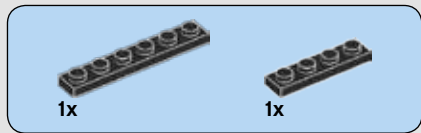

3

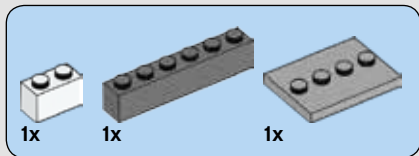
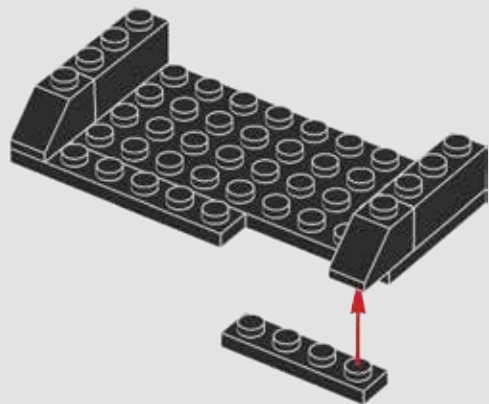

4

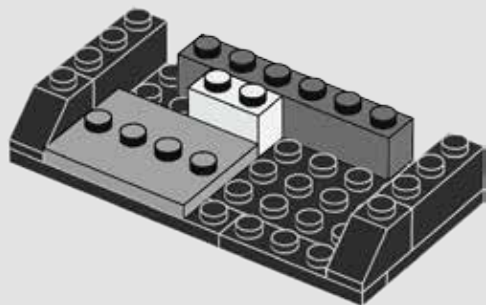

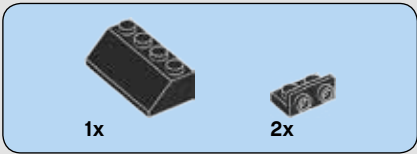

5

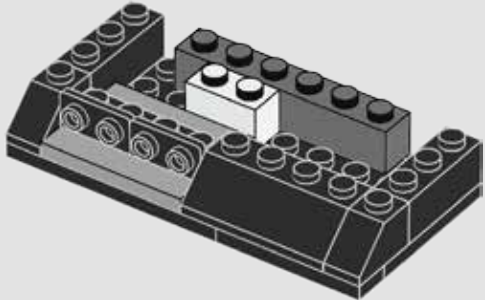

6

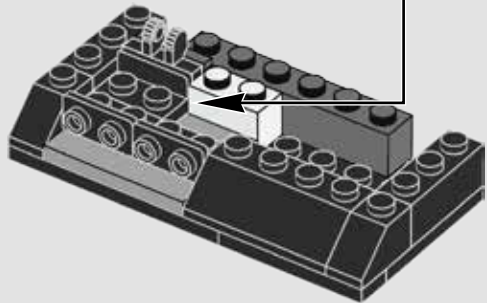
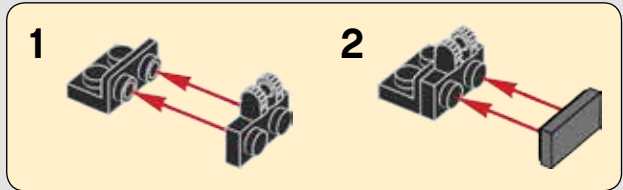



7

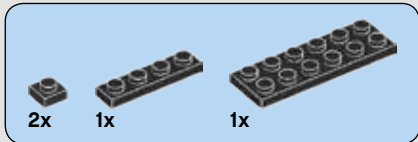
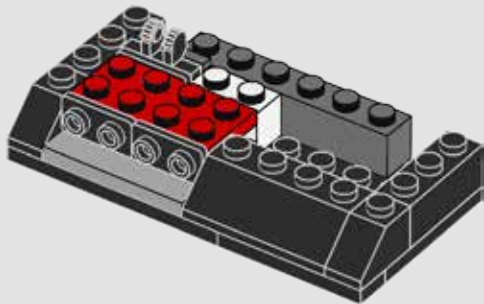

8

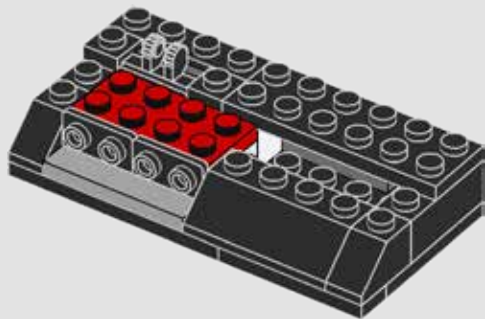

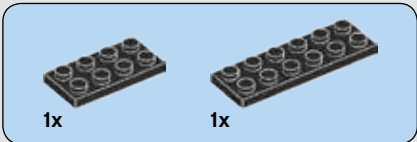

9

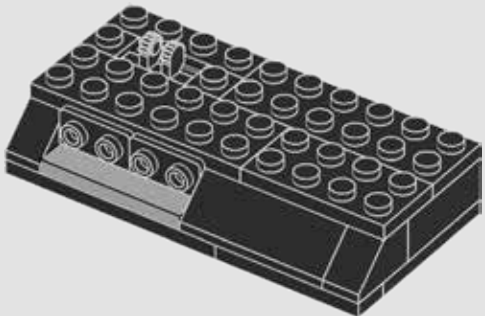

10

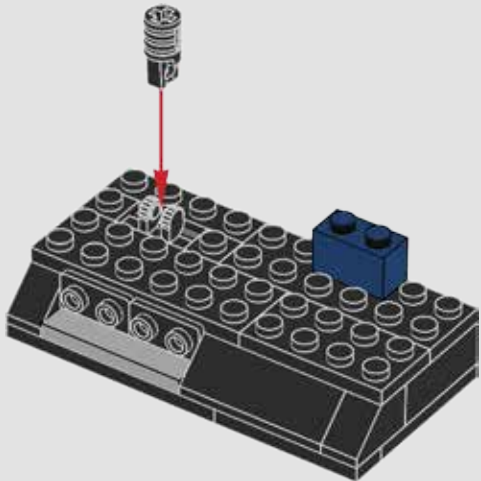

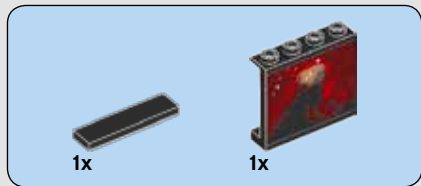

11

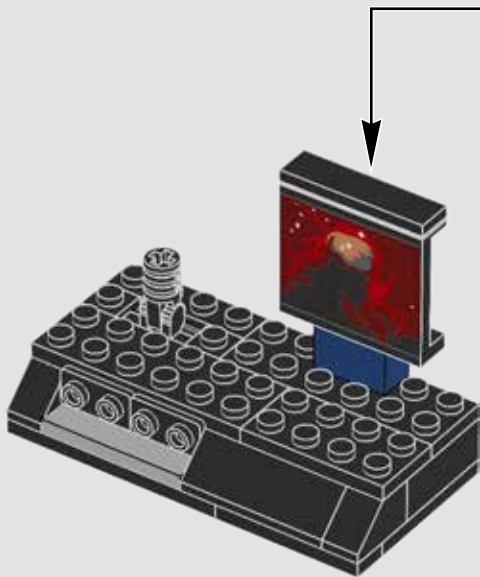
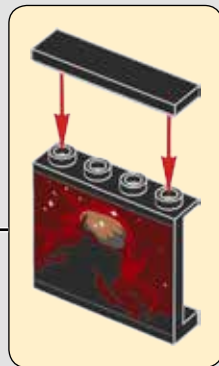

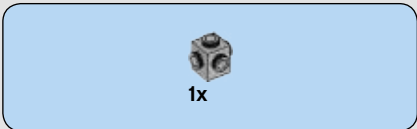

12

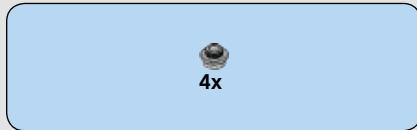

13

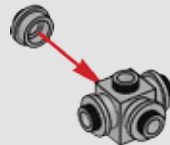



2x

14



1x

15

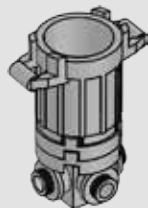

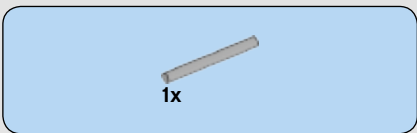

16

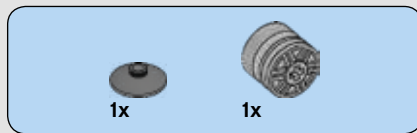
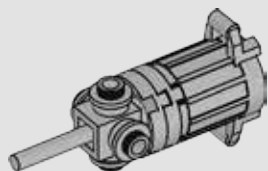
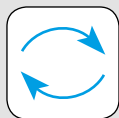

17

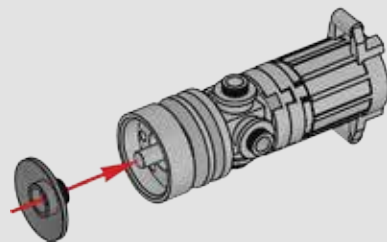



1x



1x



2x

18

1



2



3

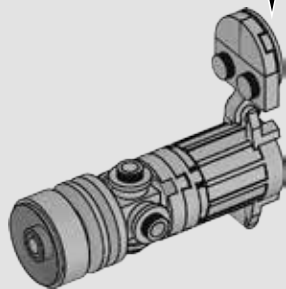

2x



1x

19

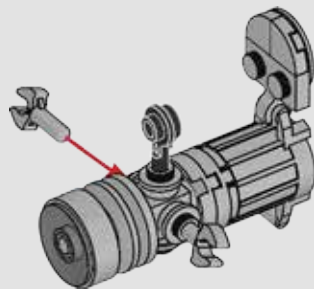



20

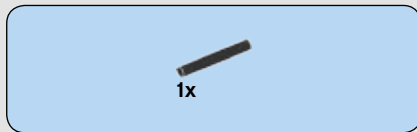
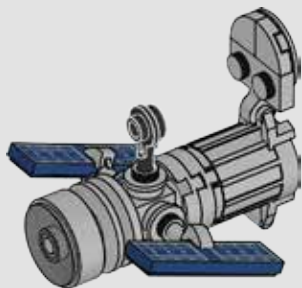

21

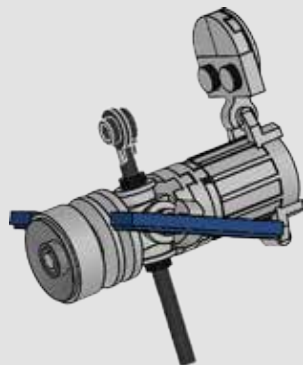



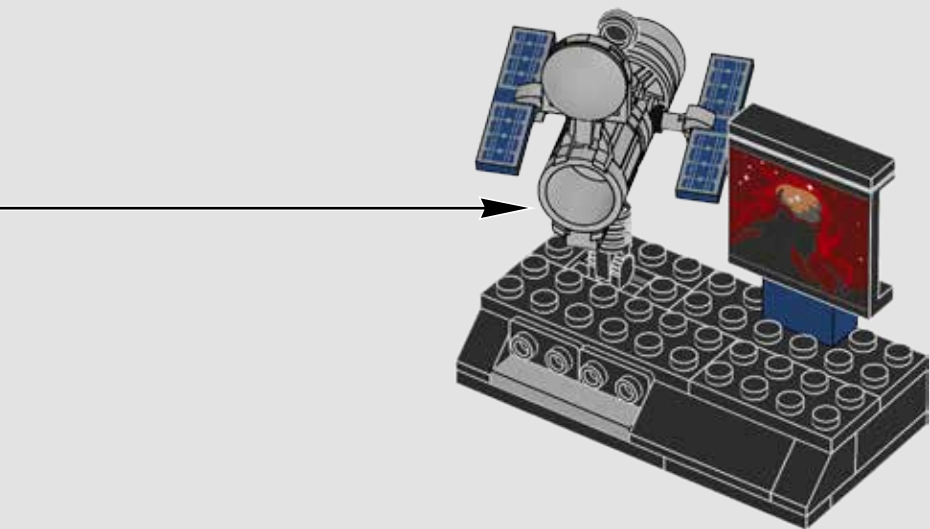

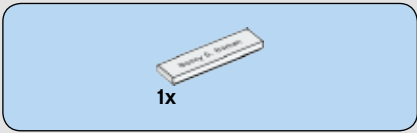



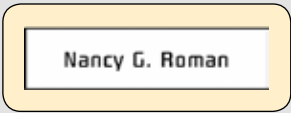





















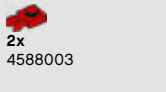





































22





23



 2x 4518400	 2x 6051511	 1x 6215334	 1x 303201	 1x 6133720	 2x 4161332	 1x 6178922	 1x 243126
 4x 4125554	 2x 6034044	 1x 6215336	 2x 303401	 5x 6126049	 1x 6196548	 6x 4121966	 3x 371026
 1x 302401	 1x 4140583	 1x 6215338	 2x 303401	 1x 306823	 1x 4158848	 9x 6020193	 2x 301026
 2x 407001	 2x 4624989	 1x 6215235	 2x 4588003	 1x 302123	 2x 4160869	 1x 6093525	 2x 303726
 1x 307001	 6x 6126046	 2x 245001	 7x 4142865	 2x 6056234	 1x 4548180	 2x 6133722	 2x 4227684
 1x 4298609	 2x 6100932	 3x 4560178	 1x 302221	 3x 6203937	 1x 4653822	 2x 4515368	 4x 302026
 2x 6174937	 1x 4288960	 2x 4561038	 1x 302021	 3x 6066102	 4x 4121715	 4x 362226	 1x 300126
 1x 300401	 2x 362301	 1x 416201	 1x 4244368	 4x 302426	 1x 4106552	 1x 6215342	 1x 6218939
 2x 302301	 3x 302101		 1x 4163306	 1x 4526110			



1x
4514845



2x
303026



4x
244526



3x
366626



3x
379526



1x
6215344



4x
4141089



1x
4120158



1x
6217992



2x
6030521



1x
6062601



2x
6120639



4x
6168647



2x
4542590



2x
6176433



1x
4211511



2x
4211475



3x
4278273



1x
6028812



1x
6194308



1x
6194414



1x
6116608



1x
4211396



3x
4211445



4x
6079461



1x
4490127



1x
4249891



2x
6215341



1x
4538252



1x
4211183



1x
6217940



1x
4252456



2x
4210719



1x
4211010



1x
6106283



2x
4211052



1x
4211088



5x
4211063



1x
4211094



3x
4211043



1x
4211100



1x
4211008



2x
4646865



1x
4107623



1x
6047056



1x
6217936



1x
6217941



1x
6162427



1x
6217991



1x
6217993



1x
6218740



1x
4568934



1x
6218268

Customer Service

Kundenservice

Service Consommateurs

Servicio Al Consumidor

LEGO.com/service or dial



: 00800 5346 5555

: 1-800-422-5346

SHARE YOUR IDEA
TEILE DEINE IDEE
PARTAGE TON IDÉE
CONDIVIDI LA TUA IDEA
COMPARTE TU IDEA
PARTILHA A TUA IDEIA
TEDD KÖZZÉ AZ ÖTLETED
分享您的观点



LEGO® REVIEW
LEGO® PRÜFUNG
EXAMEN PAR LEGO®
REVIEW LEGO®
REVISIÓN DE LEGO®
AVALIAÇÃO LEGO®
LEGO® VÉLEMÉNYEZÉS
乐高®评论



GATHER SUPPORT
HOL' DIR UNTERSTÜTZUNG
RASSEMBLE DES VOTES
CHIEDI DI ESSERE SUPPORTATO
GANA APOYOS
OBTÉM APOIO
SZEREZZ TÁMOGATÁST
获得更多支持



NEW LEGO® PRODUCT
NEUES LEGO® PRODUKT
NOUVEAU PRODUIT LEGO®
NUOVO PRODOTTO LEGO®
NUEVO PRODUCTO LEGO®
NOVO PRODUTO LEGO®
ÚJ LEGO® TERMÉK
新的乐高®产品



[LEGO.com/ideas](https://www.lego.com/ideas)

LEGO and the LEGO logo are trademarks of the LEGO Group. ©2017 The LEGO Group.

Do you like this LEGO® Ideas Set?

The LEGO® Group would like your opinion on the new product you have just purchased. Your feedback will help shape the future development of this product series.

Please visit:

[LEGO.com/productsurvey](https://www.lego.com/productsurvey)

By completing our short feedback survey, you will be automatically entered into a drawing to win a LEGO® prize.

See website for official rules and details. Open to all countries where not prohibited.

