

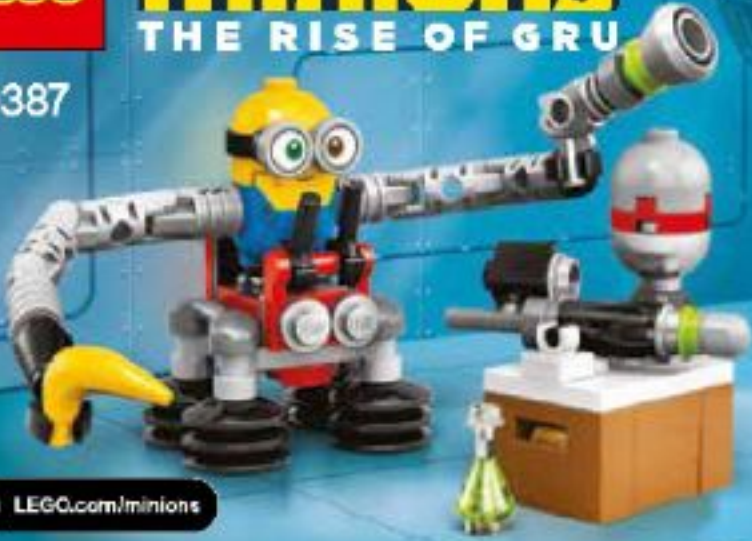

ILLUMINATION PRESENTS
MINIONS
THE RISE OF GRU

30387



LEGO.com/minions

6324227



ILLUMINATION PRESENTS
MINIONS
THE RISE OF GRU

1



2

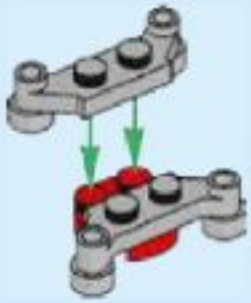

3

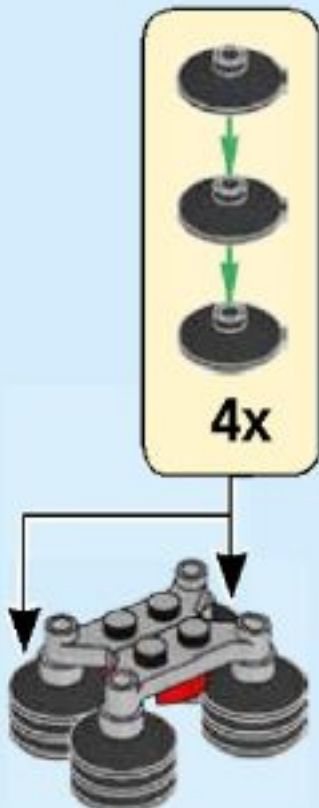

4



5

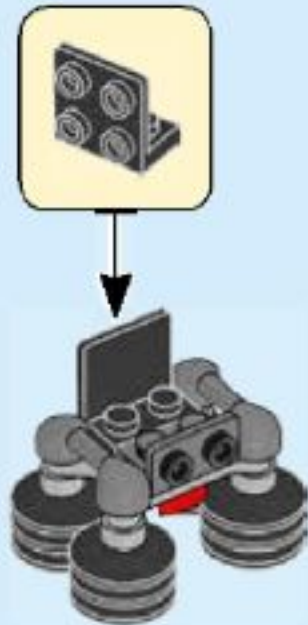

6



7

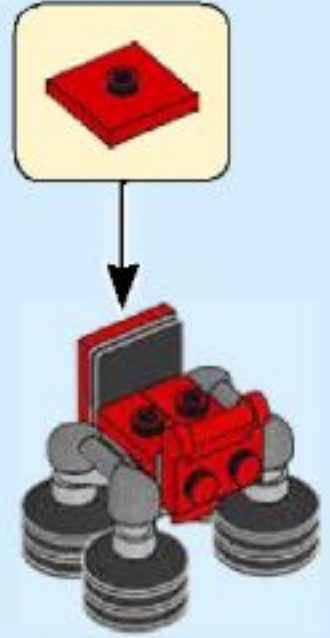

8

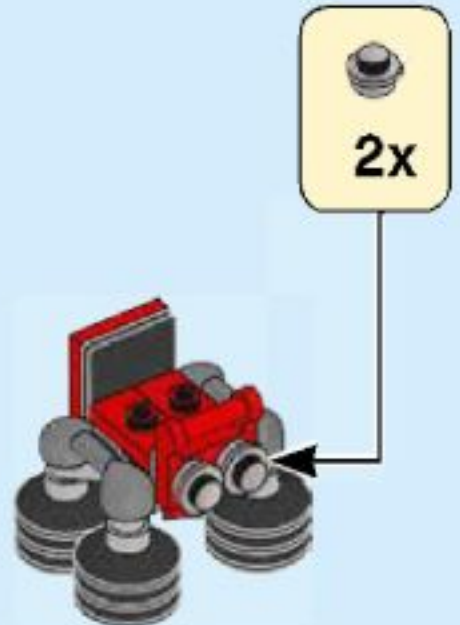

9

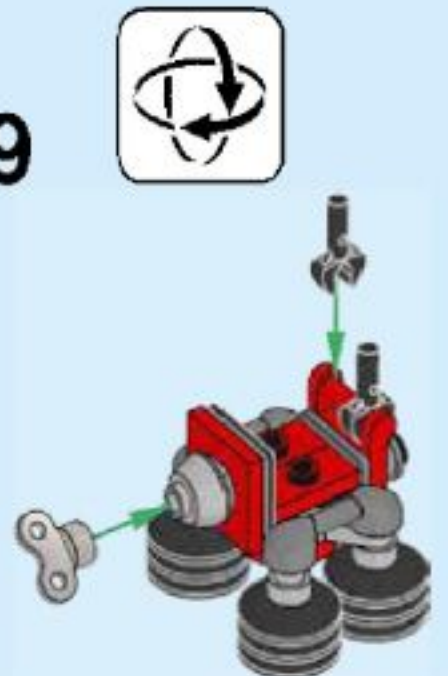

1



2

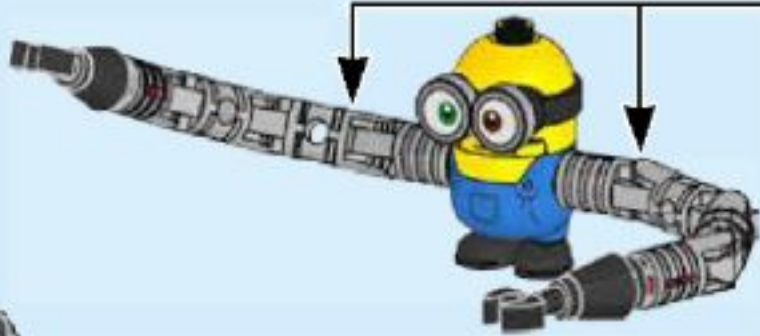

3

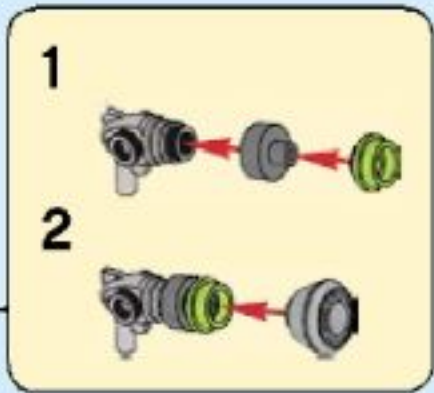
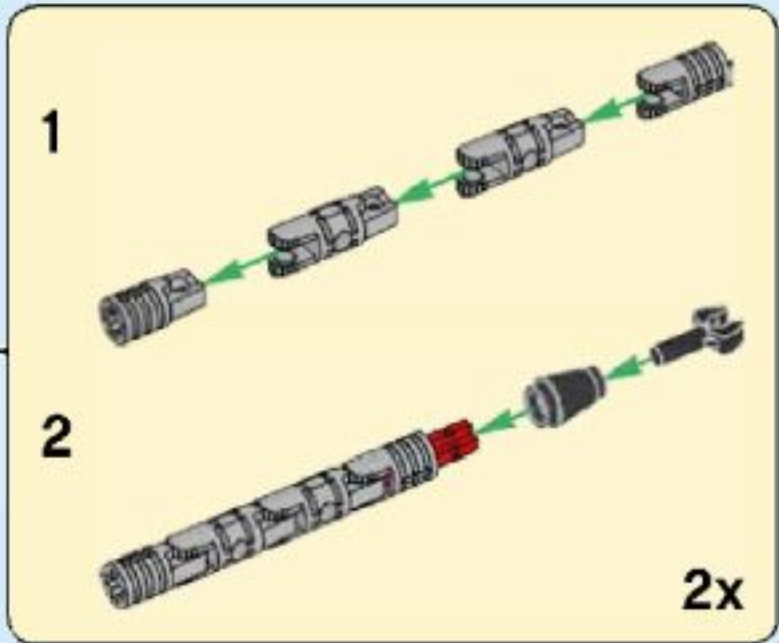

1

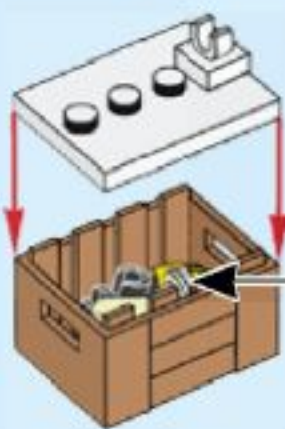

2

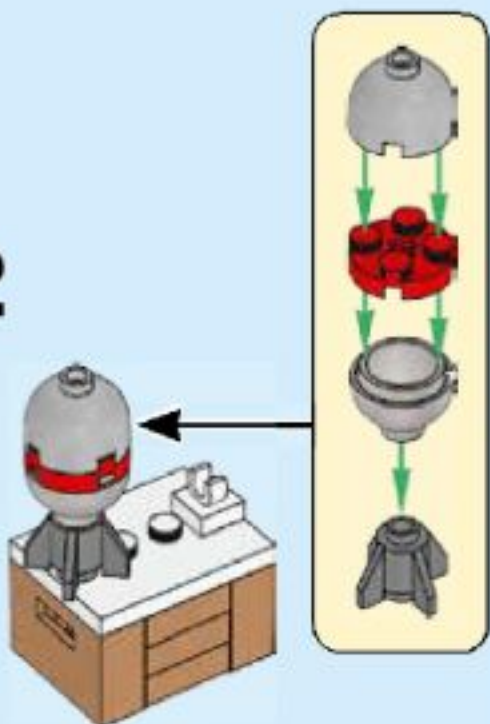

LEGO.com/service

LEGO and the LEGO logo are trademarks of the LEGO Group. ©2020 The LEGO Group.

6324227

3



4

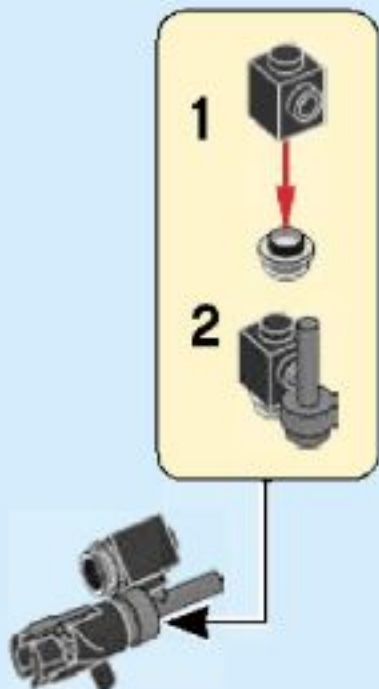

© Universal City Studios LLC. All Rights Reserved.

5

