

# HIDDEN SIDE



70433



1



2



3



4



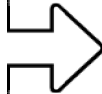
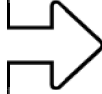





# HIDDEN SIDE™

## FREE INTERACTIVE APP

Kostenlose interaktive App  
 Appli interactiva gratuita  
 App interattiva gratuita  
 App interactiva gratis  
 App interactiva gr tis  
 Ingyenes interakt v alkalmaz s  
 Bezmaksas interakt va lietotne  
 免费交互式应用程序



LEGO® Hidden Side™  
[LEGO.com/devicecheck](http://LEGO.com/devicecheck)

Check for compatibility  
 Kompatibilit t pr fen  
 V rifier la compatibilit   
 Controlla la compatibilit   
 Comprueba tu compatibilidad  
 Verificar a compatibilidade  
 Ellen rizz a kompatibilit st  
 P rbaud t saderibu  
 检查兼容性

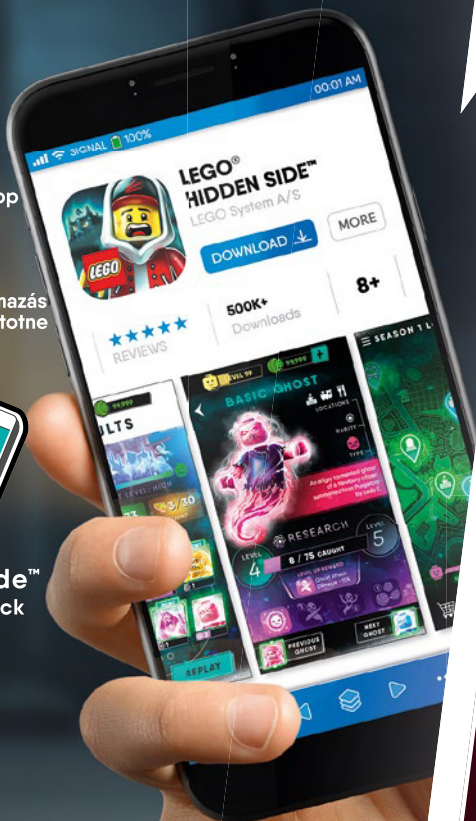

## Play in a well-lit area.

Spieler in einem gut beleuchteten Bereich.  
 Joue dans un endroit bien  clair .  
 Posiziona il set in un'area ben illuminata.  
 Juega en un  rea bien iluminada.  
 Joga numa  rea bem iluminada.  
 J tssz j l megvil gított ter leten!  
 Rotal jies labi apgaismot  zon .  
 请在光线充足的地方玩乐。

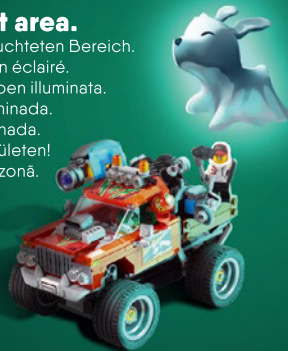

## Play on a clean, flat surface.

Spieler auf einer sauberen und ebenen Oberfl che.  
 Joue sur une surface propre et plane.  
 Posiziona il set su una superficie pulita e piana.  
 Juega sobre una superficie lisa y despejada.  
 Joga sobre uma superf cie plana e limpa.  
 J tssz tiszta, sik fel leten!  
 Rotal jies uz t ras, lidzenas virsmas.  
 请在干净平整的表面上玩乐。

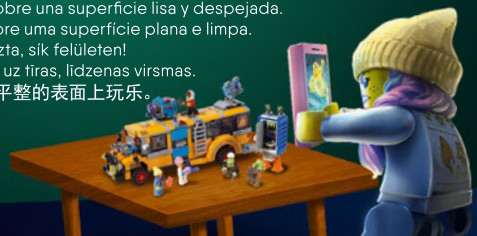

## Avoid patterned and reflective surfaces.

Vermeide gemusterte und spiegelnde Oberfl chen.  
  vite les surfaces   motifs et r fl chissantes.  
 Evita superficies riflettenti, con disegni o motivi.  
 Evita las superficies decoradas con patrones y reflectantes.  
 Evita superficies refletoras e com motivos decorativos.  
 Ker rd a mint s  s visszat kr z d  fel leteket!  
 Neizmant  virsmas ar rakstu vai atstarojo sas virsmas.  
 避免使用带图案和可反光的表面。



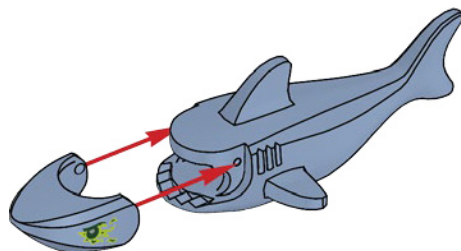
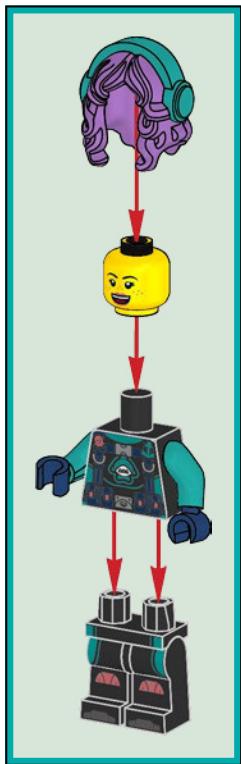

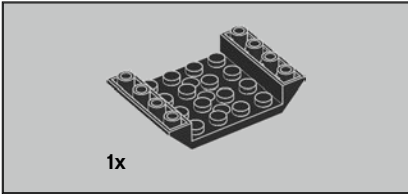
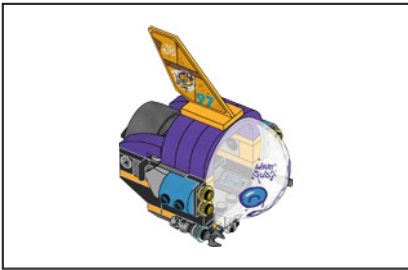

**1**

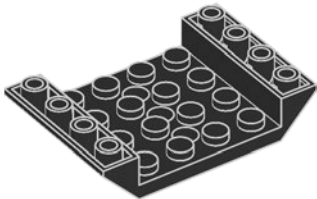

**2**

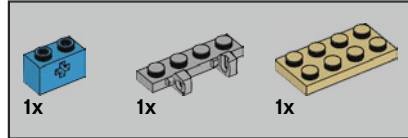
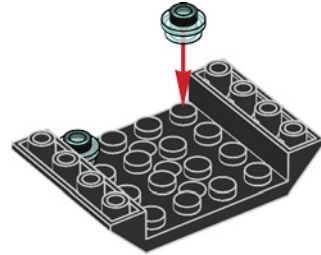

**3**

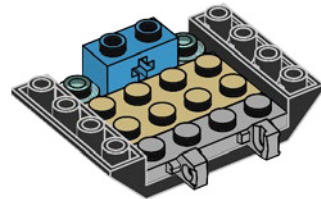

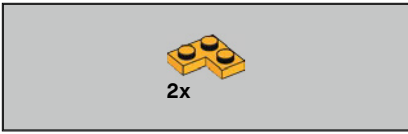

4

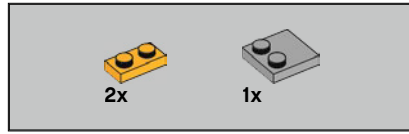
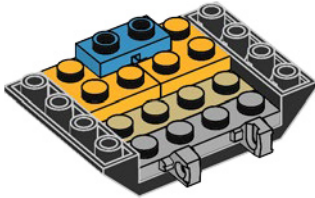

5

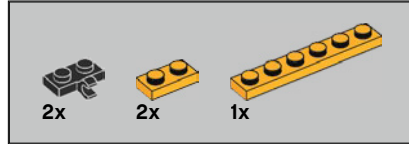
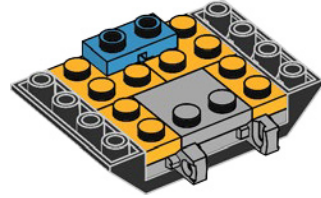

6

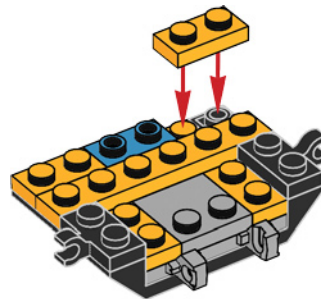



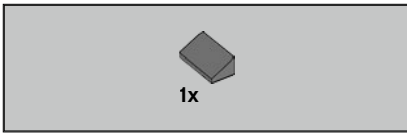

7

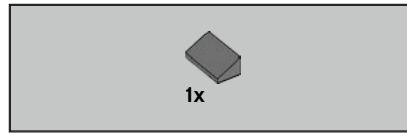
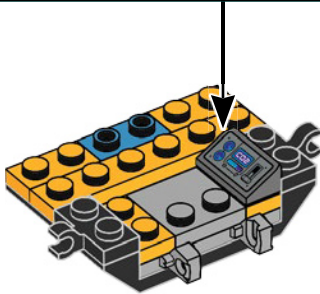

8

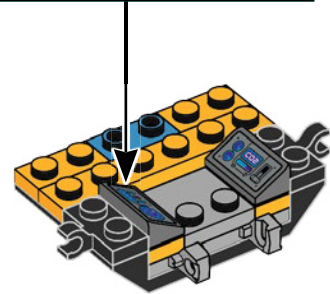
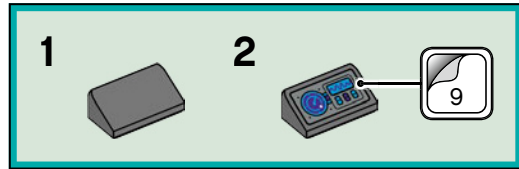

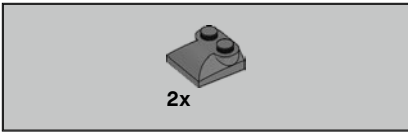

9

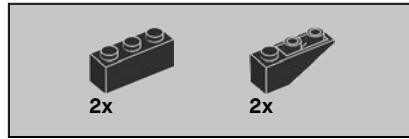

10

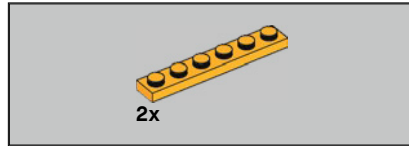
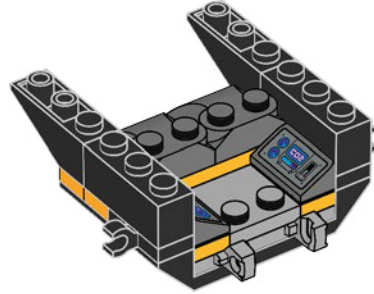

11

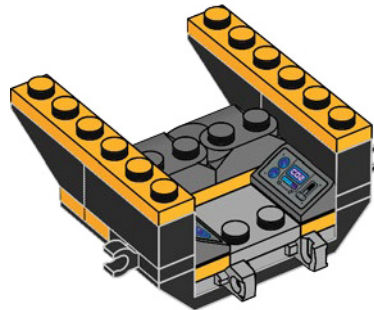

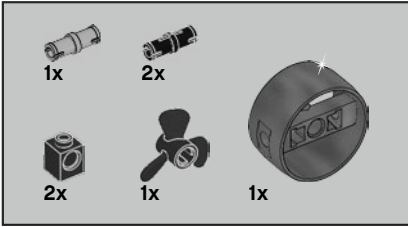
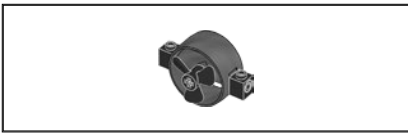

**12**

**1**



**2**

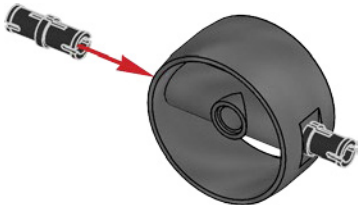

**3**

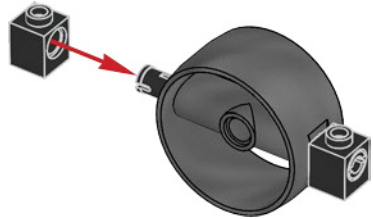

**4**

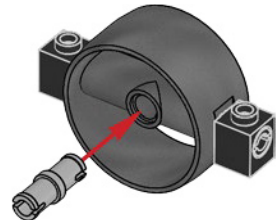

5

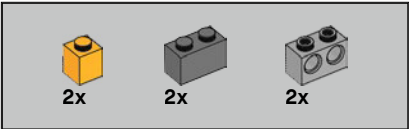
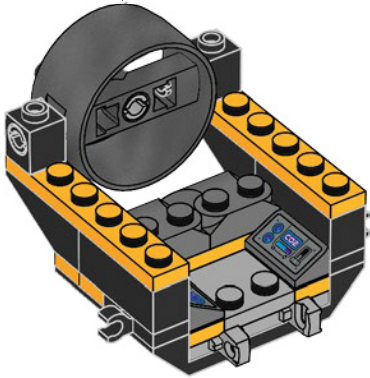
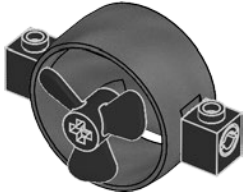

13

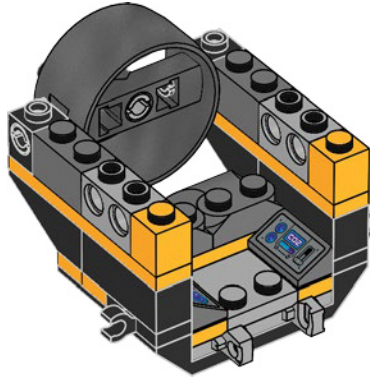

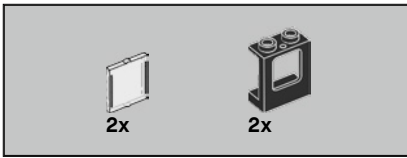

14

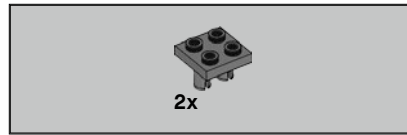
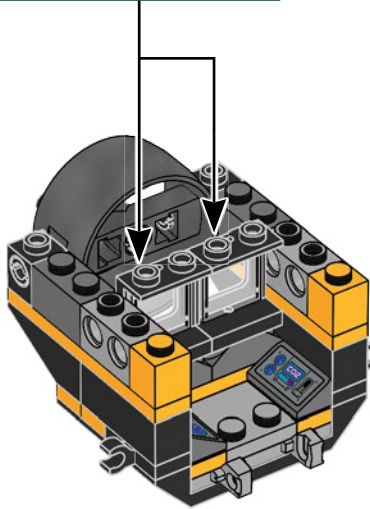
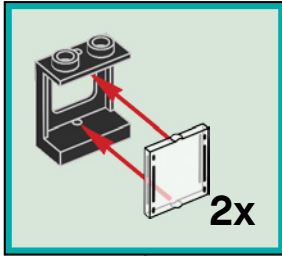

15

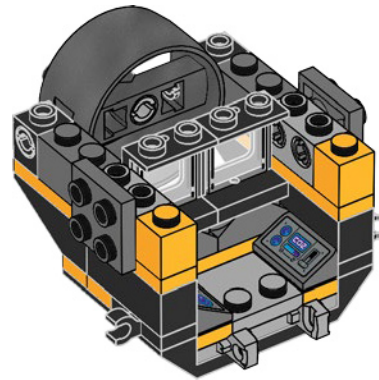

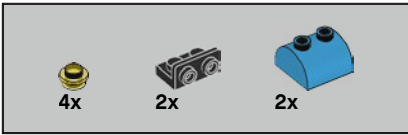

16

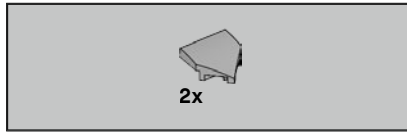
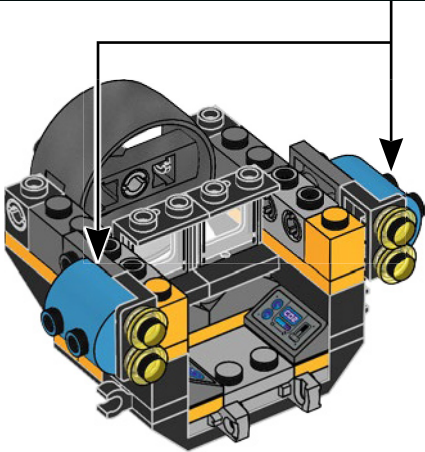
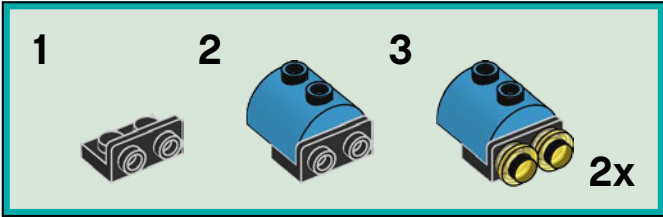

17

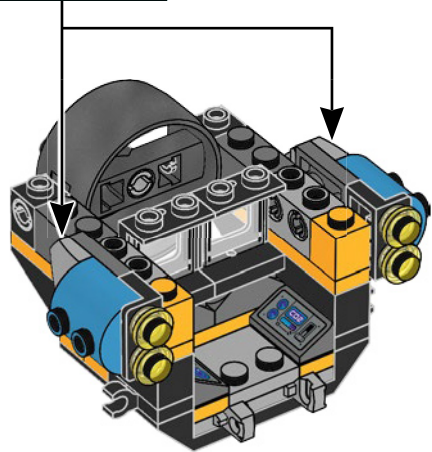

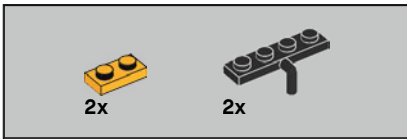

18

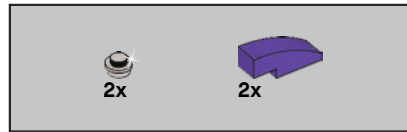
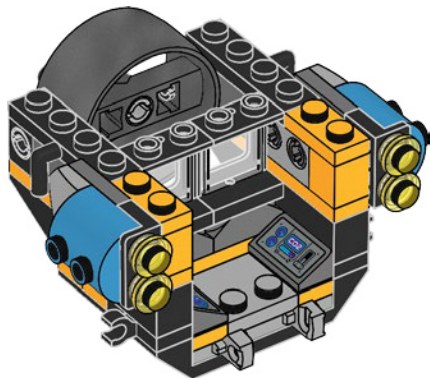

19

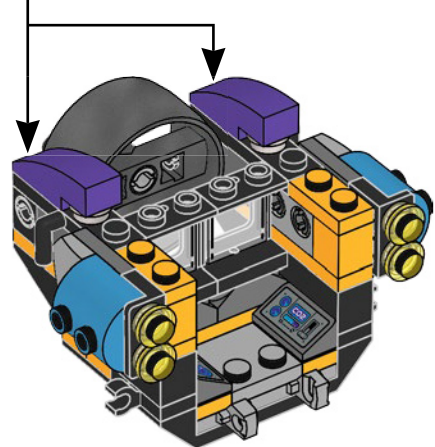
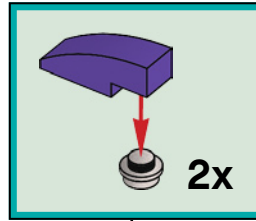

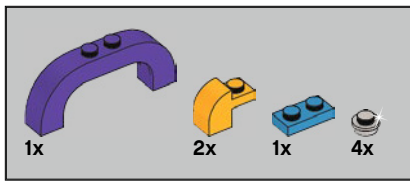

20

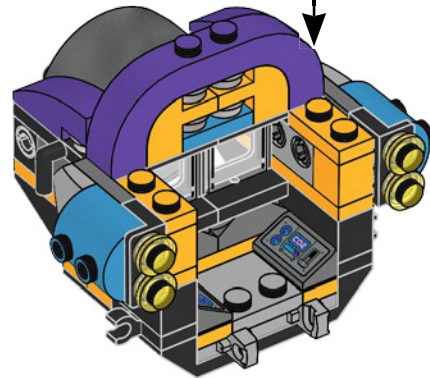
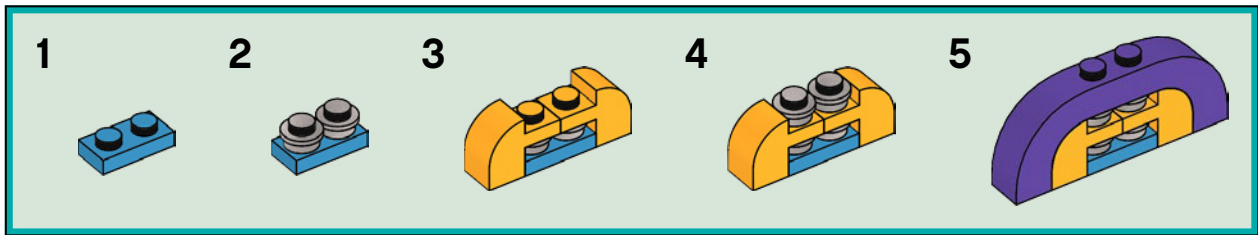



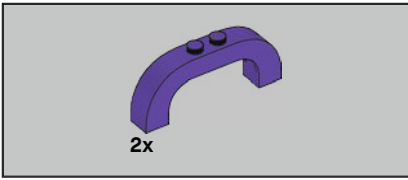

21

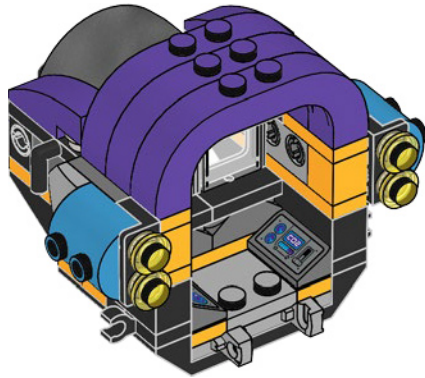





23

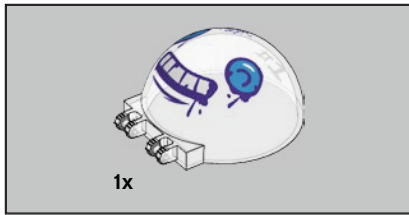
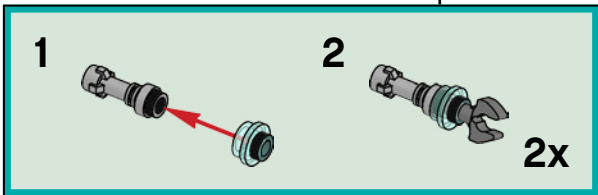
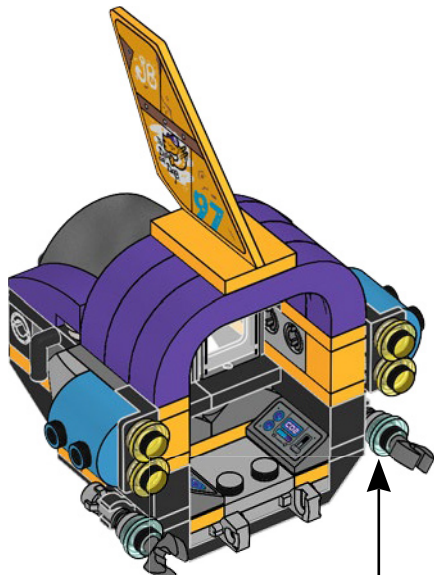

24

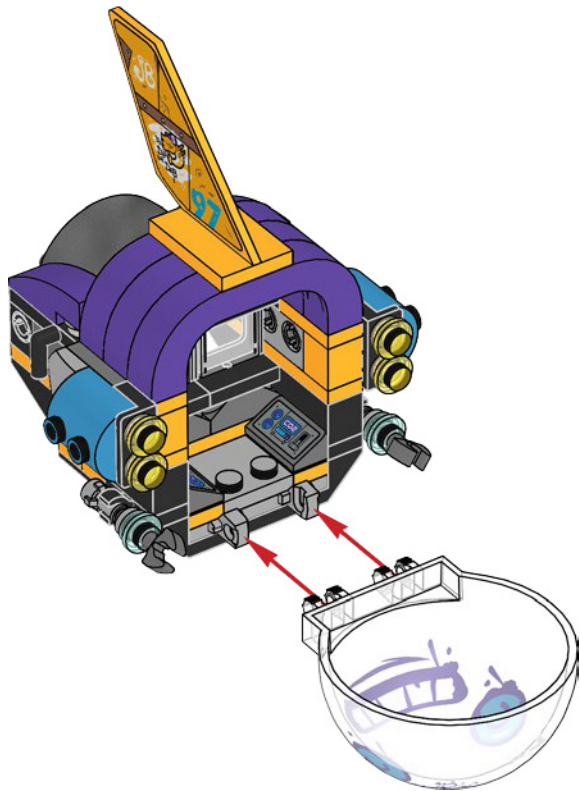

25

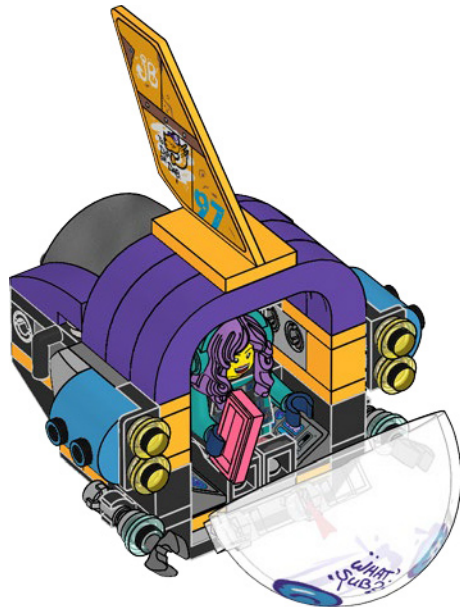

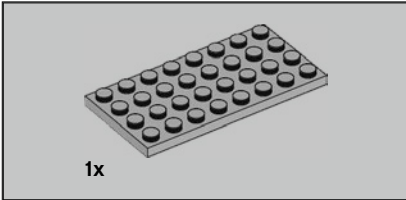
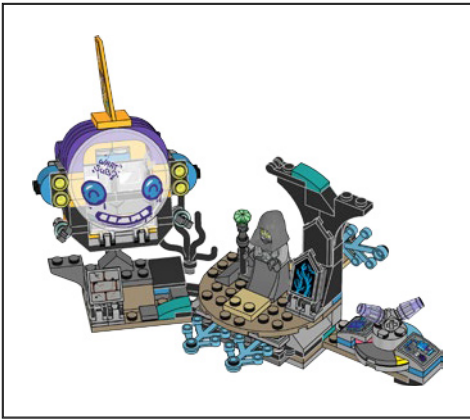

**26**

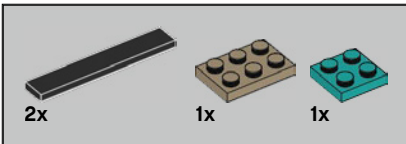
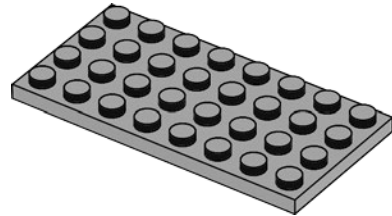

**27**

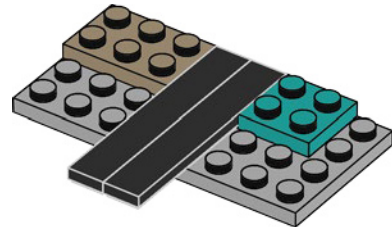

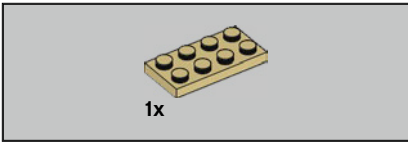

28

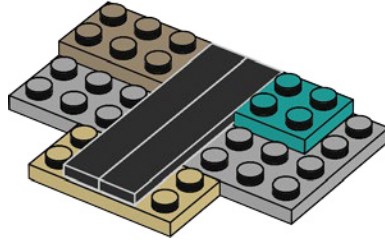

29

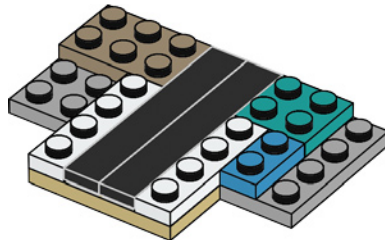

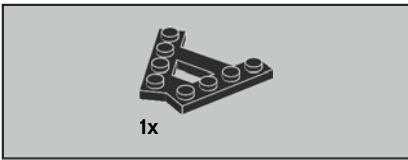

30

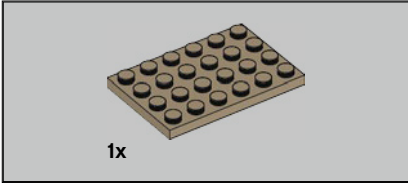
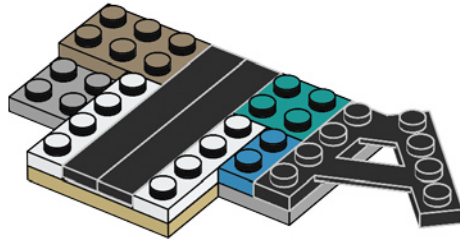

31

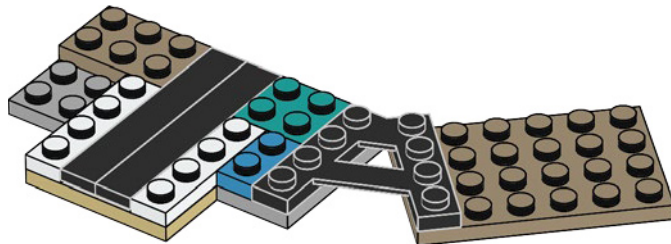

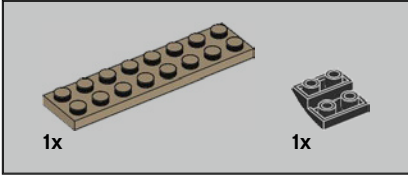
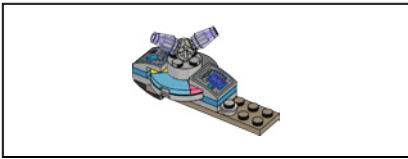

**32**

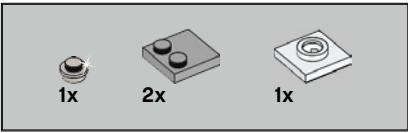
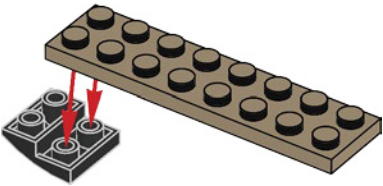

**33**

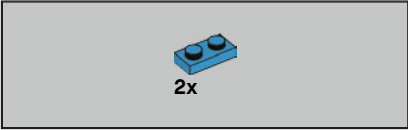
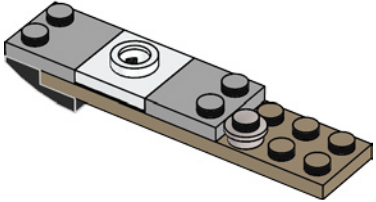

**34**

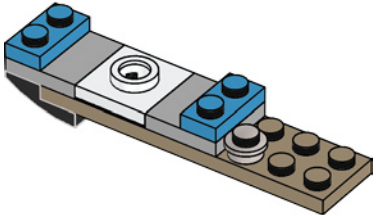



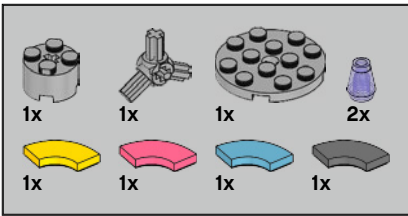

35

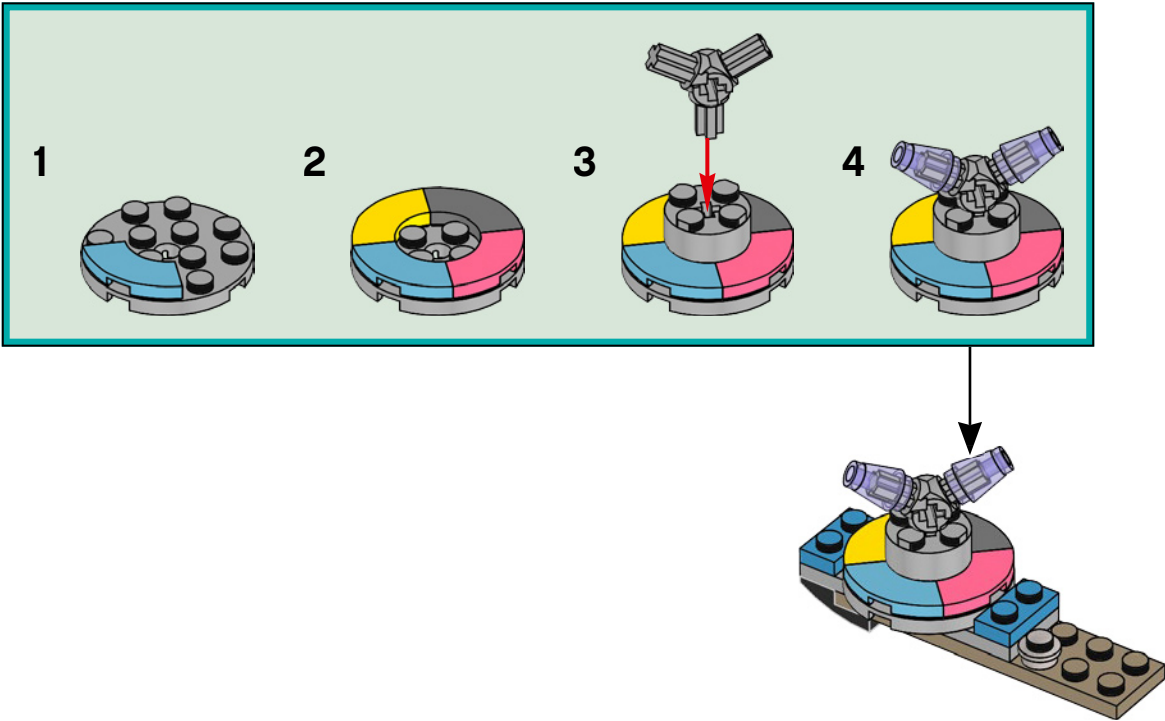

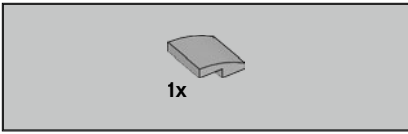

36

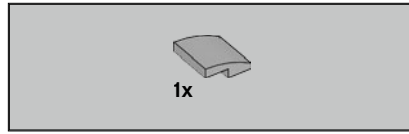
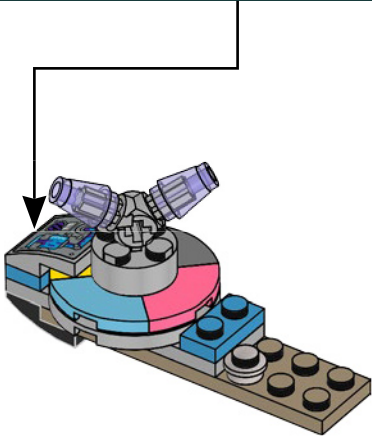
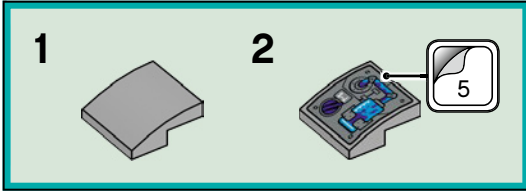

37

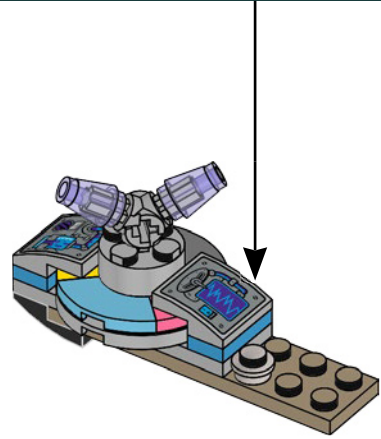
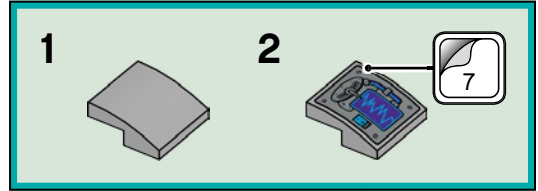

38

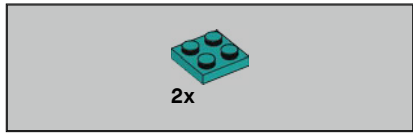
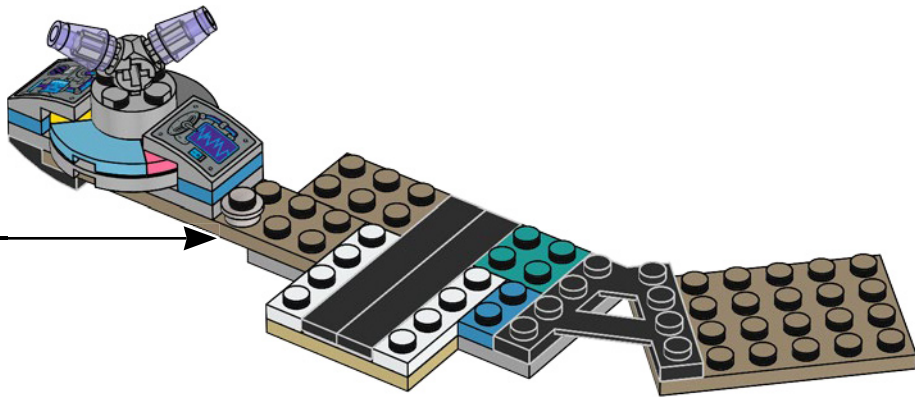

39

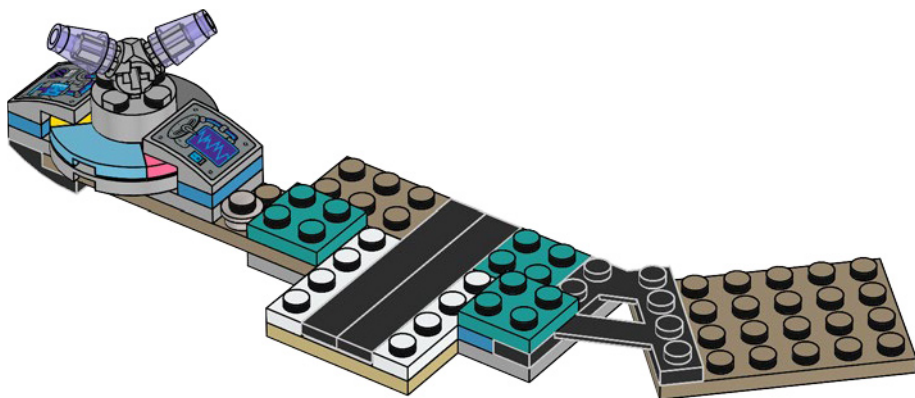

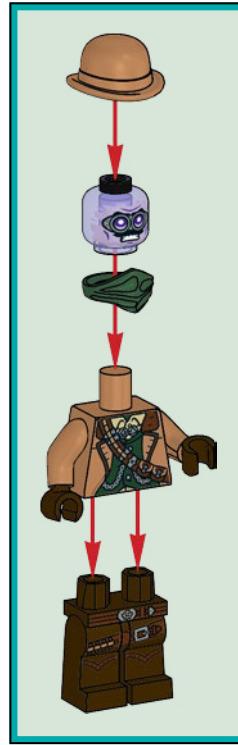
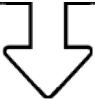



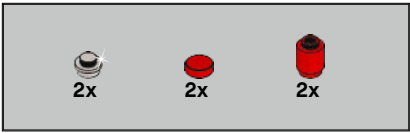

40

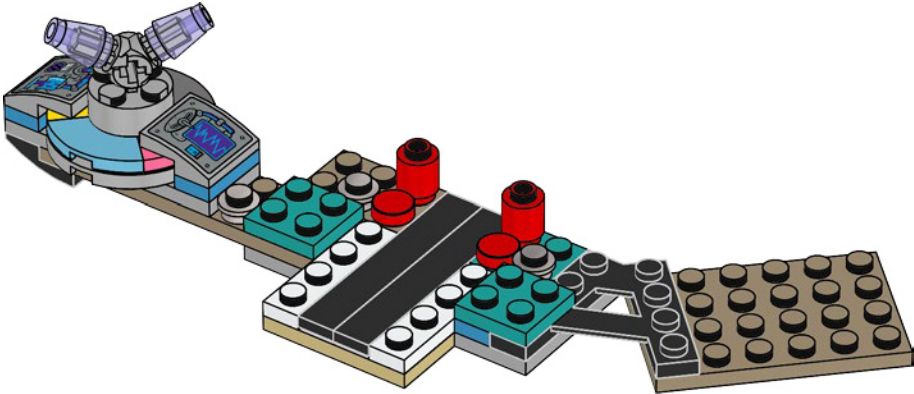

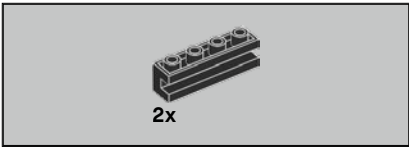

41

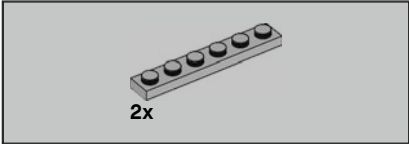
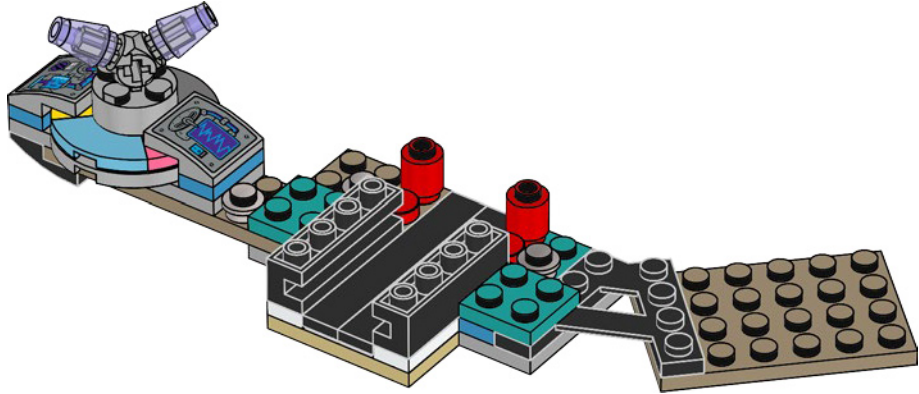

42

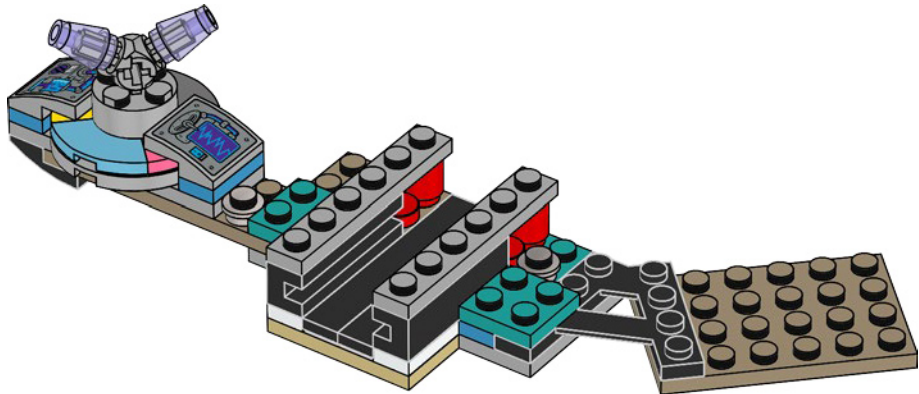

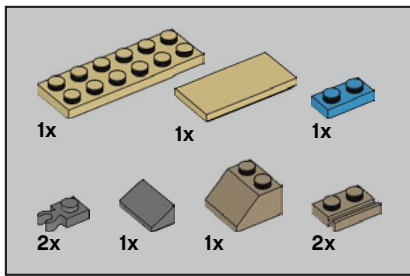

43

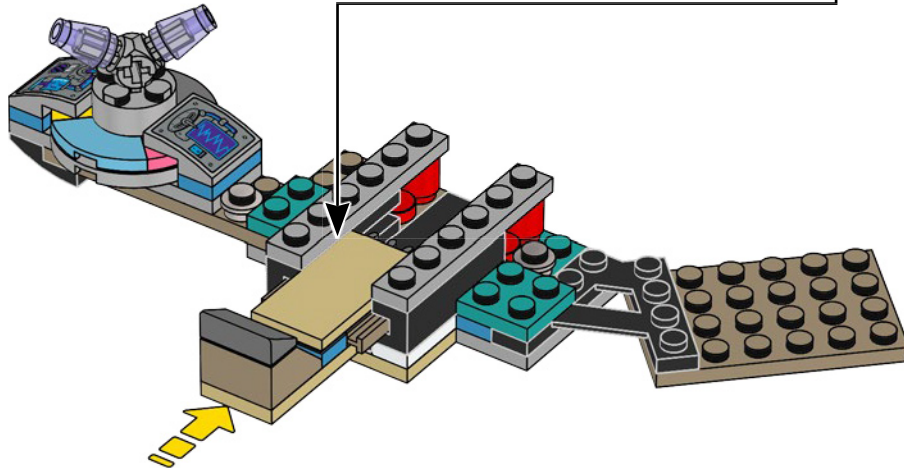
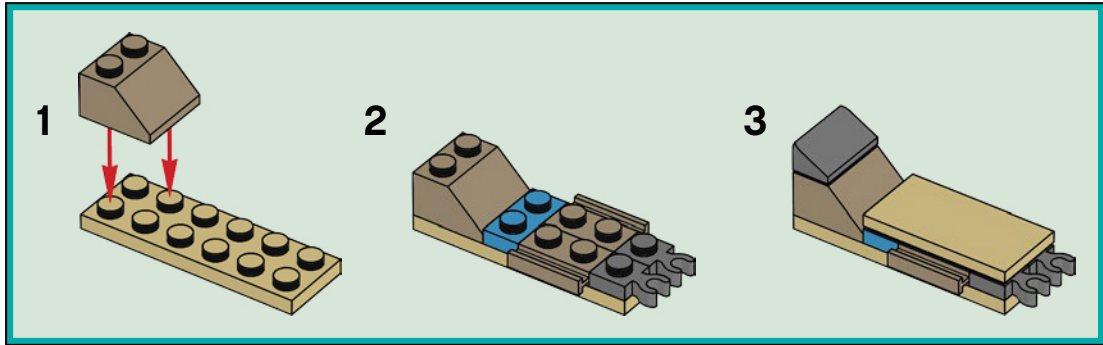



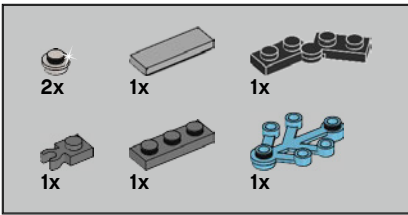

44

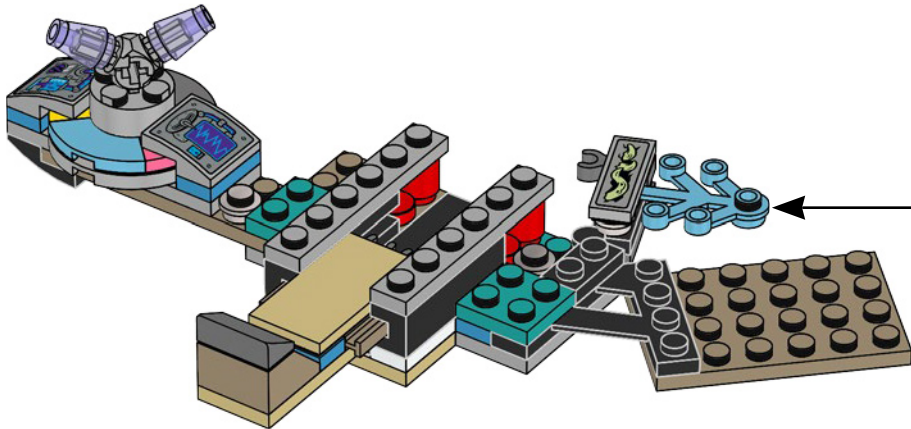
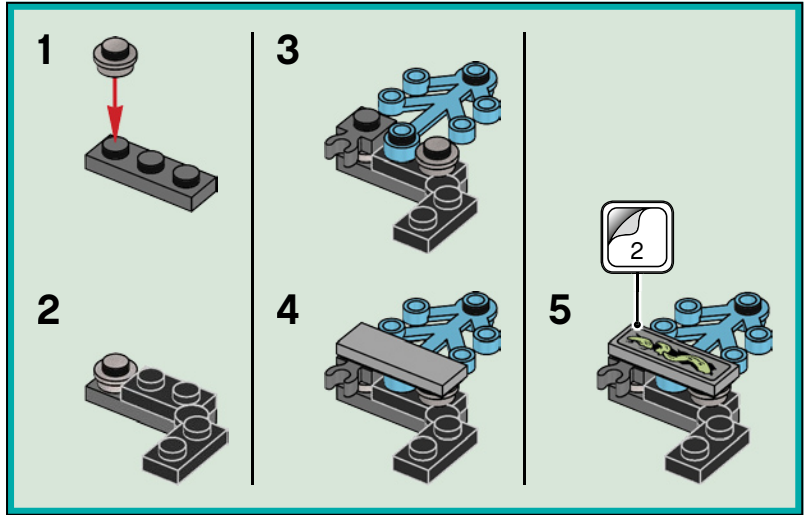

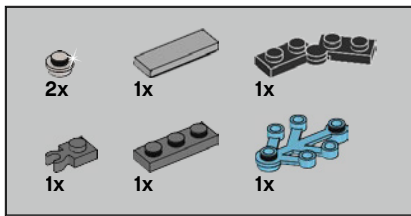

45

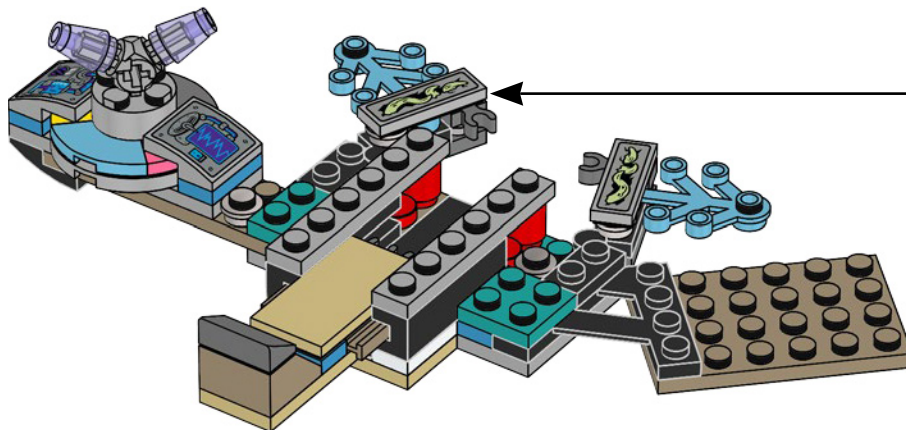
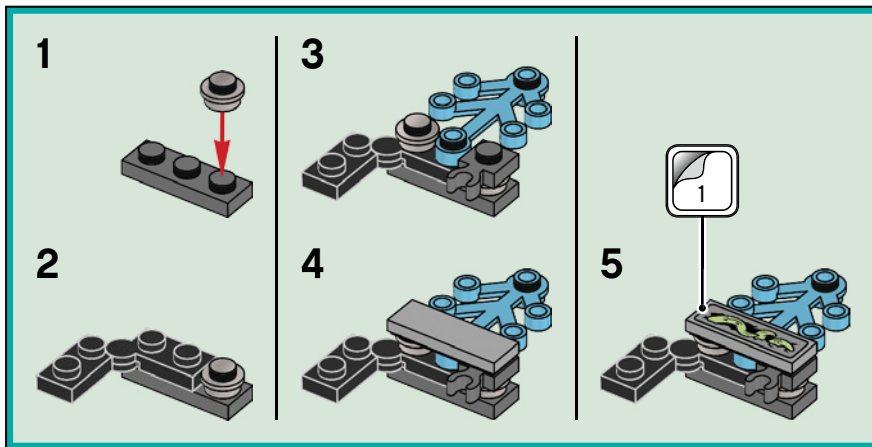

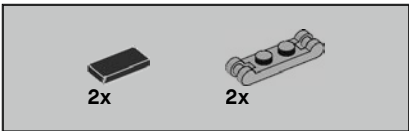

# 46

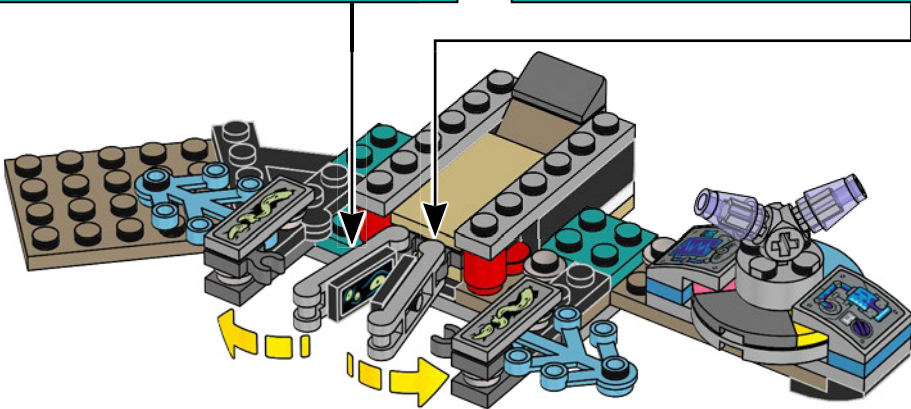
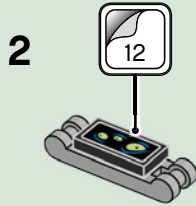
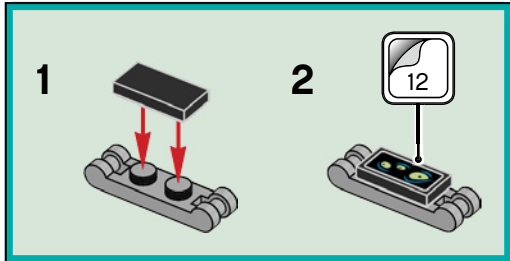
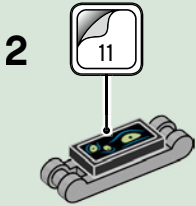
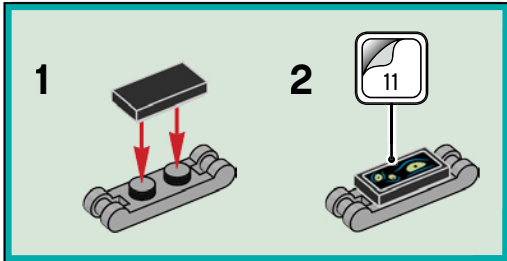

1

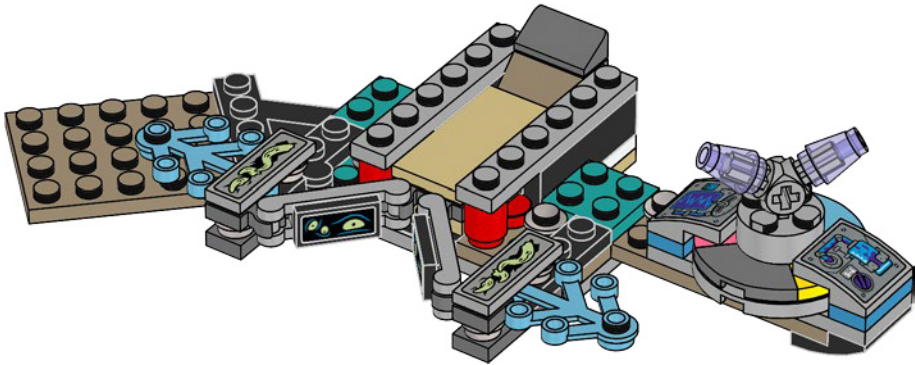

2

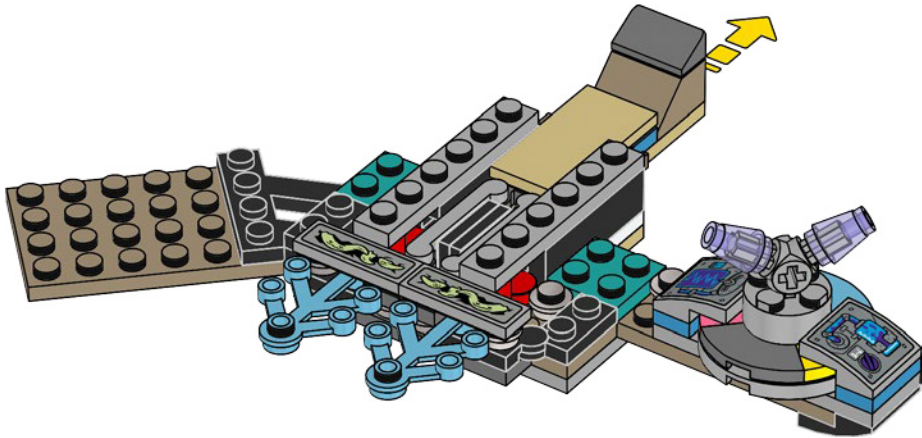

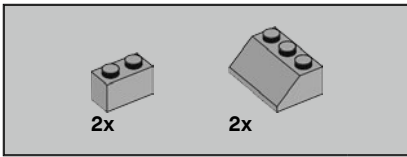

47

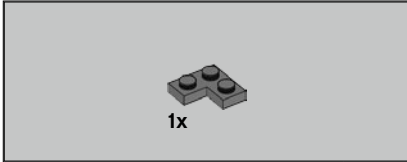
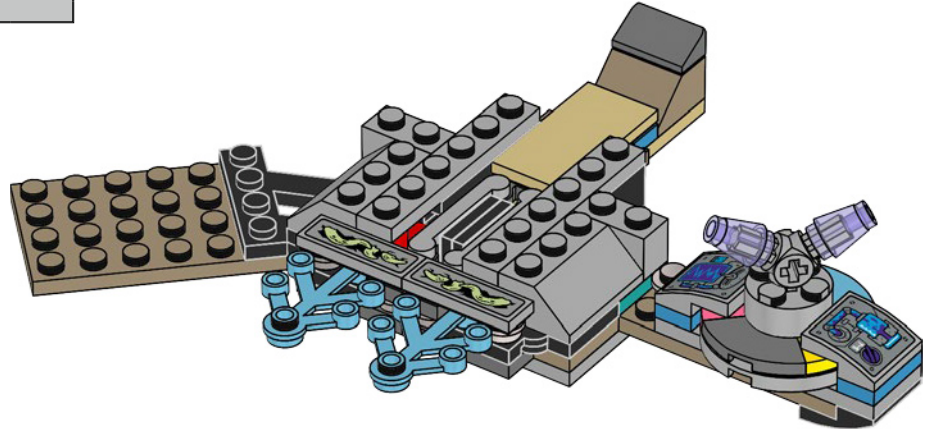

48

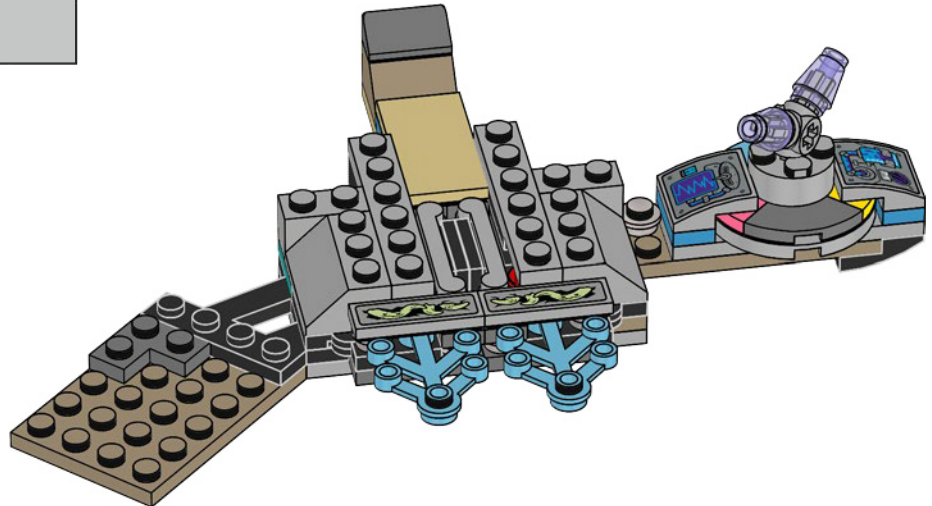

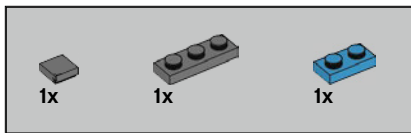

49

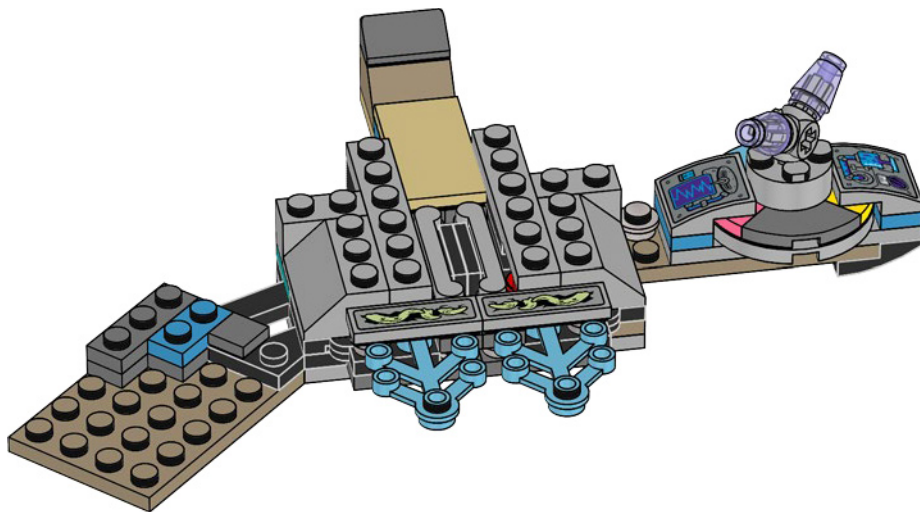

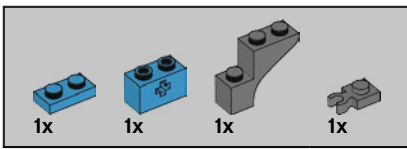

50

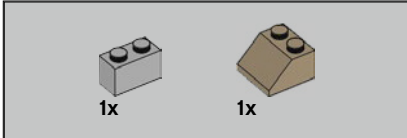
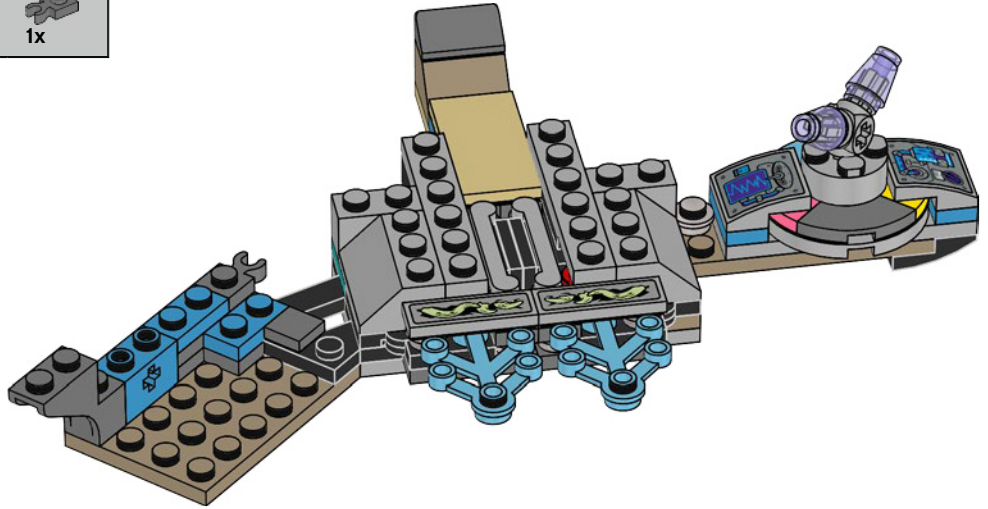

51

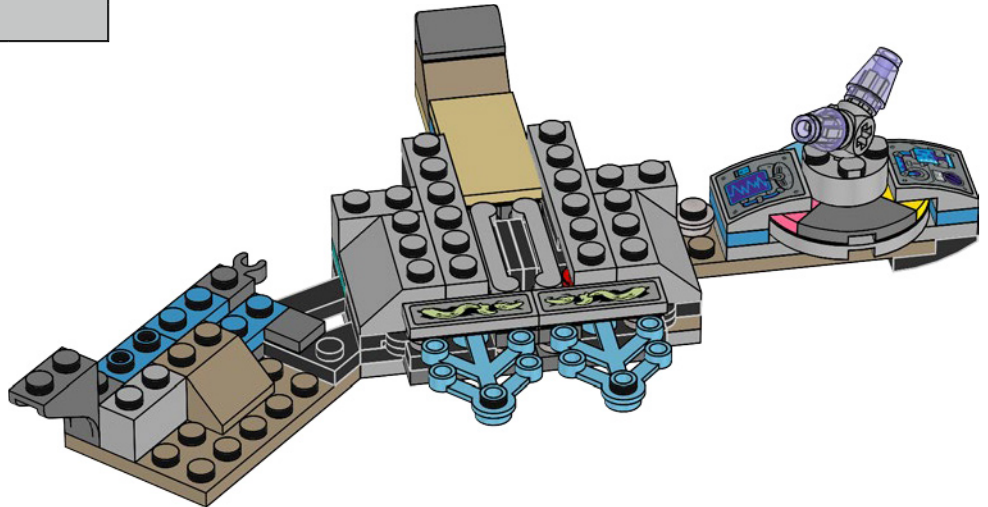

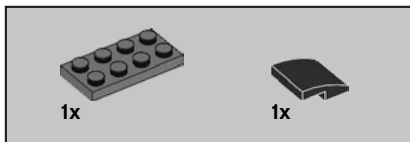

52

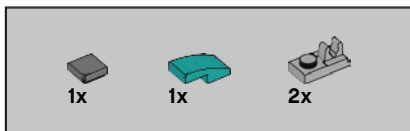
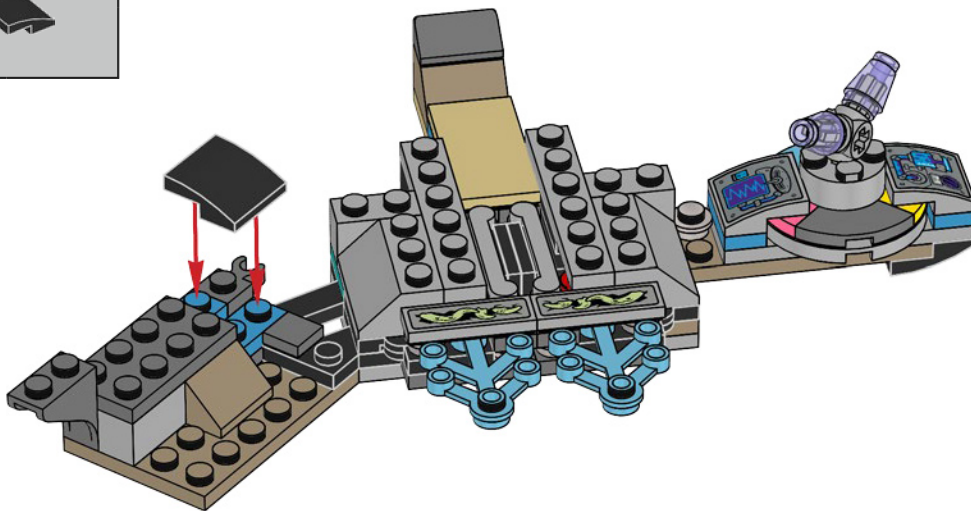

53

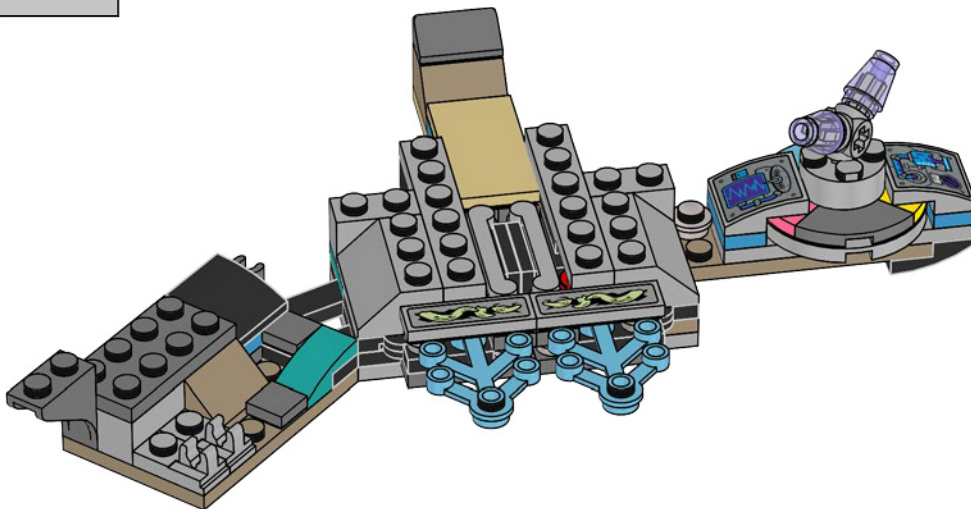



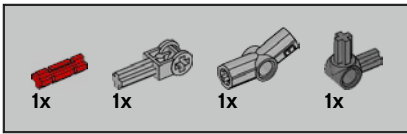

54

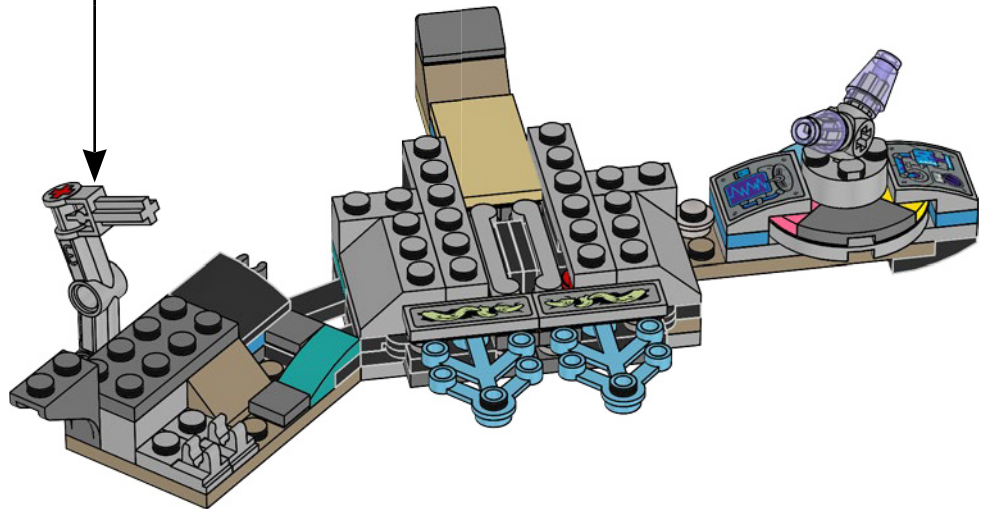
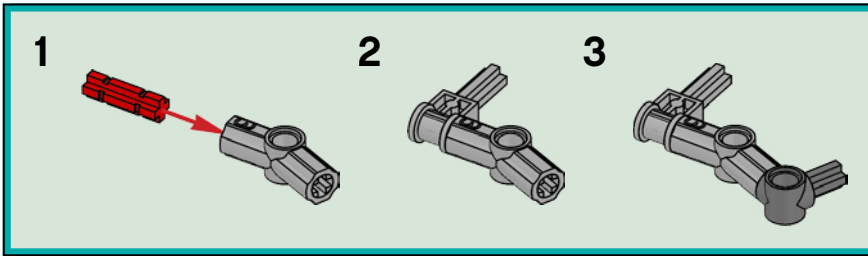
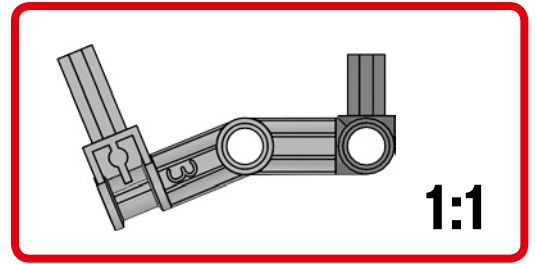

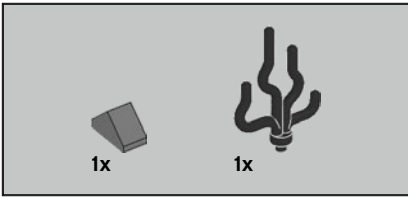

55

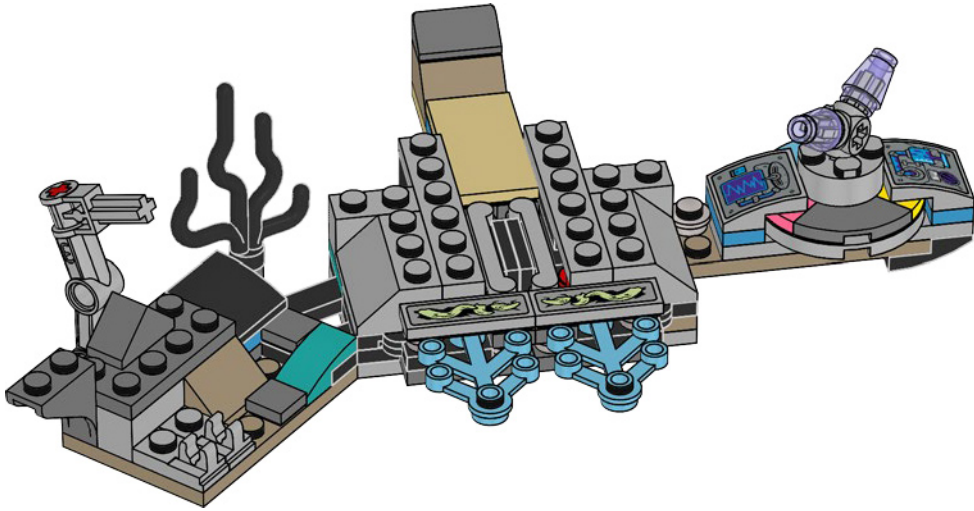

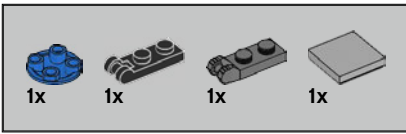

56

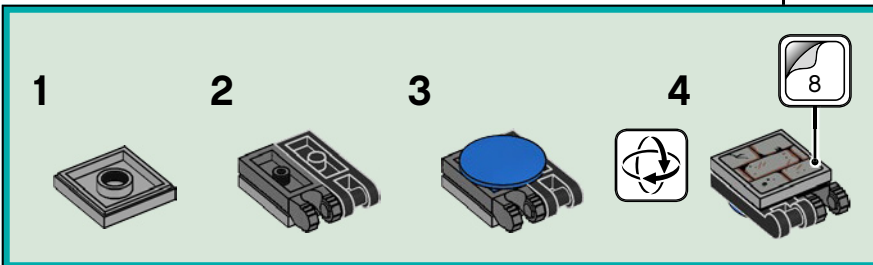
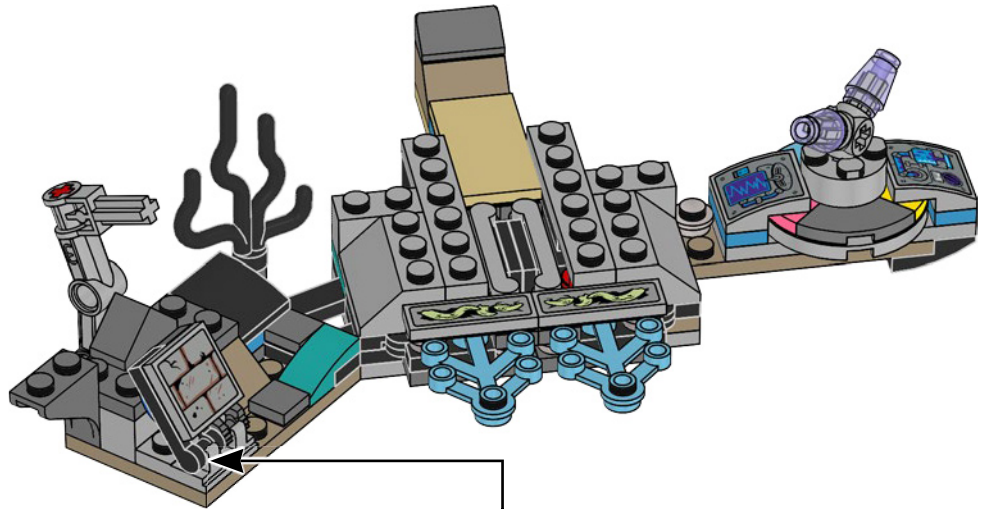

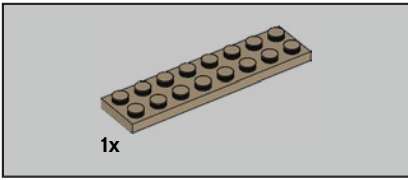

57

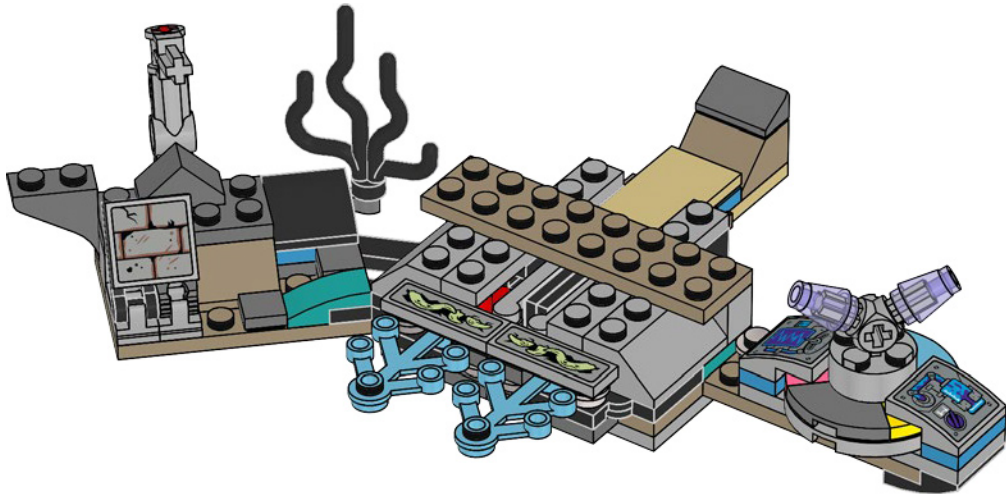



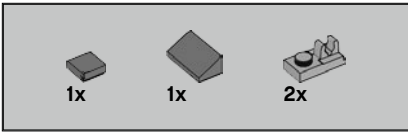

59

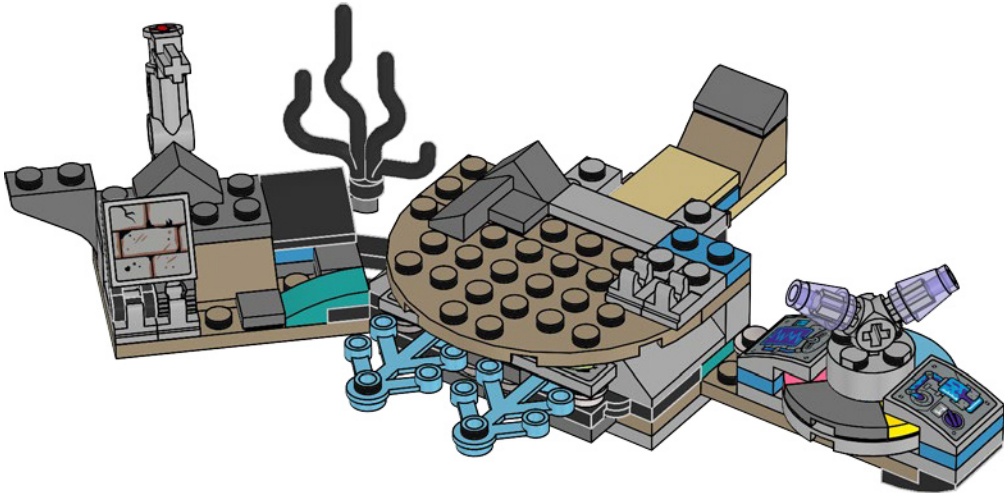

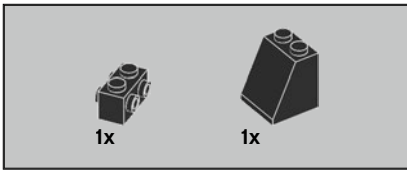

60

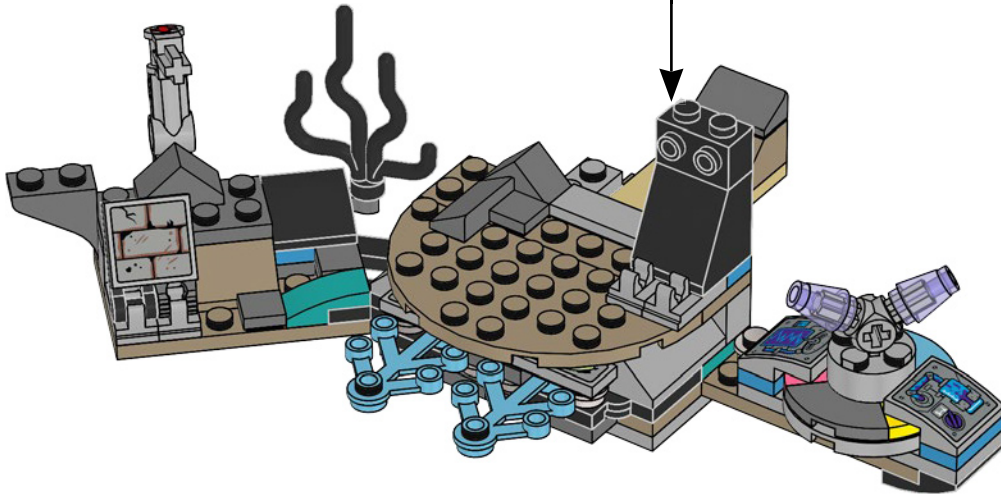
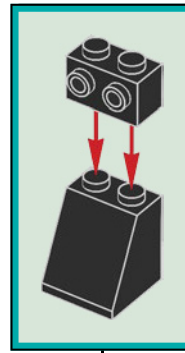

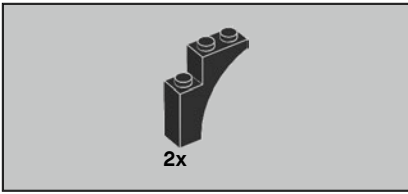

61

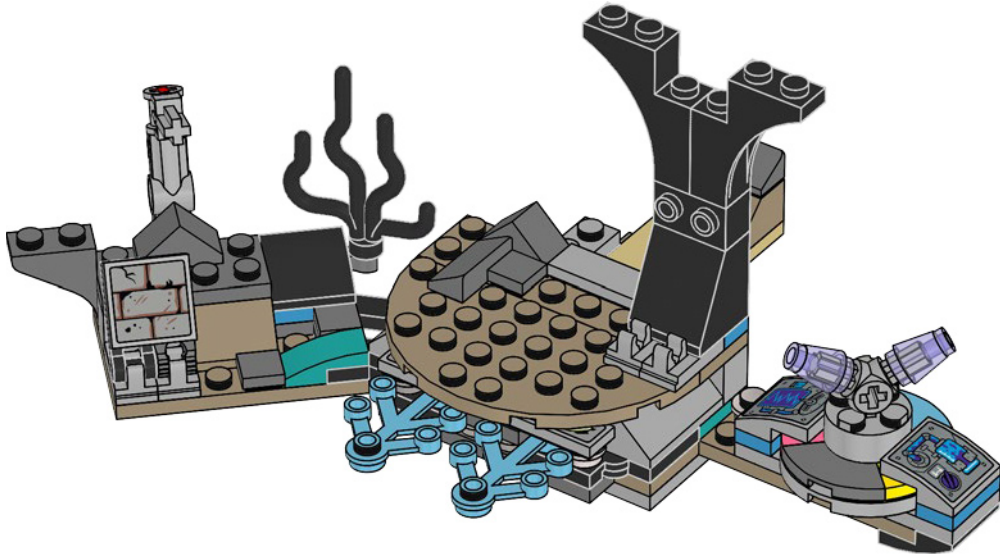





1x

62

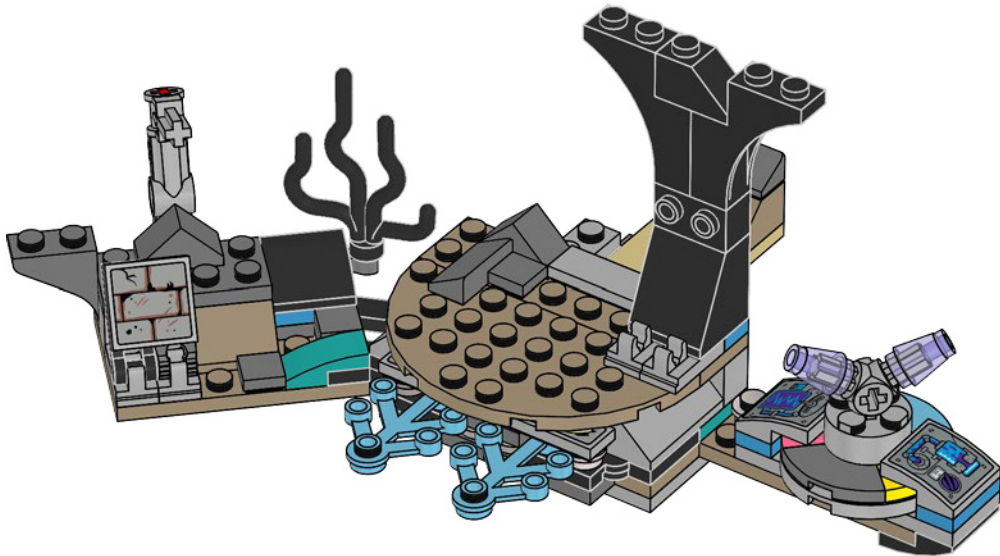

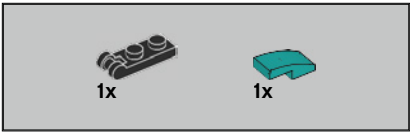

63

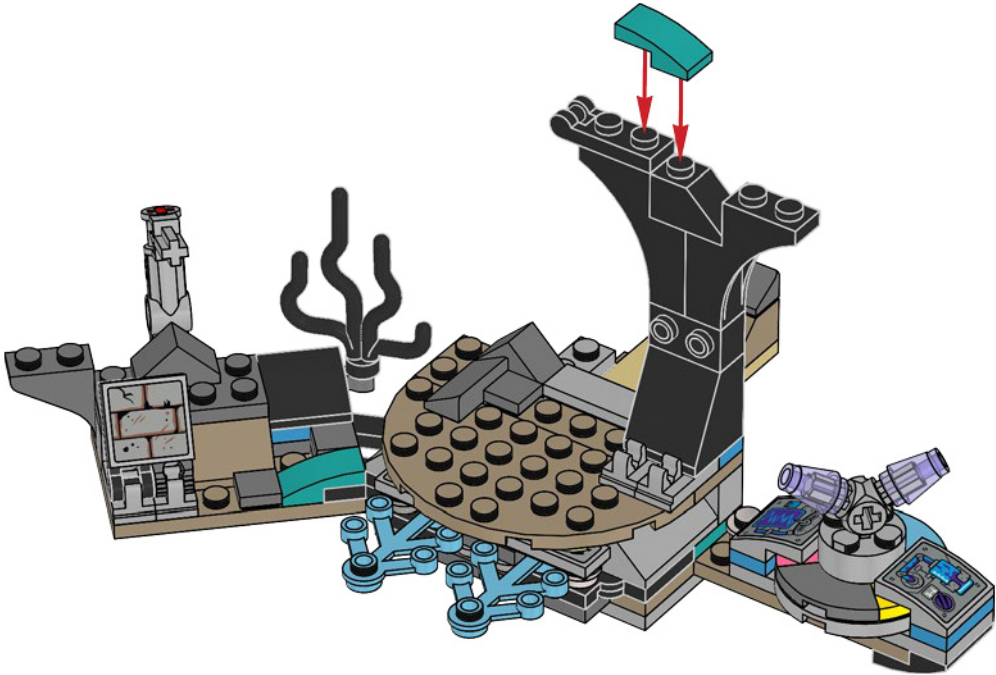

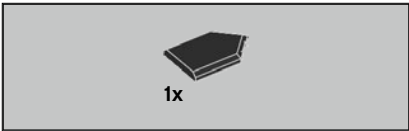

64

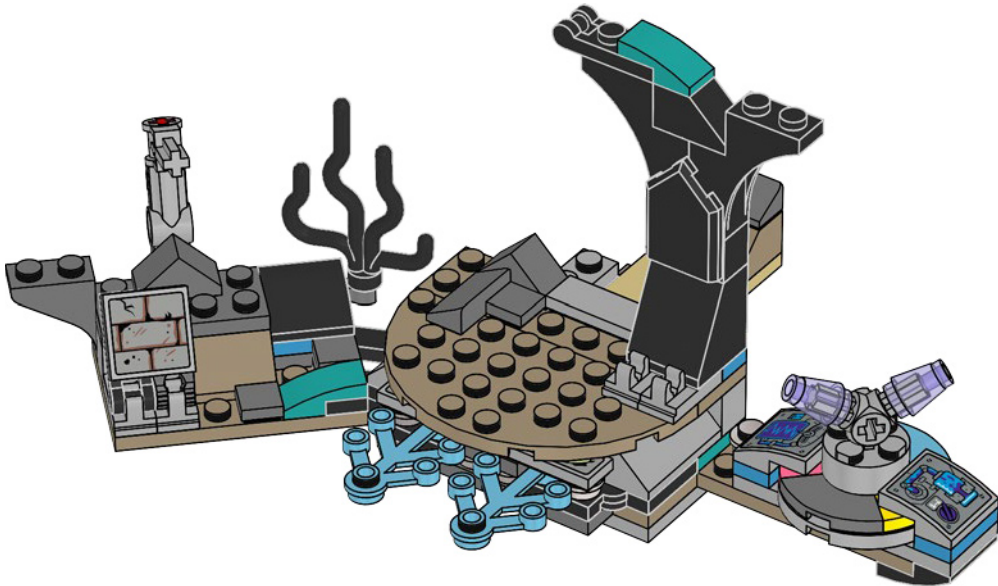

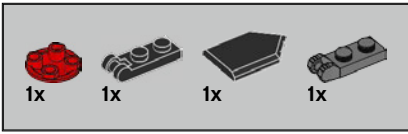

65

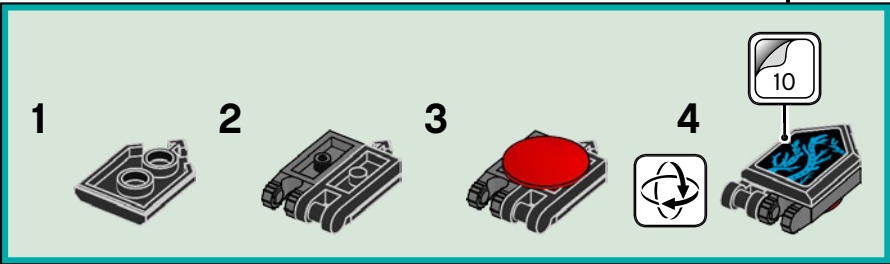
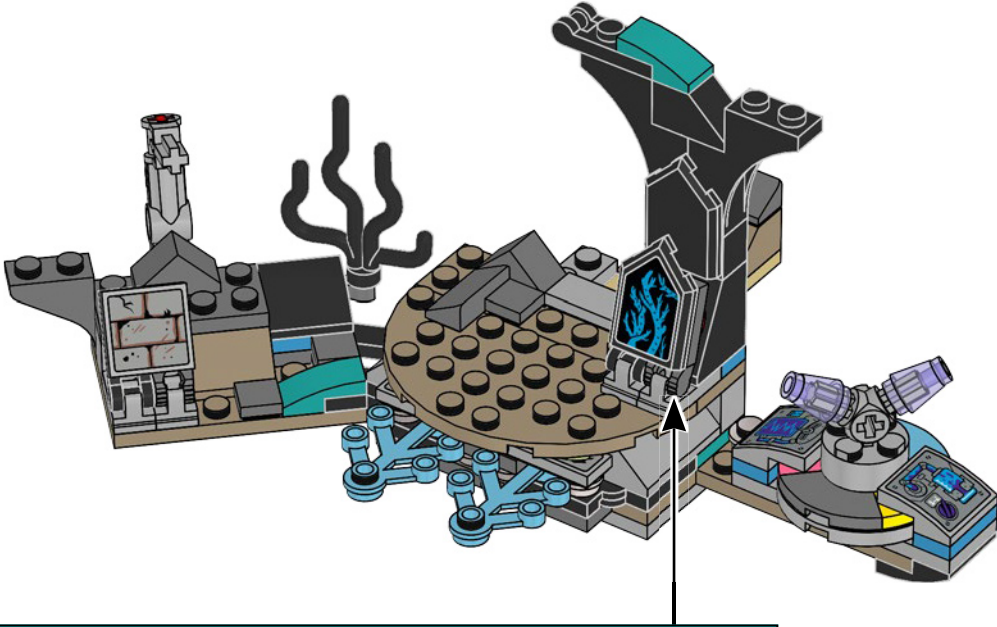

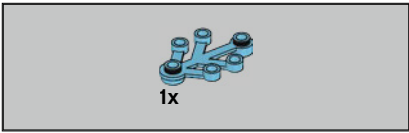

66

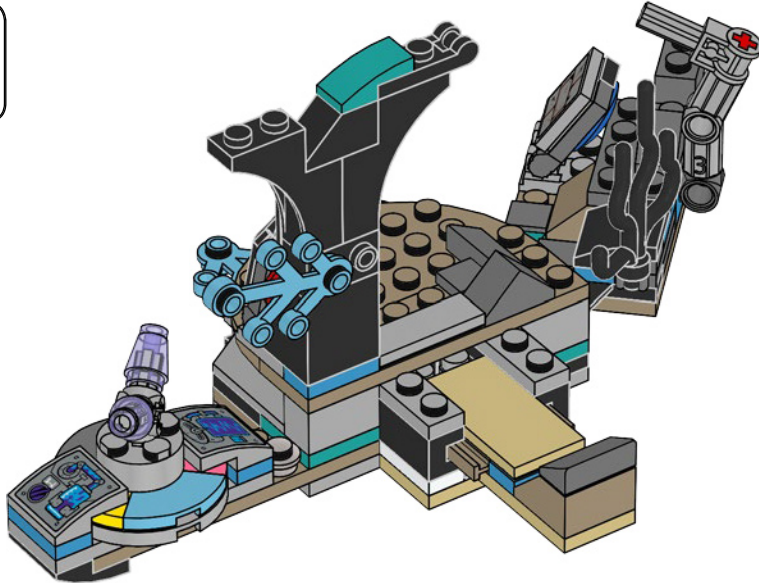

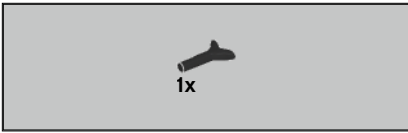

67

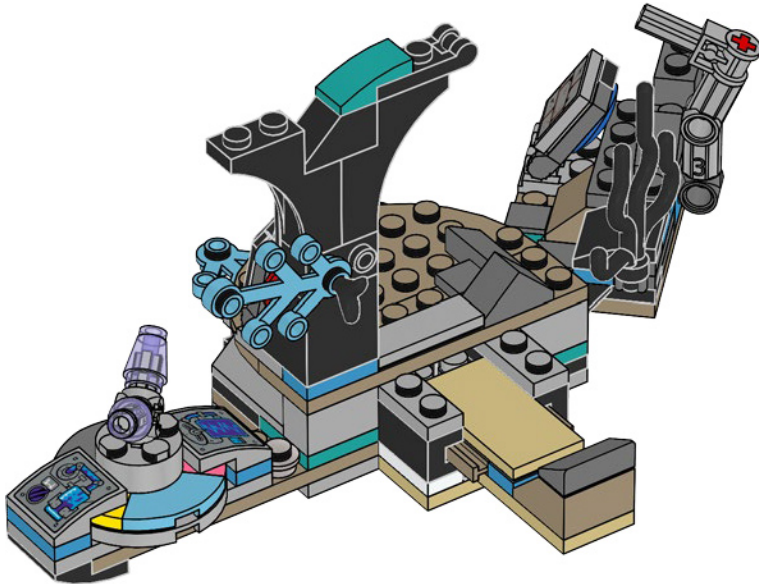

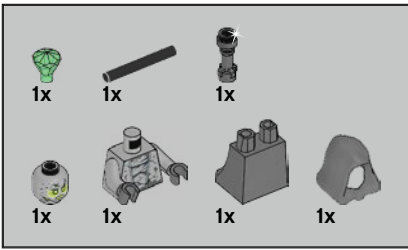

68

1

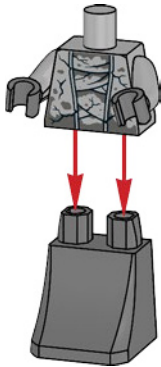

2



3

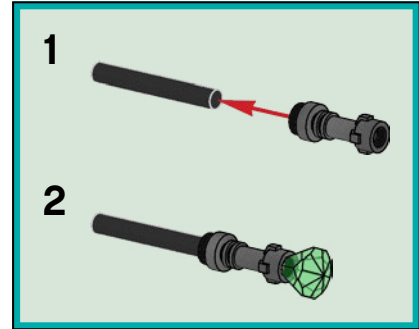

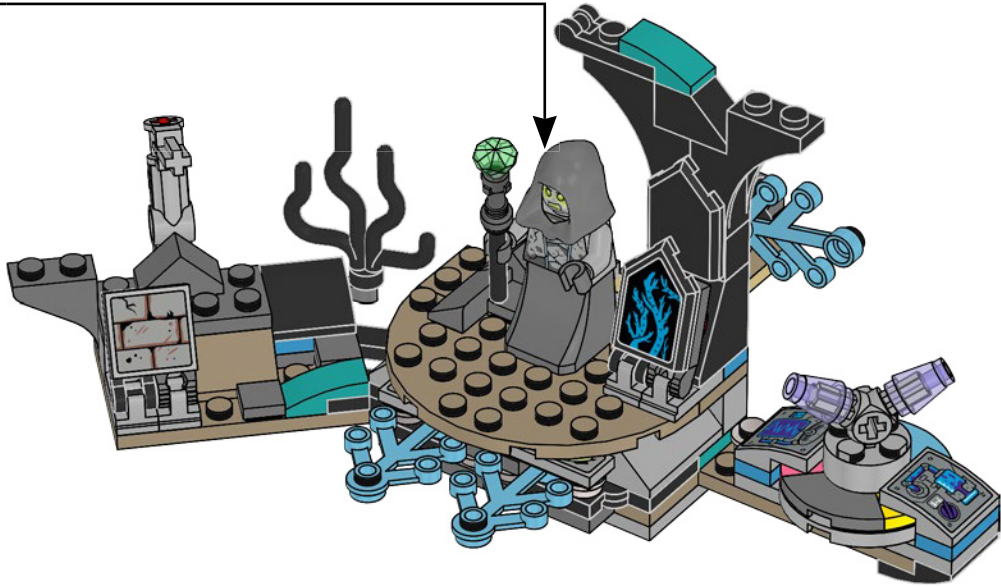





1x

69

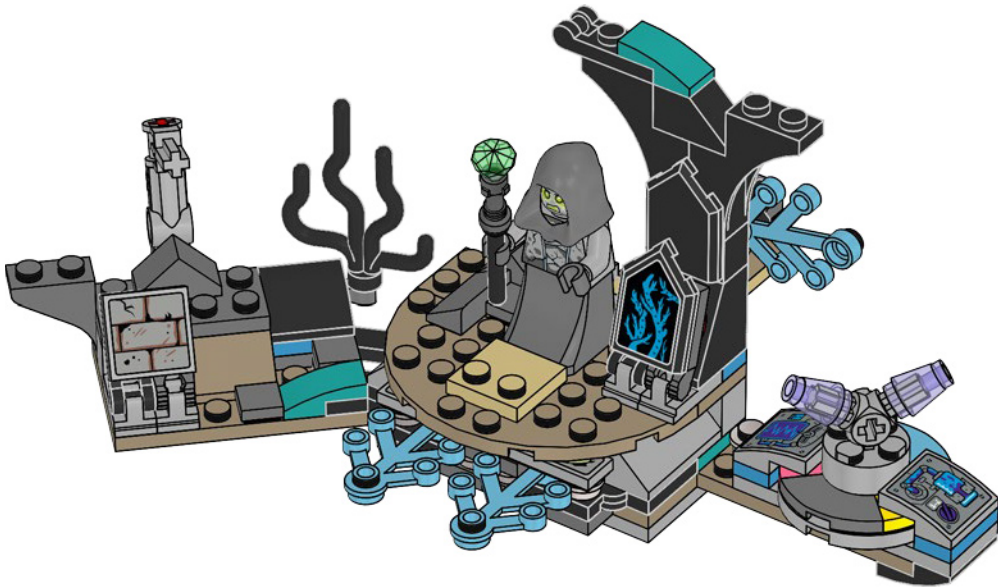

70

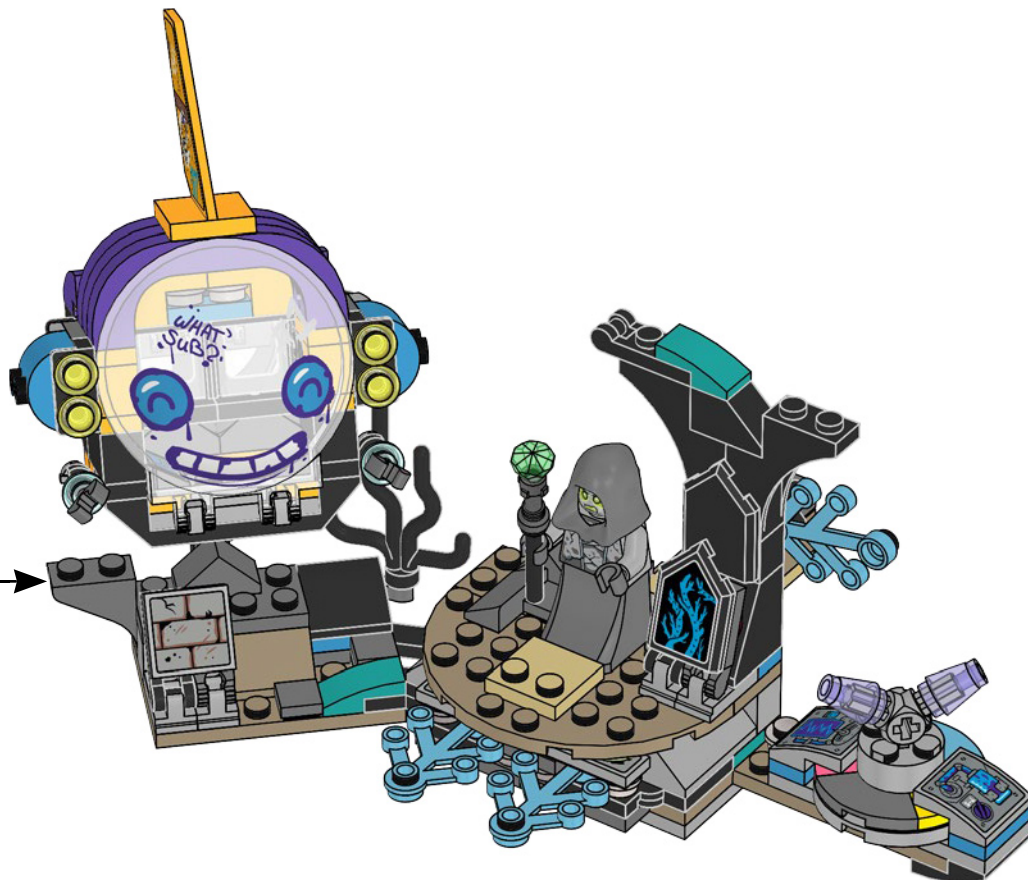



# HIDDEN SIDE



70427



70428



70429



70432



70431



70430



# HIDDEN SIDE



70433



70435

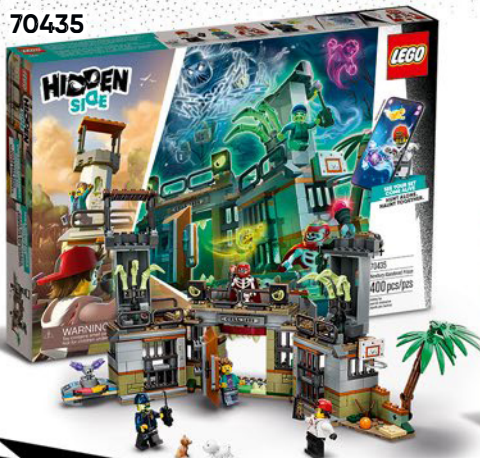

70434



70437



70436





1x  
6238334



2x  
371001



1x  
6221467



2x  
4114309



1x  
6122047



1x  
4113993



2x  
306221



2x  
6284574



1x  
4142865



1x  
4278275



1x  
4278276



1x  
6289266



1x  
6275508

62



2x  
654126



1x  
4253815



2x  
4121715



1x  
6272138



1x  
6302216



1x  
4121966



2x  
306926



2x  
4539128



2x  
6020193



1x  
604126



1x  
6093525



1x  
6211476



1x  
6053077



1x  
4273703



3x  
4515368



2x  
6245251



2x  
362226



2x  
6038531



2x  
428726



1x  
6295073



2x  
6313116



2x  
6172997



2x  
265326



2x  
6102782



1x  
6054852



2x  
663626



1x  
4541984



2x  
6254552



1x  
6303511



4x  
6173640



4x  
6240216



1x  
6247788



2x  
6249427



3x  
6249390



2x  
4567340



1x  
6302218



1x  
6303513



1x  
6306687



2x  
4616711



2x  
6184880



1x  
6035540



1x  
6167894



1x  
6146989



2x  
4246957

  
2x  
6061685

  
6x  
6028736

  
2x  
6023185

  
2x  
6099714

  
3x  
6020074

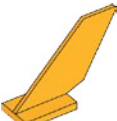
  
1x  
6307483

  
1x  
6310281

  
1x  
6309203

  
1x  
6310346

  
1x  
6309200

  
2x  
4539481

  
1x  
6302228

  
1x  
4211526

  
1x  
4211807

  
2x  
4211541

  
2x  
6305049

  
3x  
4211388

  
4x  
4598526

  
1x  
4502595

  
3x  
6212077

  
1x  
4211413

  
2x  
6102357

  
1x  
4211536

  
1x  
6261387

  
3x  
4558169

  
2x  
4211773

  
2x  
6093058

  
1x  
6276045

  
1x  
4515351

  
2x  
4211438

  
1x  
4211407

  
3x  
4210848

  
5x  
6296892

  
2x  
4226221

  
4x  
4567887

  
1x  
6005331

  
2x  
4211088

  
1x  
6122266

  
1x  
6283991

  
2x  
6284702

  
1x  
4210635

  
2x  
4218696

  
1x  
6265306

  
2x  
6267047

  
3x  
4211133

  
1x  
6186635

  
1x  
6310368

  
2x  
6278155

  
1x  
4211065

  
1x  
6302226

  
13x  
4633691

  
1x  
6122727

  
1x  
6074417

  
1x  
6303519

  
1x  
6250024

  
8x  
4653988

  
2x  
6249815

  
2x  
6307482

  
1x  
6258069

  
3x  
6307493

  
1x  
6286505

  
2x  
6103449

  
3x  
6307486

Customer Service

Kundenservice

Service Consommateurs

Servicio Al Consumidor

LEGO.com/service or dial





# WIN

GO TO [WWW.LEGO.COM/PRODUCTFEEDBACK](http://www.LEGO.COM/PRODUCTFEEDBACK) AND  
GIVE US YOUR SHORT **FEEDBACK** ABOUT THIS  
LEGO® SET FOR A CHANCE TO WIN  
A COOL LEGO PRIZE.

Terms & Conditions apply

## [LEGO.com/productfeedback](http://LEGO.com/productfeedback)

### GEWINNE

Erzähle uns auf  
[www.LEGO.com/productfeedback](http://www.LEGO.com/productfeedback)

etwas über die Erfahrungen, die du mit  
diesem LEGO® Set gemacht hast, und  
sichere dir die Chance auf einen coolen  
LEGO Preis!

Es gelten die Teilnahmebedingungen

### GAGNE

Rends-toi sur  
[www.LEGO.com/productfeedback](http://www.LEGO.com/productfeedback)

et donne-nous quelques commentaires  
sur ce produit LEGO® pour avoir une  
chance de gagner un prix LEGO !

Voir Conditions Générales

### GANA

Visita  
[www.LEGO.com/productfeedback](http://www.LEGO.com/productfeedback)

y envíanos tu opinión acerca de este set  
LEGO®. ¡Participarás en el sorteo de un  
premio LEGO!

Términos y Condiciones aplicables

### 获取奖品

登录  
[www.LEGO.com/productfeedback](http://www.LEGO.com/productfeedback)

给出关于此乐高®套装的简短反馈，  
就有机会获得炫酷乐高奖品

《条款及条件》适用

LEGO, the LEGO logo and the HIDDEN SIDE logo are trademarks of the LEGO Group. ©2020 The LEGO Group.

6325303