



TECHNIC

30433



VOLVO

6408256

1

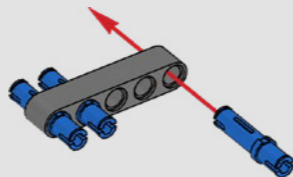

2

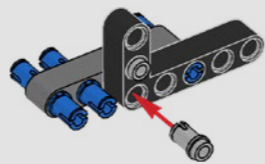

3

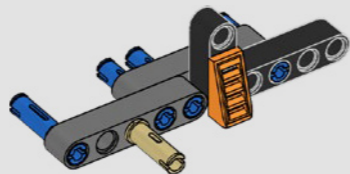

4

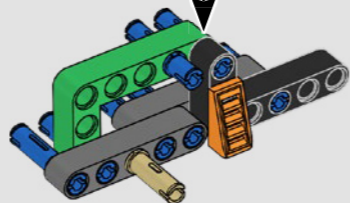
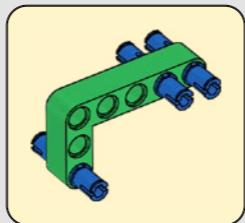

1

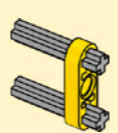

2

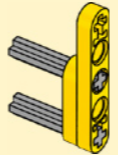

5

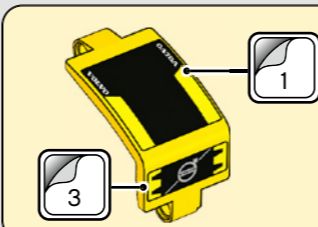
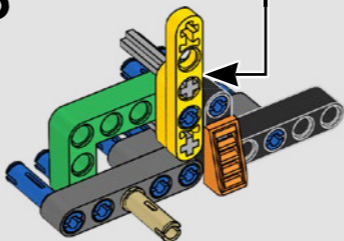

6

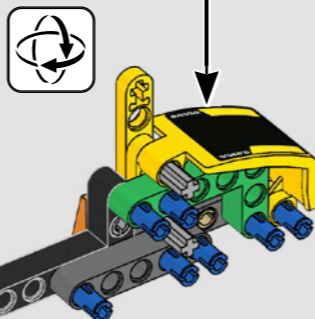

7

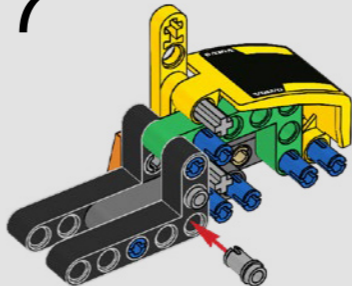

8

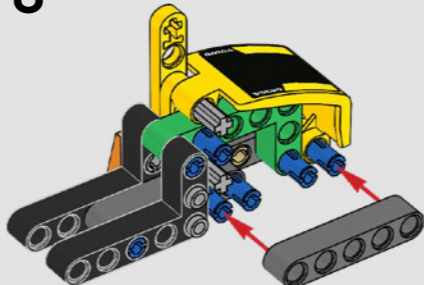

9

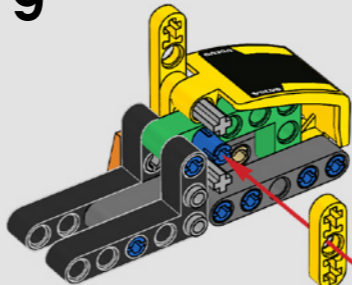

10

1

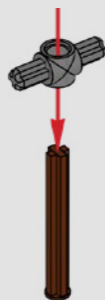

2

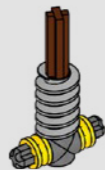

1

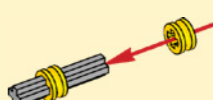

2

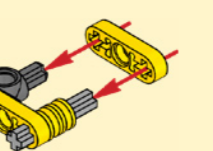

3

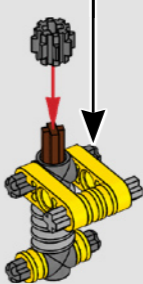

4

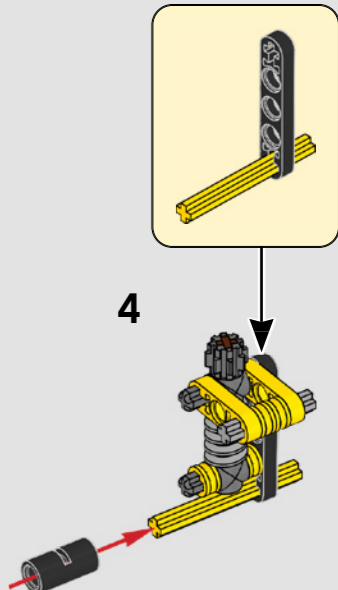

5

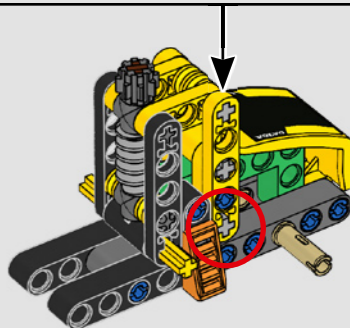
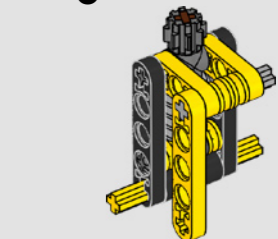

11

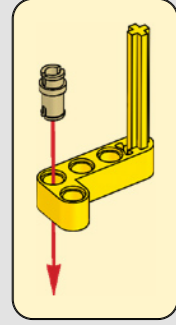
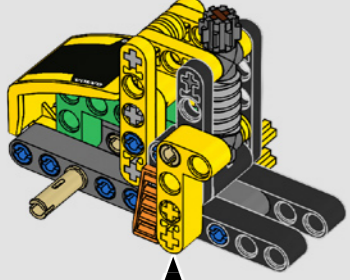

12

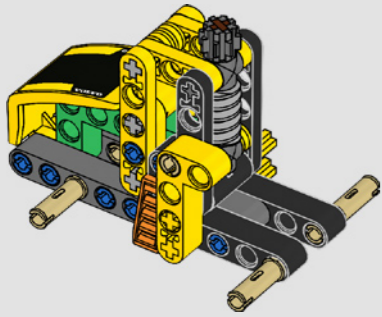

13

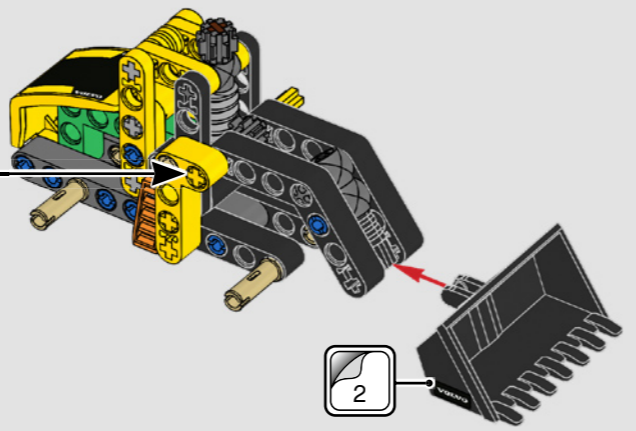
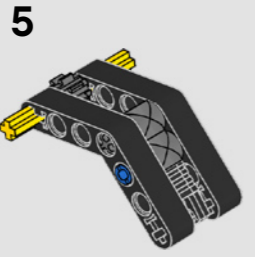
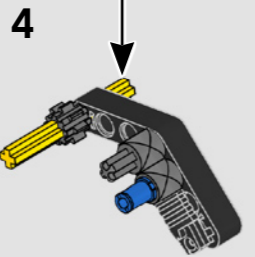
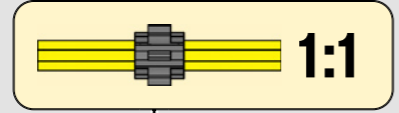
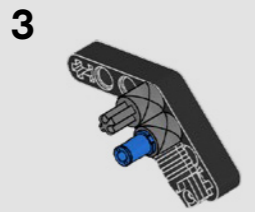
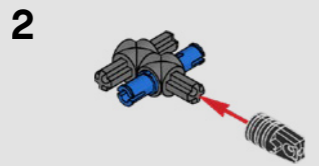
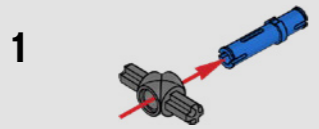

14

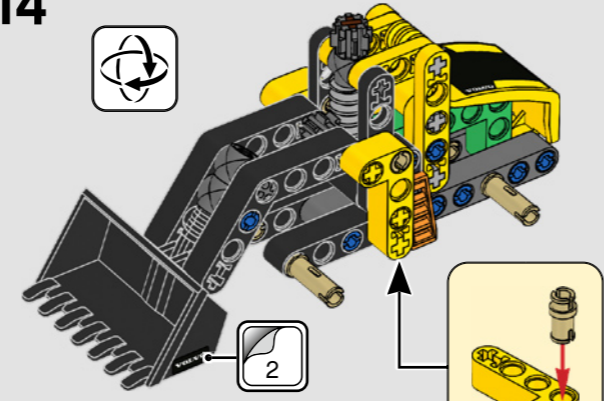

15

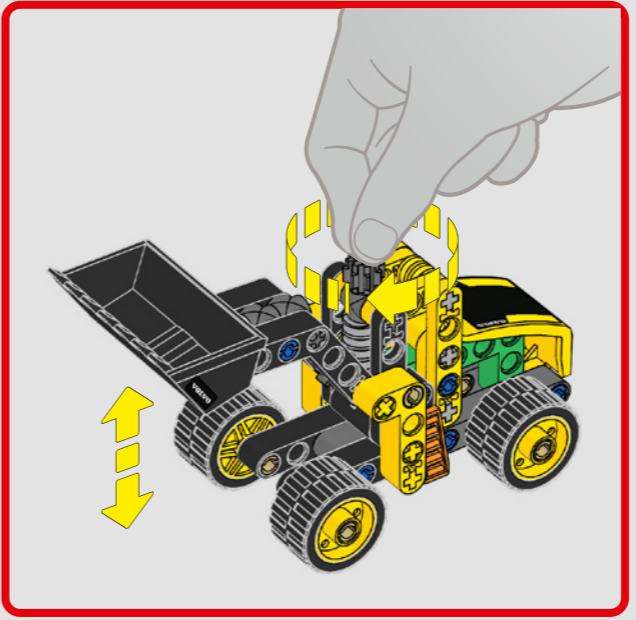
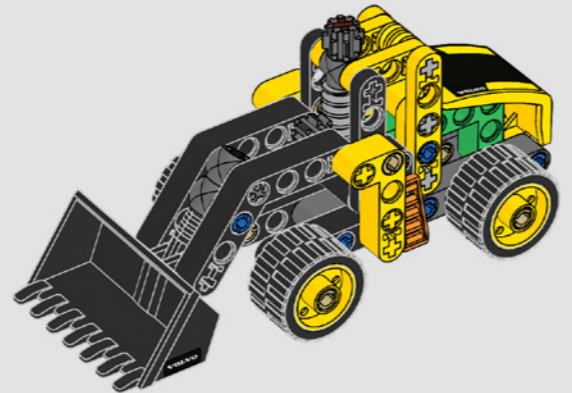

[LEGO.com/service](https://www.lego.com/service)

LEGO and the LEGO logo are trademarks of the LEGO Group.
©2022 The LEGO Group.

The Volvo trademarks (word and device) are registered trademarks of Volvo Trademark Holding AB and are used pursuant to a license. Other trademarks and trade names are those of their respective owners.

