



Singapore

Booklet available in English on  
Heft in deutscher Sprache erhältlich auf  
Livret disponible en français sur  
Libretto disponibile in Italiano su  
Folleto disponible en español en  
如需中文版手册, 请访问



A wide-angle photograph of the Singapore skyline across a body of water. The Marina Bay Sands hotel is the central focus, with its distinctive three towers and skybridge. To the left is the Esplanade - Theatres on the Bay, and to the right is the Esplanade - Theatres on the Bay. The sky is a vibrant blue with wispy white clouds. The water in the foreground is calm, reflecting the buildings and sky.

# WELCOME TO SINGAPORE

Lying at the southern tip of the Malay Peninsula, the city-state of Singapore is the gateway between East and West. This is especially evident in the city's architecture, which is a melting pot of many styles and influences set against a backdrop of lush greenery and a vibrant riverfront.



**ROK ZGALIN KOBE**  
*Senior Designer at the LEGO Group*

## FROM THE DESIGN TEAM

With a passion for architecture, LEGO® building and Singapore, Rok Zgalin Kobe was the perfect LEGO designer for this set. For him, the biggest challenge wasn't so much selecting the right mix of old and new structures for the model but attempting to capture the unique atmosphere of the vibrant city in LEGO elements.

# MARINA BAY SANDS



Opened in 2010, the impressive Marina Bay Sands is an integrated resort made up of three individual towers connected at the top by the 340-metre-long (1,120 ft.) Sands SkyPark. This is the world's largest public cantilevered platform and includes gardens, restaurants and a dramatic 150 m (490 ft.) infinity swimming pool.



# OCBC CENTRE

Designed to be seen both as a symbol of strength and permanence, the OCBC Centre consists of two semi-circular reinforced concrete cores and three lateral girders in the Brutalist architectural style. The 198 m (649 ft.) tall structure was the tallest building in Singapore when it was completed in 1976.

# ONE RAFFLES PLACE



Set in the heart of the financial district, One Raffles Place is one of the tallest skyscrapers in the city with a height of 280 m (920 ft.). The original tower, designed by prize-winning Japanese architect Kenzo Tange, was completed in 1986.

The tower is made from two triangular structures, clad with chemically treated aluminium alloy which changes colour along with the light it reflects.

# THE FULLERTON HOTEL

## BOAT QUAY



Boat Quay is the historical quay situated upstream from the mouth of the Singapore River. The characteristic two- and three-storey shophouses with their projecting upper floors were restored in the 1990s and are now the bustling home to many shops, restaurants and bars.



When it was completed in 1928, the Fullerton Building dominated the city skyline and was home to the Post Office and other government offices. After a major S\$400 million (213.8 million GBP) restoration, this masterpiece of neoclassical architecture officially opened as a five-star hotel on 1 January 2001.

## LAU PA SAT



Lau Pa Sat, also known as Telok Ayer Market, is a historic structure located in downtown Singapore. The Victorian, octagonal-shaped building was completed in 1894 using prefabricated cast-iron parts shipped to Singapore from a foundry in Glasgow, Scotland. Today it's a popular food court with stalls selling a variety of local cuisine.

## GARDENS BY THE BAY



These 18 towering Supertrees measure between 25 m (82 ft.) and 50 m (164 ft.) in height and afford splendid views of the gardens and the surrounding Marina Bay area. While large canopies provide shade during the day, in the evening this vertical garden comes alive in an amazing display of light and sound.

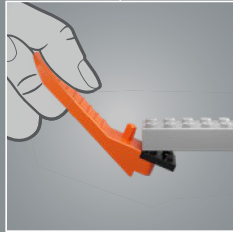
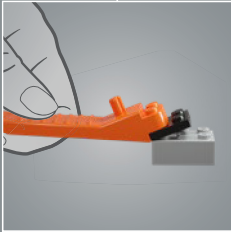
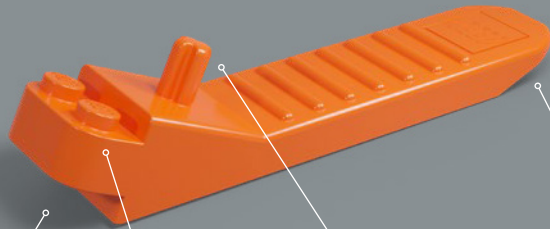



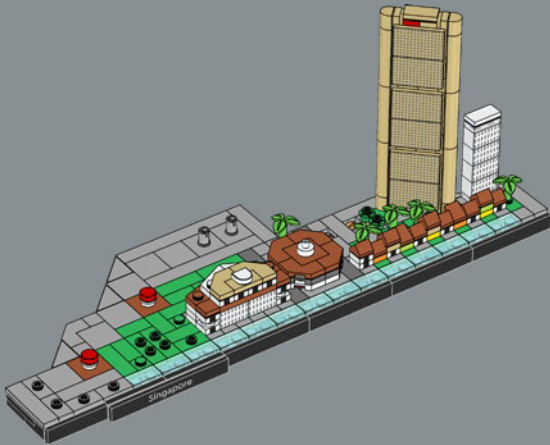
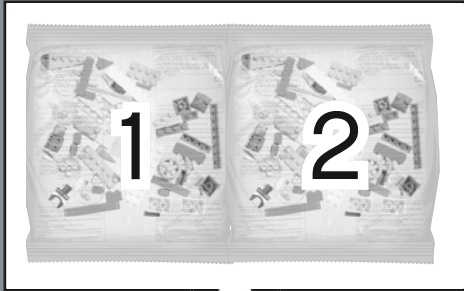

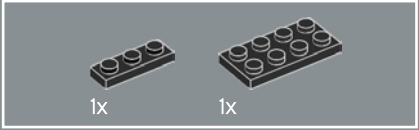
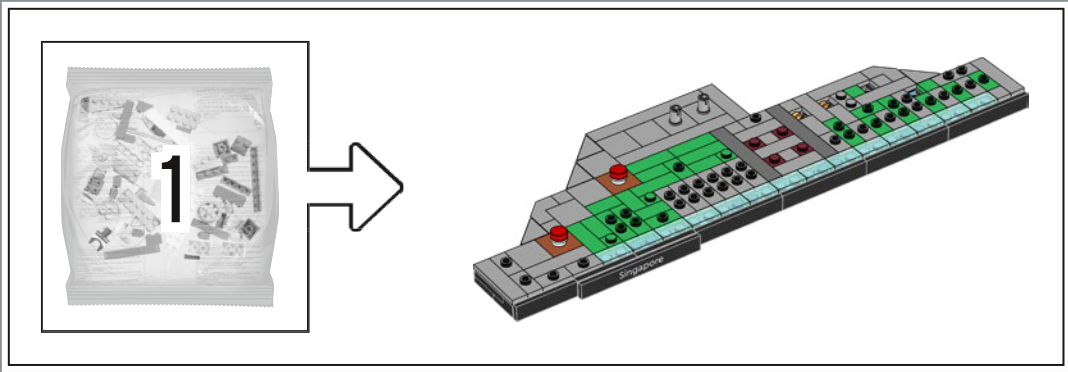

1

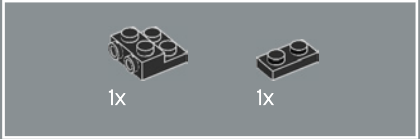
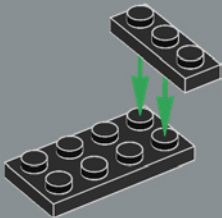

2

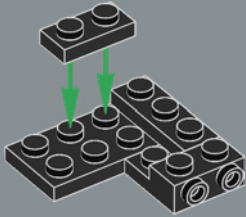

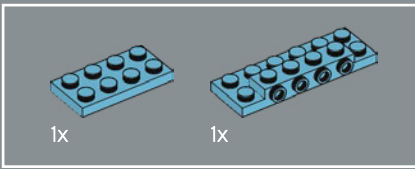

3

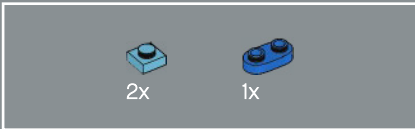
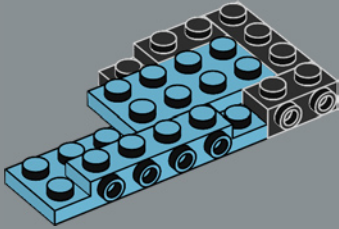

4

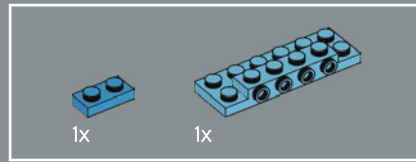
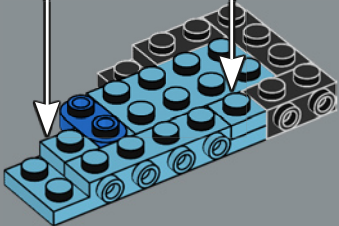

5

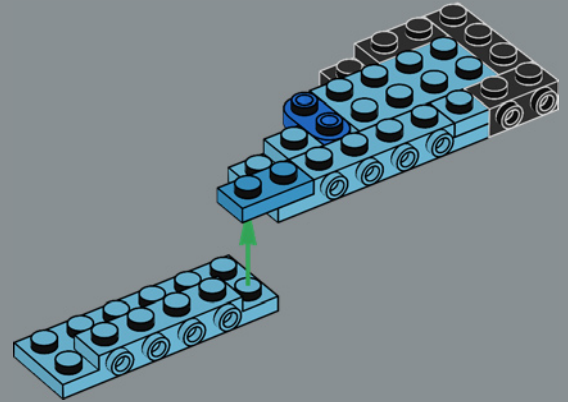

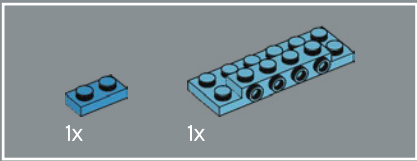

6

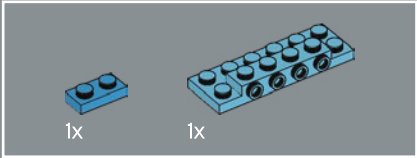
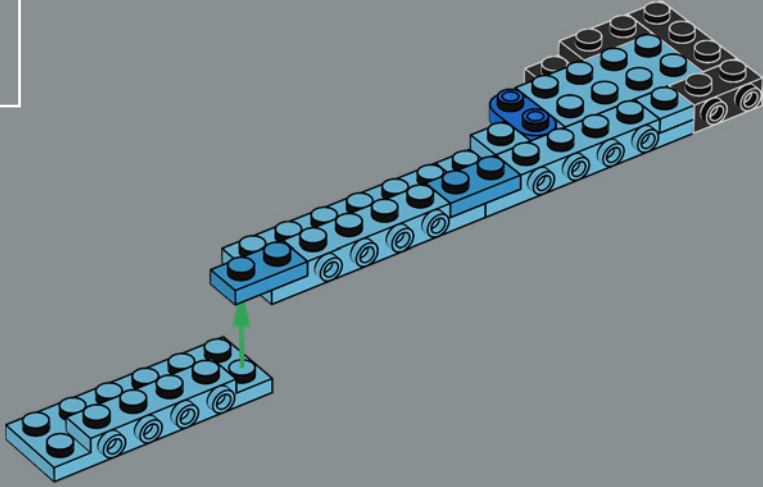

7

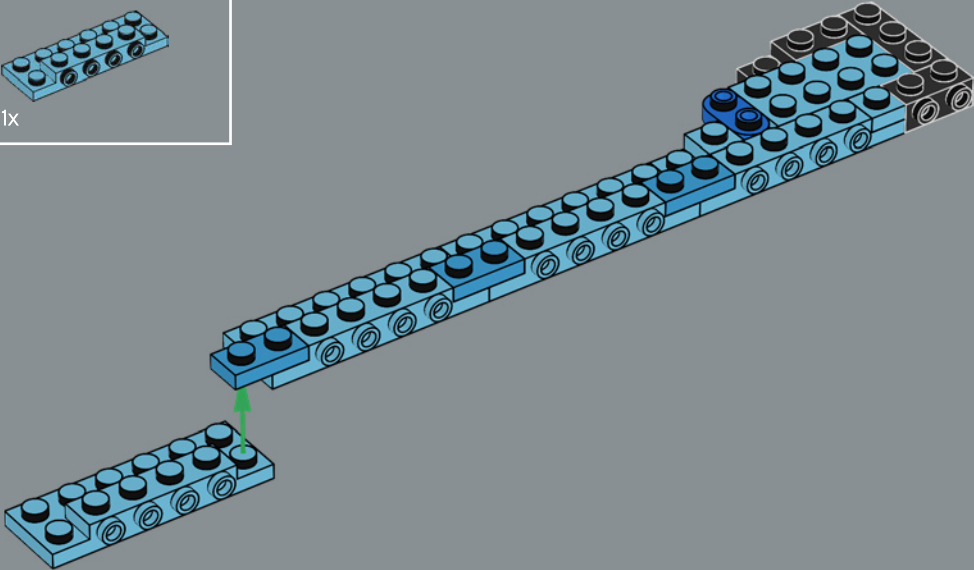

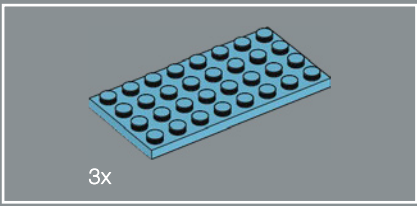

8

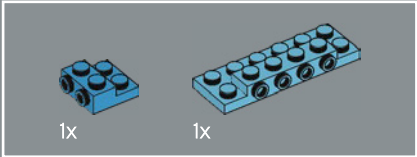
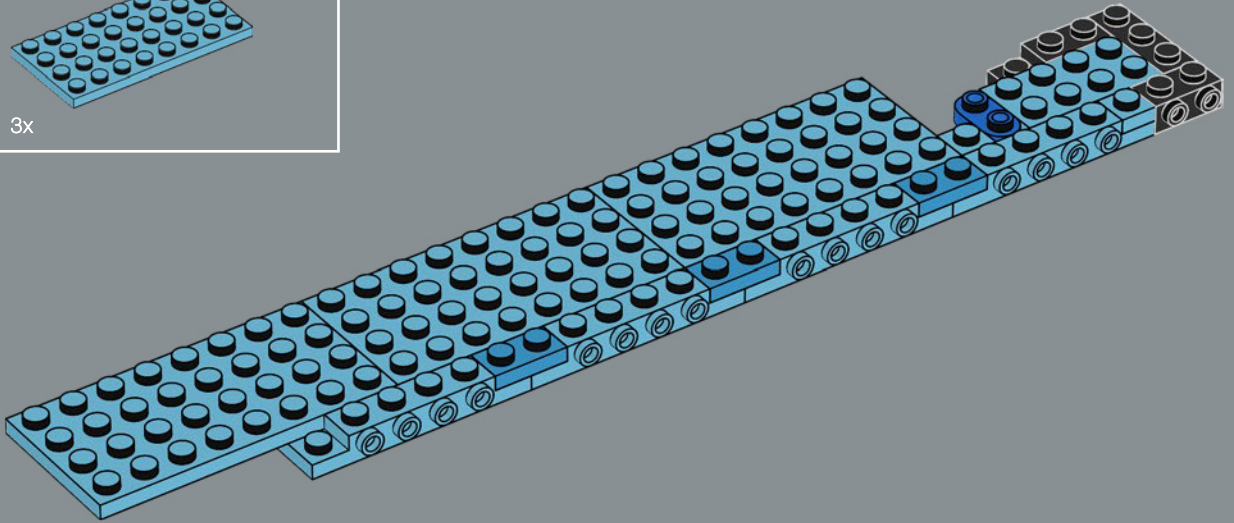

9

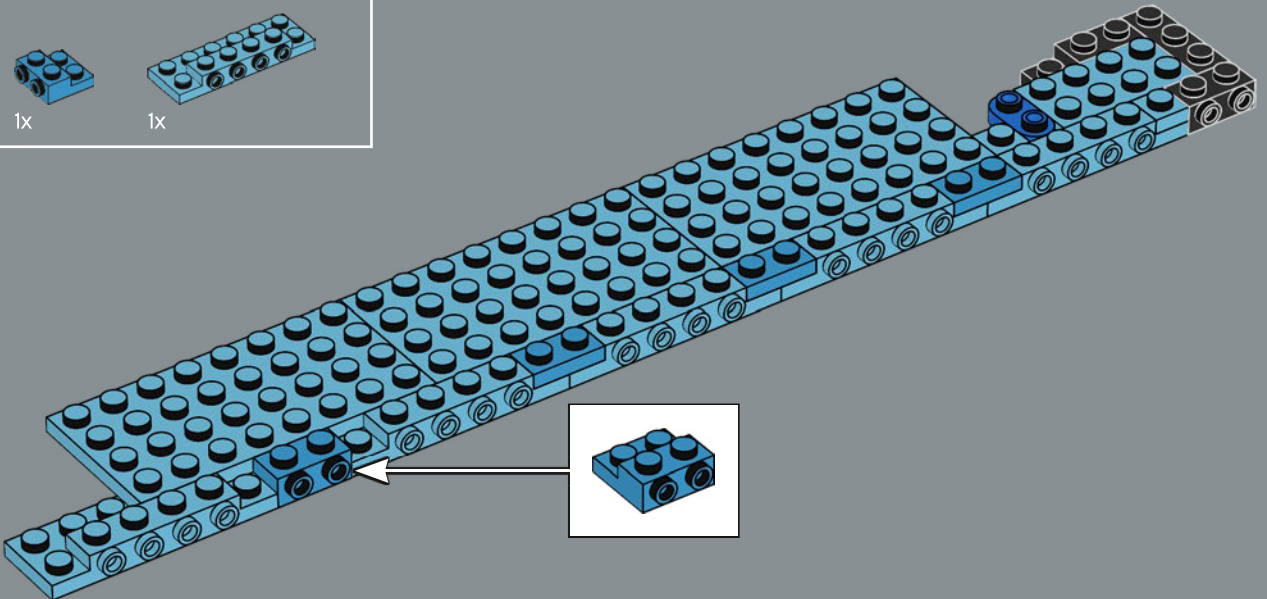

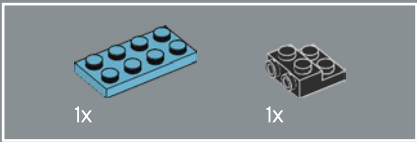

10

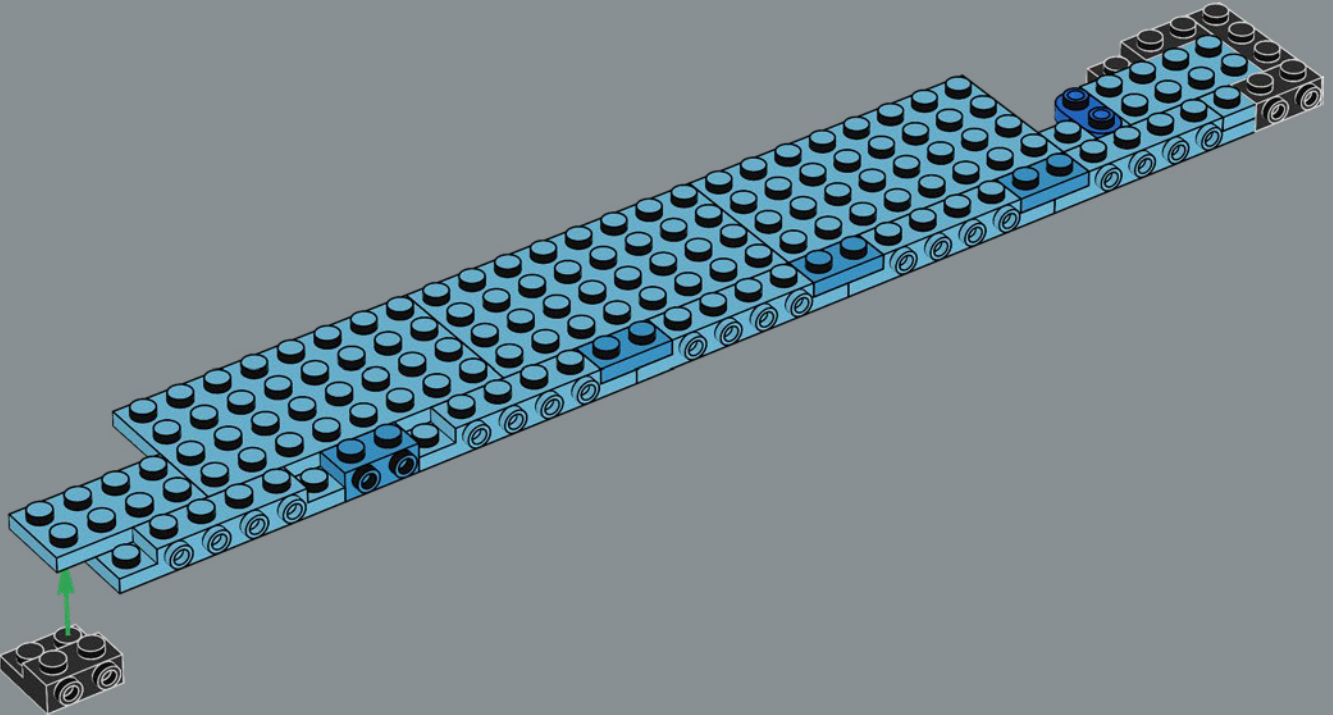

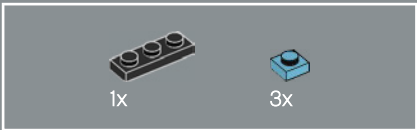

11

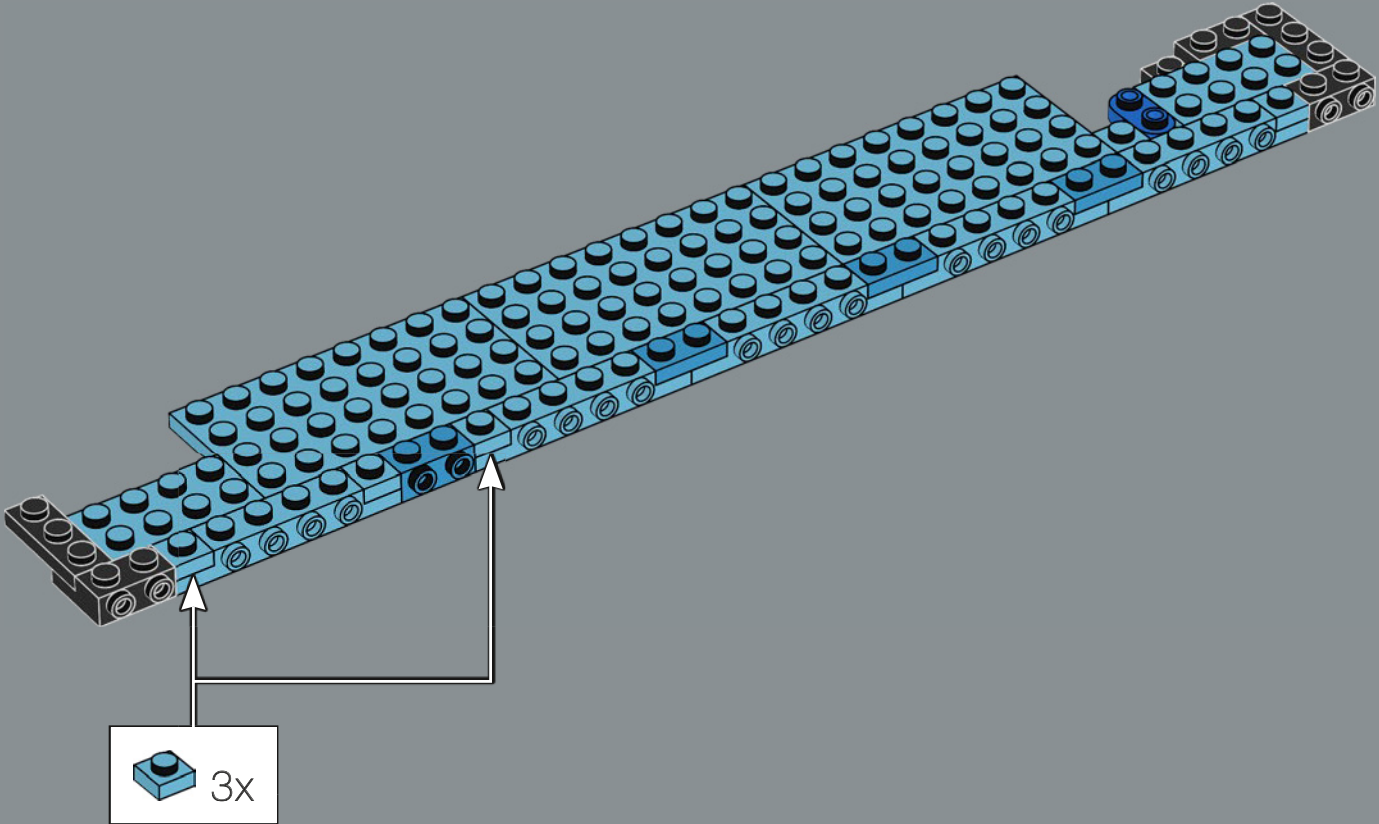

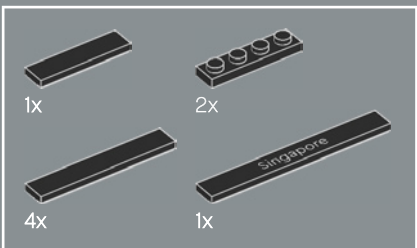

12

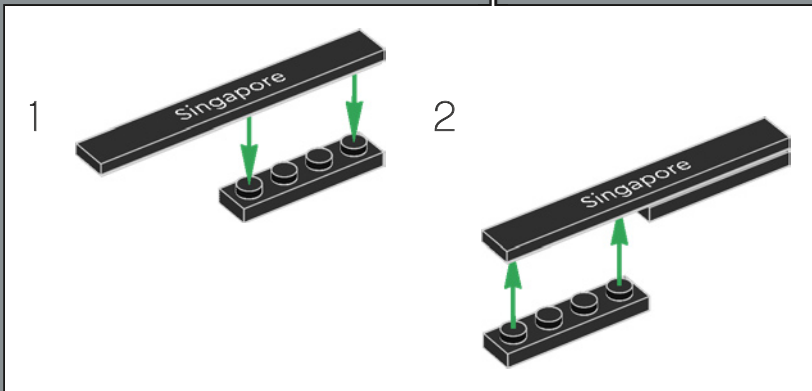
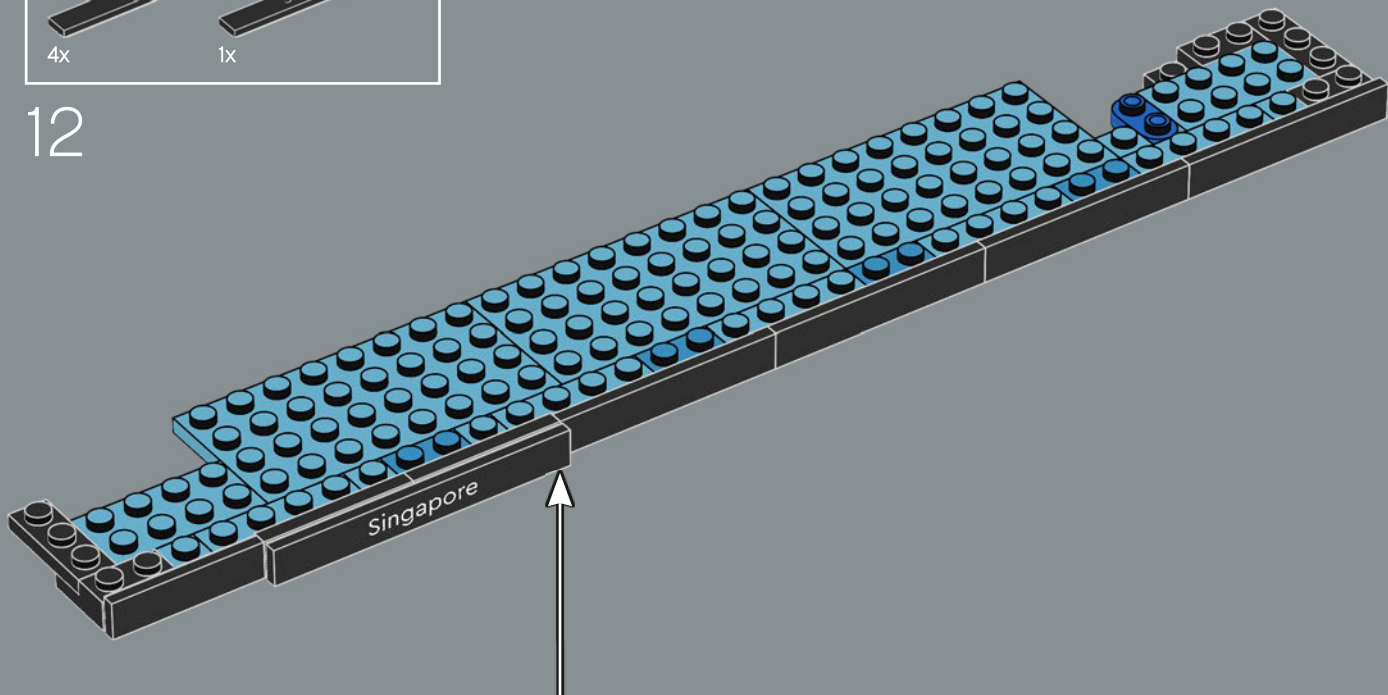



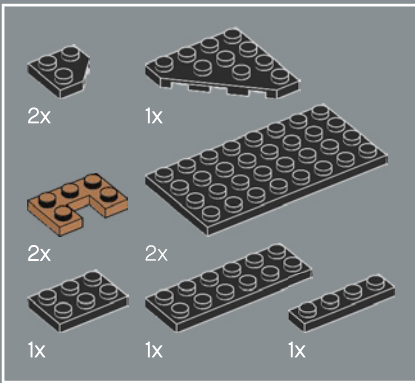

13

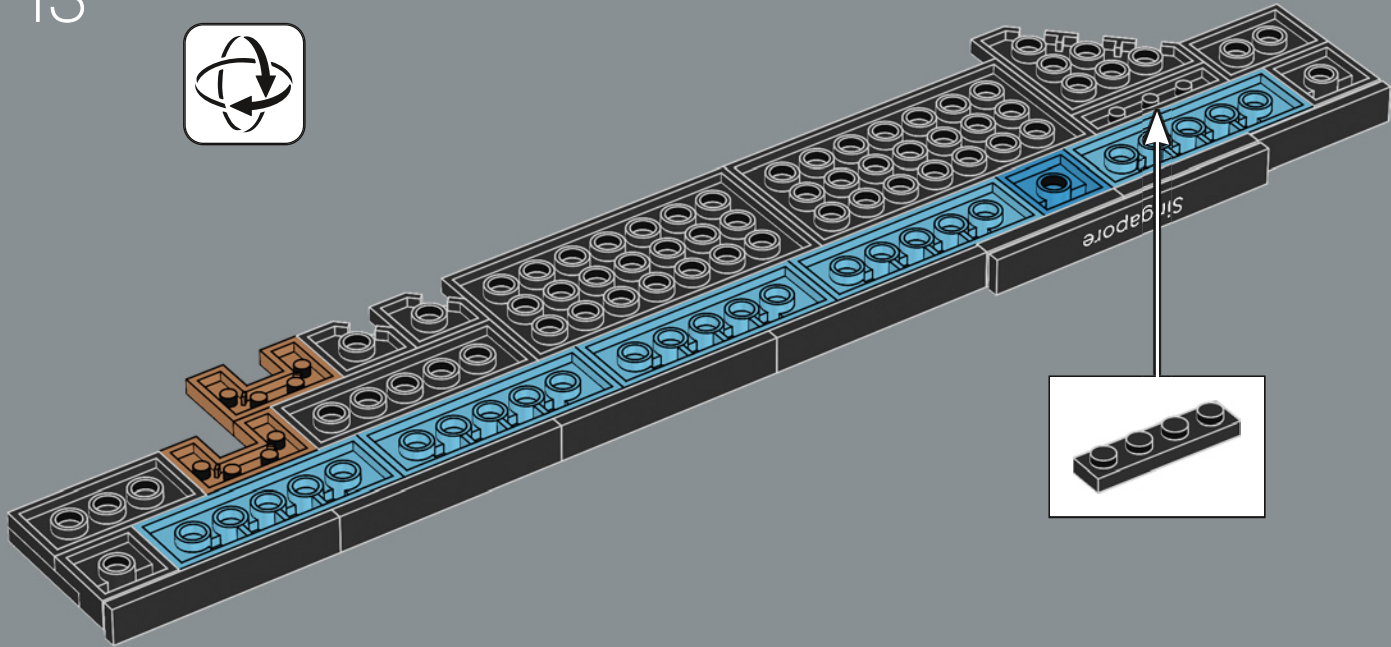

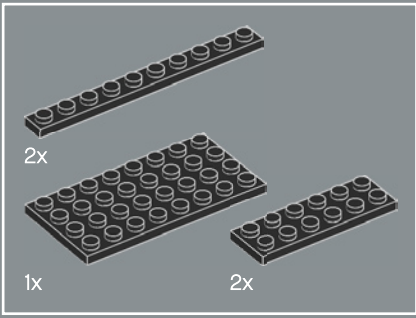

14

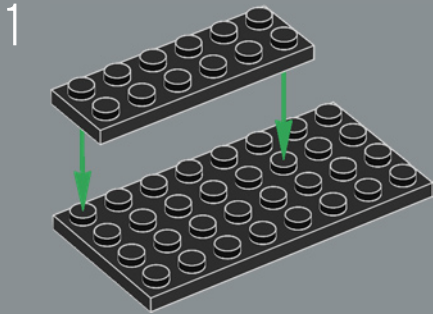

2

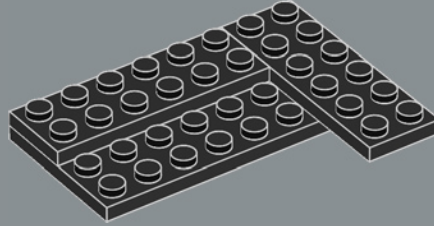

3

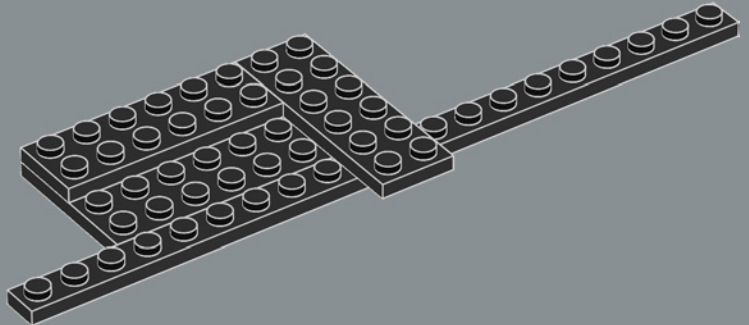

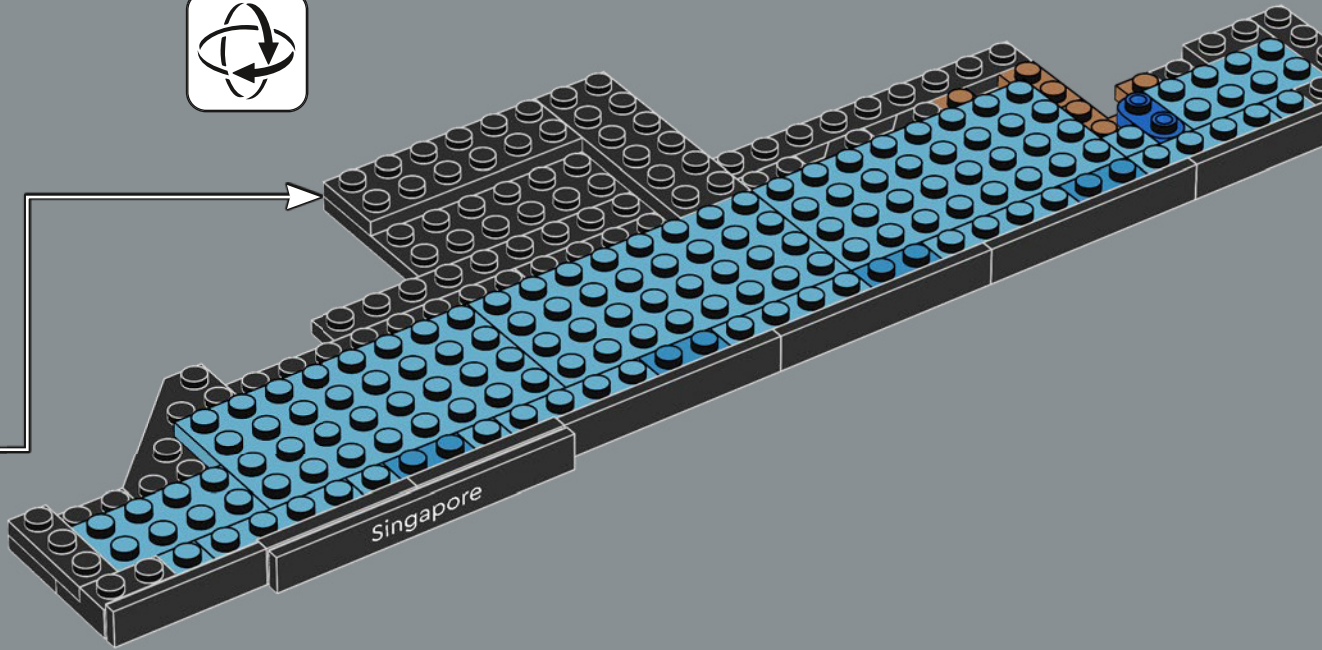

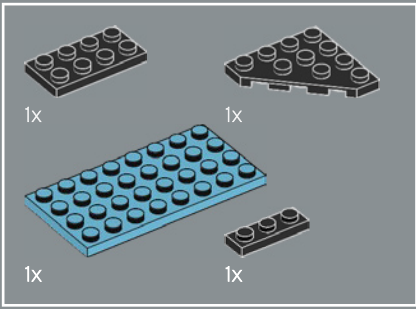

15

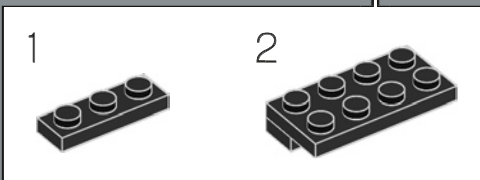
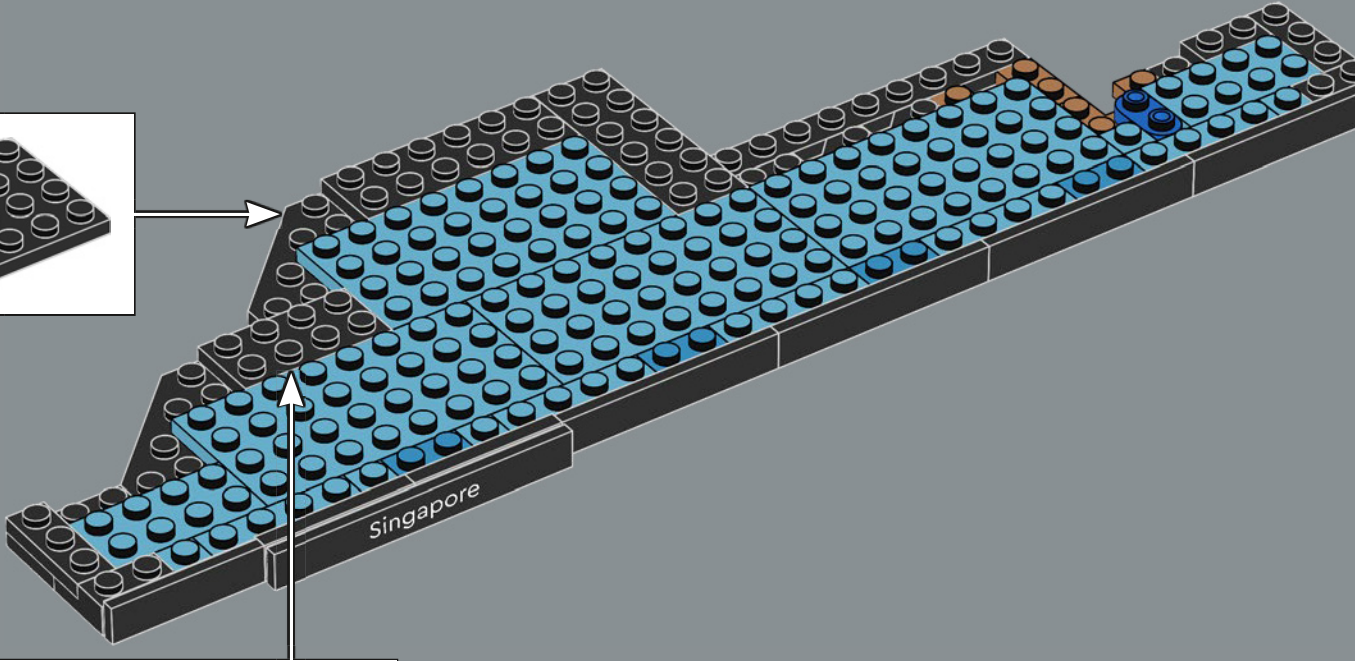
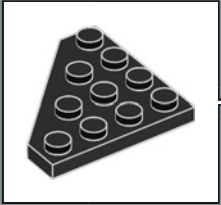

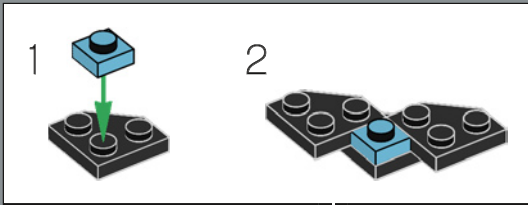
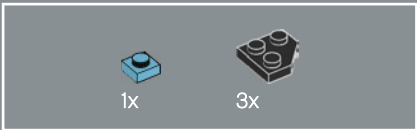

16

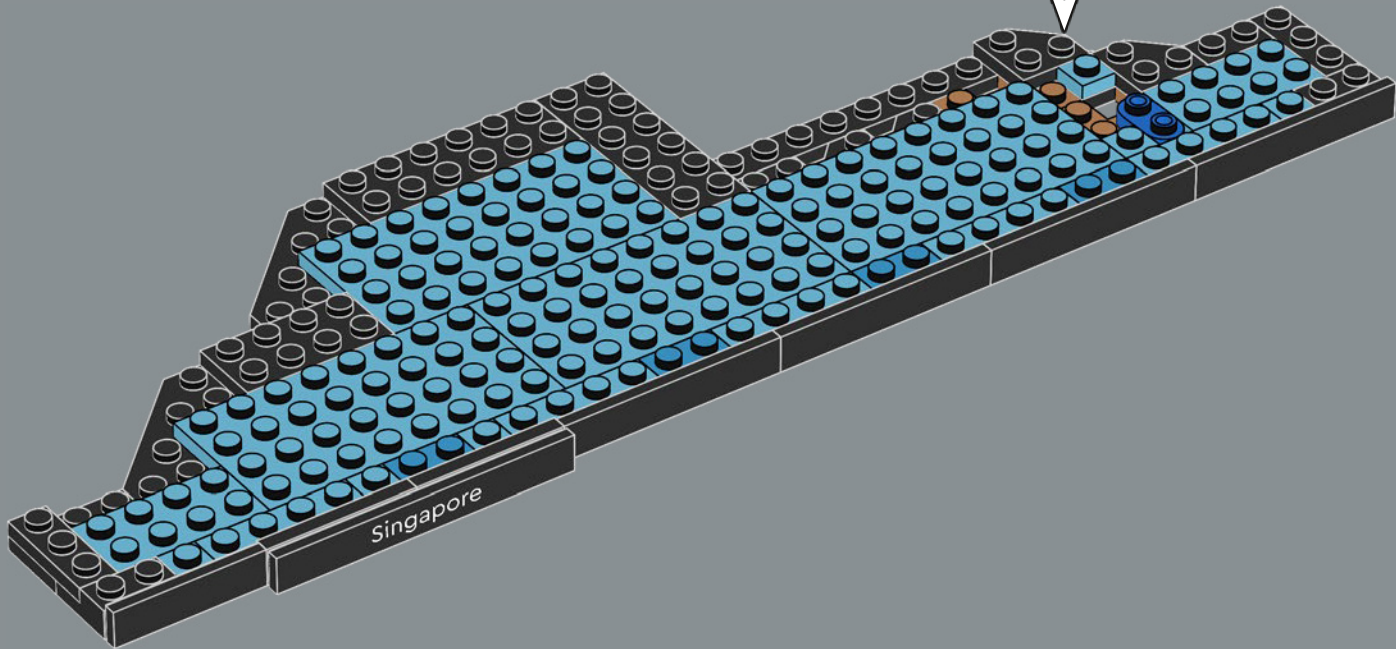

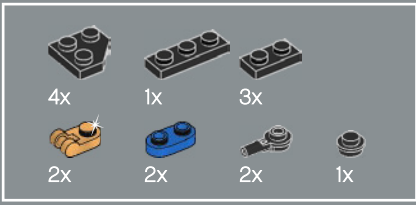

17

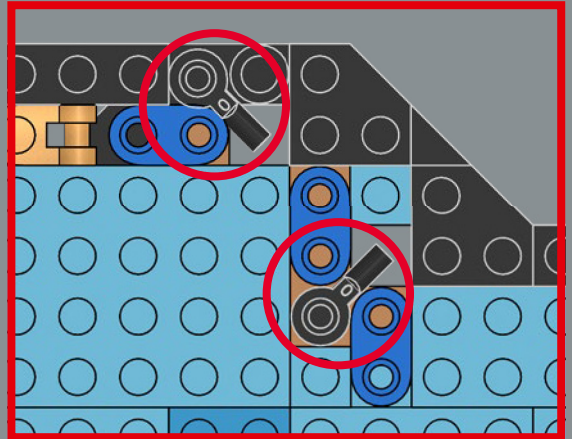
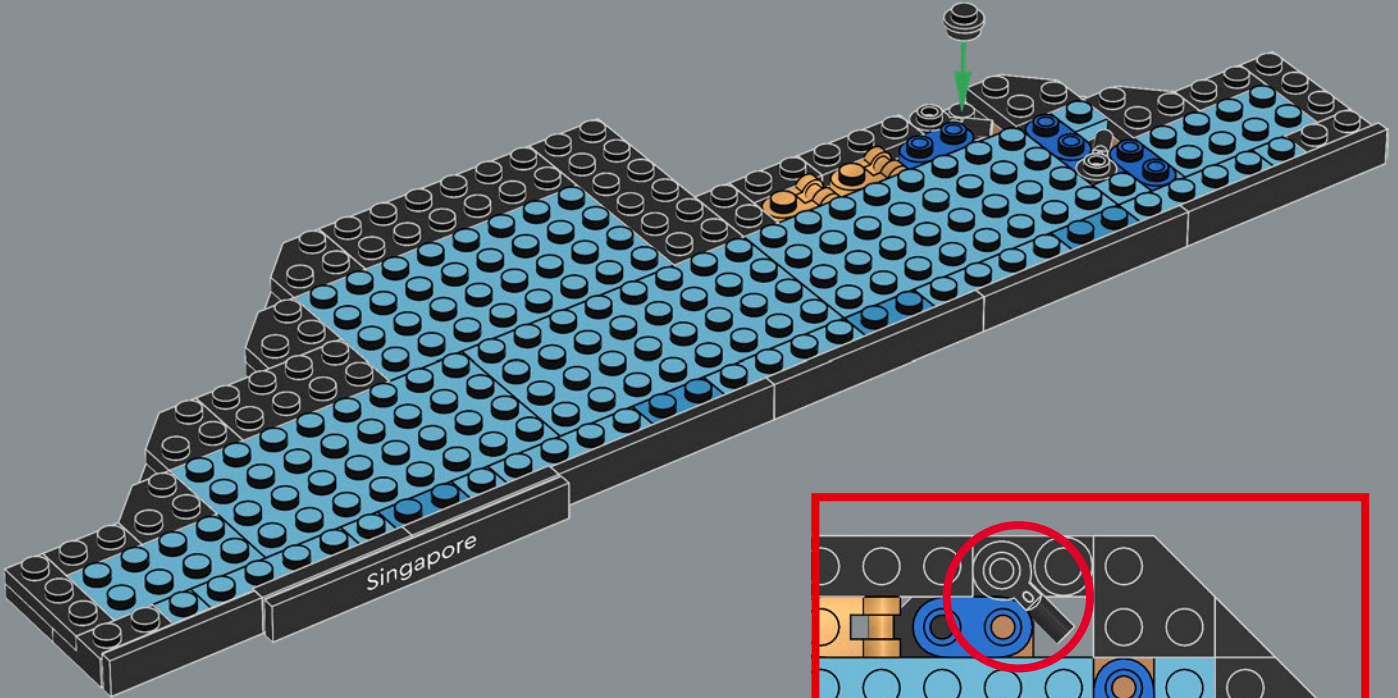

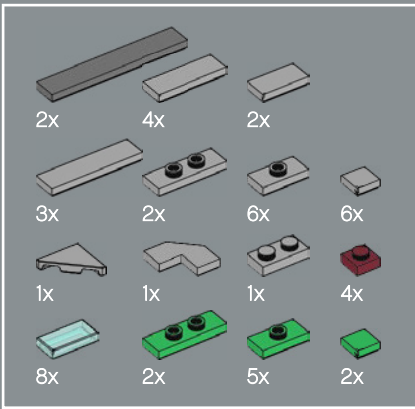

18

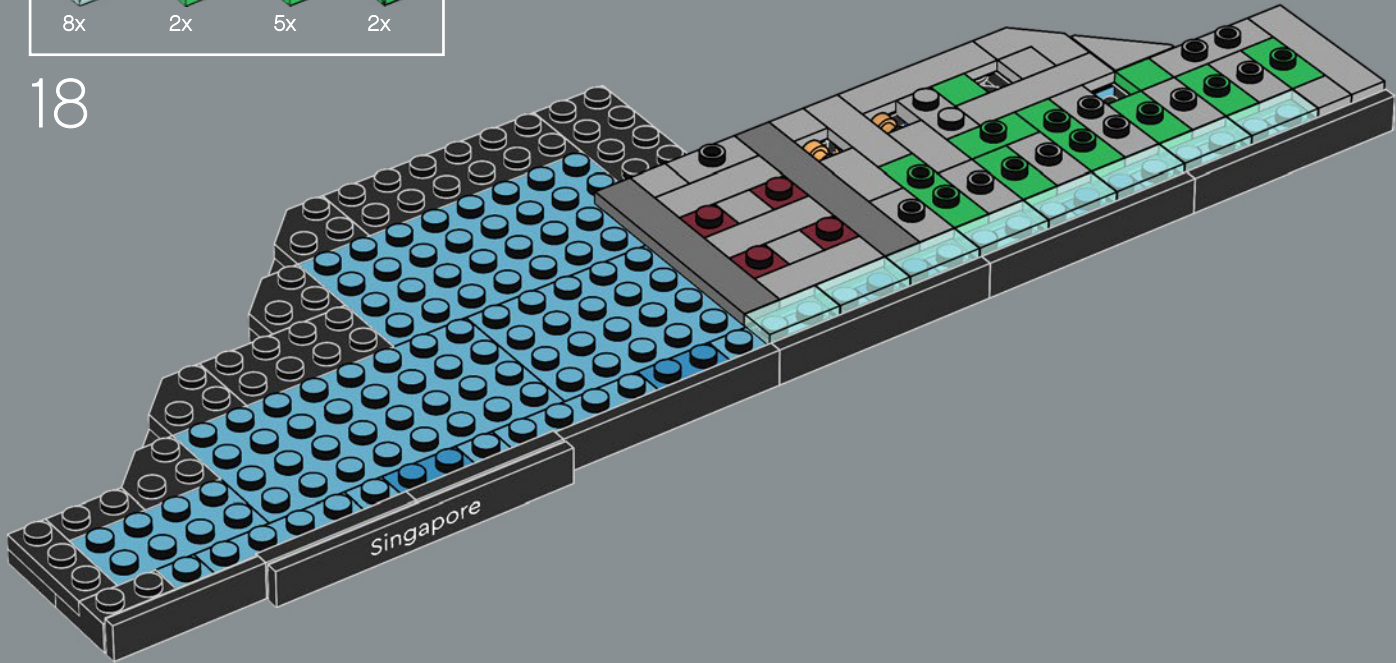

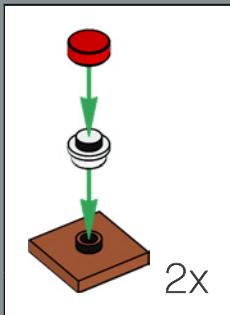
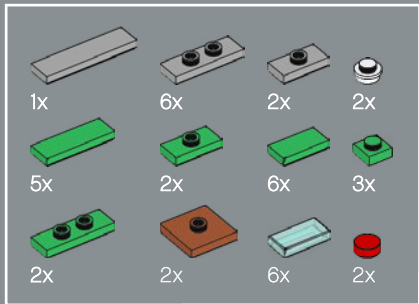

19

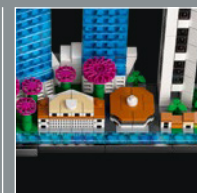
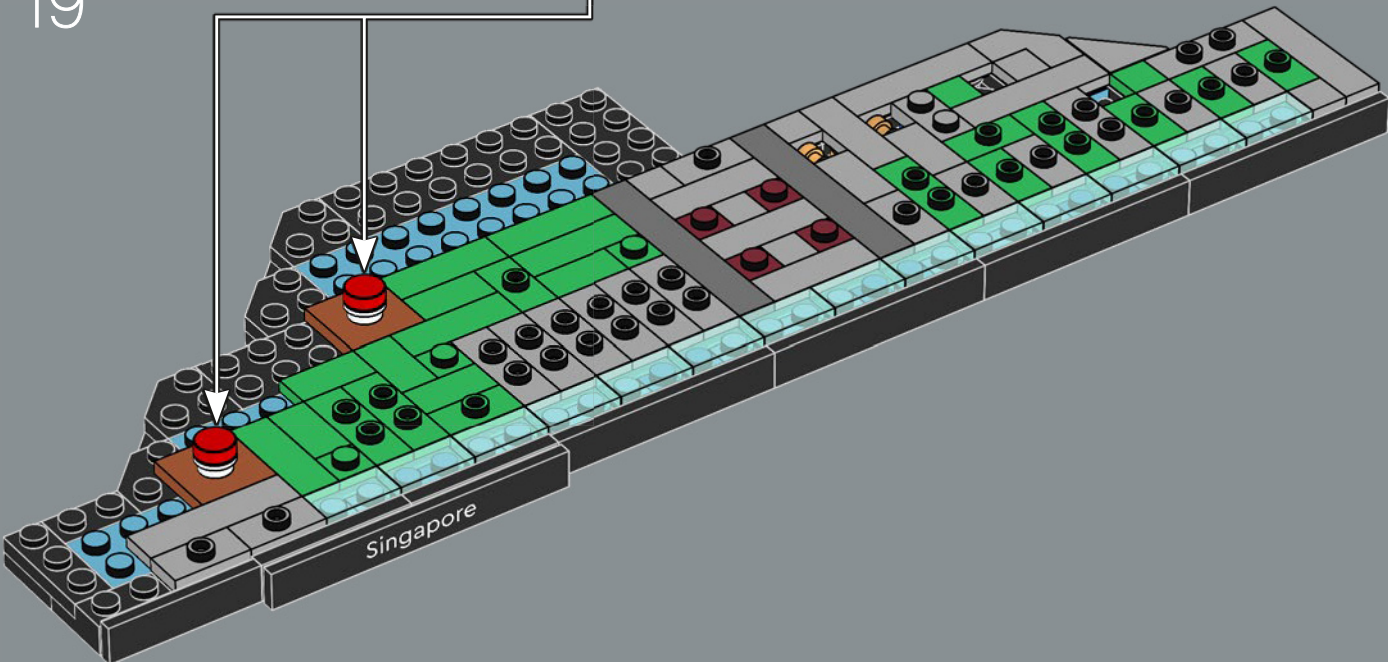

The Singapore River stretches almost the full width of the model.



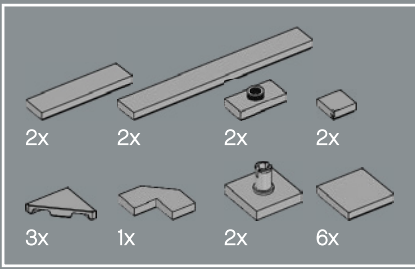

20

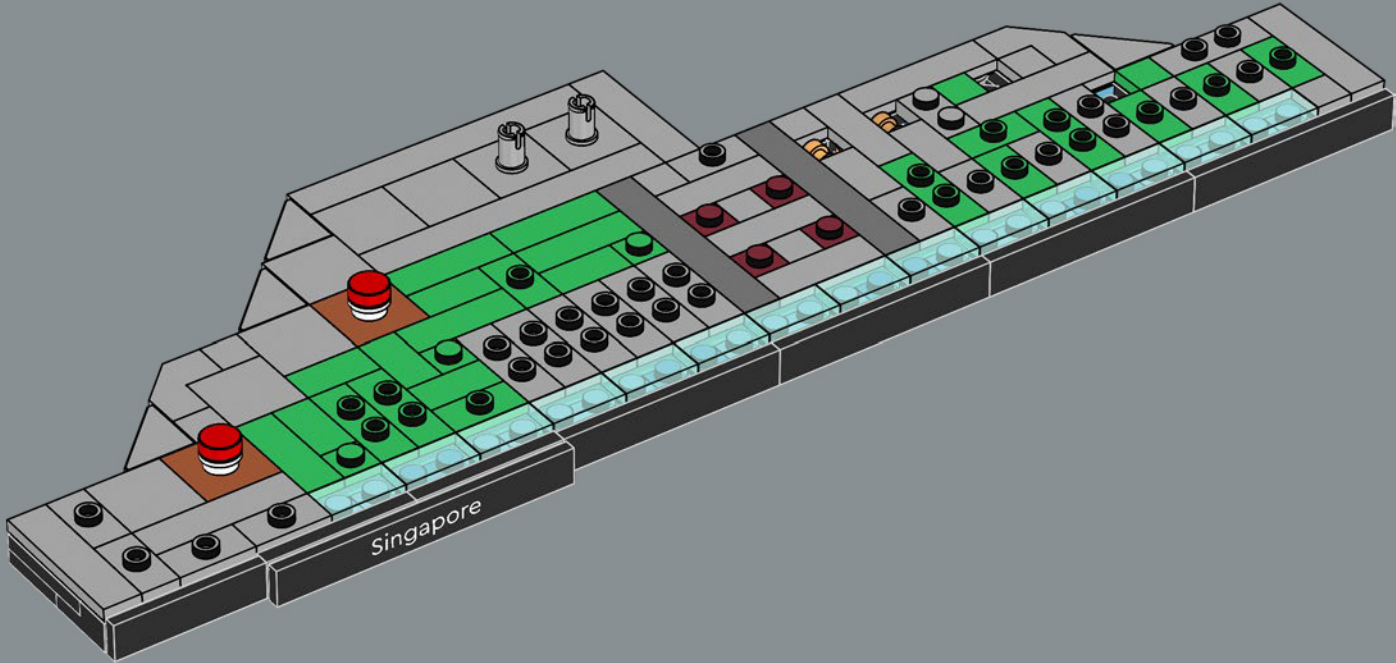

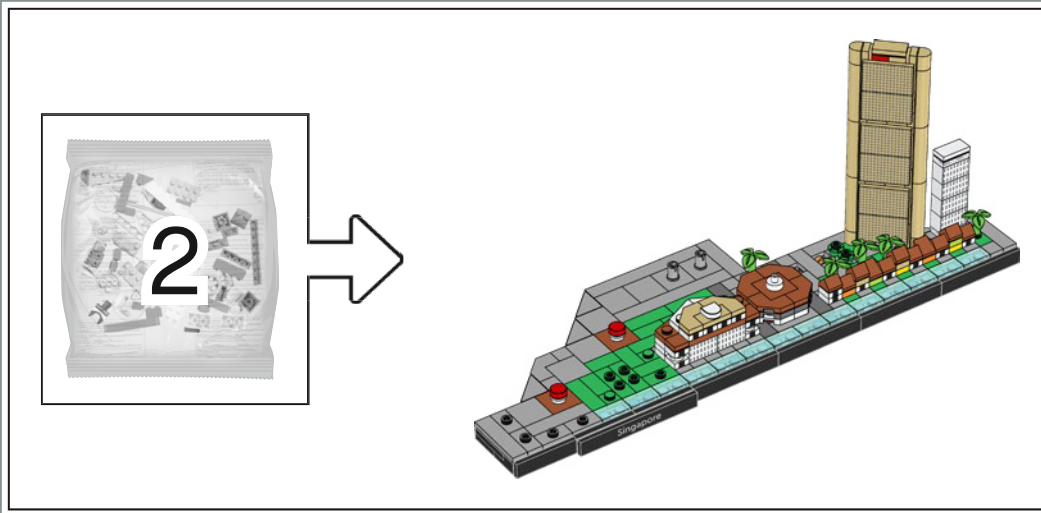

21

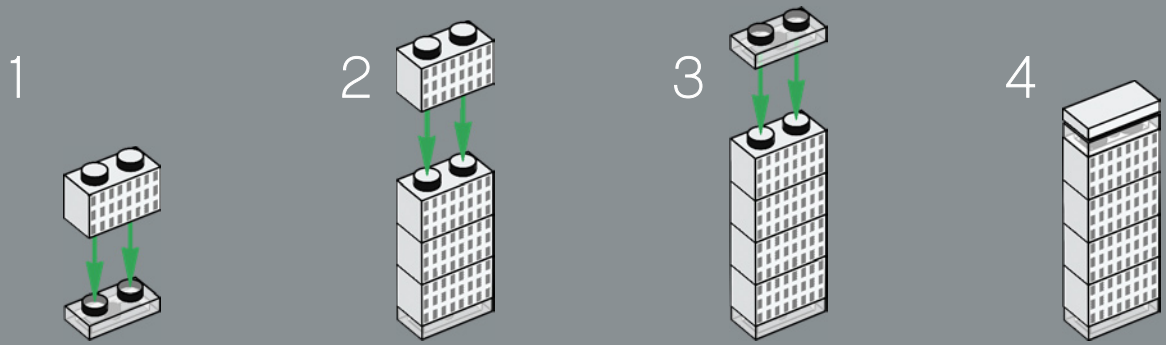

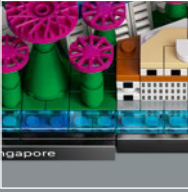

The various shades of colour used for the water and foliage represent the tropical nature of the city.

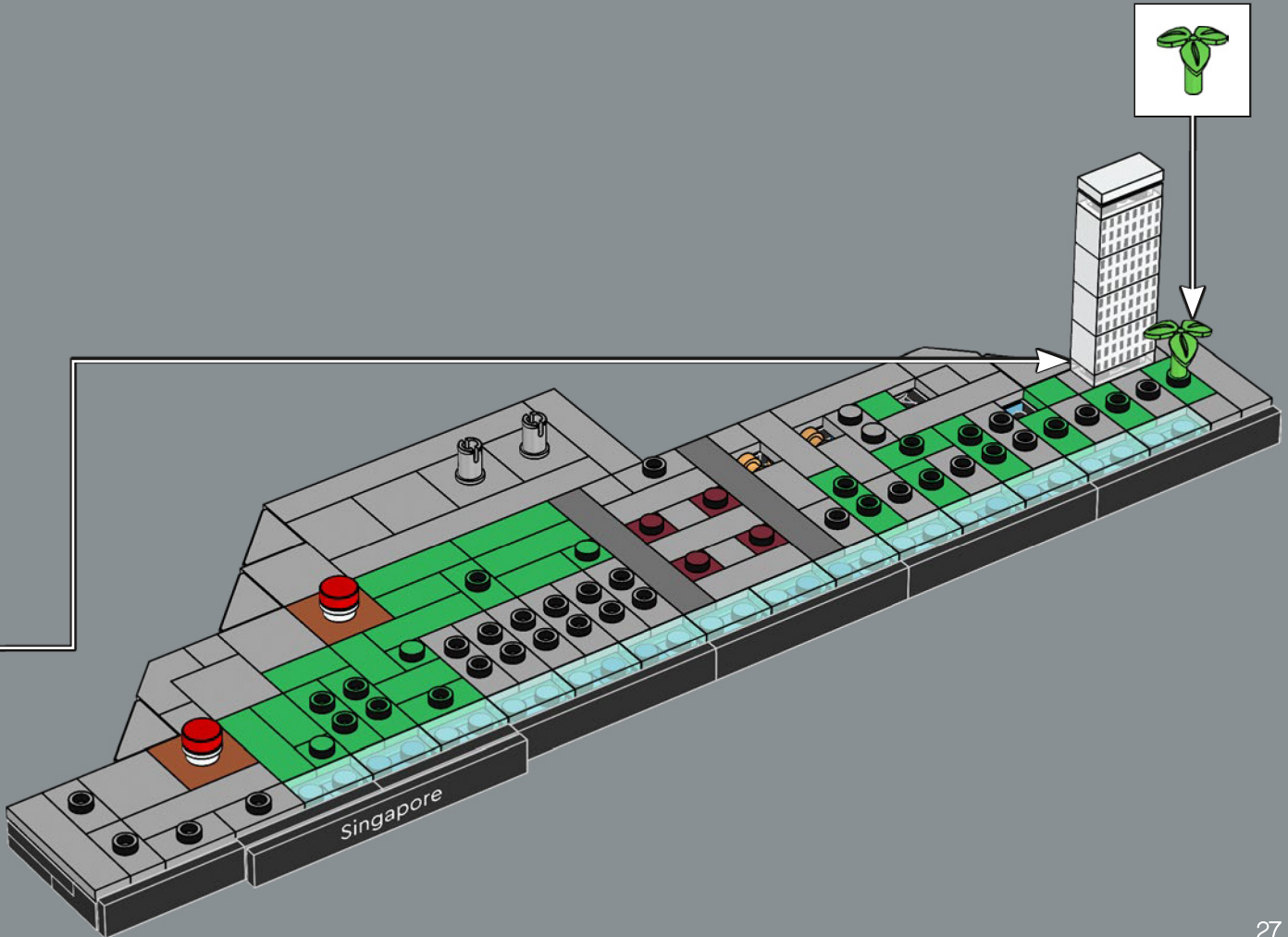

4x	6x	1x	
2x	1x	1x	1x

22

Three vertical diagrams showing the assembly of a brown 1x1 Technic brick with a hole onto different colored base bricks: yellow, black, orange, and green. Green arrows indicate the downward direction of assembly.

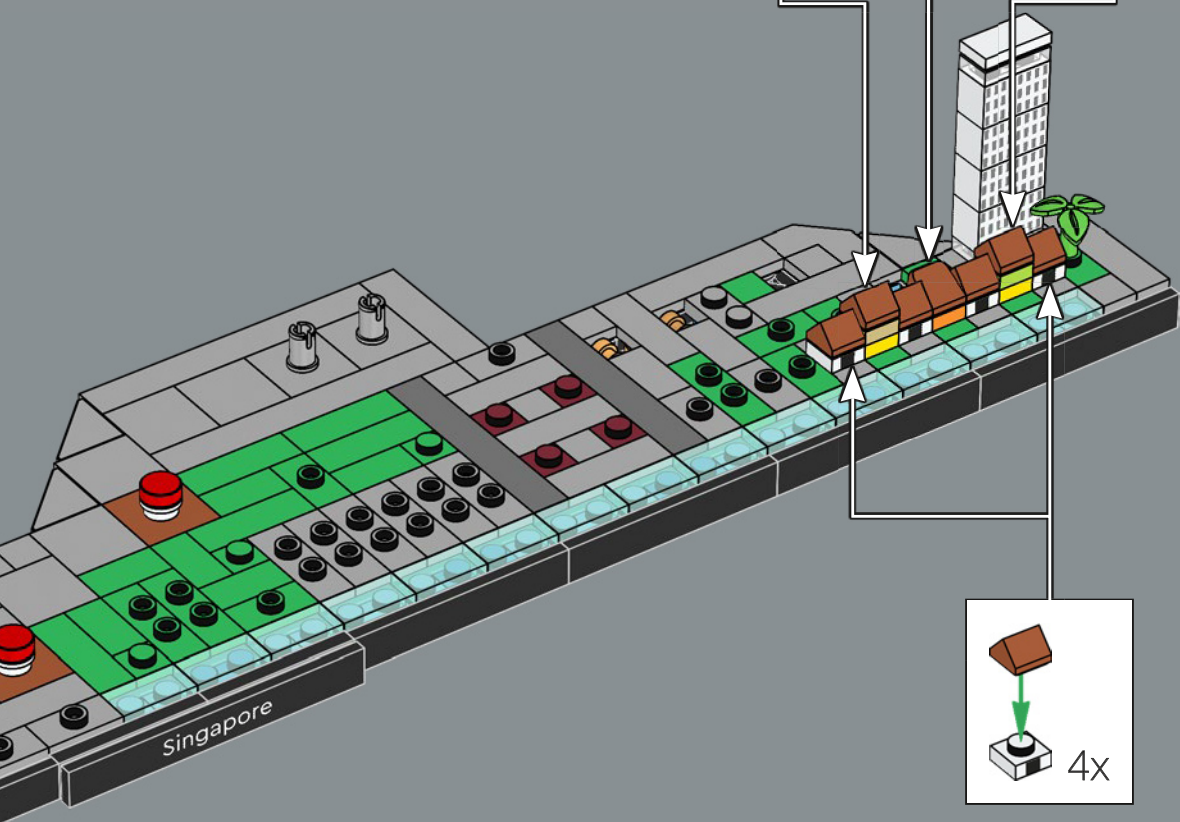

4x



23

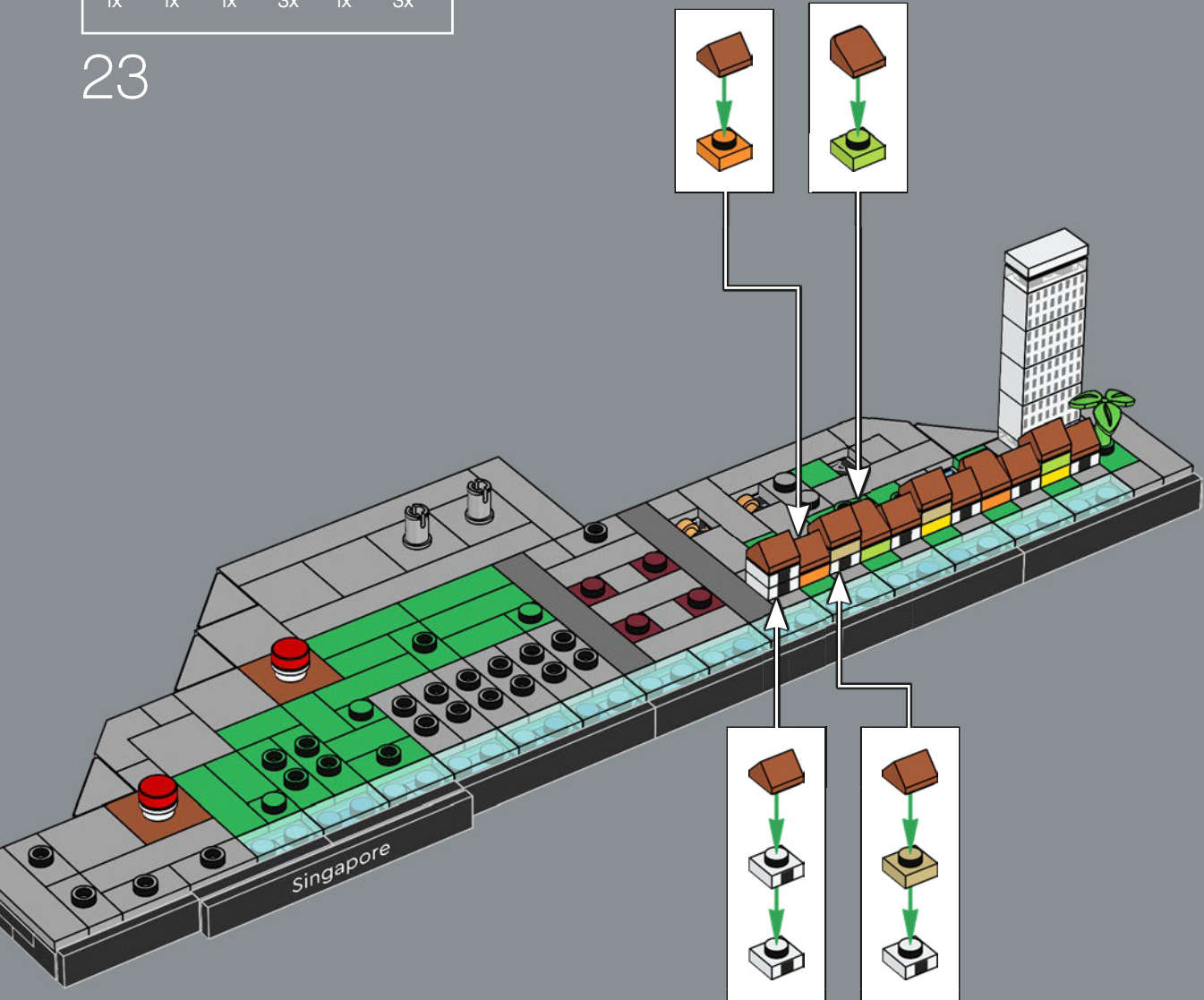

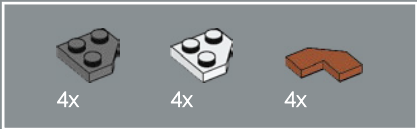

24

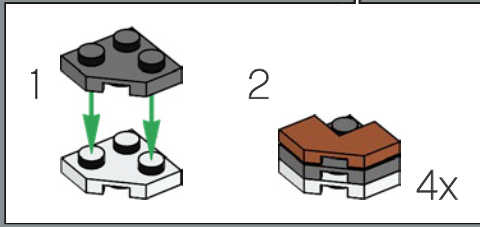
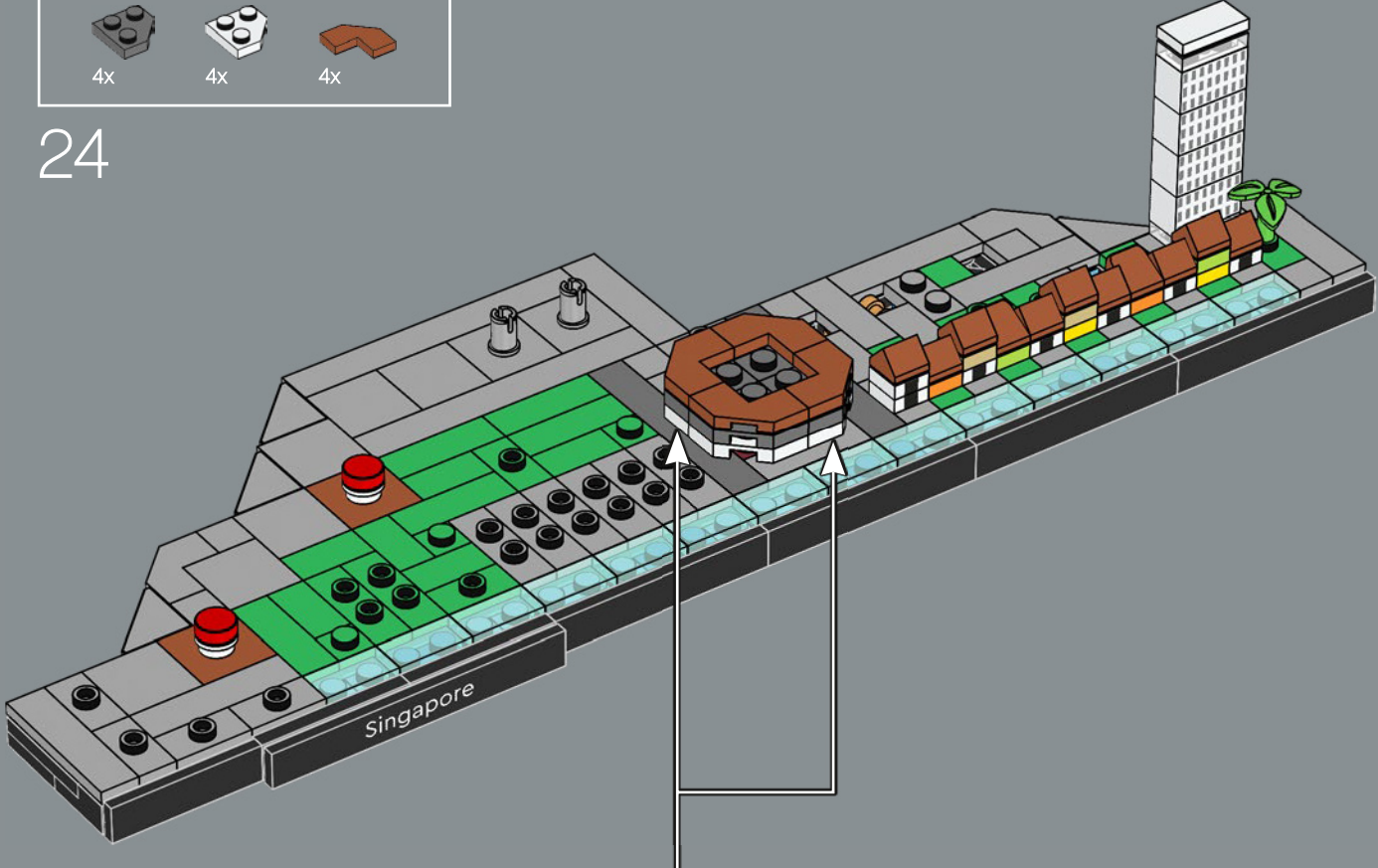

The cast-iron structure is also known as *pasar besi* (market of iron) in the Malay language.

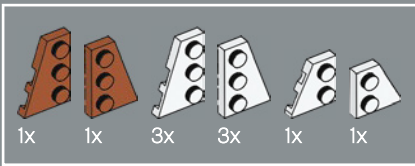

25

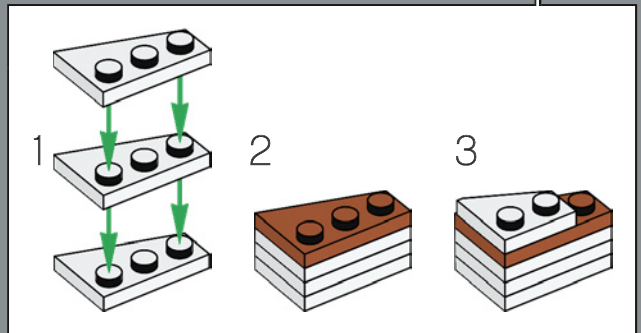
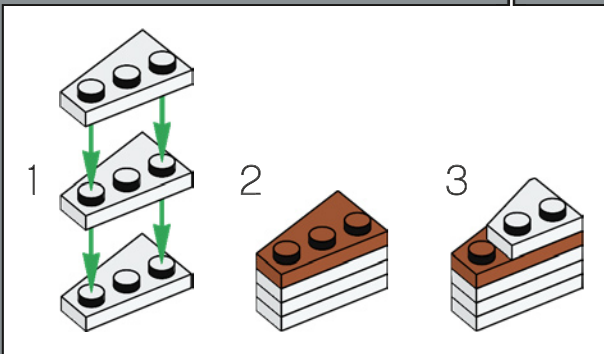
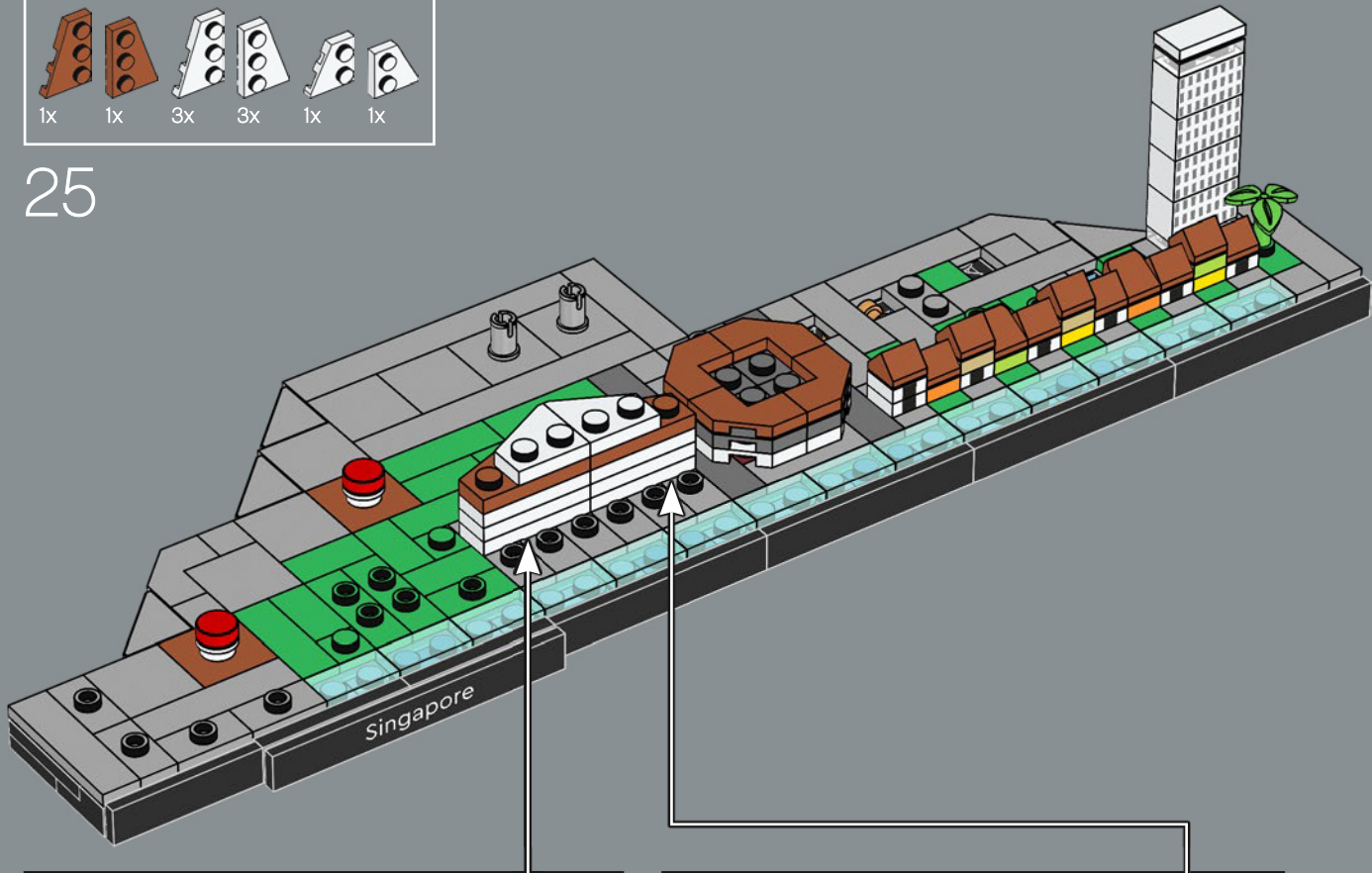

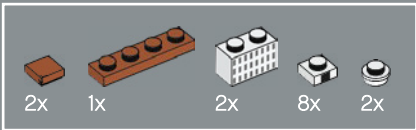

26

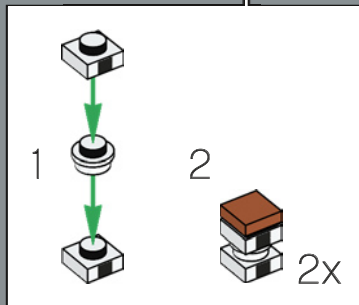
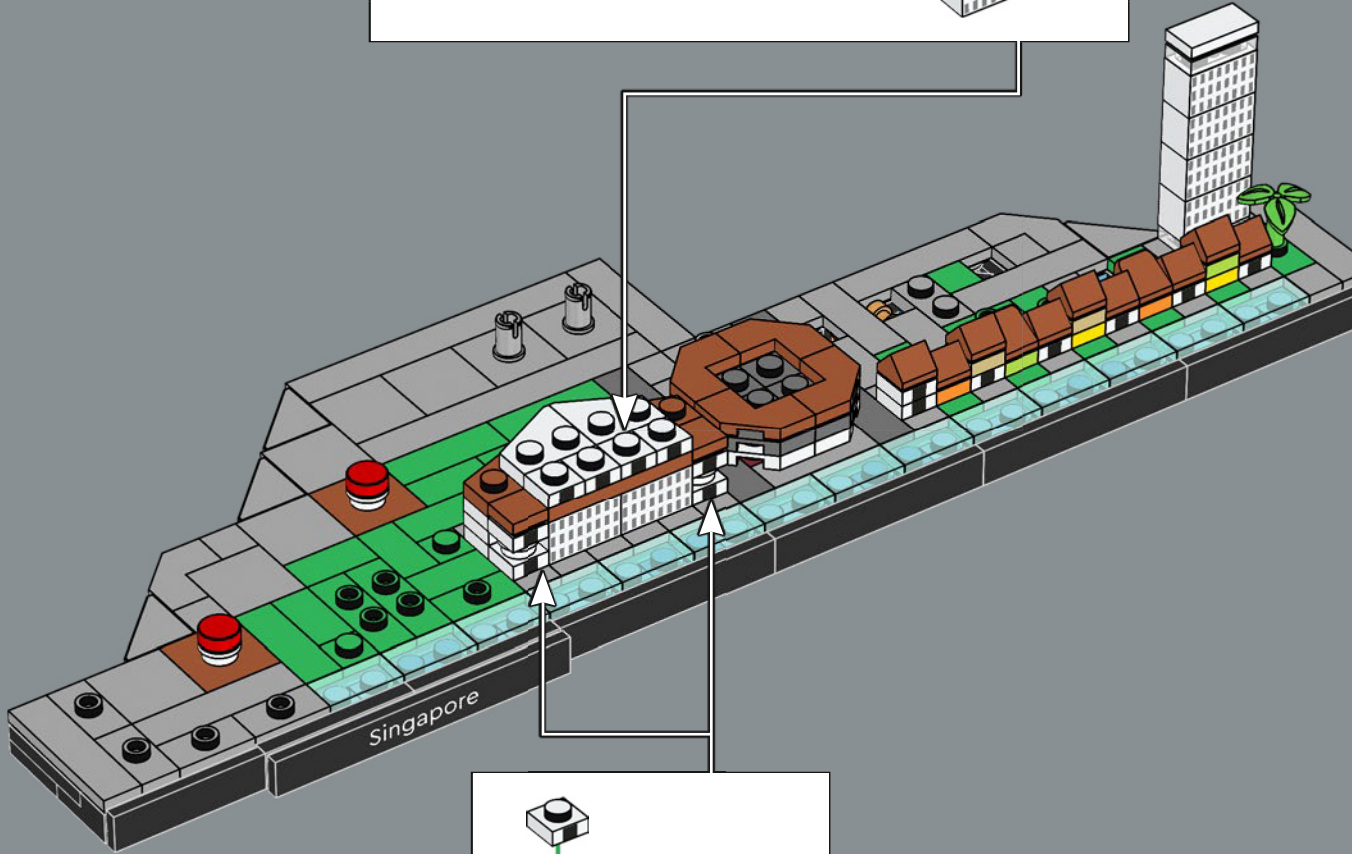
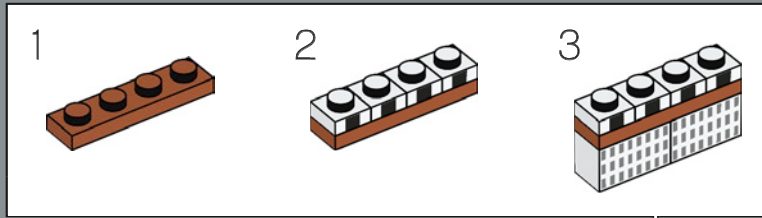



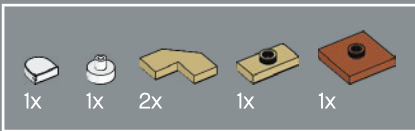

27



The historic structure was designated a National Monument of Singapore on 10 February 2003.

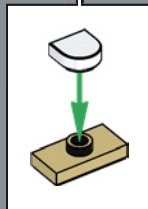
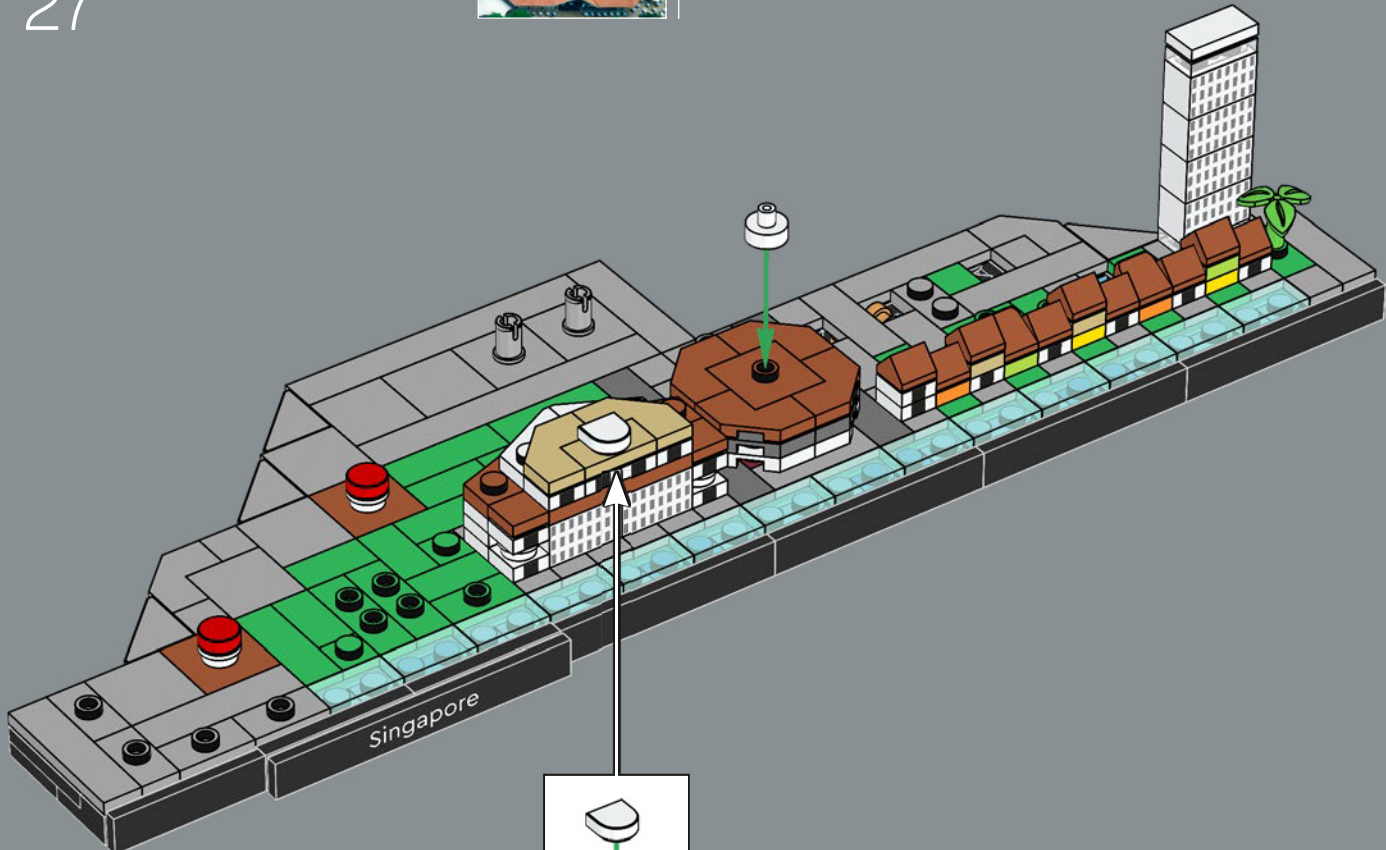



28

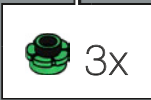
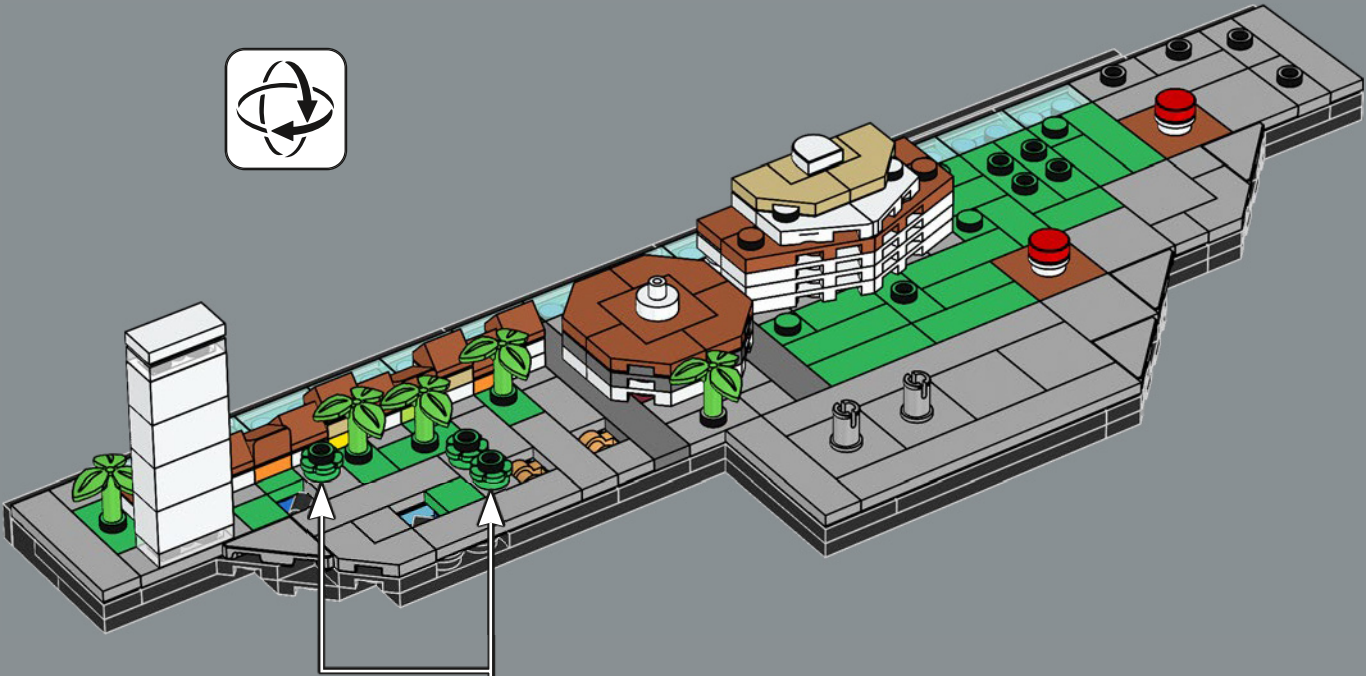

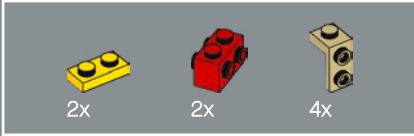
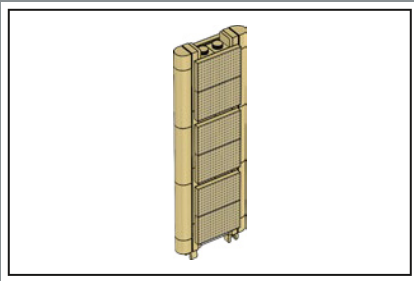

29

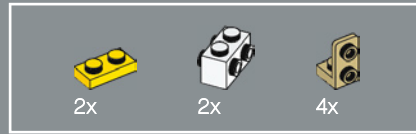
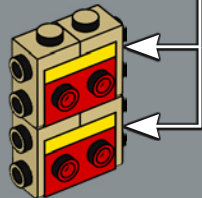
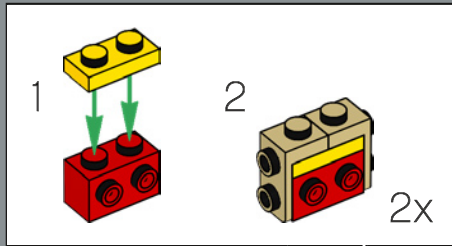

30

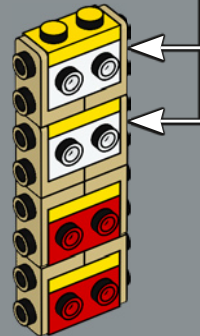
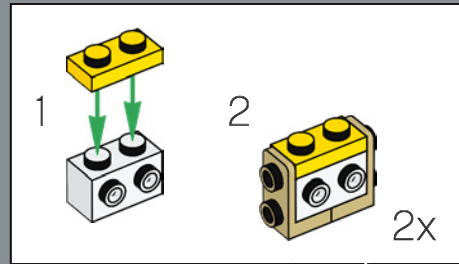



31

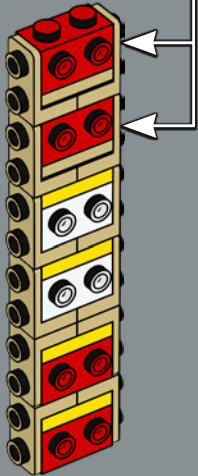
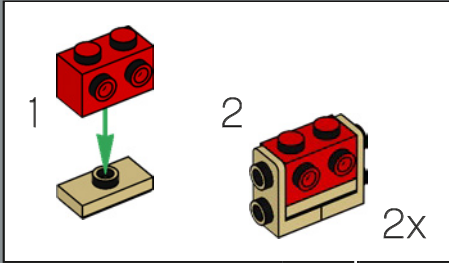

32



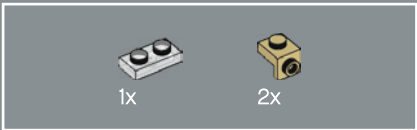

33

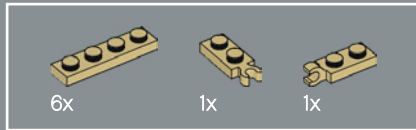
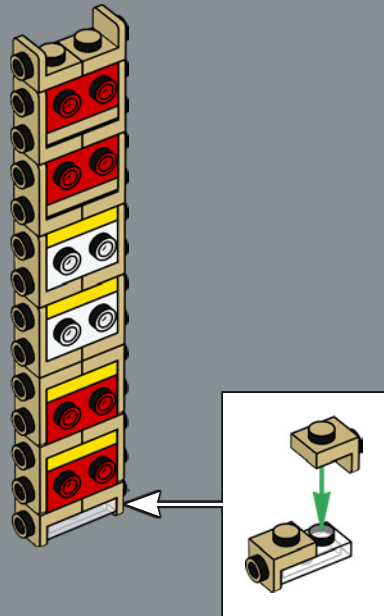

34

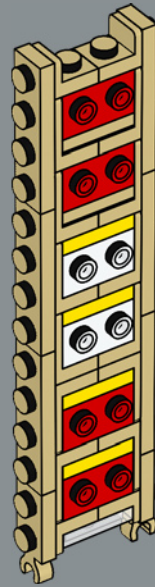



35

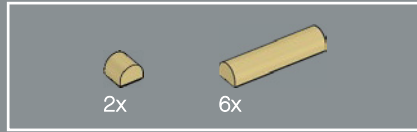
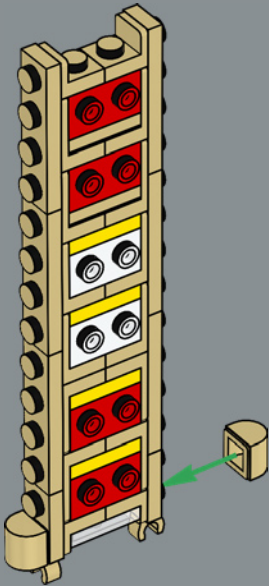

36

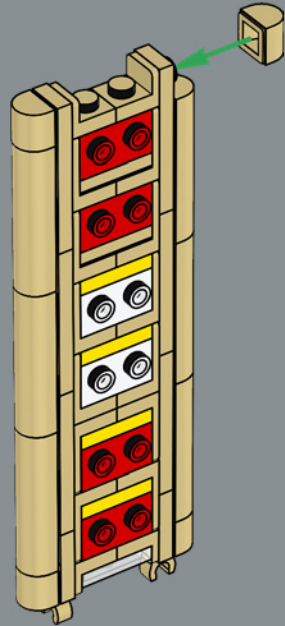

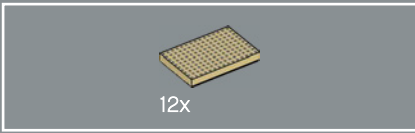

37



The LEGO® version of the OCBC Centre is a good example of sideways LEGO building.

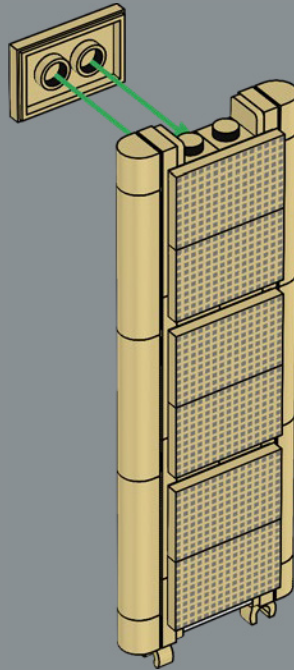

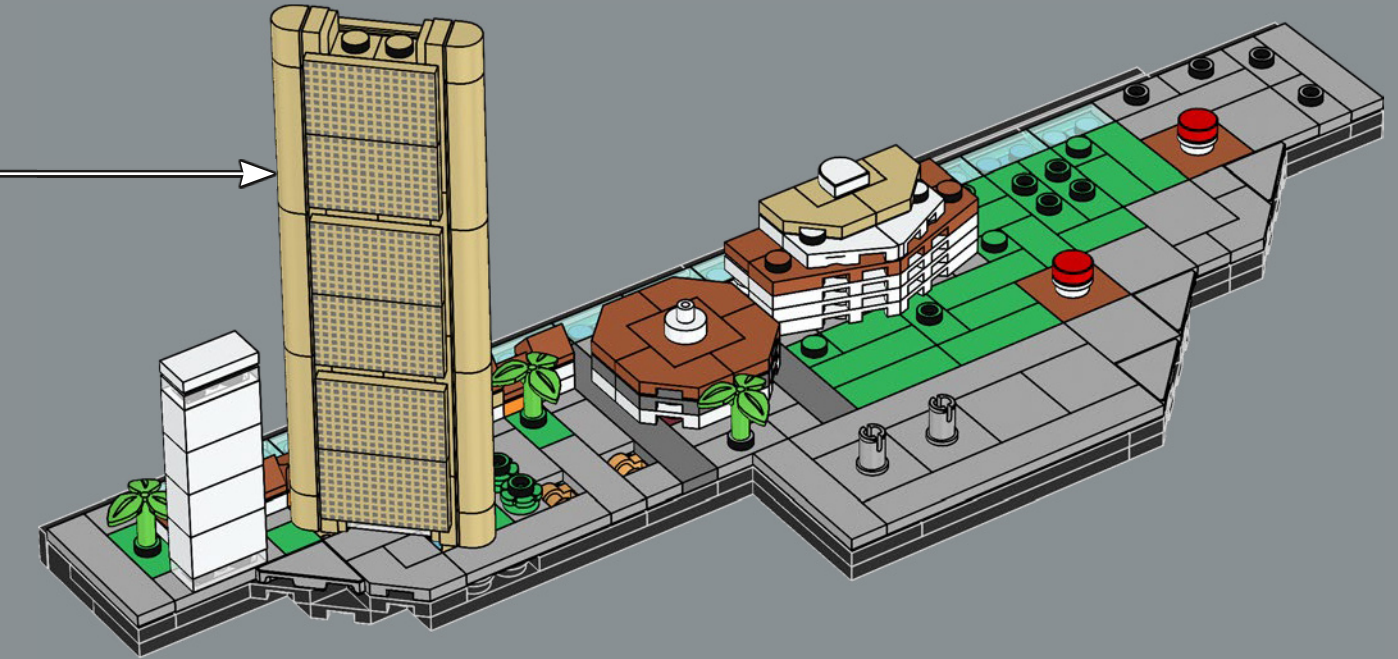



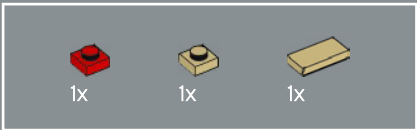

The OCBC Centre is nicknamed 'The Calculator', due to its flat shape and windows which look like button pads.

39

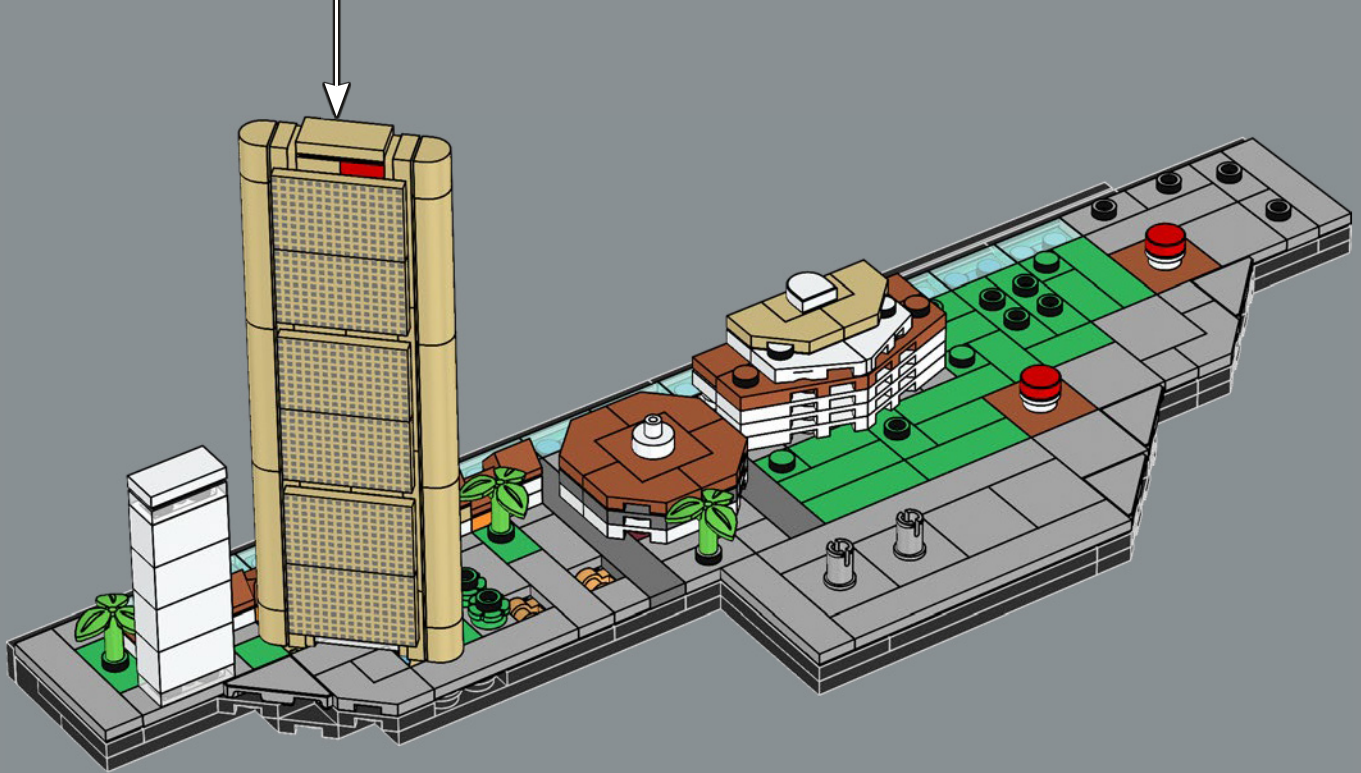
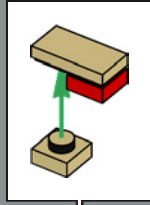

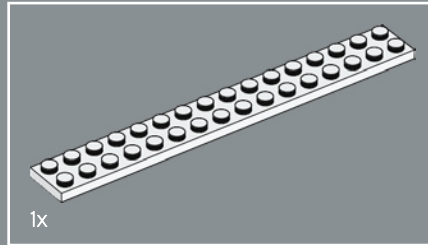
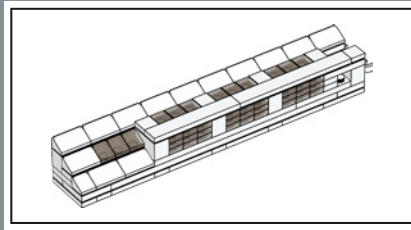
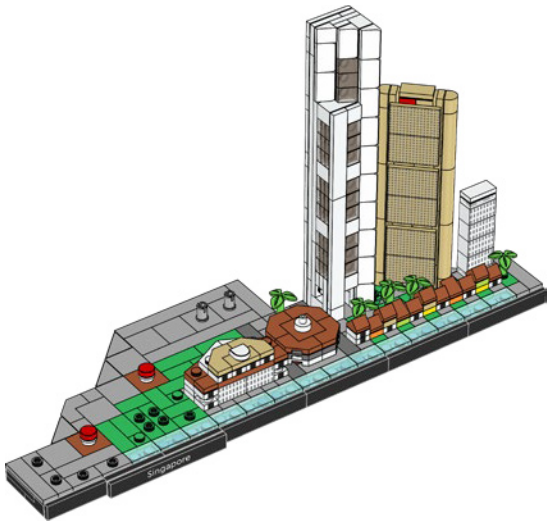
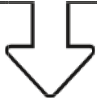

40

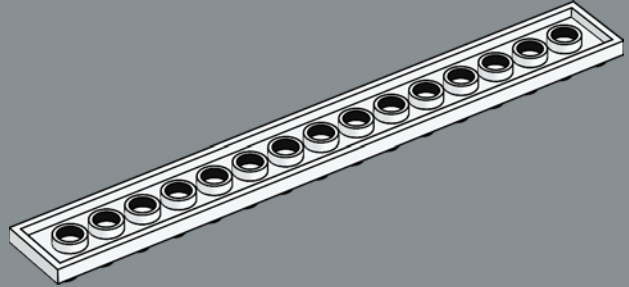

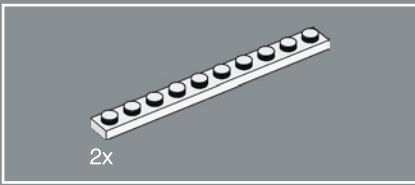

41

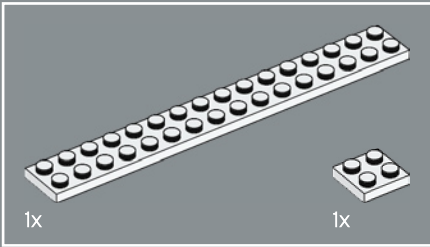
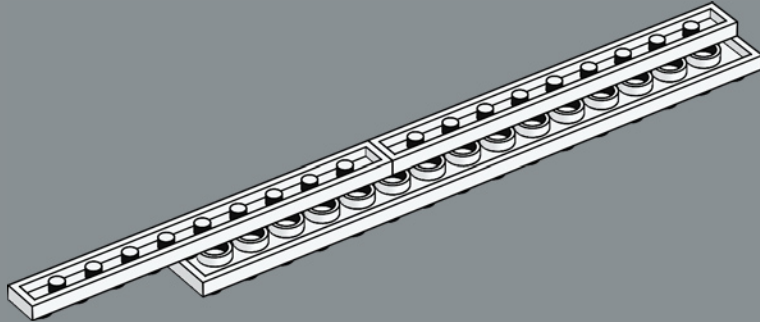

42

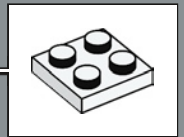
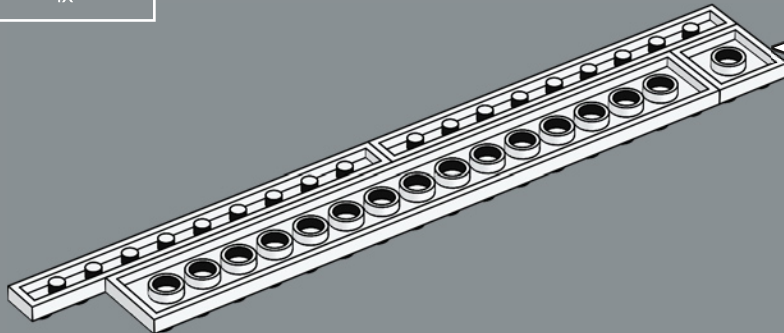

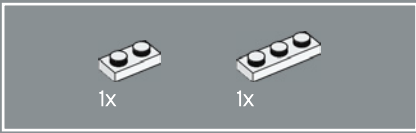

43

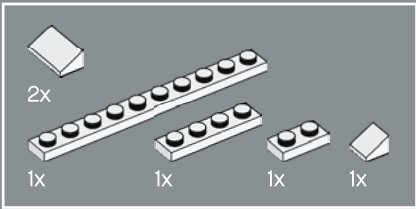
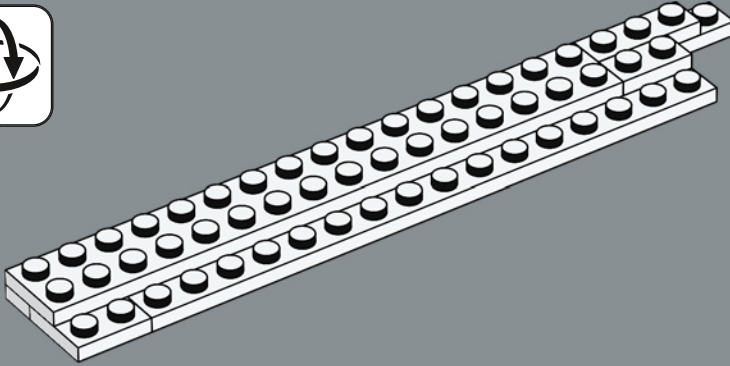

44

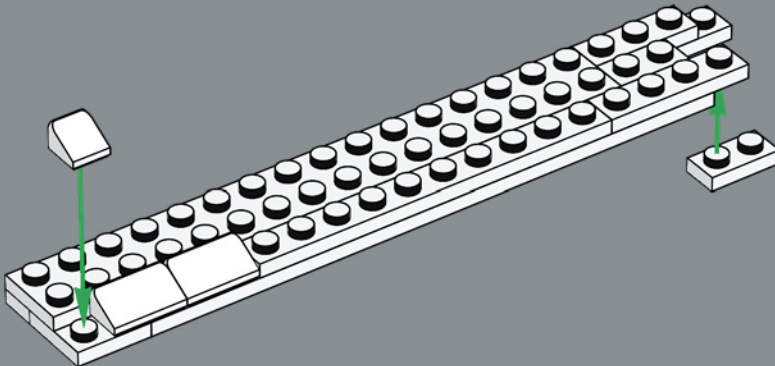

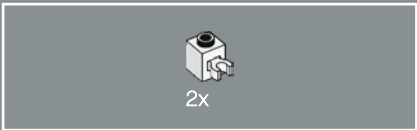

45

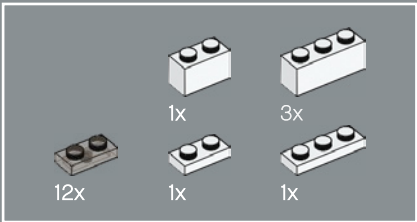
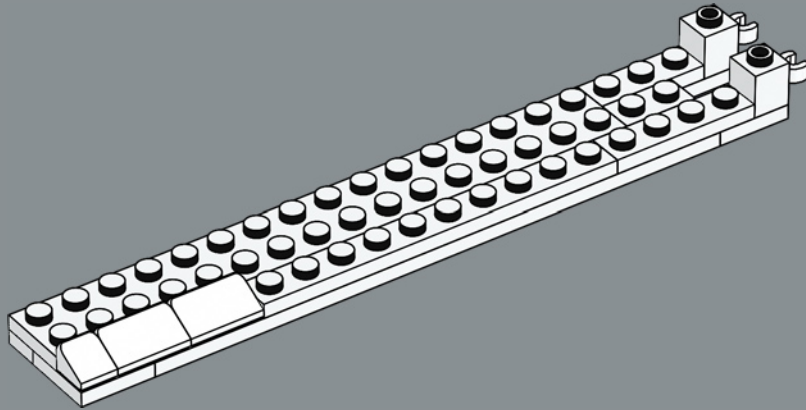

46

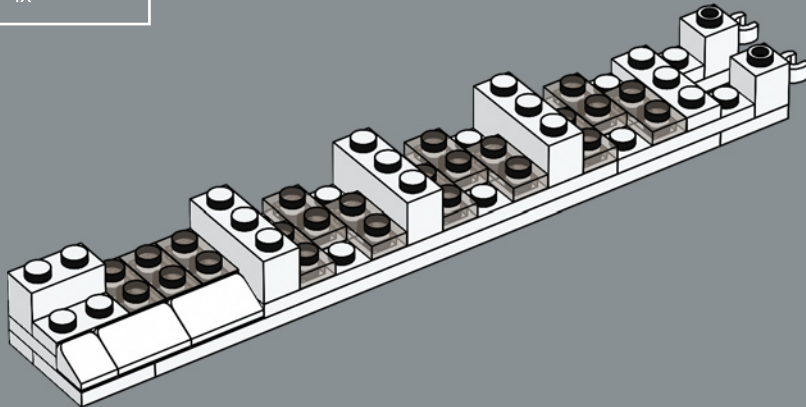

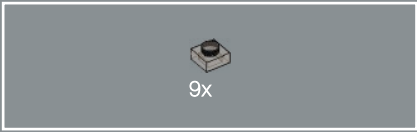

47

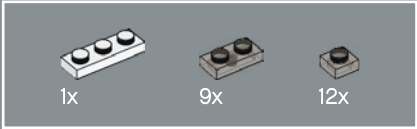
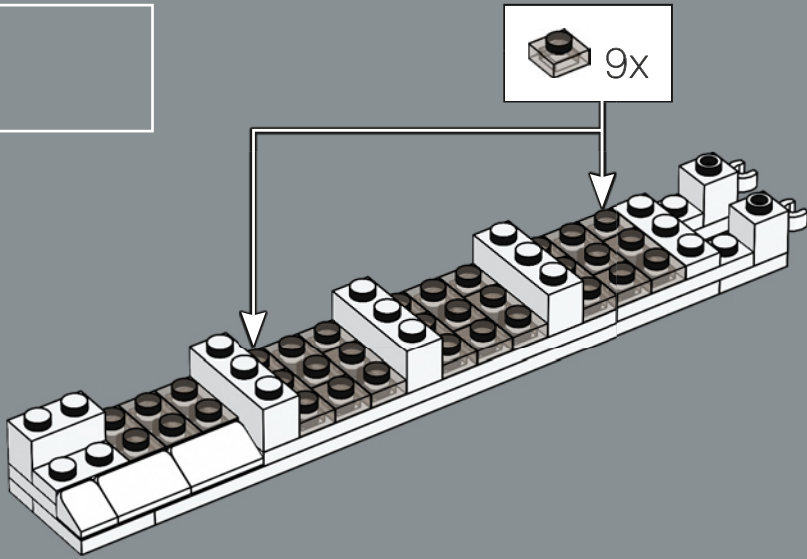

48

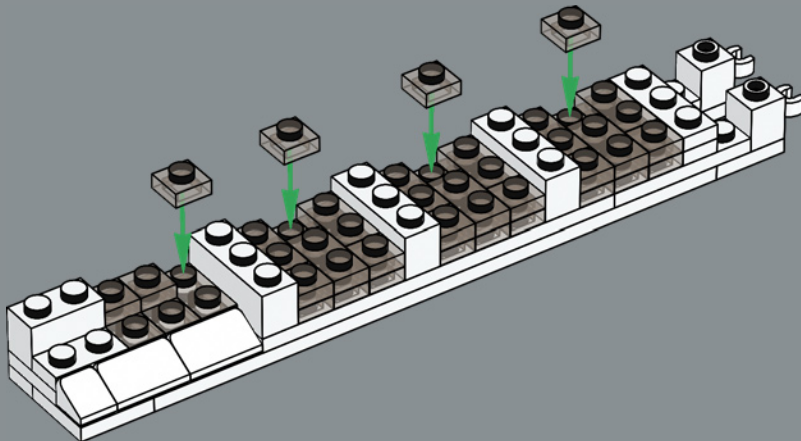

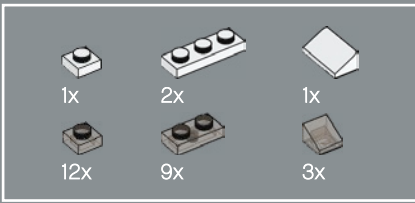

49

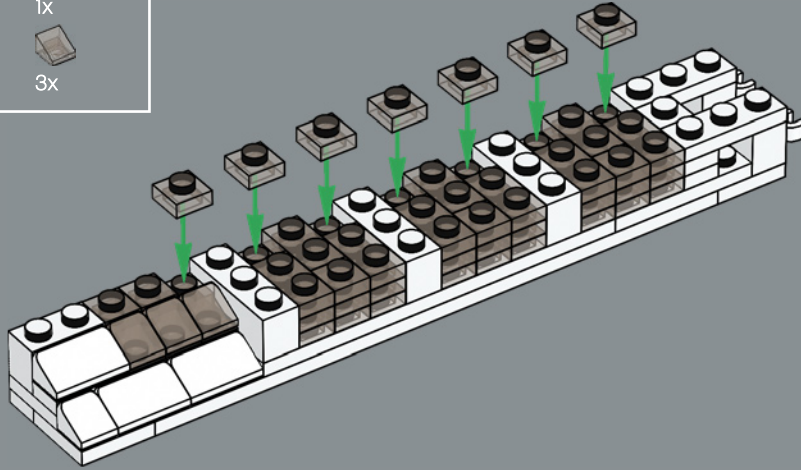

50

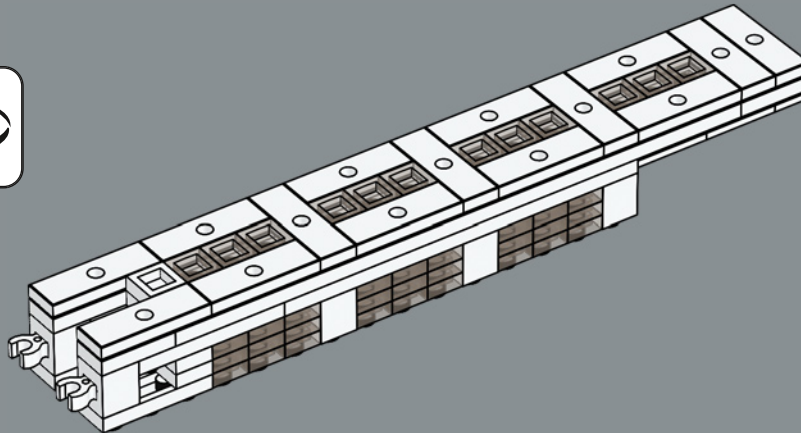

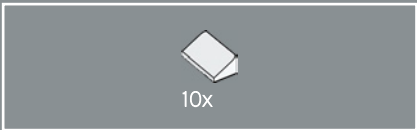

51

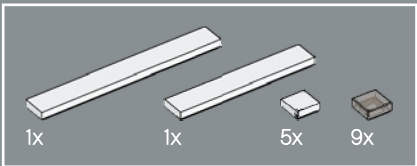
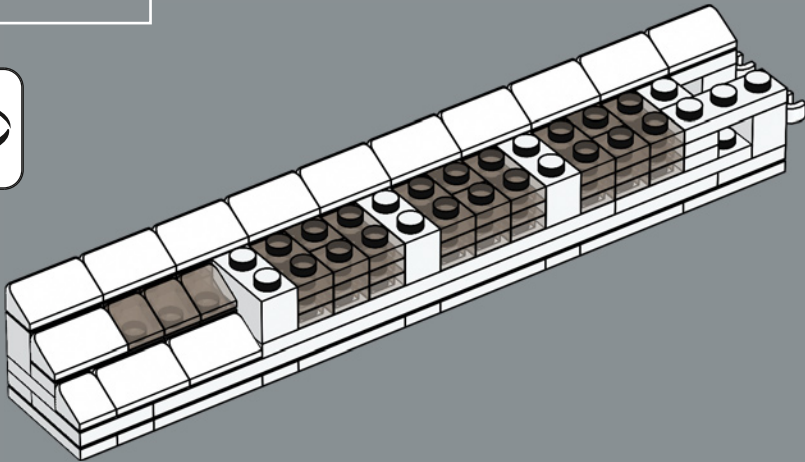

52

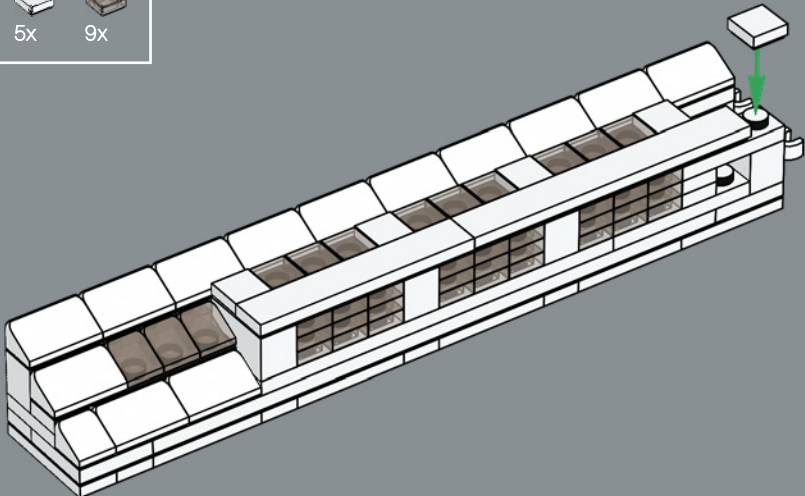



One Raffles Place was the tallest skyscraper in the world outside the US and Canada when completed.



53

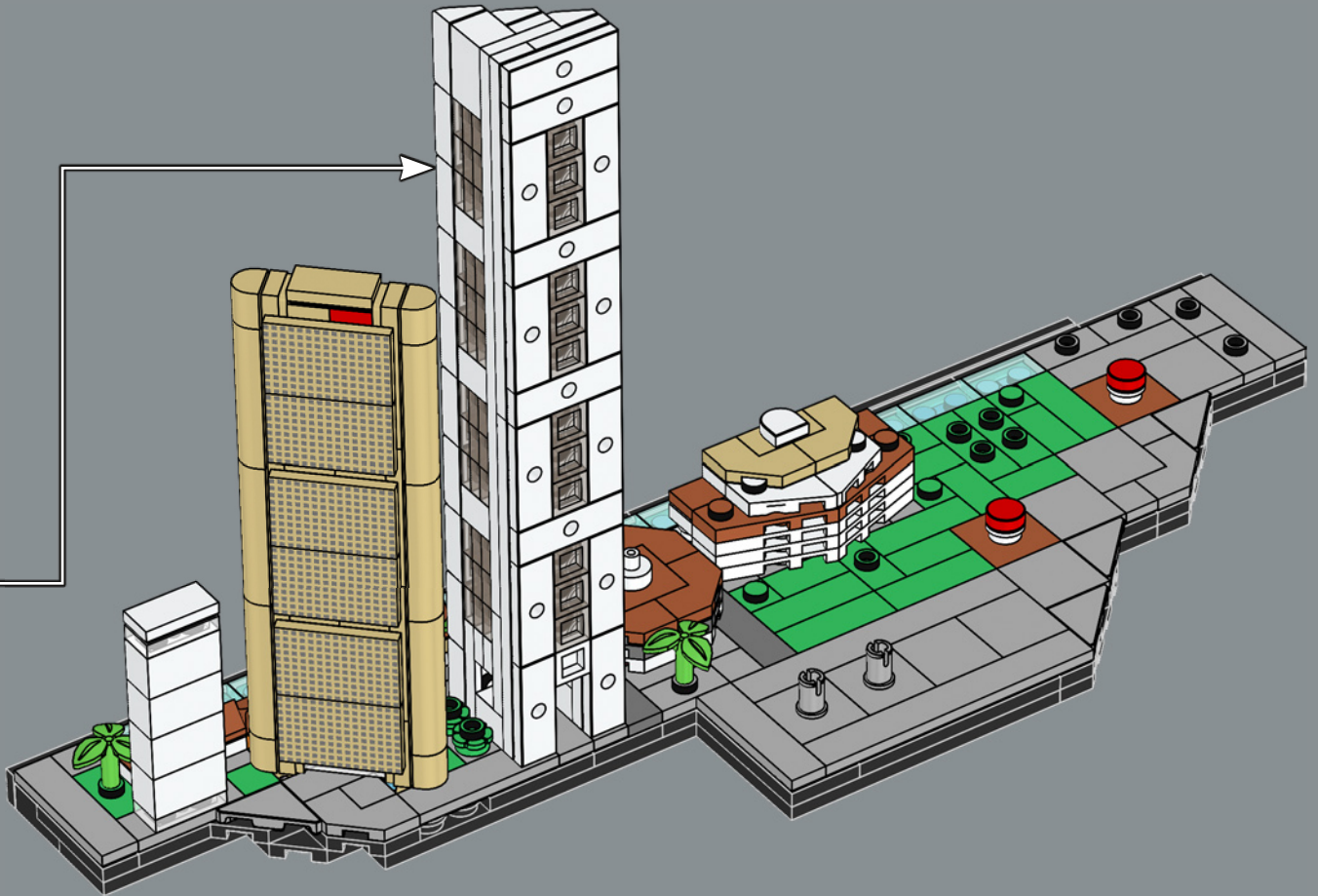

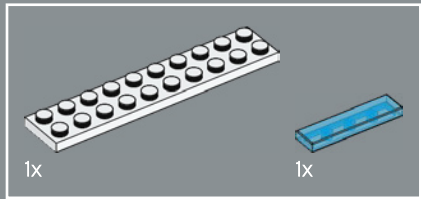
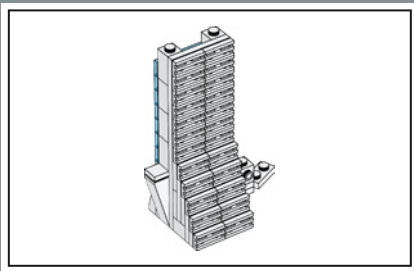
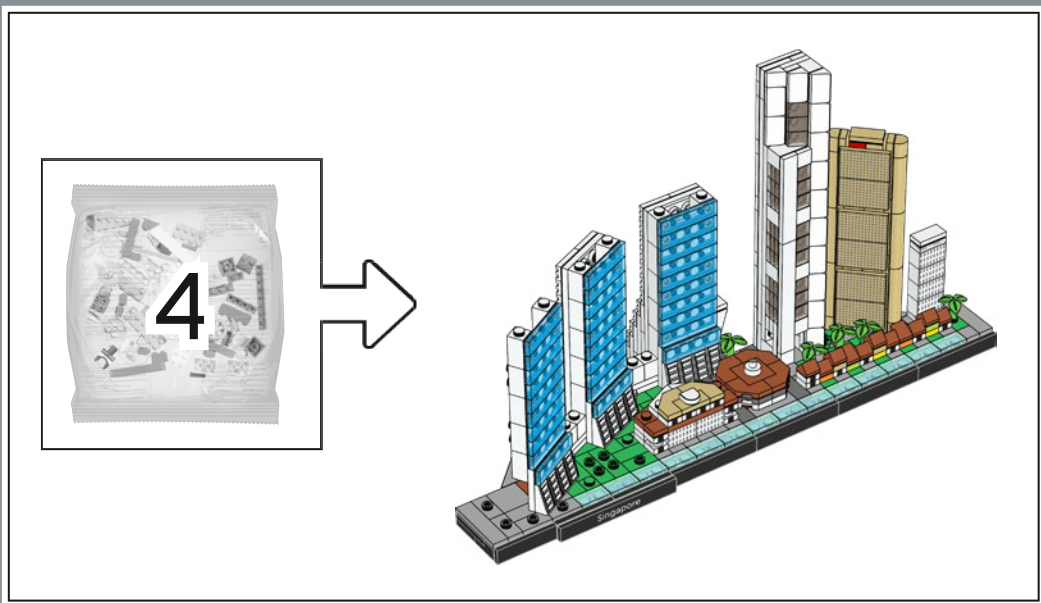

54

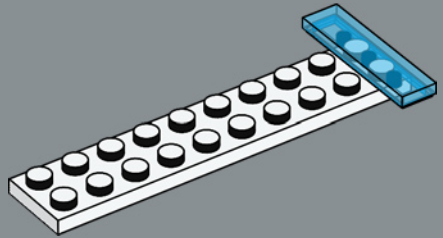

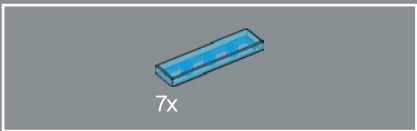

55

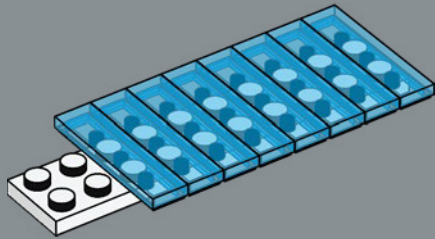

56

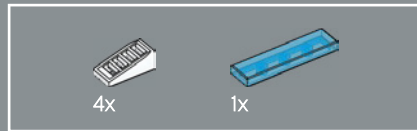
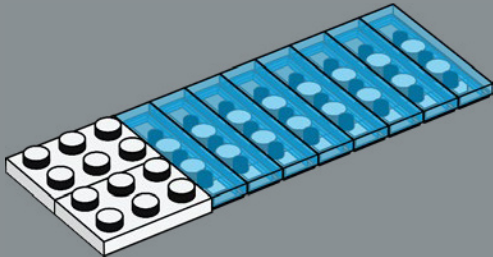

57

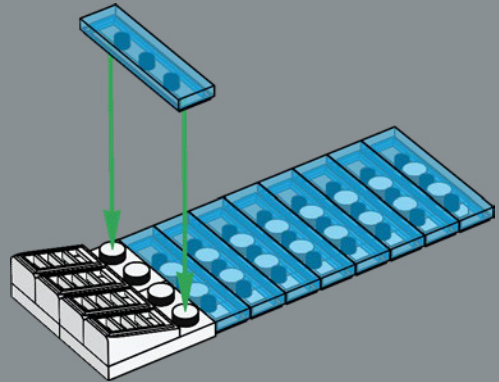

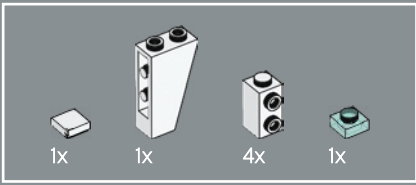

58

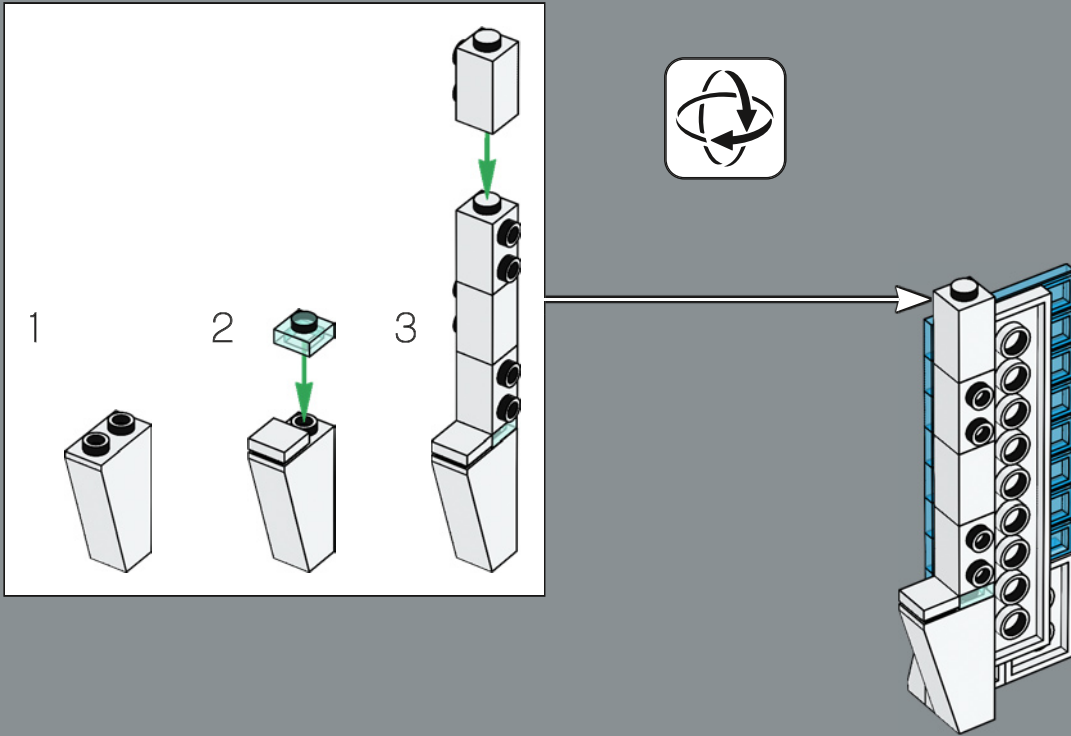

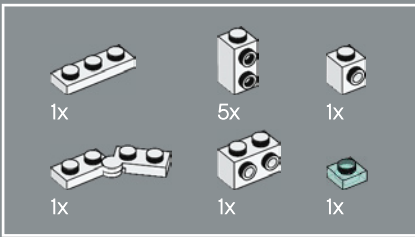

59

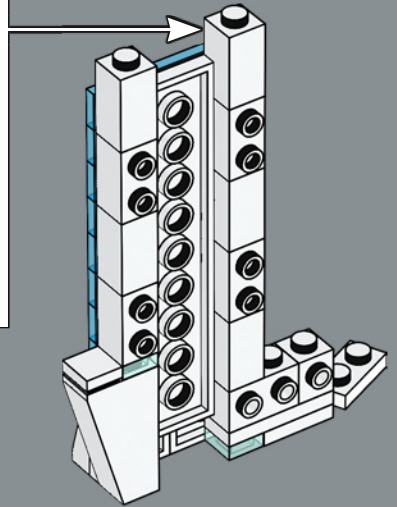
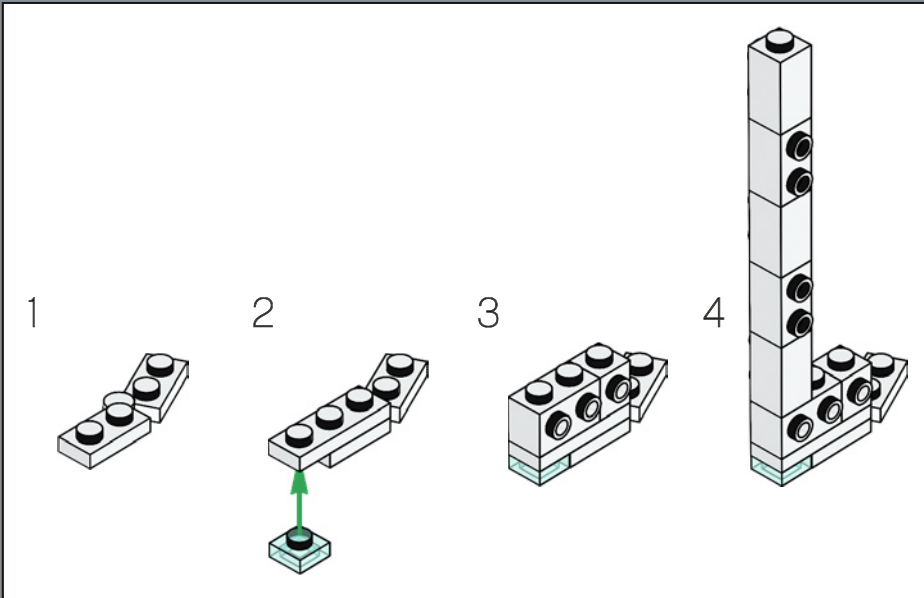



2x

60

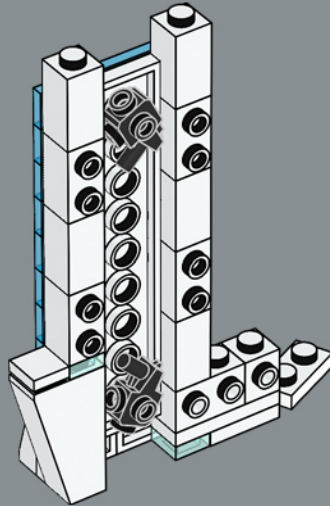

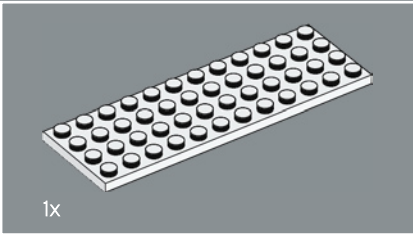
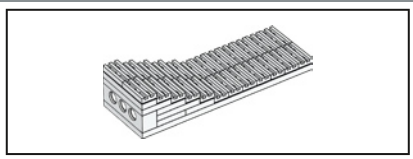

1x

61

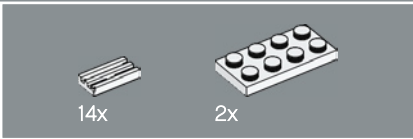
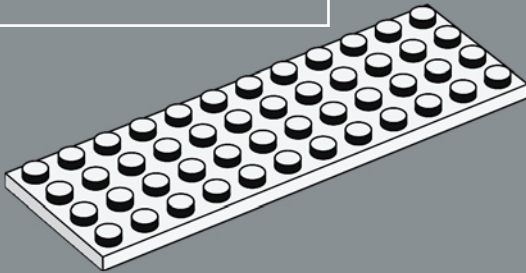

14x

2x

62

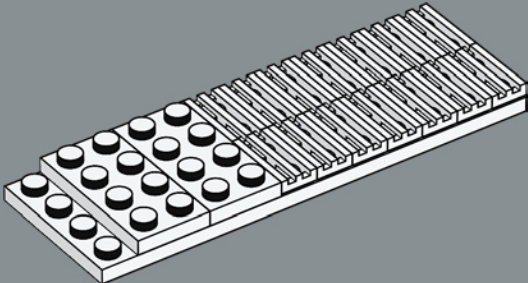

2x

63

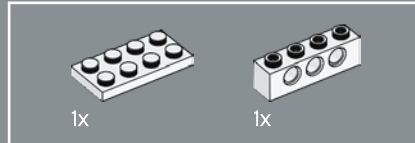
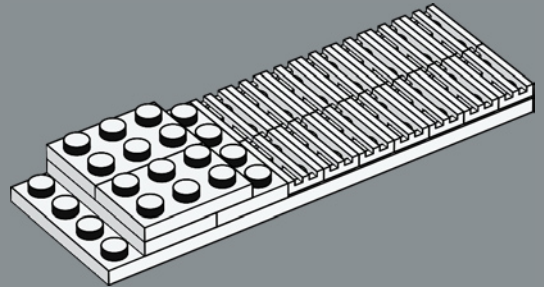

1x

1x

64

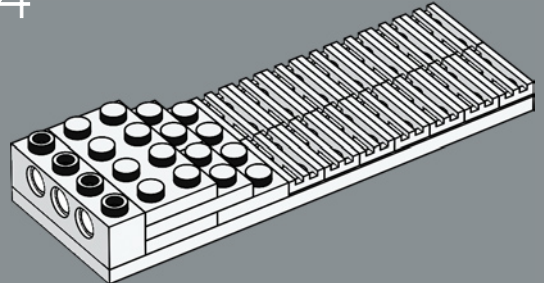

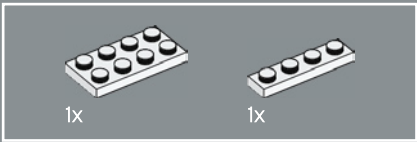

65

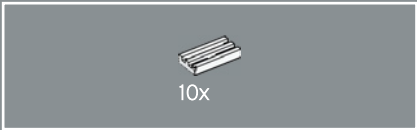
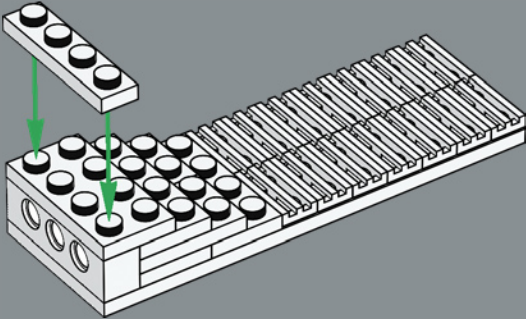

66

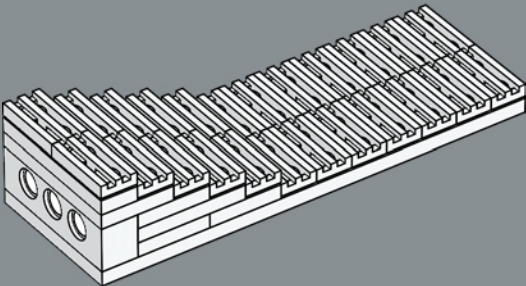

67

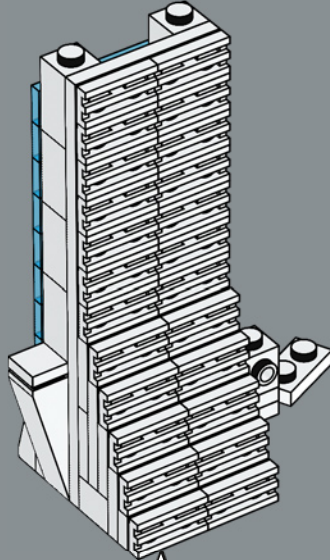



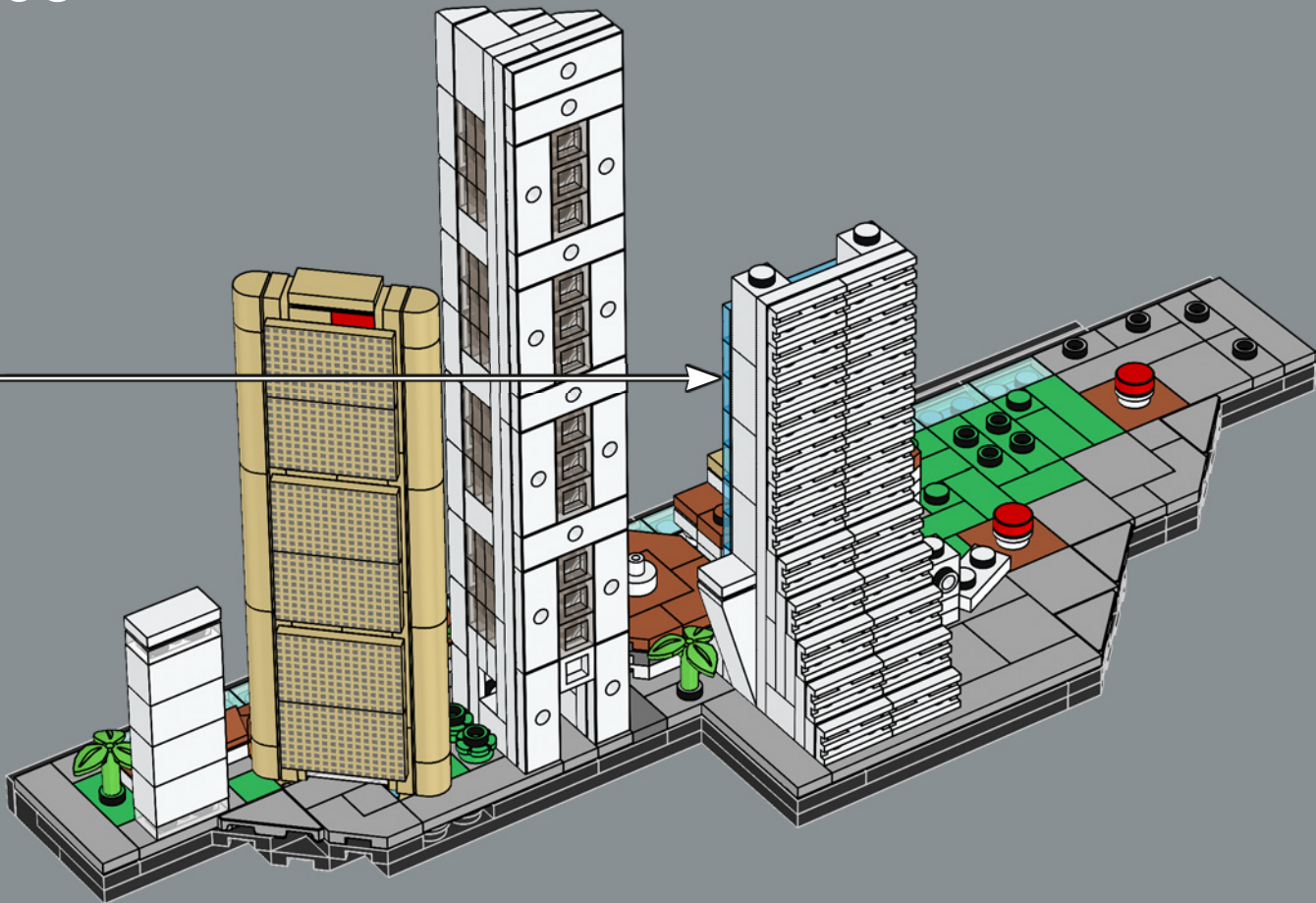

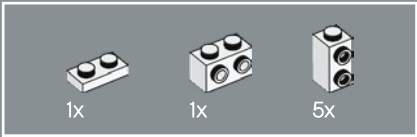

69

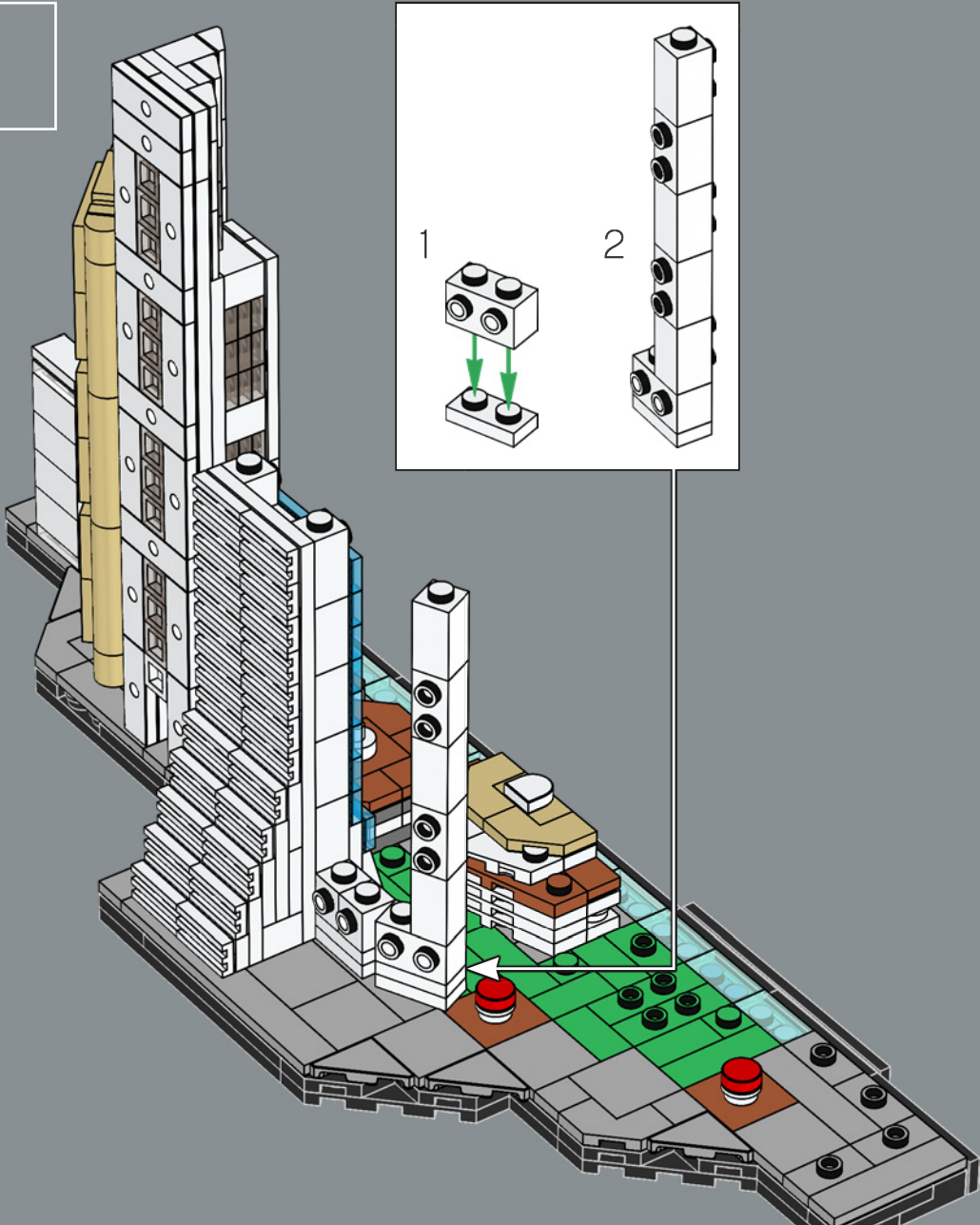

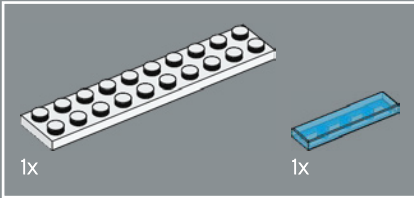
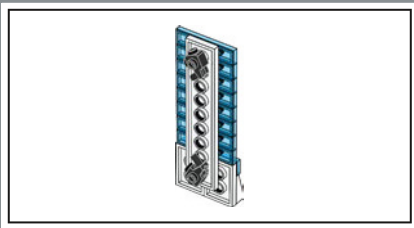

70

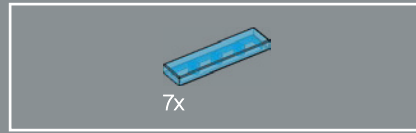
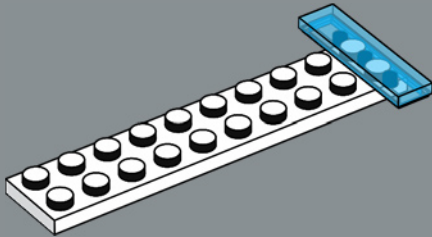

71

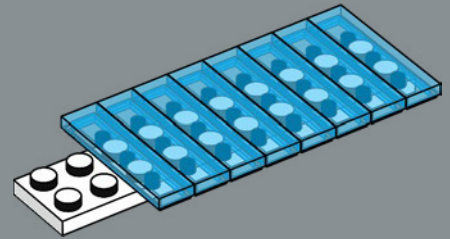

72

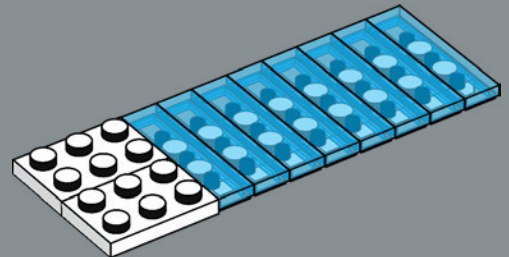

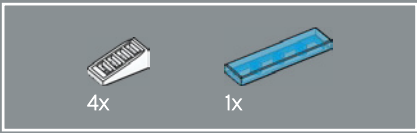

73

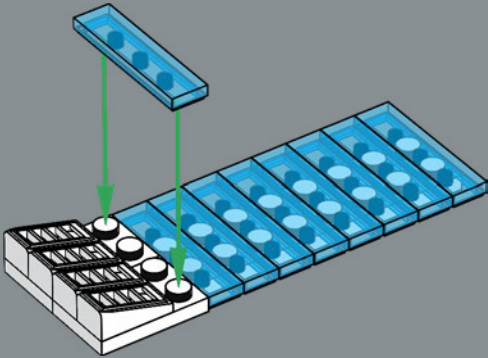

74

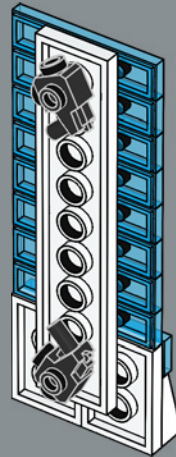

75

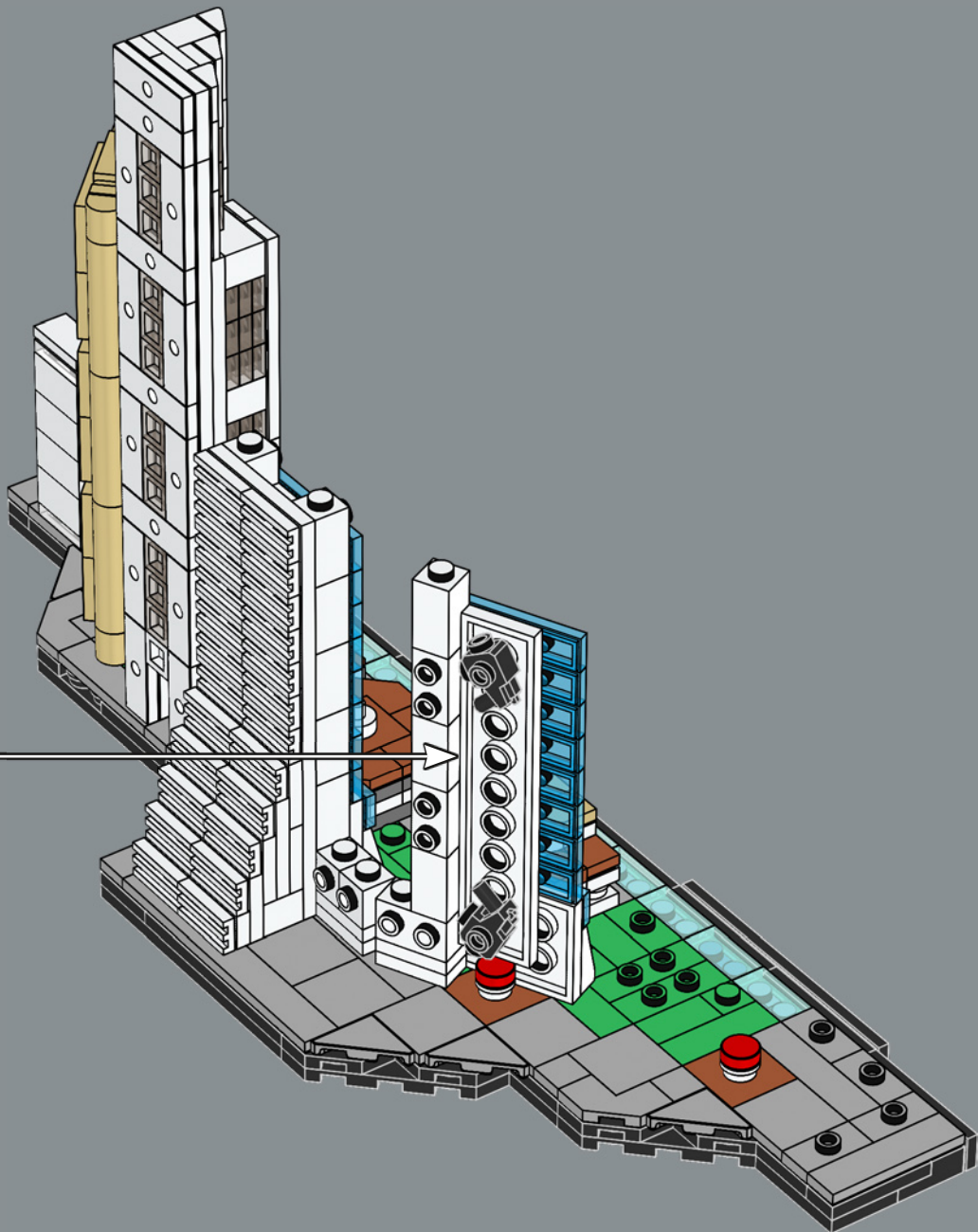

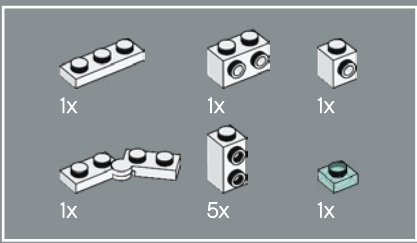

76

1

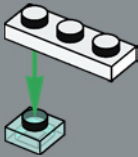

2



3

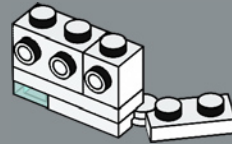

4

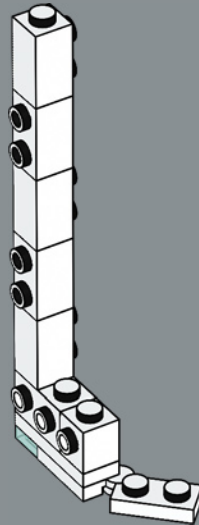

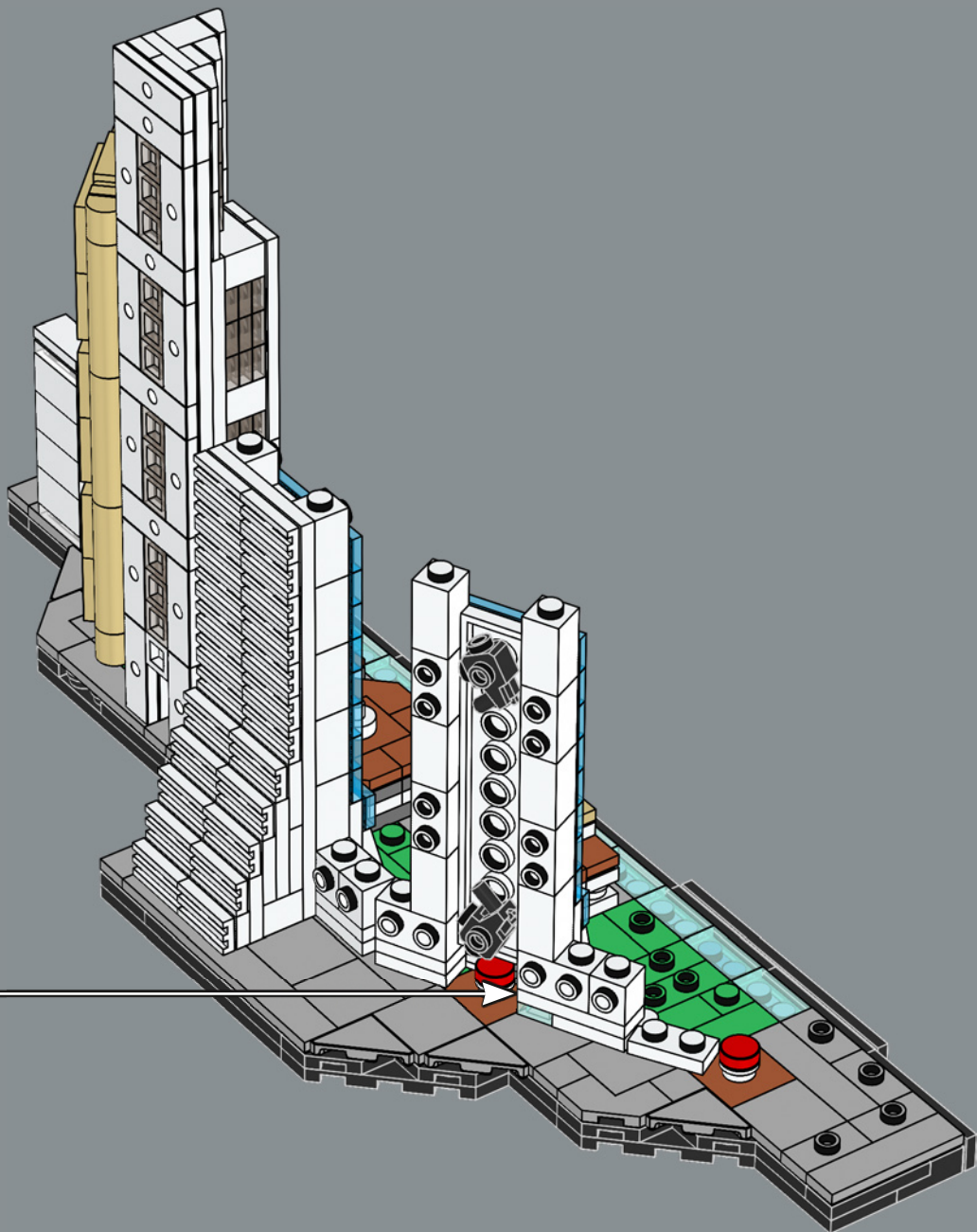

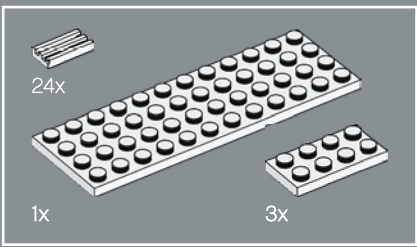

77

1

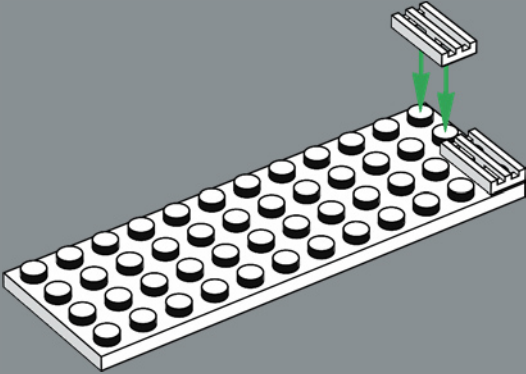

2

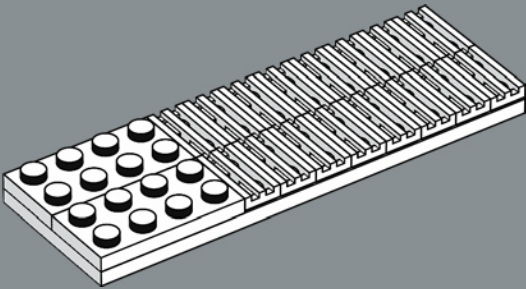

3

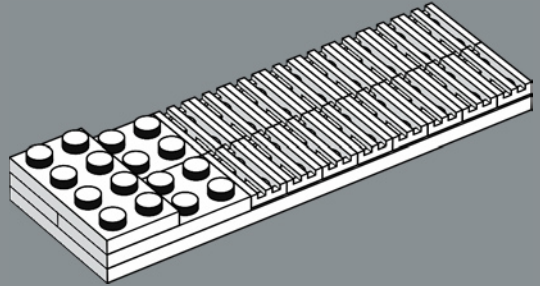

4

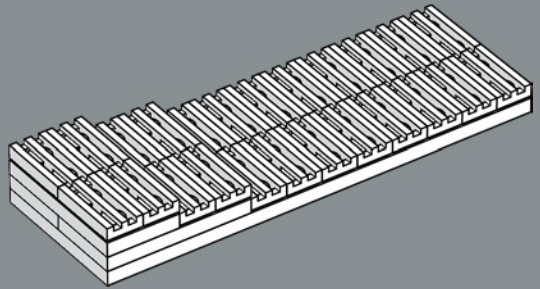



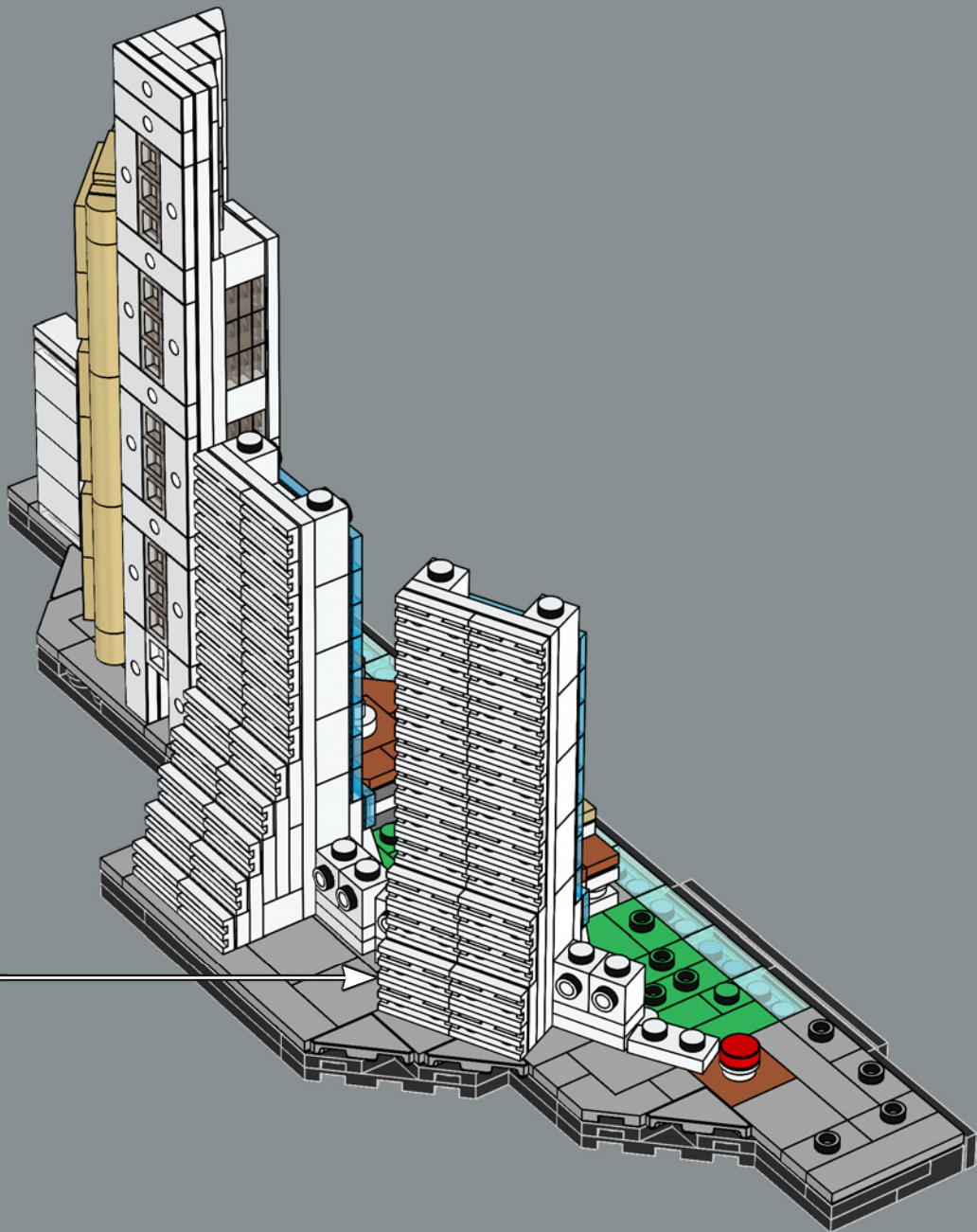

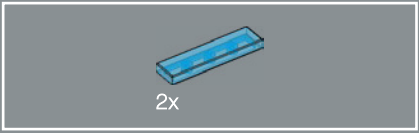

78

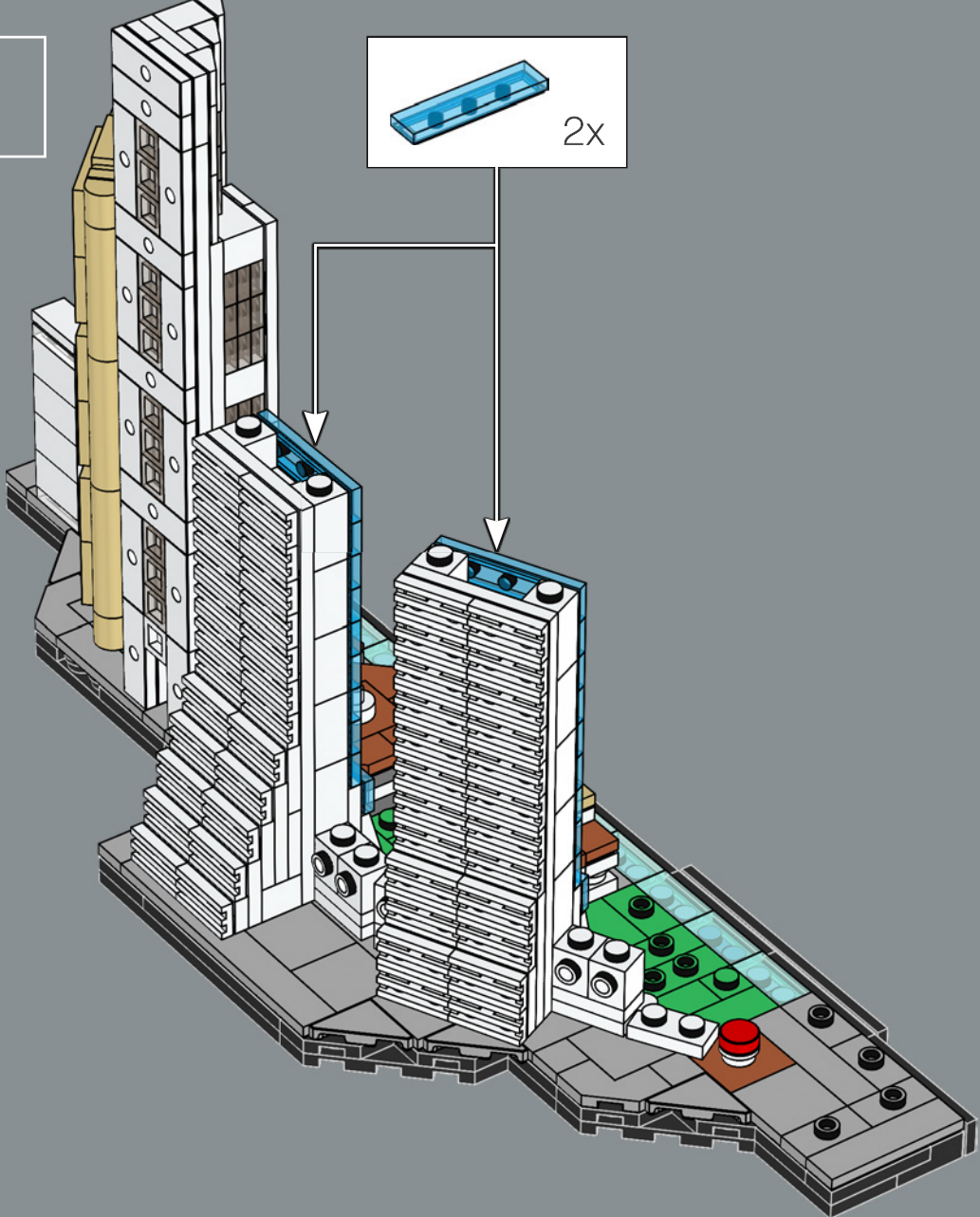
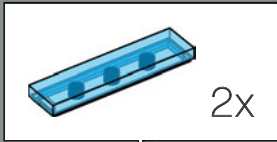

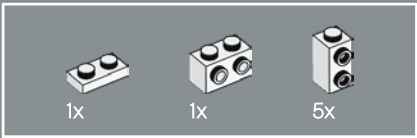

79

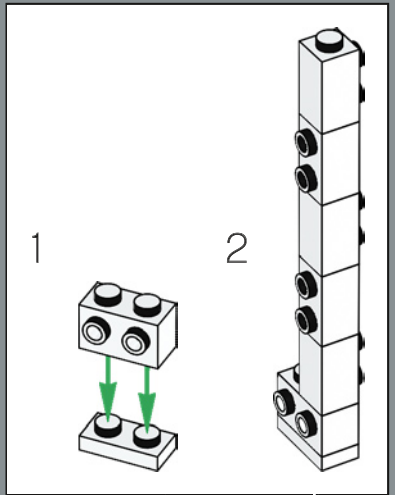
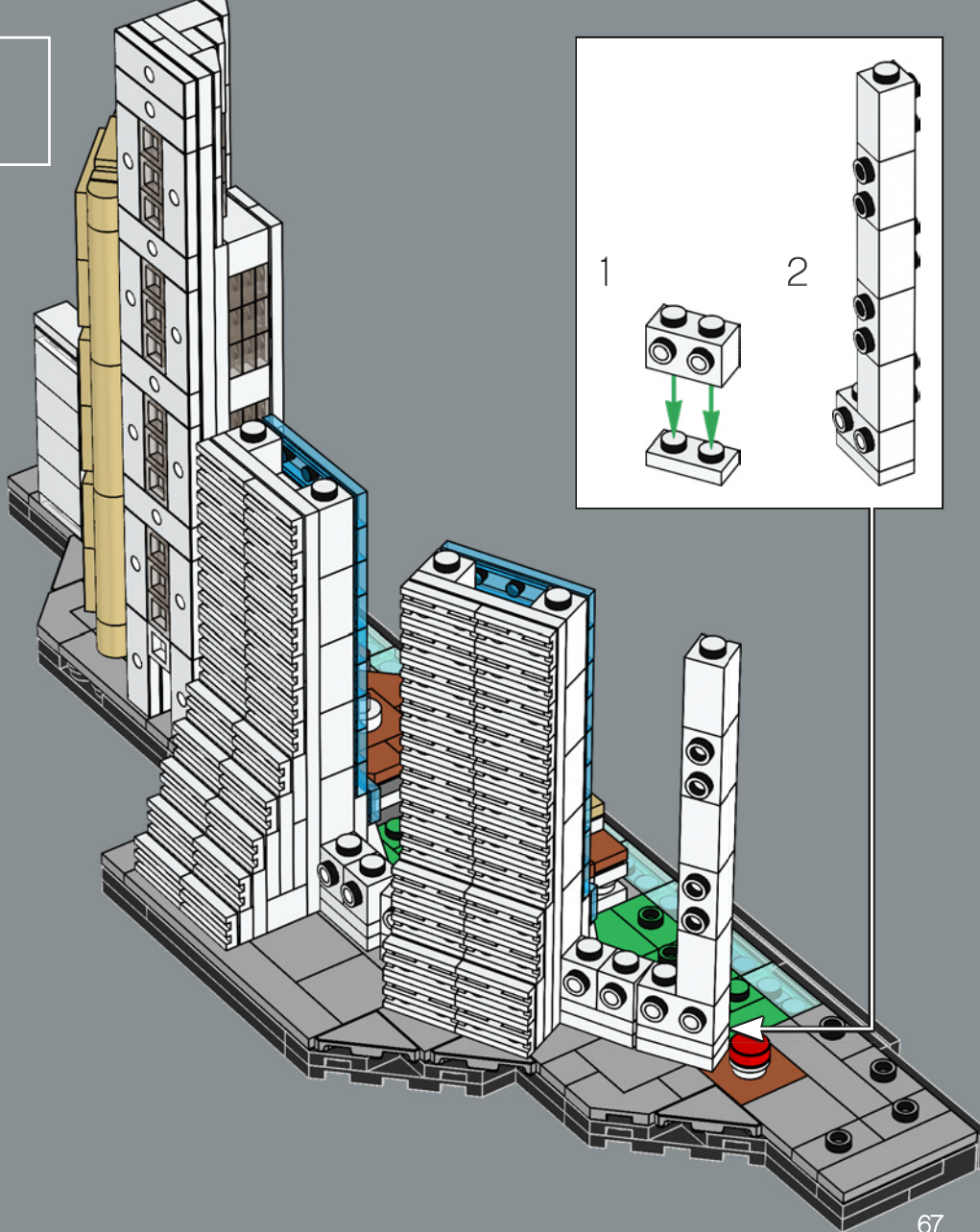

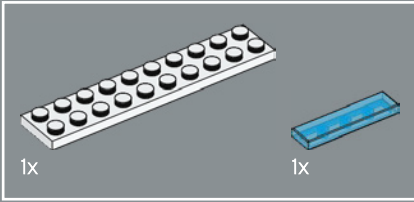
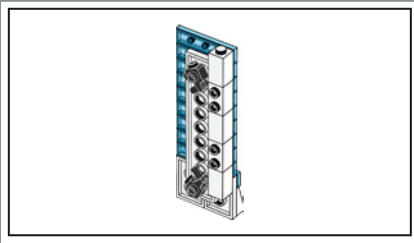

80

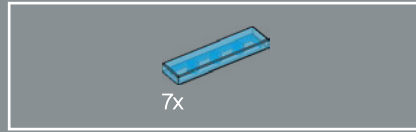
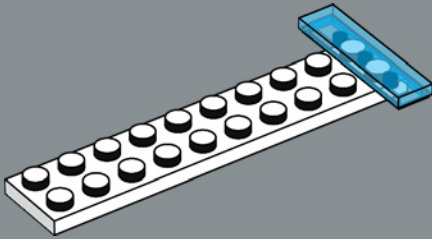

81

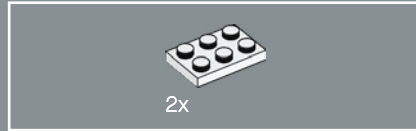
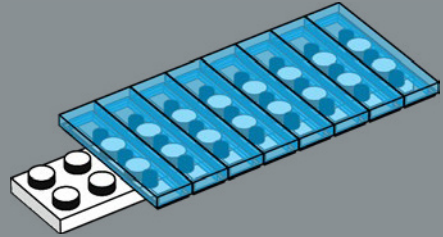

82

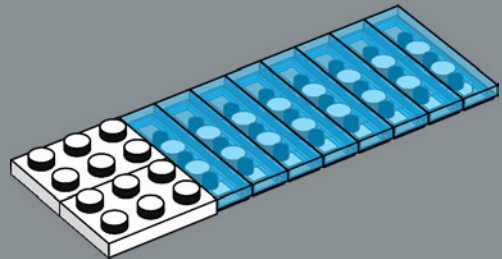

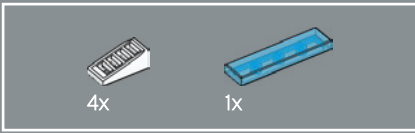

83

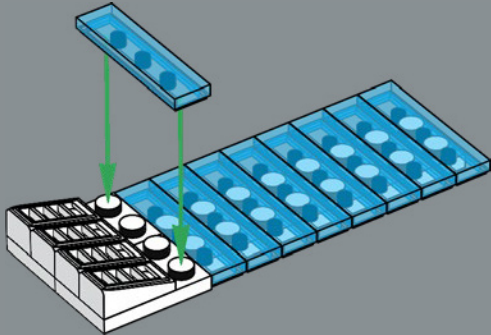

84

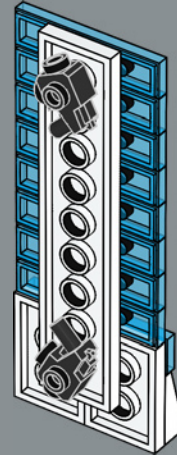

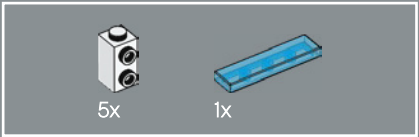

85

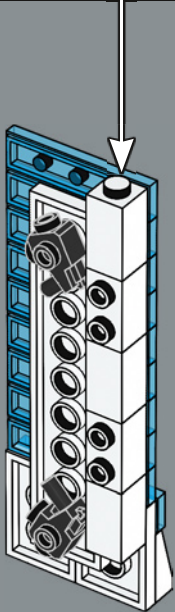
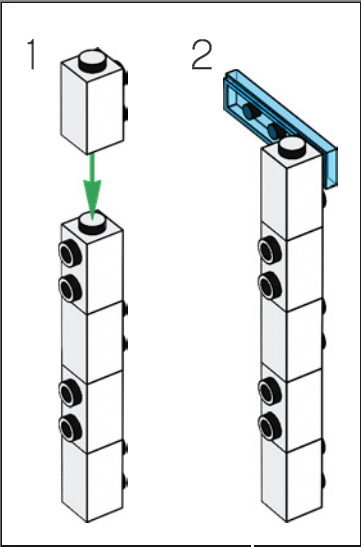

86

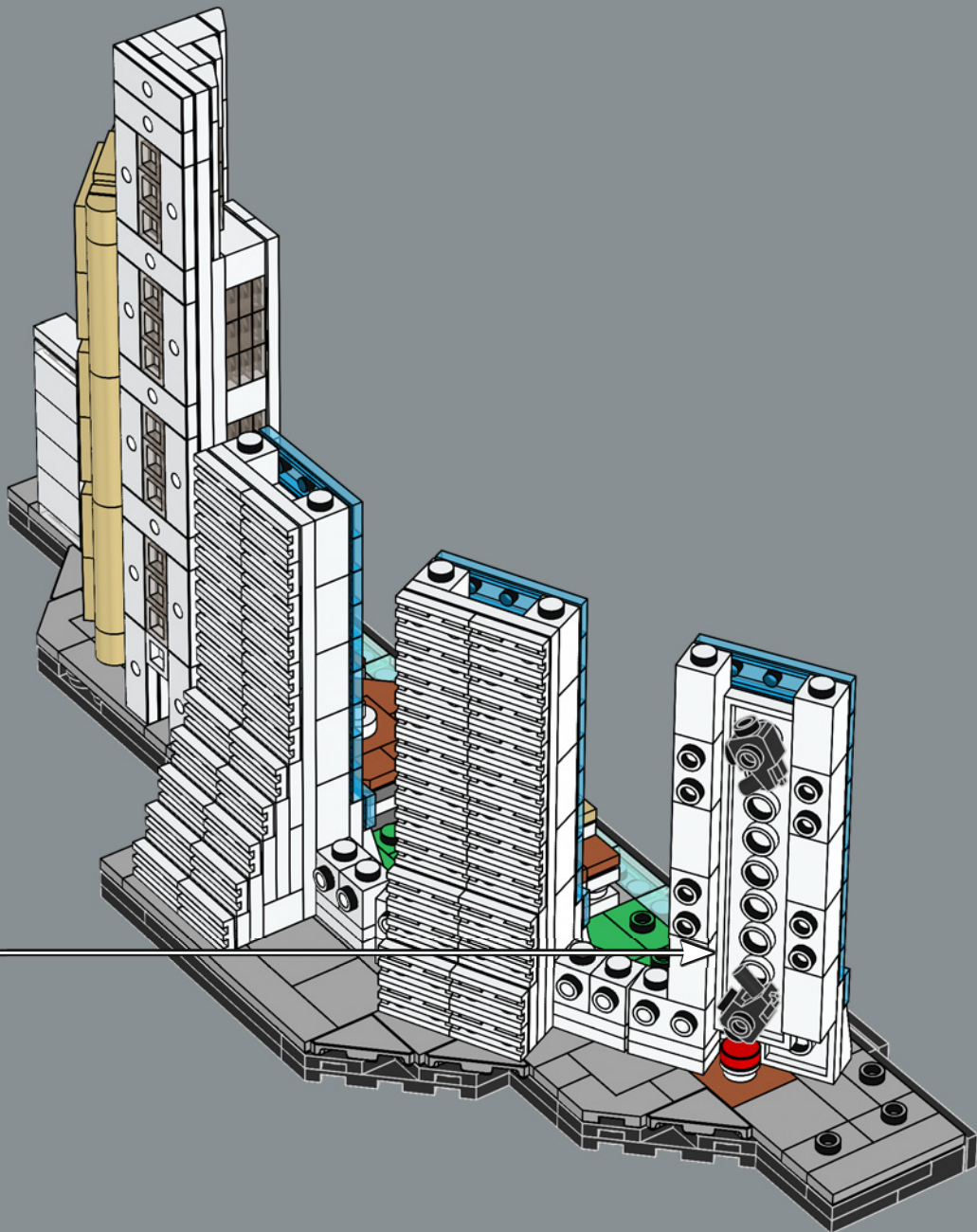

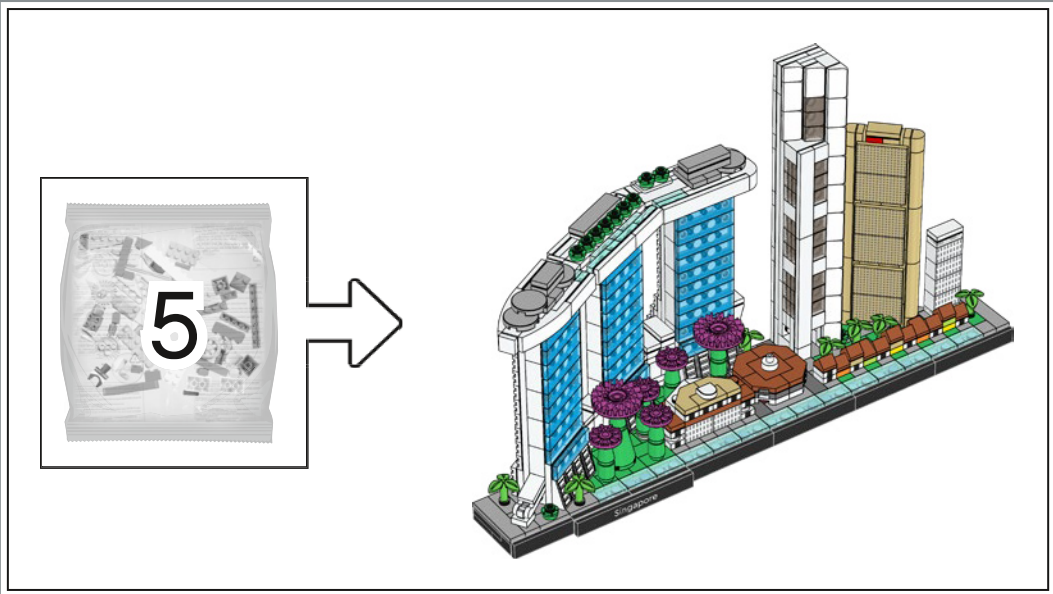



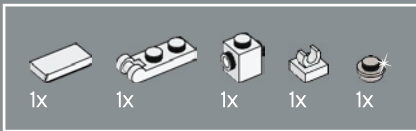

87

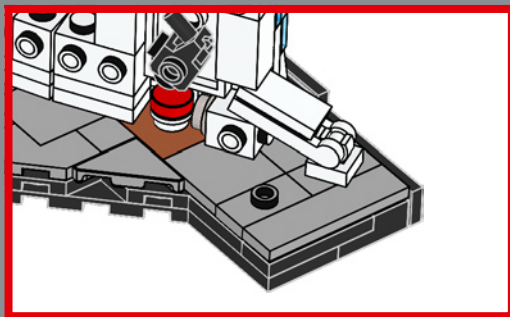
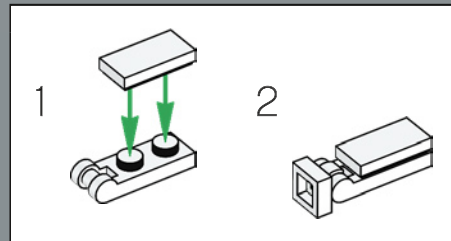
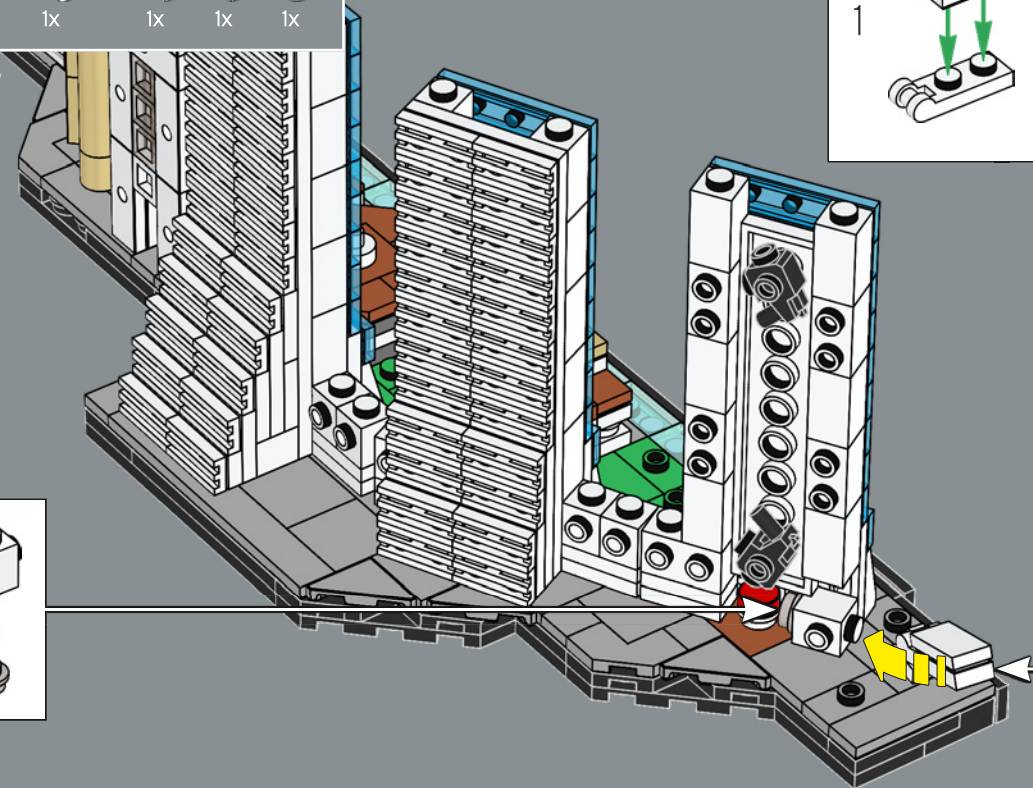
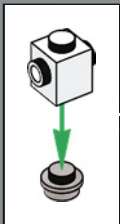

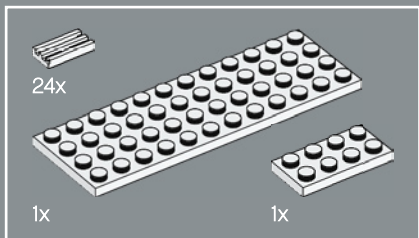

88

1

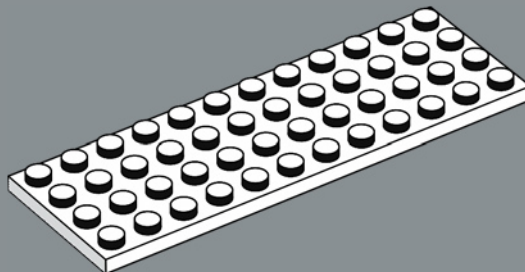

2

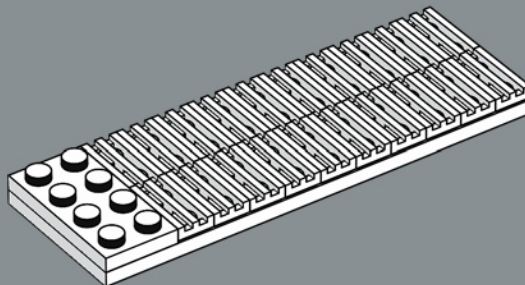



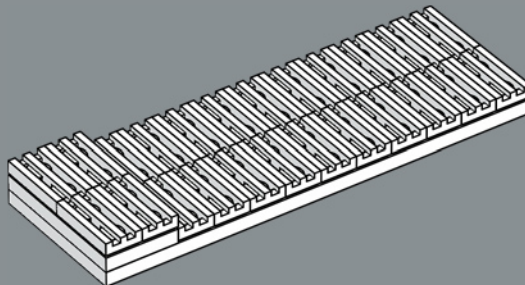

3

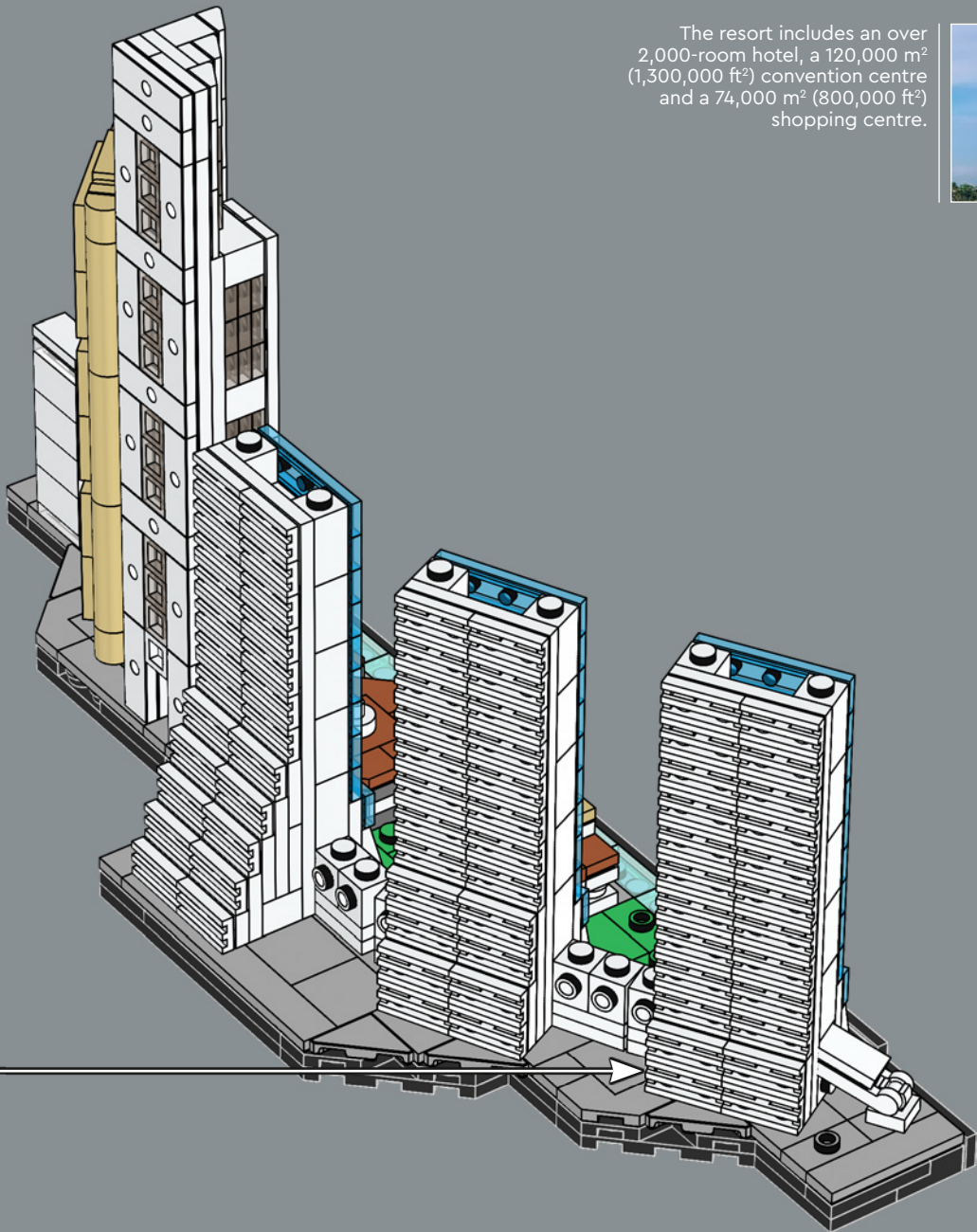

The resort includes an over 2,000-room hotel, a 120,000 m<sup>2</sup> (1,300,000 ft<sup>2</sup>) convention centre and a 74,000 m<sup>2</sup> (800,000 ft<sup>2</sup>) shopping centre.



-  9x
-  2x
-  1x
-  2x

89

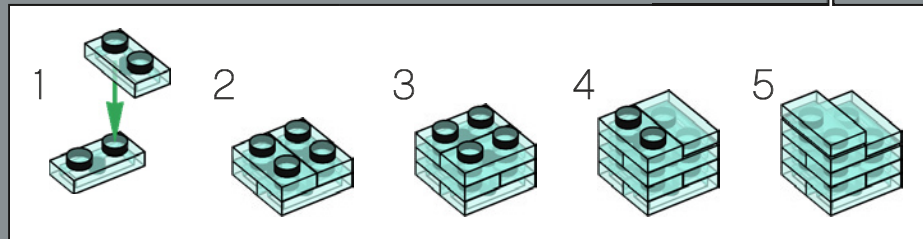
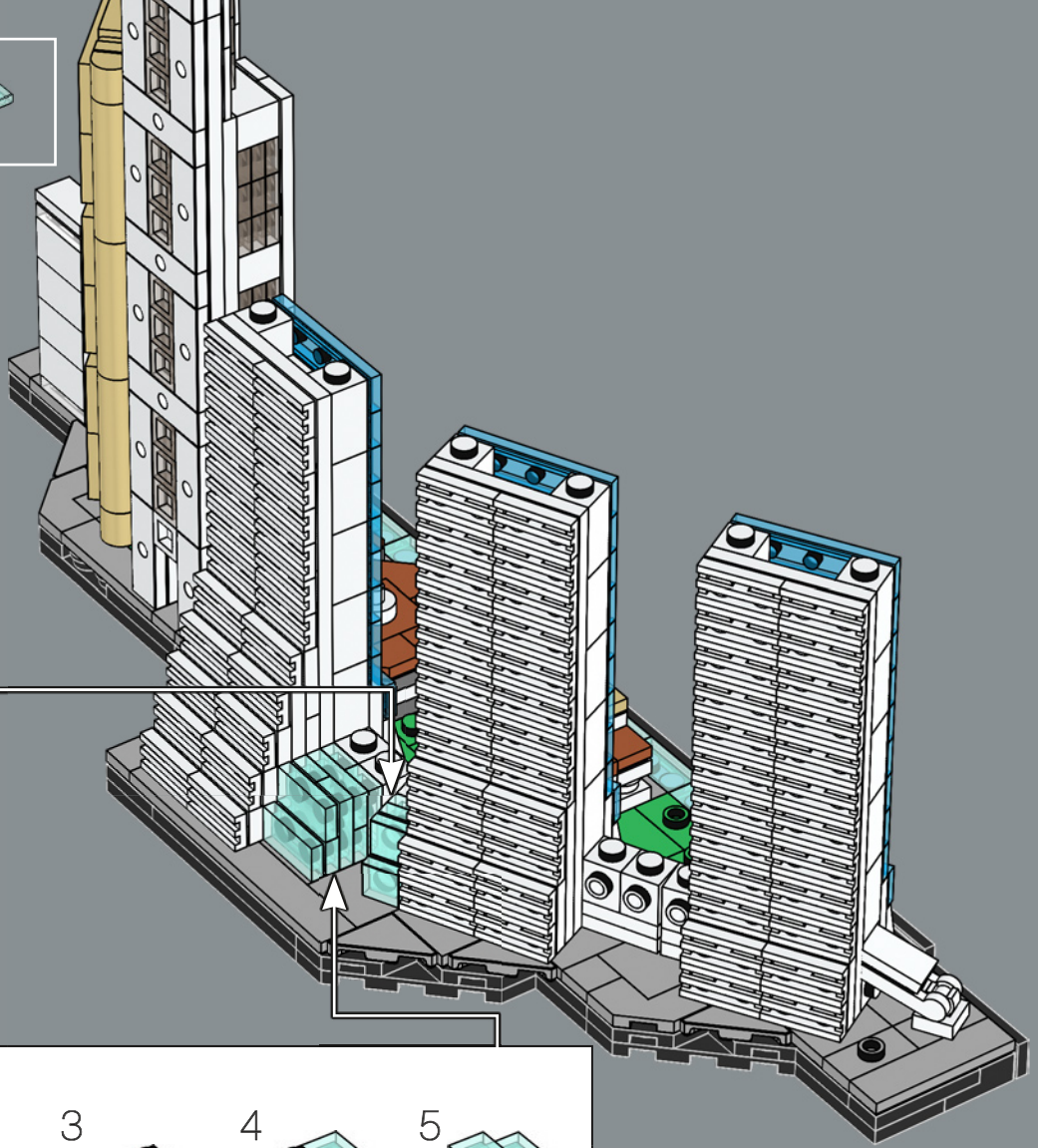
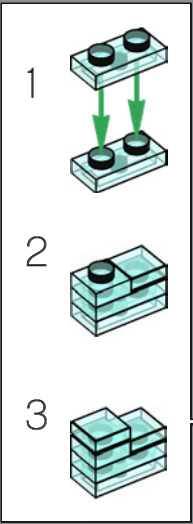

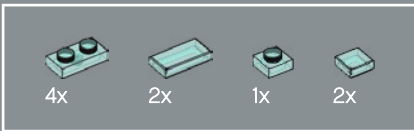

90

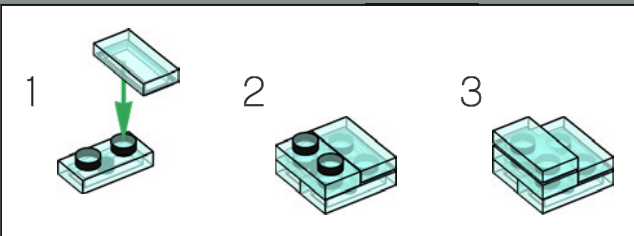
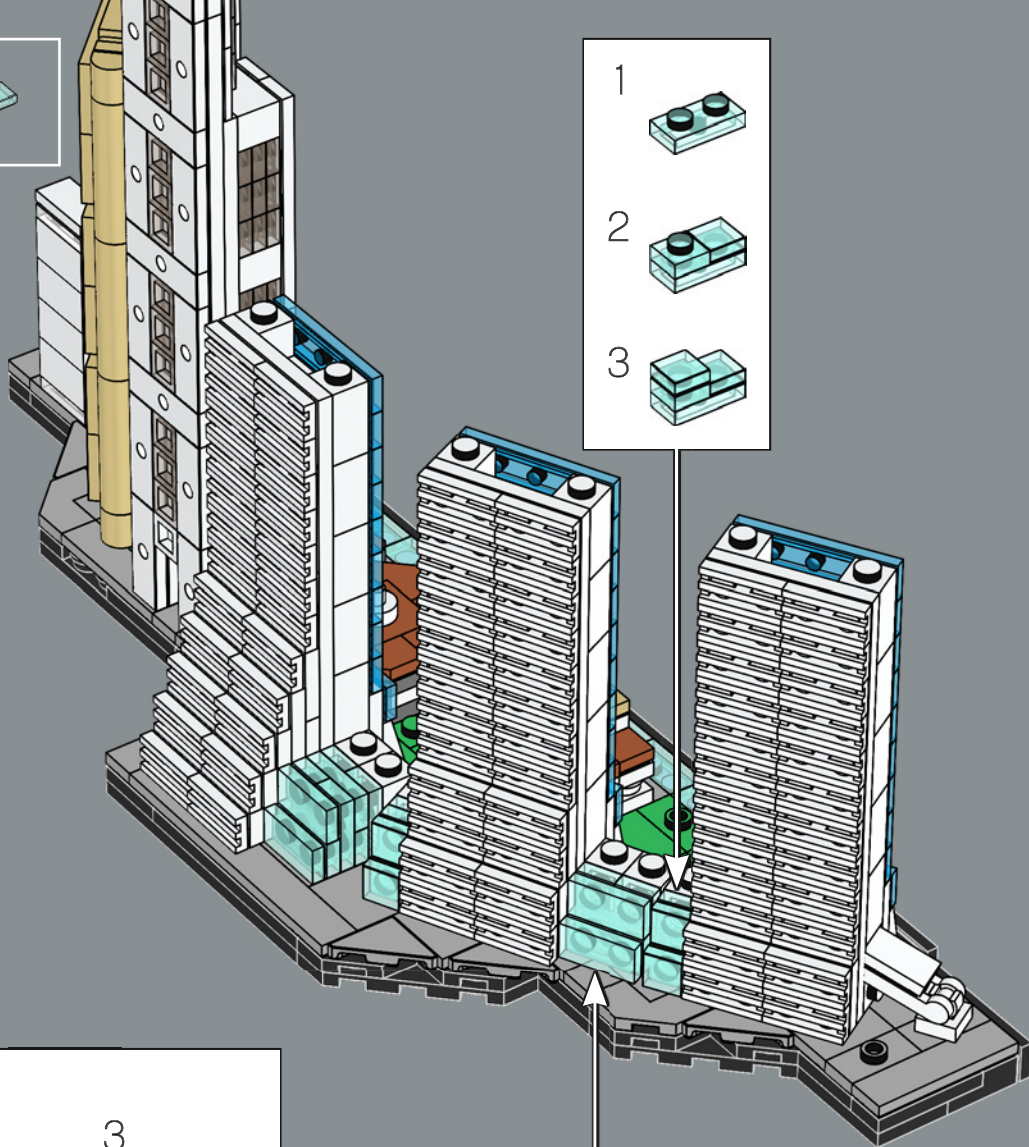
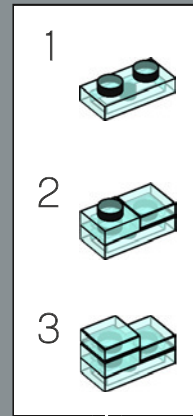

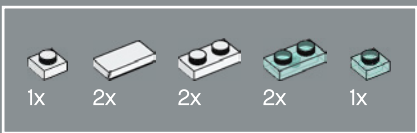

91

1

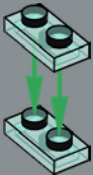

2

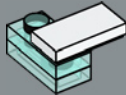

3

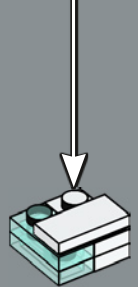
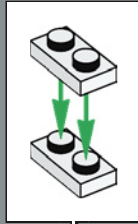



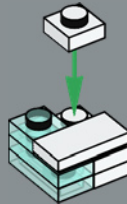

4

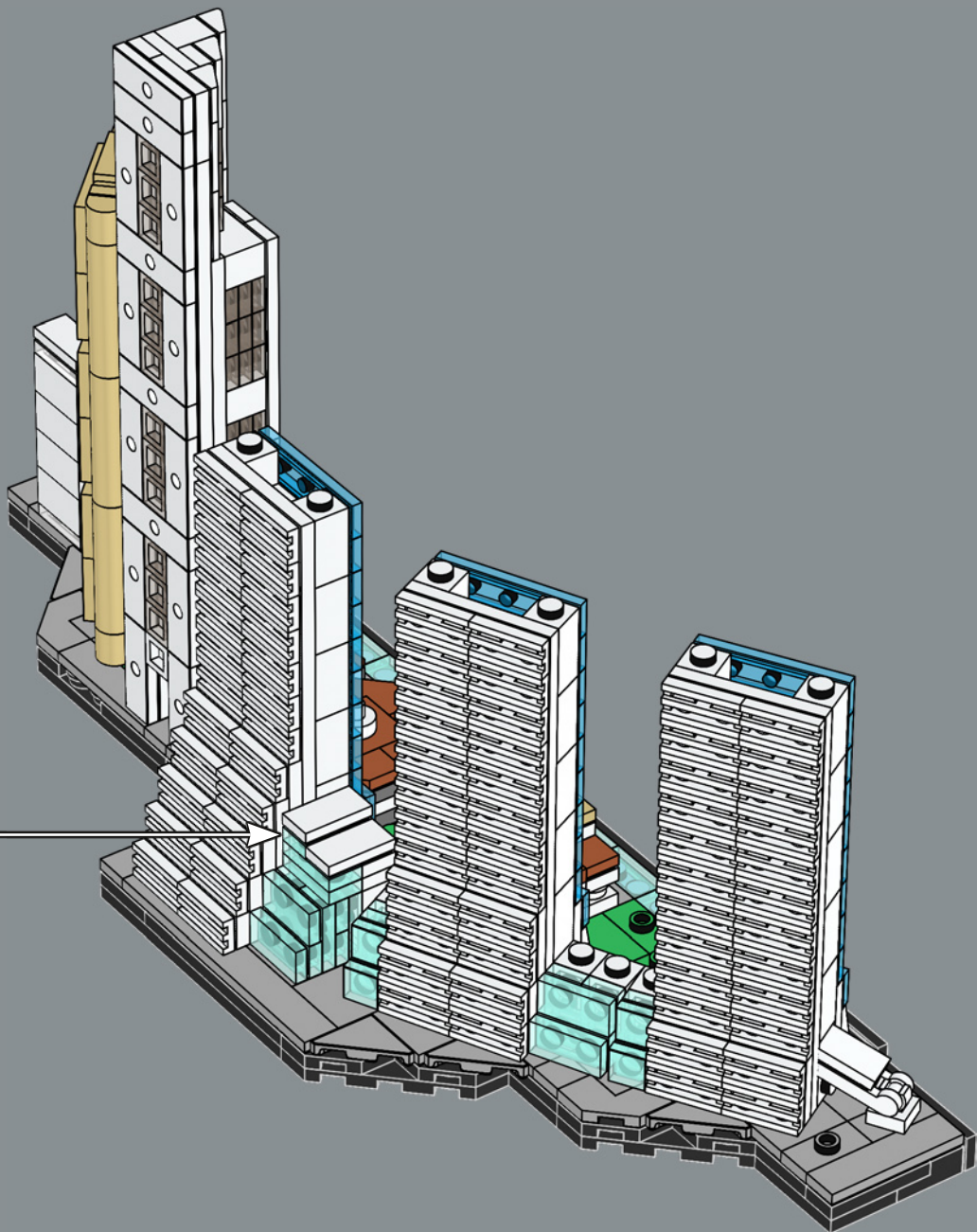

5





-   
1x
-   
2x
-   
1x
-   
3x

92

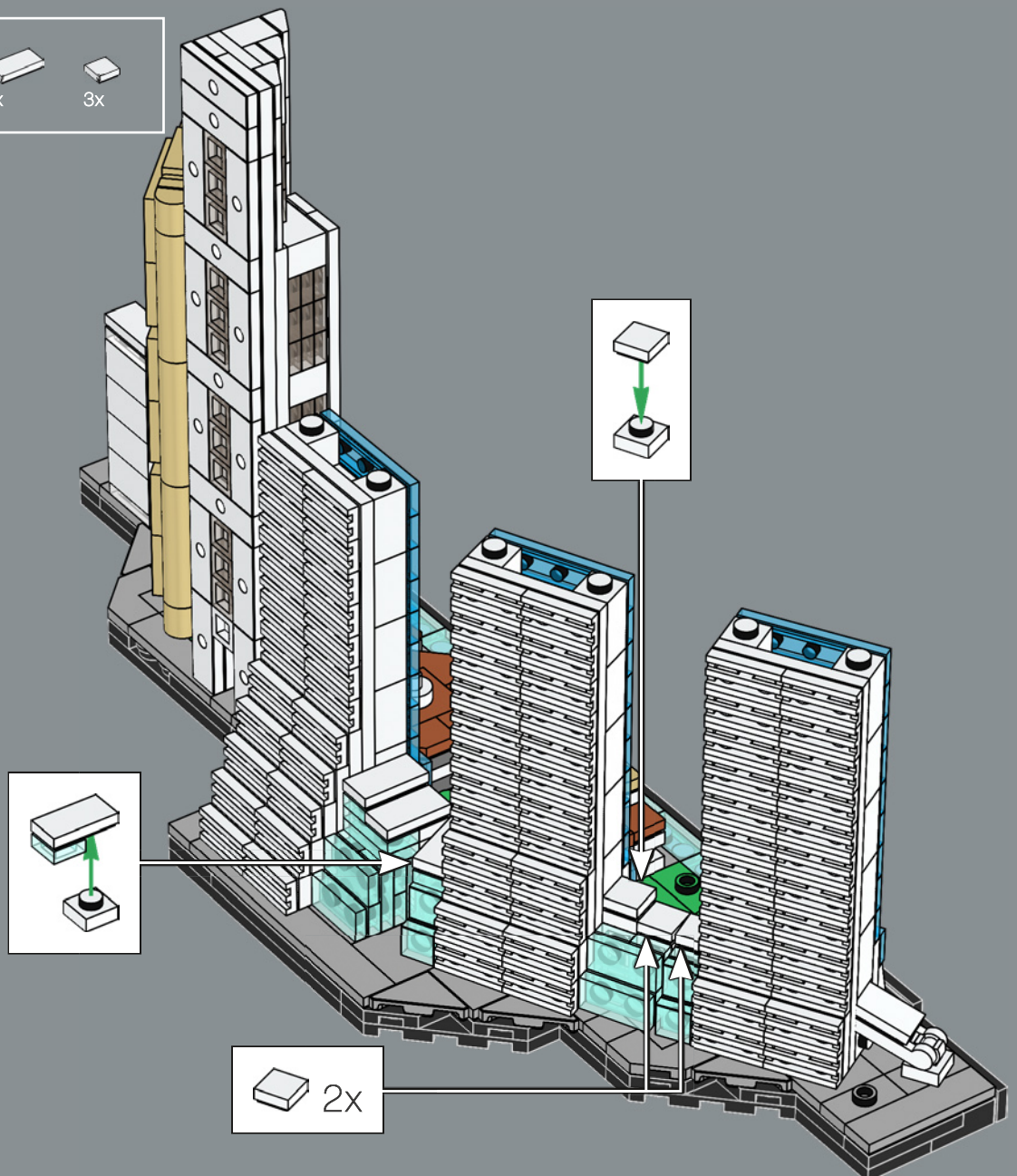



1x  2x 

93



 2x



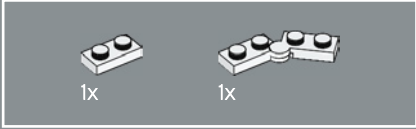
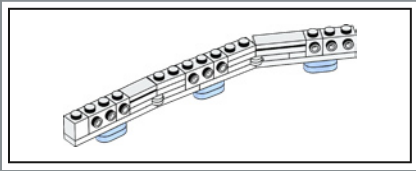

94

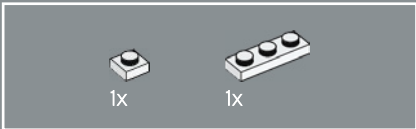
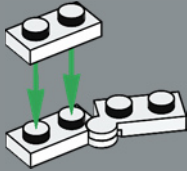

95

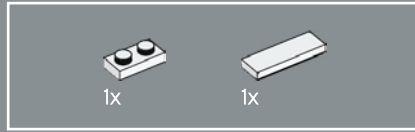
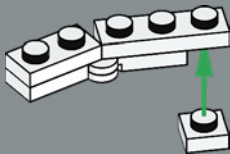

96

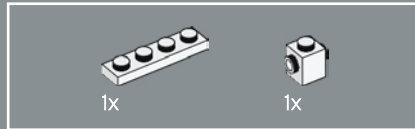
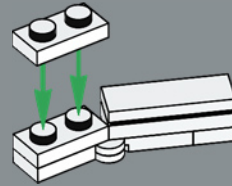

97

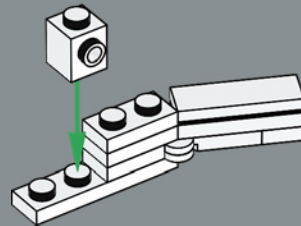

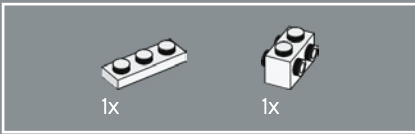

98

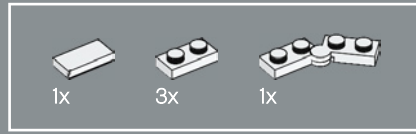
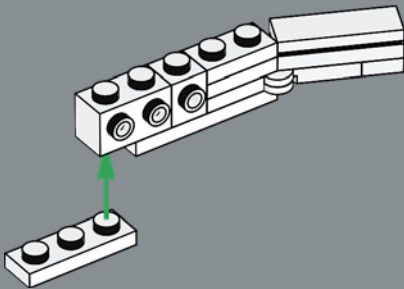

99

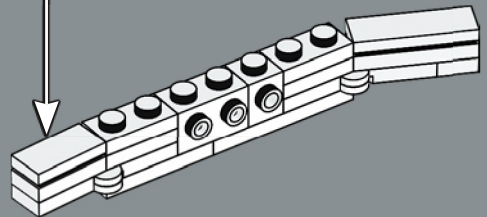
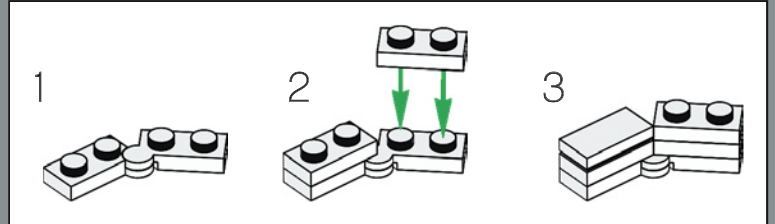

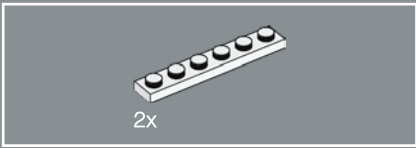

100

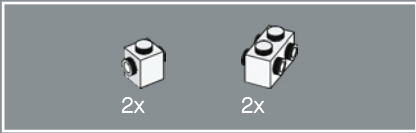
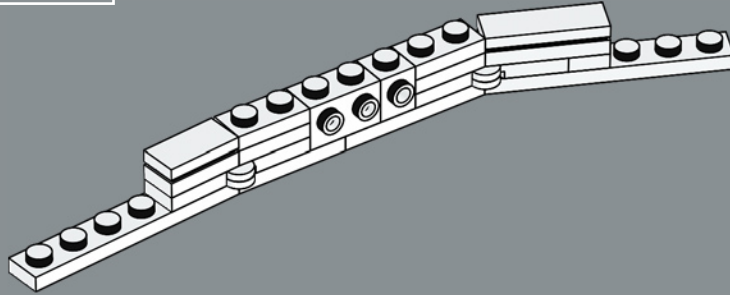

101

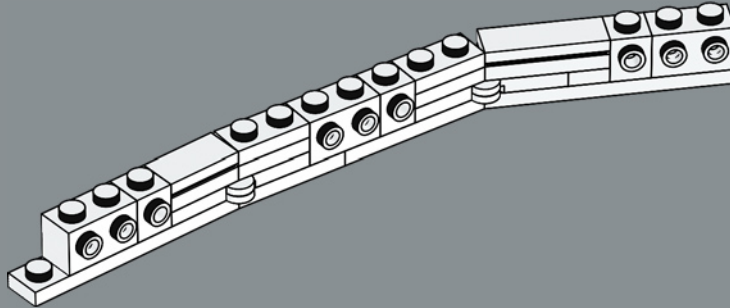

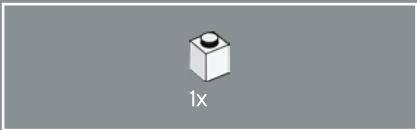

102

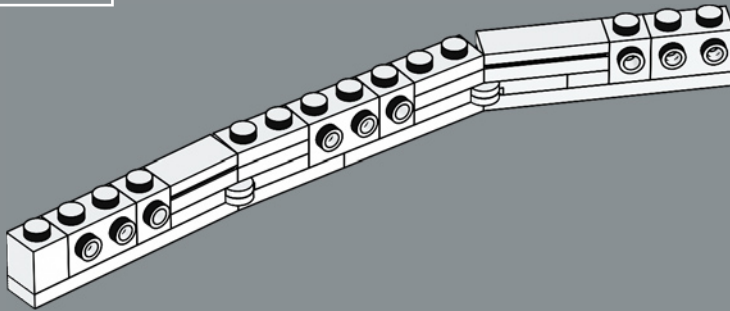

103

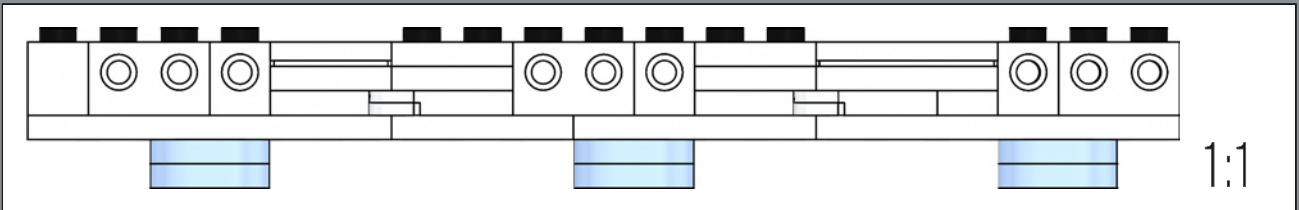
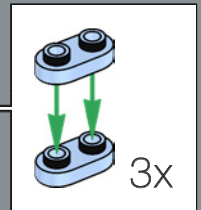
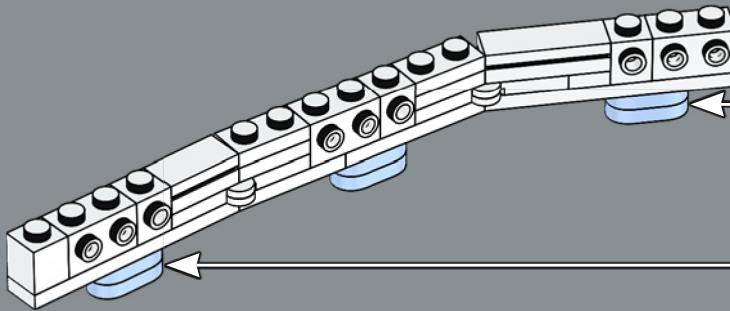

104



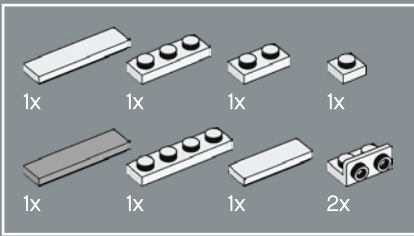

105

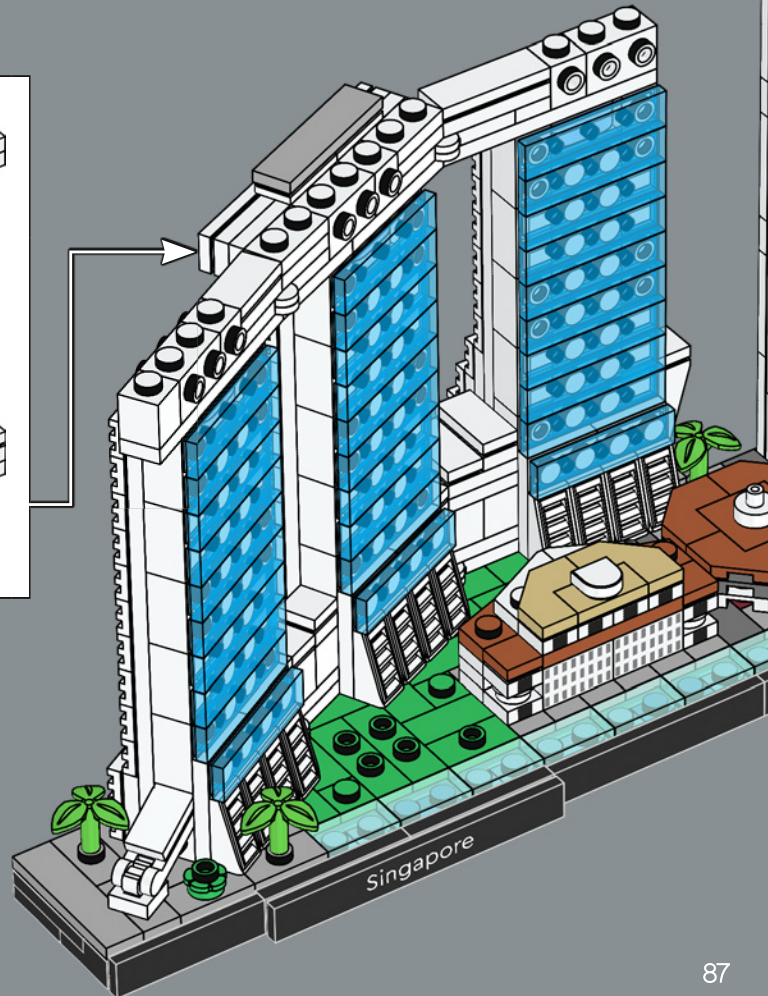
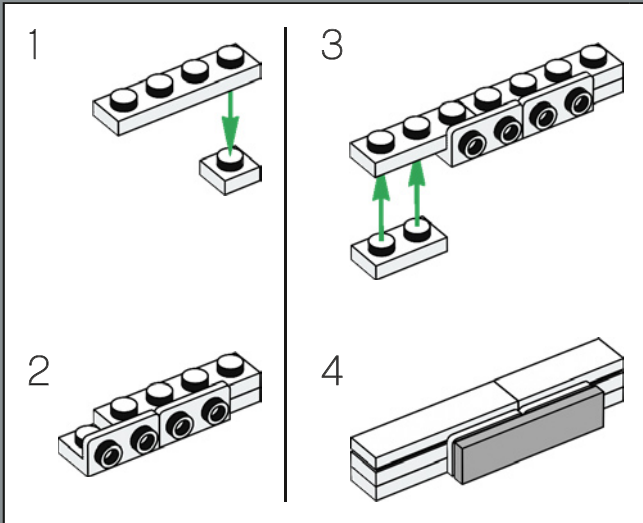

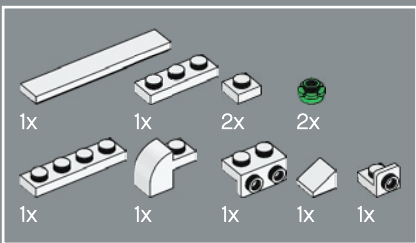

106

1

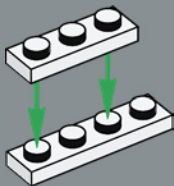

2

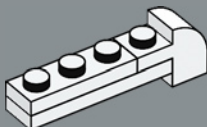

3

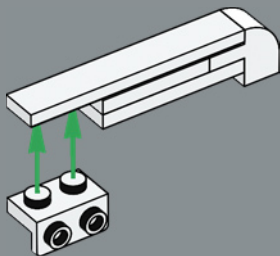

4

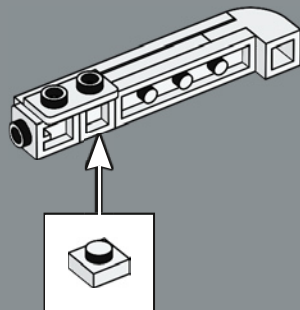

5

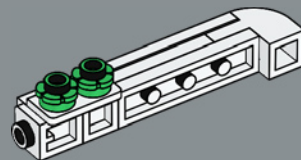

6

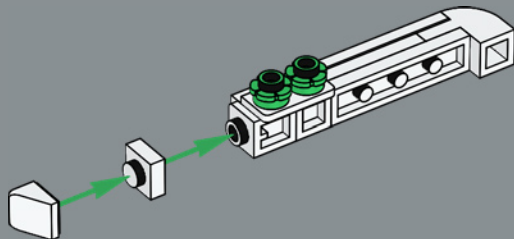





Singapore

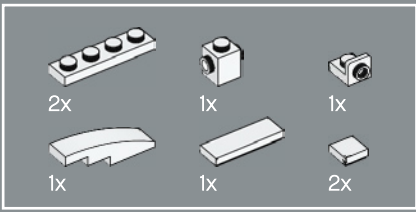

107

1

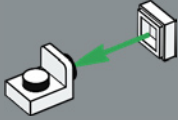

2

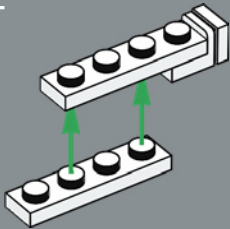

3

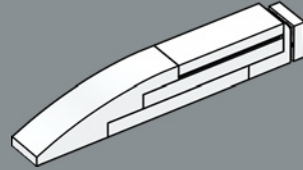

4

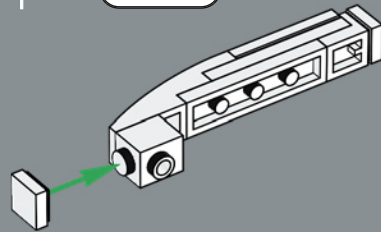



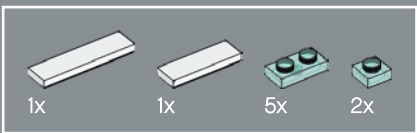

108

1

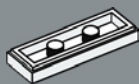

2

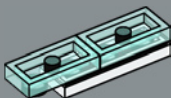

3

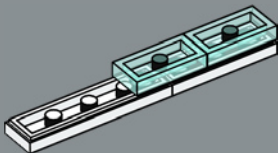

4

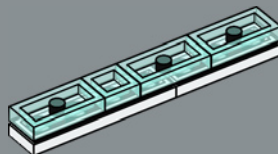

5

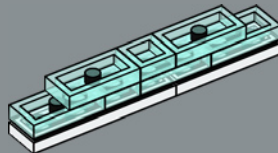

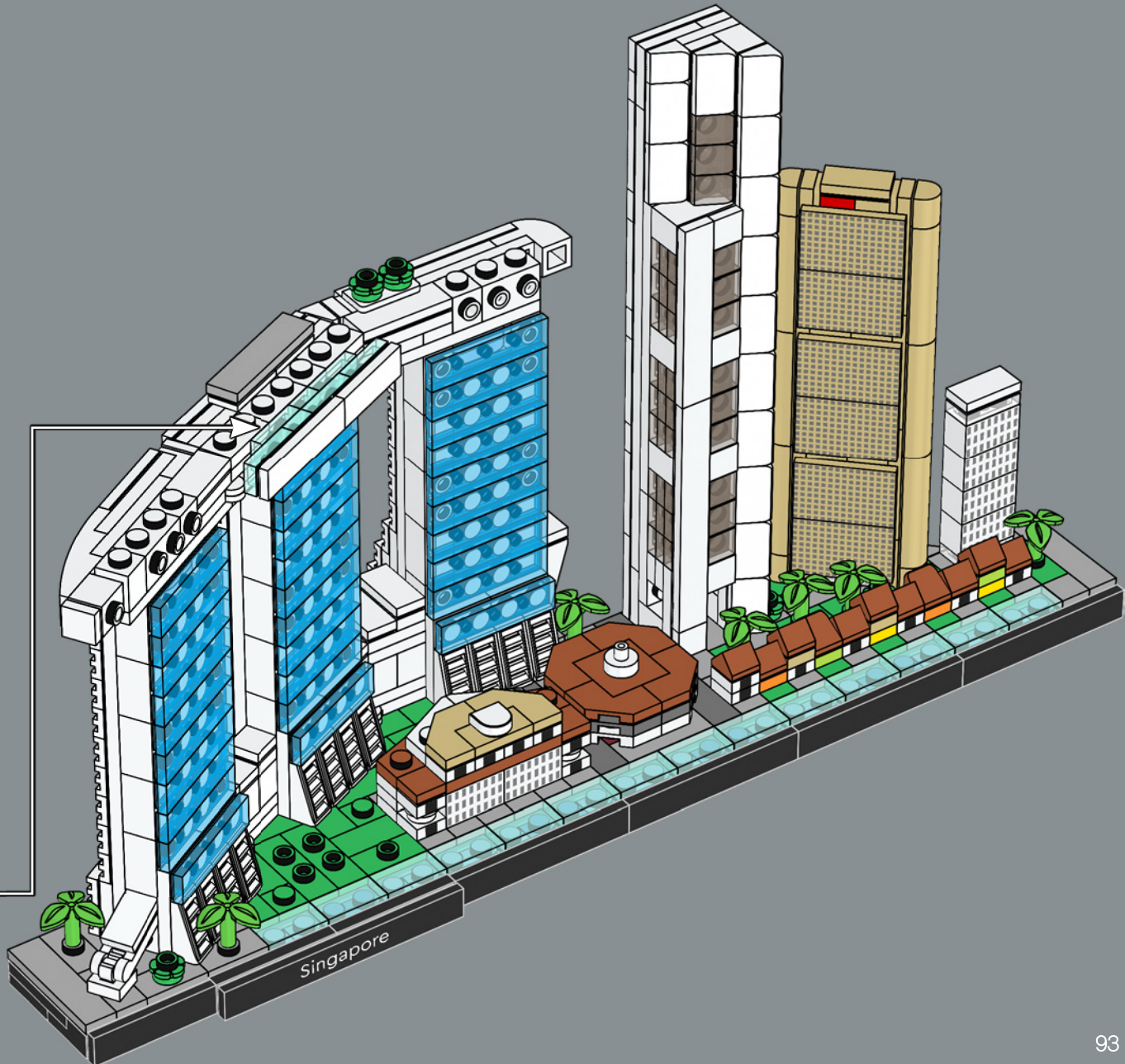

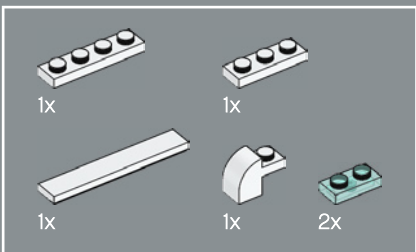

109

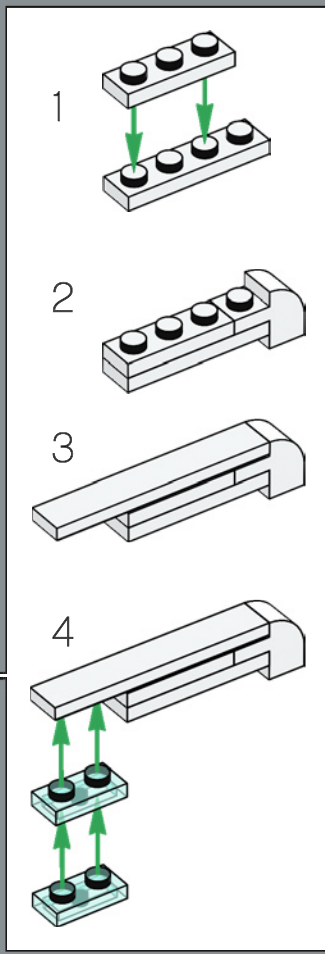
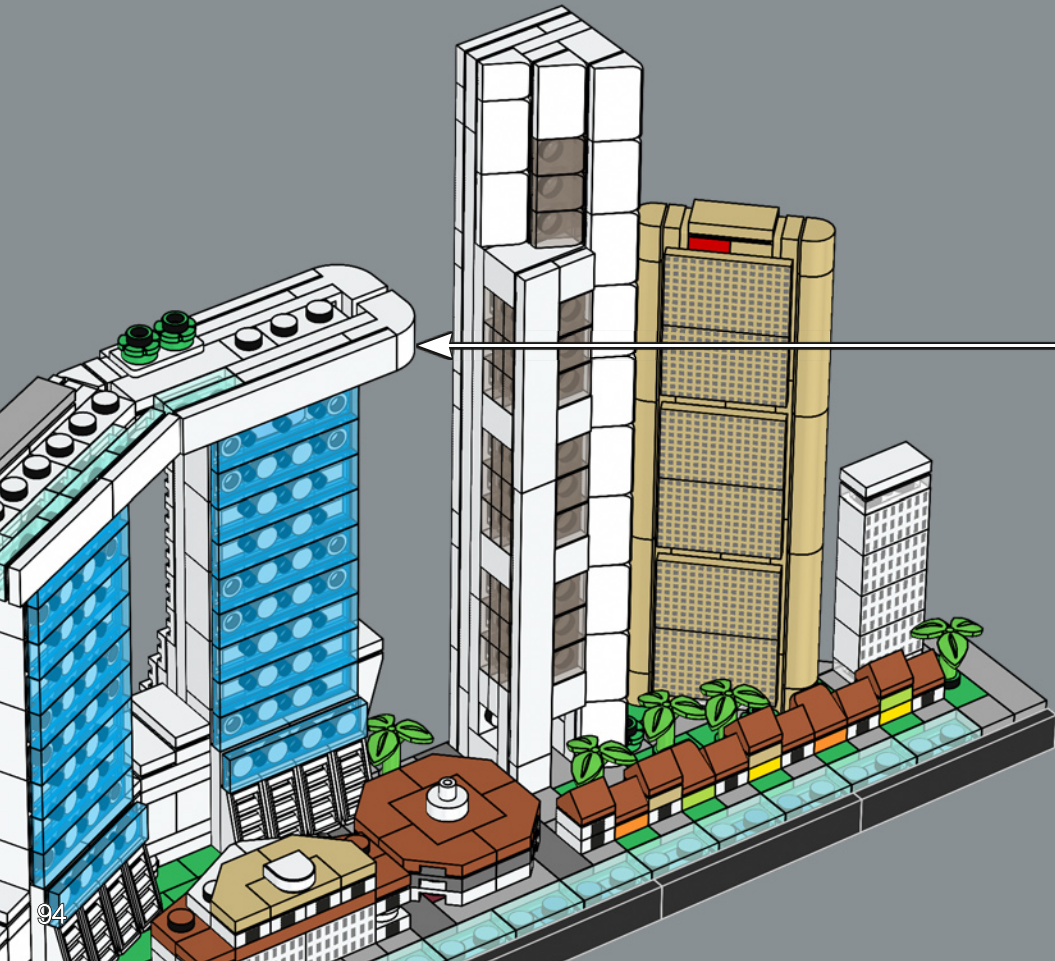

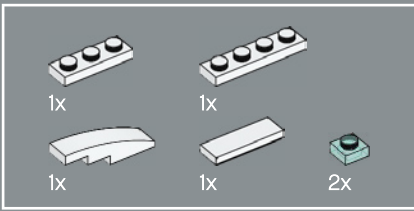

The cantilevered platform overhangs the north tower by 67 m (220 ft.).

110

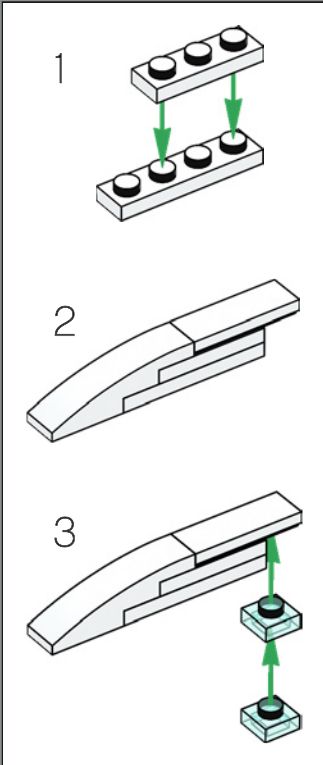

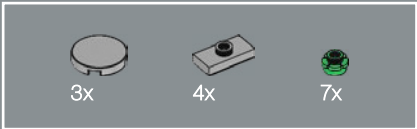

111





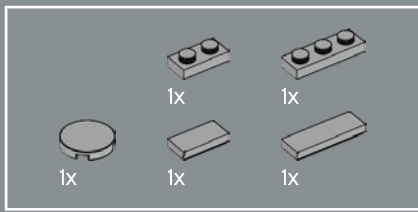

112

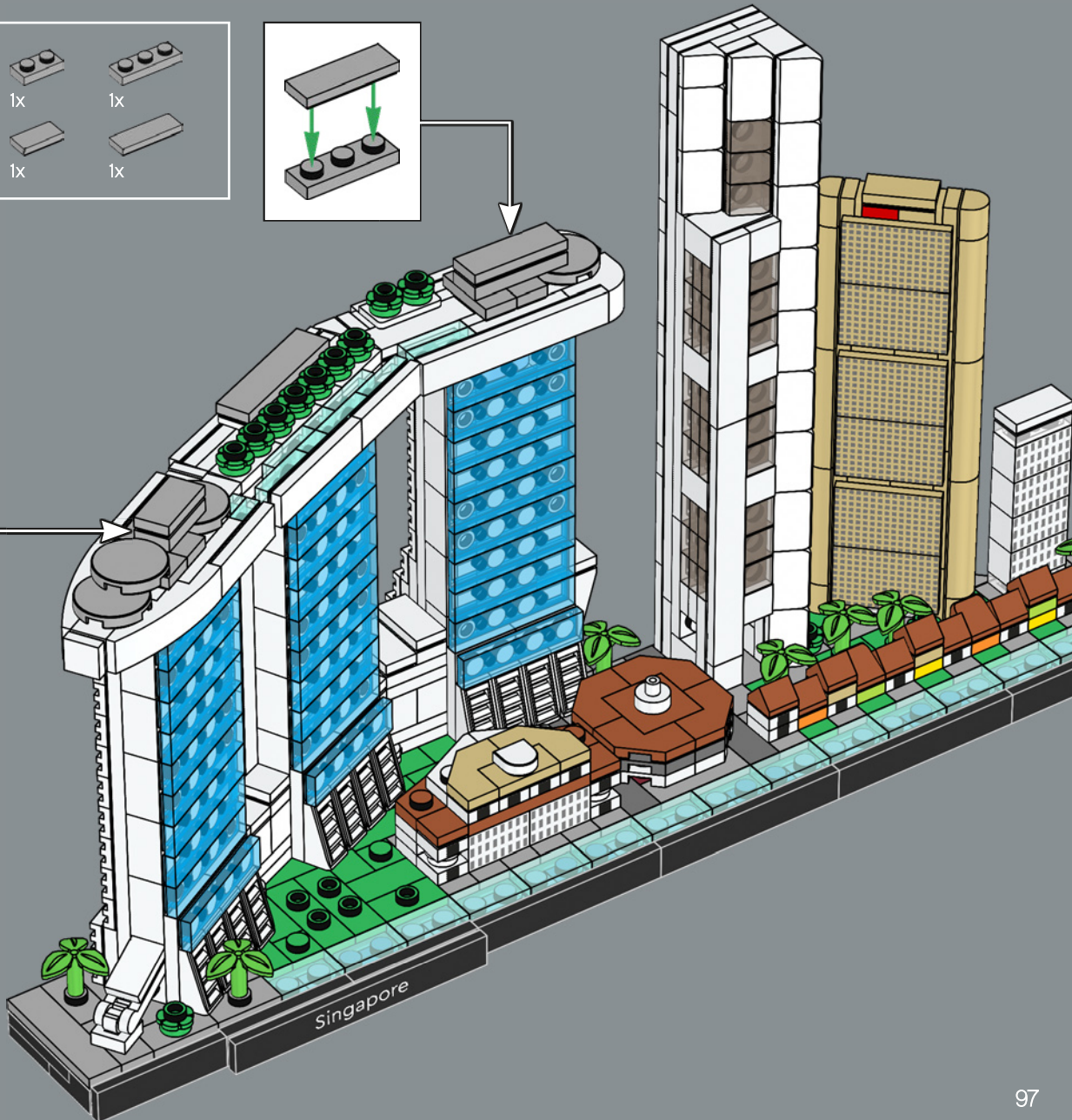
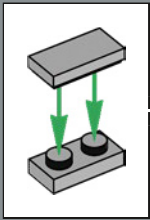
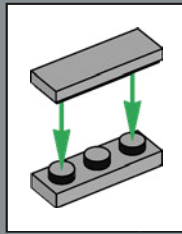

		
4x	3x	4x

113

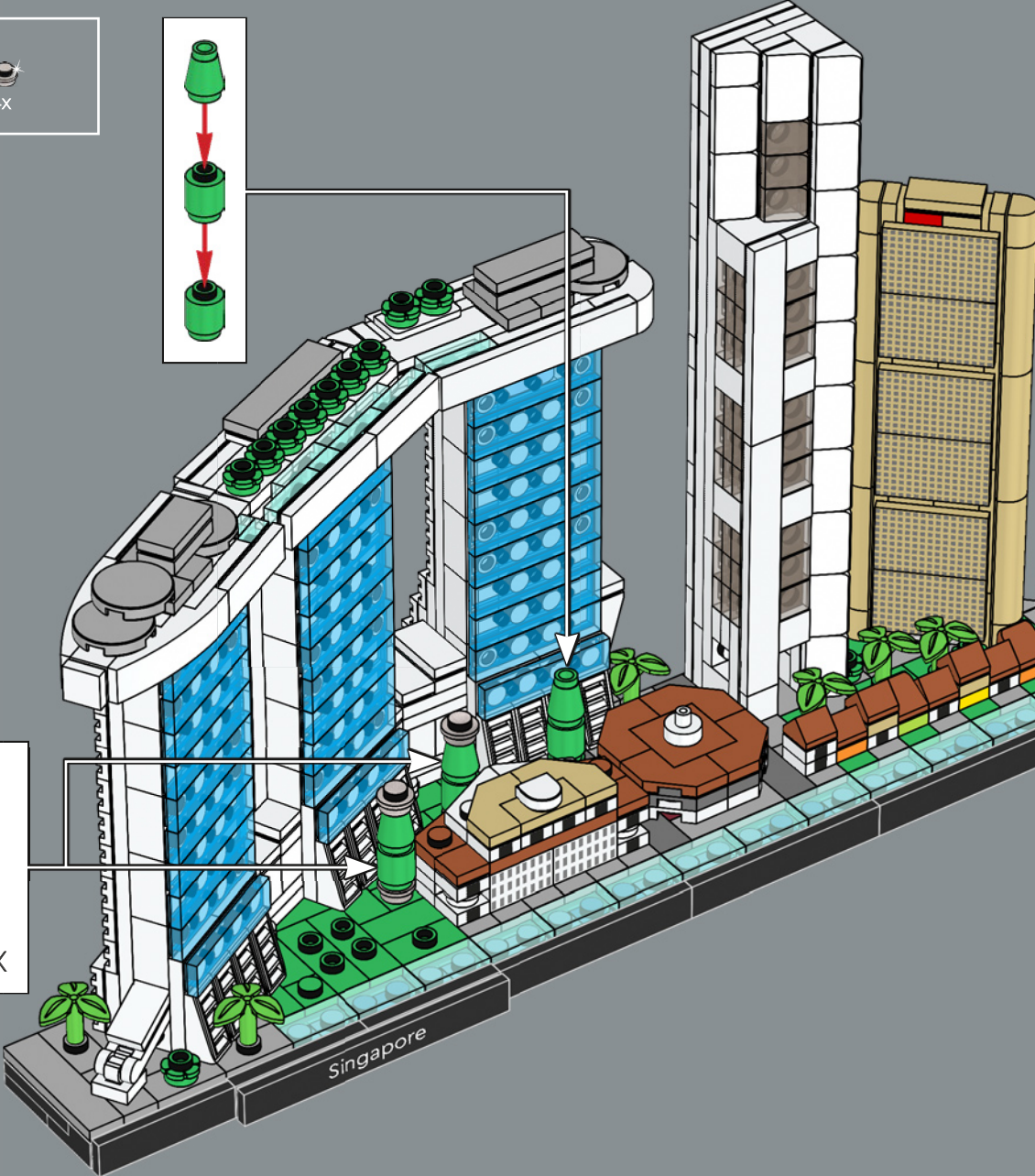
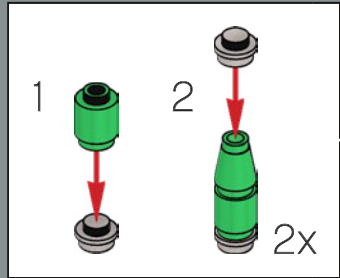
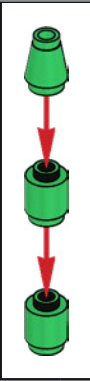

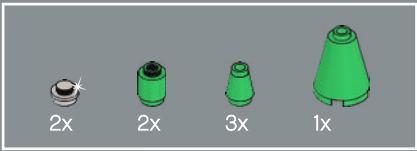

114

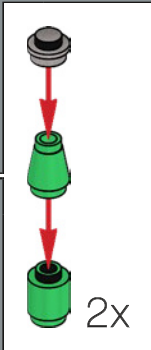
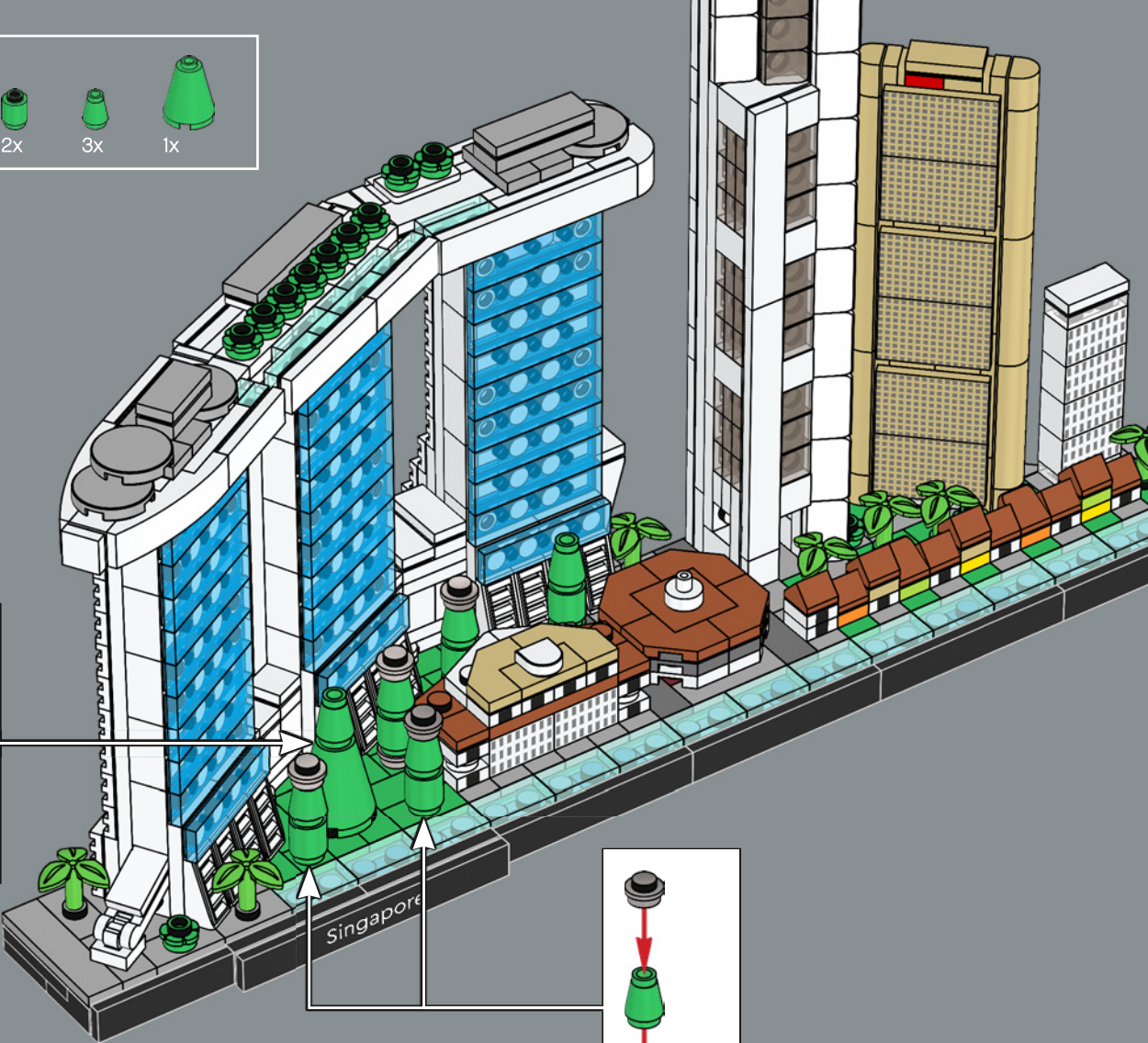
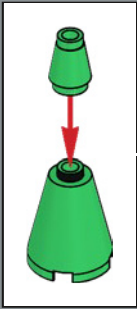



115

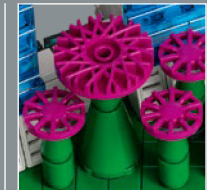

The LEGO® Supertrees are topped with re-colored LEGO hubcaps.



# FEEDBACK AND WIN

## FEEDBACK AND WIN

Your feedback will help shape the future development of this product series.

Please visit:

## FEEDBACK UND GEWINNEN

Dein Feedback trägt zur Weiterentwicklung dieser Produktreihe bei.

Geh auf:

## COMMENTEZ ET GAGNEZ

Vos commentaires nous aideront à concevoir les futurs produits de cette gamme.

Rendez-vous sur :

## COMENTA Y GANA

Tu opinión nos ayudará a dar forma al desarrollo de esta serie de productos en el futuro.

Visita:

## 反馈有奖

您的反馈将有助于我们在今后改进本系列产品。

请访问：

[LEGO.com/productfeedback](https://www.lego.com/productfeedback)

By completing, you will automatically enter a drawing to win a LEGO® set.

Terms & Conditions apply.

Durch Ausfüllen nimmst du automatisch an der Verlosung eines LEGO® Preises teil.

Es gelten die Teilnahmebedingungen.

En envoyant vos commentaires, vous serez automatiquement inscrit(e) à un tirage au sort qui vous permettra de remporter un prix LEGO®.

Offre soumise à conditions.

Al contestar, participarás automáticamente en el sorteo y podrás ganar un set LEGO®.

Sujeto a Términos y Condiciones.

完成我们的反馈调查，即可自动进入抽奖环节，赢取乐高® 套装。





























适用《条款和条件》。

LEGO and the LEGO logo are trademarks of the LEGO Group. ©2022 The LEGO Group.











Adam Reed Tucker is the co-developer of the LEGO® Architecture product line.

Made by LEGO System A/S under license from Gardens by the Bay.

MARINA BAY SANDS®

 4x 614101  
 1x 6186681  
 1x 6250591  
 15x 6202501  
 9x 302401  
 1x 6348055  
 11x 307001  
 2x 4504369  
 2x 4558952  
 29x 6218841  
 1x 300501  
 2x 6242241  
 5x 4626882  
 2x 6321349  
 1x 6132204  
 1x 6132203  
 3x 4179875  
 3x 4179874  
 13x 4547489  
 5x 4667575  
 72x 241201  
 4x 6058177  
 6x 6253517  
 2x 6285777  
 13x 302301  
 4x 6176240  
 1x 300401  
 12x 6023804

 6x 306901  
 1x 4532972  
 1x 6018774  
 2x 6070698  
 1x 302201  
 1x 4515364  
 15x 6223491  
 3x 362201  
 13x 362301  
 5x 4558168  
 8x 302101  
 2x 243101  
 2x 6045936

 1x 370101  
 9x 371001  
 4x 6102776  
 8x 302001  
 3x 663601  
 2x 366601  
 1x 416201  
 3x 447701  
 3x 383201  
 3x 4168072  
 2x 4119227

 3x 4159553  
 4x 6286329  
 2x 6365720  
 4x 6374151  
 2x 6374192  
 8x 6357613  
 1x 4114026  
 3x 6092587  
 1x 6372047  
 1x 6374166  
 2x 6265572  
 12x 6378425  
 6x 4113233

 6x 6375672  
 2x 302421  
 1x 4569056  
 4x 6315482  
 3x 302424  
 2x 302324  
 4x 614126  
 1x 6253695  
 6x 6196548  
 2x 6174243  
 9x 302326  
 4x 6052126  
 2x 362326  
 4x 302126  
 1x 302126

1x  
243126

3x  
371026

2x  
302026

4x  
663626

2x  
4160025

3x  
379526

1x  
6366690

2x  
447726

3x  
303526

13x  
6135287

6x  
306228

6x  
4529239

2x  
4558593

3x  
302428

1x  
6189162

7x  
6092586

6x  
306928

5x  
6023083

4x  
6378110

7x  
6235080

9x  
6374150

2x  
6143431

2x  
6104342

1x  
6360214

1x  
6360215

1x  
6360215

3x  
6315197

4x  
6253425

1x  
6074892

3x  
6240204

4x  
6254256

11x  
6252043

22x  
6240222

18x  
6251295

30x  
6252050

2x  
4524929

1x  
6240515

3x  
6245263

9x  
6254253

45x  
6252039

30x  
6240219

2x  
4621557

2x  
6373602

1x  
6374116

4x  
4539114

8x  
4211415

4x  
6052200

2x  
4211398

3x  
4211414

14x  
6066097

4x  
6217876

6x  
4211413

2x  
6313188

2x  
6177078

8x  
6211969

1x  
4211429

5x  
4558169

7x  
4211356

2x  
4211481

4x  
6164073

2x  
4210651

6x  
6372122

2x  
6212377

2x  
6336665

3x  
4653988

1x  
6218014

7x  
4633691

6x  
6097493

2x  
4655256

5x  
6332108

4x  
6104130



Customer Service

Kundenservice

Service Consommateurs

Servicio Al Consumidor

LEGO.com/service or dial

🇧🇪 🇩🇰 🇪🇺 🇸🇦 🇫🇷 🇮🇹 🇮🇹 🇳🇱 🇩🇪 🇸🇪  
🇨🇦 🇫🇮 🇸🇪 🇩🇪 🇬🇧  
: 00800 5346 5555  
: 1-800-422-5346

