



MINECRAFT

21241





LEGO.com/sustainable-packaging



BUILDER



Apple and the Apple logo are trademarks of Apple Inc., registered in the U.S. and other countries and regions. App Store is a service mark of Apple Inc. Google Play and the Google Play logo are trademarks of Google LLC. Tencent and the Tencent logo are trademarks of Tencent Inc.

Q [LEGO.com/devicecheck](https://www.lego.com/devicecheck)

EN Ask parents' permission before going online | **DE** Eltern um Erlaubnis bitten, bevor du online gehst | **FR** Demande l'autorisation d'un parent avant d'aller en ligne | **IT** Chiedi il permesso ai tuoi genitori prima di andare online | **ES** Pídeles permiso a tus papás antes de conectarte a Internet | **PT** Peça autorização aos pais antes de acederes online | **JA** オンラインになる前にほご者の方のきよかをもらおう | **ZH** 上网前应先征得父母的同意 | **KO** 온라인 접속 전에 보호자 동의가 필요합니다 | **RU** Спроси разрешения у родителей, прежде чем заходить в интернет | **PL** Poproś rodziców o zgodę, zanim wejdiesz do Internetu | **CS** Než půjdeš na internet, požádej rodiče o svolení | **SK** Skôr než pôjdeš na internet, vypýtaj si povolenie od rodičov | **HU** Kérj szülői engedélyt, mielőtt online csatlakoznál! | **RO** Cere permisiunea părinților înainte de a te conecta online | **BG** Поискайте разрешение от родител, преди да влезете онлайн | **LV** Pirms došanās tiešsaistē palūdz atļauju vecākiem | **ET** Enne Interneti kasutamist küsi vanematelt luba | **LT** Prieš prisijungdami prie interneto, atsiklauskite tėvų

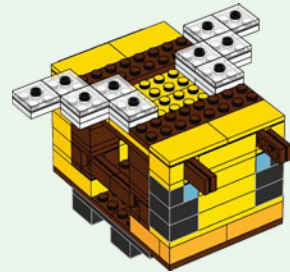
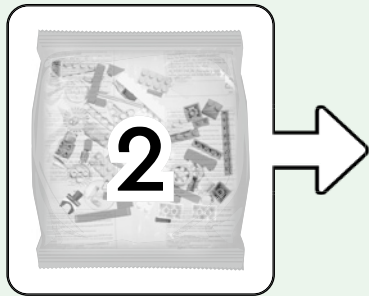
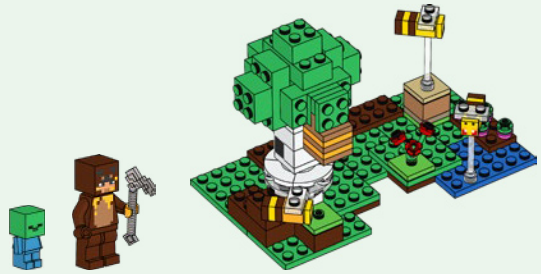
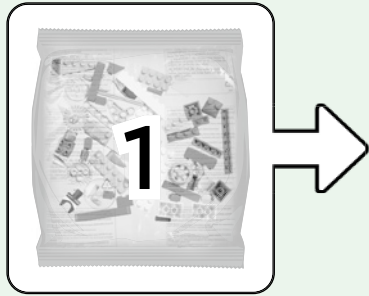

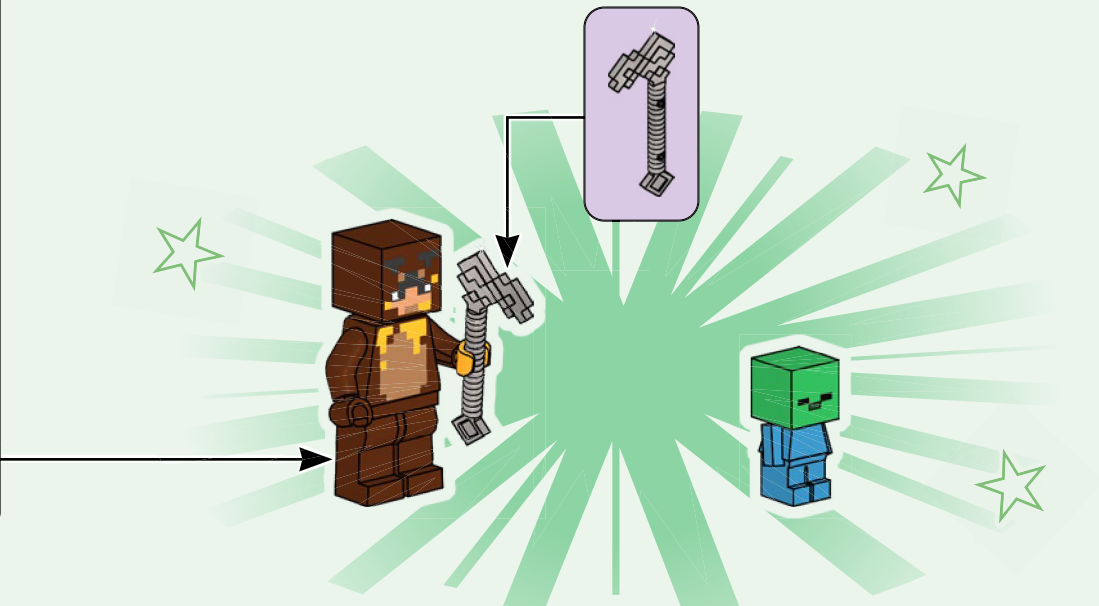
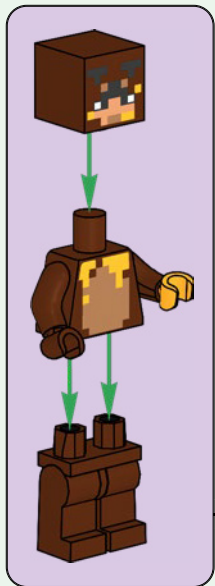

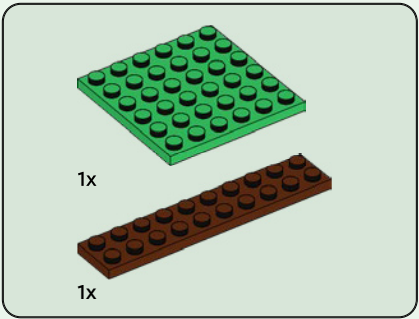

1

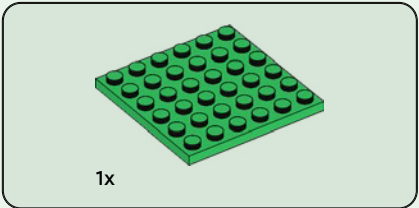
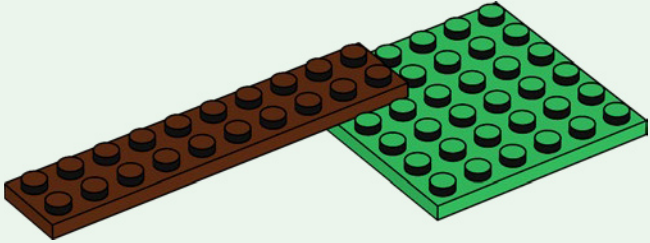

2

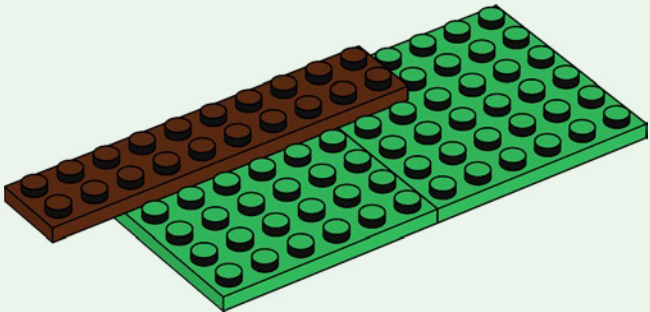

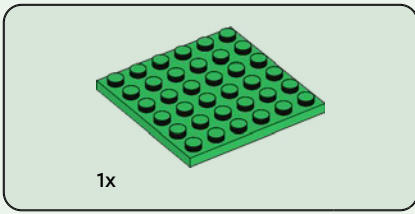

3

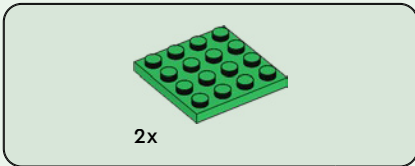
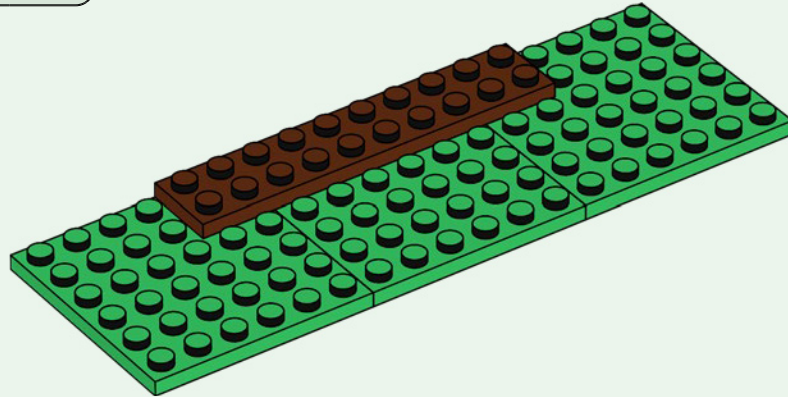

4

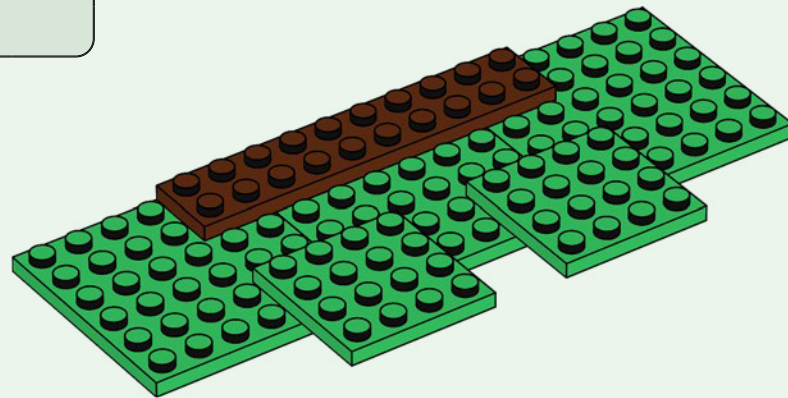



2x

5

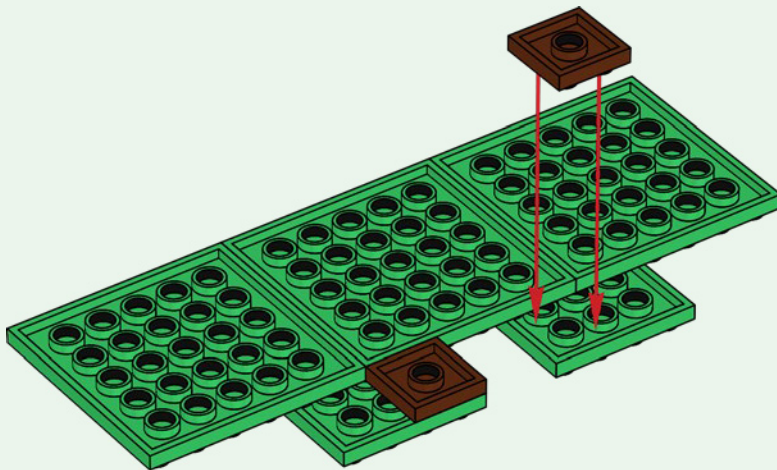

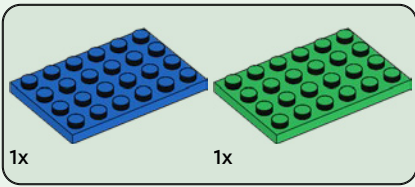

6

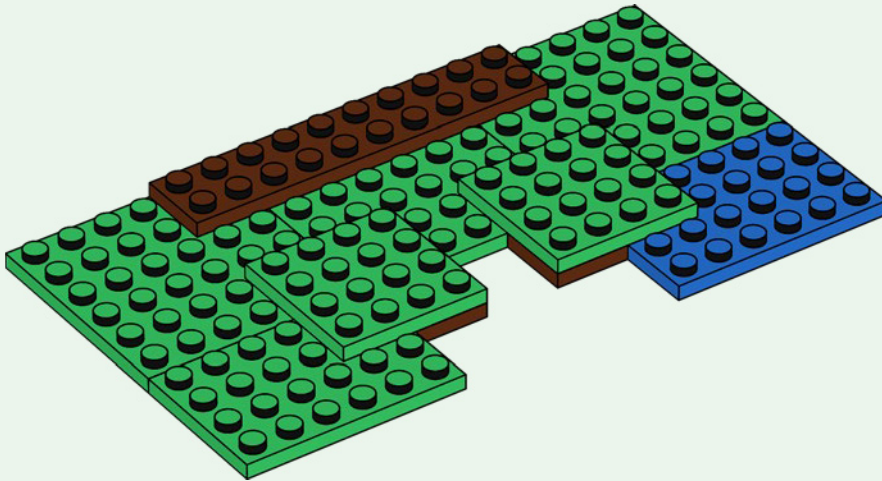

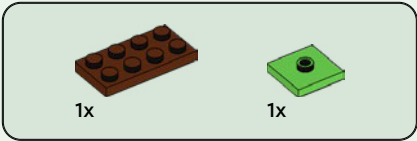

7

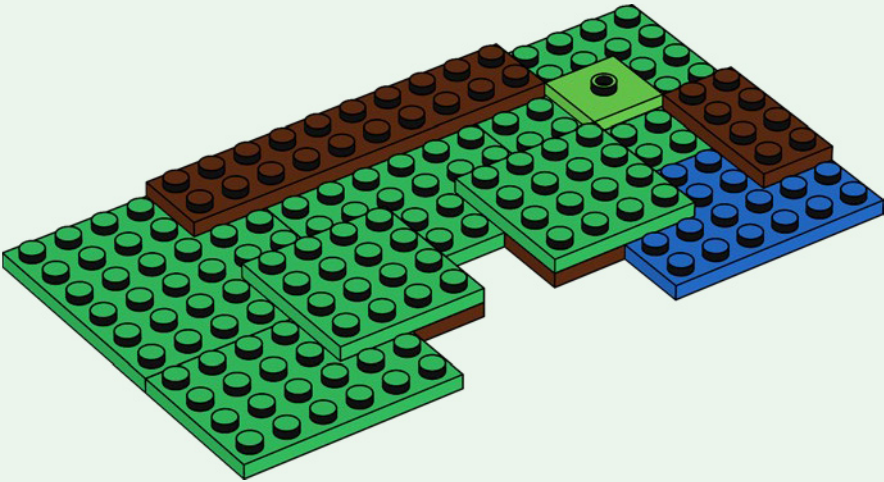

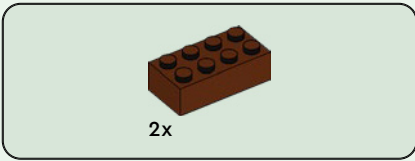

8

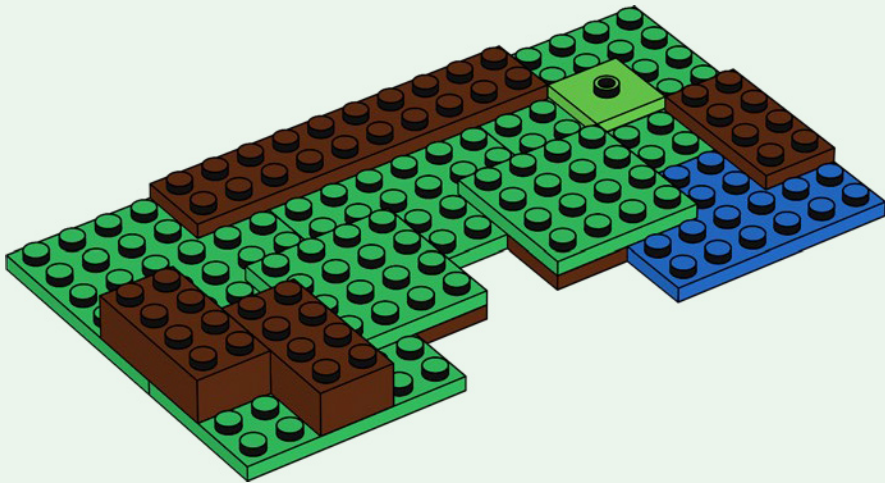

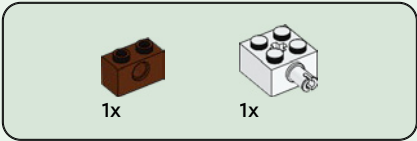

9

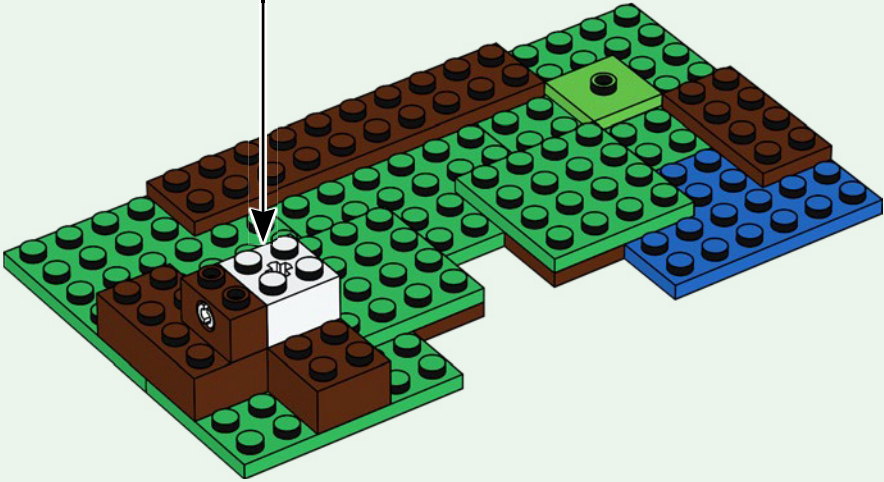
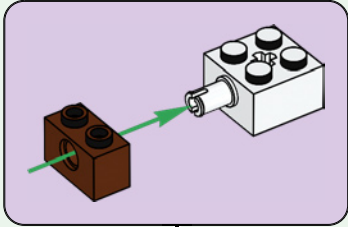

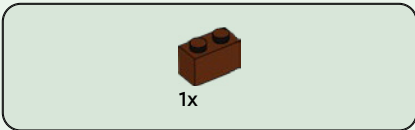

10

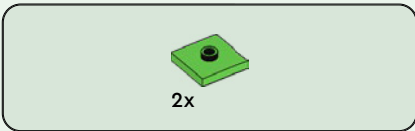
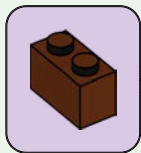

11

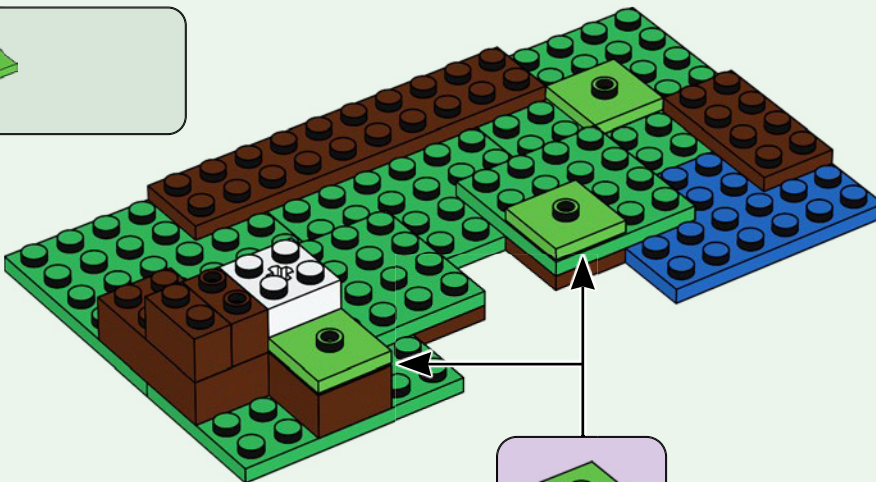
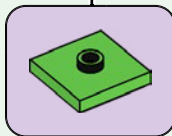

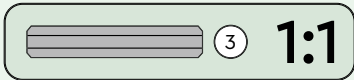
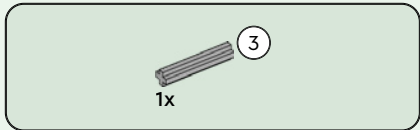

12

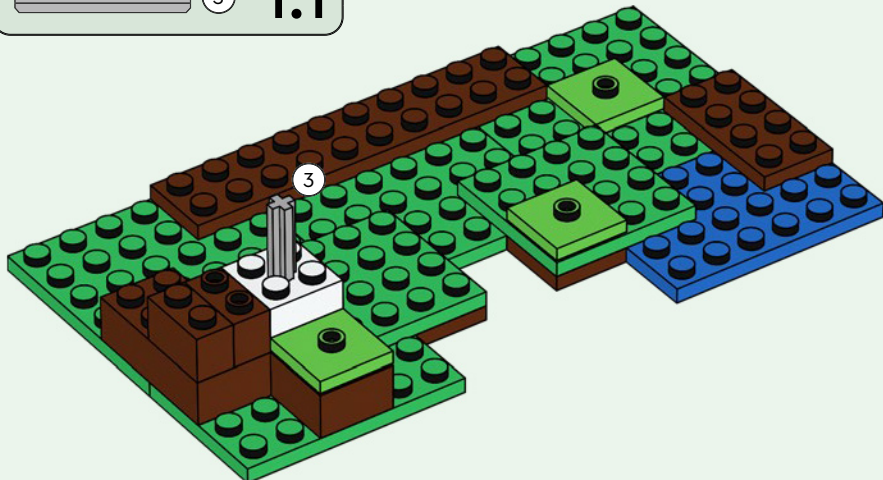

13

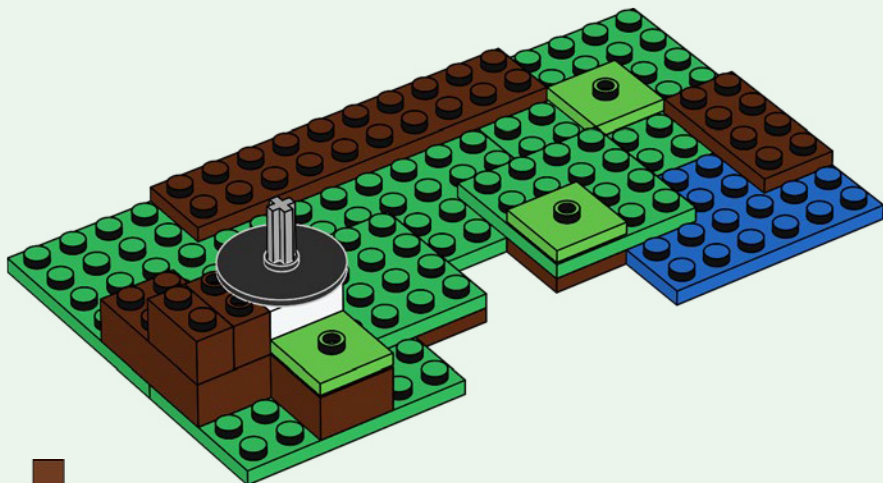

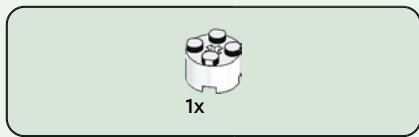

14

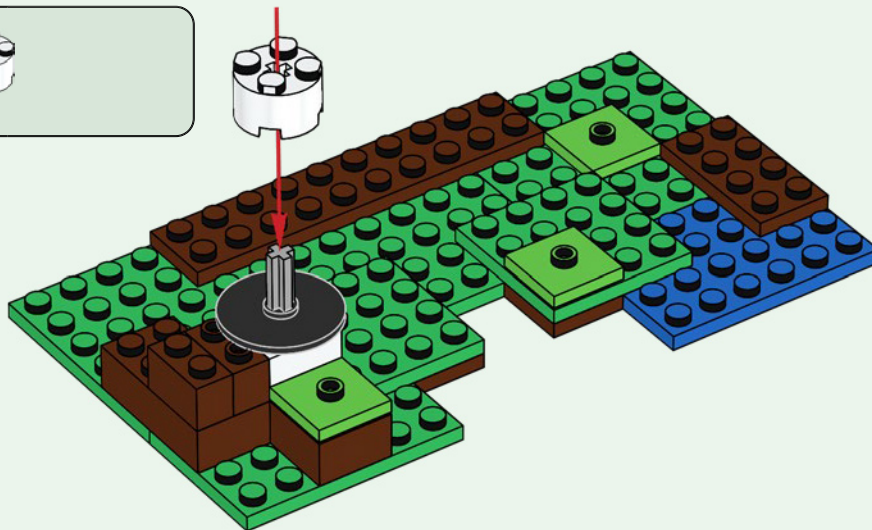

15

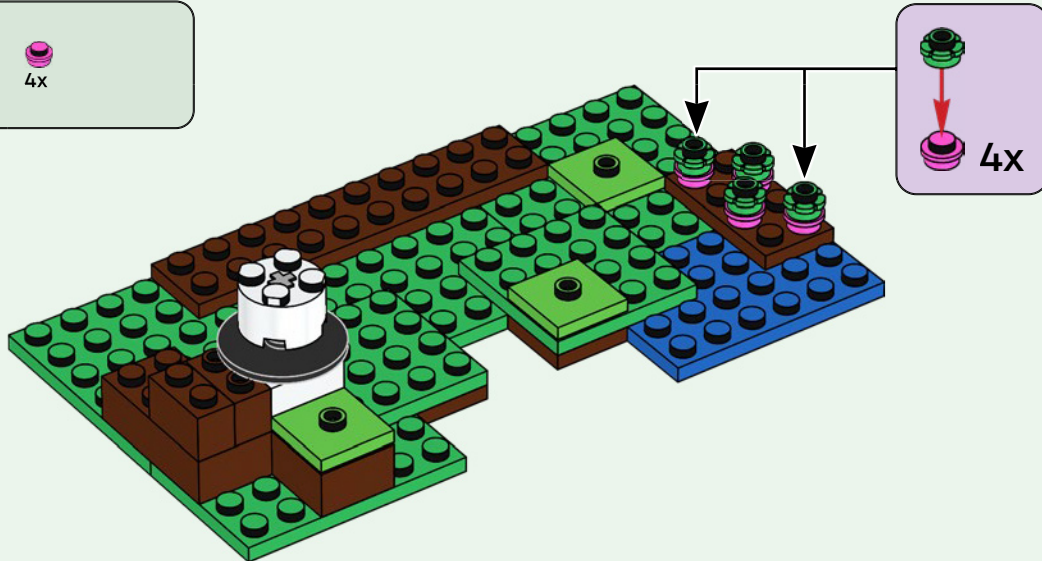

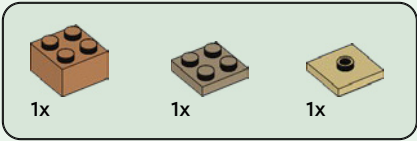

16

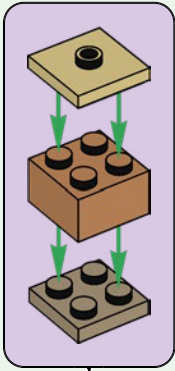



17

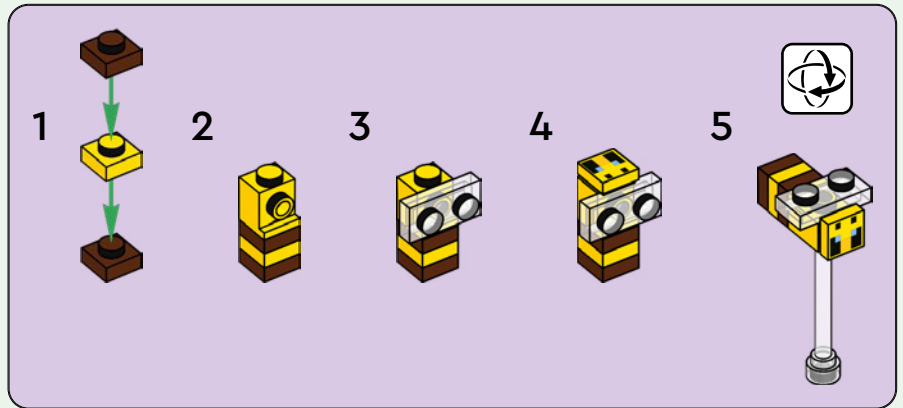



3x



1x

18

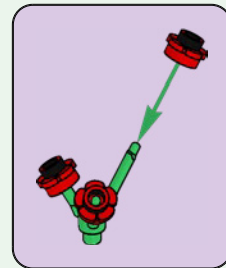

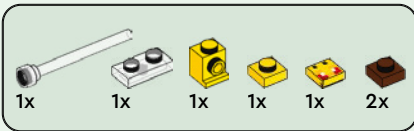

19

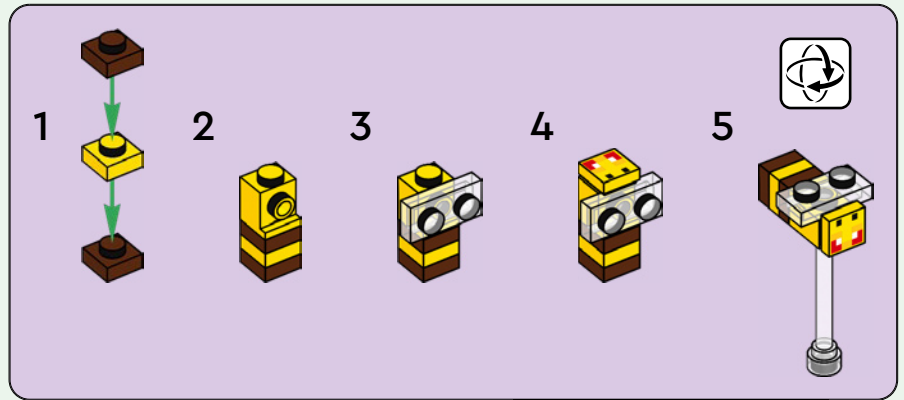

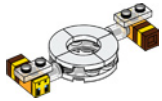

1x

20



4x

21

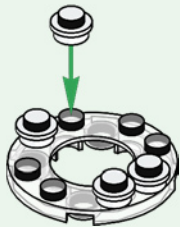

2x

2x

22

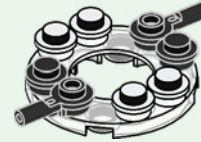

4x

23

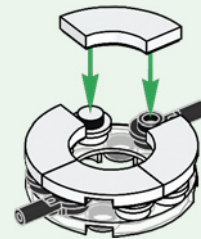

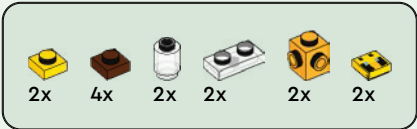

24

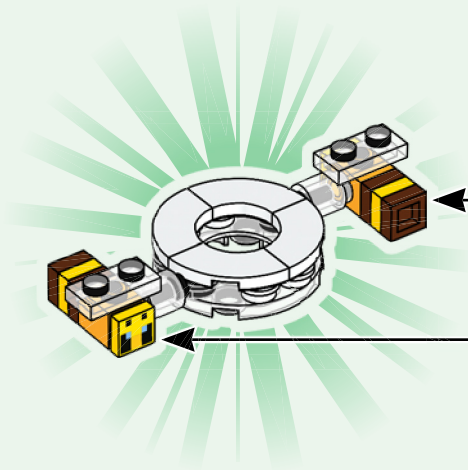
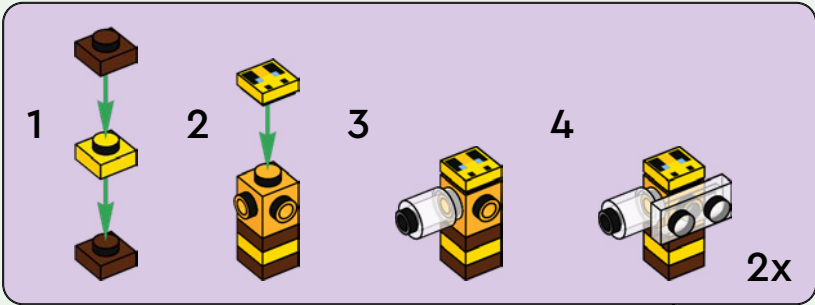

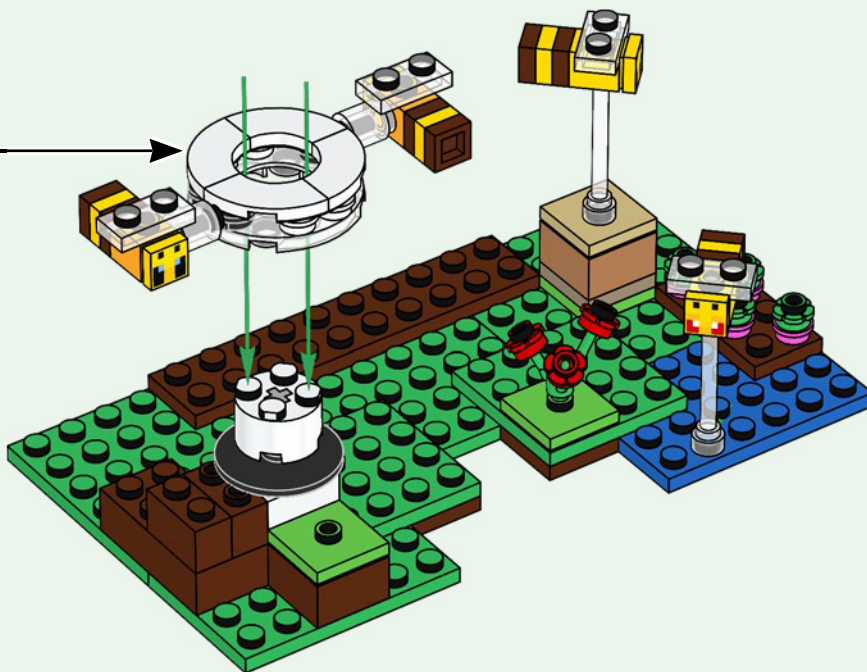

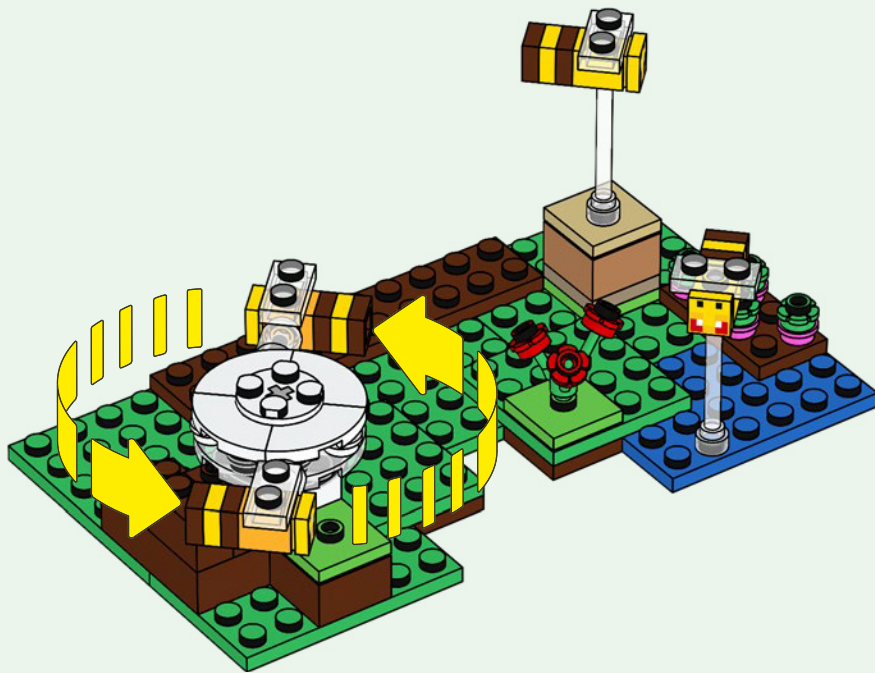

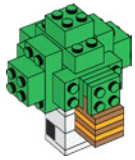

26

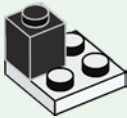

27

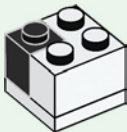

1x



1x

28

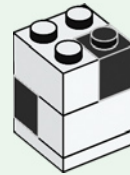

2x

29

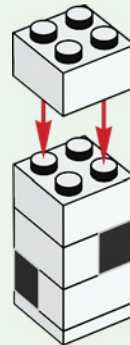

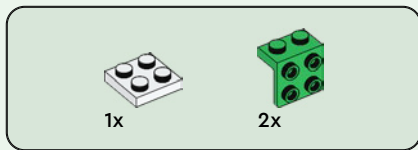

30

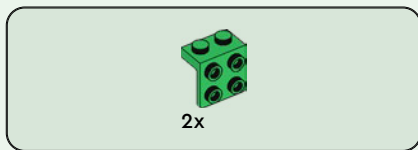

31

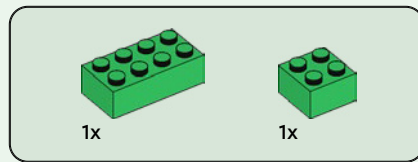
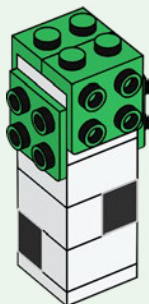

32

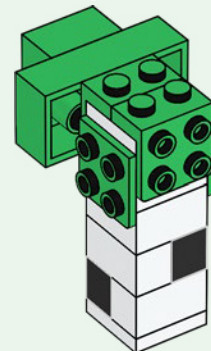
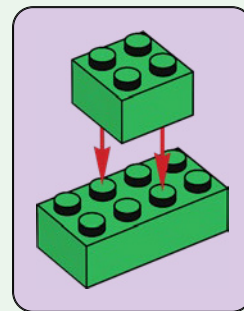

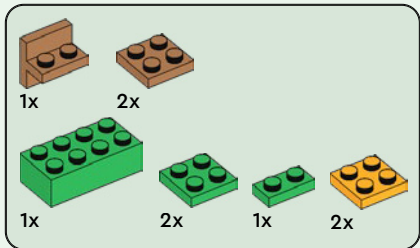

33

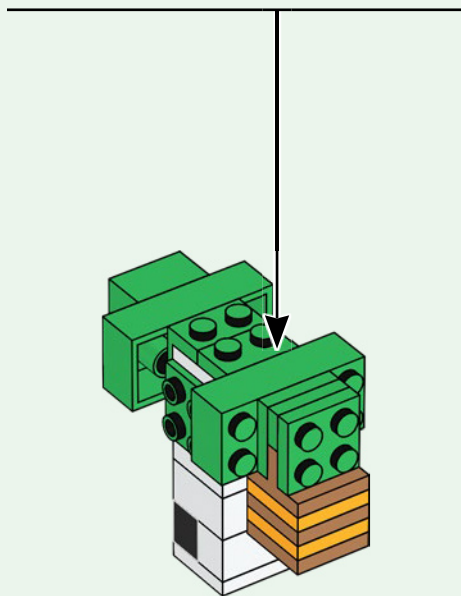
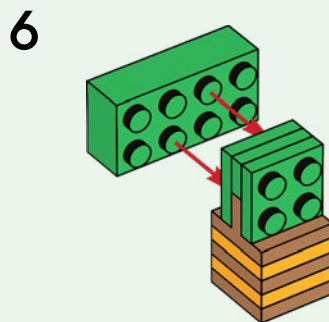
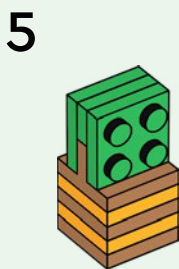
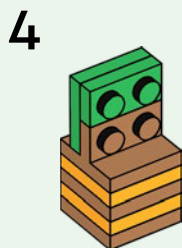
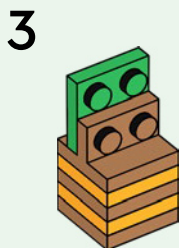
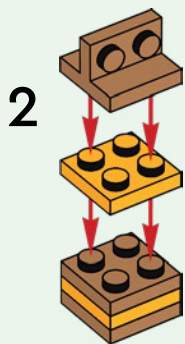
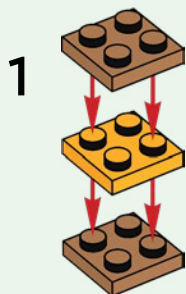

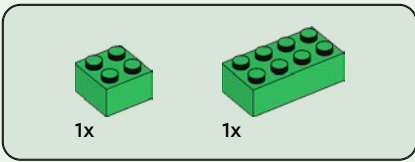

34

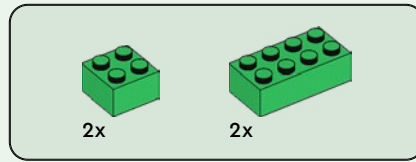
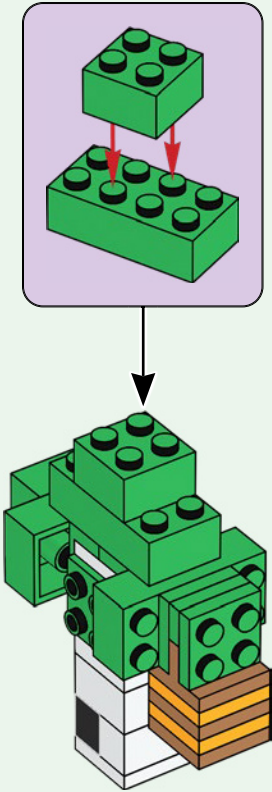

35

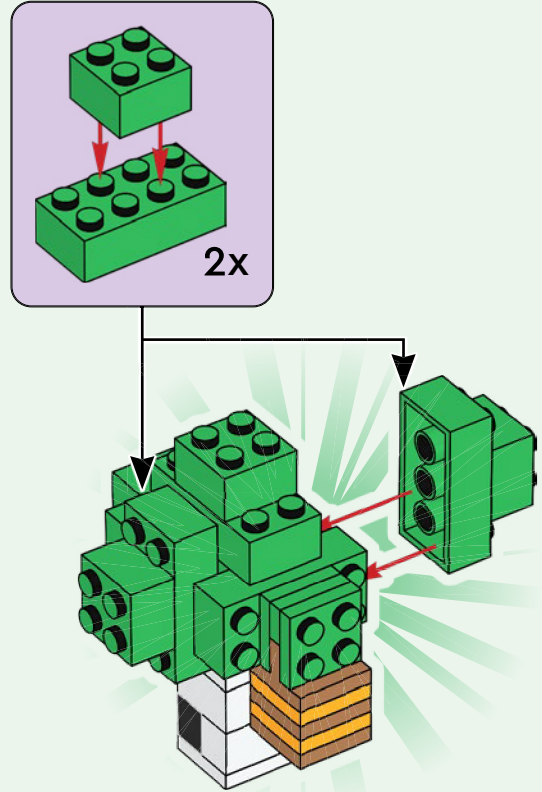





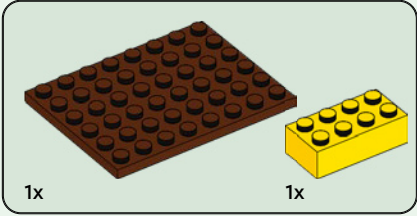
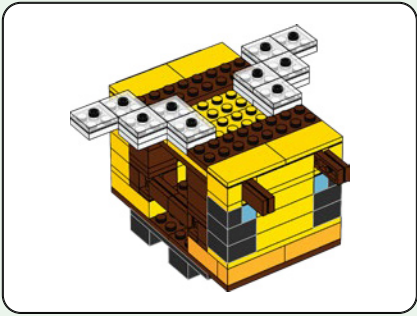

37

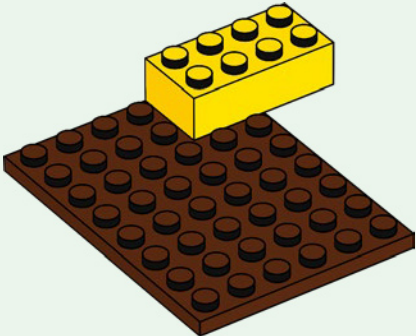



38

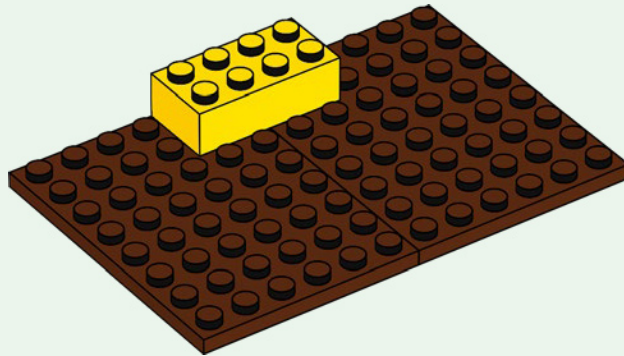

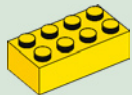

3x

39

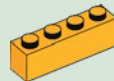
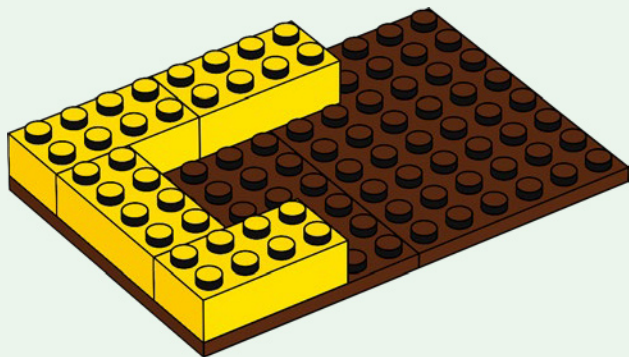

3x

40

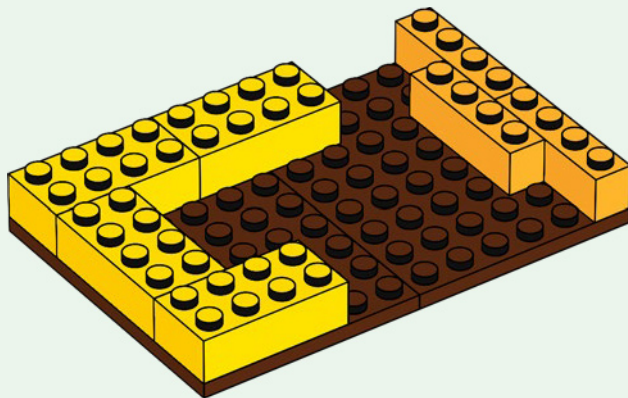

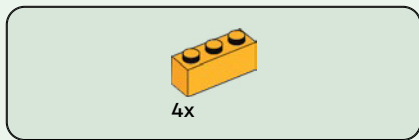

41

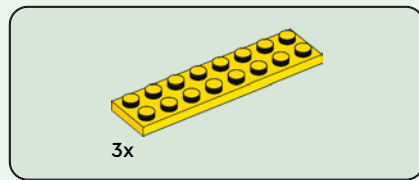
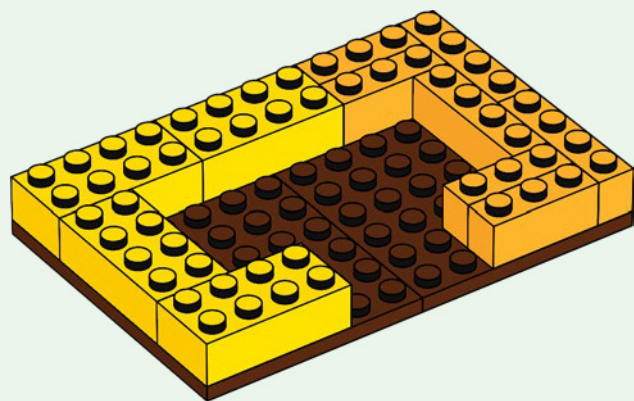

42

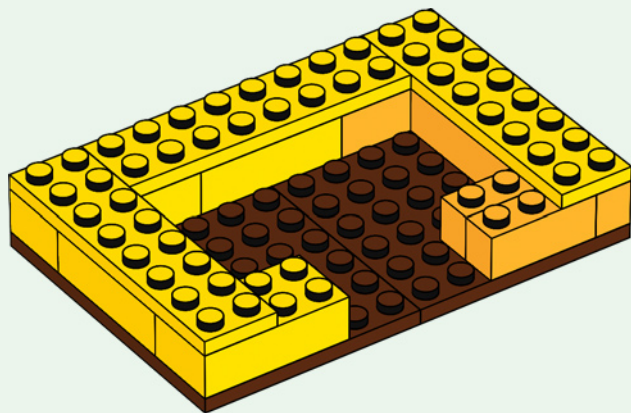



43

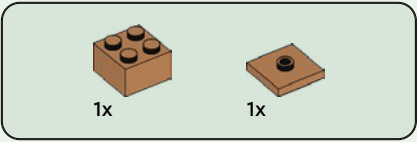
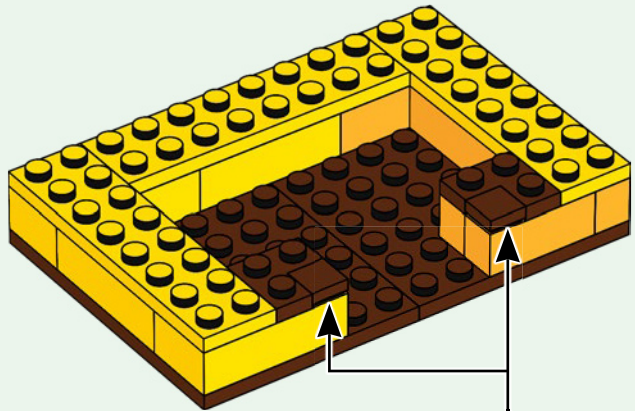

44

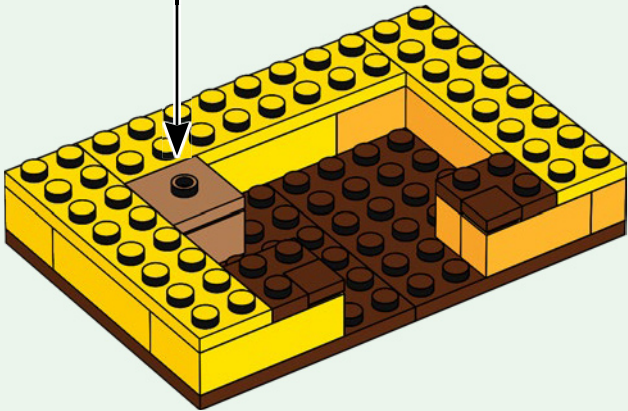
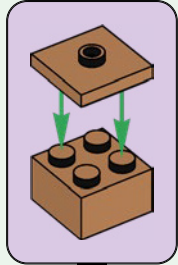

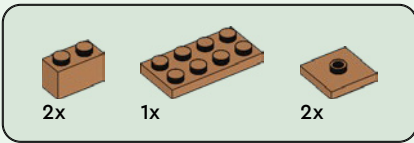

45

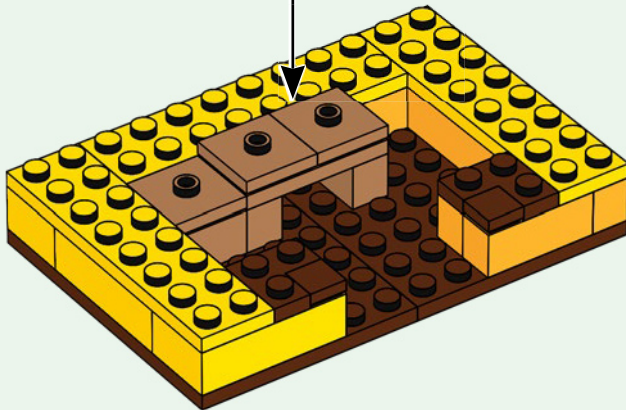
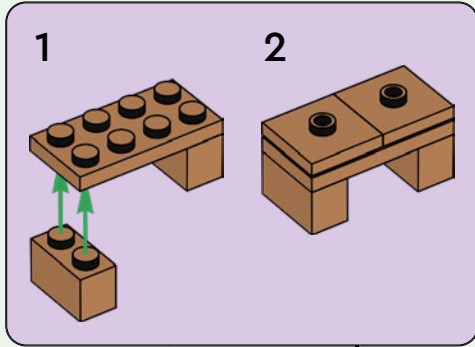

46

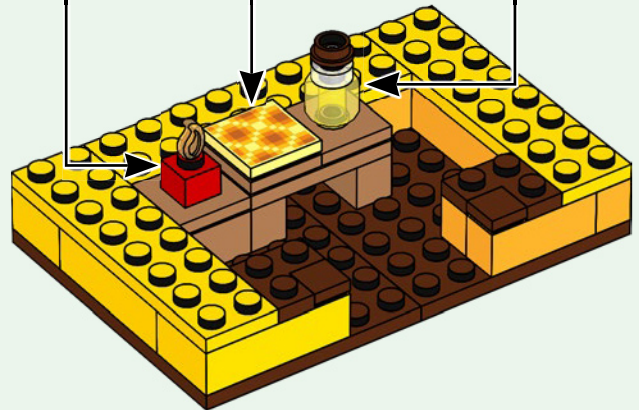



2x



2x

47

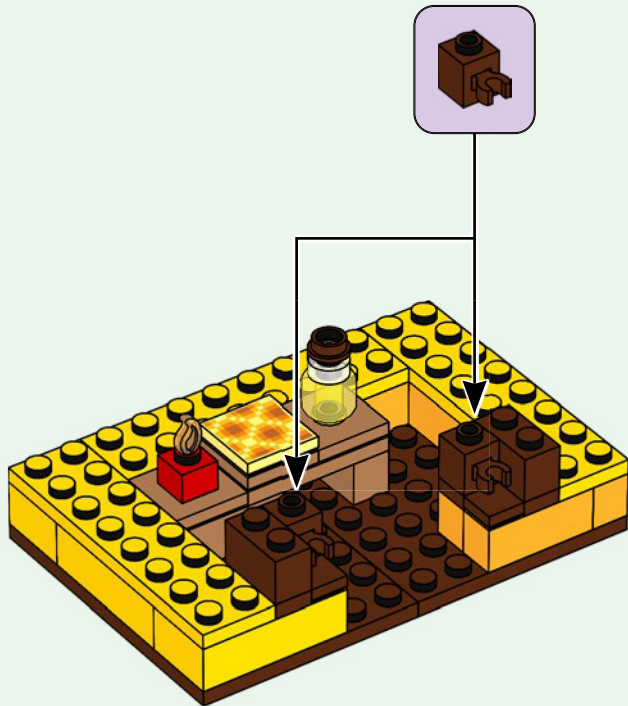

2x

48

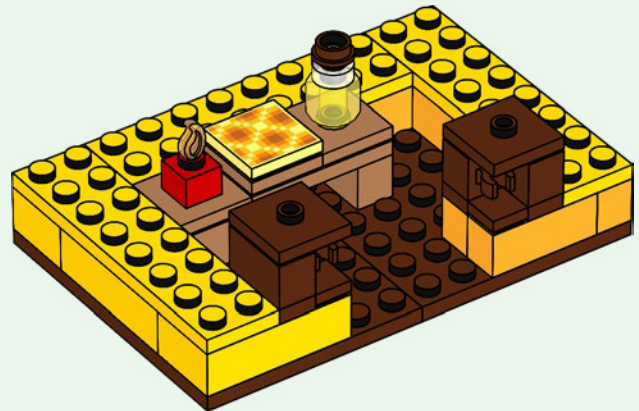

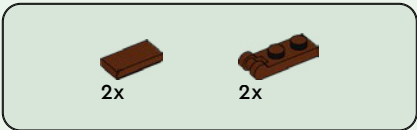

49

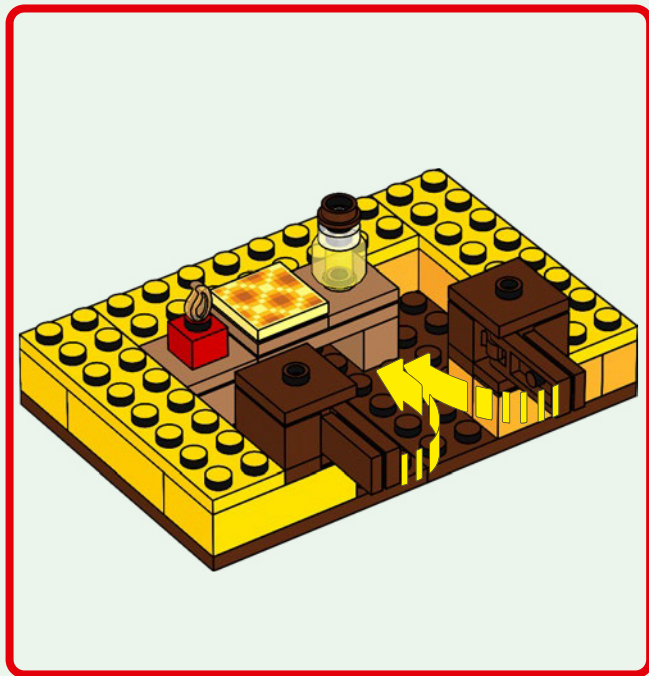
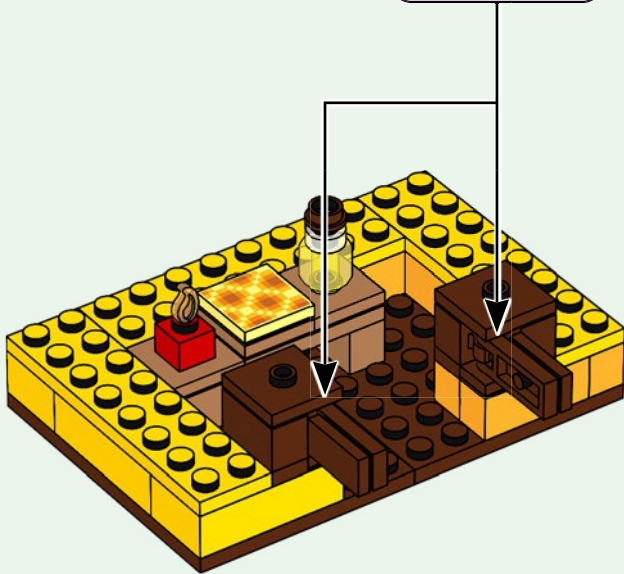
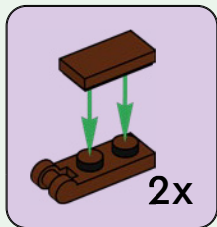

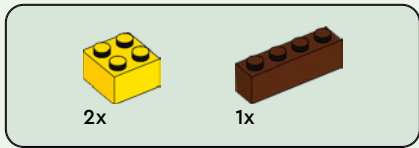

50

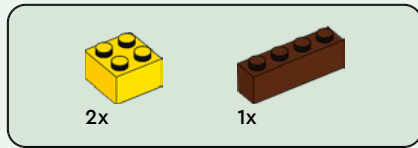
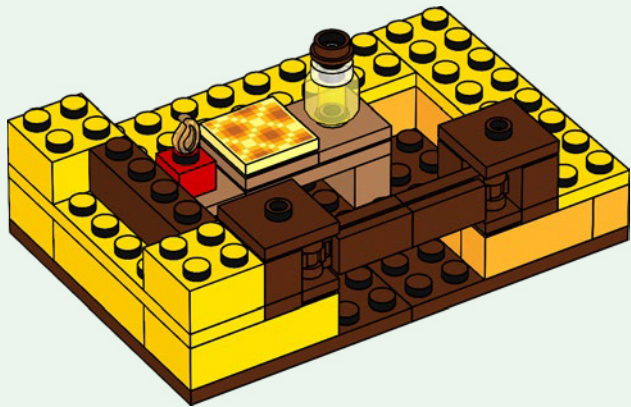

51

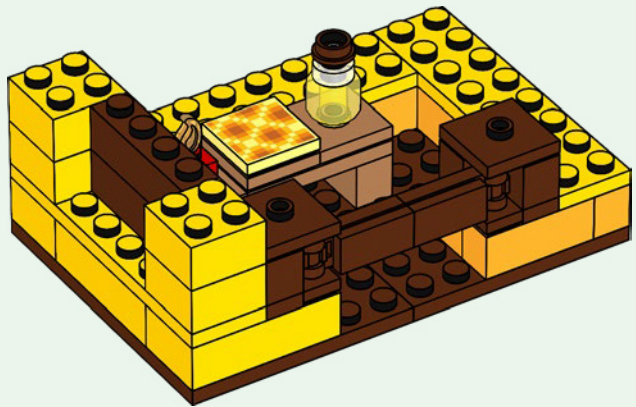



2x

52

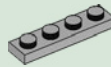
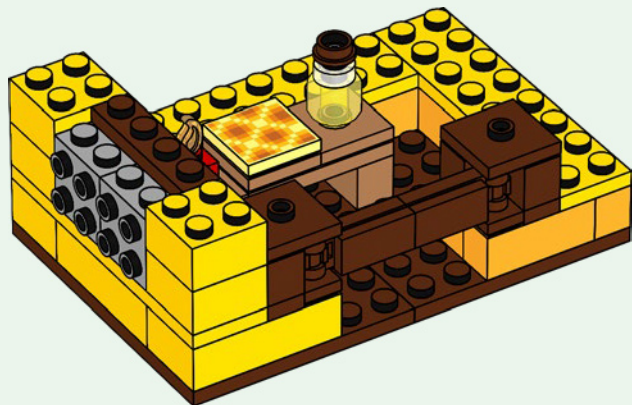

1x

53

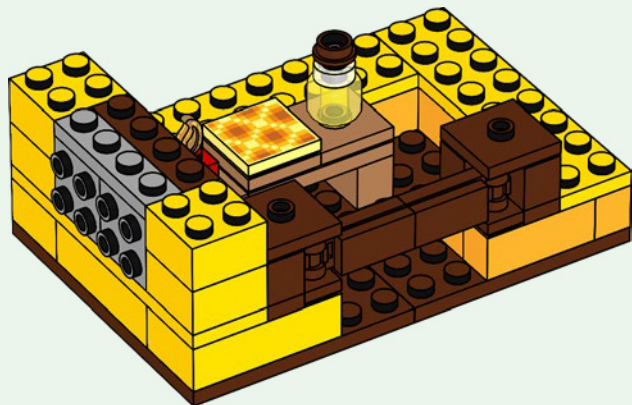

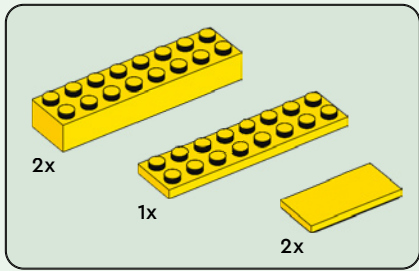

54

1

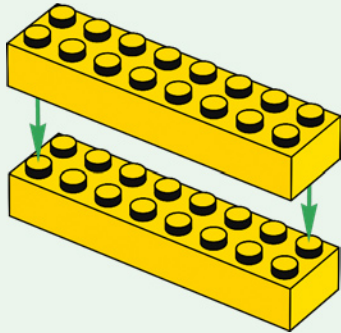

2

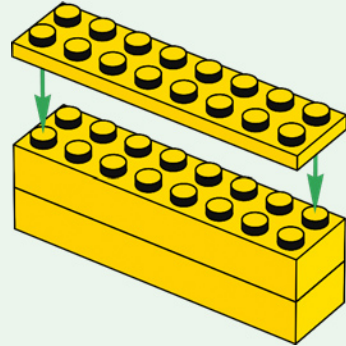

3

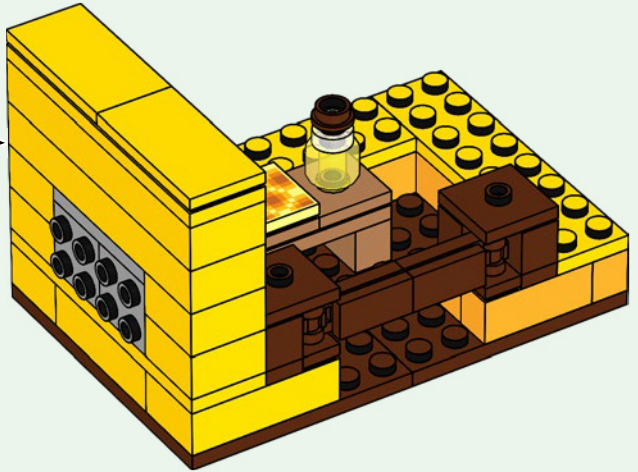
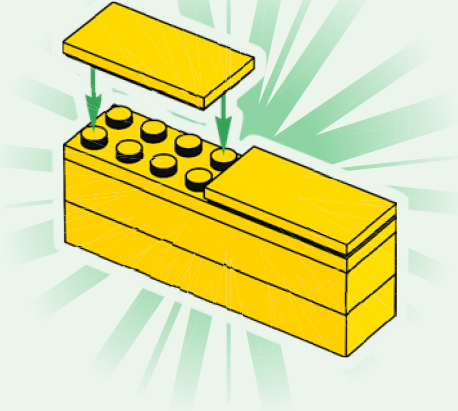

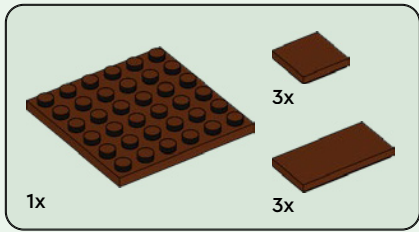

55

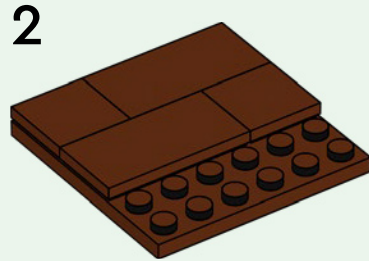
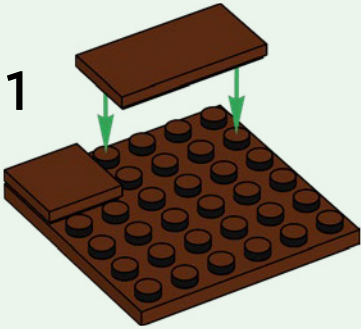

3

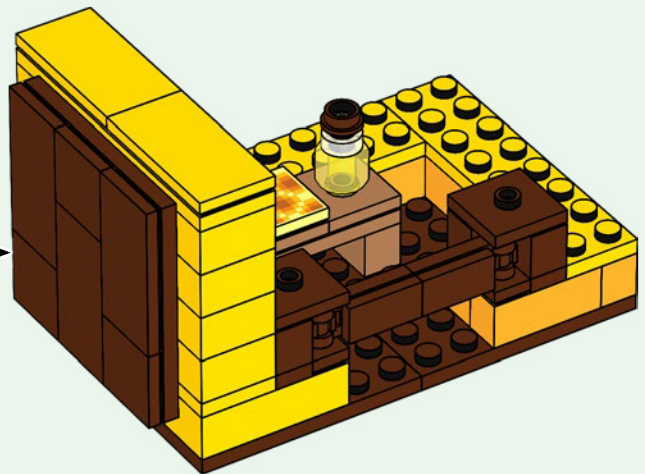
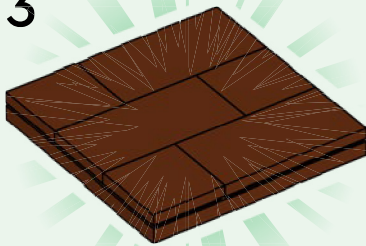

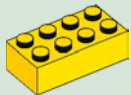

1x



2x

56

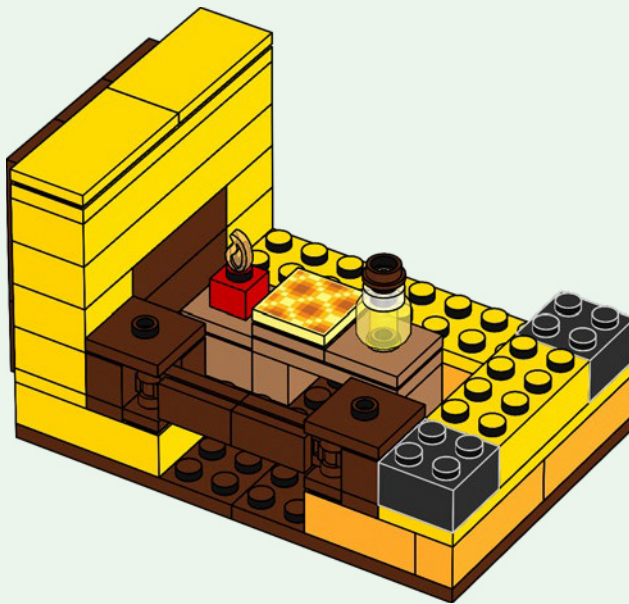

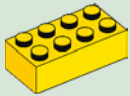

1x



2x

57

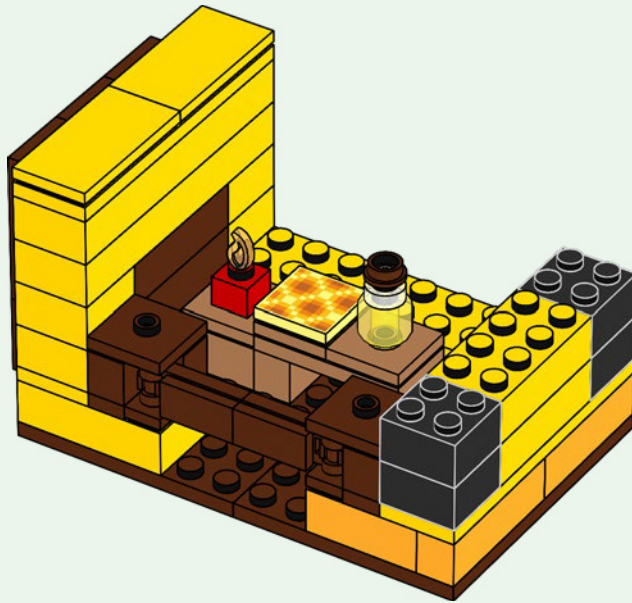

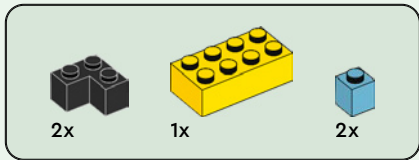

58

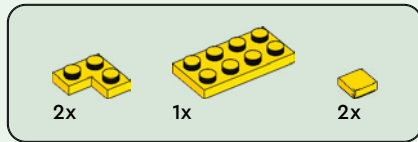
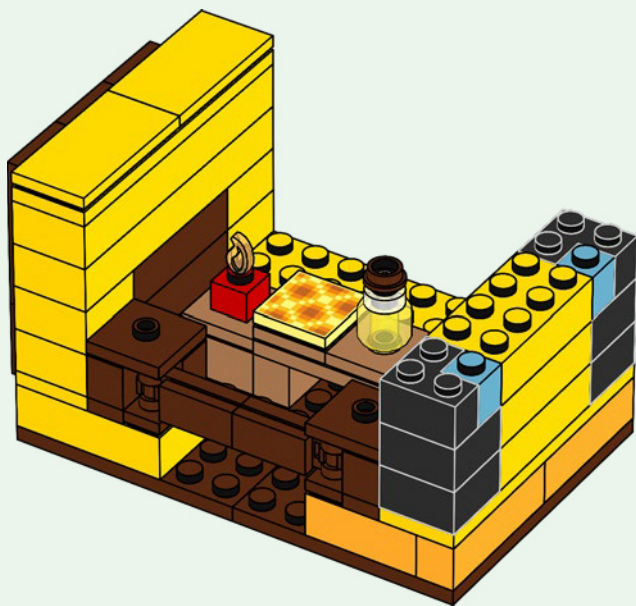

59

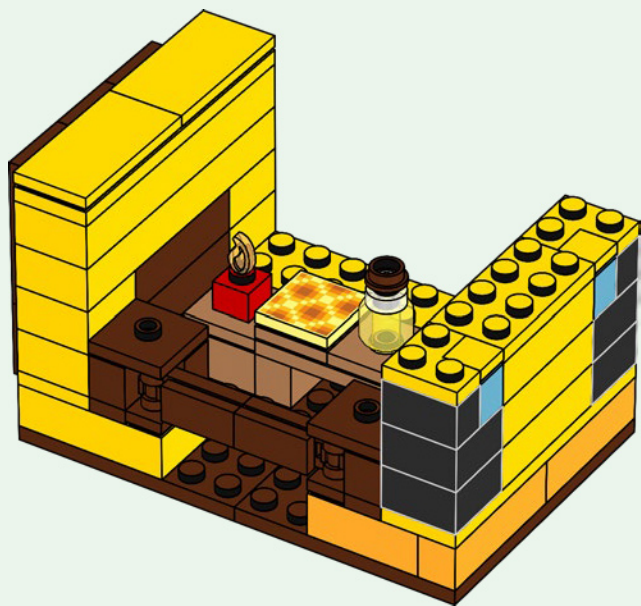

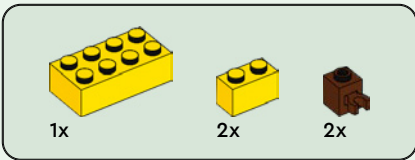

60

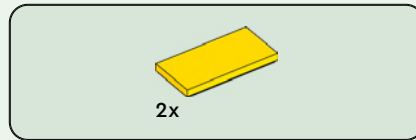
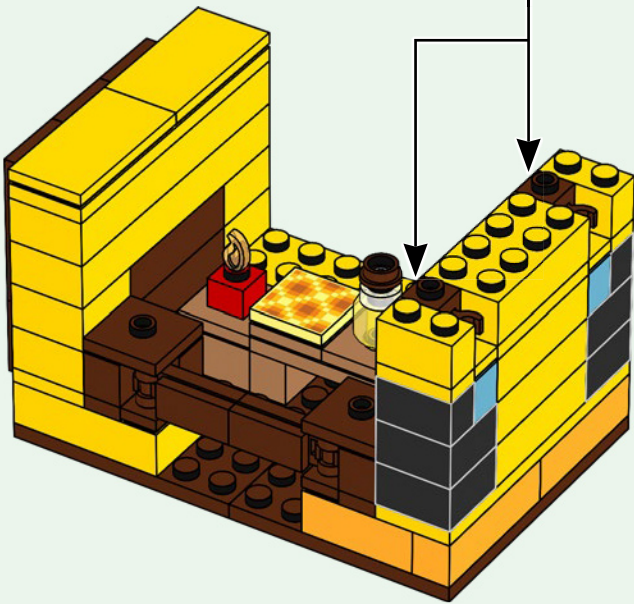
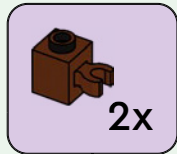

61

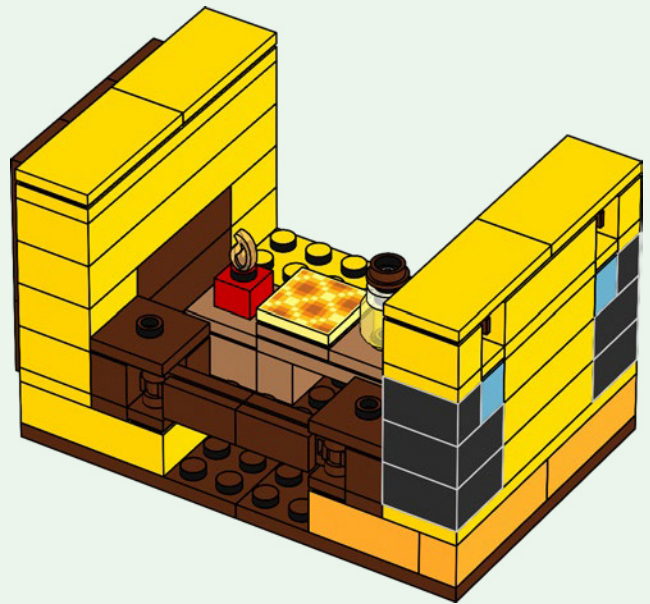

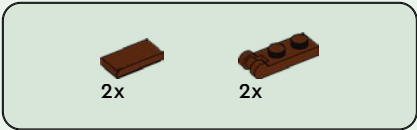

62

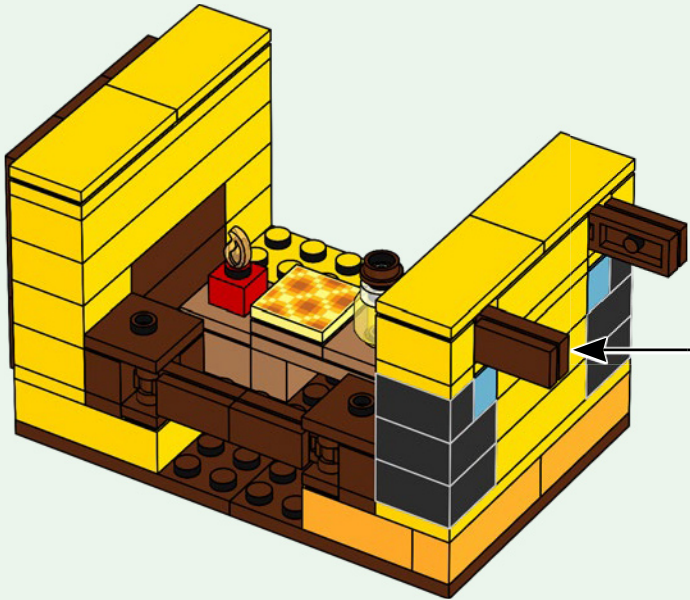
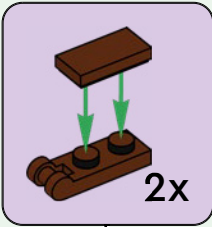

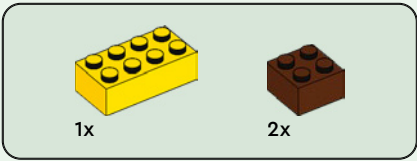

63

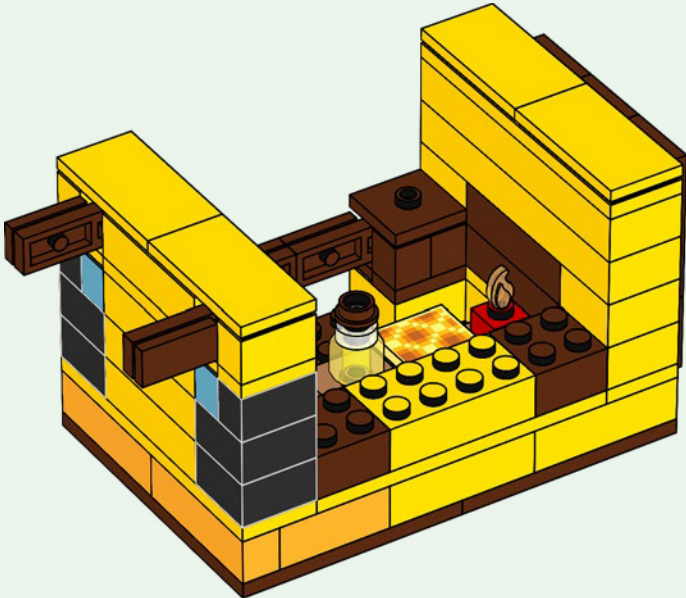

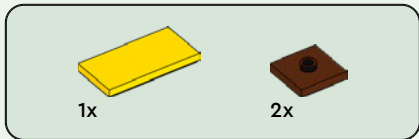

64

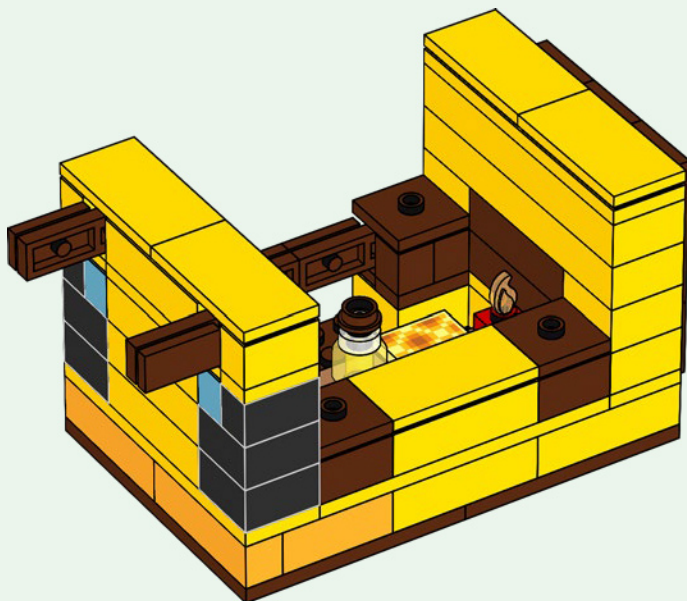

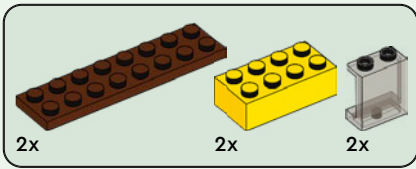

65

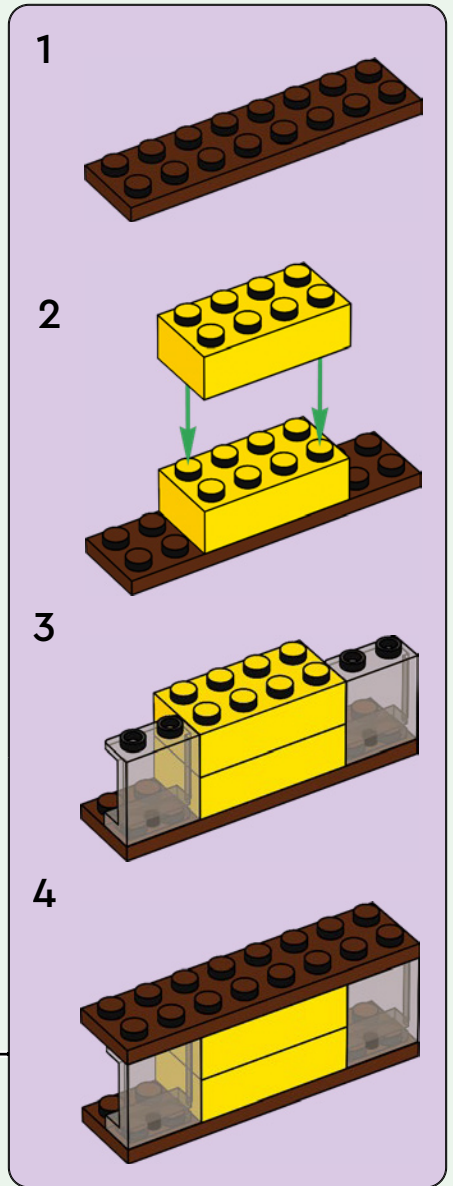
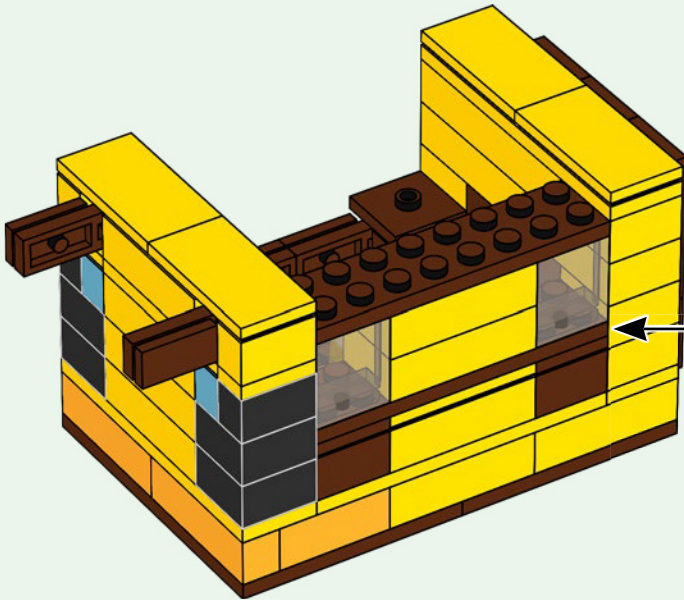

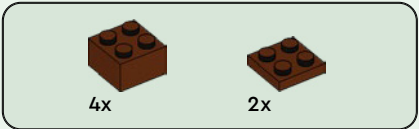

66

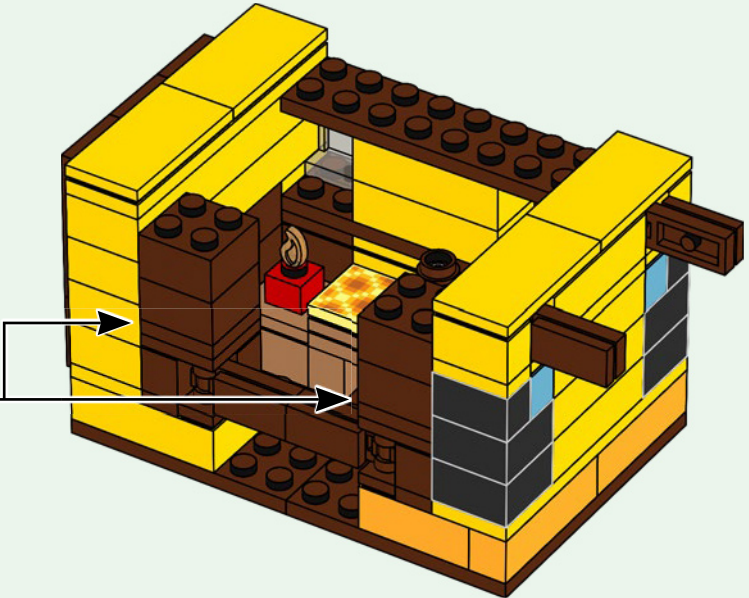
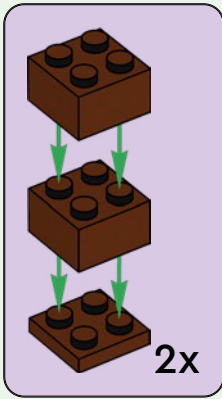

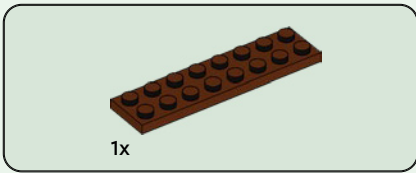

67

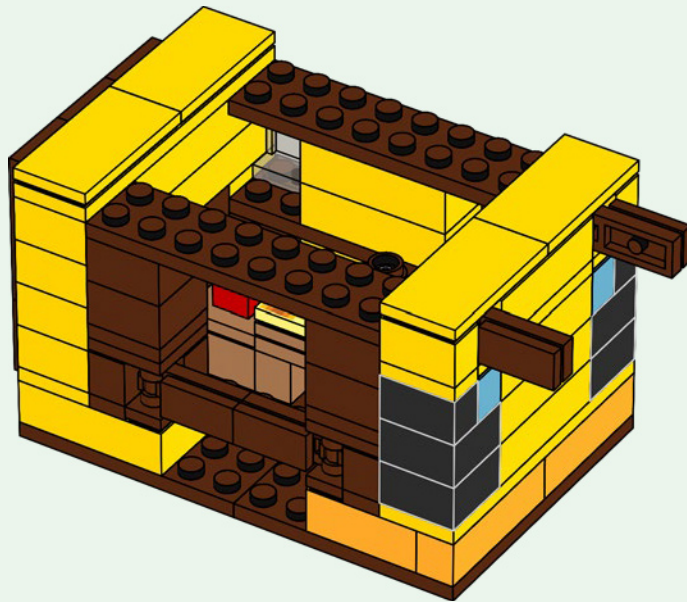

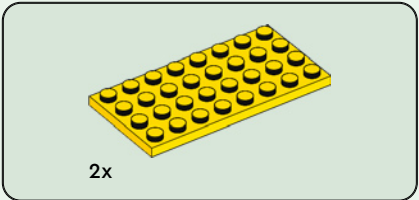

68

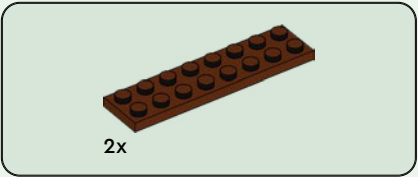
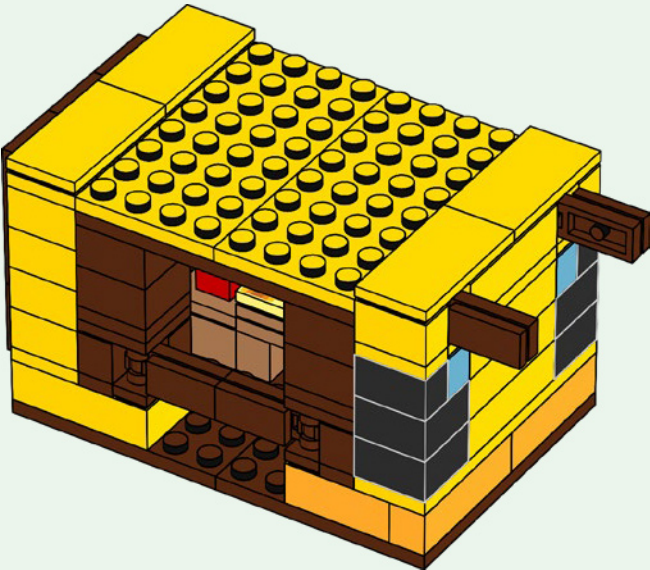

69

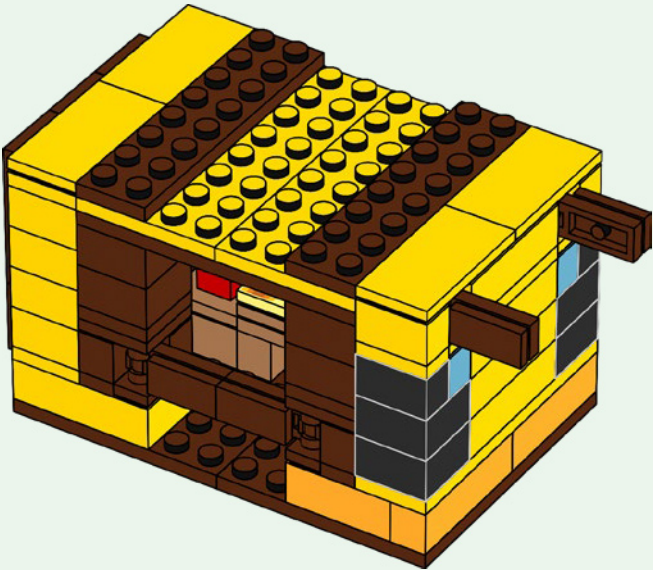

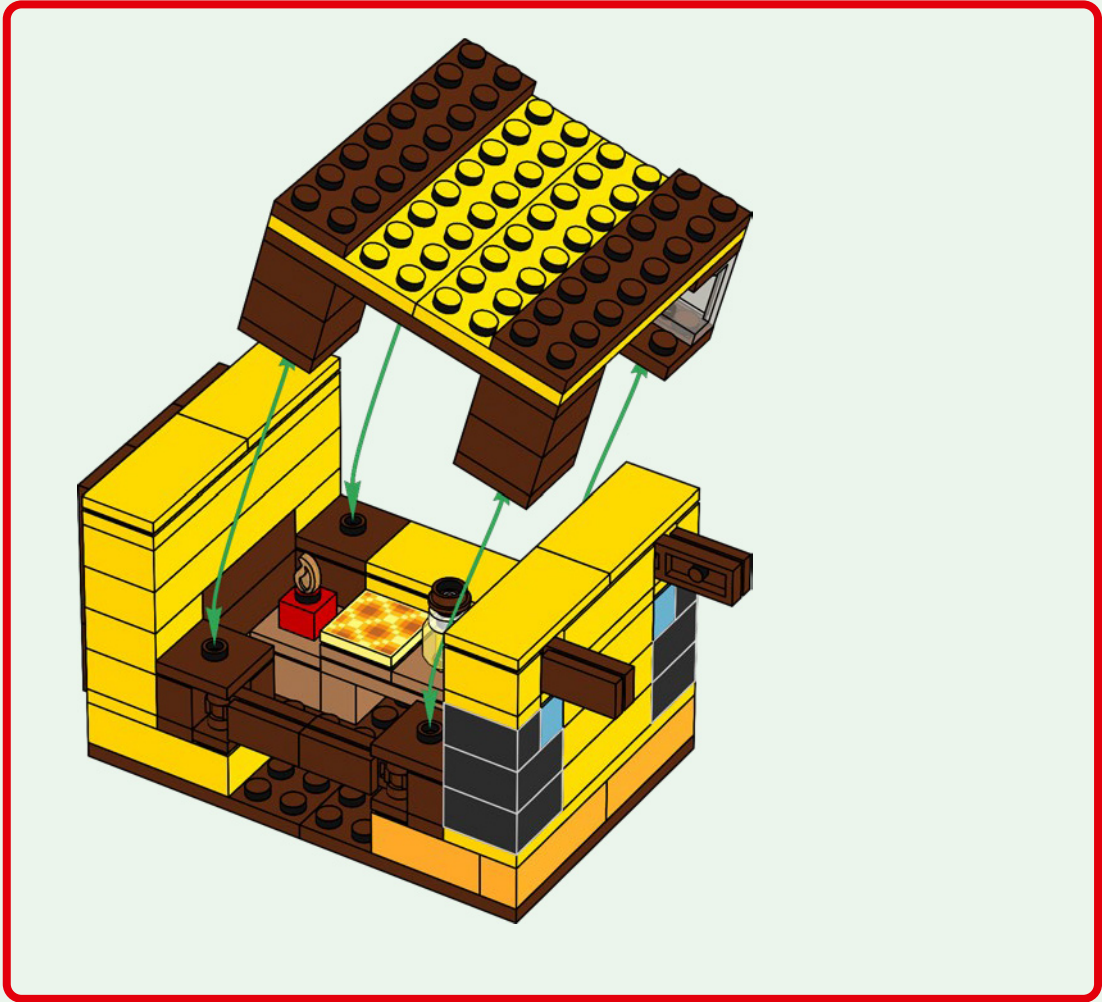

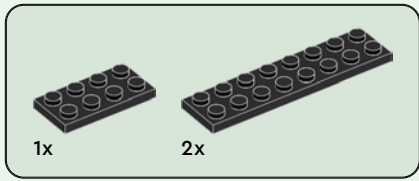

70

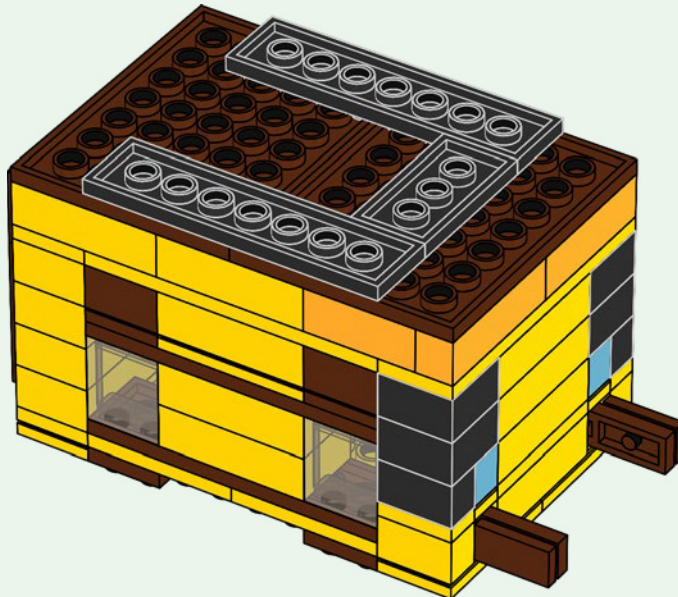



6x

71

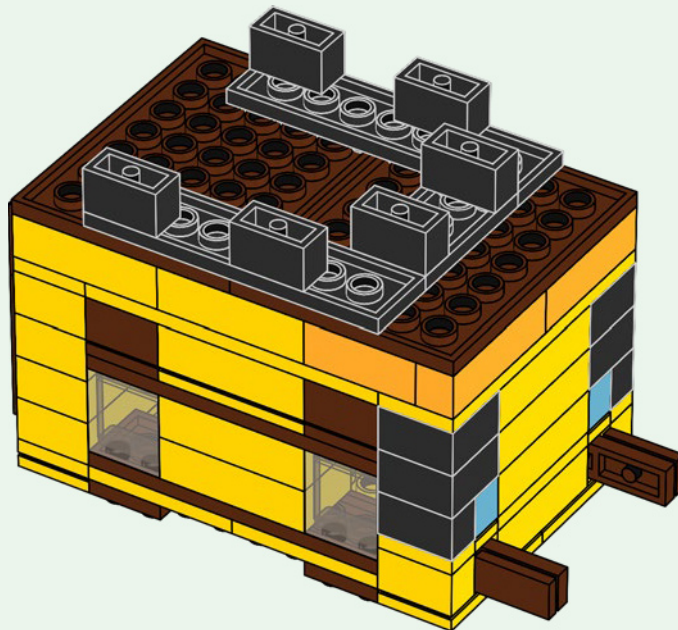

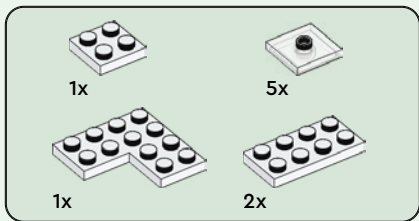

72

1

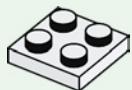

2

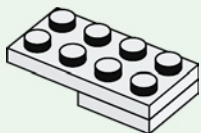

3

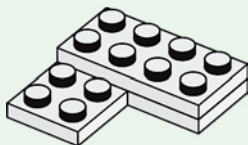

4

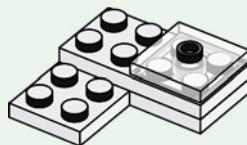

5

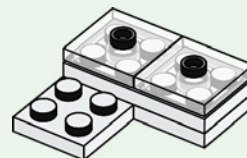

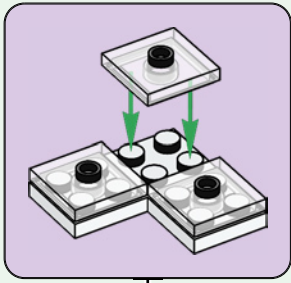

6

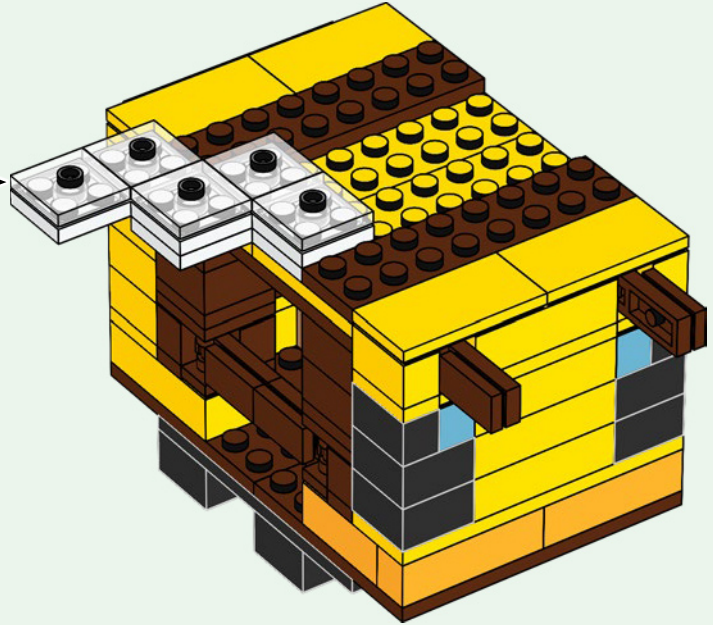
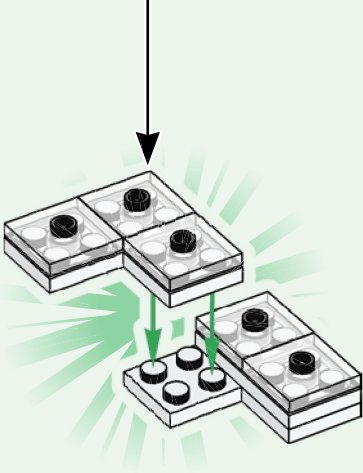

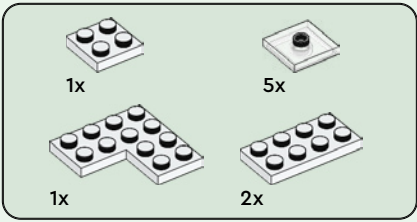

73

1



2

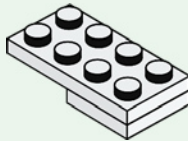

3

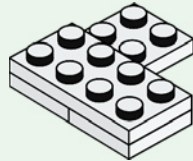

4

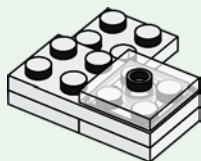

5

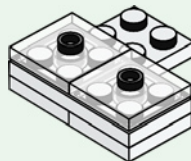

6

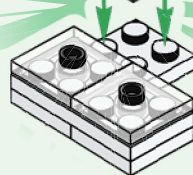
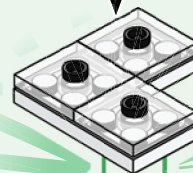
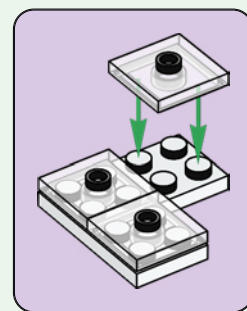

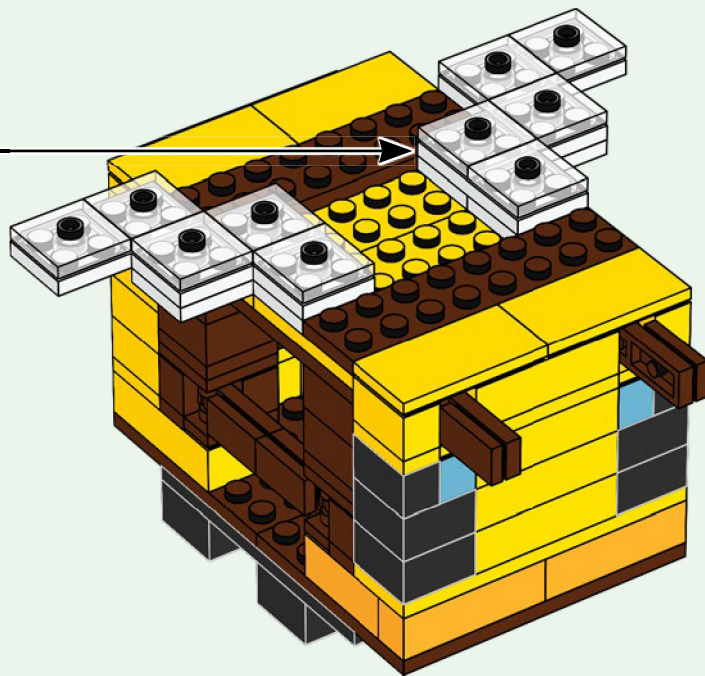





MINECRAFT

21243



21244



21241



21245





MINECRAFT

21242



21246



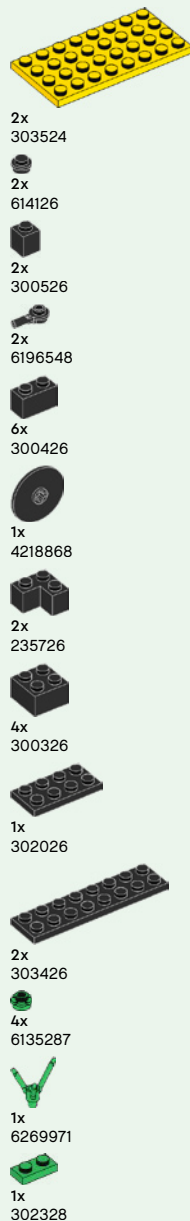



10x
6425449



1x
6173802



2x
6166111



1x
6300208



2x
6253217



1x
6047415



1x
6357747



2x
6292415



2x
6003033



4x
6061688



3x
6003004



1x
6215659



8x
4221744



2x
4211288



4x
6325717



1x
6423954



1x
4221886



3x
4211149



1x
4211252



4x
4211151



4x
4216695



2x
4211257



4x
4565394



3x
4271949



6x
4211210



4x
6102975



1x
6429570



2x
4211225



1x
4211186



2x
4211201



3x
4579690



5x
4211211



1x
4217848



1x
4211214



1x
4211214



1x
4211214



2x
4223729



2x
6123809



2x
6123809



1x
4211815



1x
4211445



4x
6195315



1x
6335367



2x
4569382



1x
6313599



2x
6056383



2x
6058085



3x
6102994



1x
6093494



1x
6421061



1x
6397838



2x
4619652

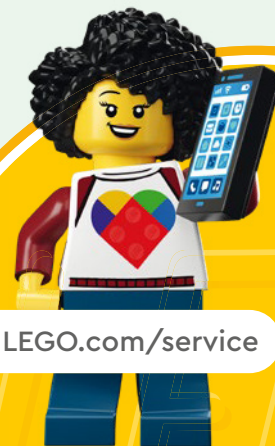

 [LEGO.com/service](https://www.LEGO.com/service)

YOU COULD **WIN**



Scan this QR code or go to **LEGO.COM/PRODUCTFEEDBACK** and give us your short feedback about this LEGO® set for a chance to win a cool LEGO prize.

Terms and Conditions apply*

DE: Du könntest GEWINNEN. Es gelten die Teilnahmebedingungen* **FR: Tu pourrais GAGNER.** Des conditions s'appliquent* **IT: Potresti VINCERE tu.** Termini e condizioni sono applicabili* **ES: Puedes GANAR.** Aplican términos y condiciones* **PT: Poderá GANHAR.** Aplicam-se termos e condições* **JA: プレゼント付き! 利用規約が適用されます*** **ZH: 轻松获奖. 条款和条件适用*** **KO: 상품의 주인이 되어보세요. 소정의 약관이 적용됩니다*** **RU: Вы можете ВЫИГРАТЬ.** Действуют положения и условия* **PL: Szansa na WYGRANĄ.** Obowiązują warunki korzystania* **CS: Máte šanci VYHRÁT.** Platí všeobecné smluvní podmínky* **SK: Máte šancu VYHRAŤ.** Platia všeobecné zmluvné podmienky* **HU: TE IS NYERHETSZ.** Felhasználási feltételek érvényesek* **RO: Ai putea CÂȘTIGA.** Se aplică termeni și condiții* **BG: Можете да СПЕЧЕЛИТЕ.** Има определени правила и условия* **LV: Tu vari LAIMĒT.** Ir spēkā noteikumi un nosacījumi.* **ET: Sul on võimalus VÕITA.** Kehtivad tingimused* **LT: Jūs galite LAIMĖTI.** Taikomos sąlygos*

*LEGO.com/productfeedback-terms

LEGO and the LEGO logo are trademarks of the LEGO Group. ©2023 The LEGO Group.



© 2023 Mojang AB. All Rights Reserved. Minecraft, the Minecraft logo, the Mojang Studios logo and the Creeper logo are trademarks of the Microsoft group of companies.

6448758